



Compliance Testing, LLC

Previously Flom Test Lab

RF, EMC and Safety Testing Experts Since 1963

toll-free: (866) 311-3268

fax: (480) 926-3598

<http://www.ComplianceTesting.com>

info@ComplianceTesting.com

Date: March 26, 2010

Applicant: EMS Technologies Canada, Ltd
400 Maple Grove Rd
Ottawa, ON K2V 1B8
Canada

Attention of: Ron Halka - Director, Business Process Improvement & Quality
Ph: (613) 591-9064 Ext. 3244
Fax: (613) 591-9107
E-mail: halka.r@emsaviation.com

Equipment: HSD-128
FCC ID: K6KHSD-128
FCC Rules: Part 87

Gentlemen:

Enclosed please find your copy of the Engineering Test Report for which you are subject to the restrictions as listed on the attached summary.

Once a Telecommunication Certification Body (TCB) issues a Grant the Federal Communication Commission (FCC) has 30 days to review the application and request added information. It is your decision whether or not to market the equipment subject to a possible recall before the end of the 30 days.

If your equipment is still retained by us, it will be returned to you 30 days after approval is achieved. Our invoice for services has been directed to your Accounts Payable Department.

For any additional information please contact us.

Thank you.

Sincerely yours,

John Erhard; Engineering Manager



Summary of Restrictions

1. All submissions to the FCC are subject to **their** Examiner's interpretation.
2. Please allow from 60 to 90 days before hearing from the FCC with regard to any submission.
3. The FCC can set aside any action or modify any action, within 30 days. (FCC Rule 1.108, 1.113).
4. Under Rule 2.803, if device is not type accepted/certificated then it must **not** be sold, leased, offered for sale, imported, shipped or distributed or advertised for sale.
5. FCC can revoke its certificates at any time if the equipment does not meet or **continue** to meet their Rules. (Rule Parts 2.927, 2.939).
6. FCC can request a sample at any time (2.936).



Compliance Testing, LLC
Previously Flom Test Lab
RF, EMC and Safety Testing Experts Since 1963

toll-free: (866) 311-3268

fax: (480) 926-3598

<http://www.ComplianceTesting.com>

info@ComplianceTesting.com

Date: March 26, 2010

Federal Communications Commission
Via: Electronic Filing

Attention: Authorization & Evaluation Division

Applicant: EMS Technologies Canada, Ltd

Equipment: HSD-128

FCC ID: K6KHSD-128

FCC Rules: Part 87

Dear Gentleman:

On behalf of the Applicant, enclosed please find Application Form 731, Engineering Test Report and all pertinent documentation, the whole for approval of the referenced equipment as shown.

We trust the same is in order. Should you need any further information, kindly contact the writer who is authorized to act as agent.

Best regards,

John Erhard; Engineering Manager



Compliance Testing, LLC

Previously Flom Test Lab

RF, EMC and Safety Testing Experts Since 1963

toll-free: (866) 311-3268

fax: (480) 926-3598

<http://www.ComplianceTesting.com>

info@ComplianceTesting.com

Test Report

for

FCC ID: K6KHSD-128

Model: HSD-128

to

Federal Communications Commission

Rule Part(s) 87

Date of report: March 26, 2010

On the Behalf of the Applicant: EMS Technologies Canada, Ltd

At the Request of: EMS Technologies Canada, Ltd
400 Maple Grove Rd
Ottawa, ON K2V 1B8
Canada

Attention of: Ron Halka - Director, Business Process Improvement & Quality
Ph: (613) 591-9064 Ext. 3244
Fax: (613) 591-9107
E-mail: halka.r@emsaviation.com

Reviewed by:

John Erhard; Engineering Manager



Test Report Revision History

Revision	Date	Revised By	Reason for revision
1.0	March 26, 2010	J. Erhard	Original Document
2.0	April 1, 2010	J. Erhard	Add 40K0G1D emissions designator necessary bandwidth calculation



List of Exhibits

(FCC **Certification** (Transmitters) - Revised 9/28/98)

Applicant: EMS Technologies Canada, Ltd

FCC ID: K6KHSD-128

By Applicant:

1. Letter of Authorization
2. Confidentiality Request: 0.457 And 0.459
3. Identification Drawings, 2.1033(c)(11)
 - Label
 - Location of Label
 - Compliance Statement
 - Location of Compliance Statement
4. Photographs, 2.1033(c)(12)
5. Documentation: 2.1033(c)
 - (3) User Manual
 - (9) Tune Up Info
 - (10) Schematic Diagram
 - (10) Circuit Description
 - Block Diagram
 - Parts List
 - Active Devices

By Compliance Testing:

- A. Testimonial & Statement of Certification



The Applicant has been cautioned as to the following:

15.21 **Information to the User.**

The users manual or instruction manual for an intentional radiator shall caution the user that changes or modifications not expressly approved by the party responsible for compliance could void the user's authority to operate the equipment.

15.27(a) **Special Accessories.**

Equipment marketed to a consumer must be capable of complying with the necessary regulations in the configuration in which the equipment is marketed. Where special accessories, such as shielded cables and/or special connectors are required to enable an unintentional or intentional radiator to comply with the emission limits in this part, the equipment must be marketed with, i.e. shipped and sold with, those special accessories. However, in lieu of shipping or packaging the special accessories with the unintentional or intentional radiator, the responsible party may employ other methods of ensuring that the special accessories are provided to the consumer, without additional charge.

Information detailing any alternative method used to supply the special accessories for a grant of equipment authorization or retained in the verification records, as appropriate. The party responsible for the equipment, as detailed in § 2.879 of this chapter, shall ensure that these special accessories are provided with the equipment. The instruction manual for such devices shall include appropriate instructions on the first page of text concerned with the installation of the device that these special accessories must be used with the device. It is the responsibility of the user to use the needed special accessories supplied with the equipment.



Testimonial and Statement of Certification

This is to Certify:

1. **That** the application was prepared either by, or under the direct supervision of, the undersigned.
2. **That** the technical data supplied with the application was taken under my direction and supervision.
3. **That** the data was obtained on representative units, randomly selected.
4. **That**, to the best of my knowledge and belief, the facts set forth in the application and accompanying technical data are true and correct.

A handwritten signature in black ink, appearing to read "John Erhard".

John Erhard; Engineering Manager

Certifying Engineer:

Compliance Testing
3356 N. San Marcos Place, Suite 107
Chandler, Arizona 85225-7176
(866) 311-3268 phone, (480) 926-3598 fax



Table of Contents

<u>Rule</u>	<u>Description</u>	<u>Page</u>
	Test Report	2
2.1033(c)(14)	Rule Summary	3
	Standard Test Conditions and Engineering Practices	4
2.1033(c)	General Information Required	5
	Test Results Summary	7
2.1046, 87.131	Carrier Output Power (Conducted)	8
2.1051, 87.139(i)(1)	Conducted Spurious Emissions	9
2.1053,	Field Strength of Spurious Radiation	27
2.1049, 87.139(i)(3)	Emission Masks (Occupied Bandwidth)	31
2.1055, 87.133(a)	Frequency Stability (Temperature Variation)	41
2.1055, 87.133(a)	Frequency Stability (Voltage Variation)	42
2.202(g)	Necessary Bandwidth and Emission Bandwidth	43
	Test Equipment Utilized	44
	Appendix	45



Required information per ISO 17025-2005, paragraph 5.10.2:

a) **Test Report**

b) Laboratory: Compliance Testing
(FCC: 933597) 3356 N. San Marcos Place, Suite 107
(Canada: IC 2044-A) Chandler, AZ 85225

c) Report Number: d1030023

d) Client: EMS Technologies Canada, Ltd
400 Maple Grove Rd
Ottawa, ON K2V 1B8
Canada

e) Identification: FCC ID: K6KHSD-128
Model: HSD-128
Part Numbers: 1110-A-0060, 1110-A-0070, 1110-A-0150, 1110-A-0190
1110-A-0080, 1110-A-0001, 1110-A-0180, 1110-A-0160
EUT Description: eNfusion HSD-128 Aeronautical Satcom Terminal

f) EUT Condition: Not required unless specified in individual tests.

g) Report Date: March 26, 2010

h, j, k): As indicated in individual tests.

i) Sampling method: No sampling procedure used.

l) Measurement Uncertainty: In accordance with Compliance Testing internal quality manual.

m) Reviewed by:

John Erhard; Engineering Manager

n) Results: The results presented in this report relate only to the item tested.

o) Reproduction: This report must not be reproduced, except in full, without written permission from this laboratory.

Accessories used during testing:

Type	Quantity	Manufacturer	Model	Serial No.	FCC ID
None	None	None	None	None	None



Sub-part

2.1033(c)(14):

Test and Measurement Data

All tests and measurement data shown were performed in accordance with FCC Rules and Regulations, Volume II; Part 2, Sub-part J, Sections 2.947, 2.1033(c), 2.1041, 2.1046, 2.1047, 2.1051, 2.1053, 2.1055, 2.1057 and the following individual Parts: 87.



Standard Test Conditions and Engineering Practices

Except as noted herein, the following conditions and procedures were observed during the testing:

In accordance with ANSI/C63.4-2009, and unless otherwise indicated in the specific measurement results, the ambient temperature of the actual EUT was maintained within the range of 10° to 40°C (50° to 104 °F) unless the particular equipment requirements specify testing over a different temperature range. Also, unless otherwise indicated, the humidity levels were in the range of 10% to 87% relative humidity.

Measurement results, unless otherwise noted, are worst-case measurements.

A2LA

"A2LA has accredited Compliance Testing in Chandler, AZ for technical competence in the field of Electrical testing. The accreditation covers the specific tests and types of tests listed on the agreed scope of accreditation. This laboratory meets the requirements of ISO 17025:2005 'General Requirements for the Competence of Testing and Calibration Laboratories' and any additional program requirements in the identified field of testing."

Please refer to www.a2la.org for current scope of accreditation.

Certificate number: 2152.01



TESTING CERT# 2152.01

FCC OATS Reg. #933597

IC Reg. # 2044A-1



List of General Information Required for Certification

In Accordance with FCC Rules and Regulations,
Volume II, Part 2 and to Part 87

Sub-part 2.1033 (c)(1):

Name and Address of Applicant: EMS Technologies Canada, Ltd
400 Maple Grove Rd
Ottawa, ON K2V 1B8
Canada

Manufacturer: EMS Technologies Canada, Ltd
400 Maple Grove Rd
Ottawa, ON K2V 1B8
Canada

(c)(2): **FCC ID:** K6KHSD-128

Model Number: HSD-128

(c)(3): **Instruction Manual(s):**

Please see attached exhibits

(c)(4): **Type of Emission:** BPSK, QPSK, QAM

(c)(5): **Frequency Range, MHz:** 1626.5 – 1660.5

(c)(6): **Power Rating, Watts:** 59.29
_____ Switchable X Variable _____ N/A

FCC Grant Note: None

(c)(7): **Maximum Allowable Power, Watts:** 60 W

DUT Results: Passes X Fails _____



Subpart 2.1033 (continued)

(c)(8): Voltages & currents in all elements in final RF stage, including final transistor or solid-state device:

Collector Current, A =	60 mA
Collector Voltage, Vdc =	3.8
Supply Voltage, Vdc =	3.8

(c)(9): **Tune-Up Procedure:**

Please see attached exhibits

(c)(10): **Circuit Diagram/Circuit Description:**

Including description of circuitry & devices provided for determining and stabilizing frequency, for suppression of spurious radiation, for limiting modulation and limiting power.

Please see attached exhibits

(c)(11): **Label Information:**

Please see attached exhibits

(c)(12): **Photographs:**

Please see attached exhibits

(c)(13): **Digital Modulation Description:**

Attached Exhibits
 N/A

(c)(14): **Test and Measurement Data:**

Follows



Test Results Summary

Specification	Test Name	Pass, Fail, N/A	Comments
2.1046, 87.131	Carrier Output Power (Conducted)	Pass	
2.1051, 87.139(i)(1)	Unwanted Emissions (Transmitter Conducted)	Pass	
2.1053	Field Strength of Spurious Radiation	Pass	
2.1049, 87.139(i)(3)	Emission Masks (Occupied Bandwidth)	Pass	See FCC waiver for allowable variance
2.1047	Audio Low Pass Filter (Voice Input)	N/A	The EUT does not contain an audio input
2.1047	Audio Frequency Response	N/A	The EUT does not contain an audio input
2.1047	Modulation Limiting	N/A	The EUT does not contain an audio input
2.1055, 87.133(a)	Frequency Stability (Temperature Variation)	Pass	
2.1055, 87.133(a)	Frequency Stability (Voltage Variation)	Pass	



Name of Test: Carrier Output Power (Conducted)
Specification: 2.1046, 87.131
Test Equipment Utilized: 0668, 04806, i00331

Engineer: J. Erhard
Test Date: 3/23/2010

Measurement Procedure

The Equipment Under Test (EUT) was connected directly to a spectrum analyzer with the RBW set to 1 MHz and the VBW set to 3 X RBW which set the RBW greater than the transmit signal ensuring there was no signal suppression while measuring a modulated signal. The peak readings were taken for each modulation type and the result was then compared to the limit.

Test Setup

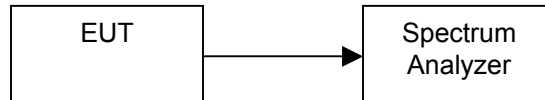

BPSK Transmitter Peak Output Power

Tuned Frequency MHz	Measured Power dBm	Measured Power W	Limit W	Result
1626.5	47.73	59.29	60	Pass
1643.5	47.73	59.29	60	Pass
1660.5	47.73	59.29	60	Pass

QPSK Transmitter Peak Output Power

Tuned Frequency MHz	Measured Power dBm	Measured Power W	Limit W	Result
1626.5	47.73	59.29	60	Pass
1643.5	47.73	59.29	60	Pass
1660.5	47.73	59.29	60	Pass

QAM Transmitter Peak Output Power

Tuned Frequency MHz	Measured Power dBm	Measured Power W	Limit W	Result
1626.5	47.73	59.29	60	Pass
1643.5	47.73	59.29	60	Pass
1660.5	47.73	59.29	60	Pass

Name of Test: Conducted Spurious Emissions
Specification: 2.1051, 87.139(i)(1)
Test Equipment Utilized: 0668, 04806, i00331

Engineer: J. Erhard
Test Date: 3/25/2010

Test Procedure

The EUT was connected directly to a spectrum analyzer to verify that the UUT met the requirements for spurious emissions. The RBW was set according to the requirements of 87139 (i)(1). The power was corrected for the measurement RBW bandwidth. The dBc limit, the DLNA rejection, and corrected power were summed together to determine the necessary dBm value of the EUT to provide a system rejection greater than the FCC limit. This necessary value was compared to the measured value to ensure compliance to the specification, which is expressed as the margin. A negative value indicates a passing result.

Test Setup

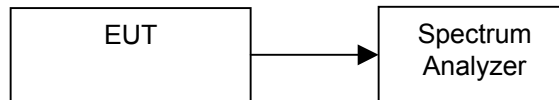

BPSK 1626.5 MHz Conducted Spurious Emissions

Freq (MHz)	Limit (dBc)	RBW (MHz)	F Type DLNA Rejection (dB)	Measured Power (dBm)	Corrected Power (dBm)	Necessary Level (dBm)	Measured Level (dBm)	Margin (dB)
.010 to 1525	-135	0.004	80	47.32	48.57	-6.43	-40.47	-34.04
1525 to 1559	-203	0.004	120	47.32	48.57	-34.43	-51.73	-17.30
1559 to 1585	-155	1	111	47.73	47.73	3.73	-25.01	-28.74
1585 to 1605	-143	1	95	47.73	47.73	-0.27	-22.94	-22.67
1605 to 1610	-117	1	62	47.73	47.73	-7.27	-21.9	-14.63
1610 to 1610.6	-95	1	40	47.73	47.73	-7.27	-20.44	-13.17
1610.6 to 1613.8	-49	1	40	47.73	47.73	38.73	-20.25	-58.98
1613.8 to 1614	-95	1	40	47.73	47.73	-7.27	-19.19	-11.92
1614 to 1620	-70	0.004	30	47.32	48.57	8.57	-27.28	-35.85
1620 to 1624.5	-70	0.004	20	47.32	48.57	-1.43	-27.28	-25.85
1624.5 to 1625.5	-70	0.004	10	47.32	48.57	-11.43	-28.25	-16.82
1625.5 to 1626.5	-70	0.004	1.3	47.32	48.57	-20.13	-28.25	-8.12
1626.5 to 1660	-70	0.004	0.8	47.32	48.57	-20.63	-27.05	-6.42
1660 to 1670	-19.5	0.02	0.8	47.39	45.63	26.93	-34.16	-61.09
1670 to 1735	-60	0.004	0.8	47.32	48.57	-10.63	-45.82	-35.19
1735 to 1865	-105	0.004	50	47.32	48.57	-6.43	-27.01	-20.58
1865 to 3250	-105	0.004	20	47.32	48.57	-36.43	-53.49	-17.06
3250 to 3330	-105	0.004	50	47.32	48.57	-6.43	-8.3	-1.87
3330 to 4000	-105	0.004	40	47.32	48.57	-16.43	-56.87	-40.44
4000 to 12000	-105	0.004	50	47.32	48.57	-6.43	-30.92	-24.49
12000 to 18000	-70	0.004	15	47.32	48.57	-6.43	-52.21	-45.78

BPSK 1643.5 MHz Conducted Spurious Emissions

Freq (MHz)	Limit (dBc)	RBW (MHz)	F Type DLNA Rejection (dB)	Measured Power (dBm)	Corrected Power (dBm)	Necessary Level (dBm)	Measured Level (dBm)	Margin (dB)
.010 to 1525	-135	0.004	80	47.63	48.88	-6.12	-43.7	-37.58
1525 to 1559	-203	0.004	120	47.63	48.88	-34.12	-52.2	-18.08
1559 to 1585	-155	1	111	47.73	47.73	3.73	-24.62	-28.35
1585 to 1605	-143	1	95	47.73	47.73	-0.27	-23.91	-23.64
1605 to 1610	-117	1	62	47.73	47.73	-7.27	-22.38	-15.11
1610 to 1610.6	-95	1	40	47.73	47.73	-7.27	-21.34	-14.07
1610.6 to 1613.8	-49	1	40	47.73	47.73	38.73	-20.98	-59.71
1613.8 to 1614	-95	1	40	47.73	47.73	-7.27	-20.29	-13.02
1614 to 1620	-70	0.004	30	47.63	48.88	8.88	-38.98	-47.86
1620 to 1624.5	-70	0.004	20	47.63	48.88	-1.12	-38.98	-37.86
1624.5 to 1625.5	-70	0.004	10	47.63	48.88	-11.12	-36.06	-24.94
1625.5 to 1626.5	-70	0.004	1.3	47.63	48.88	-19.82	-36.06	-16.24
1626.5 to 1660	-70	0.004	0.8	47.63	48.88	-20.32	-26.91	-6.59
1660 to 1670	-19.5	0.02	0.8	45.97	44.21	25.51	-33.26	-58.77
1670 to 1735	-60	0.004	0.8	47.63	48.88	-10.32	-42.42	-32.10
1735 to 1865	-105	0.004	50	47.63	48.88	-6.12	-31.35	-25.23
1865 to 3250	-105	0.004	20	47.63	48.88	-36.12	-52.68	-16.56
3250 to 3330	-105	0.004	50	47.63	48.88	-6.12	-12.25	-6.13
3330 to 4000	-105	0.004	40	47.63	48.88	-16.12	-55.06	-38.94
4000 to 12000	-105	0.004	50	47.63	48.88	-6.12	-38.74	-32.62
12000 to 18000	-70	0.004	15	47.63	48.88	-6.12	-49.67	-43.55

BPSK 1660.5 MHz Conducted Spurious Emissions

Freq (MHz)	Limit (dBc)	RBW (MHz)	F Type DLNA Rejection (dB)	Measured Power (dBm)	Corrected Power (dBm)	Necessary Level (dBm)	Measured Level (dBm)	Margin (dB)
.010 to 1525	-135	0.004	80	47.02	48.27	-6.73	-45.23	-38.50
1525 to 1559	-203	0.004	120	47.02	48.27	-34.73	-53.74	-19.01
1559 to 1585	-155	1	111	47.73	47.73	3.73	-24.86	-28.59
1585 to 1605	-143	1	95	47.73	47.73	-0.27	-23.53	-23.26
1605 to 1610	-117	1	62	47.73	47.73	-7.27	-21.83	-14.56
1610 to 1610.6	-95	1	40	47.73	47.73	-7.27	-21.73	-14.46
1610.6 to 1613.8	-49	1	40	47.73	47.73	38.73	-21.18	-59.91
1613.8 to 1614	-95	1	40	47.73	47.73	-7.27	-20.64	-13.37
1614 to 1620	-70	0.004	30	47.02	48.27	8.27	-38.2	-46.47
1620 to 1624.5	-70	0.004	20	47.02	48.27	-1.73	-36.05	-34.32
1624.5 to 1625.5	-70	0.004	10	47.02	48.27	-11.73	-36.05	-24.32
1625.5 to 1626.5	-70	0.004	1.3	47.02	48.27	-20.43	-36.05	-15.62
1626.5 to 1660	-70	0.004	0.8	47.02	48.27	-20.93	-27.51	-6.58
1660 to 1670	-19.5	0.02	0.8	45.36	43.60	24.90	-31.14	-56.04
1670 to 1735	-60	0.004	0.8	47.02	48.27	-10.93	-38.52	-27.59
1735 to 1865	-105	0.004	50	47.02	48.27	-6.73	-33.44	-26.71
1865 to 3250	-105	0.004	20	47.02	48.27	-36.73	-52.53	-15.80
3250 to 3330	-105	0.004	50	47.02	48.27	-6.73	-14.77	-8.04
3330 to 4000	-105	0.004	40	47.02	48.27	-16.73	-56	-39.27
4000 to 12000	-105	0.004	50	47.02	48.27	-6.73	-34.83	-28.10
12000 to 18000	-70	0.004	15	47.02	48.27	-6.73	-50.27	-43.54

QPSK 1626.5 MHz Conducted Spurious Emissions

Freq (MHz)	Limit (dBc)	RBW (MHz)	F Type DLNA Rejection (dB)	Measured Power (dBm)	Corrected Power (dBm)	Necessary Level (dBm)	Measured Level (dBm)	Margin (dB)
.010 to 1525	-135	0.004	80	47.69	48.94	-6.06	-40.42	-34.36
1525 to 1559	-203	0.004	120	47.69	48.94	-34.06	-52.19	-18.13
1559 to 1585	-155	1	111	47.73	47.73	3.73	-24.61	-28.34
1585 to 1605	-143	1	95	47.73	47.73	-0.27	-23.89	-23.62
1605 to 1610	-117	1	62	47.73	47.73	-7.27	-21.73	-14.46
1610 to 1610.6	-95	1	40	47.73	47.73	37.28	-20.80	-58.08
1610.6 to 1613.8	-49	1	40	47.73	47.73	38.73	-19.62	-58.35
1613.8 to 1614	-95	1	40	47.73	47.73	-7.27	-18.99	-11.72
1614 to 1620	-70	0.004	30	47.69	48.94	8.94	-26.22	-35.16
1620 to 1624.5	-70	0.004	20	47.69	48.94	-1.06	-28.76	-27.70
1624.5 to 1625.5	-70	0.004	10	47.69	48.94	-11.06	-30.77	-19.71
1625.5 to 1626.5	-70	0.004	1.3	47.69	48.94	-19.76	-28.76	-9.00
1626.5 to 1660	-70	0.004	0.8	47.69	48.94	-20.26	-28.01	-7.75
1660 to 1670	-19.5	0.02	0.8	47.48	45.72	27.02	-34.17	-61.19
1670 to 1735	-60	0.004	0.8	47.69	48.94	-10.26	-45.39	-35.13
1735 to 1865	-105	0.004	50	47.69	48.94	-6.06	-27.52	-21.46
1865 to 3250	-105	0.004	20	47.69	48.94	-36.06	-52.53	-16.47
3250 to 3330	-105	0.004	50	47.69	48.94	-6.06	-14.79	-8.73
3330 to 4000	-105	0.004	40	47.69	48.94	-16.06	-55.08	-39.02
4000 to 12000	-105	0.004	50	47.69	48.94	-6.06	-35.27	-29.21
12000 to 18000	-70	0.004	15	47.69	48.94	-6.06	-48.29	-42.23

QPSK 1643.5 MHz Conducted Spurious Emissions

Freq (MHz)	Limit (dBc)	RBW (MHz)	F Type DLNA Rejection (dB)	Measured Power (dBm)	Corrected Power (dBm)	Necessary Level (dBm)	Measured Level (dBm)	Margin (dB)
.010 to 1525	-135	0.004	80	47.56	48.81	-6.19	-41.19	-35.00
1525 to 1559	-203	0.004	120	47.56	48.81	-34.19	-52.73	-18.54
1559 to 1585	-155	1	111	47.73	47.73	3.73	-25.48	-29.21
1585 to 1605	-143	1	95	47.73	47.73	-0.27	-23.3	-23.03
1605 to 1610	-117	1	62	47.73	47.73	-7.27	-21.56	-14.29
1610 to 1610.6	-95	1	40	47.73	47.73	-7.27	-21.84	-14.57
1610.6 to 1613.8	-49	1	40	47.73	47.73	38.73	-20.58	-59.31
1613.8 to 1614	-95	1	40	47.73	47.73	-7.27	-20.32	-13.05
1614 to 1620	-70	0.004	30	47.56	48.81	8.81	-41.74	-50.55
1620 to 1624.5	-70	0.004	20	47.56	48.81	-1.19	-40.13	-38.94
1624.5 to 1625.5	-70	0.004	10	47.56	48.81	-11.19	-35.7	-24.51
1625.5 to 1626.5	-70	0.004	1.3	47.56	48.81	-19.89	-44.39	-24.50
1626.5 to 1660	-70	0.004	0.8	47.56	48.81	-20.39	-25.45	-5.06
1660 to 1670	-19.5	0.02	0.8	47.67	45.91	27.21	-33.76	-60.97
1670 to 1735	-60	0.004	0.8	47.56	48.81	-10.39	-45.6	-35.21
1735 to 1865	-105	0.004	50	47.56	48.81	-6.19	-31.42	-25.23
1865 to 3250	-105	0.004	20	47.56	48.81	-36.19	-53.41	-17.22
3250 to 3330	-105	0.004	50	47.56	48.81	-6.19	-13.5	-7.31
3330 to 4000	-105	0.004	40	47.56	48.81	-16.19	-55.09	-38.90
4000 to 12000	-105	0.004	50	47.56	48.81	-6.19	-48.96	-42.77
12000 to 18000	-70	0.004	15	47.56	48.81	-6.19	-50.57	-44.38



QPSK 1660.5 MHz Conducted Spurious Emissions

Freq (MHz)	Limit (dBc)	RBW (MHz)	F Type DLNA Rejection (dB)	Measured Power (dBm)	Corrected Power (dBm)	Necessary Level (dBm)	Measured Level (dBm)	Margin (dB)
.010 to 1525	-135	0.004	80	47.37	48.62	-6.38	-45.19	-38.81
1525 to 1559	-203	0.004	120	47.37	48.62	-34.38	-52.99	-18.61
1559 to 1585	-155	1	111	47.73	47.73	3.73	-25.01	-28.74
1585 to 1605	-143	1	95	47.73	47.73	-0.27	-22.9	-22.63
1605 to 1610	-117	1	62	47.73	47.73	-7.27	-21.75	-14.48
1610 to 1610.6	-95	1	40	47.73	47.73	-7.27	-21.49	-14.22
1610.6 to 1613.8	-49	1	40	47.73	47.73	38.73	-21.17	-59.90
1613.8 to 1614	-95	1	40	47.73	47.73	-7.27	-19.11	-11.84
1614 to 1620	-70	0.004	30	47.37	48.62	8.62	-39.79	-48.41
1620 to 1624.5	-70	0.004	20	47.37	48.62	-1.38	-38.4	-37.02
1624.5 to 1625.5	-70	0.004	10	47.37	48.62	-11.38	-34.13	-22.75
1625.5 to 1626.5	-70	0.004	1.3	47.37	48.62	-20.08	-41.9	-21.82
1626.5 to 1660	-70	0.004	0.8	47.37	48.62	-20.58	-26.6	-6.02
1660 to 1670	-19.5	0.02	0.8	47.34	45.58	26.88	-20.36	-47.24
1670 to 1735	-60	0.004	0.8	47.37	48.62	-10.58	-34.31	-23.73
1735 to 1865	-105	0.004	50	47.37	48.62	-6.38	-34.07	-27.69
1865 to 3250	-105	0.004	20	47.37	48.62	-36.38	-55.22	-18.84
3250 to 3330	-105	0.004	50	47.37	48.62	-6.38	-15.43	-9.05
3330 to 4000	-105	0.004	40	47.37	48.62	-16.38	-58	-41.62
4000 to 12000	-105	0.004	50	47.37	48.62	-6.38	-40.62	-34.24
12000 to 18000	-70	0.004	15	47.37	48.62	-6.38	-50.58	-44.20

QAM 1626.5 MHz Conducted Spurious Emissions

Freq (MHz)	Limit (dBc)	RBW (MHz)	F Type DLNA Rejection (dB)	Measured Power (dBm)	Corrected Power (dBm)	Necessary Level (dBm)	Measured Level (dBm)	Margin (dB)
.010 to 1525	-135	0.004	80	40.87	42.12	-12.88	-51.86	-38.98
1525 to 1559	-203	0.004	120	40.87	42.12	-40.88	-51.85	-10.97
1559 to 1585	-155	1	111	47.73	47.73	3.73	-35.34	-39.07
1585 to 1605	-143	1	95	47.73	47.73	-0.27	-22.06	-21.79
1605 to 1610	-117	1	62	47.73	47.73	-7.27	-22.28	-15.01
1610 to 1610.6	-95	1	40	47.73	47.73	37.28	-22.01	-59.29
1610.6 to 1613.8	-49	1	40	47.73	47.73	38.73	-20.67	-59.40
1613.8 to 1614	-95	1	40	47.73	47.73	-7.27	-19.46	-12.19
1614 to 1620	-70	0.004	30	40.87	42.12	2.12	-35.92	-38.04
1620 to 1624.5	-70	0.004	20	40.87	42.12	-7.88	-33.71	-25.83
1624.5 to 1625.5	-70	0.004	10	40.87	42.12	-17.88	-35.40	-17.52
1625.5 to 1626.5	-70	0.004	1.3	40.87	42.12	-26.58	-34.45	-7.87
1626.5 to 1660	-70	0.004	0.8	40.87	42.12	-27.08	-31.80	-4.72
1660 to 1670	-19.5	0.02	0.8	46.81	45.05	26.35	-36.99	-63.34
1670 to 1735	-60	0.004	0.8	40.87	42.12	-17.08	-47.53	-30.45
1735 to 1865	-105	0.004	50	40.87	42.12	-12.88	-27.76	-14.88
1865 to 3250	-105	0.004	20	40.87	42.12	-42.88	-52.02	-9.14
3250 to 3330	-105	0.004	50	40.87	42.12	-12.88	-23.25	-10.37
3330 to 4000	-105	0.004	40	40.87	42.12	-22.88	-54.94	-32.06
4000 to 12000	-105	0.004	50	40.87	42.12	-12.88	-40.20	-27.32
12000 to 18000	-70	0.004	15	40.87	42.12	-12.88	-49.42	-36.54

QAM 1643.5 MHz Conducted Spurious Emissions

Freq (MHz)	Limit (dBc)	RBW (MHz)	F Type DLNA Rejection (dB)	Measured Power (dBm)	Corrected Power (dBm)	Necessary Level (dBm)	Measured Level (dBm)	Margin (dB)
.010 to 1525	-135	0.004	80	41.46	42.71	-12.29	-50.06	-37.77
1525 to 1559	-203	0.004	120	41.46	42.71	-40.29	-52.33	-12.04
1559 to 1585	-155	1	111	47.73	47.73	3.73	-25.19	-28.92
1585 to 1605	-143	1	95	47.73	47.73	-0.27	-24.79	-24.52
1605 to 1610	-117	1	62	47.73	47.73	-7.27	-21.29	-14.02
1610 to 1610.6	-95	1	40	47.73	47.73	-7.27	-21.72	-14.45
1610.6 to 1613.8	-49	1	40	47.73	47.73	38.73	-21.55	-60.28
1613.8 to 1614	-95	1	40	47.73	47.73	-7.27	-21.02	-13.75
1614 to 1620	-70	0.004	30	41.46	42.71	2.71	-45.19	-47.90
1620 to 1624.5	-70	0.004	20	41.46	42.71	-7.29	-42.91	-35.62
1624.5 to 1625.5	-70	0.004	10	41.46	42.71	-17.29	-40.66	-23.37
1625.5 to 1626.5	-70	0.004	1.3	41.46	42.71	-25.99	-46.38	-20.39
1626.5 to 1660	-70	0.004	0.8	41.46	42.71	-26.49	-30.79	-4.30
1660 to 1670	-19.5	0.02	0.8	46.65	44.89	26.19	-34.71	-60.90
1670 to 1735	-60	0.004	0.8	41.46	42.71	-16.49	-44.43	-27.94
1735 to 1865	-105	0.004	50	41.46	42.71	-12.29	-31.43	-19.14
1865 to 3250	-105	0.004	20	41.46	42.71	-42.29	-52.3	-10.01
3250 to 3330	-105	0.004	50	41.46	42.71	-12.29	-26.23	-13.94
3330 to 4000	-105	0.004	40	41.46	42.71	-22.29	-55.12	-32.83
4000 to 12000	-105	0.004	50	41.46	42.71	-12.29	-51.24	-38.95
12000 to 18000	-70	0.004	15	41.46	42.71	-12.29	-50.33	-38.04

QAM 1660.5 MHz Conducted Spurious Emissions

Freq (MHz)	Limit (dBc)	RBW (MHz)	F Type DLNA Rejection (dB)	Measured Power (dBm)	Corrected Power (dBm)	Necessary Level (dBm)	Measured Level (dBm)	Margin (dB)
.010 to 1525	-135	0.004	80	41.36	42.61	-12.39	-53.51	-41.12
1525 to 1559	-203	0.004	120	41.36	42.61	-40.39	-53.42	-13.03
1559 to 1585	-155	1	111	47.73	47.73	3.73	-26.2	-29.93
1585 to 1605	-143	1	95	47.73	47.73	-0.27	-24.63	-24.36
1605 to 1610	-117	1	62	47.73	47.73	-7.27	-22.96	-15.69
1610 to 1610.6	-95	1	40	47.73	47.73	-7.27	-22.71	-15.44
1610.6 to 1613.8	-49	1	40	47.73	47.73	38.73	-21.15	-59.88
1613.8 to 1614	-95	1	40	47.73	47.73	-7.27	-21.72	-14.45
1614 to 1620	-70	0.004	30	41.36	42.61	2.61	-42.81	-45.42
1620 to 1624.5	-70	0.004	20	41.36	42.61	-7.39	-42.83	-35.44
1624.5 to 1625.5	-70	0.004	10	41.36	42.61	-17.39	-39.29	-21.90
1625.5 to 1626.5	-70	0.004	1.3	41.36	42.61	-26.09	-43.66	-17.57
1626.5 to 1660	-70	0.004	0.8	41.36	42.61	-26.59	-29.78	-3.19
1660 to 1670	-19.5	0.02	0.8	46.98	45.22	26.52	-24.33	-50.85
1670 to 1735	-60	0.004	0.8	41.36	42.61	-16.59	-42.03	-25.44
1735 to 1865	-105	0.004	50	41.36	42.61	-12.39	-33.54	-21.15
1865 to 3250	-105	0.004	20	41.36	42.61	-42.39	-53.41	-11.02
3250 to 3330	-105	0.004	50	41.36	42.61	-12.39	-27.26	-14.87
3330 to 4000	-105	0.004	40	41.36	42.61	-22.39	-56.08	-33.69
4000 to 12000	-105	0.004	50	41.36	42.61	-12.39	-46.46	-34.07
12000 to 18000	-70	0.004	15	41.36	42.61	-12.39	-51.57	-39.18

**BPSK 1626.5 MHz Conducted Spurious Emissions**

Freq (MHz)	Limit (dBc)	RBW (MHz)	D Type DLNA Rejection (dB)	Measured Power (dBm)	Corrected Power (dBm)	Necessary Level (dBm)	Measured Level (dBm)	Margin (dB)
.010 to 1525	-135	0.004	80	47.32	48.57	-6.43	-40.47	-34.04
1525 to 1559	-203	0.004	120	47.32	48.57	-34.43	-51.73	-17.30
1559 to 1585	-155	1	111	47.73	47.73	3.73	-25.01	-28.74
1585 to 1605	-143	1	95	47.73	47.73	-0.27	-22.94	-22.67
1605 to 1610	-117	1	62	47.73	47.73	-7.27	-21.9	-14.63
1610 to 1610.6	-95	1	40	47.73	47.73	-7.27	-20.44	-13.17
1610.6 to 1613.8	-49	1	40	47.73	47.73	38.73	-20.25	-58.98
1613.8 to 1614	-95	1	40	47.73	47.73	-7.27	-19.19	-11.92
1614 to 1620	-70	0.004	20	47.32	48.57	-1.43	-27.28	-25.85
1620 to 1626.5	-70	0.004	10	47.32	48.57	-11.43	-27.28	-15.85
1626.5 to 1660	-70	0.004	0.8	47.32	48.57	-20.63	-27.05	-6.42
1660 to 1670	-19.5	0.02	0.8	47.39	45.63	26.93	-34.16	-61.09
1670 to 1735	-60	0.004	0.8	47.32	48.57	-10.63	-45.82	-35.19
1735 to 12000	-105	0.004	50	47.32	48.57	-6.43	-8.3	-1.87
12000 to 18000	-70	0.004	15	47.32	48.57	-6.43	-52.21	-45.78

BPSK 1643.5 MHz Conducted Spurious Emissions

Freq (MHz)	Limit (dBc)	RBW (MHz)	D Type DLNA Rejection (dB)	Measured Power (dBm)	Corrected Power (dBm)	Necessary Level (dBm)	Measured Level (dBm)	Margin (dB)
.010 to 1525	-135	0.004	80	47.63	48.88	-6.12	-43.7	-37.58
1525 to 1559	-203	0.004	120	47.63	48.88	-34.12	-52.2	-18.08
1559 to 1585	-155	1	111	47.73	47.73	3.73	-24.62	-28.35
1585 to 1605	-143	1	95	47.73	47.73	-0.27	-23.91	-23.64
1605 to 1610	-117	1	62	47.73	47.73	-7.27	-22.38	-15.11
1610 to 1610.6	-95	1	40	47.73	47.73	-7.27	-21.34	-14.07
1610.6 to 1613.8	-49	1	40	47.73	47.73	38.73	-20.98	-59.71
1613.8 to 1614	-95	1	40	47.73	47.73	-7.27	-20.29	-13.02
1614 to 1620	-70	0.004	20	47.63	48.88	-1.12	-38.98	-37.86
1620 to 1626.5	-70	0.004	10	47.63	48.88	-11.12	-36.06	-24.94
1626.5 to 1660	-70	0.004	0.8	47.63	48.88	-20.32	-26.91	-6.59
1660 to 1670	-19.5	0.02	0.8	45.97	44.21	25.51	-33.26	-58.77
1670 to 1735	-60	0.004	0.8	47.63	48.88	-10.32	-42.42	-32.10
1735 to 12000	-105	0.004	50	47.63	48.88	-6.12	-12.25	-6.13
12000 to 18000	-70	0.004	15	47.63	48.88	-6.12	-49.67	-43.55

**BPSK 1660.5 MHz Conducted Spurious Emissions**

Freq (MHz)	Limit (dBc)	RBW (MHz)	D Type DLNA Rejection (dB)	Measured Power (dBm)	Corrected Power (dBm)	Necessary Level (dBm)	Measured Level (dBm)	Margin (dB)
.010 to 1525	-135	0.004	80	47.02	48.27	-6.73	-45.23	-38.50
1525 to 1559	-203	0.004	120	47.02	48.27	-34.73	-53.74	-19.01
1559 to 1585	-155	1	111	47.73	47.73	3.73	-24.86	-28.59
1585 to 1605	-143	1	95	47.73	47.73	-0.27	-23.53	-23.26
1605 to 1610	-117	1	62	47.73	47.73	-7.27	-21.83	-14.56
1610 to 1610.6	-95	1	40	47.73	47.73	-7.27	-21.73	-14.46
1610.6 to 1613.8	-49	1	40	47.73	47.73	38.73	-21.18	-59.91
1613.8 to 1614	-95	1	40	47.73	47.73	-7.27	-20.64	-13.37
1614 to 1620	-70	0.004	20	47.02	48.27	-1.73	-38.2	-36.47
1620 to 1626.5	-70	0.004	10	47.02	48.27	-11.73	-36.05	-24.32
1626.5 to 1660	-70	0.004	0.8	47.02	48.27	-20.93	-27.51	-6.58
1660 to 1670	-19.5	0.02	0.8	45.36	43.60	24.90	-31.14	-56.04
1670 to 1735	-60	0.004	0.8	47.02	48.27	-10.93	-38.52	-27.59
1735 to 12000	-105	0.004	50	47.02	48.27	-6.73	-14.77	-8.04
12000 to 18000	-70	0.004	15	47.02	48.27	-6.73	-50.27	-43.54

QPSK 1626.5 MHz Conducted Spurious Emissions

Freq (MHz)	Limit (dBc)	RBW (MHz)	D Type DLNA Rejection (dB)	Measured Power (dBm)	Corrected Power (dBm)	Necessary Level (dBm)	Measured Level (dBm)	Margin (dB)
.010 to 1525	-135	0.004	80	47.69	48.94	-6.06	-40.42	-34.36
1525 to 1559	-203	0.004	120	47.69	48.94	-34.06	-52.19	-18.13
1559 to 1585	-155	1	111	47.73	47.73	3.73	-24.61	-28.34
1585 to 1605	-143	1	95	47.73	47.73	-0.27	-23.89	-23.62
1605 to 1610	-117	1	62	47.73	47.73	-7.27	-21.73	-14.46
1610 to 1610.6	-95	1	40	47.73	47.73	37.28	-20.80	-58.08
1610.6 to 1613.8	-49	1	40	47.73	47.73	38.73	-19.62	-58.35
1613.8 to 1614	-95	1	40	47.73	47.73	-7.27	-18.99	-11.72
1614 to 1620	-70	0.004	20	47.69	48.94	-1.06	-26.22	-25.16
1620 to 1626.5	-70	0.004	10	47.69	48.94	-11.06	-28.76	-17.70
1626.5 to 1660	-70	0.004	0.8	47.69	48.94	-20.26	-28.01	-7.75
1660 to 1670	-19.5	0.02	0.8	47.48	45.72	27.02	-34.17	-61.19
1670 to 1735	-60	0.004	0.8	47.69	48.94	-10.26	-45.39	-35.13
1735 to 12000	-105	0.004	50	47.69	48.94	-6.06	-14.79	-8.73
12000 to 18000	-70	0.004	15	47.69	48.94	-6.06	-48.29	-42.23

**QPSK 1643.5 MHz Conducted Spurious Emissions**

Freq (MHz)	Limit (dBc)	RBW (MHz)	D Type DLNA Rejection (dB)	Measured Power (dBm)	Corrected Power (dBm)	Necessary Level (dBm)	Measured Level (dBm)	Margin (dB)
.010 to 1525	-135	0.004	80	47.56	48.81	-6.19	-41.19	-35.00
1525 to 1559	-203	0.004	120	47.56	48.81	-34.19	-52.73	-18.54
1559 to 1585	-155	1	111	47.73	47.73	3.73	-25.48	-29.21
1585 to 1605	-143	1	95	47.73	47.73	-0.27	-23.30	-23.03
1605 to 1610	-117	1	62	47.73	47.73	-7.27	-21.56	-14.29
1610 to 1610.6	-95	1	40	47.73	47.73	-7.27	-21.84	-14.57
1610.6 to 1613.8	-49	1	40	47.73	47.73	38.73	-20.58	-59.31
1613.8 to 1614	-95	1	40	47.73	47.73	-7.27	-20.32	-13.05
1614 to 1620	-70	0.004	20	47.56	48.81	-1.19	-41.74	-40.55
1620 to 1626.5	-70	0.004	10	47.56	48.81	-11.19	-35.70	-24.51
1626.5 to 1660	-70	0.004	0.8	47.56	48.81	-20.39	-25.45	-5.06
1660 to 1670	-19.5	0.02	0.8	47.67	45.91	27.21	-33.76	-60.97
1670 to 1735	-60	0.004	0.8	47.56	48.81	-10.39	-45.60	-35.21
1735 to 12000	-105	0.004	50	47.56	48.81	-6.19	-13.50	-7.31
12000 to 18000	-70	0.004	15	47.56	48.81	-6.19	-50.57	-44.38

QPSK 1660.5 MHz Conducted Spurious Emissions

Freq (MHz)	Limit (dBc)	RBW (MHz)	D Type DLNA Rejection (dB)	Measured Power (dBm)	Corrected Power (dBm)	Necessary Level (dBm)	Measured Level (dBm)	Margin (dB)
.010 to 1525	-135	0.004	80	47.37	48.62	-6.38	-45.19	-38.81
1525 to 1559	-203	0.004	120	47.37	48.62	-34.38	-52.99	-18.61
1559 to 1585	-155	1	111	47.73	47.73	3.73	-25.01	-28.74
1585 to 1605	-143	1	95	47.73	47.73	-0.27	-22.90	-22.63
1605 to 1610	-117	1	62	47.73	47.73	-7.27	-21.75	-14.48
1610 to 1610.6	-95	1	40	47.73	47.73	-7.27	-21.49	-14.22
1610.6 to 1613.8	-49	1	40	47.73	47.73	38.73	-21.17	-59.90
1613.8 to 1614	-95	1	40	47.73	47.73	-7.27	-19.11	-11.84
1614 to 1620	-70	0.004	20	47.37	48.62	-1.38	-39.79	-38.41
1620 to 1626.5	-70	0.004	10	47.37	48.62	-11.38	-34.13	-22.75
1626.5 to 1660	-70	0.004	0.8	47.37	48.62	-20.58	-26.60	-6.02
1660 to 1670	-19.5	0.02	0.8	47.34	45.58	26.88	-20.36	-47.24
1670 to 1735	-60	0.004	0.8	47.37	48.62	-10.58	-34.31	-23.73
1735 to 12000	-105	0.004	50	47.37	48.62	-6.38	-15.43	-9.05
12000 to 18000	-70	0.004	15	47.37	48.62	-6.38	-50.58	-44.20

**QAM 1626.5 MHz Conducted Spurious Emissions**

Freq (MHz)	Limit (dBc)	RBW (MHz)	D Type DLNA Rejection (dB)	Measured Power (dBm)	Corrected Power (dBm)	Necessary Level (dBm)	Measured Level (dBm)	Margin (dB)
.010 to 1525	-135	0.004	80	40.87	42.12	-12.88	-51.86	-38.98
1525 to 1559	-203	0.004	120	40.87	42.12	-40.88	-51.85	-10.97
1559 to 1585	-155	1	111	47.73	47.73	3.73	-35.34	-39.07
1585 to 1605	-143	1	95	47.73	47.73	-0.27	-22.06	-21.79
1605 to 1610	-117	1	62	47.73	47.73	-7.27	-22.28	-15.01
1610 to 1610.6	-95	1	40	47.73	47.73	37.28	-22.01	-59.29
1610.6 to 1613.8	-49	1	40	47.73	47.73	38.73	-20.67	-59.40
1613.8 to 1614	-95	1	40	47.73	47.73	-7.27	-19.46	-12.19
1614 to 1620	-70	0.004	20	40.87	42.12	-7.88	-35.92	-28.04
1620 to 1626.5	-70	0.004	10	40.87	42.12	-17.88	-33.71	-15.83
1626.5 to 1660	-70	0.004	0.8	40.87	42.12	-27.08	-31.80	-4.72
1660 to 1670	-19.5	0.02	0.8	46.81	45.05	26.35	-36.99	-63.34
1670 to 1735	-60	0.004	0.8	40.87	42.12	-17.08	-47.53	-30.45
1735 to 12000	-105	0.004	50	40.87	42.12	-12.88	-23.25	-10.37
12000 to 18000	-70	0.004	15	40.87	42.12	-12.88	-49.42	-36.54

QAM 1643.5 MHz Conducted Spurious Emissions

Freq (MHz)	Limit (dBc)	RBW (MHz)	D Type DLNA Rejection (dB)	Measured Power (dBm)	Corrected Power (dBm)	Necessary Level (dBm)	Measured Level (dBm)	Margin (dB)
.010 to 1525	-135	0.004	80	41.46	42.71	-12.29	-50.06	-37.77
1525 to 1559	-203	0.004	120	41.46	42.71	-40.29	-52.33	-12.04
1559 to 1585	-155	1	111	47.73	47.73	3.73	-25.19	-28.92
1585 to 1605	-143	1	95	47.73	47.73	-0.27	-24.79	-24.52
1605 to 1610	-117	1	62	47.73	47.73	-7.27	-21.29	-14.02
1610 to 1610.6	-95	1	40	47.73	47.73	-7.27	-21.72	-14.45
1610.6 to 1613.8	-49	1	40	47.73	47.73	38.73	-21.55	-60.28
1613.8 to 1614	-95	1	40	47.73	47.73	-7.27	-21.02	-13.75
1614 to 1620	-70	0.004	20	41.46	42.71	-7.29	-45.19	-37.90
1620 to 1626.5	-70	0.004	10	41.46	42.71	-17.29	-40.66	-23.37
1626.5 to 1660	-70	0.004	0.8	41.46	42.71	-26.49	-30.79	-4.30
1660 to 1670	-19.5	0.02	0.8	46.65	44.89	26.19	-34.71	-60.90
1670 to 1735	-60	0.004	0.8	41.46	42.71	-16.49	-44.43	-27.94
1735 to 12000	-105	0.004	50	41.46	42.71	-12.29	-26.23	-13.94
12000 to 18000	-70	0.004	15	41.46	42.71	-12.29	-50.33	-38.04

QAM 1660.5 MHz Conducted Spurious Emissions

Freq (MHz)	Limit (dBc)	RBW (MHz)	D Type DLNA Rejection (dB)	Measured Power (dBm)	Corrected Power (dBm)	Necessary Level (dBm)	Measured Level (dBm)	Margin (dB)
.010 to 1525	-135	0.004	80	41.36	42.61	-12.39	-53.51	-41.12
1525 to 1559	-203	0.004	120	41.36	42.61	-40.39	-53.42	-13.03
1559 to 1585	-155	1	111	47.73	47.73	3.73	-26.20	-29.93
1585 to 1605	-143	1	95	47.73	47.73	-0.27	-24.63	-24.36
1605 to 1610	-117	1	62	47.73	47.73	-7.27	-22.96	-15.69
1610 to 1610.6	-95	1	40	47.73	47.73	-7.27	-22.71	-15.44
1610.6 to 1613.8	-49	1	40	47.73	47.73	38.73	-21.15	-59.88
1613.8 to 1614	-95	1	40	47.73	47.73	-7.27	-21.72	-14.45
1614 to 1620	-70	0.004	20	41.36	42.61	-7.39	-42.81	-35.42
1620 to 1626.5	-70	0.004	10	41.36	42.61	-17.39	-39.29	-21.90
1626.5 to 1660	-70	0.004	0.8	41.36	42.61	-26.59	-29.78	-3.19
1660 to 1670	-19.5	0.02	0.8	46.98	45.22	26.52	-24.33	-50.85
1670 to 1735	-60	0.004	0.8	41.36	42.61	-16.59	-42.03	-25.44
1735 to 12000	-105	0.004	50	41.36	42.61	-12.39	-27.26	-14.87
12000 to 18000	-70	0.004	15	41.36	42.61	-12.39	-51.57	-39.18

BPSK 1626.5 MHz Conducted Spurious Emissions

Freq (MHz)	Limit (dBc)	RBW (MHz)	Modified A Type DLNA Rejection (dB)	Measured Power (dBm)	Corrected Power (dBm)	Necessary Level (dBm)	Measured Level (dBm)	Margin (dB)
.010 to 1525	-135	0.004	80	47.32	48.57	-6.43	-40.47	-34.04
1525 to 1559	-203	0.004	120	47.32	48.57	-34.43	-51.73	-17.30
1559 to 1585	-155	1	100	47.73	47.73	-7.27	-25.01	-17.74
1585 to 1605	-143	1	88	47.73	47.73	-7.27	-22.94	-15.67
1605 to 1610	-117	1	62	47.73	47.73	-7.27	-21.9	-14.63
1610 to 1610.6	-95	1	40	47.73	47.73	-7.27	-20.44	-13.17
1610.6 to 1613.8	-49	1	40	47.73	47.73	38.73	-20.25	-58.98
1613.8 to 1614	-95	1	40	47.73	47.73	-7.27	-19.19	-11.92
1614 to 1620	-70	0.004	2.3	47.32	48.57	-19.13	-27.28	-8.15
1620 to 1626.5	-70	0.004	2.3	47.32	48.57	-19.13	-27.28	-8.15
1626.5 to 1660	-70	0.004	0.8	47.32	48.57	-20.63	-27.05	-6.42
1660 to 1670	-19.5	0.02	0.8	47.39	45.63	26.93	-34.16	-61.09
1670 to 1735	-60	0.004	0.8	47.32	48.57	-10.63	-45.82	-35.19
1735 to 12000	-105	0.004	50	47.32	48.57	-6.43	-8.3	-1.87
12000 to 18000	-70	0.004	15	47.32	48.57	-6.43	-52.21	-45.78

BPSK 1643.5 MHz Conducted Spurious Emissions

Freq (MHz)	Limit (dBc)	RBW (MHz)	Modified A Type DLNA Rejection (dB)	Measured Power (dBm)	Corrected Power (dBm)	Necessary Level (dBm)	Measured Level (dBm)	Margin (dB)
.010 to 1525	-135	0.004	80	47.63	48.88	-6.12	-43.7	-37.58
1525 to 1559	-203	0.004	120	47.63	48.88	-34.12	-52.2	-18.08
1559 to 1585	-155	1	100	47.73	47.73	-7.27	-24.62	-17.35
1585 to 1605	-143	1	88	47.73	47.73	-7.27	-23.91	-16.64
1605 to 1610	-117	1	62	47.73	47.73	-7.27	-22.38	-15.11
1610 to 1610.6	-95	1	40	47.73	47.73	-7.27	-21.34	-14.07
1610.6 to 1613.8	-49	1	40	47.73	47.73	38.73	-20.98	-59.71
1613.8 to 1614	-95	1	40	47.73	47.73	-7.27	-20.29	-13.02
1614 to 1620	-70	0.004	2.3	47.63	48.88	-18.82	-38.98	-20.16
1620 to 1626.5	-70	0.004	2.3	47.63	48.88	-18.82	-36.06	-17.24
1626.5 to 1660	-70	0.004	0.8	47.63	48.88	-20.32	-26.91	-6.59
1660 to 1670	-19.5	0.02	0.8	45.97	44.21	25.51	-33.26	-58.77
1670 to 1735	-60	0.004	0.8	47.63	48.88	-10.32	-42.42	-32.10
1735 to 12000	-105	0.004	50	47.63	48.88	-6.12	-12.25	-6.13
12000 to 18000	-70	0.004	15	47.63	48.88	-6.12	-49.67	-43.55

BPSK 1660.5 MHz Conducted Spurious Emissions

Freq (MHz)	Limit (dBc)	RBW (MHz)	Modified A Type DLNA Rejection (dB)	Measured Power (dBm)	Corrected Power (dBm)	Necessary Level (dBm)	Measured Level (dBm)	Margin (dB)
.010 to 1525	-135	0.004	80	47.02	48.27	-6.73	-45.23	-38.50
1525 to 1559	-203	0.004	120	47.02	48.27	-34.73	-53.74	-19.01
1559 to 1585	-155	1	100	47.73	47.73	-7.27	-24.86	-17.59
1585 to 1605	-143	1	88	47.73	47.73	-7.27	-23.53	-16.26
1605 to 1610	-117	1	62	47.73	47.73	-7.27	-21.83	-14.56
1610 to 1610.6	-95	1	40	47.73	47.73	-7.27	-21.73	-14.46
1610.6 to 1613.8	-49	1	40	47.73	47.73	38.73	-21.18	-59.91
1613.8 to 1614	-95	1	40	47.73	47.73	-7.27	-20.64	-13.37
1614 to 1620	-70	0.004	2.3	47.02	48.27	-19.43	-38.2	-18.77
1620 to 1626.5	-70	0.004	2.3	47.02	48.27	-19.43	-36.05	-16.62
1626.5 to 1660	-70	0.004	0.8	47.02	48.27	-20.93	-27.51	-6.58
1660 to 1670	-19.5	0.02	0.8	45.36	43.60	24.90	-31.14	-56.04
1670 to 1735	-60	0.004	0.8	47.02	48.27	-10.93	-38.52	-27.59
1735 to 12000	-105	0.004	50	47.02	48.27	-6.73	-14.77	-8.04
12000 to 18000	-70	0.004	15	47.02	48.27	-6.73	-50.27	-43.54

QPSK 1626.5 MHz Conducted Spurious Emissions

Freq (MHz)	Limit (dBc)	RBW (MHz)	Modified A Type DLNA Rejection (dB)	Measured Power (dBm)	Corrected Power (dBm)	Necessary Level (dBm)	Measured Level (dBm)	Margin (dB)
.010 to 1525	-135	0.004	80	47.69	48.94	-6.06	-40.42	-34.36
1525 to 1559	-203	0.004	120	47.69	48.94	-34.06	-52.19	-18.13
1559 to 1585	-155	1	100	47.73	47.73	-7.27	-24.61	-17.34
1585 to 1605	-143	1	88	47.73	47.73	-7.27	-23.89	-16.62
1605 to 1610	-117	1	62	47.73	47.73	-7.27	-21.73	-14.46
1610 to 1610.6	-95	1	40	47.73	47.73	37.28	-20.80	-58.08
1610.6 to 1613.8	-49	1	40	47.73	47.73	38.73	-19.62	-58.35
1613.8 to 1614	-95	1	40	47.73	47.73	-7.27	-18.99	-11.72
1614 to 1620	-70	0.004	2.3	47.69	48.94	-18.76	-26.22	-7.46
1620 to 1626.5	-70	0.004	2.3	47.69	48.94	-18.76	-28.76	-10.00
1626.5 to 1660	-70	0.004	0.8	47.69	48.94	-20.26	-28.01	-7.75
1660 to 1670	-19.5	0.02	0.8	47.48	45.72	27.02	-34.17	-61.19
1670 to 1735	-60	0.004	0.8	47.69	48.94	-10.26	-45.39	-35.13
1735 to 12000	-105	0.004	50	47.69	48.94	-6.06	-14.79	-8.73
12000 to 18000	-70	0.004	15	47.69	48.94	-6.06	-48.29	-42.23

QPSK 1643.5 MHz Conducted Spurious Emissions

Freq (MHz)	Limit (dBc)	RBW (MHz)	Modified A Type DLNA Rejection (dB)	Measured Power (dBm)	Corrected Power (dBm)	Necessary Level (dBm)	Measured Level (dBm)	Margin (dB)
.010 to 1525	-135	0.004	80	47.56	48.81	-6.19	-41.19	-35.00
1525 to 1559	-203	0.004	120	47.56	48.81	-34.19	-52.73	-18.54
1559 to 1585	-155	1	100	47.73	47.73	-7.27	-25.48	-18.21
1585 to 1605	-143	1	88	47.73	47.73	-7.27	-23.30	-16.03
1605 to 1610	-117	1	62	47.73	47.73	-7.27	-21.56	-14.29
1610 to 1610.6	-95	1	40	47.73	47.73	-7.27	-21.84	-14.57
1610.6 to 1613.8	-49	1	40	47.73	47.73	38.73	-20.58	-59.31
1613.8 to 1614	-95	1	40	47.73	47.73	-7.27	-20.32	-13.05
1614 to 1620	-70	0.004	2.3	47.56	48.81	-18.89	-41.74	-22.85
1620 to 1626.5	-70	0.004	2.3	47.56	48.81	-18.89	-35.70	-16.81
1626.5 to 1660	-70	0.004	0.8	47.56	48.81	-20.39	-25.45	-5.06
1660 to 1670	-19.5	0.02	0.8	47.67	45.91	27.21	-33.76	-60.97
1670 to 1735	-60	0.004	0.8	47.56	48.81	-10.39	-45.60	-35.21
1735 to 12000	-105	0.004	50	47.56	48.81	-6.19	-13.50	-7.31
12000 to 18000	-70	0.004	15	47.56	48.81	-6.19	-50.57	-44.38

QPSK 1660.5 MHz Conducted Spurious Emissions

Freq (MHz)	Limit (dBc)	RBW (MHz)	Modified A Type DLNA Rejection (dB)	Measured Power (dBm)	Corrected Power (dBm)	Necessary Level (dBm)	Measured Level (dBm)	Margin (dB)
.010 to 1525	-135	0.004	80	47.37	48.62	-6.38	-45.19	-38.81
1525 to 1559	-203	0.004	120	47.37	48.62	-34.38	-52.99	-18.61
1559 to 1585	-155	1	100	47.73	47.73	-7.27	-25.01	-17.74
1585 to 1605	-143	1	88	47.73	47.73	-7.27	-22.90	-15.63
1605 to 1610	-117	1	62	47.73	47.73	-7.27	-21.75	-14.48
1610 to 1610.6	-95	1	40	47.73	47.73	-7.27	-21.49	-14.22
1610.6 to 1613.8	-49	1	40	47.73	47.73	38.73	-21.17	-59.90
1613.8 to 1614	-95	1	40	47.73	47.73	-7.27	-19.11	-11.84
1614 to 1620	-70	0.004	2.3	47.37	48.62	-19.08	-39.79	-20.71
1620 to 1626.5	-70	0.004	2.3	47.37	48.62	-19.08	-34.13	-15.05
1626.5 to 1660	-70	0.004	0.8	47.37	48.62	-20.58	-26.60	-6.02
1660 to 1670	-19.5	0.02	0.8	47.34	45.58	26.88	-20.36	-47.24
1670 to 1735	-60	0.004	0.8	47.37	48.62	-10.58	-34.31	-23.73
1735 to 12000	-105	0.004	50	47.37	48.62	-6.38	-15.43	-9.05
12000 to 18000	-70	0.004	15	47.37	48.62	-6.38	-50.58	-44.20

QAM 1626.5 MHz Conducted Spurious Emissions

Freq (MHz)	Limit (dBc)	RBW (MHz)	Modified A Type DLNA Rejection (dB)	Measured Power (dBm)	Corrected Power (dBm)	Necessary Level (dBm)	Measured Level (dBm)	Margin (dB)
.010 to 1525	-135	0.004	80	40.87	42.12	-12.88	-51.86	-38.98
1525 to 1559	-203	0.004	120	40.87	42.12	-40.88	-51.85	-10.97
1559 to 1585	-155	1	100	47.73	47.73	-7.27	-35.34	-28.07
1585 to 1605	-143	1	88	47.73	47.73	-7.27	-22.06	-14.79
1605 to 1610	-117	1	62	47.73	47.73	-7.27	-22.28	-15.01
1610 to 1610.6	-95	1	40	47.73	47.73	37.28	-22.01	-59.29
1610.6 to 1613.8	-49	1	40	47.73	47.73	38.73	-20.67	-59.40
1613.8 to 1614	-95	1	40	47.73	47.73	-7.27	-19.46	-12.19
1614 to 1620	-70	0.004	2.3	40.87	42.12	-25.58	-35.92	-10.34
1620 to 1626.5	-70	0.004	2.3	40.87	42.12	-25.58	-33.71	-8.13
1626.5 to 1660	-70	0.004	0.8	40.87	42.12	-27.08	-31.80	-4.72
1660 to 1670	-19.5	0.02	0.8	46.81	45.05	26.35	-36.99	-63.34
1670 to 1735	-60	0.004	0.8	40.87	42.12	-17.08	-47.53	-30.45
1735 to 12000	-105	0.004	50	40.87	42.12	-12.88	-23.25	-10.37
12000 to 18000	-70	0.004	15	40.87	42.12	-12.88	-49.42	-36.54

**QAM 1643.5 MHz Conducted Spurious Emissions**

Freq (MHz)	Limit (dBc)	RBW (MHz)	Modified A Type DLNA Rejection (dB)	Measured Power (dBm)	Corrected Power (dBm)	Necessary Level (dBm)	Measured Level (dBm)	Margin (dB)
.010 to 1525	-135	0.004	80	41.46	42.71	-12.29	-50.06	-37.77
1525 to 1559	-203	0.004	120	41.46	42.71	-40.29	-52.33	-12.04
1559 to 1585	-155	1	100	47.73	47.73	-7.27	-25.19	-17.92
1585 to 1605	-143	1	88	47.73	47.73	-7.27	-24.79	-17.52
1605 to 1610	-117	1	62	47.73	47.73	-7.27	-21.29	-14.02
1610 to 1610.6	-95	1	40	47.73	47.73	-7.27	-21.72	-14.45
1610.6 to 1613.8	-49	1	40	47.73	47.73	38.73	-21.55	-60.28
1613.8 to 1614	-95	1	40	47.73	47.73	-7.27	-21.02	-13.75
1614 to 1620	-70	0.004	2.3	41.46	42.71	-24.99	-45.19	-20.20
1620 to 1626.5	-70	0.004	2.3	41.46	42.71	-24.99	-40.66	-15.67
1626.5 to 1660	-70	0.004	0.8	41.46	42.71	-26.49	-30.79	-4.30
1660 to 1670	-19.5	0.02	0.8	46.65	44.89	26.19	-34.71	-60.90
1670 to 1735	-60	0.004	0.8	41.46	42.71	-16.49	-44.43	-27.94
1735 to 12000	-105	0.004	50	41.46	42.71	-12.29	-26.23	-13.94
12000 to 18000	-70	0.004	15	41.46	42.71	-12.29	-50.33	-38.04

QAM 1660.5 MHz Conducted Spurious Emissions

Freq (MHz)	Limit (dBc)	RBW (MHz)	Modified A Type DLNA Rejection (dB)	Measured Power (dBm)	Corrected Power (dBm)	Necessary Level (dBm)	Measured Level (dBm)	Margin (dB)
.010 to 1525	-135	0.004	80	41.36	42.61	-12.39	-53.51	-41.12
1525 to 1559	-203	0.004	120	41.36	42.61	-40.39	-53.42	-13.03
1559 to 1585	-155	1	100	47.73	47.73	-7.27	-26.20	-18.93
1585 to 1605	-143	1	88	47.73	47.73	-7.27	-24.63	-17.36
1605 to 1610	-117	1	62	47.73	47.73	-7.27	-22.96	-15.69
1610 to 1610.6	-95	1	40	47.73	47.73	-7.27	-22.71	-15.44
1610.6 to 1613.8	-49	1	40	47.73	47.73	38.73	-21.15	-59.88
1613.8 to 1614	-95	1	40	47.73	47.73	-7.27	-21.72	-14.45
1614 to 1620	-70	0.004	2.3	41.36	42.61	-25.09	-42.81	-17.72
1620 to 1626.5	-70	0.004	2.3	41.36	42.61	-25.09	-39.29	-14.20
1626.5 to 1660	-70	0.004	0.8	41.36	42.61	-26.59	-29.78	-3.19
1660 to 1670	-19.5	0.02	0.8	46.98	45.22	26.52	-24.33	-50.85
1670 to 1735	-60	0.004	0.8	41.36	42.61	-16.59	-42.03	-25.44
1735 to 12000	-105	0.004	50	41.36	42.61	-12.39	-27.26	-14.87
12000 to 18000	-70	0.004	15	41.36	42.61	-12.39	-51.57	-39.18



Name of Test: Field Strength of Spurious Radiation
Specification: 2.1053,
Test Equipment Utilized: 0668, 04806, i00103, i00331

Engineer: J. Erhard
Test Date: 3/25/2010

Test Procedure

- A) Connect the equipment as illustrated
- B) Adjust the spectrum analyzer for the following settings:
 - 1) Resolution Bandwidth 100 kHz (<1 GHz), 1 MHz (> 1GHz).
 - 2) Video Bandwidth ≥ 3 times Resolution Bandwidth, or 30 kHz
 - 3) Sweep Speed ≤ 2000 Hz/second
 - 4) Detector Mode = Mean or Average Power
- C) Place the transmitter to be tested on the turntable in the standard test site. The transmitter is transmitting into a non-radiating load that is placed on the turntable. The RF cable to this load should be of minimum length.
- D) For each spurious measurement the test antenna should be adjusted to the correct length for the frequency involved. This length may be determined from a calibration ruler supplied with the equipment. Measurements shall be made from the lowest radio frequency generated in the equipment to the tenth harmonic of the carrier, except for the region close to the carrier equal to \pm the test bandwidth (see section 1.3.4.4).
- E) For each spurious frequency, raise and lower the test antenna from 1 m to 4 m to obtain a maximum reading on the spectrum analyzer with the test antenna at horizontal polarity. Repeat this procedure to obtain the highest possible reading. Record this maximum reading.
- F) Repeat step E) for each spurious frequency with the test antenna polarized vertically.
- G) Reconnect the equipment as illustrated.
- H) Keep the spectrum analyzer adjusted as in step B).
- I) Remove the transmitter and replace it with a substitution antenna (the antenna should be half-wavelength for each frequency involved). The center of the substitution antenna should be approximately at the same location as the center of the transmitter. At lower frequencies, where the substitution antenna is very long, this will be impossible to achieve when the antenna is polarized vertically. In such case the lower end of the antenna should be 0.3 m above the ground.
- J) Feed the substitution antenna at the transmitter end with a signal generator connected to the antenna by means of a non-radiating cable. With the antennas at both ends horizontally polarized and with the signal generator tuned to a particular spurious frequency, raise and lower the test antenna to obtain a maximum reading at the spectrum analyzer. Adjust the level of the signal generator output until the previously recorded maximum reading for this set of conditions is obtained. This should be done carefully repeating the adjustment of the test antenna and generator output.
- K) Repeat step J) with both antennas vertically polarized for each spurious frequency.
- L) Calculate power in dBm into a reference ideal half-wave dipole antenna by reducing the readings obtained in steps J) and K) by the power loss in the cable between the generator and the antenna and further corrected for the gain of the substitution antenna used relative to an ideal half-wave dipole antenna.
- M) The levels recorded in step L) are absolute levels of radiated spurious emissions in dBm. The radiated spurious emissions in dB can be calculated by the following:

Radiated spurious emissions dB = $10\log_{10}(\text{TX power in watts}/0.001)$ – the levels in step I)

NOTE: It is permissible that other antennas provided can be referenced to a dipole.

Test Setup

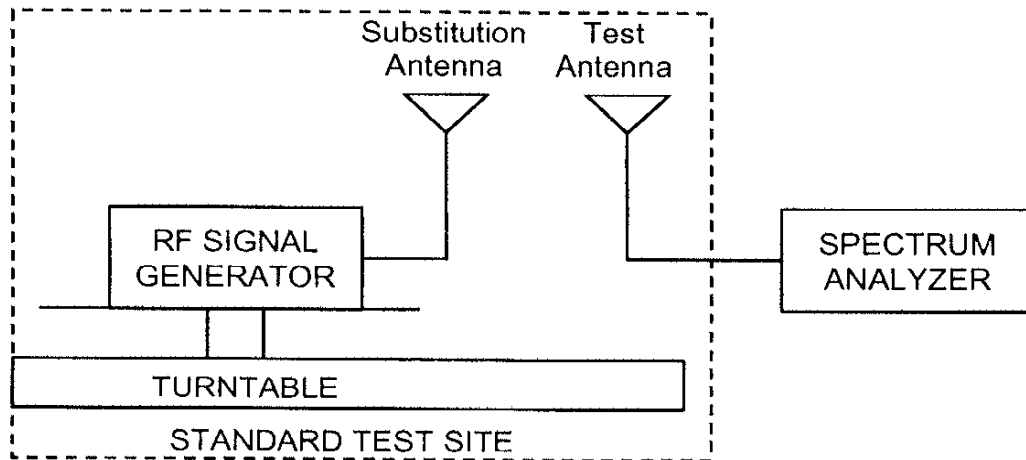
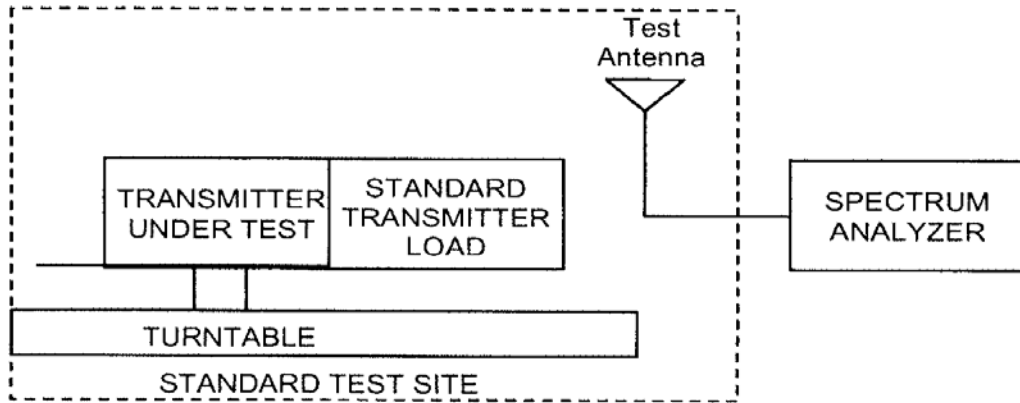

**BPSK 1626.5 MHz Radiated Spurious Emissions**

Emission Frequency (MHz)	Measured Level (dBm)	Limit (dBm)	Result
3253.0	-53.93	-13	Pass
4879.5	-53.69	-13	Pass
6506.0	-51.63	-13	Pass

BPSK 1643.5 MHz Radiated Spurious Emissions

Emission Frequency (MHz)	Measured Level (dBm)	Limit (dBm)	Result
3287.0	-54.68	-13	Pass
4930.5	-53.67	-13	Pass
6574.0	-51.12	-13	Pass

BPSK 1660.5 MHz Radiated Spurious Emissions

Emission Frequency (MHz)	Measured Level (dBm)	Limit (dBm)	Result
3321.0	-54.36	-13	Pass
4981.5	-53.19	-13	Pass
6642.0	-51.21	-13	Pass

QPSK 1626.5 MHz Radiated Spurious Emissions

Emission Frequency (MHz)	Measured Level (dBm)	Limit (dBm)	Result
3253.0	-53.94	-13	Pass
4879.5	-53.19	-13	Pass
6506.0	-50.19	-13	Pass

QPSK 1643.5 MHz Radiated Spurious Emissions

Emission Frequency (MHz)	Measured Level (dBm)	Limit (dBm)	Result
3287.0	-55.02	-13	Pass
4930.5	-52.06	-13	Pass
6574.0	-50.14	-13	Pass

QPSK 1660.5 MHz Radiated Spurious Emissions

Emission Frequency (MHz)	Measured Level (dBm)	Limit (dBm)	Result
3321.0	-54.47	-13	Pass
4981.5	-54.53	-13	Pass
6642.0	-50.46	-13	Pass



QAM 1626.5 MHz Radiated Spurious Emissions

Emission Frequency (MHz)	Measured Level (dBm)	Limit (dBm)	Result
3253.0	-56.91	-13	Pass
4879.5	-52.61	-13	Pass
6506.0	-51.84	-13	Pass

QAM 1643.5 MHz Radiated Spurious Emissions

Emission Frequency (MHz)	Measured Level (dBm)	Limit (dBm)	Result
3287.0	-54.75	-13	Pass
4930.5	-52.90	-13	Pass
6574.0	-49.27	-13	Pass

QAM 1660.5 MHz Radiated Spurious Emissions

Emission Frequency (MHz)	Measured Level (dBm)	Limit (dBm)	Result
3321.0	-55.63	-13	Pass
4981.5	-53.36	-13	Pass
6642.0	-50.55	-13	Pass

No other emissions were detected.

Name of Test: Emission Masks (Occupied Bandwidth)
Specification: 2.1049, 87.139(i)(3)
Test Equipment Utilized: 0668, 04806, i00331

Engineer: J. Erhard
Test Date: 3/23/2010

The EUT was connected directly to a spectrum analyzer to verify that the EUT meets the required emissions mask. A reference level plot is provided to verify that the peak power was established prior to testing the mask. The transmitter is digital modulation therefore no data input is required to measure the emission mask. The RBW was set as close as possible to 1% of the occupied bandwidth to ensure accurate readings.

Test Setup

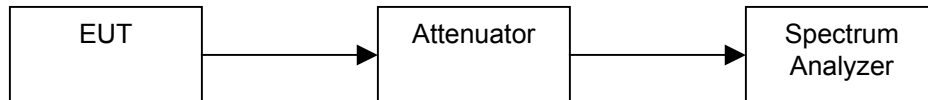

BPSK Emissions Mask

BPSK 1626.5 MHz Reference

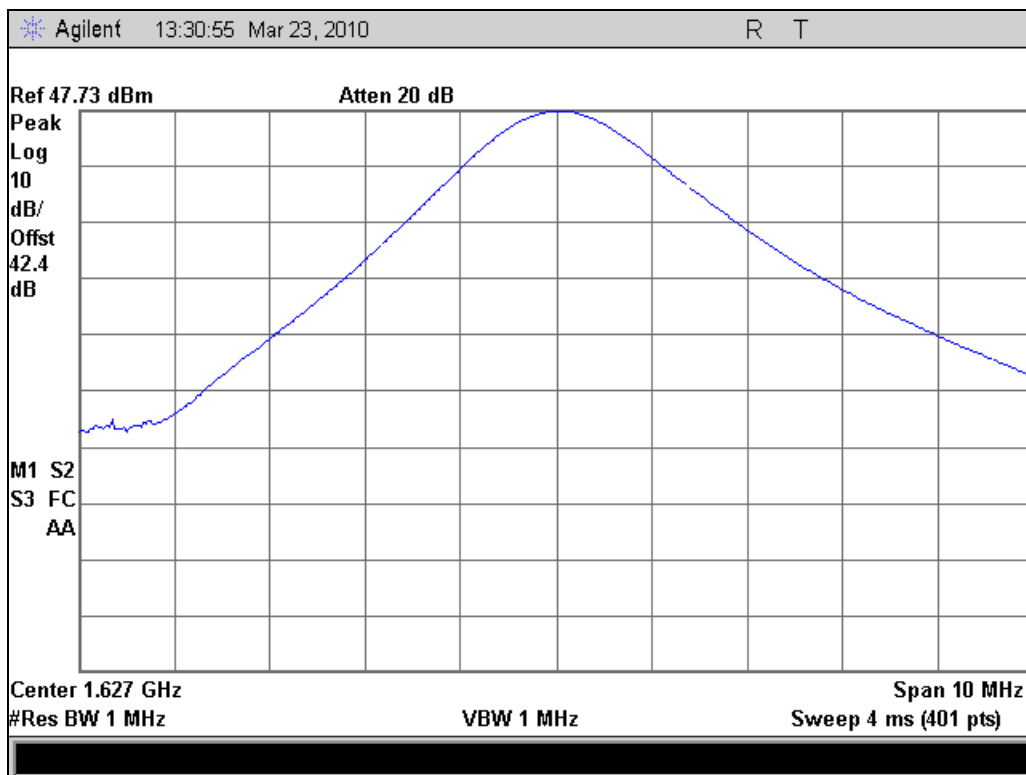



BPSK 1643.5 MHz Reference

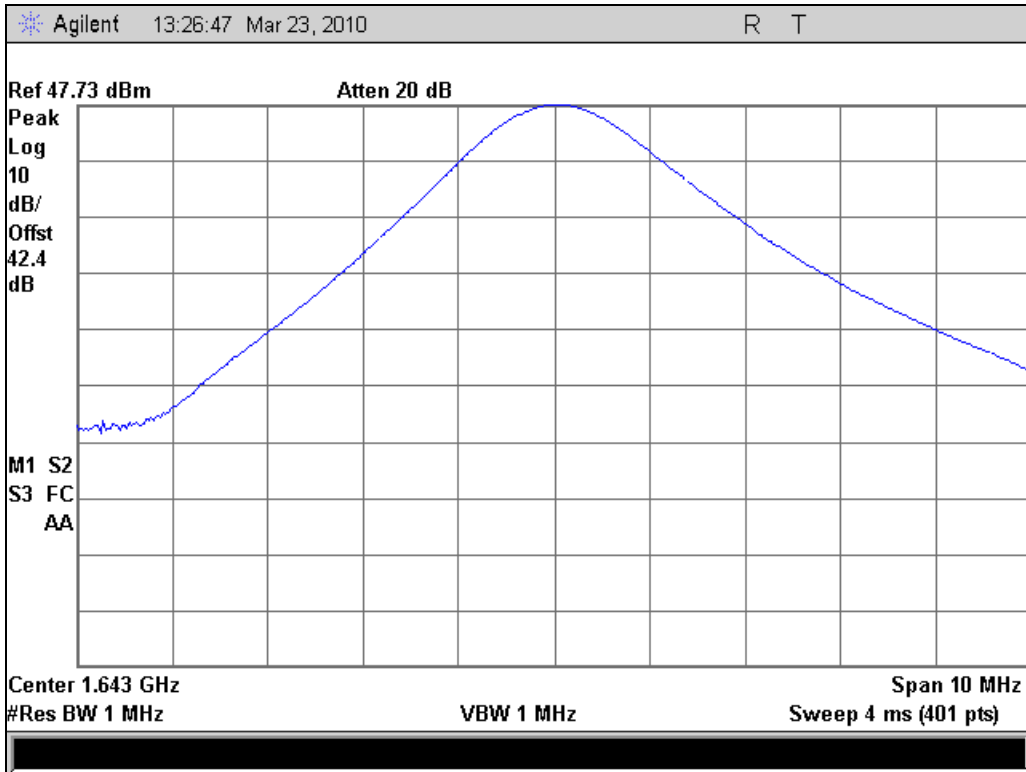

BPSK 1660.5 MHz Reference

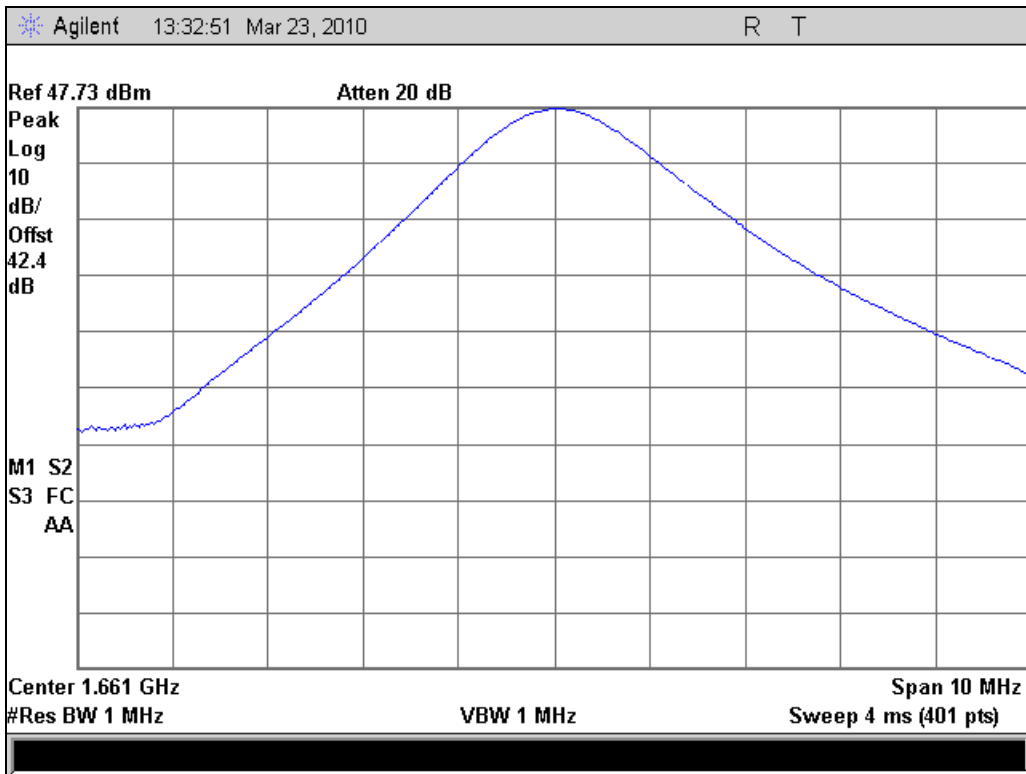

BPSK 1626.5 MHz 21K0G1D

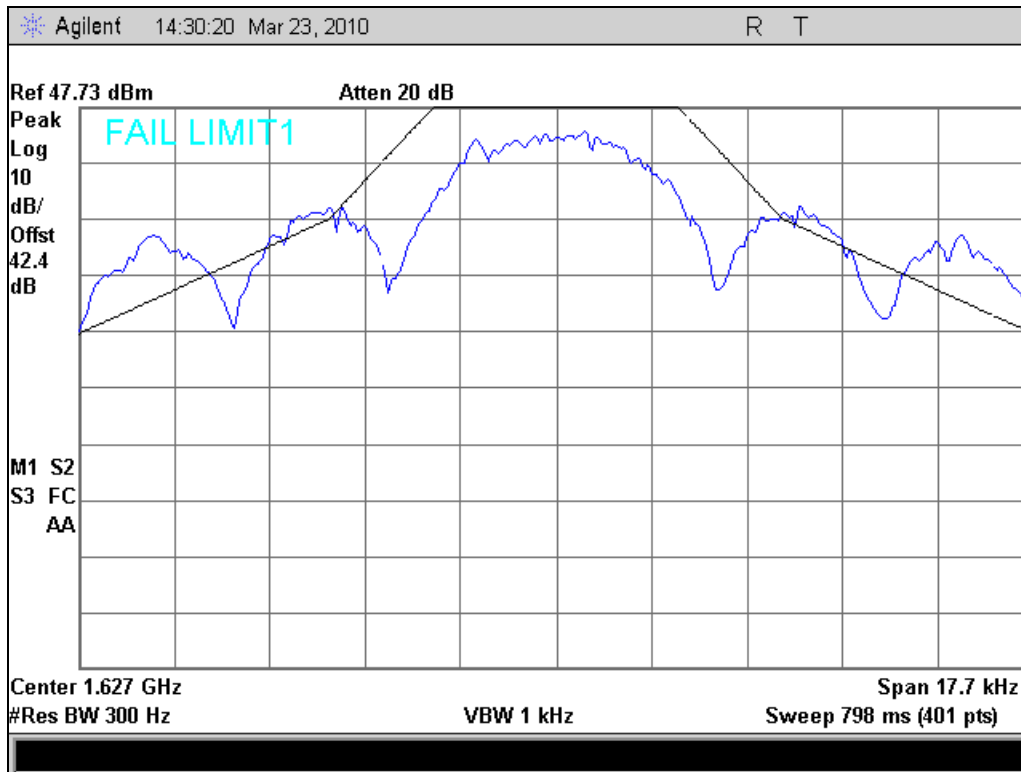

BPSK 1643.5 MHz 21K0G1D

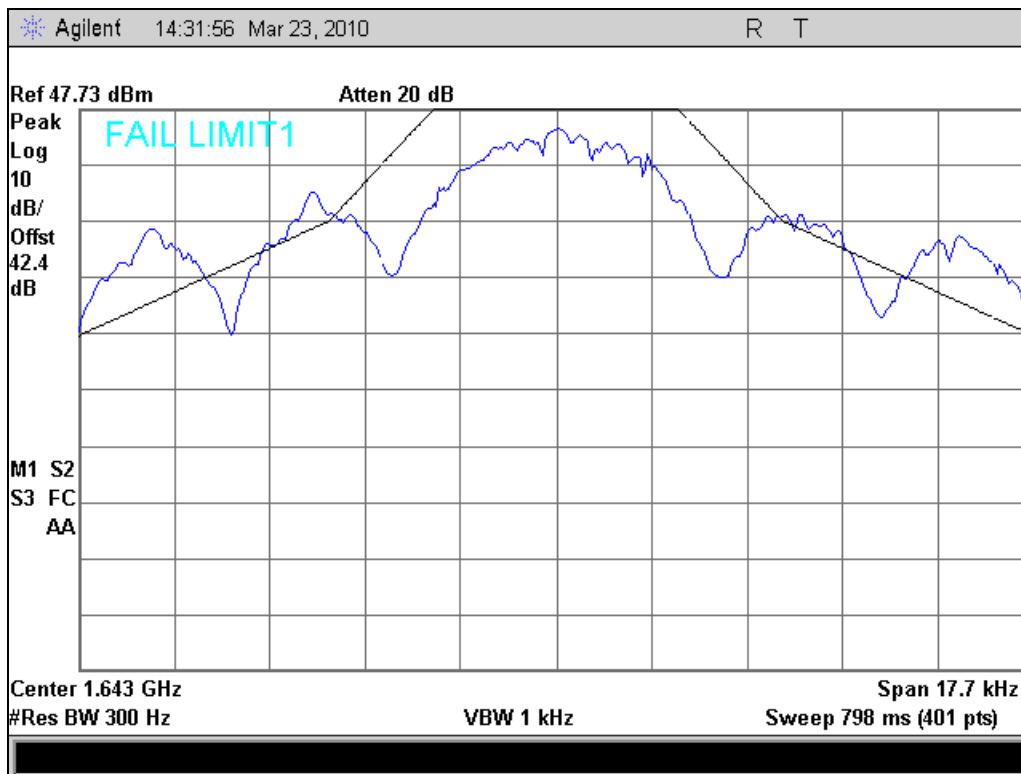

BPSK 1660.5 MHz 21K0G1D

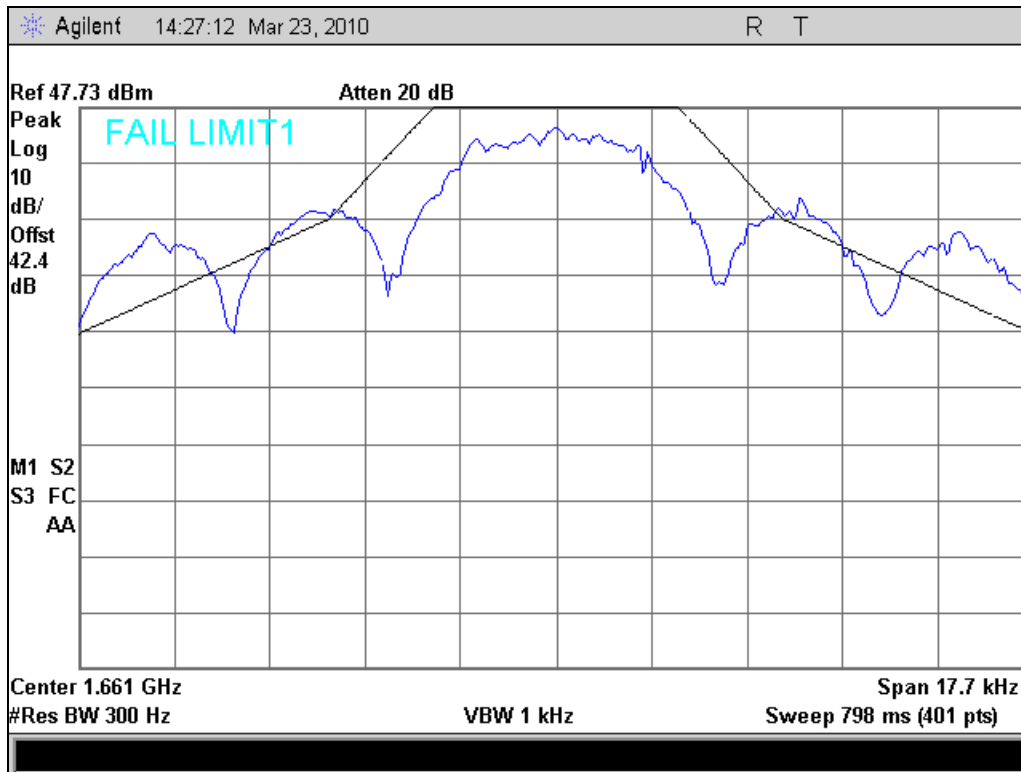

A waiver has been granted for this modulation type and bandwidth.

QPSK Emissions Mask
QPSK 1626.5 MHz Reference

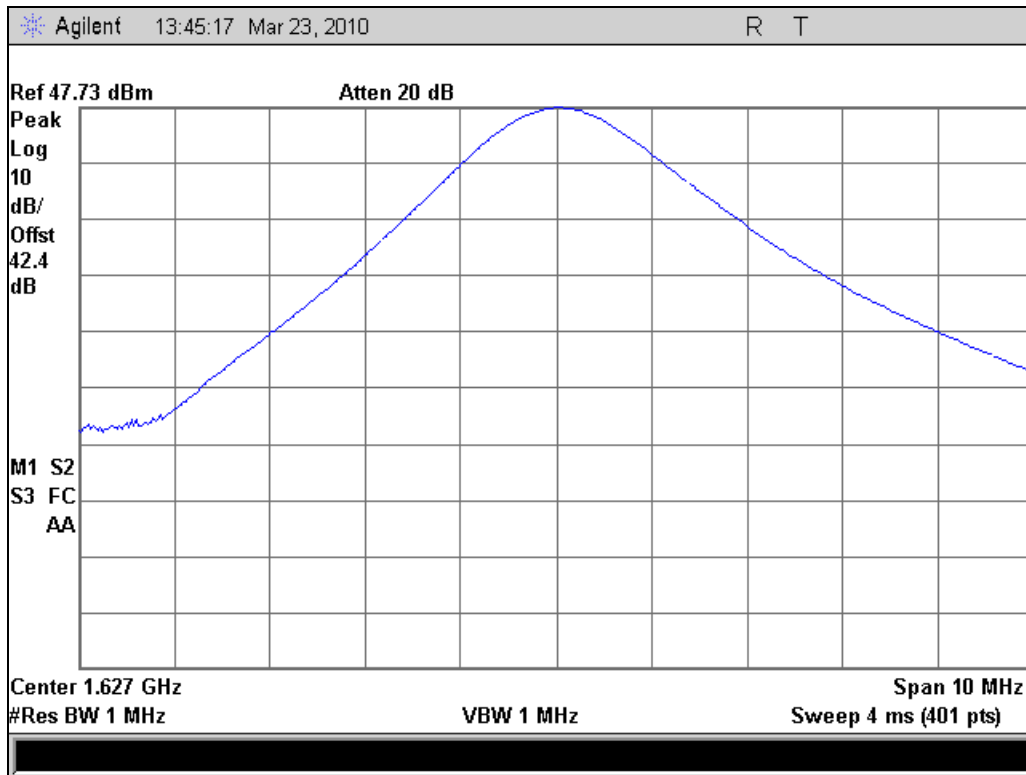

QPSK 1643.5 MHz Reference

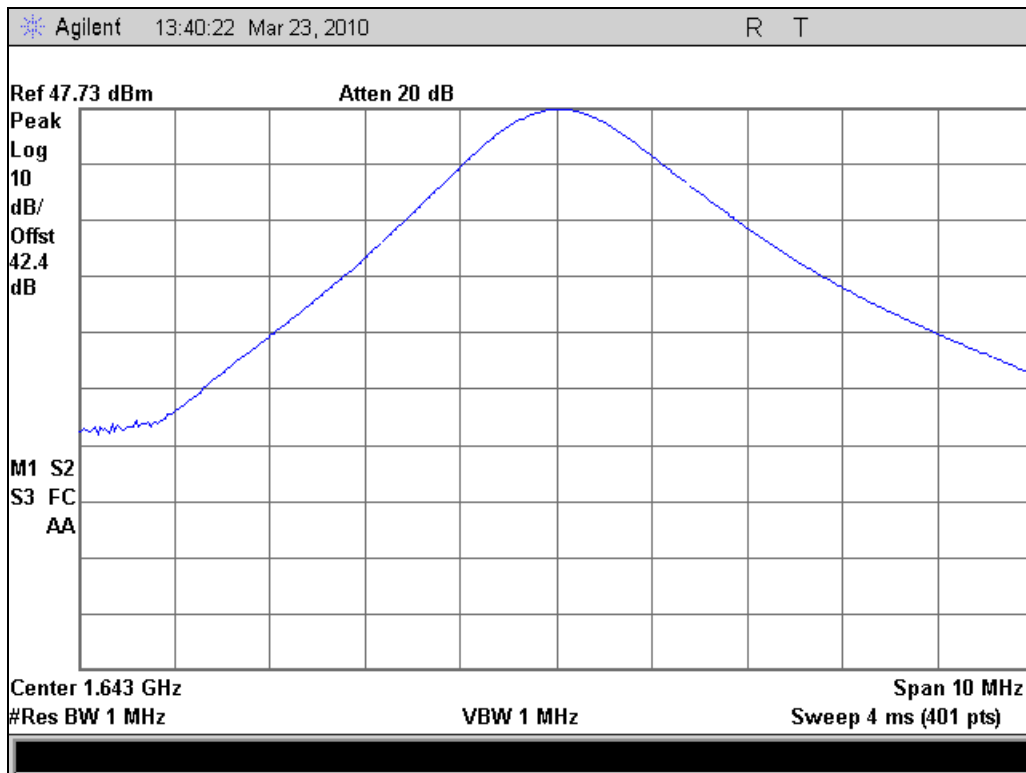

QPSK 1660.5 MHz Reference

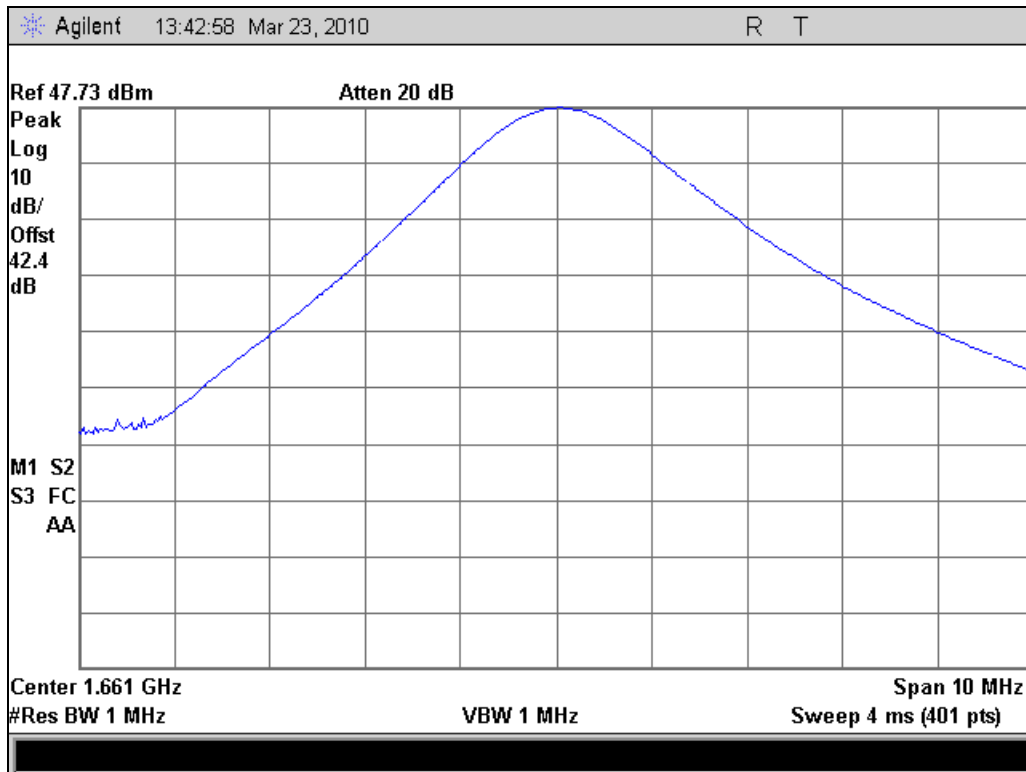

QPSK 1626.5 MHz 7K20G1E

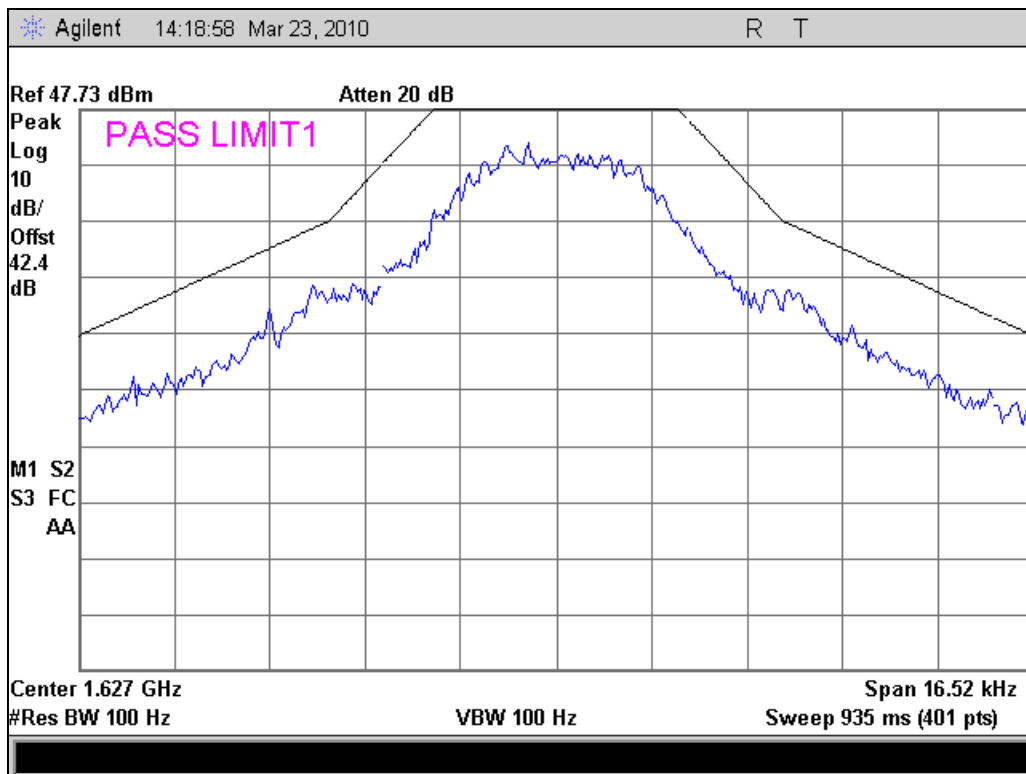



QPSK 1643.5 MHz 7K20G1E

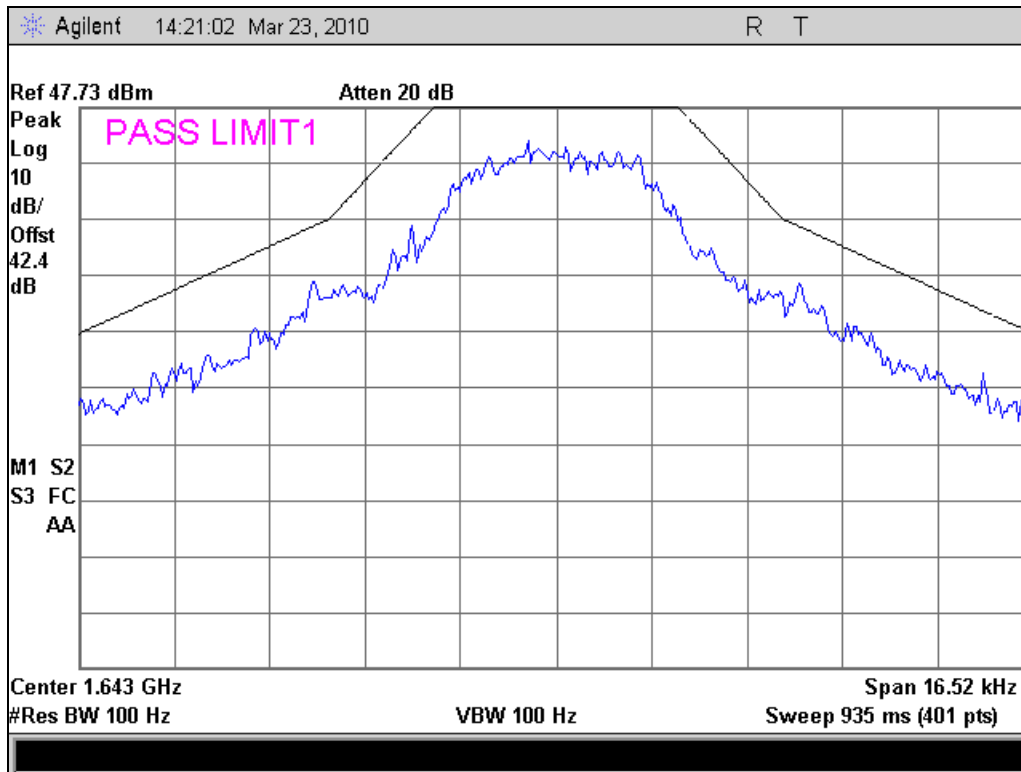

QPSK 1660.5 MHz 7K20G1E

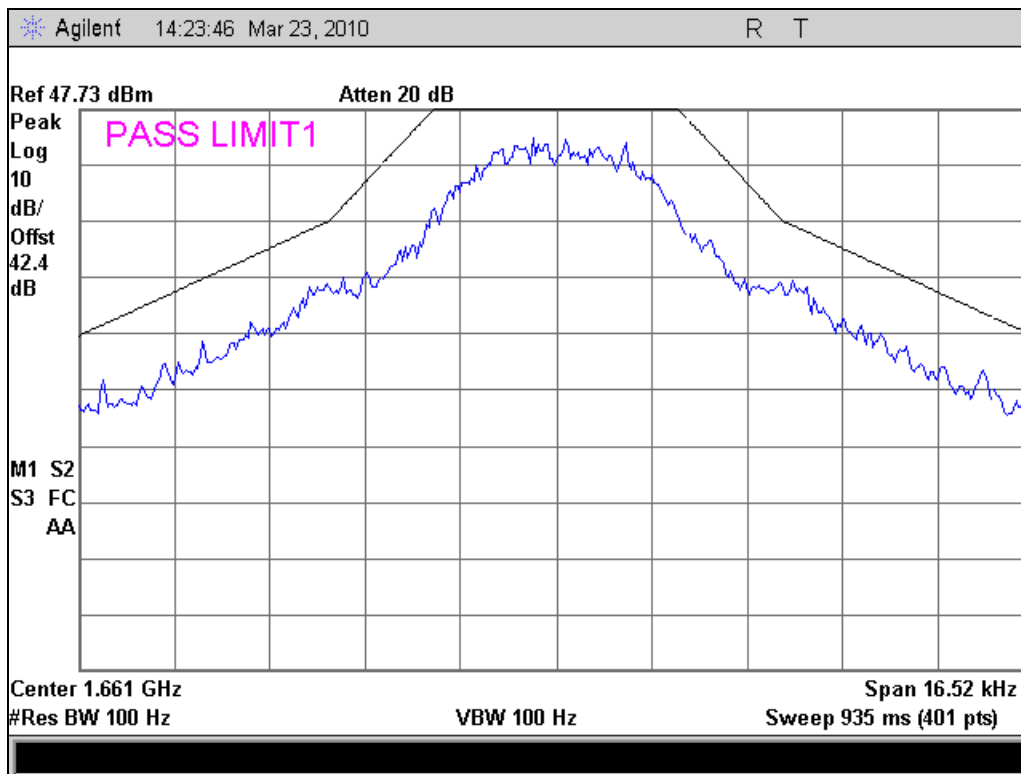



QAM Emissions Mask

QAM 1626.5 MHz Reference

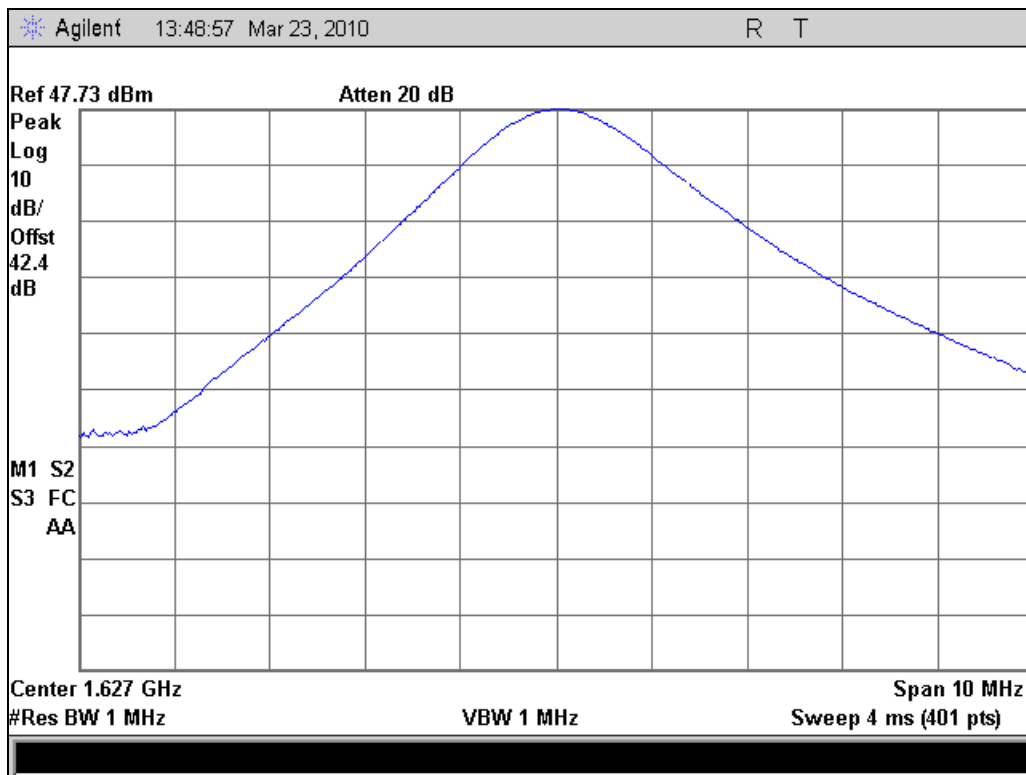

QAM 1643.5 MHz Reference

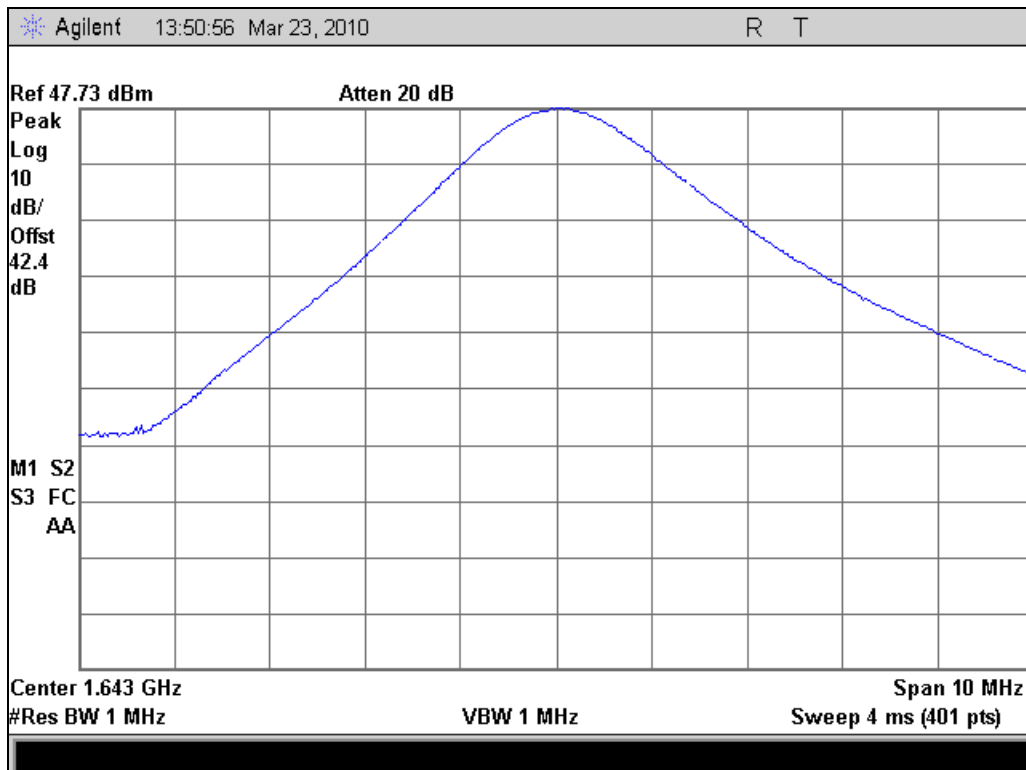



QAM 1660.5 MHz Reference

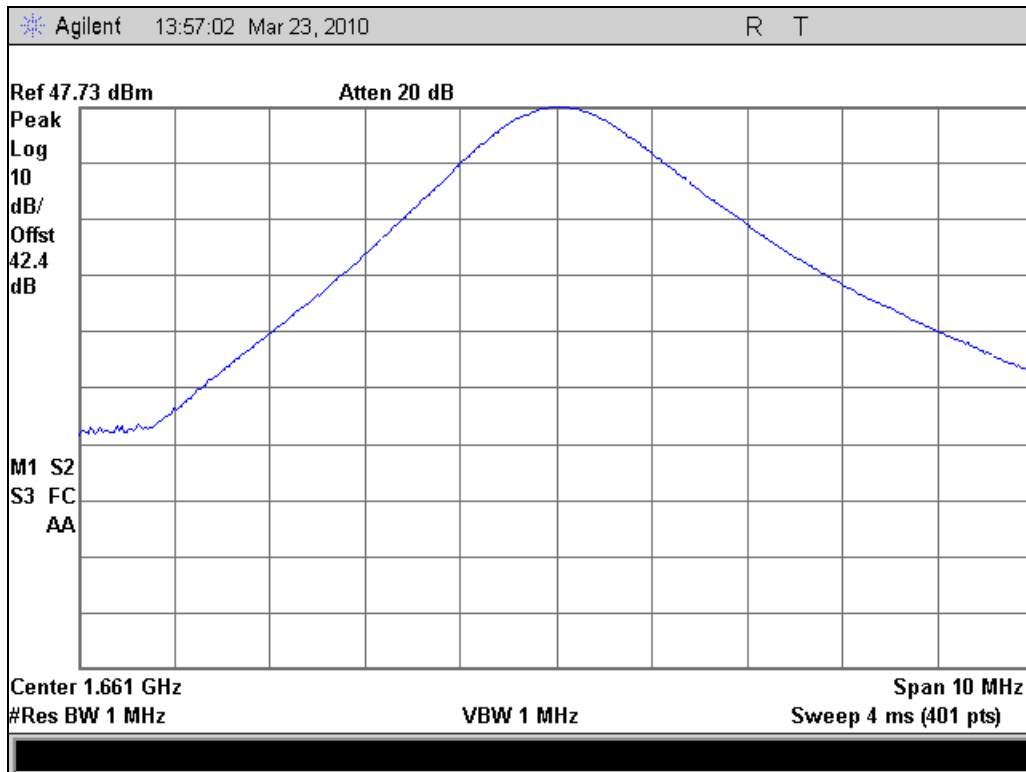

QAM 1626.5 MHz 40K0G1E

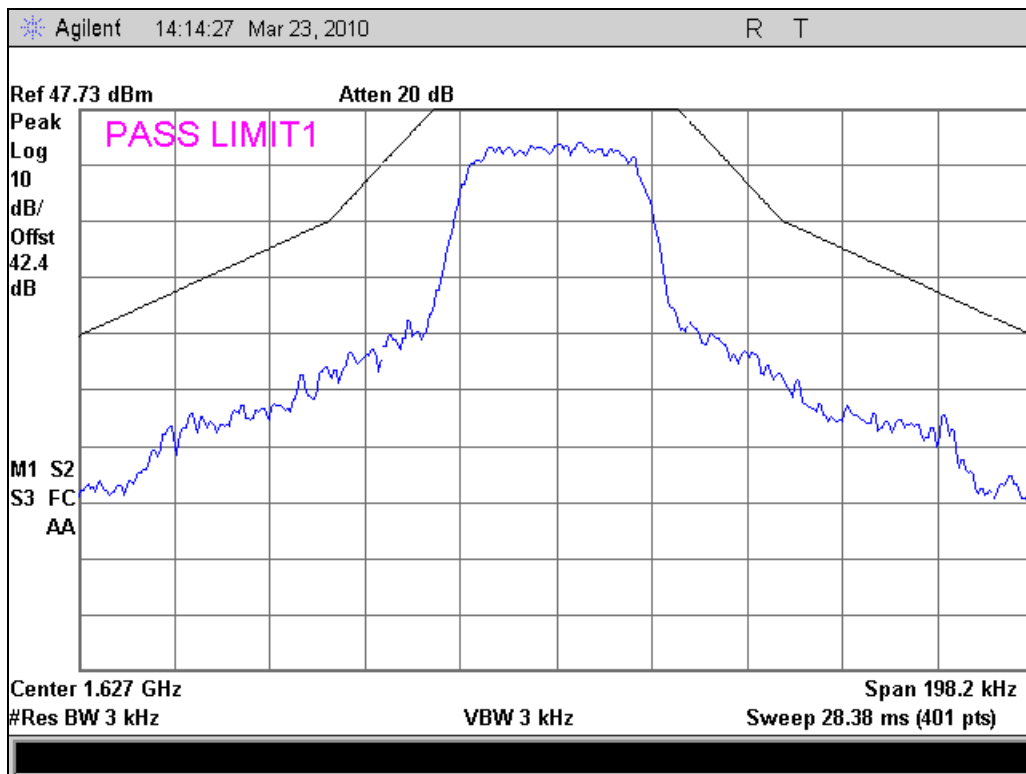

QAM 1643.5 MHz 40K0G1E

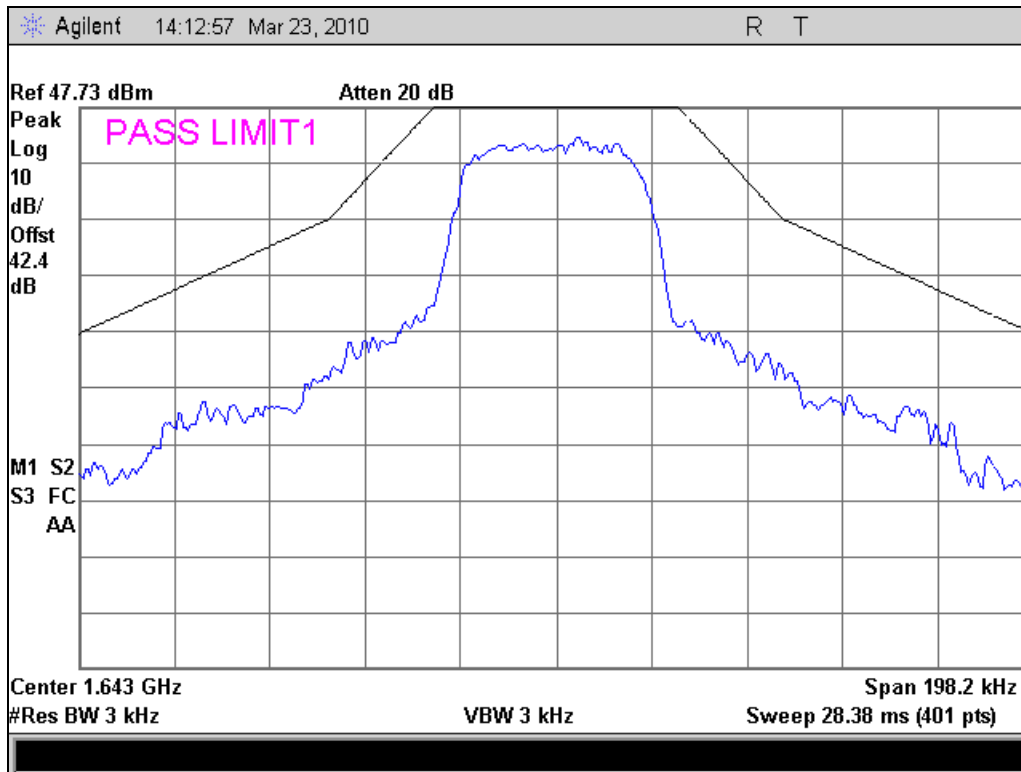

QAM 1660.5 MHz 40K0D1E

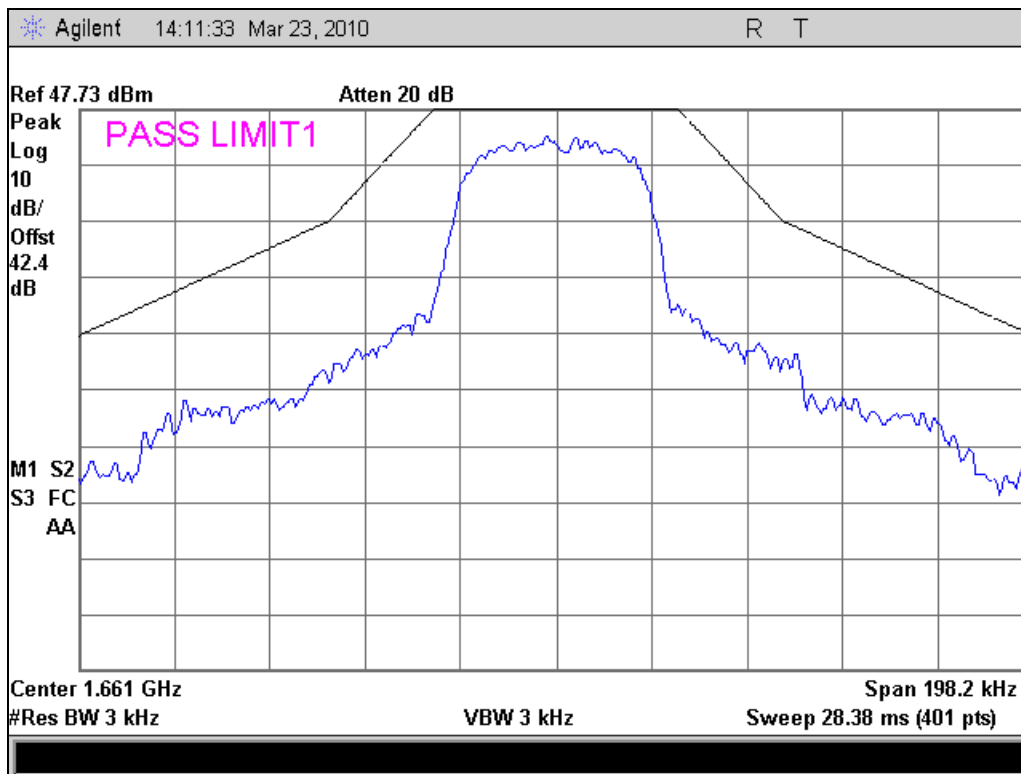

A waiver has been granted for this modulation type.

Name of Test: Frequency Stability (Temperature Variation)
Specification: 87.133(a) **Engineer:** J. Erhard
Test Equipment Utilized: 04010, 05123, i00027, i00029 **Test Date:** 3/22/2010

Measurement Procedure

The EUT was placed in an environmental test chamber and the RF output was connected directly to a frequency counter. The temperature was varied from -30°C to 50°C in 10°C increments. After a sufficient time for temperature stabilization the RF output frequency was measured.

Measurement Setup

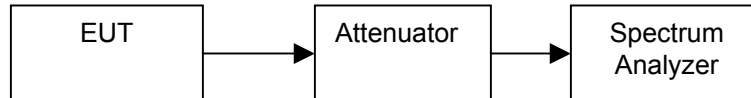

Measurement Results

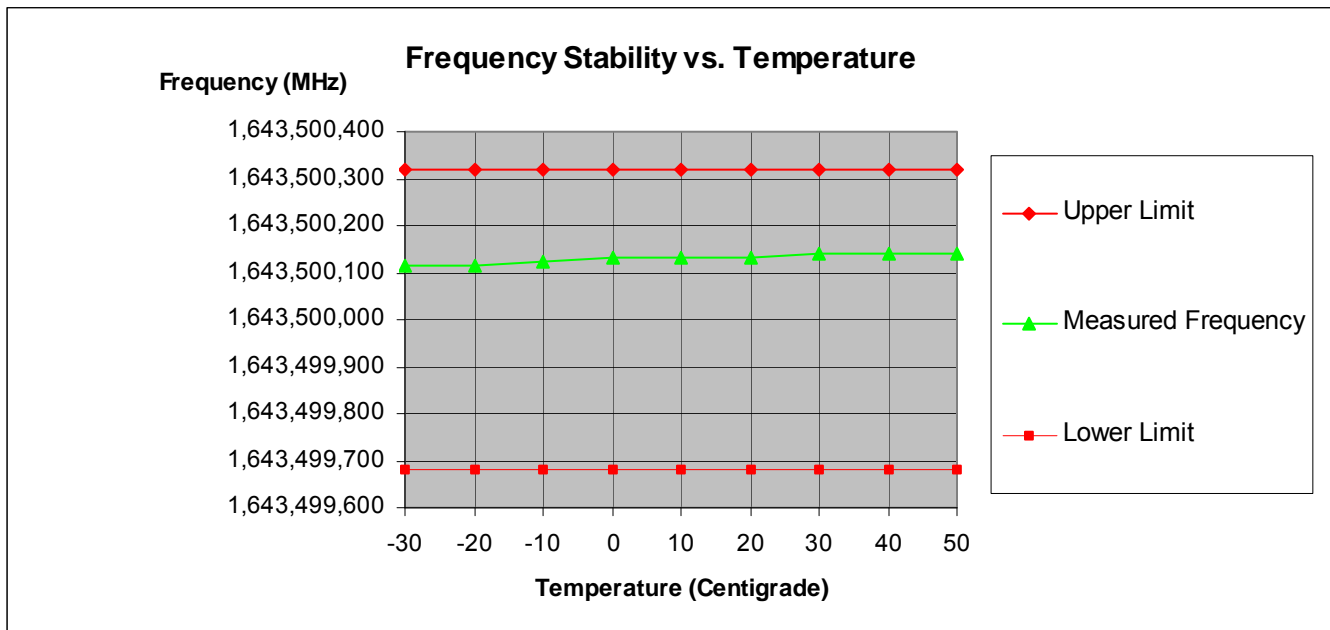



Name of Test: Frequency Stability (Voltage Variation)
Specification: 87.133(a)
Test Equipment Utilized: 04010, 05123, i00027, i00029

Engineer: J. Erhard
Test Date: 3/23/2010

Measurement Procedure

The EUT was placed in a temperature chamber at 20±5°C and connected directly to a spectrum analyzer. The power supply voltage to the EUT was varied from 85% to 115% of the nominal value and the RF output was measured. This was measured with both a 400 Hz 115 VAC supply and a variable DC voltage source.

Measurement Setup

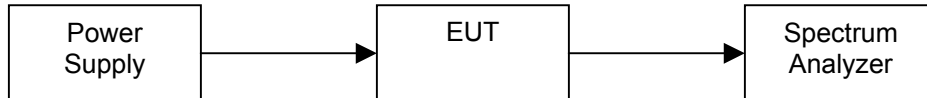

Measurement Results

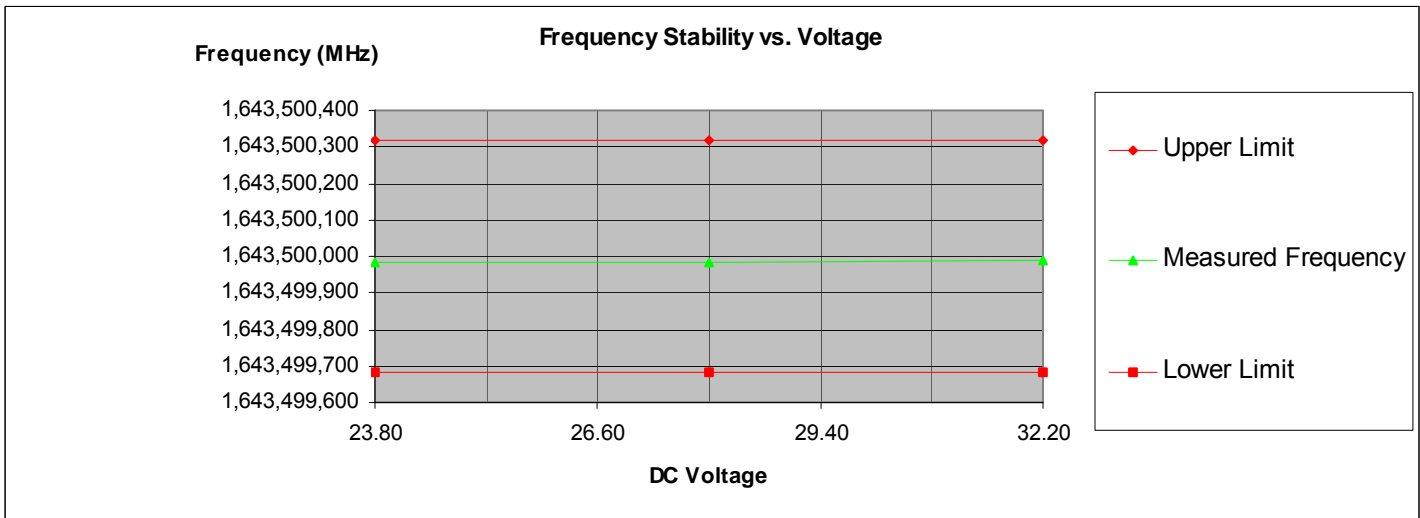
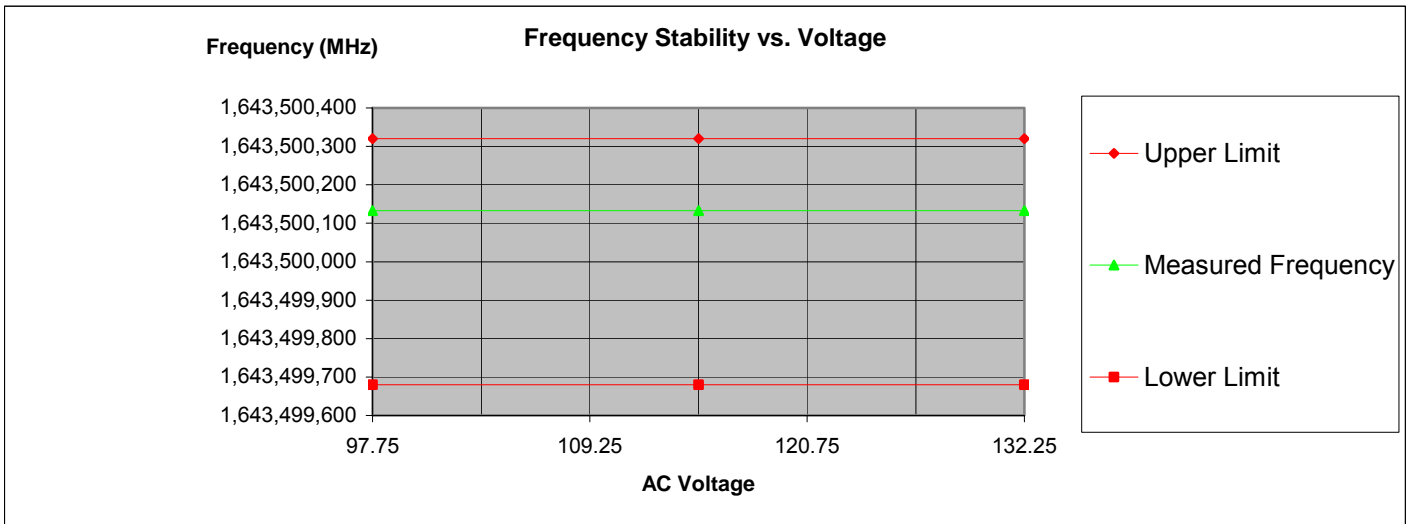



Name of Test: Necessary Bandwidth and Emission Bandwidth
Specification: 2.202(g) Engineer: J. Erhard

BPSK

Modulation = 21K0G1D

Necessary Bandwidth Calculation:

- Signal States (S) = 2
- Data Rate (D) = 3
- Constant Factor (K) = 3.5
- Necessary Bandwidth (B_N), kHz = 2*D*K / LOG₂(S)

QPSK

Modulation = 7K20G1E

Necessary Bandwidth Calculation:

- Signal States (S) = 4
- Data Rate (D) = 5.6
- Constant Factor (K) = 1.29
- Necessary Bandwidth (B_N), kHz = 2*D*K / LOG₂(S)

QAM

Modulation = 40K0G1E

Necessary Bandwidth Calculation:

- Signal States (S) = 16
- Data Rate (D) = 134.4
- Constant Factor (K) = 0.6
- Necessary Bandwidth (B_N), kHz = 2*D*K / LOG₂(S)

Modulation = 40K0G1D

Necessary Bandwidth Calculation:

- Signal States (S) = 16
- Data Rate (D) = 134.4
- Constant Factor (K) = 0.6
- Necessary Bandwidth (B_N), kHz = 2*D*K / LOG₂(S)

Test Equipment Utilized

Compliance Testing

Asset#	Manufacturer	Model	Description	Last Calibration	Calibration Due
i00027	Tenney	Tenney Jr	Temperature Test Chamber	12/8/2009	12/8/2010
i00029	HP	8563E	Spectrum Analyzer	6/8/2009	6/8/2010
i00103	EMCO	3115	Horn Antenna	11/25/2008	11/25/2010
i00331	Agilent	E4407B	Spectrum Analyzer	11/0/2009	11/3/2010

EMS

Asset#	Manufacturer	Model	Description	Last Calibration	Calibration Due
0668	Weinschel	49-30-34	30 dB Power Attenuator	NCR	NCR
04010	Xantrex	XHR 40-25	Variable DC Power Supply	2/26/2010	3/26/2011
04806	California Instruments	801RP	400 Hz AC Supply	3/1/2010	4/1/2011
05123	California Instruments	801RP	400 Hz AC Supply	10/1/2009	11/1/2010

In addition to the above listed equipment standard RF connectors and cables were utilized in the testing of the described equipment. Prior to testing these components were tested to verify proper operation.

Appendix
LNA Specifications
2.2.4.3.2.2 Type F - Transmit Port to Antenna Port

The path from the transmit port to the antenna port should have the following characteristics:

Frequency (MHz)			Rejection
0.0	to	1525.0	>80 dB
1525.0	to	1559.0	> 120 dB
1559.0	to	1585.0	> 111 dB
1585.0	to	1605.0	> 95 dB
1605.0	to	1610.0	> 62 dB
1610.0	to	1614.0	> 40 dB
1614.0	to	1620.0	> 30 dB
1620.0	to	1624.5	> 20 dB
1624.5	to	1625.5	> 10 dB
1625.5	to	1626.5	Decreases
1626.5	to	1633.0	Insertion loss < 1.3 dB
1633.0	to	1660.5	Insertion loss < 0.8 dB
1660.5	to	1735.0	Increases
1735.0	to	1865.0	> 50 dB
1865.0	to	3250.0	> 20 dB
3250.0	to	3330.0	> 50 dB
3330.0	to	4000.0	> 40 dB
4000.0	to	12000.0	> 50 dB
12000.0	to	18000.0	> 15 dB

2.2.4.3.3 Modified Type A Diplexer/LNA - For Protection of GPS and GLONASS
Transmit Port to Antenna Port

The path from the transmit port to the antenna port should have the following characteristics:

Frequency (MHz)	Rejection
0.0 to 1525.0	> 80 dB
1525.0 to 1559.0	> 120 dB
1559.0 to 1585.0	> 100 dB
1585.0 to 1605.0	> 88 dB
1605.0 to 1610.0	> 62 dB
1610.0 to 1614.0	> 40 dB
1614.0 to 1626.5	> Decreases
1626.5 to 1631.5	Insertion loss < 2.3 dB
1631.5 to 1660.5	Insertion loss < 0.8 dB
1660.5 to 1735.0	Increases
1735.0 to 12000.0	> 50 dB
12000.0 to 18000.0	> 15 dB



2.2.4.3.2.1 Type D - Transmit Port to Antenna Port

The path from the transmit port to the antenna port should have the following characteristics:

Frequency (MHz)			Rejection
0.0	to	1525.0	> 80 dB
1525.0	to	1559.0	> 120 dB
1559.0	to	1585.0	> 111 dB
1585.0	to	1605.0	> 95 dB
1605.0	to	1610.0	> 62 dB
1610.0	to	1614.0	> 40 dB
1614.0	to	1620.0	> 20 dB
1620.0	to	1625.5	> 10 dB
1625.5	to	1629.5	Decreases
1629.5	to	1633.0	Insertion loss < 1.3 dB
1633.0	to	1660.5	Insertion loss < 0.8 dB
1660.5	to	1735.0	Increases
1735.0	to	12000.0	> 50 dB
12000.0	to	18000.0	> 15 dB

The above should be met over the DLNAs operating temperature range.

END OF TEST REPORT