



M. Flom Associates, Inc. - Global Compliance Center

3356 North San Marcos Place, Suite 107, Chandler, Arizona 85224-1571

www.goodnet.com/~mflom, (602) 926-3100, FAX: 926-3598

Sub-part
2.983 (f):

EQUIPMENT IDENTIFICATION

FCC ID: K66VXR-1000V

NAMEPLATE DRAWING

ATTACHED, EXHIBIT 1.

LOCATION

AS PER LABEL DRAWING(S)

DATE OF REPORT

August 11, 1998

SUPERVISED BY:
MF:glk

MORTON FLOM, P. Eng.

THE APPLICANT HAS BEEN CAUTIONED AS TO THE FOLLOWING:

15.21 INFORMATION TO USER.

The users manual or instruction manual for an intentional radiator shall caution the user that changes or modifications not expressly approved by the party responsible for compliance could void the user's authority to operate the equipment.

15.27(a) SPECIAL ACCESSORIES.

Equipment marketed to a consumer must be capable of complying with the necessary regulations in the configuration in which the equipment is marketed. Where special accessories, such as shielded cables and/or special connectors are required to enable an unintentional or intentional radiator to comply with the emission limits in this part, the equipment must be marketed with, i.e. shipped and sold with, those special accessories. However, in lieu of shipping or packaging the special accessories with the unintentional or intentional radiator, the responsible party may employ other methods of ensuring that the special accessories are provided to the consumer, without additional charge.

Information detailing any alternative method used to supply the special accessories for a grant of equipment authorization or retained in the verification records, as appropriate. The party responsible for the equipment, as detailed in § 2.909 of this chapter, shall ensure that these special accessories are provided with the equipment. The instruction manual for such devices shall include appropriate instructions on the first page of text concerned with the installation of the device that these special accessories must be used with the device. It is the responsibility of the user to use the needed special accessories supplied with the equipment.

TABLE OF CONTENTS

K66VXR-1000V

<u>RULE</u>	<u>DESCRIPTION</u>	<u>PAGE</u>
2.983	List of General Information Required	2
2.985(a)	Carrier Output Power	6
2.991	Unwanted Emissions (Transmitter Conducted)	8
2.993(a)	Field Strength of Spurious Radiation	11
2.989(c)	Occupied Bandwidth	14
90.214	Transient Frequency Behavior	16
2.987(a)	Audio Low Pass Filter (Voice Input)	19
2.987(a)	Audio Frequency Response	22
2.987(b)	Modulation Limiting	24
2.995(a)	Frequency Stability (Temperature Variation)	26
2.995(d)	Frequency Stability (Voltage Variation)	29
2.202(g)	Necessary Bandwidth and Emission Bandwidth	30

LIST OF GENERAL INFORMATION REQUIRED FOR TYPE ACCEPTANCE

IN ACCORDANCE WITH FCC RULES AND REGULATIONS,
VOLUME II, PART 2 AND TO

22, 74, 80, 90

Sub-part

2.983(a): NAME AND ADDRESS OF APPLICANT:

Yaesu Musen Co., Ltd.
20-2, Shimomaruko 1-chome
Ota-ku
Tokyo, Japan 146

VENDOR:

Yaesu U.S.A.
17210 Edwards Rd.
Cerritos, CA 90703

2.983(b): FCC ID: K66VXR-1000V

MODEL NO: VERTEX VXR-1000V

2.983(c): QUANTITY PRODUCTION PLANNED.

2.983(d): TECHNICAL DESCRIPTION: SEE ATTACHED EXHIBITS

(1): TYPE OF EMISSION: 16K0F3E, 11K0F3E

(2): FREQUENCY RANGE, MHz: 150 to 174

(3): POWER RATING, Watts: 0.5, 5
SWITCHABLE ___ ADJUSTABLE x N/A ___

(4): MAXIMUM POWER RATING, Watts: 300

2.983(d)

(5): VOLTAGES & CURRENTS IN ALL ELEMENTS IN FINAL R. F. STAGE, INCLUDING FINAL TRANSISTOR OR SOLID STATE DEVICE:

COLLECTOR CURRENT, A = per manual
COLLECTOR VOLTAGE, Vdc = per manual
SUPPLY VOLTAGE, Vdc = 13.8

(6): FUNCTION OF ACTIVE CIRCUIT DEVICES:

PLEASE SEE ATTACHED EXHIBITS

(7): CIRCUIT DIAGRAM:

PLEASE SEE ATTACHED EXHIBITS

(8): MANUAL:

PLEASE SEE ATTACHED EXHIBITS

(9): TUNE-UP PROCEDURE:

PLEASE SEE ATTACHED EXHIBITS

(10): DESCRIPTION OF CIRCUITRY & DEVICES PROVIDED FOR DETERMINING AND STABILIZING FREQUENCY:

PLEASE SEE ATTACHED EXHIBITS

(11): DESCRIPTION OF CIRCUITS OR DEVICES EMPLOYED FOR

- (a) SUPPRESSION OF SPURIOUS RADIATION,
- (b) LIMITING MODULATION,
- (c) LIMITING POWER:

PLEASE SEE ATTACHED EXHIBITS

(12): DIGITAL MODULATION DESCRIPTION:

ATTACHED EXHIBITS
N/A

 x

2.983(e): TEST AND MEASUREMENT DATA:

FOLLOWS

2.983(f): LABEL INFORMATION:

PLEASE SEE ATTACHED EXHIBITS

2.983(g): PHOTOGRAPHS:

PLEASE SEE ATTACHED EXHIBITS

Sub-part
2.983(e):

TEST AND MEASUREMENT DATA

All tests and measurement data shown were performed in accordance with FCC Rules and Regulations, Volume II; Part 2, Sub-part J, Sections 2.981, 2.983, 2.985, 2.987, 2.989, 2.991, 2.993, 2.995, 2.997, 2.999 and the following individual Parts:

- 21 - Domestic Public Fixed Radio Services
- 22 - Public Mobile Services
- 22 Subpart H - Cellular Radiotelephone Service
- 22.901(d) - Alternative technologies and auxiliary services
- 23 - International Fixed Public Radiocommunication services
- 24 - Personal Communications Services
- 74 Subpart H - Low Power Auxiliary Stations
- 80 - Stations in the Maritime Services
- 80 Subpart E - General Technical Standards
- 80 Subpart F - Equipment Authorization for Compulsory Ships
- 80 Subpart K - Private Coast Stations and Marine Utility Stations
- 80 Subpart S - Compulsory Radiotelephone Installations for Small Passenger Boats
- 80 Subpart T - Radiotelephone Installation Required for Vessels on the Great Lakes
- 80 Subpart U - Radiotelephone Installations Required by the Bridge-to-Bridge Act
- 80 Subpart V - Emergency Position Indicating Radiobeacons (EPIRB'S)
- 80 Subpart W - Global Maritime Distress and Safety System (GMDSS)
- 80 Subpart X - Voluntary Radio Installations
- 87 - Aviation Services
- 90 - Private Land Mobile Radio Services
- 94 - Private Operational-Fixed Microwave Service
- 95 Subpart A - General Mobile Radio Service (GMRS)
- 95 Subpart C - Radio Control (R/C) Radio Service
- 95 Subpart D - Citizens Band (CB) Radio Service
- 95 Subpart E - Family Radio Service
- 95 Subpart F - Interactive Video and Data Service (IVDS)
- 101 - Fixed Microwave Services

STANDARD TEST CONDITIONS
and
ENGINEERING PRACTICES

Except as noted herein, the following conditions and procedures were observed during the testing:

ROOM TEMPERATURE	=	25±5°C
ROOM HUMIDITY	=	20-50%
D.C. SUPPLY VOLTAGE, Vdc	=	13.8
A.C. SUPPLY VOLTAGE, Vac	=	N/A
A.C. SUPPLY FREQUENCY, Hz	=	N/A

Prior to testing, the EUT was tuned up in accordance with the manufacturer's alignment procedures. All external gain controls were maintained at the position of maximum and/or optimum gain throughout the testing.

Measurement results, unless otherwise noted, are worst case measurements.

PAGE NO. 6. K66VXR-1000V

NAME OF TEST: Carrier Output Power (Conducted)

SPECIFICATION: FCC: 47 CFR 2.985(a)
IC: RSS-119, Section 6.2

GUIDE: TIA/EIA-603, Paragraph 2.2.1

TEST CONDITIONS: Standard Temperature and Humidity (S. T. & H.)

TEST EQUIPMENT: As per attached page

MEASUREMENT PROCEDURE

1. The EUT was connected to a resistive coaxial attenuator of normal load impedance, and the unmodulated output power was measured by means of an R. F. Power Meter.
2. Measurement accuracy is $\pm 3\%$.

MEASUREMENT RESULTS

<u>NOMINAL, MHz</u>	<u>R.F. POWER OUTPUT, WATTS</u>	
162.025	0.5	5
150.025	0.5	5
173.975	0.5	5

SUPERVISED BY:

Morton Flom P. Eng.
MORTON FLOM, P. Eng.

TRANSMITTER POWER CONDUCTED MEASUREMENTS

TEST 1: R. F. POWER OUTPUT

TEST 2: FREQUENCY STABILITY

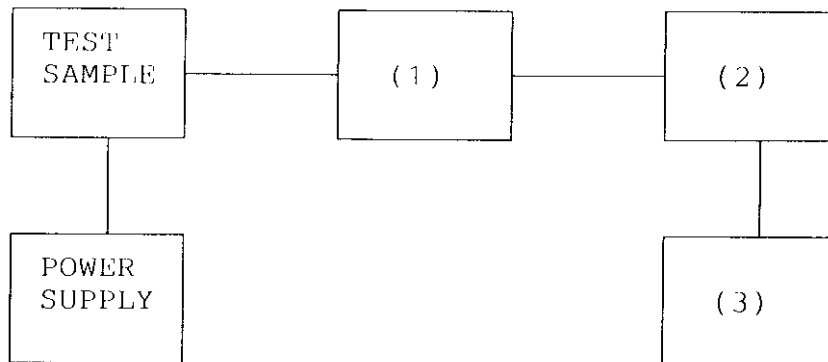
(1) COAXIAL ATTENUATOR

NARDA 766-10
 SIERRA 661A-30
 BIRD 8329 (30 dB)

 x

(2) POWER METERS

HP 435A
 HP 436A
 HP 8901A POWER MODE

 x
 x

(3) FREQUENCY COUNTER

HP 5383A
 HP 5334B
 HP 8901A FREQUENCY MODE

 x
 x

PAGE NO. 8. K66VXR-1000V
NAME OF TEST: Unwanted Emissions (Transmitter Conducted)
SPECIFICATION: FCC: 47 CFR 2.991
IC: RSS-119, Section 6.3
GUIDE: TIA/EIA-603, Paragraph 2.2.13
TEST CONDITIONS: S. T. & H.
TEST EQUIPMENT: As per attached page

MEASUREMENT PROCEDURE

1. The emissions were measured for the worst case as follows:
 - (a): within a band of frequencies defined by the carrier frequency plus and minus one channel.
 - (b): from the lowest frequency generated in the EUT and to at least the 10th harmonic of the carrier frequency, or 40 GHz, whichever is lower.
2. The magnitude of spurious emissions which are attenuated more than 20 dB below the permissible value need not be specified.
3. MEASUREMENT RESULTS: ATTACHED FOR WORST CASE

FREQUENCY OF CARRIER, MHz - 162.025, 150.025, 173.975
SPECTRUM SEARCHED, GHz = 0 to $10 \times F_C$
MAXIMUM RESPONSE, Hz = 2820
ALL OTHER EMISSIONS - ≥ 20 dB BELOW LIMIT
LIMIT, dBc: $-(43 + 10 \text{ LOG } P_0)$ = -40 (0.5 Watts)
-50 (5 Watts)



MORTON FLOM, P. Eng.

SUPERVISED BY:

TRANSMITTER SPURIOUS EMISSION

TEST A. OCCUPIED BANDWIDTH (IN-BAND SPURIOUS)

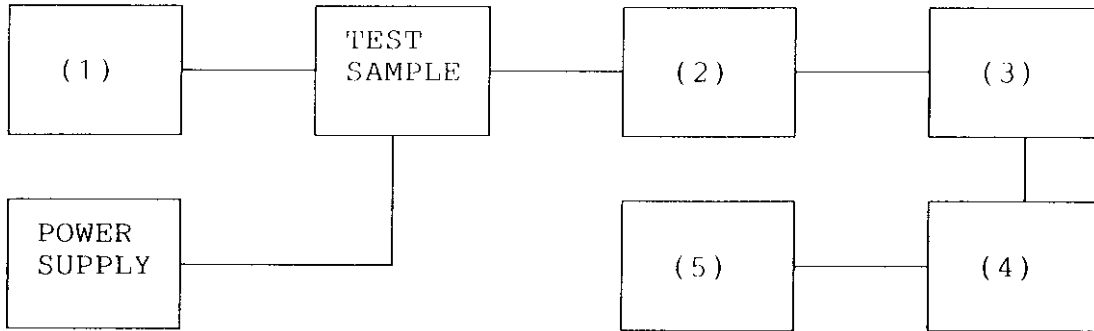
TEST B. OUT-OF-BAND SPURIOUS



- | | | |
|-----|--|--|
| (1) | <u>AUDIO OSCILLATOR/GENERATOR</u>
HP 204D
HP 8903A
HP 3312A | _____

<u> x </u>
<u> x </u> |
| (2) | <u>COAXIAL ATTENUATOR</u>
NARDA 766-10
SIERRA 661A-30
BIRD 8329 (30 dB) | _____

<u> x </u>
<u> x </u> |
| (3) | <u>FILTERS; NOTCH, HP, LP, BP</u>
CIRQTEL FHT
EAGLE TNF 1
PHELPS DODGE PD 495-8 | _____

<u> x </u>
_____ |
| (4) | <u>SPECTRUM ANALYZER</u>
HP 8566B
HP 8563E | _____
<u> x </u>
_____ |
| (5) | <u>SCOPE</u>
HP 1741A
HP 181T
TEK 935
HP 54502A | _____

_____ |

PAGE NO.
G887002

10.1.

K66VXR-1000V

TRANSMITTER SPURIOUS EMISSIONS (CONDUCTED)
POWER: LOW

FREQUENCY TUNED, MHz	FREQUENCY EMISSION, MHz	LEVEL, dBm	LEVEL, dBc	LEVEL, μ W
162.025	324.448	-53.7	-80.6	0
162.025	486.072	37.8	-64.7	0
162.025	648.091	-45.9	-72.8	0
162.025	810.084	-55.0	-81.9	0
162.025	972.151	54.8	-81.7	0
162.025	1134.239	-52.9	-79.8	0
162.025	1296.403	54.8	-81.7	0
162.025	1458.236	-49.5	-76.4	0
162.025	1620.258	53.5	-80.4	0
162.025	1782.250	-53.0	-79.9	0
162.025	1944.281	-49.6	-76.5	0
162.025	2106.339	50.5	-77.4	0
162.025	2268.370	-51.0	-77.9	0
162.025	2430.422	-51.4	-78.3	0

PAGE NO.

10.2.

K66VXR 1000V

G887001

TRANSMITTER SPURIOUS EMISSIONS (CONDUCTED)

POWER: HIGH

FREQUENCY TUNED, MHz	FREQUENCY EMISSION, MHz	LEVEL, dBm	LEVEL, dBc	LEVEL, μ W
162.025	324.058	-45.2	-82.1	0
162.025	486.082	-37.9	-74.8	0
162.025	648.091	-41.2	-78.1	0
162.025	810.107	-44.9	-81.8	0
162.025	972.342	44.9	-81.8	0
162.025	1134.468	-44.4	-81.3	0
162.025	1295.740	-44.7	-81.6	0
162.025	1458.245	34.8	-71.7	0
162.025	1620.278	-40.9	-77.8	0
162.025	1782.302	-34.7	-71.6	0
162.025	1944.316	-34.8	-71.7	0
162.025	2106.361	-40.5	-77.4	0
162.025	2268.369	-42.3	-79.2	0
162.025	2430.377	-42.0	-78.9	0

PAGE NO. 11.1. K66VXR-1000V
NAME OF TEST: Field Strength of Spurious Radiation
SPECIFICATION: FCC: 47 CFR 2.993(a)
IC: N/A
GUIDE: TIA/ETA-603, Section 2.2.12
TEST CONDITIONS: S. T. & H.
TEST EQUIPMENT: AS PER ATTACHED PAGE

MEASUREMENT PROCEDURE

1. A description of the measurement facilities was filed with the FCC and was found to be in compliance with the requirements of Section 15.38, by letter from the FCC dated March 3, 1997, FILE 31040/SIP. All pertinent changes will be reported to the Commission by up date prior to March 2000.
2. At first, in order to locate all spurious frequencies and approximate amplitudes, and to determine proper equipment functioning, the test sample was set up at a distance of three meters from the test instrument. Valid spurious signals were determined by switching the power on and off.
3. In the field, the test sample was placed on a wooden turntable above ground at three (or thirty) meters away from the search antenna. The test sample was connected to an R.F. Wattmeter and a 50 ohm dummy load, and adjusted to its rated output.

In order to obtain the maximum response at each spurious frequency, the turntable was rotated. Also, the Search Antennas were raised and lowered vertically, and all cables were oriented. Excess power lead was coiled near the power supply.
4. A signal generator, connected with a non-radiating cable to a vertically polarized half-wave antenna (for each frequency involved) was substituted for the transmitter. The Search Antenna was raised and lowered to obtain maximum indicated.
5. The signal generator output was adjusted until a signal level indication equal to that from the transmitter was obtained.
6. Steps 4 and 5 were repeated, using a horizontally polarized half-wave antenna. The higher of the two observations was noted.

PAGE NO.

11.2.

K66VXR-1000V

NAME OF TEST:

Field Strength of Spurious Radiation

SPECIFICATION:

FCC: 47 CFR 2.993(a)

IC: N/A

MEASUREMENT PROCEDURE (CONT.)

7. Power into the half-wave antenna was calculated from the characteristic impedance of the line, and the voltage output from the signal generator.

8. The level of each spurious radiation with reference to the transmitter power in dB, was calculated from:

$$\text{SPURIOUS LEVEL, dB} = 10 \text{ LOG} \left(\frac{\text{Calculated Spurious Power}}{\text{Tx Power (Wattmeter)}} \right) \quad \begin{array}{l} \text{[from para. 7].} \\ \text{-----} \end{array}$$

9. The worst case for all channels is shown.

10. Measurement summary:

FREQUENCY OF CARRIER, MHz = 162.025, 150.025, 173.975

SPECTRUM SEARCHED, GHz = 0 to $10 \times F_C$

ALL OTHER EMISSIONS -- > 20 dB BELOW LIMIT

LIMIT, dBc = -50 (5 Watts)
-40 (0.5 Watts)

11. Measurement results:

ATTACHED FOR WORST CASE

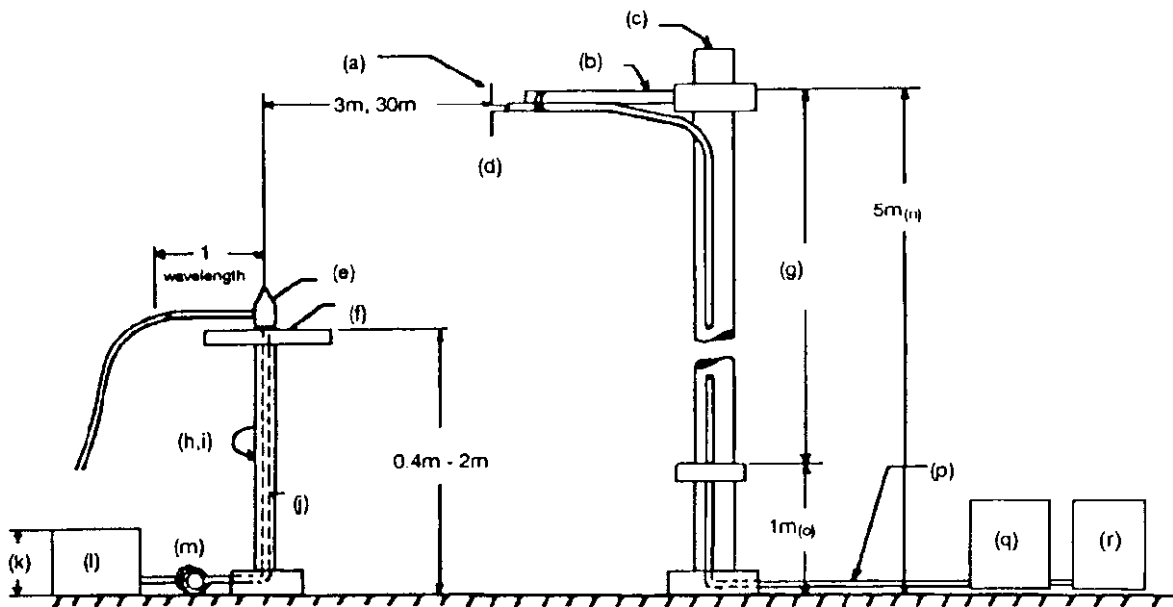
RADIATED TEST SETUP

NOTES:

- (a) Search Antenna - Rotatable on boom.
- (b) Non-metallic boom.
- (c) Non-metallic mast.
- (d) Adjustable horizontally.
- (e) Equipment Under Test.
- (f) Turntable.
- (g) Boom adjustable in height.
- (h) External control cables routed horizontally at least one wavelength.
- (i) Rotatable.
- (j) Cables routed through hollow turntable center.
- (k) 30 cm or less.
- (l) External power source.
- (m) 10 cm diameter coil of excess cable.
- (n) 25 cm (V), 1 m-7 m (V, H).
- (o) 25 cm from bottom end of 'V', 1 m normally.
- (p) Calibrated Cable at least 10 m in length.
- (q) Amplifier (optional).
- (r) Spectrum Analyzer.

TRANSMITTER SPURIOUS EMISSIONS (RADIATED FIELD STRENGTH)

ALL OTHER EMISSIONS = > 20 dB BELOW LIMIT

EMISSION, MHz/HARMONIC	SPURIOUS LEVEL BELOW	
	Lo	Hi
2nd to 10th	<-60	<-70

SUPERVISED BY:

M. Flom P. Eng.
 MORTON FLOM, P. Eng.

PAGE NO. 14. K66VXR-1000V
NAME OF TEST: Emission Masks (Occupied Bandwidth)
SPECIFICATION: FCC: 47 CFR 2.989(c)(1)
IC: RSS 119, Section 6.4
GUIDE: TIA/EIA 603, Paragraph 2.2.11
TEST CONDITIONS: S. T. & H.
TEST EQUIPMENT: As per previous page

MEASUREMENT PROCEDURE

1. The EUT and test equipment were set up as shown on the following page, with the Spectrum Analyzer connected.
2. For EUTs supporting audio modulation, the audio signal generator was adjusted to the frequency of maximum response and with output level set for +2.5 kHz deviation (or 50% modulation). With level constant, the signal level was increased 16 dB.
3. For EUTs supporting digital modulation, the digital modulation mode was operated to its maximum extent.
4. The Occupied Bandwidth was measured with the Spectrum Analyzer controls set as shown on the test results.
5. MEASUREMENT RESULTS: ATTACHED

SPECTRUM ANALYZER PRESENTATION

YAESU, VXR-1000V

1998-AUG-10, 09:17, MON

POWER: LOW
MODULATION: NONE

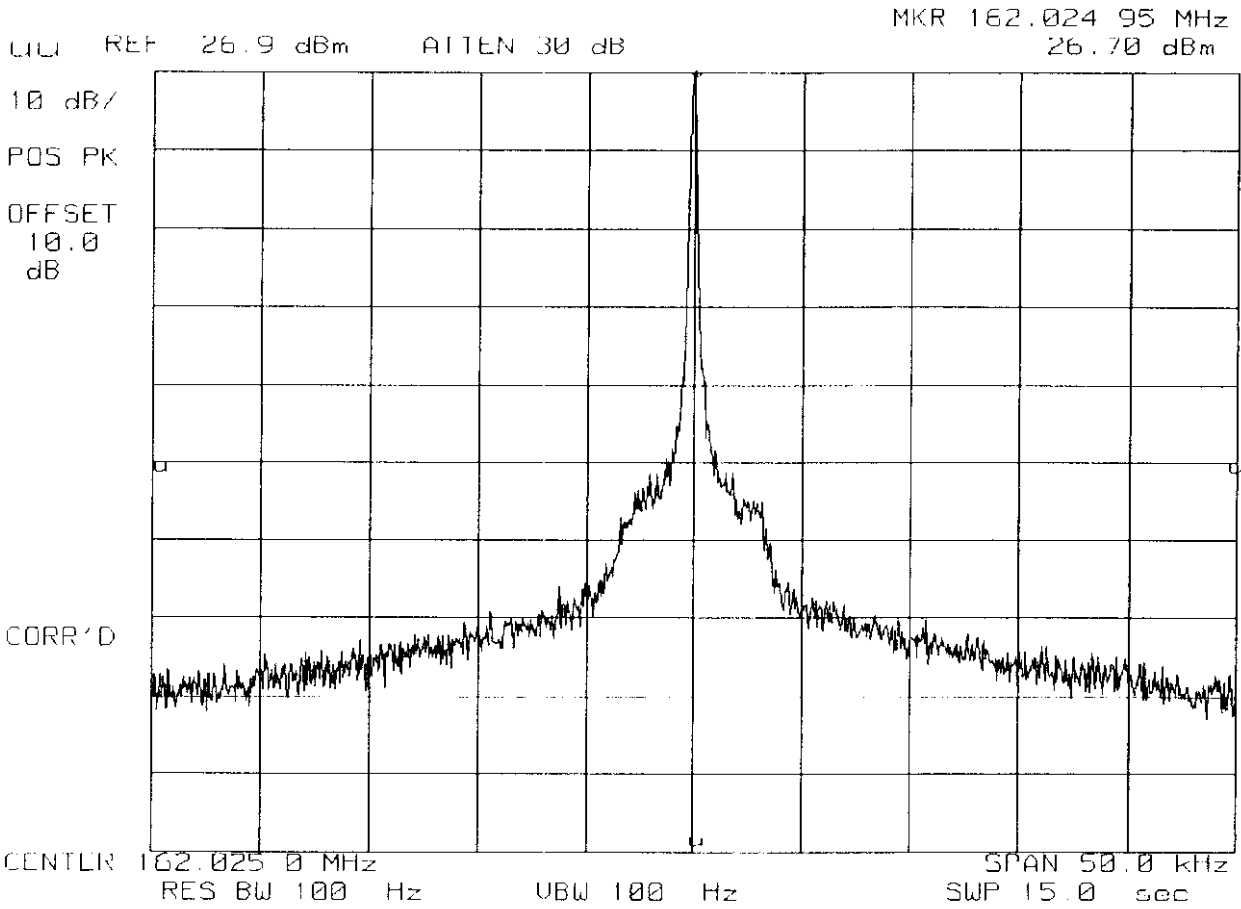

ALL RIGHTS RESERVED

SPECTRUM ANALYZER PRESENTATION

YAESU, VXR-1000V

1998-AUG-07, 10:16, FRI

POWER: LOW
MODULATION: VOICE: 2500 Hz SINE WAVE
MASK: D, VHF/UHF 12.5kHz BW

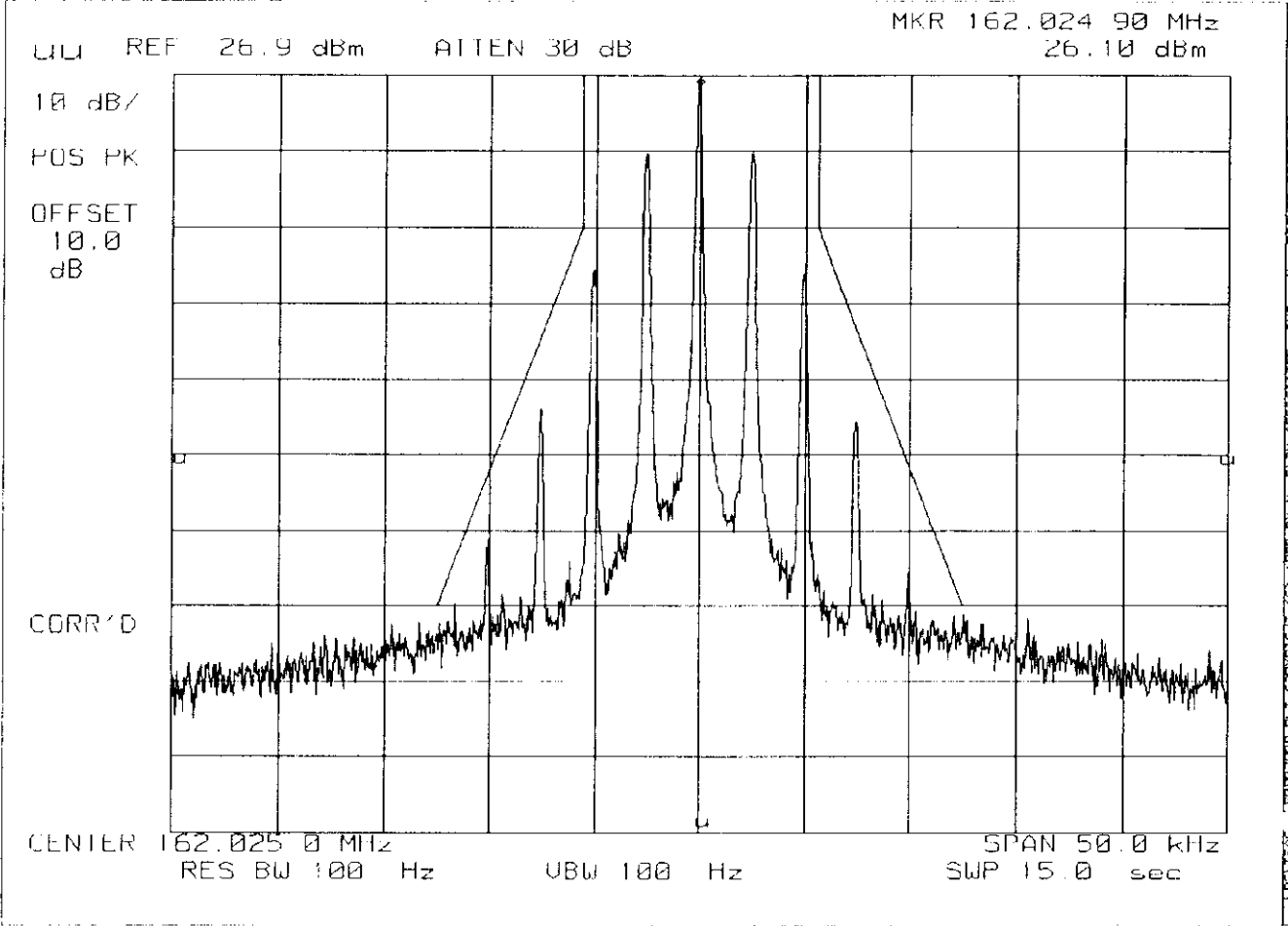

SPECTRUM ANALYZER PRESENTATION

YAESU, VXR-1000V

1998-AUG-07, 09:53, FRI

POWER: LOW
MODULATION: VOICE: 2500 Hz SINE WAVE
MASK: B, VHF/UHF 25kHz, w/LPF

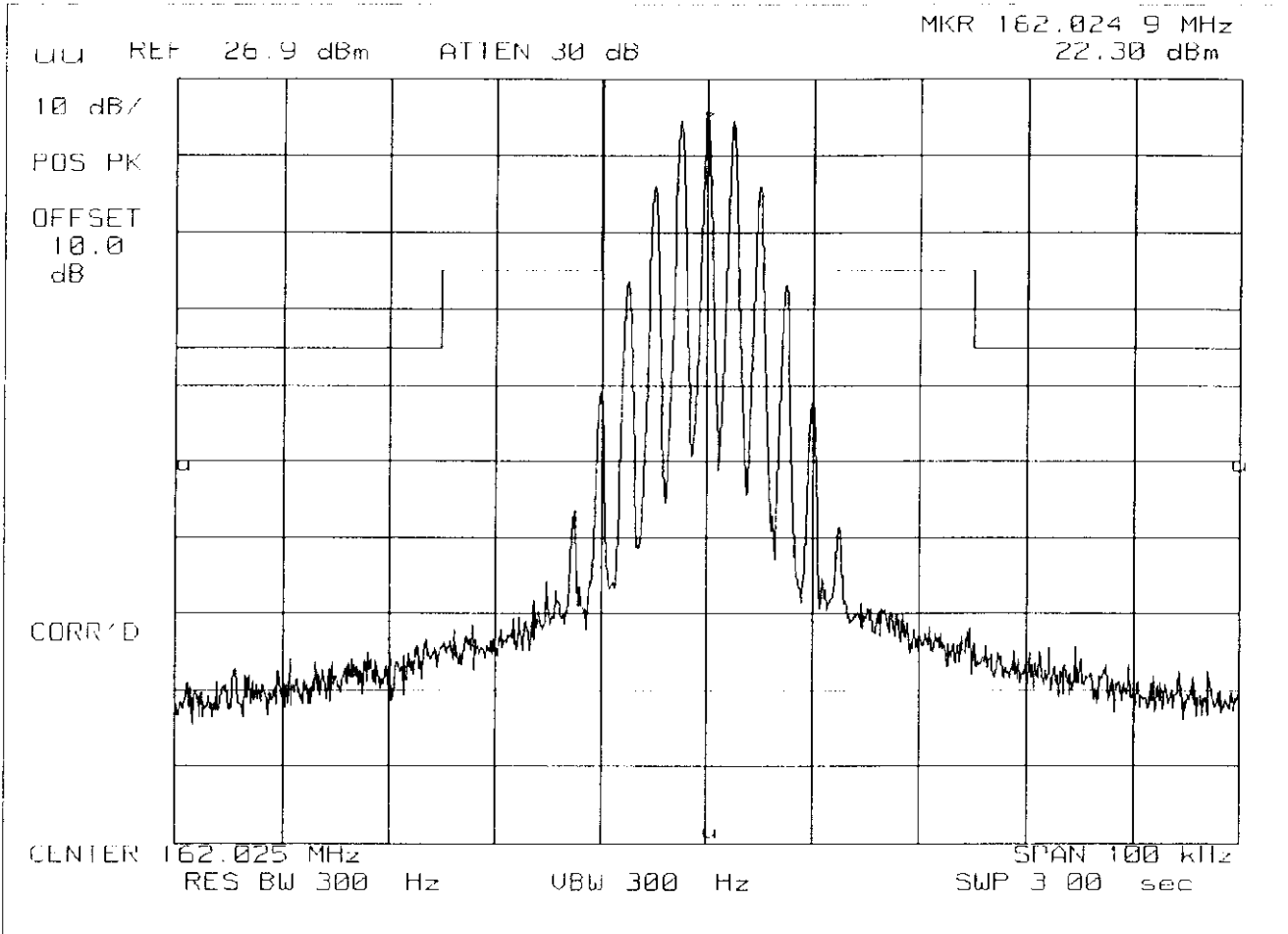

SPECTRUM ANALYZER PRESENTATION

YAESU, VXR-1000V

1998-AUG-07, 09:37, FRI

POWER: HIGH
MODULATION: NONE

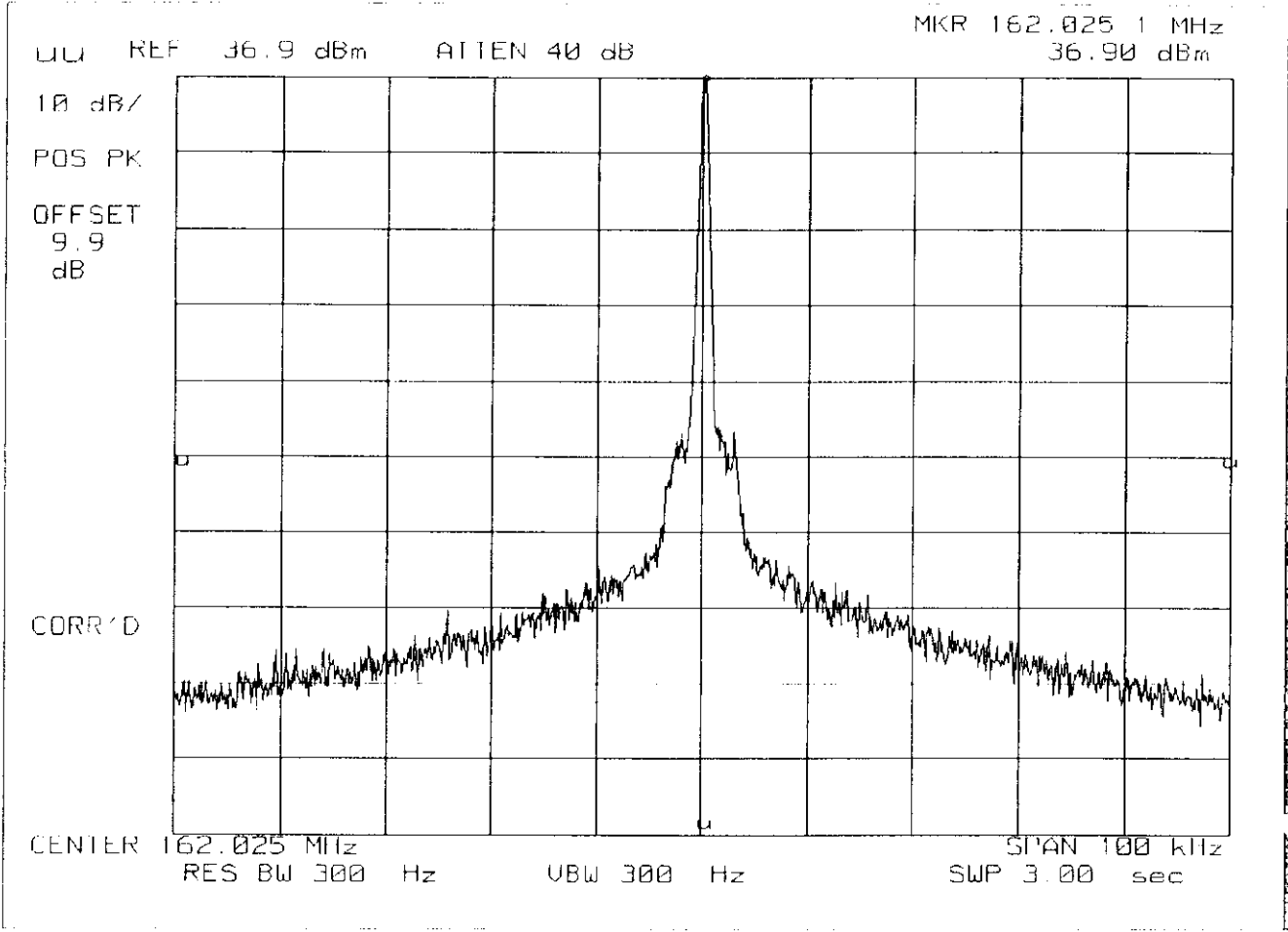

SPECTRUM ANALYZER PRESENTATION

YAESU, VXR-1000V

1998-AUG-07, 10:14, FRI

POWER: HIGH
MODULATION: VOICE: 2500 Hz SINE WAVE
MASK: D, VHF/UHF 12.5kHz BW

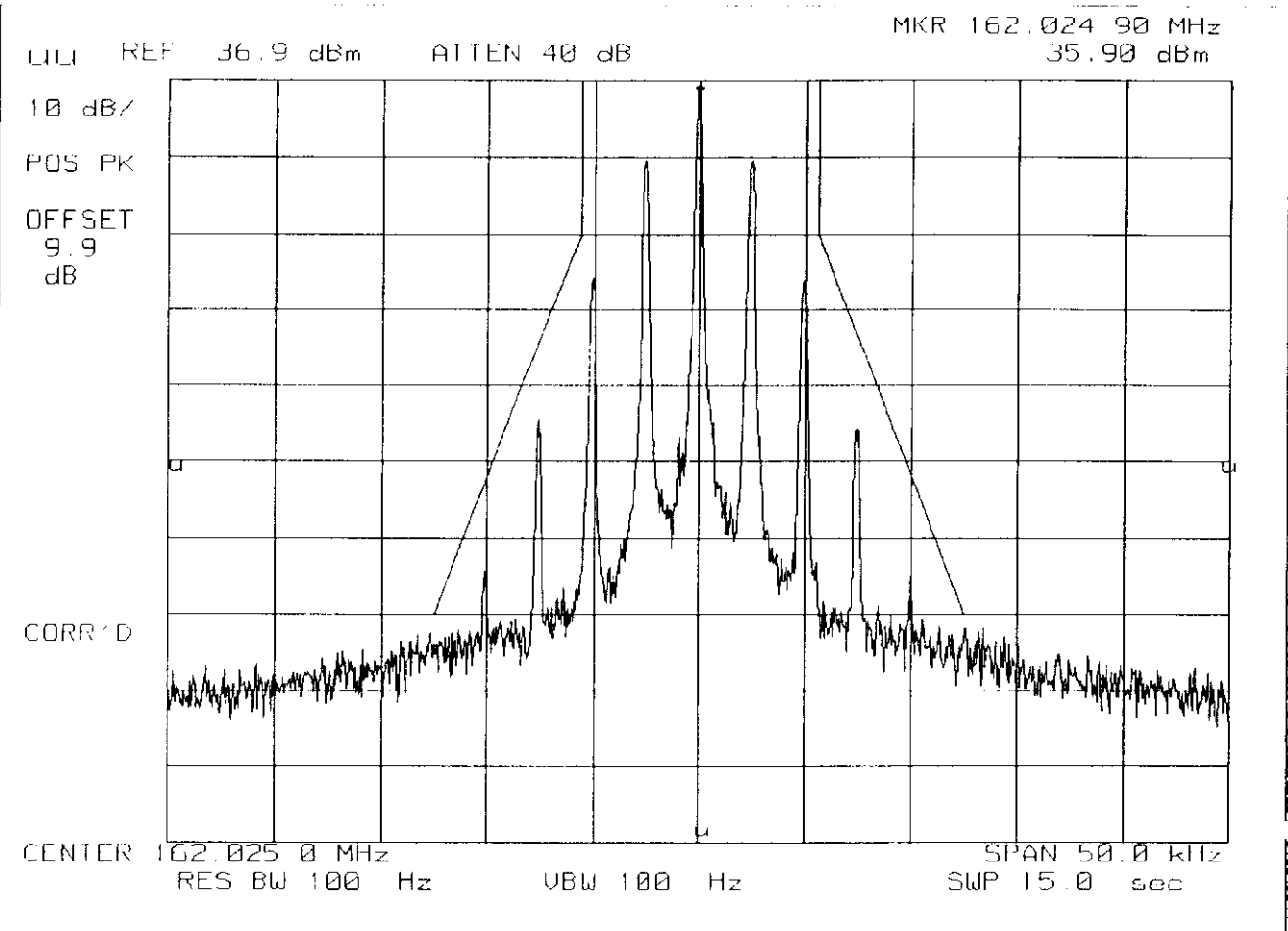

© 1998 YAESU INC. ALL RIGHTS RESERVED

SPECTRUM ANALYZER PRESENTATION

YAESU, VXR-1000V

1998-AUG-07, 09:50, FRI

POWER: HIGH
MODULATION: VOICE: 2500 Hz SINE WAVE
MASK: B, VHF/UHF 25kHz, w/LPF

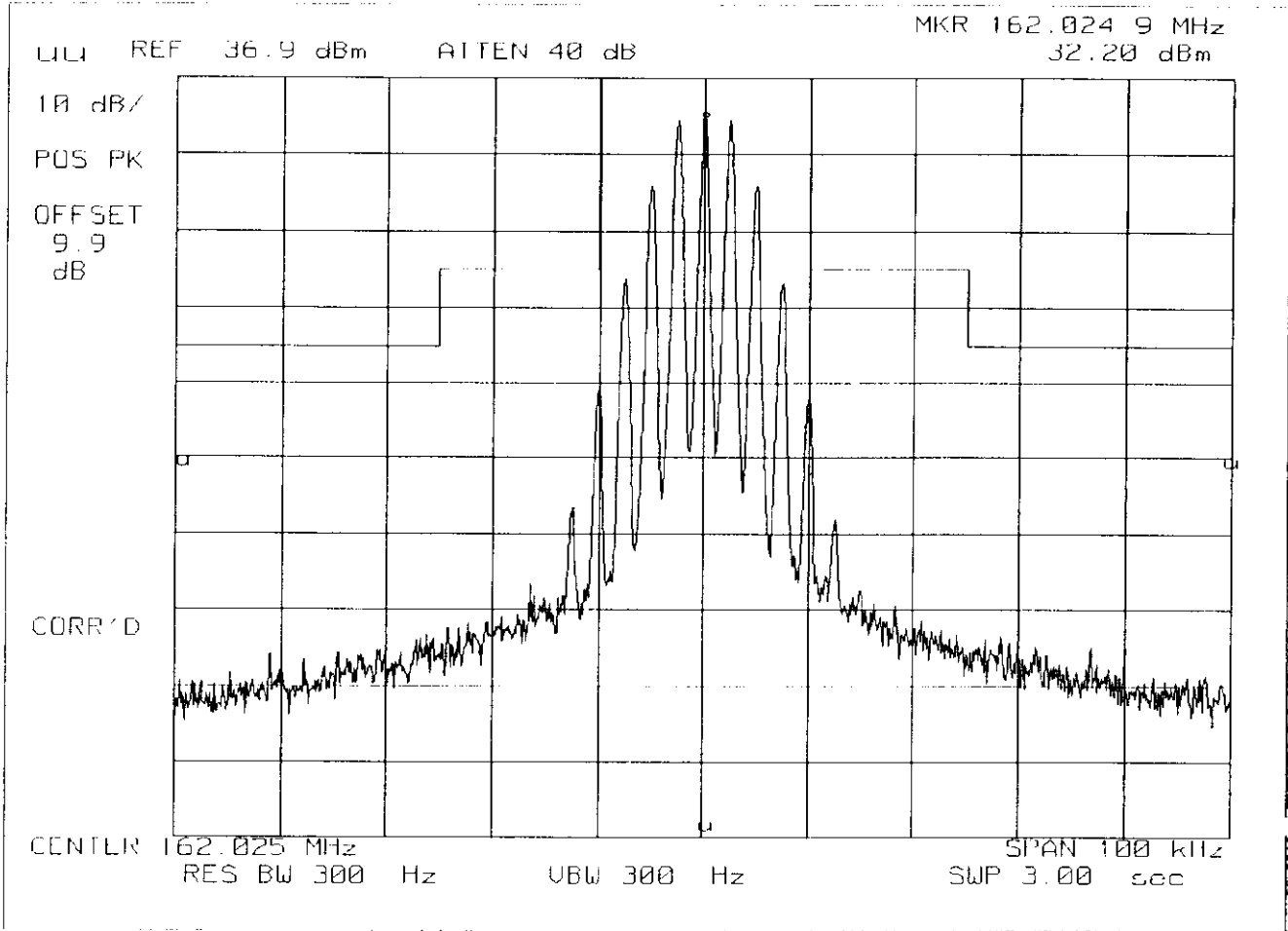

PAGE NO.

16.

K66VXR-1000V

NAME OF TEST:

Transient Frequency Behavior

SPECIFICATION:

FCC: 47 CFR 90.214
IC: RSS 119, Section 6.5

GUIDE:

TIA/EIA-603, Paragraph 2.2.19

TEST CONDITIONS:

S. T. & H.

TEST EQUIPMENT:

As per attached page

MEASUREMENT PROCEDURE

1. The EUT was setup as shown on the attached page, following TIA/EIA-603 steps a, b, and c as a *guide*.
2. The transmitter was turned on.
3. Sufficient attenuation was provided so that the transmitter carrier level measured at the output of the combiner was 40 dB below the maximum input level of the test receiver. This level was recorded as step f.
4. The transmitter was turned off.
5. An RF signal generator (1) modulated with a 1 kHz tone at either 25, 12.5, or 6.25 kHz deviation, and set to the same frequency as the assigned transmitter frequency, (2) was adjusted to a level -20 dB below the level recorded for step f, as measured at the output of the combiner. This level was then fixed for the remainder of the test and is recorded at step h.
6. The oscilloscope was setup using TIA/EIA-603 steps j and k as a guide, and to either 10 ms/div (UHF) or 5 ms/div (VHF).
7. The 30 dB attenuator was removed, the transmitter was turned on, and the level of the carrier at the output of the combiner was recorded as step l.
8. The carrier on-time as referenced in TIA/EIA-603 steps m, n, and o was captured and plotted. The carrier off-time as referenced in TIA/EIA-603 steps p, q, r, and s was captured and plotted.

LEVELS MEASURED:

<u>step f</u> , dBm	= -12.3
<u>step h</u> , dBm	= -33.2
<u>step l</u> , dBm	= 16.4

SUPERVISED BY:

MORTON FLOM, P. Eng.

TRANSIENT FREQUENCY BEHAVIOR

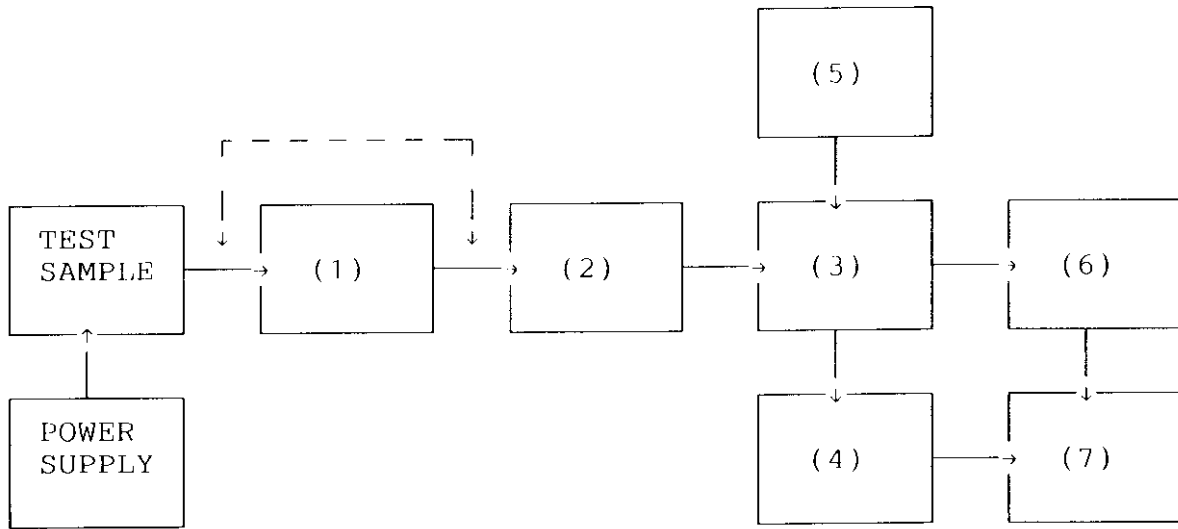

- (1) ATTENUATOR
 (NOTE: Removed after 1st step)
 30 dB x

- (2) ATTENUATOR
 30 dB
 20 dB x
 10 dB
 KAY VARIABLE

- (3) COMBINER
 4 x 25 Ω COMBINER x

- (4) CRYSTAL DETECTOR
 HP 8470B x

- (5) RF SIGNAL GENERATOR
 HP 8656A
 HP 8920A x

- (6) MODULATION ANALYZER
 HP 8901A x

- (7) SCOPE
 HP 54502A x

MODULATION: Ref Gen=12.5 kHz Deviation
 REMARK: CARRIER ON TIME

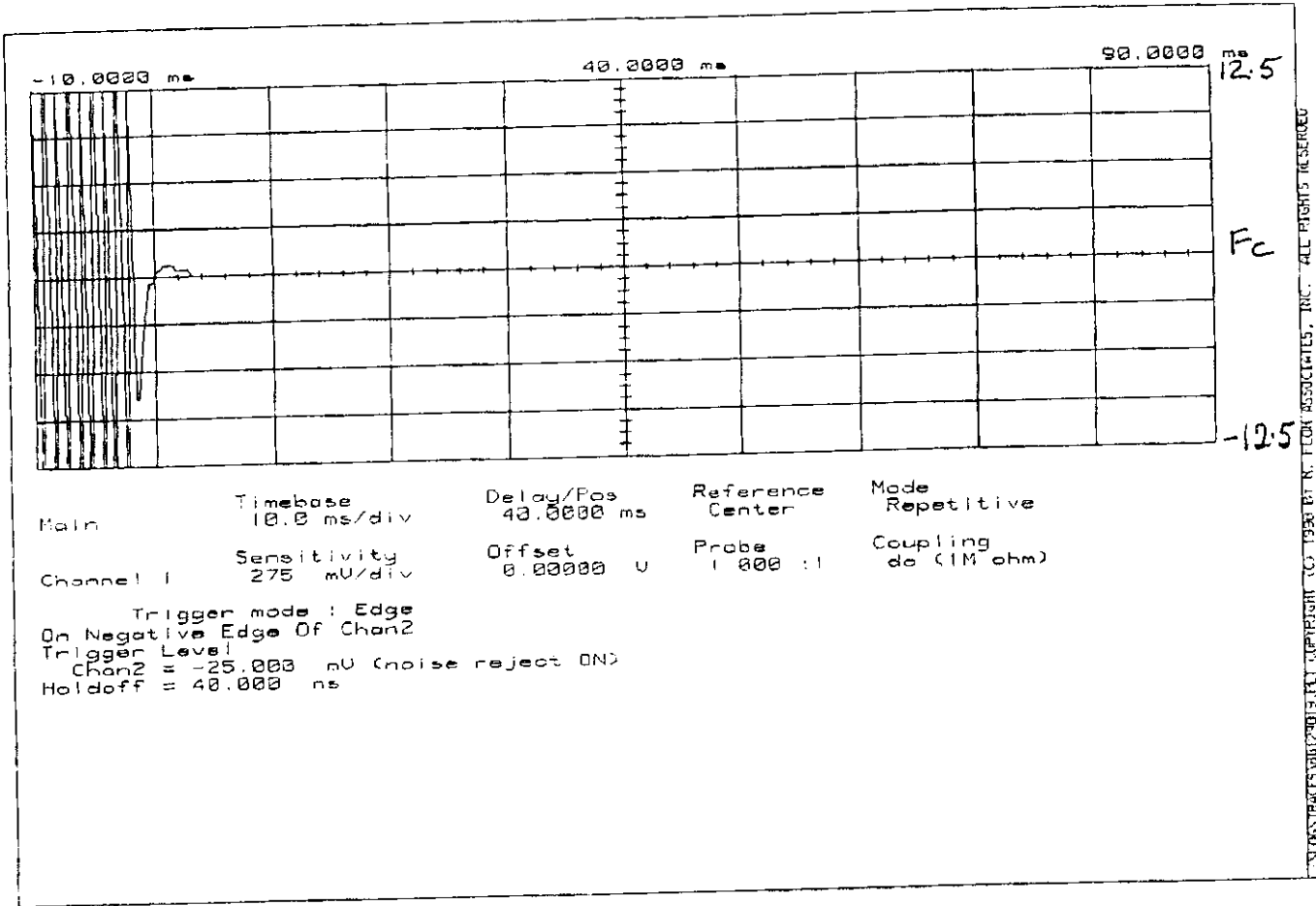

MODULATION: Ref Gen=12.5 kHz Deviation
REMARK: CARRIER OFF TIME

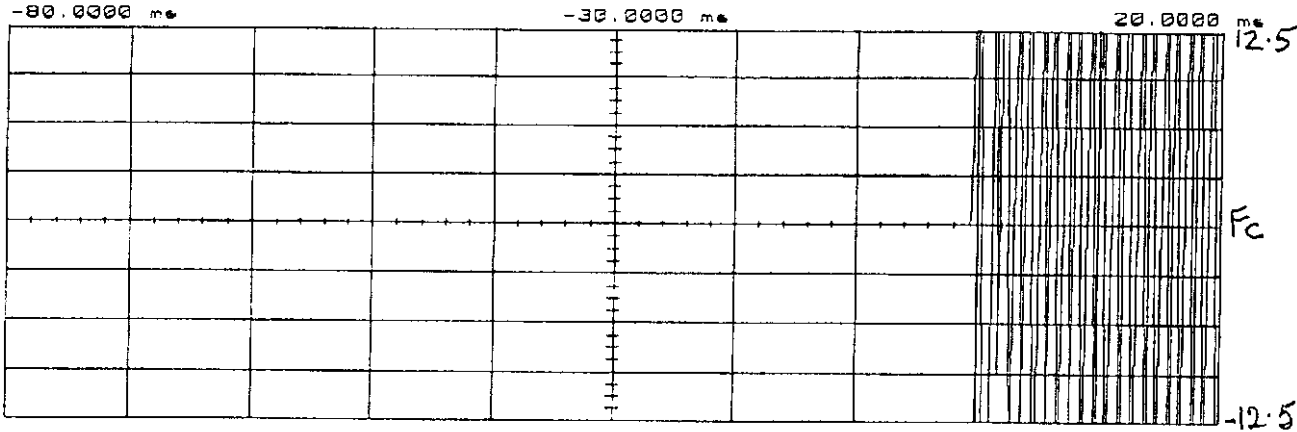

Main	Timebase 10.0 ms/div	Delay/Pos -30.0000 ms	Reference Center	Mode Repetitive
Channel 1	Sensitivity 275 mV/div	Offset 0.00000 U	Probe 1.000 :1	Coupling dc (1M ohm)

Trigger mode : Edge
On Positive Edge Of Chan2
Trigger Level
Chan2 = -600.000 mV (noise reject ON)
Holdoff = 40.000 ns

OSCILLOSCOPE PRESENTATION COPYRIGHT © 1999 BY H. FLOPP ASSOCIATES, INC. ALL RIGHTS RESERVED

OSCILLOSCOPE PRESENTATION

YAESU, VXR-1000V

MODULATION: Ref Gen=25 kHz Deviation

REMARK: CARRIER ON TIME

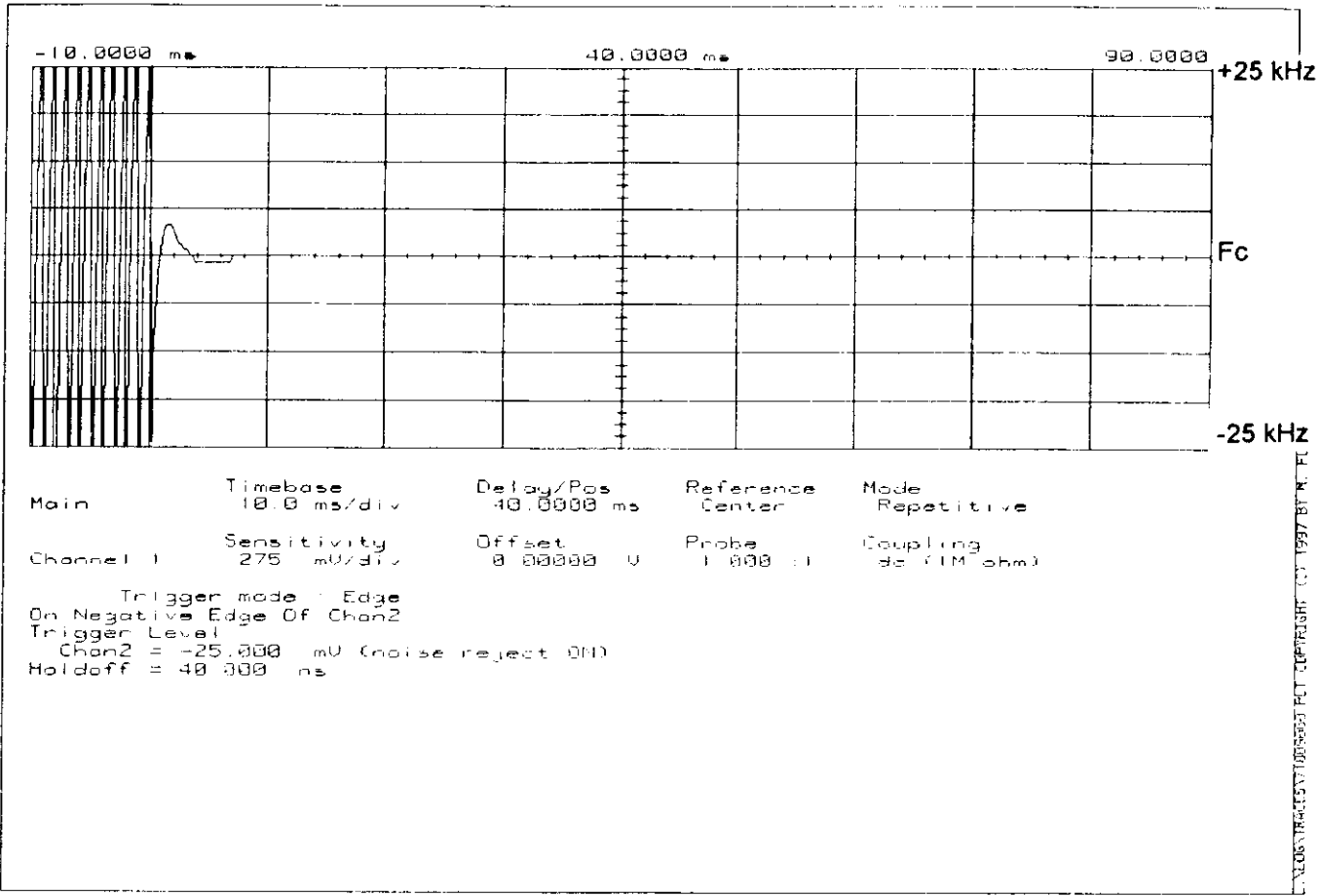

© 1997 BY N. FU

OSCILLOSCOPE PRESENTATION

YAESU, VXR-1000V

MODULATION: Ref Gen=25 kHz Deviation

REMARK: CARRIER OFF TIME

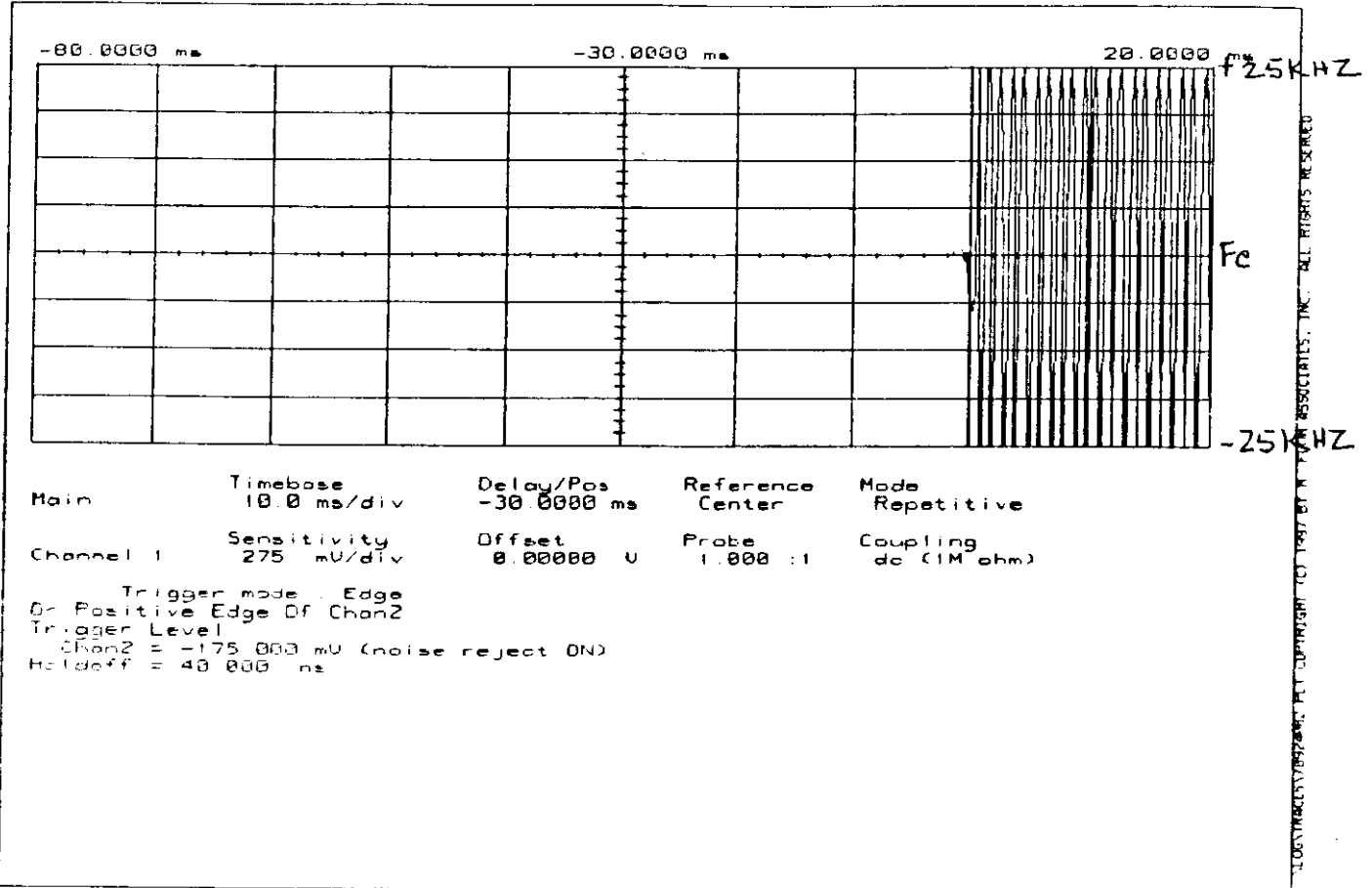

PAGE NO.

19.

K66VXR-1000V

NAME OF TEST:

Audio Low Pass Filter (Voice Input)

SPECIFICATION:

FCC: 47 CFR 2.987(a)
IC: RSS-119, Section 6.6

GUIDE:

TIA/EIA-603, Paragraph 2.2.15

TEST CONDITIONS:

S. T. & H.

TEST EQUIPMENT:

As per attached page

MEASUREMENT PROCEDURE

1. The EUT and test equipment were set up such that the audio input was connected at the input to the modulation limiter, and the modulated stage.
2. The audio output was connected at the output to the modulated stage.
3. MEASUREMENT RESULTS: ATTACHED

TRANSMITTER TEST SET-UP

- TEST A. MODULATION CAPABILITY/DISTORTION
- TEST B. AUDIO FREQUENCY RESPONSE
- TEST C. HUM AND NOISE LEVEL
- TEST D. RESPONSE OF LOW PASS FILTER
- TEST E. MODULATION LIMITING

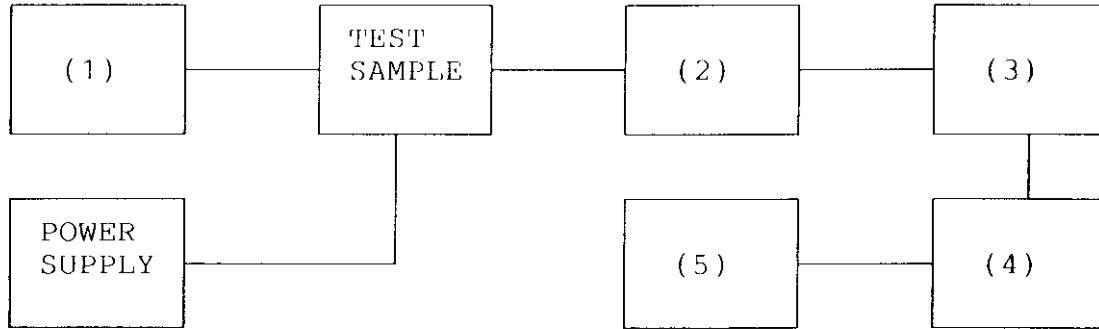

(1) AUDIO OSCILLATOR/GENERATOR

HP 204D	---
HP 8903A	---
HP 3312A	<u> x </u>
_____	<u> x </u>

(2) COAXIAL ATTENUATOR

NARDA 766-10	---
SIERRA 661A-30	<u> x </u>
BIRD 8329 (30 dB)	---
_____	---

(3) MODULATION ANALYZER

HP 8901A	<u> x </u>
_____	---

(4) AUDIO ANALYZER

HP 8903A	<u> x </u>
_____	---

(5) SCOPE

HP 1741A	---
HP 181T	---
TEK 935	---
_____	---

FREQUENCY RESPONSE OF AUDIO LOW PASS FILTER

YAESU, VXR-1000V

10 AUG 1998, 07:58

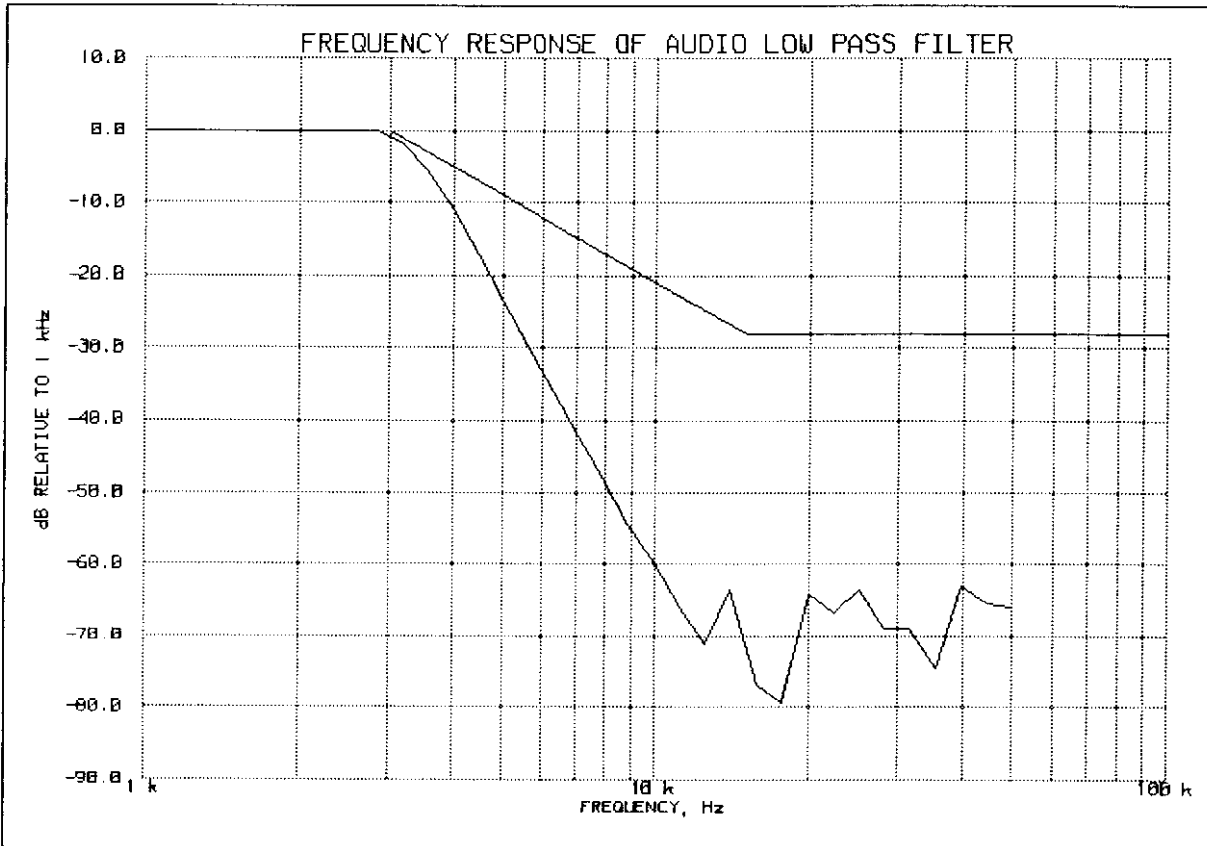

PEAK AUDIO FREQUENCY, Hz: 2820

Morton P. Eng

SUPERVISED BY:

MORTON FLOM, P. Eng.

PAGE NO. 22. K66VXR-1000V
NAME OF TEST: Audio Frequency Response
SPECIFICATION: FCC: 47 CFR 2.987(a)
IC: N/A
GUIDE: TIA/EIA-603, Section 2.2.6
TEST CONDITIONS: S. T. & H.
TEST EQUIPMENT: As per previous page

MEASUREMENT PROCEDURE

1. The EUT and test equipment were set up as shown on the following page.
2. The audio signal generator was connected to the audio input circuit/microphone of the EUT.
3. The audio signal input was adjusted to obtain 20% modulation at 1 kHz, and this point was taken as the 0 dB reference level.
4. With input levels held constant and below limiting at all frequencies, the audio signal generator was varied from 100 Hz to 50 kHz.
5. The response in dB relative to 1 kHz was then measured, using the HP 8901A Modulation Analyzer.
6. MEASUREMENT RESULTS: ATTACHED

TRANSMITTER AUDIO FREQUENCY RESPONSE

YAESU, VXR-1000V

10 AUG 1998, 07:53

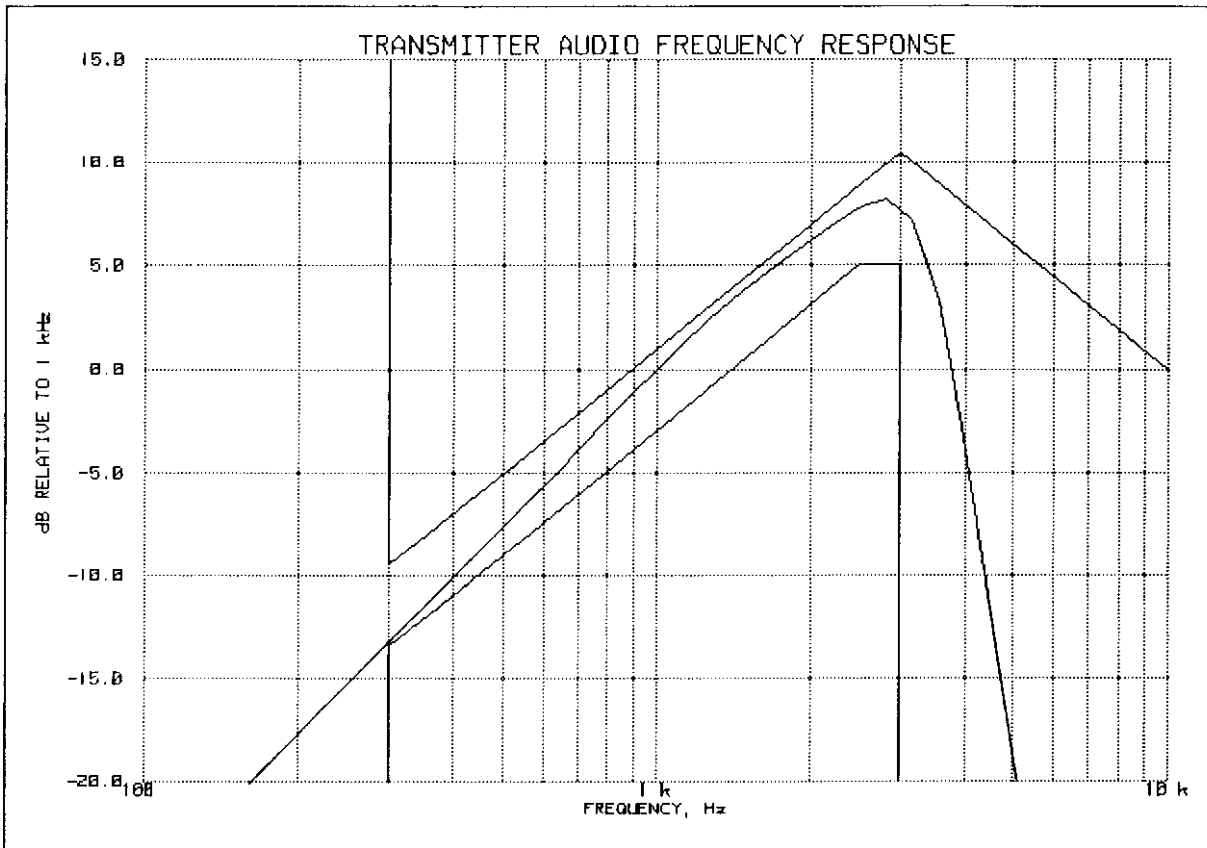

PEAK AUDIO FREQUENCY, Hz: 2820

TABLE VALUES:

FREQUENCY, Hz	LEVEL, dB	FREQUENCY, Hz	LEVEL, dB	FREQUENCY, Hz	LEVEL, dB
300	-14.6	30000	-18.6		
20000	-18.6	50000	-18.6		

Morton Flom P. Eng.

SUPERVISED BY:

MORTON FLOM, P. Eng.

PAGE NO.

24.

K66VXR-1000V

NAME OF TEST:

Modulation Limiting

SPECIFICATION:

IC: RSS-119, Section 6.6
FCC: 47 CFR 2.987(b)

GUIDE:

TIA/EIA-603, Paragraph 2.2.3

TEST CONDITIONS:

S. T. & H.

TEST EQUIPMENT:

As per attached page

MEASUREMENT PROCEDURE

1. The signal generator was connected to the input of the EUT as for "Frequency Response of the Modulating Circuit."
2. The modulation response was measured for each of three frequencies (one of which was the frequency of maximum response), and the input voltage was varied and was observed on an HP 8901A Modulation Analyzer.
3. The input level was varied from 30% modulation (± 1.5 kHz deviation) to at least 20 dB higher than the saturation point.
4. Measurements were performed for both negative and positive modulation and the respective results were recorded.
5. MEASUREMENT RESULTS: ATTACHED

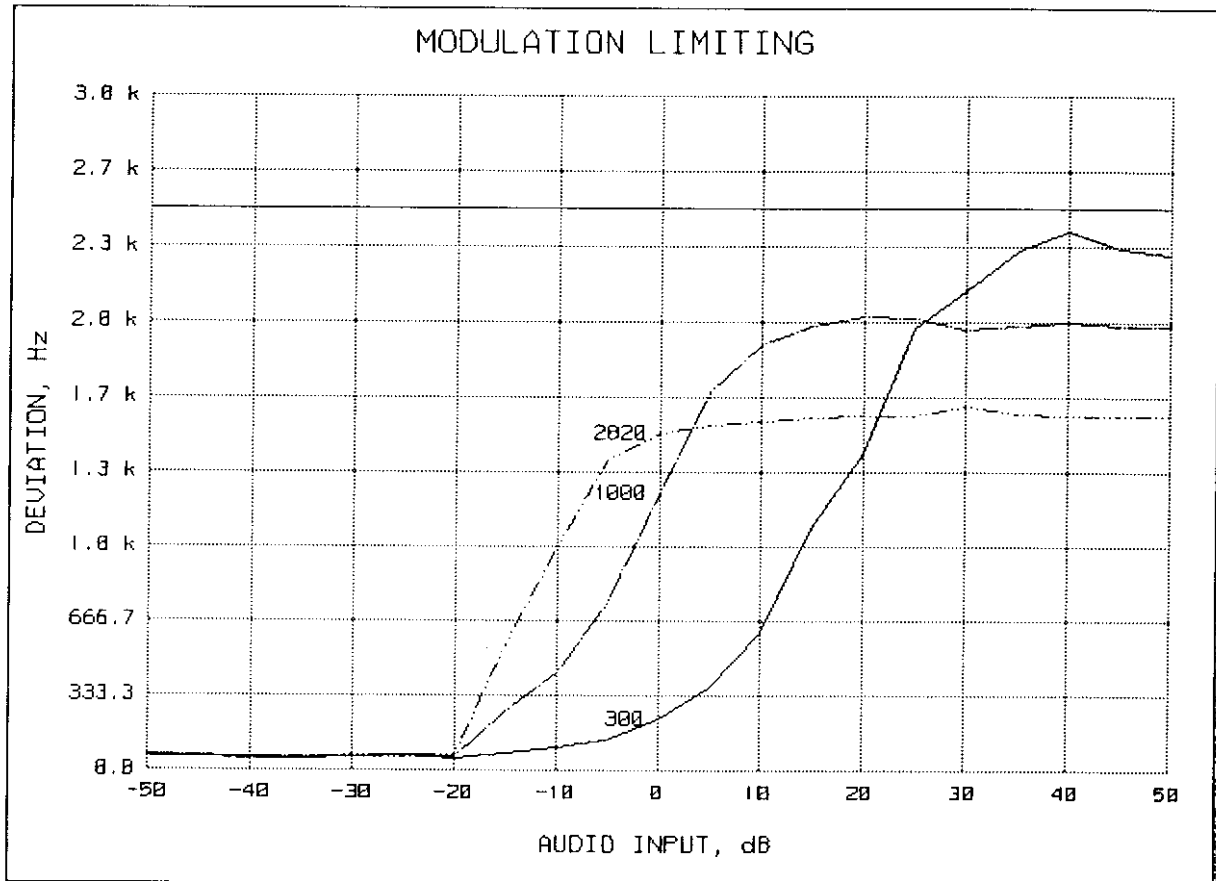

REFERENCE DEVIATION, kHz = 1.25
 REFERENCE MODULATION, Hz = 1000
 PEAKS = POSITIVE
 AUDIO AMPLITUDE, mV = 4.16

Morton Flom P. Eng.

SUPERVISED BY:

MORTON FLOM, P. Eng.

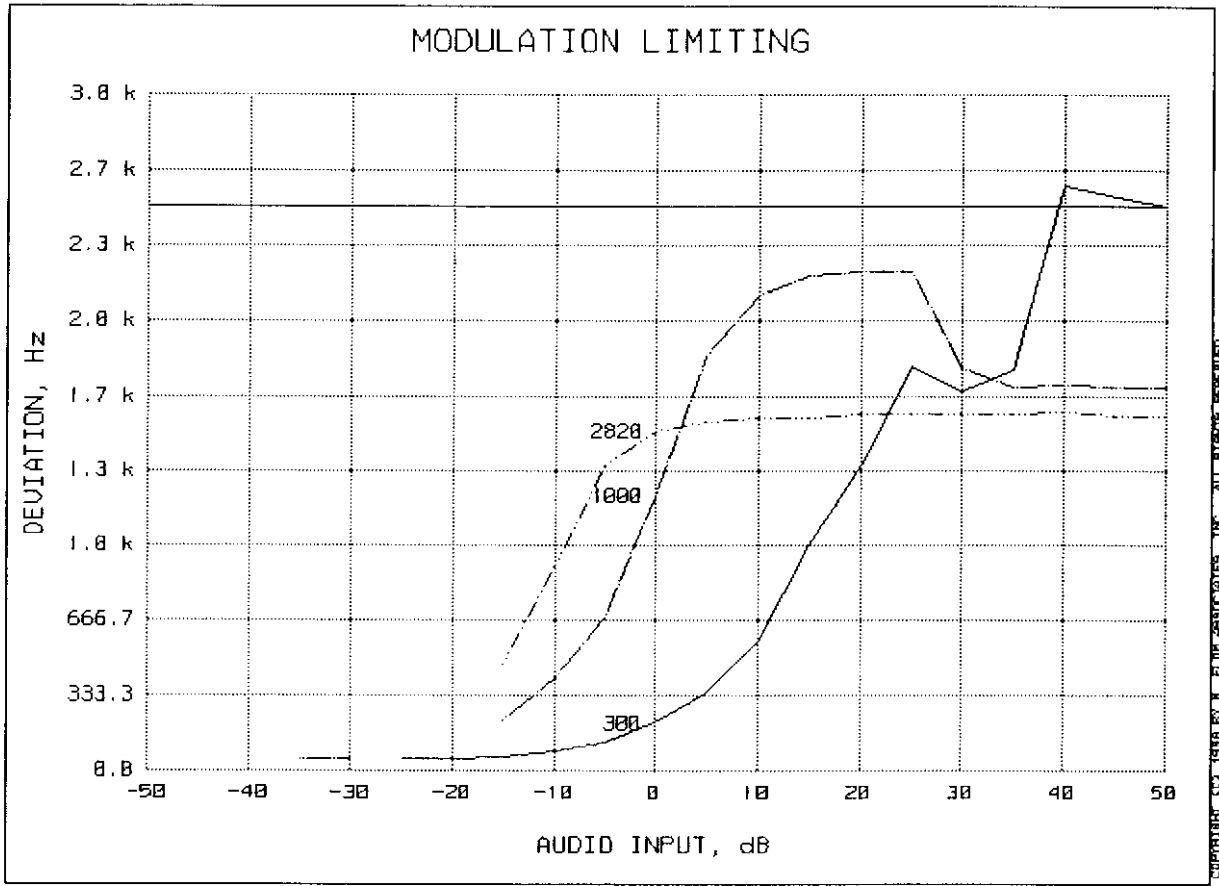

COPYRIGHT © 1988 BY M. FLOM ASSOCIATES, INC. ALL RIGHTS RESERVED.

REFERENCE DEVIATION, kHz = 1.25
 REFERENCE MODULATION, Hz = 1000
 PEAKS = NEGATIVE
 AUDIO AMPLITUDE, mV = 3.88

Morton Flom P. Eng.

SUPERVISED BY:

MORTON FLOM, P. Eng.

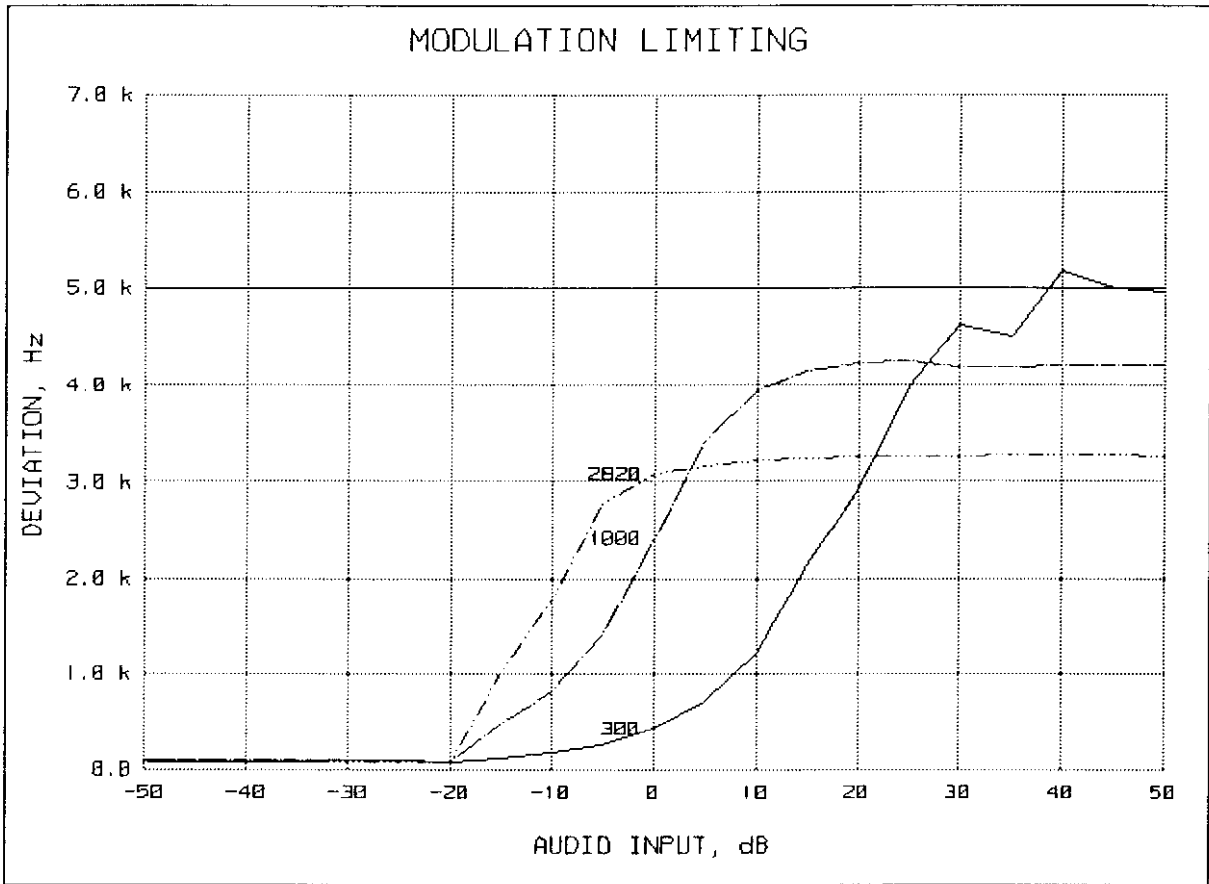

REFERENCE DEVIATION, kHz = 2.5
REFERENCE MODULATION, Hz = 1000
PEAKS = POSITIVE
AUDIO AMPLITUDE, mV = 3.67

Morton Flom P. Eng.

SUPERVISED BY:

MORTON FLOM, P. Eng.

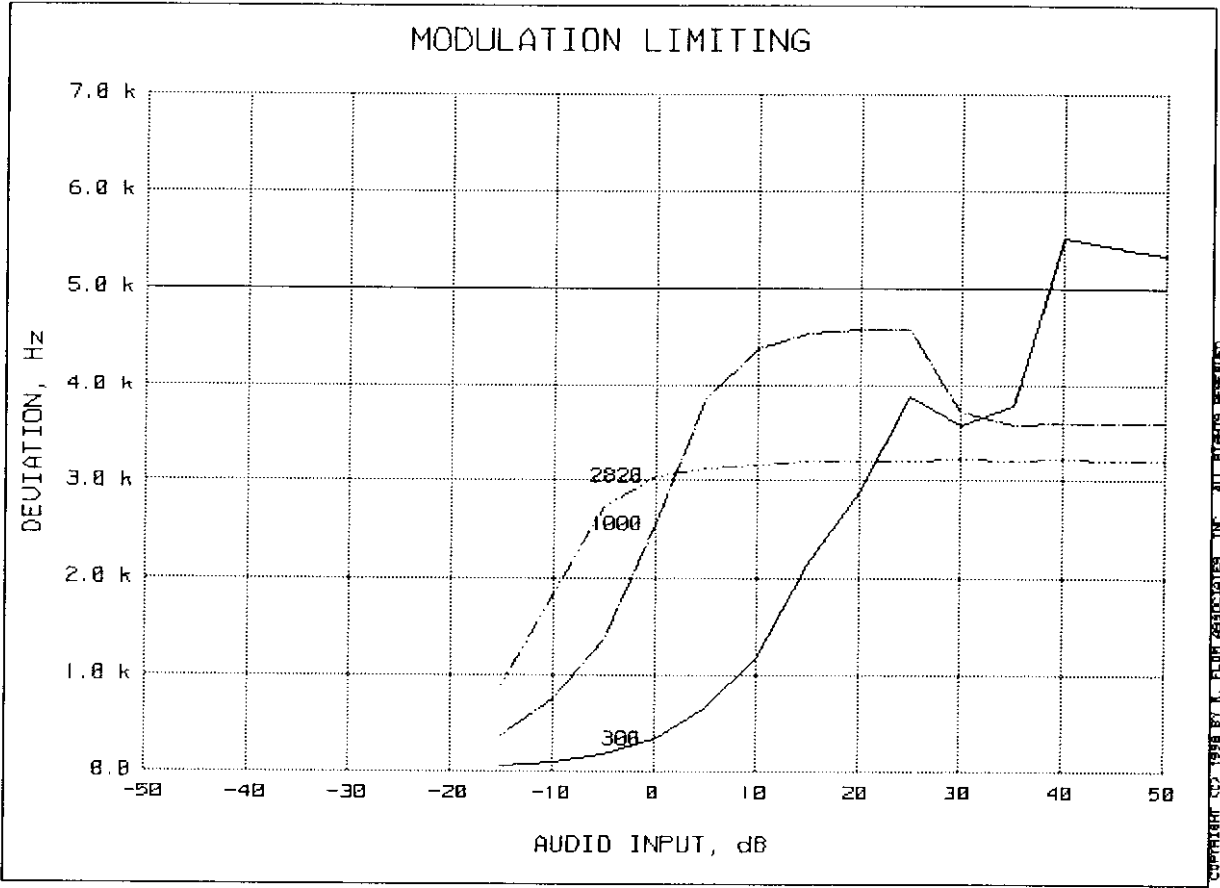

REFERENCE DEVIATION, kHz = 2.5
REFERENCE MODULATION, Hz = 1000
PEAKS = NEGATIVE
AUDIO AMPLITUDE, mV = 3.88

M. Flom P. Eng.
MORTON FLOM, P. Eng.

SUPERVISED BY:

PAGE NO. 26. K66VXR-1000V
NAME OF TEST: Frequency Stability (Temperature Variation)
SPECIFICATION: FCC: 47 CFR 2.995(a)(1)
IC: RSS-119, Section 7.0
GUIDE: TIA/EIA-602, Section 2.2.2
TEST CONDITIONS: As indicated
TEST EQUIPMENT: As per attached page

MEASUREMENT PROCEDURE

1. The EUT and test equipment were set up as shown on the following page.
2. With all power removed, the temperature was decreased to -30°C and permitted to stabilize for three hours. Power was applied and the maximum change in frequency was noted within one minute.
3. With power OFF, the temperature was raised in 10°C steps. The sample was permitted to stabilize at each step for at least one-half hour. Power was applied and the maximum frequency change was noted within one minute.
4. The temperature tests were performed for the worst case.
5. MEASUREMENT RESULTS: ATTACHED

TRANSMITTER TEST SET-UP

- TEST A. OPERATIONAL STABILITY
- TEST B. CARRIER FREQUENCY STABILITY
- TEST C. OPERATIONAL PERFORMANCE STABILITY
- TEST D. HUMIDITY
- TEST E. VIBRATION
- TEST F. ENVIRONMENTAL TEMPERATURE
- TEST G. FREQUENCY STABILITY: TEMPERATURE VARIATION
- TEST H. FREQUENCY STABILITY: VOLTAGE VARIATION

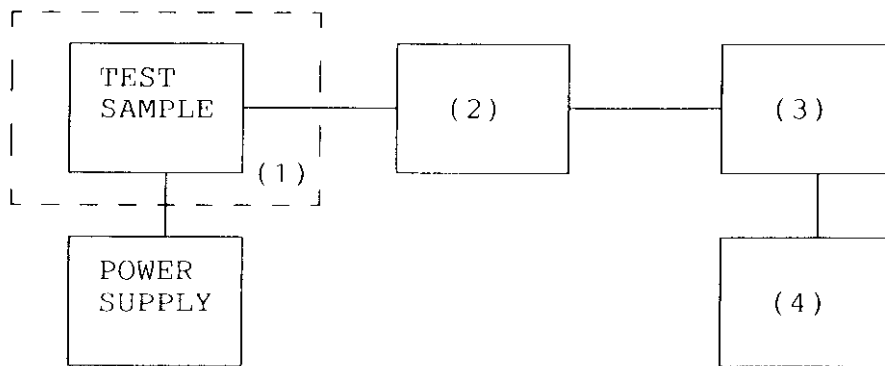

(1) TEMPERATURE, HUMIDITY, VIBRATION

TENNEY TEMPERATURE CHAMBER	<u> x </u>
WEBER HUMIDITY CHAMBER	<u> </u>
L.A.B. RVH 18-100	<u> </u>
_____	<u> </u>

(2) COAXIAL ATTENUATOR

NARDA 766-10	<u> </u>
SIERRA 661A-30	<u> x </u>
BIRD 8329 (30 dB)	<u> x </u>
_____	<u> </u>

(3) R.F. POWER

HP 435A POWER METER	<u> </u>
HP 436A POWER METER	<u> x </u>
HP 8901A POWER METER	<u> x </u>
_____	<u> </u>

(4) FREQUENCY COUNTER

HP 5383A	<u> </u>
HP 5334B	<u> x </u>
HP 8901A	<u> x </u>
_____	<u> </u>

TRANSMITTER FREQUENCY STABILITY
YAESU, VXR-1000V
7 AUG 1998, 10:42

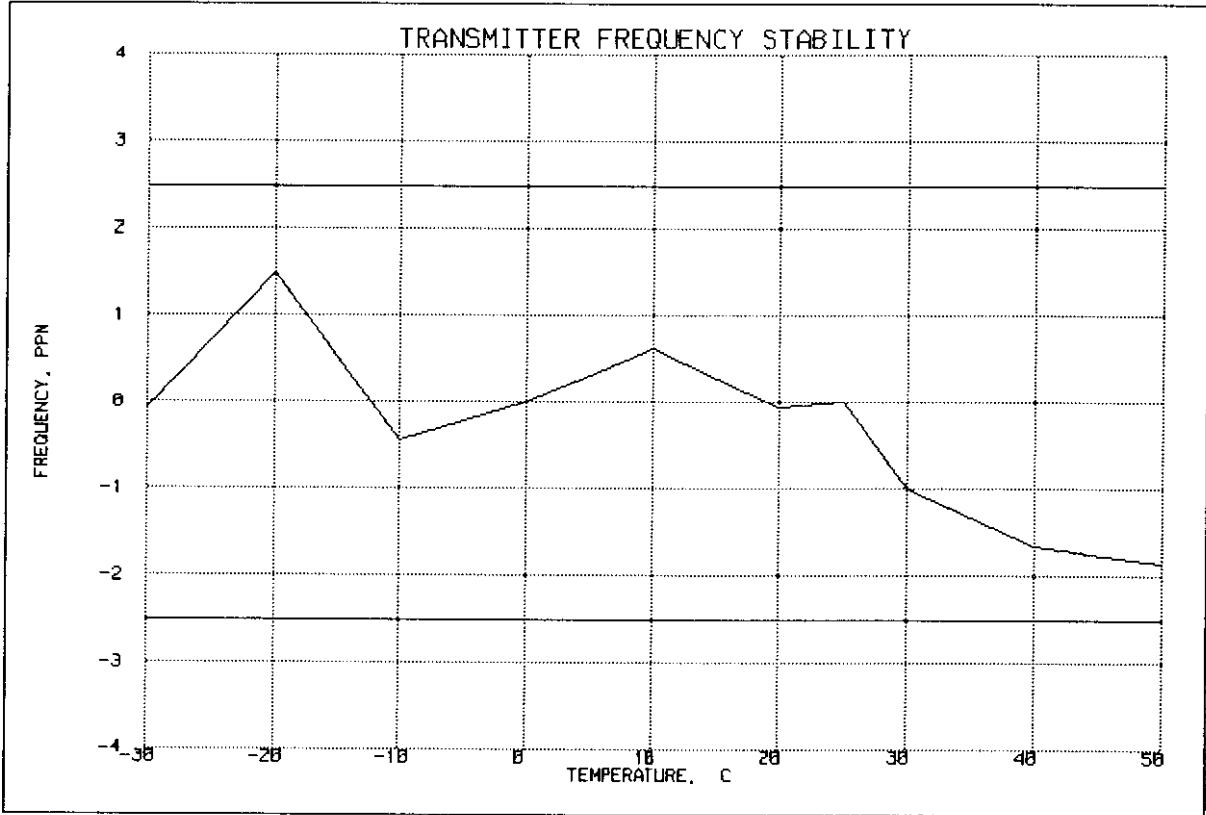

FREQUENCY OF CARRIER, MHz = 162.02507

LIMIT, ppm = 2.5

LIMIT, Hz = 405

SUPERVISED BY:

MORTON FLOM, P. Eng.

PAGE NO. 29. K66VXR-1000V

NAME OF TEST: Frequency Stability (Voltage Variation)

SPECIFICATION: FCC: 47 CFR 2.995 (b)(1)
IC: RSS-119, Section 7.0

GUIDE: TIA/EIA-602, Section 2.2.2

TEST CONDITIONS: As indicated

TEST EQUIPMENT: As per attached page

MEASUREMENT PROCEDURE

1. The EUT was placed in a temperature chamber at 25±5°C and connected as for "Frequency Stability - Temperature Variation" test.
2. The power supply voltage to the EUT was varied from 85% to 115% of the nominal value measured at the input to the EUT.
3. The variation in frequency was measured for the worst case.

MEASUREMENT RESULTS

LIMIT, ppm = 2.5
LIMIT, Hz - 405

STV, %	Vdc	<u>CHANGE IN FREQUENCY, Hz</u>	
85	11.7	162024690	-310
100	13.8	162025000	0
115	15.9	162025000	0
BATTERY END POINT:	11.4	162024330	-670

SUPERVISED BY:

Morton Flom P. Eng.
MORTON FLOM, P. Eng.

PAGE NO.

30.

K66VXR 1000V

NAME OF TEST:

Necessary Bandwidth and Emission Bandwidth

PARAGRAPH:

47 CFR 2.202(g)

MODULATION = 16K0F3E

NECESSARY BANDWIDTH CALCULATION:

MAXIMUM MODULATION (M), kHz = 3
MAXIMUM DEVIATION (D), kHz = 5
CONSTANT FACTOR (K) = 1
NECESSARY BANDWIDTH (B_N), kHz = $(2 \times M) + (2 \times D \times K)$
= 16.0

MODULATION = 11K0F3E

NECESSARY BANDWIDTH CALCULATION:

MAXIMUM MODULATION (M), kHz = 3
MAXIMUM DEVIATION (D), kHz = 2.5
CONSTANT FACTOR (K) = 1
NECESSARY BANDWIDTH (B_N), kHz = $(2 \times M) + (2 \times D \times K)$
= 11.0

SUPERVISED BY:

MORTON FLOM, P. Eng.

TESTIMONIAL
AND
STATEMENT OF CERTIFICATION

K66VXR-1000V

THIS IS TO CERTIFY:

1. THAT the application was prepared either by, or under the direct supervision of, the undersigned.
2. THAT the technical data supplied with the application was taken under my direction and supervision.
3. THAT the data was obtained on representative units, randomly selected.
4. THAT, to the best of my knowledge and belief, the facts set forth in the application and accompanying technical data are true and correct.

CERTIFYING ENGINEER:

MORTON FLOM, P. Eng.

STATEMENT OF QUALIFICATIONS

EDUCATION:

1. B. ENG. in ENGINEERING PHYSICS, 1949, McGill University, Montreal, Canada.
2. Post Graduate Studies, McGill University & Sir George Williams University, Montreal.

PROFESSIONAL AFFILIATIONS:

1. ARIZONA SOCIETY OF PROFESSIONAL ENGINEERS (NSPE), #026 031 821.
2. ORDER OF ENGINEERS (QUEBEC) 1949. #4534.
3. ASSOCIATION OF PROFESSIONAL ENGINEERS, GEOPHYSICISTS & GEOLOGISTS OF ALBERTA #5916.
4. REGISTERED ENGINEERING CONSULTANT - GOVERNMENT OF CANADA, DEPARTMENT OF COMMUNICATIONS. Radio Equipment Approvals.
5. IEEE, Lifetime Member No. 0417204 (member since 1947).

EXPERIENCE:

1. Research/Development/Senior Project Engineer, R.C.A. LIMITED (4 years).
2. Owner/Chief Engineer of Electronics. Design/Manufacturing & Cable TV Companies (10 years).
3. CONSULTING ENGINEER (over 25 years).

MORTON FLOM, P. Eng.