



VX-900

Operating Manual

VERTEX STANDARD CO., LTD.

4-8-8 Nakameguro, Meguro-Ku, Tokyo 153-8644, Japan

VERTEX STANDARD

US Headquarters

17210 Edwards Rd., Cerritos, CA 90703, U.S.A.

International Division

8350 N.W. 52nd Terrace, Suite 201, Miami, FL 33166, U.S.A.

YAESU EUROPE B.V.

P.O. Box 75525, 1118 ZN Schiphol, The Netherlands

YAESU UK LTD.

Unit 12, Sun Valley Business Park, Winnall Close
Winchester, Hampshire, SO23 0LB, U.K.

YAESU GERMANY GmbH

Am Kronberger Hang 2, D-65824 Schwalbach, Germany

VERTEX STANDARD HK LTD.

Unit 5, 20/F., Seaview Centre, 139-141 Hoi Bun Road,
Kwun Tong, Kowloon, Hong Kong

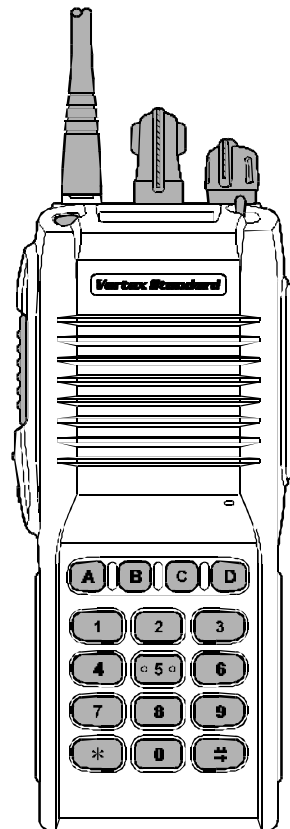

Contents

Warning RF Exposure Compliance	1
Controls & Connectors	2
Before You Begin	4
Battery Pack Installation and Removal	4
Low Battery Indication	4
Operation	5
Preliminary Steps	5
Operation Quick Start	5
Advanced Operation	8
Soft key and TOGGLE switch Functions	8
ARTS (Auto Range Transpond System)	15
DTMF Paging System	15
Understanding Radio Waves	16
Accessories & Options	17

Congratulations!

You now have at your fingertips a valuable communications tool—a **VERTEX STANDARD** two-way radio! Rugged, reliable and easy to use, your **VERTEX STANDARD** radio will keep you in constant touch with your colleagues for years to come, with negligible maintenance down-time.

Please take a few minutes to read this manual carefully. The information presented here will allow you to derive maximum performance from your radio, in case questions arise later on.

We're glad you joined the **VERTEX STANDARD** team. Call on us anytime, because communications is our business. Let us help you get your message across.

Notice!: There are no owner-serviceable parts inside the transceiver. All service jobs must be referred to an authorized **VERTEX STANDARD** Service Representative. Consult your Authorized **VERTEX STANDARD** Dealer for installation of optional accessories.

WARNING! FCC RF Exposure Requirements

FCC RF Exposure Compliance Requirements for Occupational Use Only:

This Radio has been tested and complies with the Federal Communications Commission (FCC) RF exposure limits for Occupational Use/Controlled exposure environment. In addition, it complies with the following Standards and Guidelines:

- FCC 96-326, Guidelines for Evaluating the Environmental Effects of Radio-Frequency Radiation.
 - FCC OET Bulletin 65 Edition 97-01 (1997) Supplement C, Evaluating Compliance with FCC Guidelines for Human Exposure to Radio Frequency Electromagnetic Fields.
 - ANSI/IEEE C95.1-1992, IEEE Standard for Safety Levels with Respect to Human Exposure to Radio Frequency Electromagnetic Fields, 3 kHz to 300 GHz.
 - ANSI/IEEE C95.3-1992, IEEE Recommended Practice for the Measurement of Potentially Hazardous Electromagnetic Fields - RF and Microwave.
- **This radio is NOT approved for use by the general population in an uncontrolled exposure environment. This radio is restricted to occupational use, work related operations only where the radio operator must have the knowledge to control his or her RF exposure conditions.**
 - **When transmitting, hold the radio in a vertical position with its microphone 1 to 2 inches (2.5 to 5 cm) away from your mouth and keep the antenna at least 1 inch (2.5 cm) away from your head and body.**
 - **The radio must be used with a maximum operating duty cycle not exceeding 50%, in typical Push-to-Talk configurations.**
DO NOT transmit for more than 50% of total radio use time (50% duty cycle). Transmitting more than 50% of the time can cause FCC RF exposure compliance requirements to be exceeded.
The radio is transmitting when the red LED on the top of the radio is illuminated. You can cause the radio to transmit by pressing the P-T-T button.
 - **Always use Vertex Standard authorized accessories.**

CONTROLS & CONNECTORS

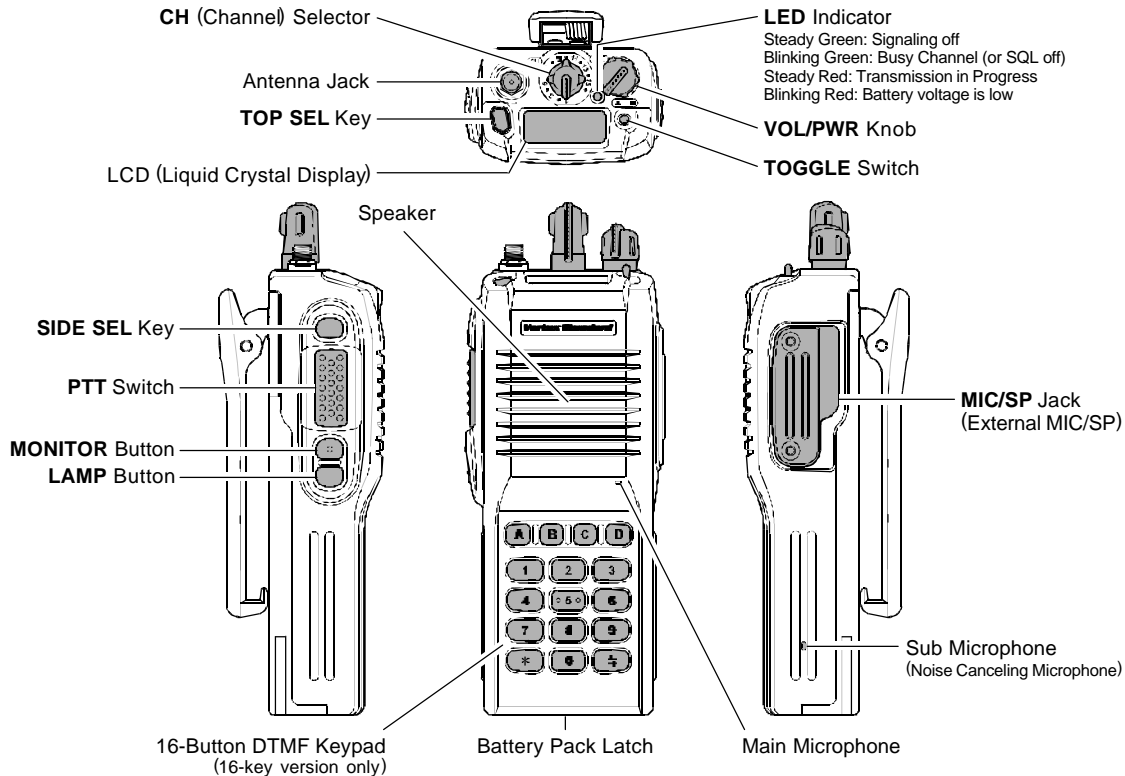

LCD ICONS & INDICATORS

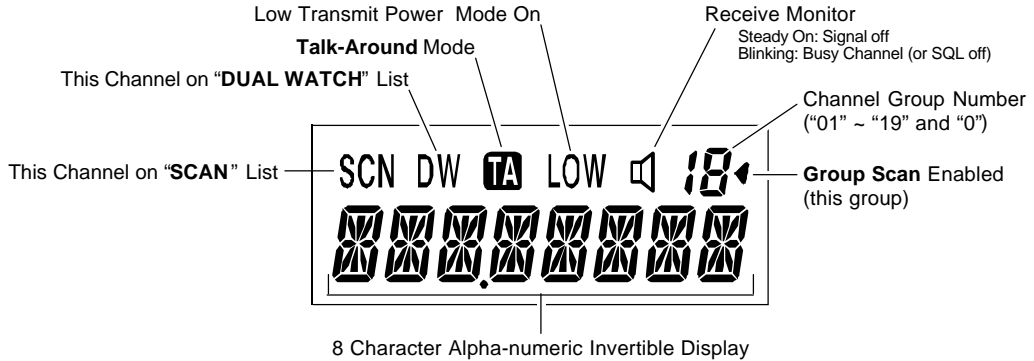

BEFORE YOU BEGIN

Battery Pack Installation and Removal

- ❑ To install the battery, hold the transceiver with your left hand, so your palm is over the speaker and your thumb is on the top of the belt clip. Carefully mate the battery's four insertion slots with their corresponding alignment tabs on the transceiver case, while tilting the Belt Clip outward. Proper alignment occurs with the battery pack offset about 1/2 inch from the top edge of the battery compartment.
- ❑ Guide the pack on to the tabs with a slight inward pressure, then slide the battery pack upward, until it locks in place with a "Click."

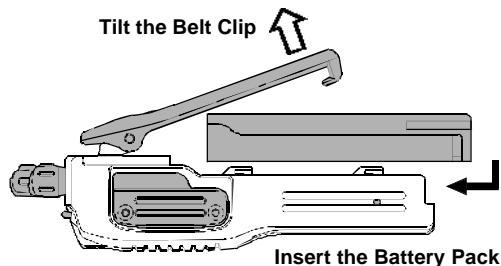

- ❑ To remove the battery, turn the radio off and remove any protective cases. Slide the **Battery Pack Latch** on the bottom of the radio toward the front panel while sliding the battery down about 1/2 inch. Then lift the battery out from the radio while unfolding the Belt Clip.



Do not attempt to open any of the rechargeable Lithium-Ion packs, as they could explode if accidentally short-circuited.

Low Battery Indication

As the battery discharges during use, the voltage gradually becomes lower. When the battery voltage reaches 6.0 volts, it is time to substitute a freshly charged battery and recharge the depleted pack. The **LED** indicator on the top of the radio will blink red when the battery voltage is low (6 Volts or lower).

Caution

Danger of explosion if battery is replaced with an incorrect battery. Replace only with the same or equivalent type.

OPERATION

Preliminary Steps

- ❑ Install a charged battery pack onto the transceiver, as described previously.
- ❑ Screw the supplied antenna onto the Antenna jack. Never attempt to operate this transceiver without an antenna connected.
- ❑ If you have a Speaker/Microphone, we recommend that it not be connected until you are familiar with the basic operation of the **VX-900**.

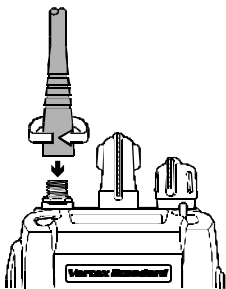

Quick Start

- ❑ Turn the top panel's **VOL/PWR** knob clockwise to turn on the radio on.

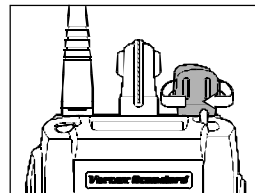

- ❑ Turn the top panel's **CH** selector knob to choose the desired operating channel. A channel name will appear on the LCD. If you want to select the operating channel from a different Memory Channel Group, press the **Soft** key (assigned to the Memory Group Up or Down function) to select the Memory Channel Group you want before selecting the operating channel. A Group name will appear on the LCD whenever the **Soft** key is pressed.

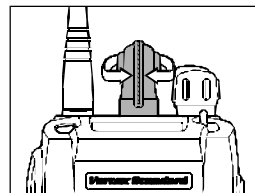

Note: Some models are programmed so that the operating channels are selected by the **Soft** key and the memory channel group is selected by the **CH** selector knob. For further details, contact your **VERTEX STANDARD** dealer.

OPERATION

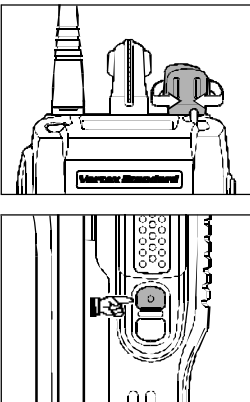
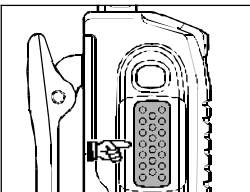
- ❑ Rotate the **VOL/PWR** knob to set the volume level. If no signal is present, press and hold in the **MONITOR** button (under the **PTT** switch) more than 2 seconds; background noise will now be heard, and you may use this to set the **VOL/PWR** knob for the desired audio level. Press and hold the **MONITOR** button more than 2 seconds (or press the **MONITOR** button twice) to quiet the noise and resume normal (quiet) monitoring.
- ❑ To transmit, press and hold the **PTT** switch. Speak into the microphone area of the front panel grille (above the **[D]** key) in a normal voice level. To return to the Receive mode, release the **PTT** switch.

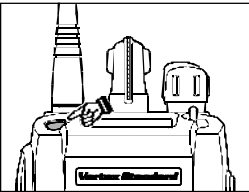
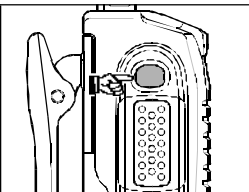
- ❑ Press the **Soft** key (if assigned to the Scan function) or switch the **TOGGLE** Switch to the assigned "Scan" position (when so programmed by your dealer) to start the scanner. The scanner rapidly steps through each of the dealer-programmed channels, looking for incoming calls.
- ❑ Press the **TOP SEL** key (on the top panel) or **SIDE SEL** key (the top button on the left side) to activate one of the preprogrammed functions which may have been enabled at the time of programming by the dealer. Similarly, when using the 16-key version, the **[A]**, **[B]**, **[C]**, and **[D]** function keys may activate one of these features, if programmed by the dealer. See the next section for details regarding the available features.

OPERATION

- ❑ Switch the top panel's **TOGGLE** switch to the [A], [B], or [Center] position to activate one of the pre-programmed functions which may have been enabled at the time of programming by the dealer. When this switch is in the [A (left)], [B (right)], or [Center] position, the feature programmed (by your dealer) to that switch position will be activated. See the next section for details regarding the available features.
- ❑ Press the **DTMF** keys on the telephone keypad while pressing the **PTT** switch to send DTMF tones (16-key version only).

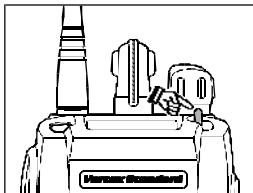

- ❑ If a Speaker/Microphone is available, remove the plastic cap and its two mounting screws from the right side of the transceiver, then align the connector of the Speaker/Microphone on the transceiver body; secure the connector pin using the screws supplied with the Speaker/Microphone. Hold the speaker grille up next to your ear while receiving. To transmit, press the **PTT** switch on the Speaker/Microphone, just as you would on the main transceiver's body, and speak into the microphone on a normal voice level.

***Note:** Save the original plastic cap and its mounting screws. They should be reinstalled when not using the Speaker/Microphone.*

ADVANCED OPERATION

Soft key and TOGGLE switch Functions

The **VX-900** includes the [TOP SEL], [SIDE SEL], [MONITOR], and [LAMP] keys, and the **TOGGLE** switch, while the 16-key version additionally provides [A], [B], [C], [D] function keys. The **Soft** key and **TOGGLE** switch functions can be customized, via programming by your **VERTEX STANDARD** dealer, to meet your communications/network requirements. Some features may require the purchase and installation of optional internal accessories. The possible **Soft** key and **TOGGLE** switch programming features are illustrated at the right, and their functions are explained on page 10. For further details, contact your **VERTEX STANDARD** dealer.

For future reference, check the box next to each function that has been assigned to the **Soft** key and **TOGGLE** switch on your particular radio, and keep it handy.

Functions	TOGGLE switch (Position)		
	A	center	B
None			
Channel Scan			
Dual Watch			
High/Low Power			
Talk Around			
TX Save Disable			
LCD Invert			
Encryption Disable*			
Lock			
Follow-Me Scan			
Group Recall Shortcut	<input type="checkbox"/> Group 1 <input type="checkbox"/> Group 2 <input type="checkbox"/> Group 3	<input type="checkbox"/> Group 1 <input type="checkbox"/> Group 2 <input type="checkbox"/> Group 3	<input type="checkbox"/> Group 1 <input type="checkbox"/> Group 2 <input type="checkbox"/> Group 3

*: Requires **FVP-25** DTMF/Encryption Unit

ADVANCED OPERATION

Functions	Soft key							
	TOP SEL	SIDE SEL	MONITOR	LAMP	[A]	[B]	[C]	[D]
None								
Channel Scan								
Dual Watch								
High/Low Power								
Talk Around								
TX Save Disable								
LCD Invert								
Encryption Disable*								
Follow-Me DW								
Call/Reset*								
Speed Dial								
Emergency								
Group Up								
Group Down								
Channel Up								
Channel Down								
Monitor								
Lamp								

※: Requires **FVP-25** DTMF/Encryption Unit

ADVANCED OPERATION

Description of Operating Functions

Channel Scan

The Scanning feature is used to monitor multiple channels programmed into the transceiver. While scanning, the transceiver will check each channel for the presence of a signal, and will stop on a channel if a signal is present.

One key or switch may be assigned to the **Scan** function, as follows:

- One of the **Soft** keys may be assigned for **Scan** operation; or
- The **TOGGLE** switch may have one position assigned to the **Scan** function.

To activate scanning:

- Press the assigned **Soft** key, or set the **TOGGLE** switch to the assigned position.
- The scanner will search the channels, looking for active ones; it will pause each time it finds a channel on which someone is speaking.

To stop scanning:

- Press the assigned **Soft** key, or set the **TOGGLE** switch to a different position.
- Operation will revert to the channel to which the **CH** knob is set.

Note: Your dealer may have programmed your radio to stay on one of the following channels if you press the **PTT** switch during scanning pause:

- Current channel (“Talk Back”)
- “Last Busy” channel
- “Priority” channel
- “Home” channel
- “Scan Start” channel

Dual Watch

The **Dual Watch** feature is similar to the **Scan** feature, except that only two channels are monitored:

- The current operating channel; and
- The “Priority” channel.

To activate Dual Watch:

- Press the assigned **Soft** key, or set the **TOGGLE** switch to the assigned position.
- The scanner will search the two channels; it will pause each time it finds a channel on which someone is speaking.

To stop Dual Watch:

- Press the assigned **Soft** key, or set the **TOGGLE** switch to a different position.
- Operation will revert to the channel to which the **CH** knob is set.

ADVANCED OPERATION

Low Power

Press the assigned **Soft** key or switch the **TOGGLE** switch to the assigned position to set the radio's transmitter to the "Low Power" mode, thus extending battery life. Press the assigned **Soft** key again or switch the **TOGGLE** switch to the other Position to return to "High Power" operation when in difficult terrain.

Talk Around

Press the assigned **Soft** key or switch the **TOGGLE** switch to the assigned position to activate the Talk Around feature when you are operating on duplex channel systems (separate receive and transmit frequencies, utilizing a "repeater" station). The Talk Around feature allows you to bypass the repeater station and talk directly to a station that is nearby. This feature has no effect when you are operating on "simplex" channels, where the receive and transmit frequencies are already the same.

Note that your dealer may have made provision for "Talk Around" channels by programming "repeater" and "Talk Around" frequencies on two adjacent channels. If so, the key may be used for one of the other Pre-Programmed Functions.

TX Save Disable

Press the assigned **Soft** key or switch the **TOGGLE** switch to the assigned position to disable the Transmit Battery Saver, if you are operating in a location where high power is almost always needed.

The Transmit Battery Saver helps extend battery life by reducing transmit power when a very strong signal from an apparently nearby station is being received. Under some circumstances, though, your hand-held radio may not be heard well at the other end of the communication path, and high power may be necessary at all times.

LCD Invert

Press the assigned **Soft** key or switch the **TOGGLE** switch to the assigned position to invert the LCD display to backward-facing readout (the backward display is convenient for viewing when wearing the transceiver on your belt). Press the assigned **Soft** key again or switch the **TOGGLE** switch to the other position to return the LCD display to frontward-facing readout.

ADVANCED OPERATION

Encryption Disable

Press the assigned **Soft** key or switch the **TOGGLE** switch to the assigned position to turn off the optional voice encryption unit temporarily, for use when an incorrect setting of (or failure in) the encryption system at one end of the communication path has made it impossible to talk to the other station.

Remember that disabling the encryption will mean that your transmissions are no longer secure. Return to the encrypted mode as soon as possible, and do not discuss any critical or confidential information while in the non-encrypted mode of operation.

Lock

Switch the **TOGGLE** switch to lock the top-panel keys; this can be enabled to prevent radio settings from being disturbed.

Follow-Me Scan

“Follow-Me” Scan feature checks a User-assigned Priority Channel regularly as you scan the other channels. Thus, if only Channels 1, 3, and 5 (of the 8 available channels) are designated for “Scanning,” the user may nonetheless assign Channel 2 as the “User-assigned” Priority Channel via the “Follow-Me” feature.

To activate “Follow-Me” scanning, first select the channel you want to designate as the “User-Assigned Priority Channel” and switch the **TOGGLE** switch to the assigned position. Then turn the **CH** selector knob to the “Scanning Start” channel which has been programmed by your dealer to activate the scanner. When the scanner stops on an “Active” channel, the User-assigned Priority Channel will automatically be checked every few seconds; if activity is found on the User-assigned Priority Channel, the radio will switch between it and the Dealer-Assigned Priority Channel, if any.

Follow-Me DW

To set up a “Dual Watch” frequency pair using the “Follow-Me” feature, select a channel using the **CH** selector knob. Now press the assigned **Soft** key; pressing the assigned **Soft** key locks the current channel as the User-assigned Priority Channel. Now rotate the **CH** selector knob to another channel (not the “Scanning Start” channel). Your radio will now switch back-and-forth between the currently-selected channel (shown on the **CH** selector knob) and the User-assigned Priority Channel.

During “Follow-Me” scanning (after you have

ADVANCED OPERATION

pressed the key), you can set up the “Dual Watch” feature by rotating the **CH** selector knob to another channel. The radio will then scan back and forth between the original User-assigned Priority Channel and the newly-selected channel.

The Priority Channel you have assigned (before pressing the key) will be retained in memory until you change it.

Channel Group Selection

The **VX-900** is capable of separating its 512 memory channels into any of 20 Groups. There is no limit as to the number of channels which may be assigned to each Group. The Dealer will have made the Group assignment at the time of channel programming. At the same time, one of the **Soft** keys will be assigned as the Channel Group Selection key.

To change Channel Groups, press the assigned **Soft** key to step through the available Groups. Once the desired Group is reached, rotate the **CH** selector knob to select the desired channel within the selected Group.

You may wish to have the Scanner (described previously) pass through more than one Group during the scanning process (normally, scanning

is performed within the current group only). To include the current Group in the scanning loop, **press and hold in** the assigned **Soft** key for one second.

To remove a Group from Group Scan, press and hold in the assigned **Soft** key again for one second.

Multi-Group Scanning is only possible if you are using the “User Scan” list.

The **VX-900** has two scanning “lists:” the “Dealer Scan” list and the “User Scan” list. The “Dealer Scan” list is a fixed group of stations which will be included when scanning is activated. The “User Scan” list is a different list, initially arranged by the Dealer, which may be modified by the User (if, for example, you want to delete one or more of these channels from the scanning list).

To edit the User Scan list, press and hold the soft key (assigned to the Group Up/Down function) to delete the current Memory Group from the Scanning. Alternatively, press and hold the “Scan” **Soft** key for one second to delete the Current Memory channel from the Scanning.

When you delete a Group or channel, “-SKIP-” will appear on the LCD for one second after press-

ADVANCED OPERATION

ing the **Soft** key. To restore a particular channel to your scanning list, press and hold in the **Soft** key again for one second; “- STOP -” will appear on the LCD for one second after pressing the **Soft** key.

Call/Reset

This feature, if enabled, allows the user to change the 3-digit Page Call code, used to call other similarly-equipped stations. Press the Dealer-assigned **Soft** key, followed by the three digits representing the Page Call code of the station you wish to call. Three tones will be heard after the last key is pressed (the new code will now be transmitted).

The receiver squelch of the other station will be opened, and you can begin communication.

Speed Dial

Your Dealer may have pre-programmed Auto-Dial telephone number memories into your radio.

To dial a number, press the Dealer-assigned **Soft** key for Speed Dialing, then press the numbered key corresponding to the Auto-Dial memory number list provided by your Dealer. The DTMF tones sent during the dialing sequence will be heard in the speaker.

Emergency

The **VX-900** includes an “Emergency” feature which may be useful if you have someone monitoring on the same frequency as your transceiver’s channel. For further details contact your **VERTX STANDARD** dealer.

ADVANCED OPERATION

ARTS (Auto Range Transpond System)

This system is designed to inform you when you and another ARTS-equipped station are within communication range.

During ARTS operation, your radio automatically transmits for about 1 second every 25 seconds (the interval is programmed by the Dealer) in an attempt to shake hands with the other station.

If you move out of range for more than two minutes, your radio senses that no signal has been received, a ringing beeper will sound, and “**OUT OF SERVICE**” will scroll on the LCD. If you subsequently move back into range, as soon as the other station transmits, your beeper will sound, and “**IN SERVICE**” will scroll on the LCD.

DTMF Paging System

This system allows paging and selective calling, using DTMF tone sequences.

When your radio is paged by a station bearing a tone sequence which matches yours, your radio’s squelch will open and the alert ringer will sound.

The three-digit code of the station which paged you will be displayed on your radio’s LCD.

UNDERSTANDING RADIO WAVES

Radio waves travel from one point to another by several different means. The general term for these methods of wave travel is “propagation.” You may know that “shortwave” signals can be propagated over distances of several thousand miles by reflection off of the upper regions of the atmosphere.

Your hand-held transceiver, on the other hand, operates on the so-called VHF (Very-High Frequency) or UHF (Ultra-High Frequency) bands. On these bands, radio waves usually do not reflect off of the atmosphere. Instead, the radio waves behave almost as light: they travel in a straight line, and when they meet a building or obstruction, they go no further in that direction.

Therefore, it is important that you be as high and free from obstructions as possible to cover the greatest distance when using your radio. If you operate from inside a car or building, any metal around you can absorb much of the signal, both transmitted and received. Coverage may therefore be very poor under those conditions. However, if you must operate from indoors, moving next to a window will improve communications.

In view of the factors just discussed, you can easily see the potential benefit of holding the radio up high near your mouth while transmitting. In this way the antenna is high and clear, and coverage is best.

One final note regarding propagation is useful in improving coverage. Because radio waves at VHF/UHF are similar to light waves, they do reflect, to varying degrees, off of hills, buildings, and the like. In a crowded urban area, with many close buildings close together, many reflections may occur, and interfere with one another, causing variations in signal strength at different locations.

Therefore, if a signal is weak and you walk a few feet in any direction, reception may suddenly become clear, because a particular reflection path may become dominant. Reflections are frequently useful, as they can allow for communications between two stations over a highly obstructed path.

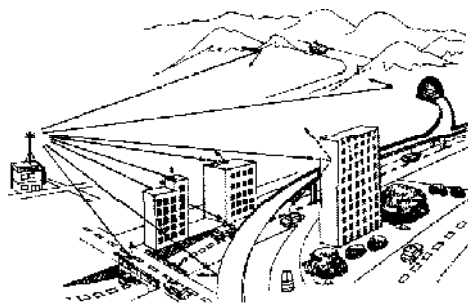

ACCESSORIES & OPTIONS

FVP-25	Encryption/DTMF Pager Unit	CE39	Programming Software
F2D-8	2-Tone Decode Unit	CT-70	Radio Programming Cable (Requires VPL-1)
F5D-14	5-Tone ENC/DEC Unit	CT-71	PC Programming Cable
FNB-V68LI	7.4 V 1800 mAh Lithium-Ion Battery	CT-72	Radio to Radio Programming Cable
FNB-V69LI	7.4 V 2400 mAh Lithium-Ion Battery		
FBA-27	Alkaline Battery Case (6 x AA)		
VAC-900	Rapid Desktop Charger	ATV-6A	VHF Antenna, 134 ~ 151 MHz (Stubby)
VAC-6900	6-Unit Multi Charger	ATV-6B	VHF Antenna, 150 ~ 163 MHz (Stubby)
VCM-1	Mobile Mounting Bracket	ATV-6C	VHF Antenna, 161 ~ 174 MHz (Stubby)
VTP-50	VX-Trunk Unit	ATV-6XL	VHF Antenna, 134 ~ 174 MHz (Untuned)
MH-50_{A7A}	Speaker/Microphone (Noise Canceling)	ATU-6A	UHF Antenna, 400 ~ 430 MHz
VH-110	Over the Head, Heavy Duty Headset	ATU-6C	UHF Antenna, 440 ~ 470 MHz
VH-120	3-Wire Earpiece, Mic, Palm PTT Switch	ATU-6D	UHF Antenna, 450 ~ 485 MHz
VH-130	2-Wire Earpiece, Palm Mic/PTT Combo		
VH-140	DSP VOX Earpiece Microphone		
VH-150	DSP VOX Bone-vibration Headset		
VH-160	Earpiece, Mic, Body PTT System		
VH-170	Bone-vibration Headset		

*Availability of accessories may vary; some accessories are supplied standard per local requirements, others may be unavailable in some regions. Check with your **VERTEX STANDARD Dealer** for changes to the this list.*

This device complies with Part 15 of the FCC rules.
Operation is subject to the condition that this device
does not cause harmful interference.



Copyright 2000
VERTEX STANDARD CO., LTD.
All rights reserved.

No portion of this manual
may be reproduced
without the permission of
VERTEX STANDARD CO., LTD.

Printed in Japan

0012P-AE

