

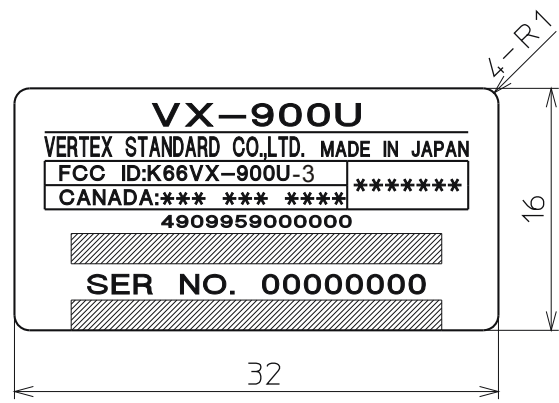

360 Herndon Parkway
Suite 1400
Herndon, VA 20170
<http://www.rheintech.com>

21 LABEL INFORMATION

Please see the following page

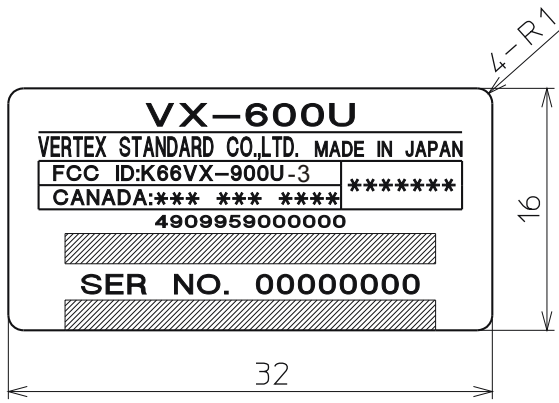

FCC Operational Requirement

This device complies with 15 of the FCC Rules.
 Operation is subject to condition that
 this device does not cause harmful interference.

VERTEX STANDARD K66-VX-900U-3 FCC LABEL POSITION

REAR SIDE PANEL

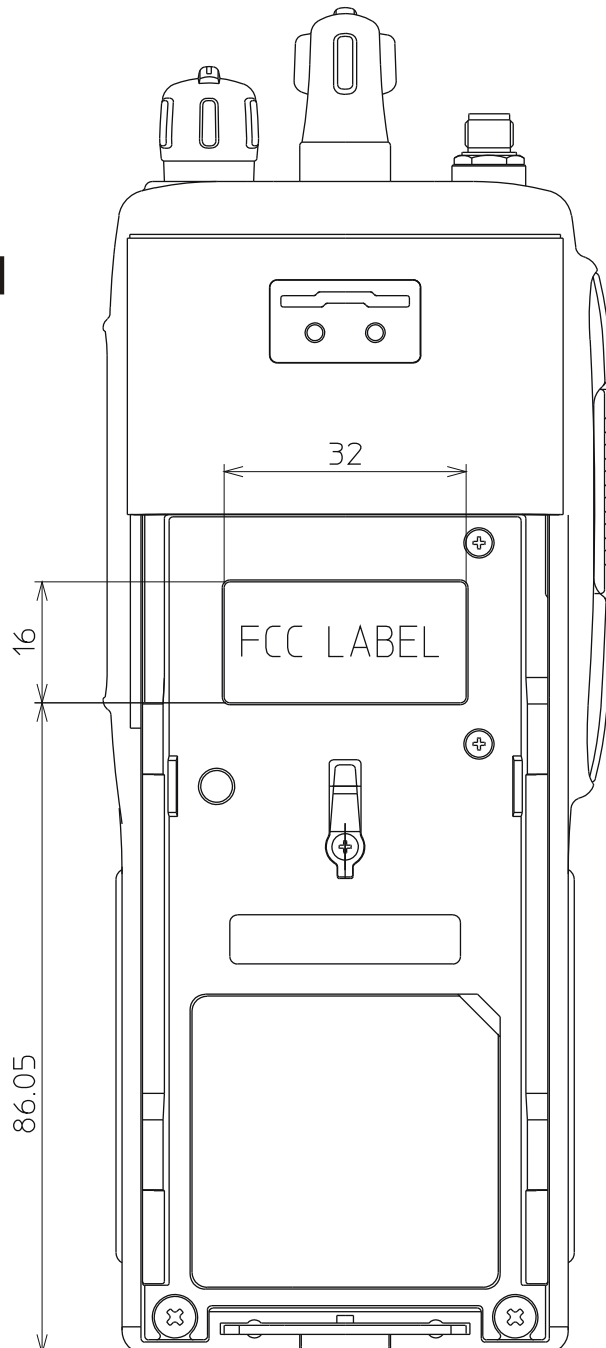

Label Drawing

Font Size: 8point

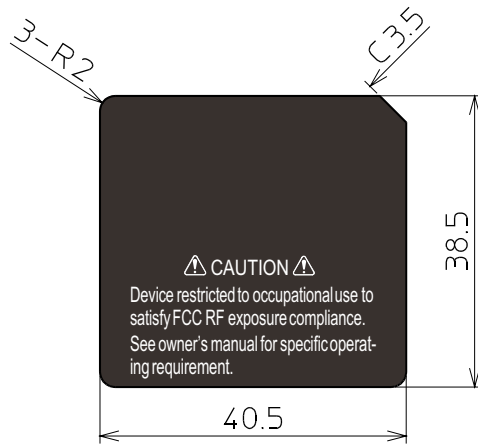

K66VX-900U-3

CAUTION LABEL POSITION

REAR SIDE PANEL

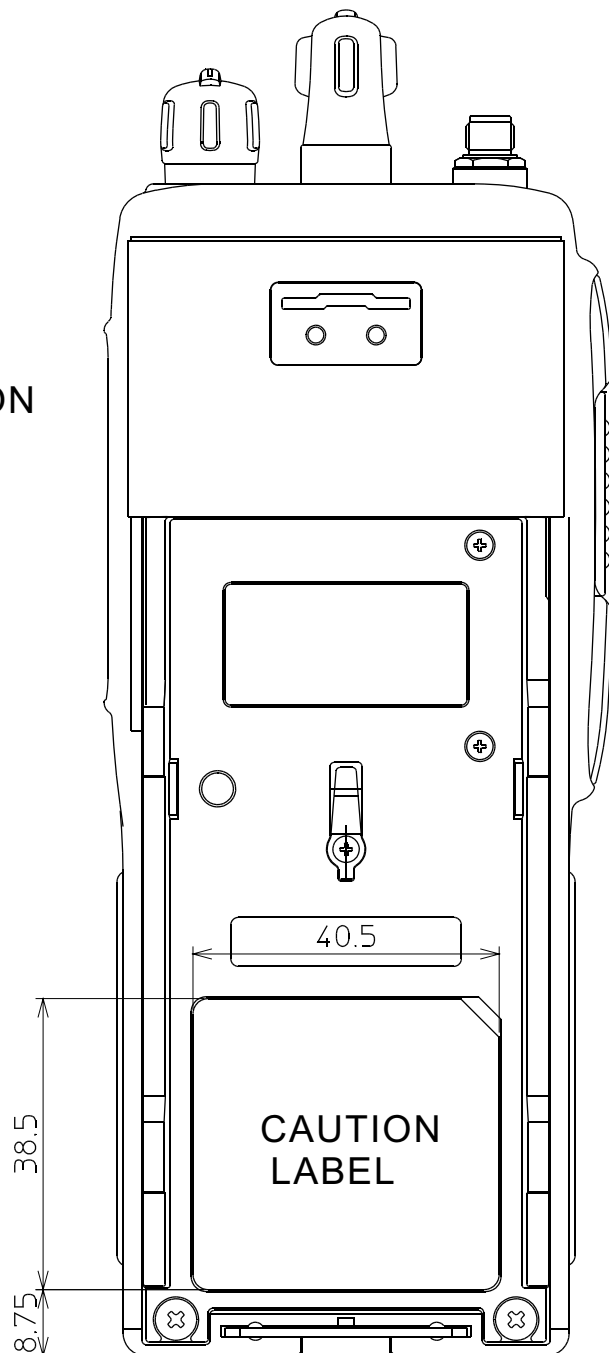

May 21st, 2001

Federal Communications Commission
Authorization and Evaluation Division,
7435 Oakland Mills Road
Columbia, MD 21045
USA

Re: VX-900U / VX-600U (FCC ID: K66VX-900U-3)

Gentlemen:

A. Part 15 · 19 & 15 · 21 Compliance Statement Drawing:

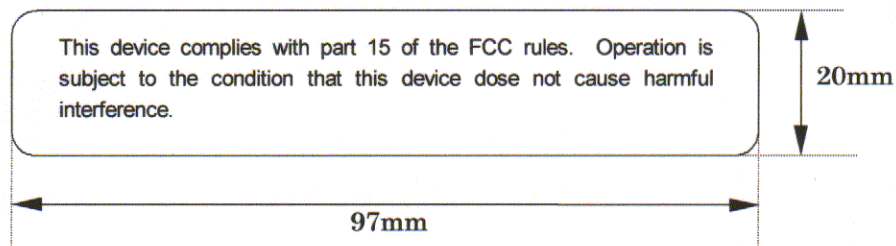

B. Part 15 · 19 & 15 · 21 Compliance Statement Drawing Location:

IN OPERATION MANUAL (location on inside back cover)

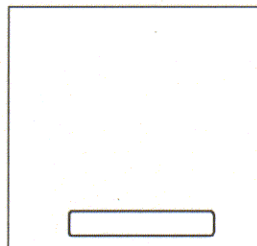

Sincerely,

VERTEX STANDARD CO., LTD.

Mr. Tomiro Ohmoto
General Manager of Export Department