

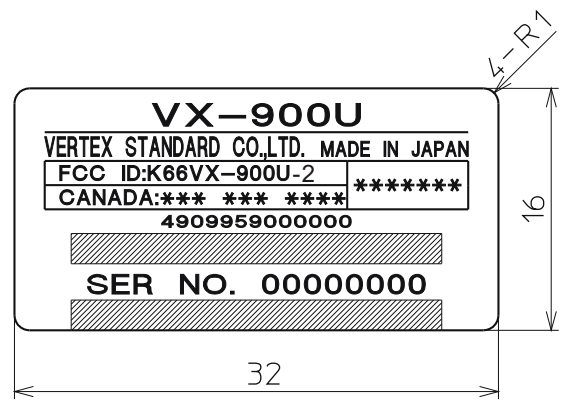

360 Herndon Parkway  
Suite 1400  
Herndon, VA 20170  
<http://www.rheintech.com>

## 21 LABEL INFORMATION

Please see the following page

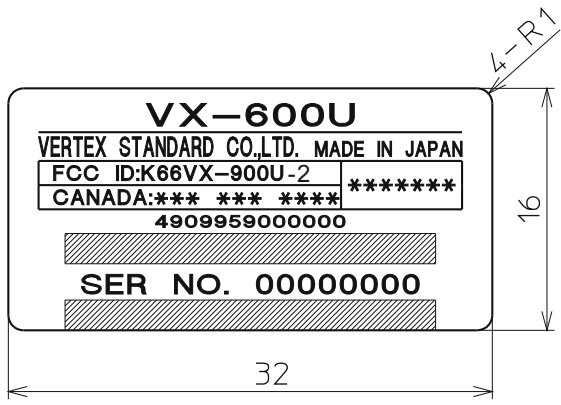

## FCC Operational Requirement

This device complies with 15 of the FCC Rules.  
 Operation is subject to condition that  
 this device does not cause harmful interference.

## VERTEX STANDARD K66-VX-900U-2 FCC LABEL POSITION

REAR SIDE PANEL

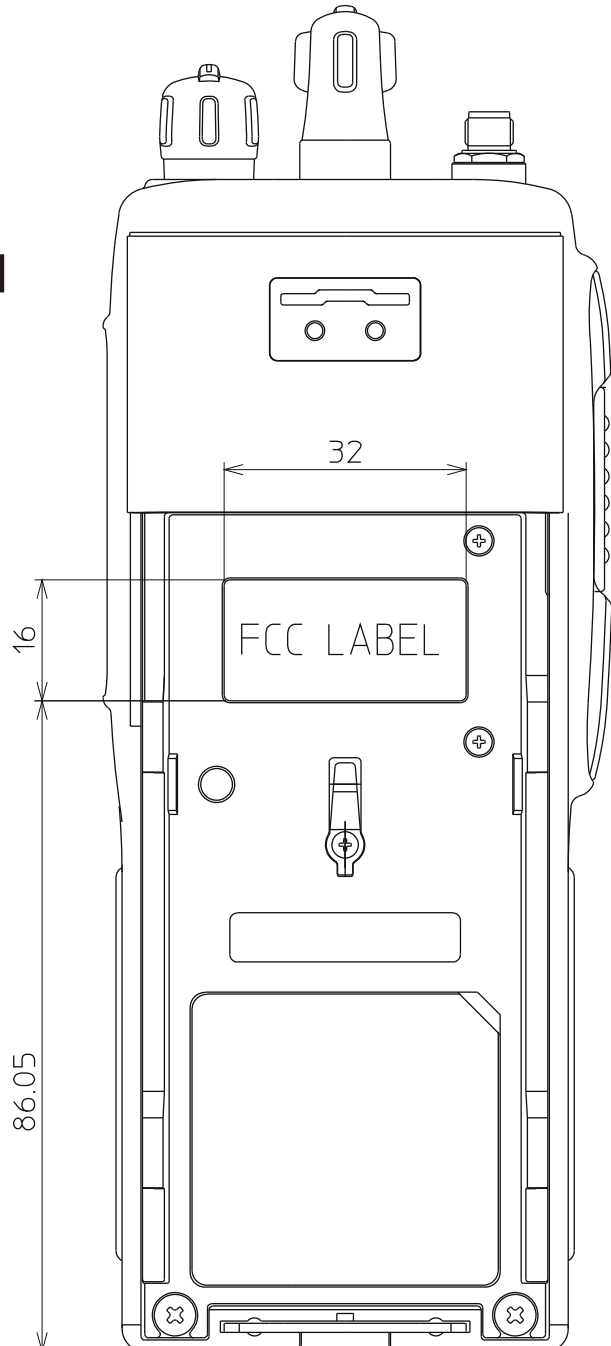



**VERTEX STANDARD CO., LTD.**

4-8-8, Nakameguro, Meguro-ku, Tokyo 153-8644, Japan  
Tel: 81-(0)3-5725-6122 • Fax: 81-(0)3-5725-6205

March 29th, 2001

Federal Communications Commission  
Authorization and Evaluation Division,  
7435 Oakland Mills Road  
Columbia, MD 21045  
USA

Re: VX-900U / VX-600U (FCC ID: K66VX-900U-2)

Gentlemen:

The equipment meets the requirements of the FCC Rules, Part 90.203(e) and (g), as applicable.

Programming of this product's transmit frequencies can be performed ONLY by the manufacturer or by service or maintenance personal. The operator cannot be program transmit frequencies using the equipment's external operation controls.

Sincerely,

VERTEX STANDARD CO., LTD.

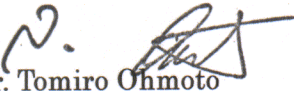
  
Mr. Tomiro Ohmoto  
General Manager of Export Department

March 29th, 2001

Federal Communications Commission  
Authorization and Evaluation Division,  
7435 Oakland Mills Road  
Columbia, MD 21045  
USA

Re: VX-900U / VX-600U (FCC ID: K66VX-900U-2)

Gentlemen:

A. Part 15 · 19 & 15 · 21 Compliance Statement Drawing:

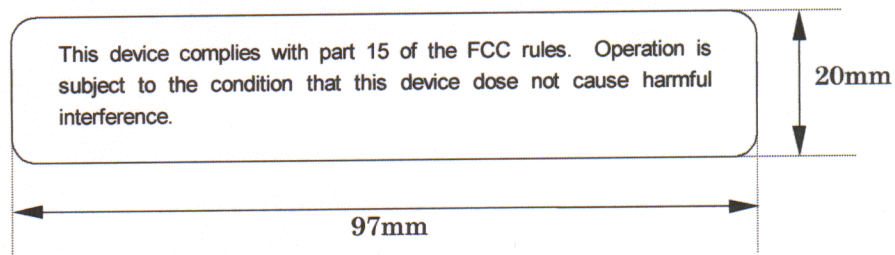

B. Part 15 · 19 & 15 · 21 Compliance Statement Drawing Location:

IN OPERATION MANUAL (location on inside back cover)

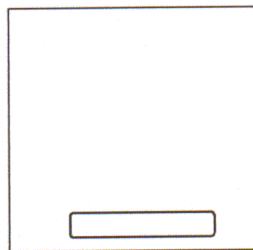

Sincerely,

VERTEX STANDARD CO., LTD.

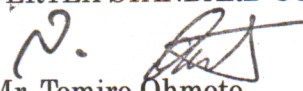

Mr. Tomiro Ohmoto  
General Manager of Export Department