

VX-5500V Alignment

The VX-5500 has been carefully aligned at the factory for the specified performance across the frequency range specified for each version.

Realignment should therefore not be necessary except in the event of a component failure, or alteration of version. All component replacement and service should be performed only by an authorized VERTEX STANDSRD representative, or the warranty policy may be voided.

The following procedures cover the sometimes critical and tedious adjustments that are not normally required once the transceiver has left the factory. However, if damage occurs and some parts are replaced, realignment may be required. If a sudden problem occurs during normal operation, it is likely due to component failure; realignment should not be done until after the faulty component has been replaced.

We recommend that servicing be performed only by authorized VERTEX STANDARD service technicians who are experienced with the circuitry and fully equipped for repair and alignment. Therefore, if a fault is suspected, contact the dealer from whom the transceiver was purchased for instructions regarding repair. Authorized VERTEX STANDARD service technicians realign all circuits and make complete performance checks to ensure compliance with factory specifications after replacing any faulty components. Those who do undertake any of the following alignments are cautioned to proceed at their own risk. Problems caused by unauthorized attempts at realignment are not covered by the warranty policy. Also, VERTEX STANDARD must reserve the right to change circuits and alignment procedures in the interest of improved performance, without notifying owners. Under no circumstances should any alignment be attempted unless the normal function and operation of the transceiver are clearly understood, the cause of the malfunction has been clearly pinpointed and any faulty components replaced, and the need for realignment determined to be absolutely necessary. The following test equipment (and thorough familiarity with its correct use) is necessary for complete realignment. Correction of problems caused by misalignment resulting from use of improper test equipment is not covered under the warranty policy. While most steps do not require all of the equipment listed, the interactions of some adjustments may require that more complex adjustments be performed afterwards. Do not attempt to perform only a single step unless it is clearly isolated electrically from all other steps. Have all test equipment ready before beginning, and follow all of the steps in a section in the order presented.

Required Test Equipment

RF signal generator: calibrated output level at 1000 MHz (0 dB μ = 1.0 μ V - closed circuit)

Deviation Meter (linear detector)

AF Millivoltmeter

SINAD Meter

Inline Wattmeter with 5% accuracy at 1000 MHz

Regulated DC Power Supply: adjustable from 10 to 17 VDC, 15A

50 Ω Non-reactive Dummy Load: 100W at 1000 MHz

Frequency Counter: >0.1-ppm accuracy at 1000 MHz

AF Signal Generator

DC Voltmeter: high impedance

RF Sampling Coupler (attenuation pad)

AF Dummy Load: 4 Ω , 20W

Oscilloscope

Spectrum Analyzer

IBM PC/compatible computer w/ VERTEX STANDARD CT-71 programming cable and CE-35 channel programming editor.

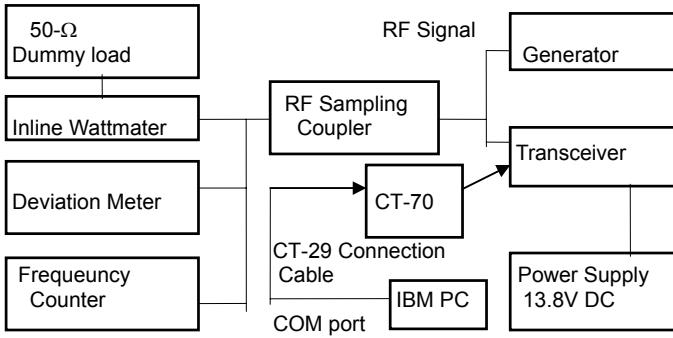

Alignment Preparation & Precautions

A dummy load and inline wattmeter must be connected to the main antenna jack in all procedures that call for transmission, except where specified otherwise. Correct alignment is not possible with an antenna. After completing one step, read the following step to determine whether the same test equipment will be required. If not, remove the test equipment (except dummy load and wattmeter, if connected) before proceeding.

Correct alignment requires that the ambient temperature be the same as that of the transceiver and test equipment, and that this temperature be held constant between 20 and 30 °C (68 and 86 °F). When the transceiver is brought into the shop from hot or cold air it should be allowed some time for thermal equalization with the environment before alignment. If possible, alignments should be made with oscillator shields and circuit boards firmly affixed in place. Also, the test equipment must be thoroughly warmed up before beginning.

Before beginning, connect the transceiver and PC using the CT-71 programming cable as described in the EEPROM Programming chapter, and download the EEPROM data from the transceiver to the computer.

Store this data in a disk file so that it can be saved and retrieved later. Using the table below, program the channel, CTCSS, and DCS alignment settings for your transceiver version. Upload this file to the transceiver.

Note: Signal levels in dB referred to in this procedure are based on 0 dBm = 0.5 μV (closed circuit).

Caution: Do not connect this line to ground, and be certain that the speaker has adequate capability to handle the audio output from the radio.

Because of the bridge audio amplifier circuit used in the radio, it is necessary to construct and use a simple audio load test adapter as shown in the schematic diagram above, when conducting receiver alignment steps.

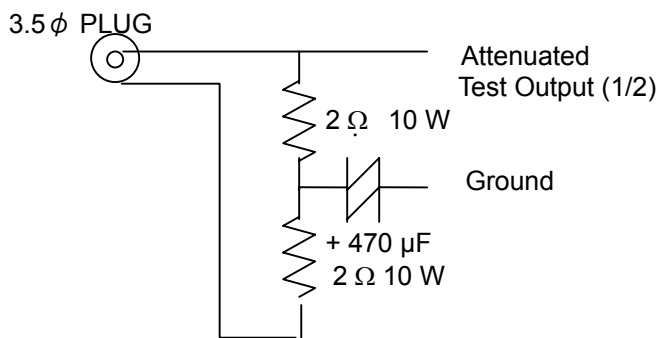

AF Test Adapter Schematic

Alignment Channel Frequencies

Channel	Frequency (simplex)	CTCSS Encode	DCS Encode	Narrow /wide
CH1	148.01MHz	None	None	Wide
CH2	161.01MHz	None	None	Wide
CH3	173.99MHz	None	None	Wide
CH4	148.01MHz	None	None	Narrow
CH5	161.01MHz	None	None	Narrow
CH6	173.99MHz	None	None	Narrow
CH7	161.01MHz	151.4Hz	None	Wide
CH8	161.01MHz	None	023	Wide
CH9	161.01MHz	151.4Hz	None	Narrow
CH10	161.01MHz	None	023	Narrow

PLL & Transmitter

Set up the test equipment as shown for transmitter alignment. Maintain the supply voltage at 13.8 V DC for all steps.

PLL VCV

Connect the positive lead of the DC voltmeter to the test point TP1011 (VCV) on the Main Unit, as indicated in the figure, and the negative lead to chassis ground.

Set the transceiver to the high band edge frequency channel, then adjust coil L1023 on the Unit for 4.2 V on the voltmeter.

Key the transmitter, and adjust coil L1026 on the Unit for 4.2 V on the voltmeter.

Next select to the low edge frequency channel and confirm about 1.0 V (0.8V - 1.2V) on the voltmeter.

Key the transmitter, and confirm about 1.0 V (0.8 V - 1.2 V) on the voltmeter.

PLL Reference Frequency

With the wattmeter, dummy load and frequency counter connected to the antenna jack, and select band center frequency channel, key the transmitter and adjust VR1001 on the Main Unit, if necessary, so the counter frequency is within 100 Hz of the channel center frequency for the transceiver version.

Transmitter Output Power

Select band center frequency channel, and select high power output level.

Key the transmitter and adjust by control commands for high power from the computer for 50 ± 1 W as indicated on the wattmeter.

Select band center frequency channel, and select low power output level.

Key the transmitter and adjust by control commands for low power from the computer for 10 ± 0.1 W as indicated on the wattmeter.

Transmitter Deviation

Microphone Audio Modulation Level

Select band center frequency channel, and adjust the AF generator for 25 mV (-30 dBm) output at 1 kHz to the microphone jack.

Key the transmitter and adjust by control commands for maximum deviation from the computer for 4.2 kHz ± 0.05 kHz deviation as indicated on the deviation meter.

CTCSS Modulation Level

Select band center frequency channel, with 151.4 Hz CTCSS encode, and reduce the AF generator injection to zero.

Key the transmitter and adjust by control commands for CTCSS deviation from the computer for 0.7 kHz \pm 0.05 kHz deviation as indicated on the deviation meter.

DCS Modulation Level

Select band center frequency channel, with DCS 023 enabled, reduce the AF generator injection to zero.

Key the transmitter and adjust by control commands for DCS deviation from the computer for 0.7 kHz \pm 0.05 kHz deviation as indicated on the deviation meter.

Receiver

Set up the test equipment as shown for receiver alignment, and construct the audio test adapter as described in the box below.

With the transceiver set to band center frequency channel, and the RF signal generator tuned to the same frequency, set the generator for ± 3.0 kHz deviation (for 25 kHz steps) with 1kHz tone modulation, and set the output level for 1 μ V at the antenna jack.

Adjust by control commands for tune from the computer for optimum SINAD, reducing signal generator output level as necessary for proper meter deflection.

After the previous step, final signal generator level should be less than 0.25 μ V for 12 dB SINAD.

Squelch Threshold

Select band center frequency channel, and the RF signal generator turned to the same frequency, set the generator for ± 3.0 kHz deviation with 1 kHz tone modulation, and set the output level for -8 dB μ at the antenna jack.

Adjust the squelch threshold level by control commands for squelch threshold from the computer so that it just closes (**BUSY** LED turns off).