



M. Flom Associates, Inc. - Global Compliance Center
3356 North San Marcos Place, Suite 107, Chandler, Arizona 85224-1571
www.goodnet.com/~mflom, (602) 926-3100, FAX: 926-3598

Sub-part
2.983 (f):

EQUIPMENT IDENTIFICATION

FCC ID: K66VX-510L

NAMEPLATE DRAWING

ATTACHED, EXHIBIT 1.

LOCATION

AS PER LABEL DRAWING(S)

DATE OF REPORT

April 13, 1998

SUPERVISED BY:
MF:glk

MORTON FLOM, P. Eng.

THE APPLICANT HAS BEEN CAUTIONED AS TO THE FOLLOWING:

15.21 INFORMATION TO USER.

The users manual or instruction manual for an intentional radiator shall caution the user that changes or modifications not expressly approved by the party responsible for compliance could void the user's authority to operate the equipment.

15.27(a) SPECIAL ACCESSORIES.

Equipment marketed to a consumer must be capable of complying with the necessary regulations in the configuration in which the equipment is marketed. Where special accessories, such as shielded cables and/or special connectors are required to enable an unintentional or intentional radiator to comply with the emission limits in this part, the equipment must be marketed with, i.e. shipped and sold with, those special accessories. However, in lieu of shipping or packaging the special accessories with the unintentional or intentional radiator, the responsible party may employ other methods of ensuring that the special accessories are provided to the consumer, without additional charge.

Information detailing any alternative method used to supply the special accessories for a grant of equipment authorization or retained in the verification records, as appropriate. The party responsible for the equipment, as detailed in § 2.909 of this chapter, shall ensure that these special accessories are provided with the equipment. The instruction manual for such devices shall include appropriate instructions on the first page of text concerned with the installation of the device that these special accessories must be used with the device. It is the responsibility of the user to use the needed special accessories supplied with the equipment.

TABLE OF CONTENTS

K66VX-510L

<u>RULE</u>	<u>DESCRIPTION</u>	<u>PAGE</u>
2.983	List of General Information Required	2
2.985(a)	Carrier Output Power	6
2.991	Unwanted Emissions (Transmitter Conducted)	8
2.993(a)	Field Strength of Spurious Radiation	11
2.989(c)	Occupied Bandwidth	14
90.214	Transient Frequency Behavior	16
2.987(a)	Audio Low Pass Filter (Voice Input)	19
2.987(a)	Audio Frequency Response	22
2.987(b)	Modulation Limiting	24
2.995(a)	Frequency Stability (Temperature Variation)	26
2.995(d)	Frequency Stability (Voltage Variation)	29
2.202(g)	Necessary Bandwidth and Emission Bandwidth	30

LIST OF GENERAL INFORMATION REQUIRED FOR TYPE ACCEPTANCE

IN ACCORDANCE WITH FCC RULES AND REGULATIONS,
VOLUME II, PART 2 AND TO

90

Sub-part2.983(a): NAME AND ADDRESS OF APPLICANT:

Yaesu Musen Co., Ltd.
20-2, Shimomaruko 1-chome, Ota-ku
Tokyo Japan 146

VENDOR:

Yaesu U.S.A.
17210 Edwards Rd.
Cerritos, CA 90703

2.983(b): FCC ID: K66VX-510LMODEL NO: VERTEX VX-510L, Type A2.983(c): QUANTITY PRODUCTION PLANNED.2.983(d): TECHNICAL DESCRIPTION: SEE ATTACHED EXHIBITS(1): TYPE OF EMISSION: 16KOF3E(2): FREQUENCY RANGE, MHz: 29.7 to 38(3): POWER RATING, Watts: 1, 5
SWITCHABLE ADJUSTABLE N/A (4): MAXIMUM POWER RATING, Watts: 300

2.983(d)

(5): VOLTAGES & CURRENTS IN ALL ELEMENTS IN FINAL R. F. STAGE, INCLUDING FINAL TRANSISTOR OR SOLID STATE DEVICE:

COLLECTOR CURRENT, A = per manual
COLLECTOR VOLTAGE, Vdc = per manual
SUPPLY VOLTAGE, Vdc = 7.2

(6): FUNCTION OF ACTIVE CIRCUIT DEVICES:

PLEASE SEE ATTACHED EXHIBITS

(7): CIRCUIT DIAGRAM:

PLEASE SEE ATTACHED EXHIBITS

(8): MANUAL:

PLEASE SEE ATTACHED EXHIBITS

(9): TUNE-UP PROCEDURE:

PLEASE SEE ATTACHED EXHIBITS

(10): DESCRIPTION OF CIRCUITRY & DEVICES PROVIDED FOR DETERMINING AND STABILIZING FREQUENCY:

PLEASE SEE ATTACHED EXHIBITS

(11): DESCRIPTION OF CIRCUITS OR DEVICES EMPLOYED FOR

- (a) SUPPRESSION OF SPURIOUS RADIATION,
- (b) LIMITING MODULATION,
- (c) LIMITING POWER:

PLEASE SEE ATTACHED EXHIBITS

(12): DIGITAL MODULATION DESCRIPTION:

ATTACHED EXHIBITS
N/A

 x

2.983(e): TEST AND MEASUREMENT DATA:

FOLLOWS

2.983(f): LABEL INFORMATION:

PLEASE SEE ATTACHED EXHIBITS

2.983(g): PHOTOGRAPHS:

PLEASE SEE ATTACHED EXHIBITS

Sub-part
2.983(e):

TEST AND MEASUREMENT DATA

All tests and measurement data shown were performed in accordance with FCC Rules and Regulations, Volume II; Part 2, Sub-part J, Sections 2.981, 2.983, 2.985, 2.987, 2.989, 2.991, 2.993, 2.995, 2.997, 2.999 and the following individual Parts:

- ___ 21 - Domestic Public Fixed Radio Services
- ___ 22 - Public Mobile Services
- ___ 22 Subpart H - Cellular Radiotelephone Service
- ___ 22.901(d) - Alternative technologies and auxiliary services
- ___ 23 - International Fixed Public Radiocommunication services
- ___ 24 - Personal Communications Services
- ___ 74 Subpart H - Low Power Auxiliary Stations
- ___ 80 - Stations in the Maritime Services
- ___ 80 Subpart E - General Technical Standards
- ___ 80 Subpart F - Equipment Authorization for Compulsory Ships
- ___ 80 Subpart K - Private Coast Stations and Marine Utility Stations
- ___ 80 Subpart S - Compulsory Radiotelephone Installations for Small Passenger Boats
- ___ 80 Subpart T - Radiotelephone Installation Required for Vessels on the Great Lakes
- ___ 80 Subpart U - Radiotelephone Installations Required by the Bridge-to-Bridge Act
- ___ 80 Subpart V - Emergency Position Indicating Radiobeacons (EPIRB'S)
- ___ 80 Subpart W - Global Maritime Distress and Safety System (GMDSS)
- ___ 80 Subpart X - Voluntary Radio Installations
- ___ 87 - Aviation Services
- x 90 - Private Land Mobile Radio Services
- ___ 94 - Private Operational-Fixed Microwave Service
- ___ 95 Subpart A - General Mobile Radio Service (GMRS)
- ___ 95 Subpart C - Radio Control (R/C) Radio Service
- ___ 95 Subpart D - Citizens Band (CB) Radio Service
- ___ 95 Subpart E - Family Radio Service
- ___ 95 Subpart F - Interactive Video and Data Service (IVDS)
- ___ 101 - Fixed Microwave Services

STANDARD TEST CONDITIONS
and
ENGINEERING PRACTICES

Except as noted herein, the following conditions and procedures were observed during the testing:

ROOM TEMPERATURE	=	25±5°C
ROOM HUMIDITY	=	20-50%
D.C. SUPPLY VOLTAGE, Vdc	=	7.2
A.C. SUPPLY VOLTAGE, Vac	=	N/A
A.C. SUPPLY FREQUENCY, Hz	=	N/A

Prior to testing, the EUT was tuned up in accordance with the manufacturer's alignment procedures. All external gain controls were maintained at the position of maximum and/or optimum gain throughout the testing.

Measurement results, unless otherwise noted, are worst case measurements.

PAGE NO.

6.

K66VX-510L

NAME OF TEST:

Carrier Output Power (Conducted)

SPECIFICATION:

FCC: 47 CFR 2.985(a)
IC: RSS-119, Section 6.2

GUIDE:

TIA/EIA-603, Paragraph 2.2.1

TEST CONDITIONS:

Standard Temperature and Humidity (S. T. & H.)

TEST EQUIPMENT:

As per attached page

MEASUREMENT PROCEDURE

1. The EUT was connected to a resistive coaxial attenuator of normal load impedance, and the unmodulated output power was measured by means of an R. F. Power Meter.
2. Measurement accuracy is $\pm 3\%$.

MEASUREMENT RESULTS

NOMINAL, MHz

R. F. POWER OUTPUT, WATTS

33.875
29.725
37.975

1
1
1

5
5
5

SUPERVISED BY:

MORTON FLOOM, P. Eng.

TRANSMITTER POWER CONDUCTED MEASUREMENTS

TEST 1: R. F. POWER OUTPUT
 TEST 2: FREQUENCY STABILITY

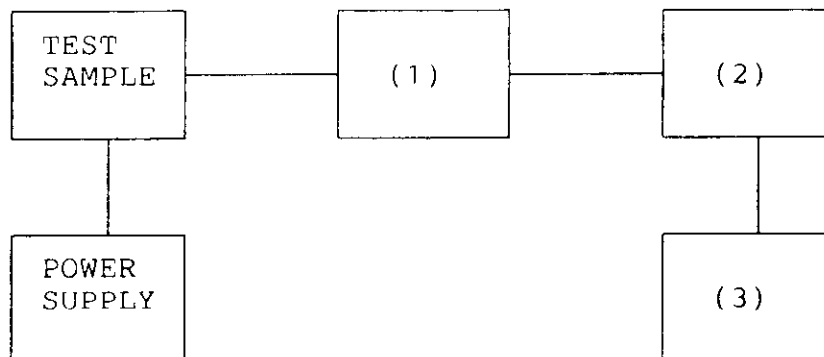
(1) COAXIAL ATTENUATOR

NARDA 766-10
 SIERRA 661A-30
 BIRD 8329 (30 dB)

 x

(2) POWER METERS

HP 435A
 HP 436A
 HP 8901A POWER MODE

 x
 x

(3) FREQUENCY COUNTER

HP 5383A
 HP 5334B
 HP 8901A FREQUENCY MODE

 x
 x

PAGE NO. 8. K66VX-510L
NAME OF TEST: Unwanted Emissions (Transmitter Conducted)
SPECIFICATION: FCC: 47 CFR 2.991
IC: RSS-119, Section 6.3
GUIDE: TIA/EIA-603, Paragraph 2.2.13
TEST CONDITIONS: S. T. & H.
TEST EQUIPMENT: As per attached page

MEASUREMENT PROCEDURE

1. The emissions were measured for the worst case as follows:
 - (a): within a band of frequencies defined by the carrier frequency plus and minus one channel.
 - (b): from the lowest frequency generated in the EUT and to at least the 10th harmonic of the carrier frequency, or 40 GHz, whichever is lower.
2. The magnitude of spurious emissions which are attenuated more than 20 dB below the permissible value need not be specified.
3. MEASUREMENT RESULTS: ATTACHED FOR WORST CASE

FREQUENCY OF CARRIER, MHz = 33.875, 29.725, 37.975
SPECTRUM SEARCHED, GHz = 0 to 10 x F_C
MAXIMUM RESPONSE, Hz = 2820
ALL OTHER EMISSIONS = ≥ 20 dB BELOW LIMIT
LIMIT, dBc: -(43 + 10 LOG P₀) = -43 (1 Watt)
-50 (5 Watts)

SUPERVISED BY:

MORTON FLOOM, P. Eng.

TRANSMITTER SPURIOUS EMISSION

TEST A. OCCUPIED BANDWIDTH (IN-BAND SPURIOUS)
 TEST B. OUT-OF-BAND SPURIOUS

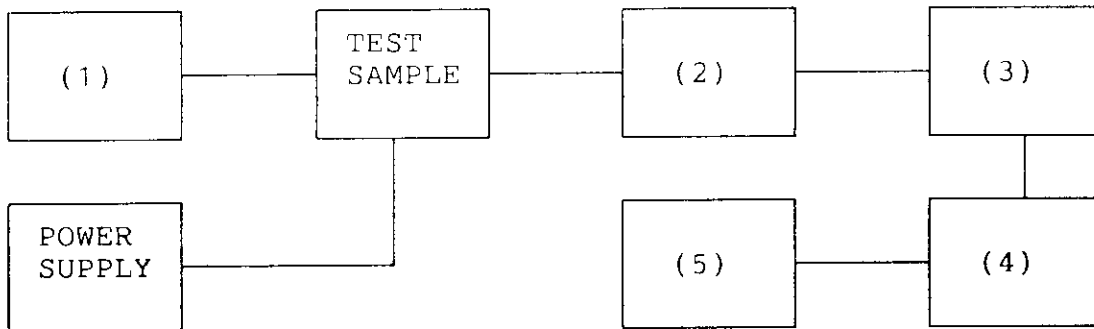

- (1) AUDIO OSCILLATOR/GENERATOR
 - HP 204D _____
 - HP 8903A _____
 - HP 3312A x
 - _____ x

- (2) COAXIAL ATTENUATOR
 - NARDA 766-10 _____
 - SIERRA 661A-30 x
 - BIRD 8329 (30 dB) x
 - _____ _____

- (3) FILTERS; NOTCH, HP, LP, BP
 - CIRQTEL FHT _____
 - EAGLE TNF-1 x
 - PHELPS DODGE PD-495-8 _____
 - _____ _____

- (4) SPECTRUM ANALYZER
 - HP 8566B x
 - HP 8563E _____
 - _____ _____

- (5) SCOPE
 - HP 1741A _____
 - HP 181T _____
 - TEK 935 _____
 - HP 54502A _____
 - _____ _____

PAGE NO.

10.1.

K66VX-510L

G83U004

TRANSMITTER SPURIOUS EMISSIONS (CONDUCTED)

POWER: LOW

FREQUENCY TUNED, MHz	FREQUENCY EMISSION, MHz	LEVEL, dBm	LEVEL, dBc	LEVEL, μ W
33.875	67.754	-33.3	-63.3	0
33.875	101.615	-28.8	-58.8	1
33.875	135.487	-42.9	-72.9	0
33.875	169.404	-43.2	-73.2	0
33.875	203.247	-42.2	-72.2	0
33.875	237.135	-41.7	-71.7	0
33.875	271.024	-43.2	-73.2	0
33.875	304.875	-43.3	-73.3	0
33.875	338.790	-45.5	-75.5	0
33.875	372.617	-45.6	-75.6	0
33.875	406.531	-43.8	-73.8	0
33.875	439.934	-45.9	-75.9	0
33.875	473.799	-44.7	-74.7	0
33.875	507.870	-45.0	-75.0	0

G83U003

TRANSMITTER SPURIOUS EMISSIONS (CONDUCTED)

POWER: HIGH

FREQUENCY TUNED, MHz	FREQUENCY EMISSION, MHz	LEVEL, dBm	LEVEL, dBc	LEVEL, μ W
33.875	67.743	-27.3	-64.2	2
33.875	101.950	-22.7	-59.6	5
33.875	135.508	-38.0	-74.9	0
33.875	169.365	-43.4	-80.3	0
33.875	203.234	-37.5	-74.4	0
33.875	237.155	-35.8	-72.7	0
33.875	270.980	-36.1	-73.0	0
33.875	304.860	-39.5	-76.4	0
33.875	338.733	-39.9	-76.8	0
33.875	372.594	-39.3	-76.2	0
33.875	406.541	-39.1	-76.0	0
33.875	439.978	-43.6	-80.5	0
33.875	474.449	-44.0	-80.9	0
33.875	508.128	-44.6	-81.5	0

PAGE NO.

11.1.

K66VX-510L

NAME OF TEST:

Field Strength of Spurious Radiation

SPECIFICATION:

FCC: 47 CFR 2.993(a)
IC: N/A

GUIDE:

TIA/EIA-603, Section 2.2.12

TEST CONDITIONS:

S. T. & H.

TEST EQUIPMENT:

AS PER ATTACHED PAGE

MEASUREMENT PROCEDURE

1. A description of the measurement facilities was filed with the FCC and was found to be in compliance with the requirements of Section 15.38, by letter from the FCC dated March 3, 1997, FILE 31040/SIT. All pertinent changes will be reported to the Commission by up-date prior to March 2000.
2. At first, in order to locate all spurious frequencies and approximate amplitudes, and to determine proper equipment functioning, the test sample was set up at a distance of three meters from the test instrument. Valid spurious signals were determined by switching the power on and off.
3. In the field, the test sample was placed on a wooden turntable above ground at three (or thirty) meters away from the search antenna. The test sample was connected to an R.F. Wattmeter and a 50 ohm dummy load, and adjusted to its rated output.

In order to obtain the maximum response at each spurious frequency, the turntable was rotated. Also, the Search Antennas were raised and lowered vertically, and all cables were oriented. Excess power lead was coiled near the power supply.
4. A signal generator, connected with a non-radiating cable to a vertically polarized half-wave antenna (for each frequency involved) was substituted for the transmitter. The Search Antenna was raised and lowered to obtain maximum indicated.
5. The signal generator output was adjusted until a signal level indication equal to that from the transmitter was obtained.
6. Steps 4 and 5 were repeated, using a horizontally polarized half-wave antenna. The higher of the two observations was noted.

PAGE NO.

11.2.

K66VX-510L

NAME OF TEST:

Field Strength of Spurious Radiation

SPECIFICATION:

FCC: 47 CFR 2.993(a)

IC: N/A

MEASUREMENT PROCEDURE (CONT.)

7. Power into the half-wave antenna was calculated from the characteristic impedance of the line, and the voltage output from the signal generator.

8. The level of each spurious radiation with reference to the transmitter power in dB, was calculated from:

$$\text{SPURIOUS LEVEL, dB} = 10 \text{ LOG} \left(\frac{\text{Calculated Spurious Power}}{\text{Tx Power (Wattmeter)}} \right) \quad \text{[from para. 7].}$$

9. The worst case for all channels is shown.

10. Measurement summary:

FREQUENCY OF CARRIER, MHz	= 33.875, 29.725, 37.975
SPECTRUM SEARCHED, GHz	= 0 to $10 \times F_C$
ALL OTHER EMISSIONS	= ≥ 20 dB BELOW LIMIT
LIMIT, dBc	= -50 (5 Watts) -43 (1 Watt)

11. Measurement results:

ATTACHED FOR WORST CASE

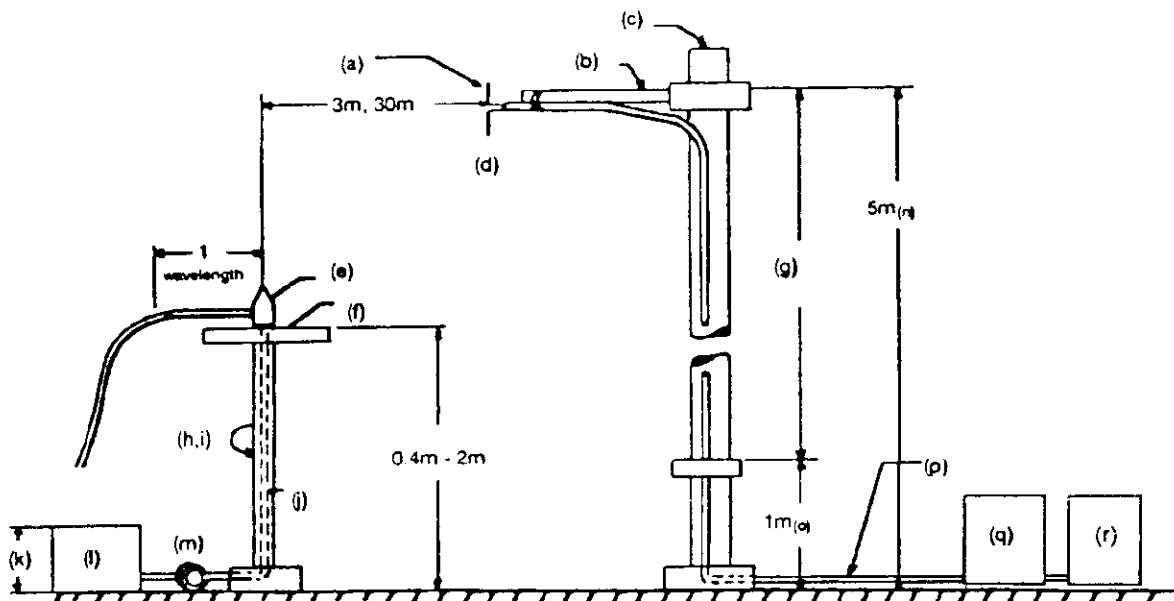
RADIATED TEST SETUP

NOTES:

- (a) Search Antenna - Rotatable on boom.
- (b) Non-metallic boom.
- (c) Non-metallic mast.
- (d) Adjustable horizontally.
- (e) Equipment Under Test.
- (f) Turntable.
- (g) Boom adjustable in height.
- (h) External control cables routed horizontally at least one wavelength.
- (i) Rotatable.
- (j) Cables routed through hollow turntable center.
- (k) 30 cm or less.
- (l) External power source.
- (m) 10 cm diameter coil of excess cable.
- (n) 25 cm (V), 1 m-7 m (V, H).
- (o) 25 cm from bottom end of 'V', 1 m normally.
- (p) Calibrated Cable at least 10 m in length.
- (q) Amplifier (optional).
- (r) Spectrum Analyzer.

TRANSMITTER SPURIOUS EMISSIONS (RADIATED FIELD STRENGTH)

ALL OTHER EMISSIONS = ≥ 20 dB BELOW LIMIT

EMISSION, MHz/HARMONIC	SPURIOUS LEVEL BELOW	
	Lo	Hi
2nd to 10th	<-55	<-55

SUPERVISED BY:

M. F. Eng
MORTON FLOM, P. Eng.

PAGE NO.

14.

K66VX-510L

NAME OF TEST:

Emission Masks (Occupied Bandwidth)

SPECIFICATION:

FCC: 47 CFR 2.989(c)(1)
IC: RSS-119, Section 6.4

GUIDE:

TIA/EIA-603, Paragraph 2.2.11

TEST CONDITIONS:

S. T. & H.

TEST EQUIPMENT:

As per previous page

MEASUREMENT PROCEDURE

1. The EUT and test equipment were set up as shown on the following page, with the Spectrum Analyzer connected.
2. For EUTs supporting audio modulation, the audio signal generator was adjusted to the frequency of maximum response and with output level set for ± 2.5 kHz deviation (or 50% modulation). With level constant, the signal level was increased 16 dB.
3. For EUTs supporting digital modulation, the digital modulation mode was operated to its maximum extent.
4. The Occupied Bandwidth was measured with the Spectrum Analyzer controls set as shown on the test results.
5. MEASUREMENT RESULTS: ATTACHED

PAGE 15.1.
SPECTRUM ANALYZER PRESENTATION
YAESU, VX-510L Type A
1998-MAR-30, 17:18, MON

POWER: LOW
MODULATION: NONE

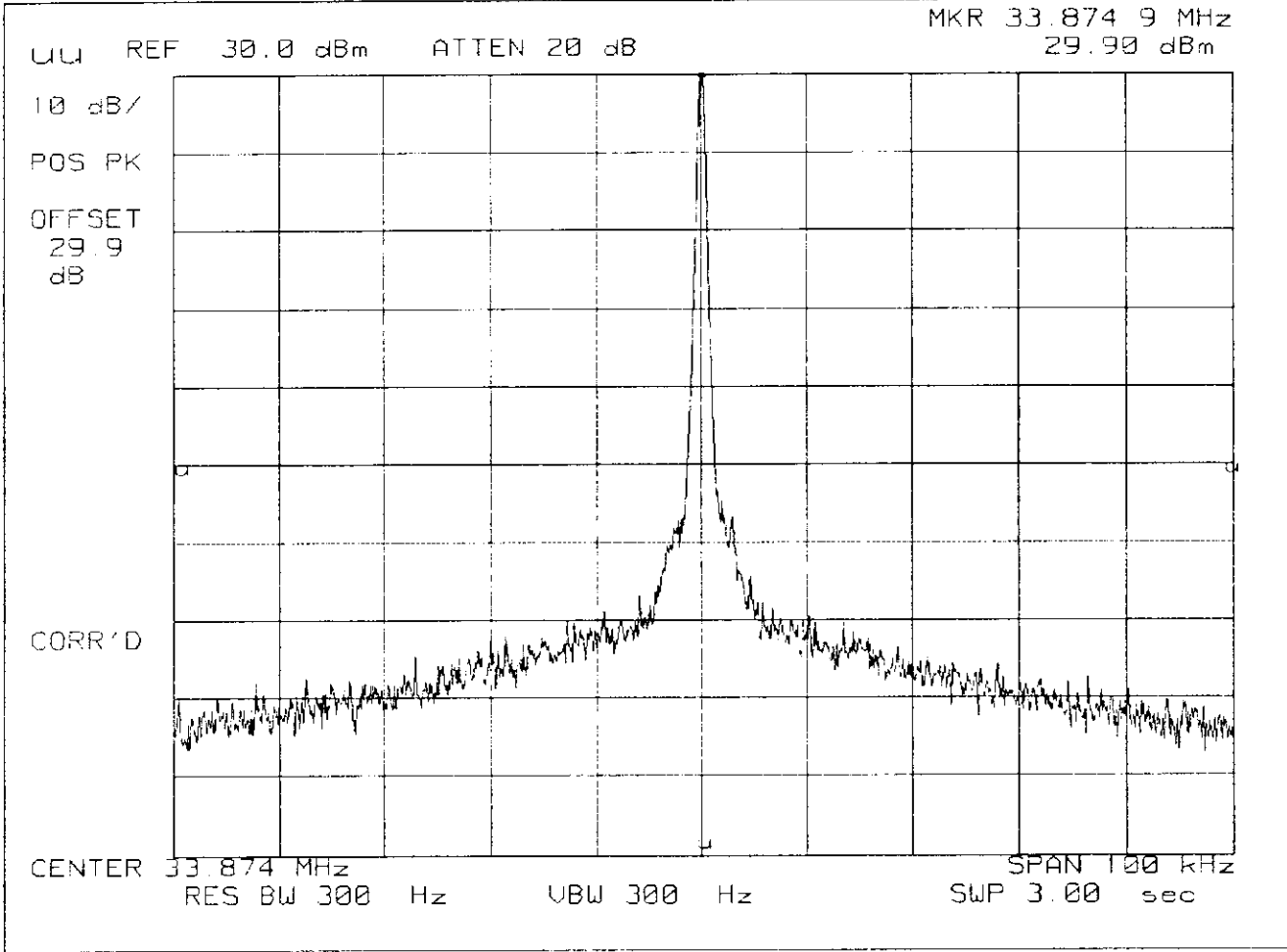

C:\NOCTRO\65\60530306.PLY COPYRIGHT © 1998 BY K7 FLINN ASSOCIATES, INC. ALL RIGHTS RESERVED

PAGE 15.2.
SPECTRUM ANALYZER PRESENTATION
YAESU, VX-510L Type A
1998-MAR-30, 17:21, MON

POWER: LOW
MODULATION: VOICE: 2500 Hz SINE WAVE
MASK: B, VHF/UHF 25kHz, w/LPF

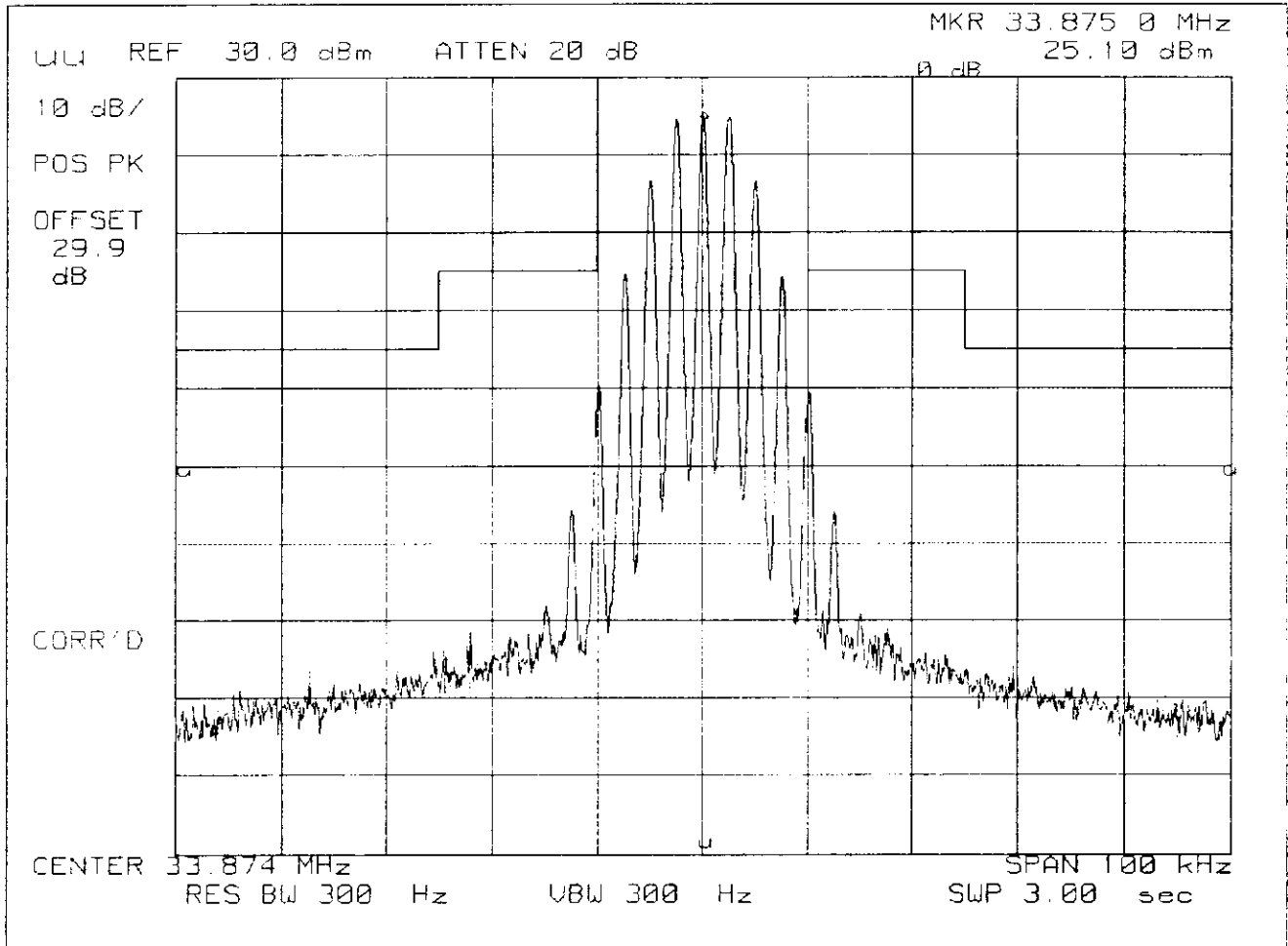

PAGE 15.3.
SPECTRUM ANALYZER PRESENTATION
YAESU, VX-510L Type A
1998-MAR-30, 17:15, MON

POWER: HIGH
MODULATION: NONE

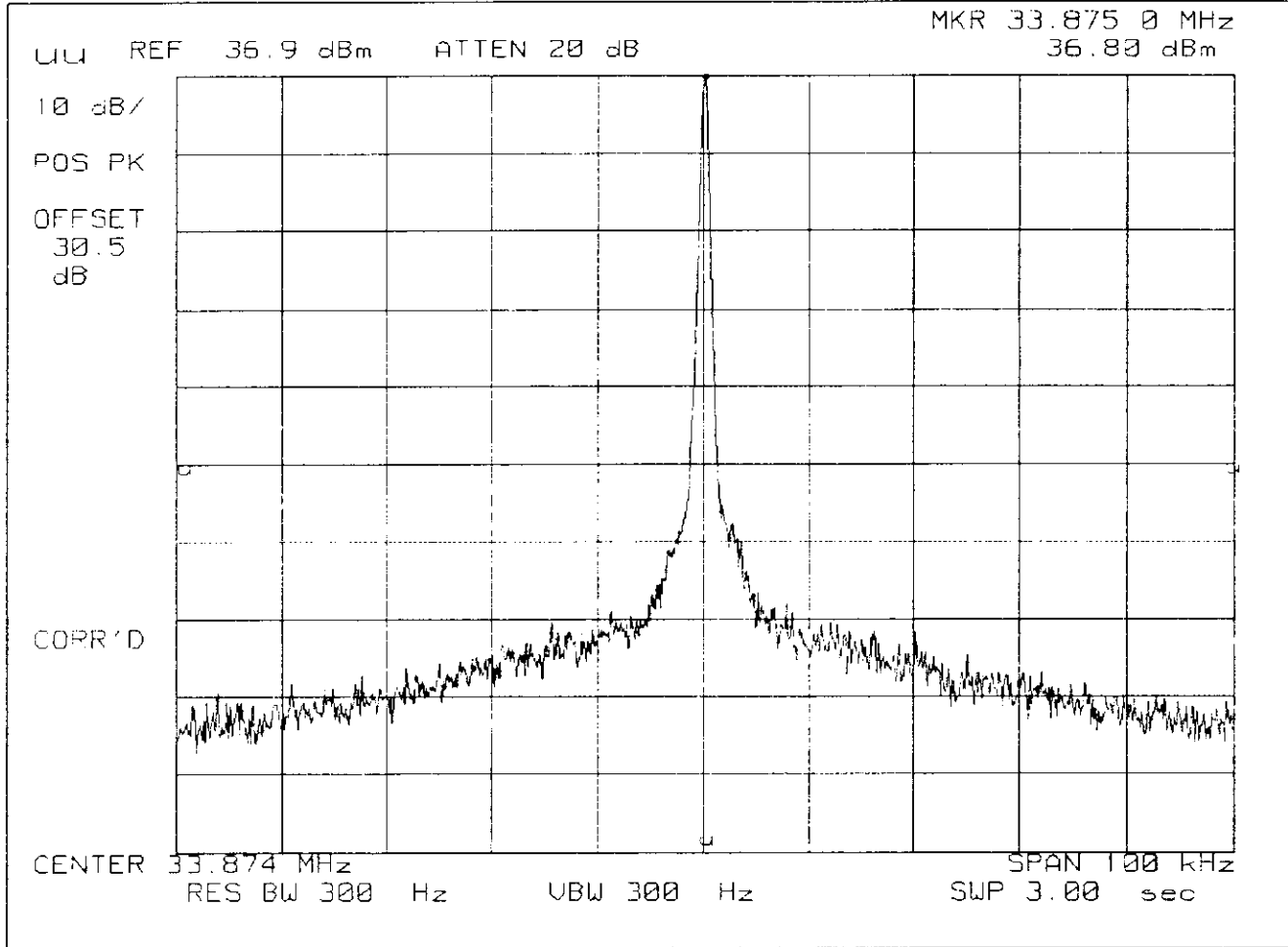

PAGE 15.4.
SPECTRUM ANALYZER PRESENTATION
YAESU, VX-510L Type A
1998-MAR-30, 17:24, MON

K66VX-510L

POWER: HIGH
MODULATION: VOICE: 2500 Hz SINE WAVE
MASK: B, VHF/UHF 25kHz, w/LPF

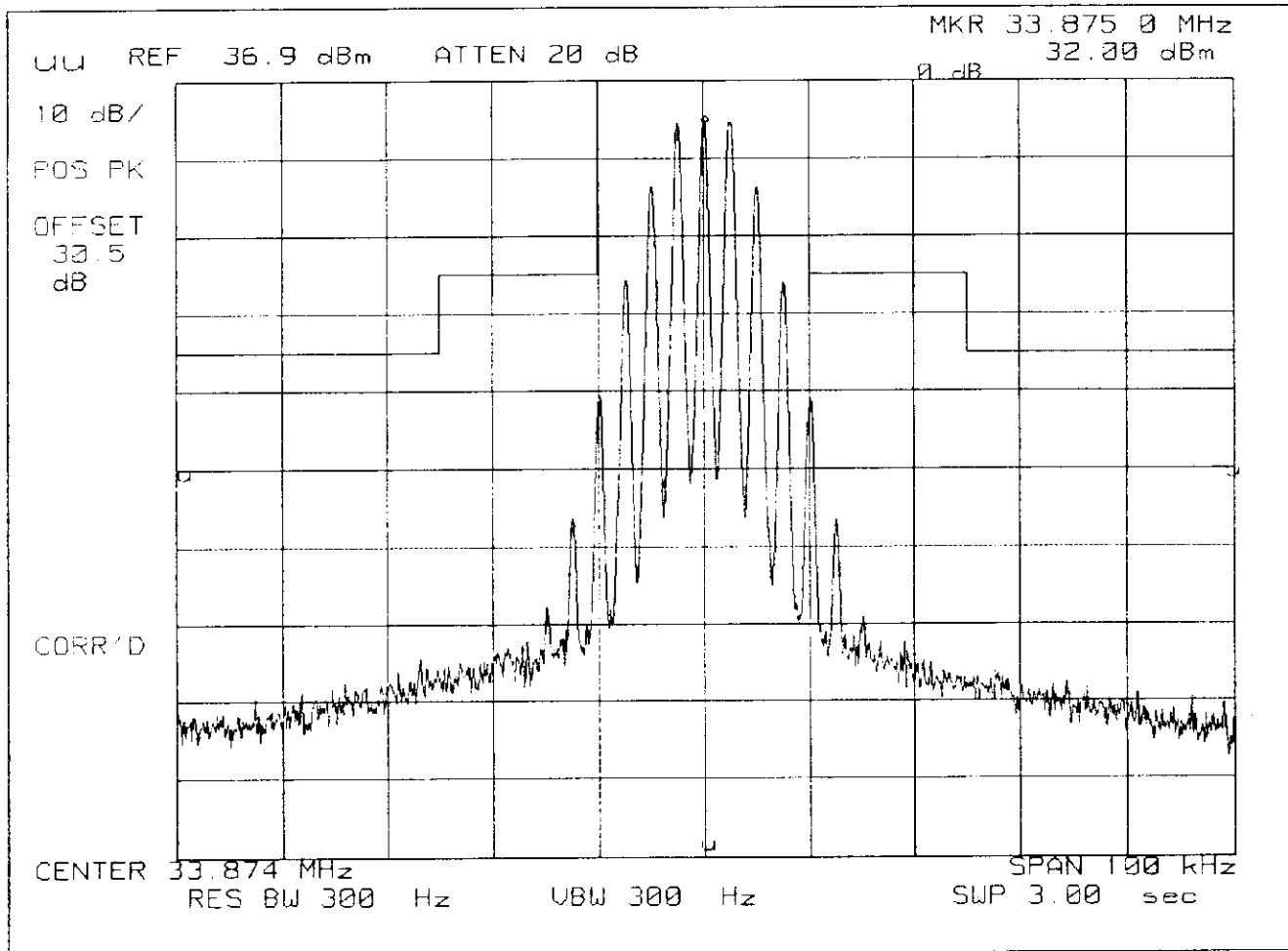

ALL RIGHTS RESERVED

FCC ID: K66VX-510L

TRANSIENT FREQUENCY BEHAVIOUR

NOT REQUIRED FOR FREQUENCY BELOW 150 MHz

PAGES 16 to 18

DELIBERATELY LEFT BLANK

PAGE NO.

19.

K66VX-510L

NAME OF TEST:

Audio Low Pass Filter (Voice Input)

SPECIFICATION:

FCC: 47 CFR 2.987(a)
IC: RSS-119, Section 6.6

GUIDE:

TIA/EIA-603, Paragraph 2.2.15

TEST CONDITIONS:

S. T. & H.

TEST EQUIPMENT:

As per attached page

MEASUREMENT PROCEDURE

1. The EUT and test equipment were set up such that the audio input was connected at the input to the modulation limiter, and the modulated stage.
2. The audio output was connected at the output to the modulated stage.
3. MEASUREMENT RESULTS: ATTACHED

TRANSMITTER TEST SET-UP

TEST A. MODULATION CAPABILITY/DISTORTION
 TEST B. AUDIO FREQUENCY RESPONSE
 TEST C. HUM AND NOISE LEVEL
 TEST D. RESPONSE OF LOW PASS FILTER
 TEST E. MODULATION LIMITING

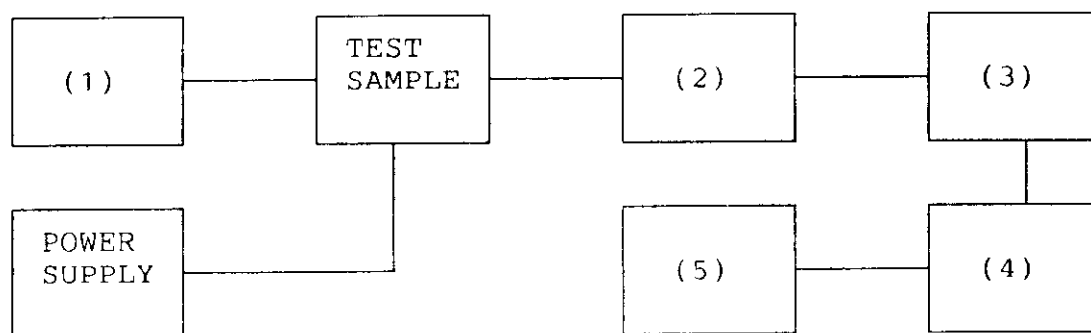
(1) AUDIO OSCILLATOR/GENERATOR

HP 204D	---
HP 8903A	---
HP 3312A	<u>x</u>
_____	<u>x</u>

(2) COAXIAL ATTENUATOR

NARDA 766-10	---
SIERRA 661A-30	<u>x</u>
BIRD 8329 (30 dB)	---
_____	---

(3) MODULATION ANALYZER

HP 8901A	<u>x</u>
_____	---

(4) AUDIO ANALYZER

HP 8903A	<u>x</u>
_____	---

(5) SCOPE

HP 1741A	---
HP 181T	---
TEK 935	---
_____	---

FREQUENCY RESPONSE OF AUDIO LOW PASS FILTER
YAESU, VX-510L Type A
30 MAR 1998, 16:51

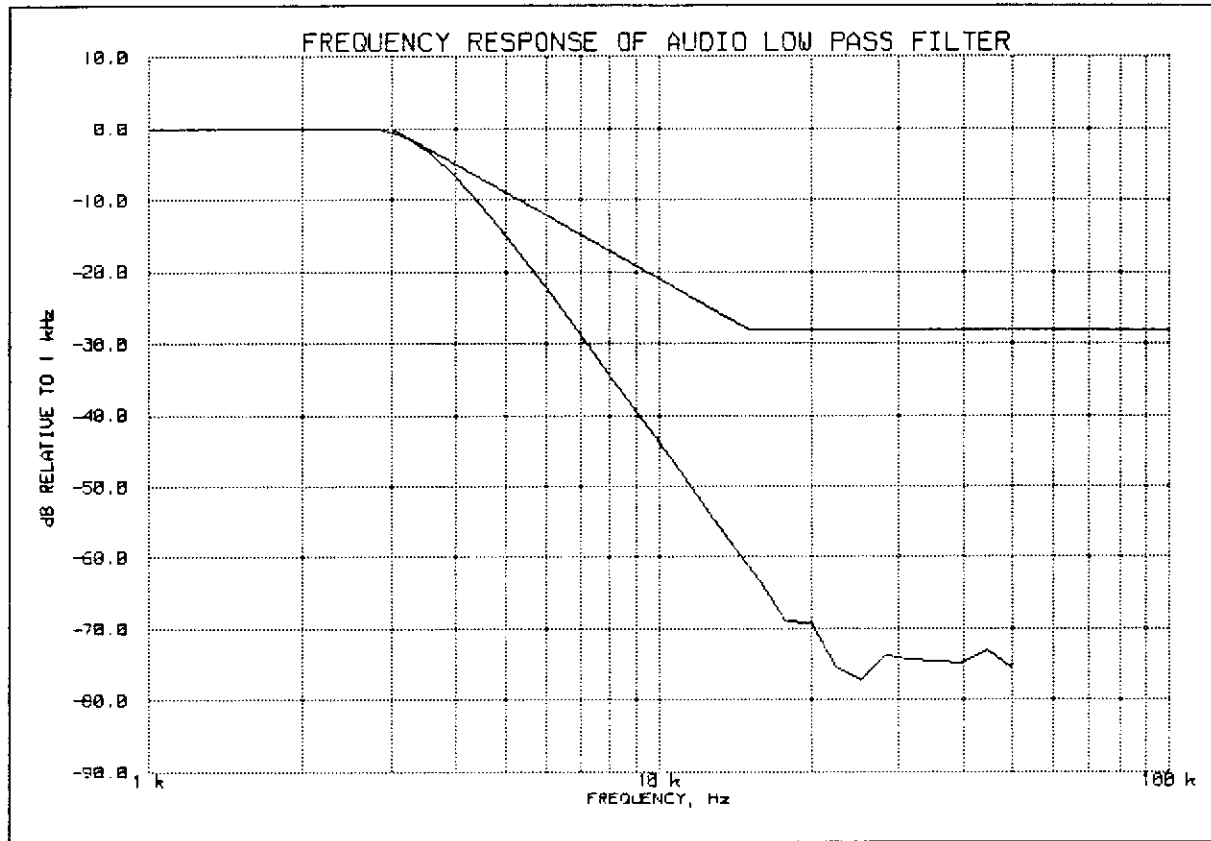

COPYRIGHT (C) 1988 BY W. FLOM ASSOCIATES, INC. ALL RIGHTS RESERVED.

PEAK AUDIO FREQUENCY, Hz: 2820

Morton P. Eng

SUPERVISED BY:

MORTON FLOM, P. Eng.

PAGE NO.

22.

K66VX-510L

NAME OF TEST:

Audio Frequency Response

SPECIFICATION:

FCC: 47 CFR 2.987(a)
IC: N/A

GUIDE:

TIA/EIA-603, Section 2.2.6

TEST CONDITIONS:

S. T. & H.

TEST EQUIPMENT:

As per previous page

MEASUREMENT PROCEDURE

1. The EUT and test equipment were set up as shown on the following page.
2. The audio signal generator was connected to the audio input circuit/microphone of the EUT.
3. The audio signal input was adjusted to obtain 20% modulation at 1 kHz, and this point was taken as the 0 dB reference level.
4. With input levels held constant and below limiting at all frequencies, the audio signal generator was varied from 100 Hz to 50 kHz.
5. The response in dB relative to 1 kHz was then measured, using the HP 8901A Modulation Analyzer.
6. MEASUREMENT RESULTS: ATTACHED

PAGE 23.
 TRANSMITTER AUDIO FREQUENCY RESPONSE
 YAESU, VX-510L Type A
 30 MAR 1998, 16:37

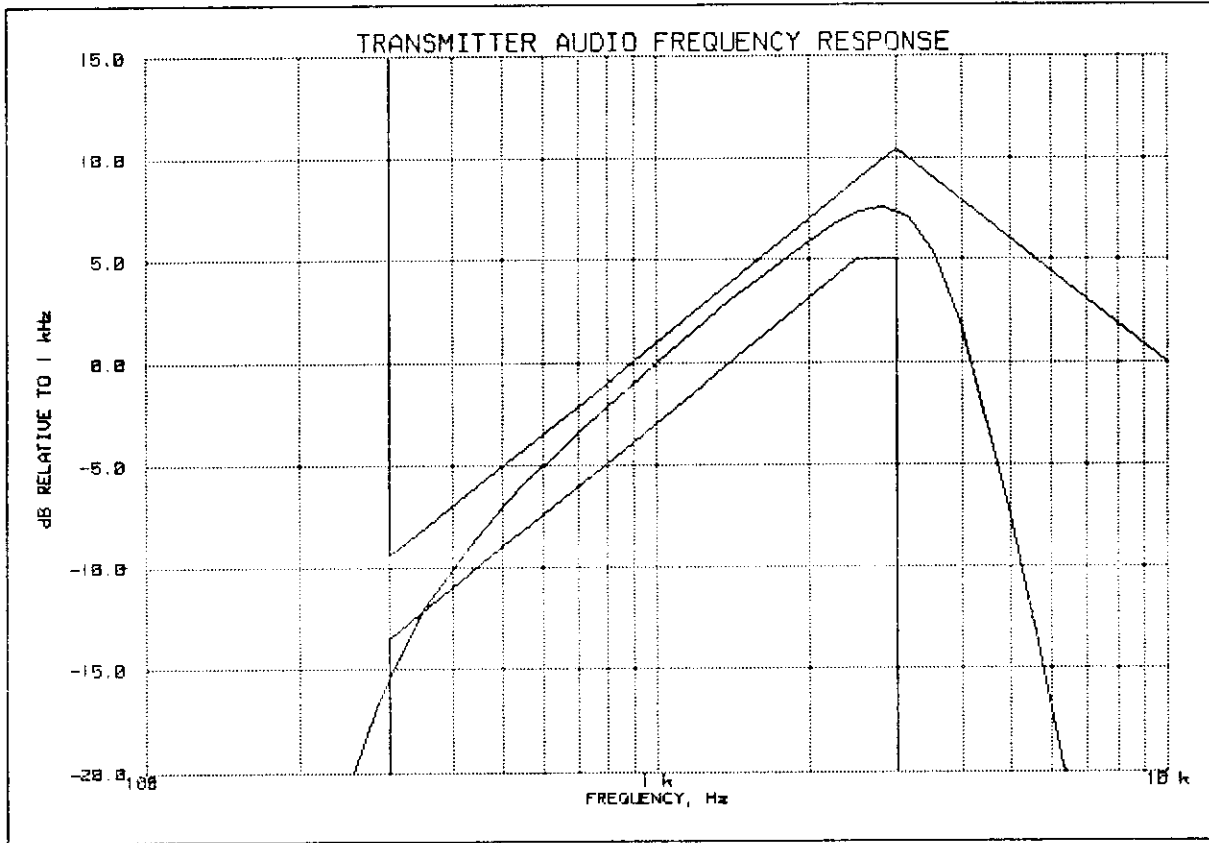

COPYRIGHT © 1986 BY M. FLOM ASSOCIATES, INC. ALL RIGHTS RESERVED.

PEAK AUDIO FREQUENCY, Hz: 2820

TABLE VALUES:

FREQUENCY, Hz	LEVEL, dB	FREQUENCY, Hz	LEVEL, dB	FREQUENCY, Hz	LEVEL, dB
300	-15.3	30000	-34.2		
20000	-34.1	50000	-34.3		

M. Flom P. Eng.

SUPERVISED BY:

MORTON FLOM, P. Eng.

PAGE NO.

24.

K66VX-510L

NAME OF TEST:

Modulation Limiting

SPECIFICATION:

IC: RSS-119, Section 6.6
FCC: 47 CFR 2.987(b)

GUIDE:

TIA/EIA-603, Paragraph 2.2.3

TEST CONDITIONS:

S. T. & H.

TEST EQUIPMENT:

As per attached page

MEASUREMENT PROCEDURE

1. The signal generator was connected to the input of the EUT as for "Frequency Response of the Modulating Circuit."
2. The modulation response was measured for each of three frequencies (one of which was the frequency of maximum response), and the input voltage was varied and was observed on an HP 8901A Modulation Analyzer.
3. The input level was varied from 30% modulation (± 1.5 kHz deviation) to at least 20 dB higher than the saturation point.
4. Measurements were performed for both negative and positive modulation and the respective results were recorded.
5. MEASUREMENT RESULTS: ATTACHED

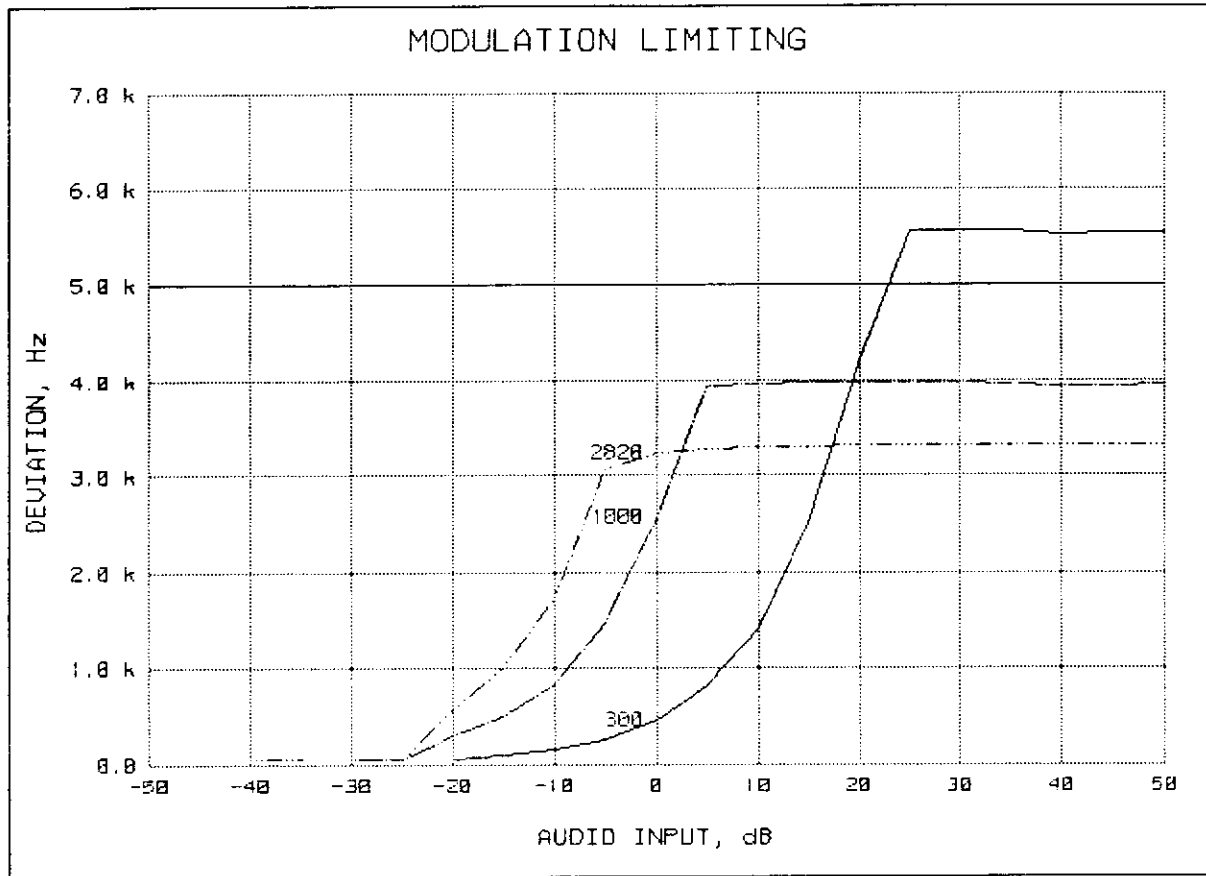

COPYRIGHT © 1998 BY M. FLOM ASSOCIATES, INC. ALL RIGHTS RESERVED.

REFERENCE DEVIATION, kHz = 2.5
 REFERENCE MODULATION, Hz = 1000
 PEAKS = POSITIVE
 AUDIO AMPLITUDE, mV = 10.33

Morton Flom P. Eng.

SUPERVISED BY:

MORTON FLOM, P. Eng.

MODULATION LIMITING
YAESU, VX-510L Type A
1998-MAR-30, 16:55

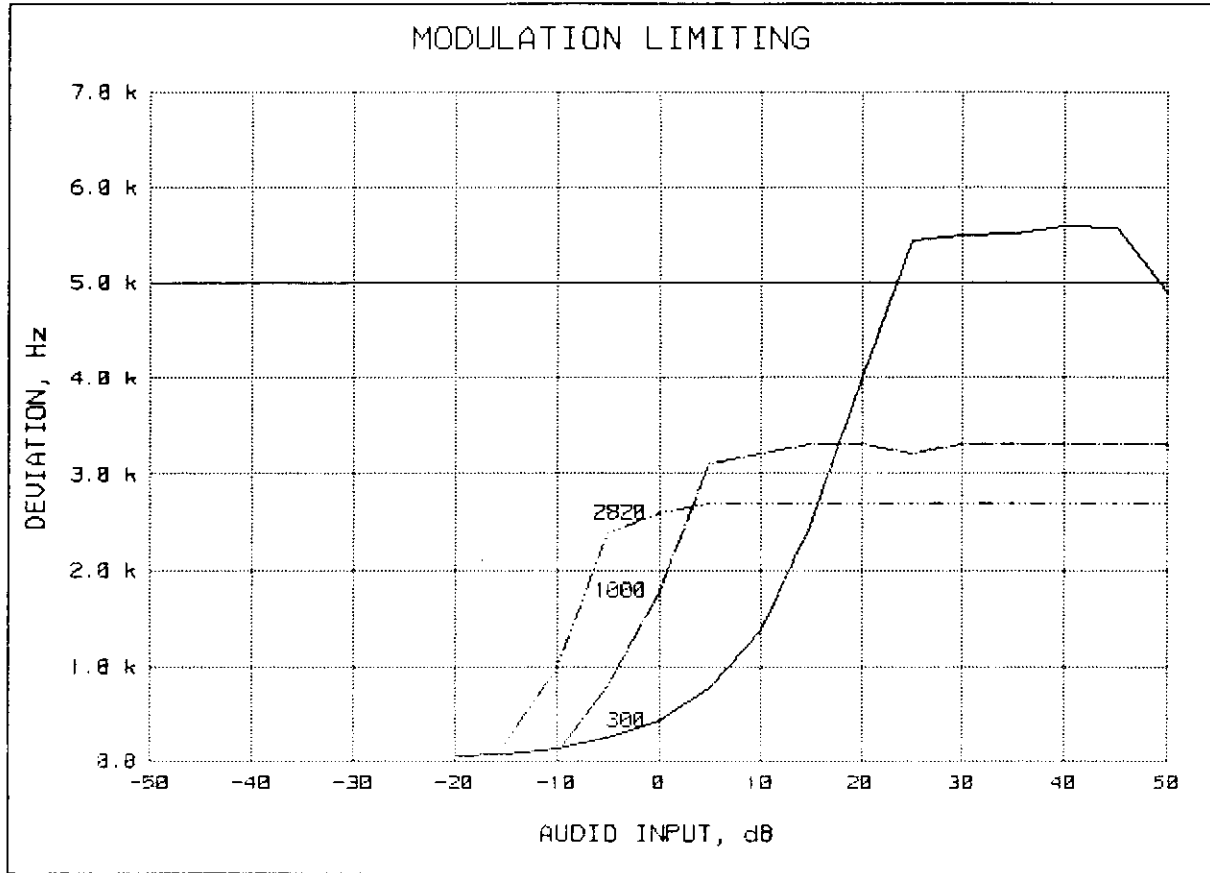

REFERENCE DEVIATION, kHz = 2.5
REFERENCE MODULATION, Hz = 1000
PEAKS = NEGATIVE
AUDIO AMPLITUDE, mV = 9.98

Morton Flom P. Eng.

SUPERVISED BY:

MORTON FLOM, P. Eng.

PAGE NO.

26.

K66VX-510L

NAME OF TEST:

Frequency Stability (Temperature Variation)

SPECIFICATION:

FCC: 47 CFR 2.995(a)(1)
IC: RSS-119, Section 7.0

GUIDE:

TIA/EIA-602, Section 2.2.2

TEST CONDITIONS:

As indicated

TEST EQUIPMENT:

As per attached page

MEASUREMENT PROCEDURE

1. The EUT and test equipment were set up as shown on the following page.
2. With all power removed, the temperature was decreased to -30°C and permitted to stabilize for three hours. Power was applied and the maximum change in frequency was noted within one minute.
3. With power OFF, the temperature was raised in 10°C steps. The sample was permitted to stabilize at each step for at least one-half hour. Power was applied and the maximum frequency change was noted within one minute.
4. The temperature tests were performed for the worst case.
5. MEASUREMENT RESULTS: ATTACHED

TRANSMITTER TEST SET-UP

- TEST A. OPERATIONAL STABILITY
- TEST B. CARRIER FREQUENCY STABILITY
- TEST C. OPERATIONAL PERFORMANCE STABILITY
- TEST D. HUMIDITY
- TEST E. VIBRATION
- TEST F. ENVIRONMENTAL TEMPERATURE
- TEST G. FREQUENCY STABILITY: TEMPERATURE VARIATION
- TEST H. FREQUENCY STABILITY: VOLTAGE VARIATION

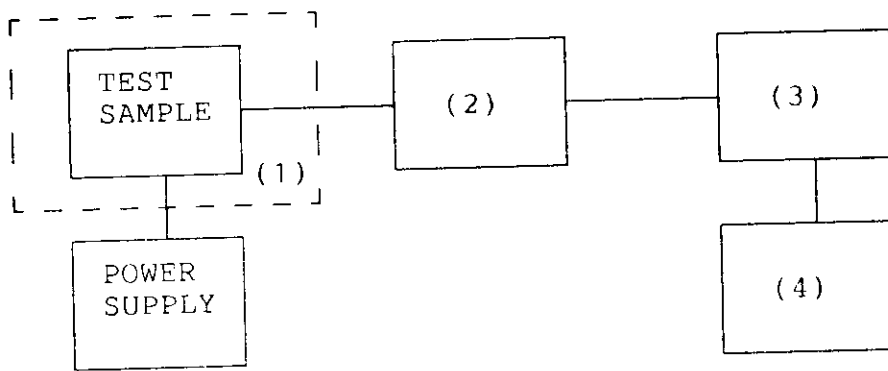

(1) TEMPERATURE, HUMIDITY, VIBRATION

- TENNEY TEMPERATURE CHAMBER x
- WEBER HUMIDITY CHAMBER
- L.A.B. RVH 18-100

(2) COAXIAL ATTENUATOR

- NARDA 766-10
- SIERRA 661A-30 x
- BIRD 8329 (30 dB) x

(3) R.F. POWER

- HP 435A POWER METER
- HP 436A POWER METER x
- HP 8901A POWER MODE x

(4) FREQUENCY COUNTER

- HP 5383A
- HP 5334B x
- HP 8901A x

PAGE NO. 29. K66VX-510L

NAME OF TEST: Frequency Stability (Voltage Variation)

SPECIFICATION: FCC: 47 CFR 2.995 (b)(1)
IC: RSS-119, Section 7.0

GUIDE: TIA/EIA-602, Section 2.2.2

TEST CONDITIONS: As indicated

TEST EQUIPMENT: As per attached page

MEASUREMENT PROCEDURE

1. The EUT was placed in a temperature chamber at 25±5°C and connected as for "Frequency Stability - Temperature Variation" test.
2. The power supply voltage to the EUT was varied from 85% to 115% of the nominal value measured at the input to the EUT.
3. The variation in frequency was measured for the worst case.

MEASUREMENT RESULTS

LIMIT, ppm = 20
LIMIT, Hz = 678

STV, %	Vdc	<u>CHANGE IN FREQUENCY, Hz</u>	
85	6.1	33875000	0
100	7.2	33875000	0
115	8.3	33875000	0
BATTERY END POINT:	5.8	33875000	0

SUPERVISED BY:

Morton Flom P. Eng.
MORTON FLOM, P. Eng.

PAGE NO.

30.

K66VX-510L

NAME OF TEST:

Necessary Bandwidth and Emission Bandwidth

PARAGRAPH:

47 CFR 2.202(g)

MODULATION = 16K0F3E

NECESSARY BANDWIDTH CALCULATION:

MAXIMUM MODULATION (M), kHz = 3
MAXIMUM DEVIATION (D), kHz = 5
CONSTANT FACTOR (K) = 1
NECESSARY BANDWIDTH (B_N), kHz = $(2 \times M) + (2 \times D \times K)$
= 16.0

SUPERVISED BY:

MORTON FLOM, P. Eng.

TESTIMONIAL
AND
STATEMENT OF CERTIFICATION

K66VX-510L

THIS IS TO CERTIFY:

1. THAT the application was prepared either by, or under the direct supervision of, the undersigned.
2. THAT the technical data supplied with the application was taken under my direction and supervision.
3. THAT the data was obtained on representative units, randomly selected.
4. THAT, to the best of my knowledge and belief, the facts set forth in the application and accompanying technical data are true and correct.

CERTIFYING ENGINEER:

MORTON FLOM, P. Eng.

STATEMENT OF QUALIFICATIONS

EDUCATION:

1. B. ENG. in ENGINEERING PHYSICS, 1949, McGill University, Montreal, Canada.
2. Post Graduate Studies, McGill University & Sir George Williams University, Montreal.

PROFESSIONAL AFFILIATIONS:

1. ARIZONA SOCIETY OF PROFESSIONAL ENGINEERS (NSPE), #026 031 821.
2. ORDER OF ENGINEERS (QUEBEC) 1949. #4534.
3. ASSOCIATION OF PROFESSIONAL ENGINEERS, GEOPHYSICISTS & GEOLOGISTS OF ALBERTA #5916.
4. REGISTERED ENGINEERING CONSULTANT - GOVERNMENT OF CANADA, DEPARTMENT OF COMMUNICATIONS. Radio Equipment Approvals.
5. IEEE, Lifetime Member No. 0417204 (member since 1947).

EXPERIENCE:

1. Research/Development/Senior Project Engineer, R.C.A. LIMITED (4 years).
2. Owner/Chief Engineer of Electronics. Design/Manufacturing & Cable TV Companies (10 years).
3. CONSULTING ENGINEER (over 25 years).

MORTON FLOM, P. Eng.

TEST INSTRUMENTATION LIST

All equipment calibrated within last 90 days

ADAPTER

HP X281 (Coaxial waveguide); HP S281; HP 85659 (Quasi peak)

AMPLIFIER

Pre-amp. HP 10885A (2-1300 MHz); HP 8447D, HP 8447E, HP 8449A

ANTENNA See end

ATTENUATOR

Kay 432D; Power, Sierra 661A-30; Narda 76610; Narda 4779-3, -6, -10 dB

AUDIO OSCILLATOR

HP 204D; AIEC DTC-1; Motorola S-1333B; HP 3312A; HP 8903A

BATTERY

Sears Diehard, Stock #4341

CAMERA

Oscilloscope, Tektronix C5A; Polaroid Impulse AF; Kodak DC-50

CAPACITOR

Feed-Thru, 10 μ F, Solar 6512-106R; Solar 7525-1

CLOSE FIELD PROBE

HP 11940A, 11941A, HP 11945A

COMPUTER

HP 332; HP Vectra 486/25VL; Various PC Compatibles

CONVERTOR, Down

HP 117 10B

COUPLER

Narda 1080, Waveguide; HP S750E (Cross guide); Waveline 274/40; Solar 7415-3; Solar 7835-891 & -896

CURRENT PROBE

Solar 6741-1

DETECTOR

HP 8470B

DIGITAL MULTIMETER

HP 3476A w/H.F. Probe; Fluke 8030A-01; HP 3478A

DISTORTION ANALYZER

HP 334A; HP 8903A

ELECTRONIC COUNTER

HP 5383A; HP 5334B

FILTER

Circuit FHT/7-50-57/50-1A/1B (HP); Jerrold TLB-1; THB-1, Piezo 5064; Eagle TNF-I Series, Krohn-Hite 3202; Phelps-Dodge #PD-495-8; Newton #PD6000 Line Protector; 870-890 MHz (Lab Design); 900 MHz (Lab Design); Solar High-Pass s/n 882029

FREQ. DEV. METER

HP 8901A

FREQ. DOUBLER

HP 11721A

FREQUENCY METER

HP 537A; HP 536A

GENERATOR

Solar 6550-1 (power sweep); HP 8640B, GAW 1012, HP 8656A (signal); Solar 8282-1 (spike)

HUMIDITY CHAMBER

Ember Co FW30; Bowser 0

LIMITER, R.F.

HP 11867A; HP 11693A; HP 10509A

LISN

Singer 91221-1; Ailtech 94641-1 (50 μ H)

LOAD, POWER

Telewave TLW-25; Bird 8329

MILLIAMETER

HP 428B

MIXER

HP 10514A; Mini-Circuits TAK-1H

OPEN FIELD SITE

As filed with FCC & IC and kept up-dated.

TURNABLES:

Up to 2000# capacity

GROUND SCREEN:

Complies with docket 80-284

ANTENNA MAST:

Complies as above

OSCILLOSCOPE

HP 1741A; HP 181T; Tektronix T935; HP 54502A

PHANTOM

M.F.A. Labs Left and Right human head

PLOTTER

HP 7470; HP7475A

POWER METER

AF GR 1840A; HP 435A with 8481A & 8482H Power Sensors; HP 436A; HP 8901A

POWER SUPPLY

HP 6286A; Heathkit 1P 2711; 1P 5220; Honda EM400 (portable gas gen.); HP 6012

PRINTER

Brother HL-8; Brother HL-10V; HP DeskJet 640C

R. F. PRESELECTOR

HP 85685A

RADIATION METER

Narda 8717 w/8010 Amp, 8021B and 8760 probes

RESISTOR, PRECISION

Solar 7144-1.0, 7144-10.0; Solar 8525-1

SCALE

Weigh-Tronix 3632T-50

SCANNER

HP 9190A Scanjet

SCREEN ROOM

Lindgren 22-2/2-0

SIGNAL LEVEL METER

Jerrold 704B

SIGNAL SAMPLER

R. F. Bird 4273-030, 4275-030

SINAD/VOLTMETER

Helper Sinadder

SPECTRUM ANALYZER

HP 8558B, 8557; HP 8563E; HP 853A; HP 8566B/8568B

TEMPERATURE CHAMBER

Tenney, Jr

TEMPERATURE PROBE

Fluke 80T-150C

TERMINATION

Narda 320B Waveguide, Waveline #281

TEST SET

Semi-Automatic; HP 8953A; HP 8954A Interface; Computer / Controller; P.S. Programmer; HP 59501A; RF Communications; HP 8920A

TRANSFORMERS

Audio Isolation: Solar 6220-1A; Impedance: HP 11694A; Isolation: Solar 7032-1; Matching: Solar 7033-1

TRANSMISSION & NOISE

MEASURING SET

HP 3555B

VIBRATION CHAMBER

Unholtz-Dickie T 500; Unholtz-Dickie T 4000

VOLTMETER

HP 410C; HP 3478A

WATTMETER

Bird 43, Sierra 174A-2

ANTENNAS

30 - 50 Hz
Emco 7603 M-Field; Emco 7604 M-Field

20 - 200 MHz

Apriel Biconical Model AAB20200

20 - 300 MHz

Emco Biconical H-Field

25 - 1000 MHz

Singer DM-105A; EMCO 3121C

200 - 1000 MHz

Apriel Log Periodic, Model AALP 2001

10 kHz - 30 MHz

Emco 3107B, E-Field; Emco 3101B/1, Rod E-Field

10 kHz - 32 MHz

Singer 94593-1 (Loop)

150 kHz - 32 MHz

Singer 92197-1 (41")

150 kHz - 32 MHz

Singer 93049-1 (9')

1 - 10 GHz

Singer 90794-A Discone

1 - 18 GHz

Horn: Apriel Model AAH-118

18 - 40 GHz

Emco 3116, Horn

40 - 60 GHz

Horn: HP 11970U, HP 11971U,

HP 11975A (Lo Drive

Amplifier)

50 - 75 GHz

Mixer, HP 11970V, HP 11971V

75 - 110 GHz

Mixer, HP 11970W