

DISPLAY-UNIT

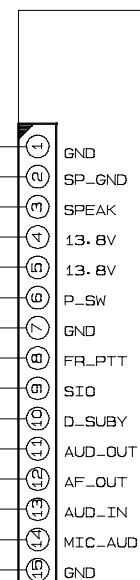

MAIN-UNIT

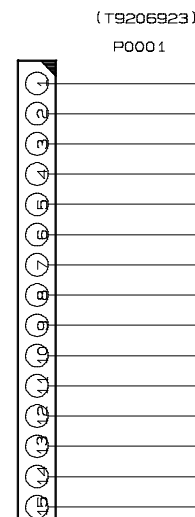
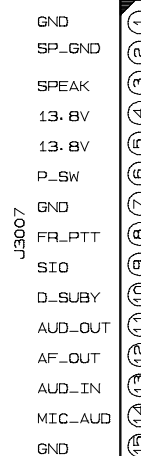
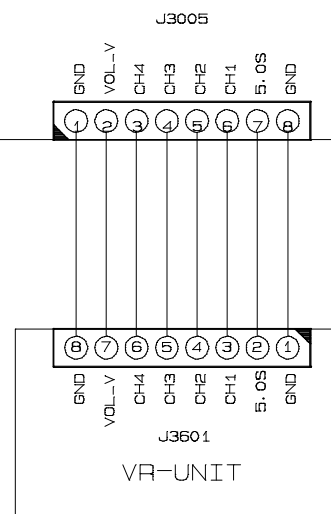
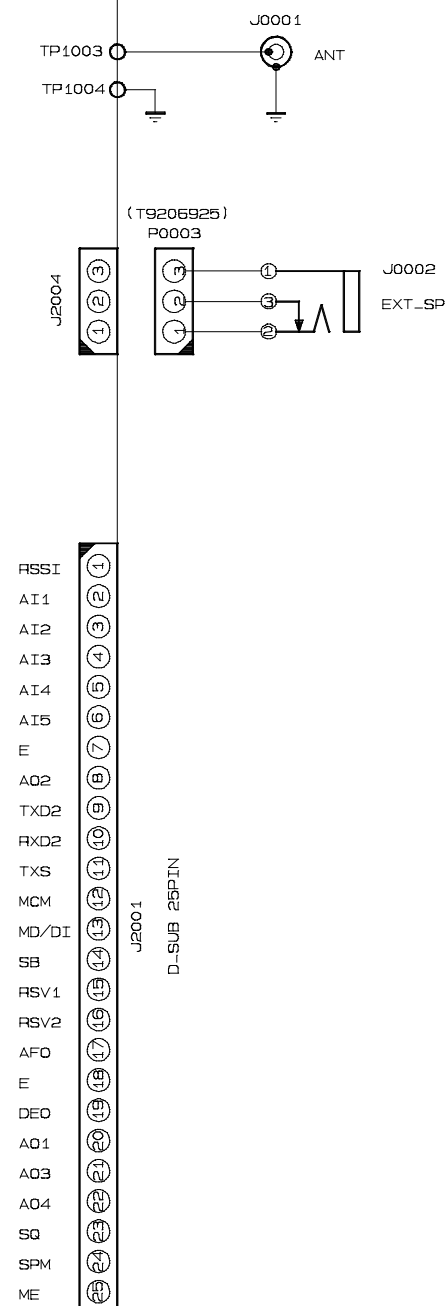
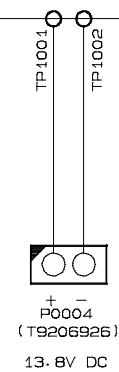
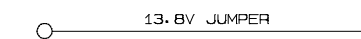
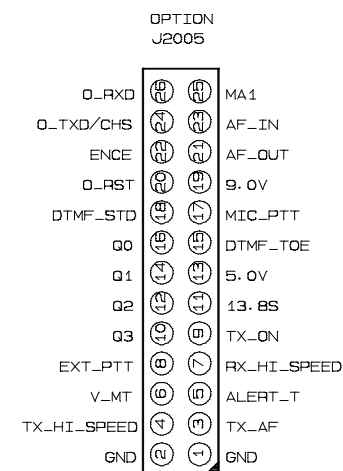

CIRCUIT DIAGRAM	MODEL VX-4000L
DES. B-AC005L0000/CONNECTION-DIAGRAM	
REF. BP0082100.cir/001.sht	EDITION
DATE 2000.07.12	UPDATE 2001.02.13
VERTEX STANDARD CO.,LTD.	