

MFA **M. Flom Associates, Inc. - Global Compliance Center**
3356 North San Marcos Place, Suite 107, Chandler, Arizona 85225-7176
www.mflom.com general@mflom.com (480) 926-3100, FAX: 926-3598

Date: November 7, 2001

Federal Communications Commission
Via: Electronic Filing

Attention: Authorization & Evaluation Division

Applicant: Vertex Standard Co., Ltd.
Equipment: VX-2500U
FCC ID: K66VX-2500U
FCC Rules: 90, 90.210, 95

Gentlemen:

On behalf of the Applicant, enclosed please find Application Form 731, Engineering Test Report and all pertinent documentation, the whole for approval of the referenced equipment as shown.

Filing fees are attached.

We trust the same is in order. Should you need any further information, kindly contact the writer who is authorized to act as agent.

Sincerely yours,

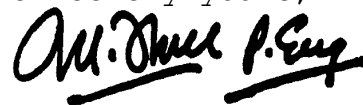

Morton Flom, P. Eng.

enclosure(s)
cc: Applicant
MF/cvr

LIST OF EXHIBITS
 (FCC **CERTIFICATION** (TRANSMITTERS) - REVISED 9/28/98)

APPLICANT: Vertex Standard Co., Ltd.

FCC ID: K66VX-2500U

BY APPLICANT:

- | | |
|--|---|
| 1. LETTER OF AUTHORIZATION | x |
| 2. IDENTIFICATION DRAWINGS, 2.1033(c) (11) | |
| <u>x</u> LABEL | |
| <u>x</u> LOCATION OF LABEL | |
| <u>x</u> COMPLIANCE STATEMENT | |
| <u>x</u> LOCATION OF COMPLIANCE STATEMENT | |
| 3. PHOTOGRAPHS, 2.1033(c) (12) | x |
| 4. DOCUMENTATION: 2.1033(c) | |
| (3) USER MANUAL | x |
| (9) TUNE UP INFO | x |
| (10) SCHEMATIC DIAGRAM | x |
| (10) CIRCUIT DESCRIPTION | x |
| BLOCK DIAGRAM | x |
| PARTS LIST | x |
| ACTIVE DEVICES | x |
| 5. PART 90.203(e) & (g) ATTESTATION | x |
| 6. MPE Report | x |

BY M.F.A. INC.

- A. TESTIMONIAL & STATEMENT OF CERTIFICATION
- B. STATEMENT OF QUALIFICATIONS

MFA **M. Flom Associates, Inc. - Global Compliance Center**
3356 North San Marcos Place, Suite 107, Chandler, Arizona 85225-7176
www.mflom.com general@mflom.com (480) 926-3100, FAX: 926-3598

T R A N S M I T T E R C E R T I F I C A T I O N

of

FCC ID: K66VX-2500U
MODEL: VX-2500U

to

FEDERAL COMMUNICATIONS COMMISSION

Rule Part(s) 90, 90.210, 95

DATE OF REPORT: November 7, 2001

ON THE BEHALF OF THE APPLICANT:

Vertex Standard Co., Ltd.

AT THE REQUEST OF:

P.O. UPS Oct 31, 2001

Vertex Standard USA Inc.
17210 Edwards Rd.
Cerritos, CA 90703

Attention of:

Mikio Maruya, Executive Vice President
(800) 255-9237; FAX: (800) 477-9237
(562) 404-2700, x280; FAX: -1210
m.maruya@vxstdusa.com

SUPERVISED BY:



Morton Flom, P. Eng.

THE APPLICANT HAS BEEN CAUTIONED AS TO THE FOLLOWING:

15.21 INFORMATION TO USER.

The users manual or instruction manual for an intentional radiator shall caution the user that changes or modifications not expressly approved by the party responsible for compliance could void the user's authority to operate the equipment.

15.27(a) SPECIAL ACCESSORIES.

Equipment marketed to a consumer must be capable of complying with the necessary regulations in the configuration in which the equipment is marketed. Where special accessories, such as shielded cables and/or special connectors are required to enable an unintentional or intentional radiator to comply with the emission limits in this part, the equipment must be marketed with, i.e. shipped and sold with, those special accessories. However, in lieu of shipping or packaging the special accessories with the unintentional or intentional radiator, the responsible party may employ other methods of ensuring that the special accessories are provided to the consumer, without additional charge.

Information detailing any alternative method used to supply the special accessories for a grant of equipment authorization or retained in the verification records, as appropriate. The party responsible for the equipment, as detailed in § 2.909 of this chapter, shall ensure that these special accessories are provided with the equipment. The instruction manual for such devices shall include appropriate instructions on the first page of text concerned with the installation of the device that these special accessories must be used with the device. It is the responsibility of the user to use the needed special accessories supplied with the equipment.

TABLE OF CONTENTS

<u>RULE</u>	<u>DESCRIPTION</u>	<u>PAGE</u>
	Test Report	1
2.1033(c)	General Information Required	2
2.1033(c) (14)	Rule Summary	6
	Standard Test Conditions and Engineering Practices	7
2.1046(a)	Carrier Output Power (Conducted)	8
2.1046(a)	ERP Carrier Power (Radiated)	10
2.1051	Unwanted Emissions (Transmitter Conducted)	11
2.1053(a)	Field Strength of Spurious Radiation	15
2.1049(c) (1)	Emission Masks (Occupied Bandwidth)	19
90.214	Transient Frequency Behavior	26
2.1047(a)	Audio Low Pass Filter (Voice Input)	32
2.1047(a)	Audio Frequency Response	35
2.1047(b)	Modulation Limiting	37
2.1055(a) (1)	Frequency Stability (Temperature Variation)	40
2.1055(b) (1)	Frequency Stability (Voltage Variation)	43
2.202(g)	Necessary Bandwidth and Emission Bandwidth	44

PAGE NO. 1 of 44.

Required information per ISO/IEC Guide 25-1990, paragraph 13.2:

- a) TEST REPORT
- b) Laboratory: M. Flom Associates, Inc.
(FCC: 31040/SIT) 3356 N. San Marcos Place, Suite 107
(Canada: IC 2044) Chandler, AZ 85225
- c) Report Number: d01b0023
- d) Client: Vertex Standard USA Inc.
17210 Edwards Rd.
Cerritos, CA 90703
- e) Identification: VX-2500U
FCC ID: K66VX-2500U
EUT Description: UHF FM Mobile Transceiver
- f) EUT Condition: Not required unless specified in individual tests.
- g) Report Date: November 7, 2001
EUT Received: October 31, 2001
- h, j, k): As indicated in individual tests.
- i) Sampling method: No sampling procedure used.
- l) Uncertainty: In accordance with MFA internal quality manual.
- m) Supervised by: 
Morton Flom, P. Eng.
- n) Results: The results presented in this report relate only to the item tested.
- o) Reproduction: This report must not be reproduced, except in full, without written permission from this laboratory.

PAGE NO. 2 of 44.

LIST OF GENERAL INFORMATION REQUIRED FOR CERTIFICATION

IN ACCORDANCE WITH FCC RULES AND REGULATIONS,
VOLUME II, PART 2 AND TO

90, 90.210, 95

Sub-part 2.1033

(c) (1): NAME AND ADDRESS OF APPLICANT:

Vertex Standard Co., Ltd.
4-8-8 Nakameguro, Meguro-Ku
Tokyo 153-8644 Japan

MANUFACTURER:

Applicant

(c) (2): FCC ID: K66VX-2500U

MODEL NO: VX-2500U

(c) (3): INSTRUCTION MANUAL(S):

PLEASE SEE ATTACHED EXHIBITS

(c) (4): TYPE OF EMISSION: 16K0F3E, 11K0F3E

(c) (5): FREQUENCY RANGE, MHz: 450 to 490

(c) (6): POWER RATING, Watts: 5 to 25
___ Switchable x Variable ___ N/A

FCC GRANT NOTE: BE - The output power is continuously variable from the value listed in this entry to 15%-20% of the value listed.

(c) (7): MAXIMUM POWER RATING, Watts: 300

DUT RESULTS: Passes x Fails

PAGE NO.

3 of 44.

INFORMATION FOR PUSH-TO-TALK DEVICES

Type and number of antenna to be used for this device:

One, $\frac{1}{4}$ wave helix

Maximum antenna gain for antenna indicated above:

0 dbd

Can this device sustain continuous operation with respect to its hardware capabilities and allowable operating functions?

No

Other hardware or operating restrictions that could limit a person's RF Exposure:

See Instructions to Installers and Users

Source-based time-averaging (see 2.1093 of rules) applicable to reduce the average output power:

No

If device has headset and belt-clip accessories that would allow body-worn operations, what is the minimum separation distance between the antenna and the user's body in this operating configuration?

N/A

Can device access wire-line services to make phone calls, either directly or through an operator?

No

Can specific operating instructions be given to users to eliminate any potential RF Exposure concerns for both front-of-the-face and body-worn operating configurations?

N/A

Other applicable information the applicant may provide that can serve as effective means for ensuring RF Exposure compliance:

See Instructions to Installers and Users

M. Flom Associates, Inc. is accredited by the American Association for Laboratory Accreditation (A2LA) as shown in the scope below.



THE AMERICAN ASSOCIATION FOR LABORATORY ACCREDITATION

ACCREDITED LABORATORY

A2LA has accredited

M. FLOM ASSOCIATES, INC.
Chandler, AZ

for technical competence in the field of

Electrical (EMC) Testing

The accreditation covers the specific tests and types of tests listed on the agreed scope of accreditation. This laboratory meets the requirements of ISO/IEC 17025 - 1999 "General Requirements for the Competence of Testing and Calibration Laboratories" and any additional program requirements in the identified field of testing. Testing and calibration laboratories that comply with this International Standard also operate in accordance with ISO 9001 or ISO 9002.

Presented this 2nd day of March, 2001.



Peter Mlynek
President
For the Accreditation Council
Certificate Number 1008.01
Valid to December 31, 2002

For tests or types of tests to which this accreditation applies, please refer to the laboratory's Electrical (EMC) Scope of Accreditation



American Association for Laboratory Accreditation

SCOPE OF ACCREDITATION TO ISO/IEC 17025-1999

M. FLOM ASSOCIATES, INC.
Electronic Testing Laboratory
3356 North San Marcos Place, Suite 107
Chandler, AZ 85225
Morton Flom Phone: 480 926 3100

ELECTRICAL (EMC)

Valid to: December 31, 2002 Certificate Number: 1008-01

In recognition of the successful completion of the A2LA evaluation process, accreditation is granted to this laboratory to perform the following electromagnetic compatibility tests:

Tests	Standard(s)
RF Emissions	FCC Part 15 (Subparts B and C) using ANSI C63.4-1992; CISPR 11; CISPR 13; CISPR 14; CISPR 22; EN 55011; EN 55013; EN 55014; EN 55022; EN 50081-1; EN 50081-2; ICES-003; AS/NZS 1044; AS/NZS 1053; AS/NZS 3548; AS/NZS 4251.1; CNS 13438
Harmonic Currents	EN 61000-3-2
Fluctuation and Flicker	EN 61000-3-3
RF Immunity	EN: 50082-1, 50082-2 (both excluding "Power Frequency Magnetic Field Immunity" and "Voltage Dips, Short Interruptions, and Line Voltage Variations"); AS/NZS 4251.1
Radiated Susceptibility	EN 61000-4-3; ENV 50140; ENV 50204; IEC 1000-4-3; IEC 801-3
EFT	EN 61000-4-4; IEC 1000-4-4; IEC 801-4
Surge	EN 61000-4-5; ENV 50142; IEC 1000-4-5; IEC 801-5
47 CFR (FCC)	2, 21, 22, 23, 24, 74, 80, 87, 90, 95, 97

Peter Mlynek

5301 Buckeystown Pike, Suite 350 • Frederick, MD 21704-8373 • Phone: 301-644 3248 • Fax: 301-662 2974



"This laboratory is accredited by the American Association for Laboratory Accreditation (A2LA) and the results shown in this report have been determined in accordance with the laboratory's terms of accreditation unless stated otherwise in the report."

Should this report contain any data for tests for which we are not accredited, or which have been undertaken by a subcontractor that is not A2LA accredited, such data would not covered by this laboratory's A2LA accreditation.

PAGE NO. 5 of 44.

Subpart 2.1033 (continued)

(c) (8): VOLTAGES & CURRENTS IN ALL ELEMENTS IN FINAL R. F. STAGE, INCLUDING FINAL TRANSISTOR OR SOLID STATE DEVICE:

COLLECTOR CURRENT, A = per manual
 COLLECTOR VOLTAGE, Vdc = per manual
 SUPPLY VOLTAGE, Vdc = 13.8

(c) (9): TUNE-UP PROCEDURE:

PLEASE SEE ATTACHED EXHIBITS

(c) (10): CIRCUIT DIAGRAM/CIRCUIT DESCRIPTION:

Including description of circuitry & devices provided for determining and stabilizing frequency, for suppression of spurious radiation, for limiting modulation and limiting power.

PLEASE SEE ATTACHED EXHIBITS

(c) (11): LABEL INFORMATION:

PLEASE SEE ATTACHED EXHIBITS

(c) (12): PHOTOGRAPHS:

PLEASE SEE ATTACHED EXHIBITS

(c) (13): DIGITAL MODULATION DESCRIPTION:

ATTACHED EXHIBITS

 x N/A

(c) (14): TEST AND MEASUREMENT DATA:

FOLLOWS

PAGE NO.

6 of 44.

Sub-part
2.1033(c) (14):TEST AND MEASUREMENT DATA

All tests and measurement data shown were performed in accordance with FCC Rules and Regulations, Volume II; Part 2, Sub-part J, Sections 2.947, 2.1033(c), 2.1041, 2.1046, 2.1047, 2.1079, 2.1051, 2.1053, 2.1055, 2.1057 and the following individual Parts:

- 21 - Domestic Public Fixed Radio Services
- 22 - Public Mobile Services
- 22 Subpart H - Cellular Radiotelephone Service
- 22.901(d) - Alternative technologies and auxiliary services
- 23 - International Fixed Public Radiocommunication services
- 24 - Personal Communications Services
- 74 Subpart H - Low Power Auxiliary Stations
- 80 - Stations in the Maritime Services
- 80 Subpart E - General Technical Standards
- 80 Subpart F - Equipment Authorization for Compulsory Ships
- 80 Subpart K - Private Coast Stations and Marine Utility Stations
- 80 Subpart S - Compulsory Radiotelephone Installations for Small Passenger Boats
- 80 Subpart T - Radiotelephone Installation Required for Vessels on the Great Lakes
- 80 Subpart U - Radiotelephone Installations Required by the Bridge-to-Bridge Act
- 80 Subpart V - Emergency Position Indicating Radiobeacons (EPIRB'S)
- 80 Subpart W - Global Maritime Distress and Safety System (GMDSS)
- 80 Subpart X - Voluntary Radio Installations
- 87 - Aviation Services
- 90 - Private Land Mobile Radio Services
- 94 - Private Operational-Fixed Microwave Service
- 95 Subpart A - General Mobile Radio Service (GMRS)
- 95 Subpart C - Radio Control (R/C) Radio Service
- 95 Subpart D - Citizens Band (CB) Radio Service
- 95 Subpart E - Family Radio Service
- 95 Subpart F - Interactive Video and Data Service (IVDS)
- 97 - Amateur Radio Service
- 101 - Fixed Microwave Services

PAGE NO.

7 of 44.

STANDARD TEST CONDITIONS
and
ENGINEERING PRACTICES

Except as noted herein, the following conditions and procedures were observed during the testing:

In accordance with ANSI C63.4-1992/2000 Draft, section 6.1.9, and unless otherwise indicated in the specific measurement results, the ambient temperature of the actual EUT was maintained within the range of 10° to 40°C (50° to 104 °F) unless the particular equipment requirements specify testing over a different temperature range. Also, unless otherwise indicated, the humidity levels were in the range of 10% to 90% relative humidity.

Prior to testing, the EUT was tuned up in accordance with the manufacturer's alignment procedures. All external gain controls were maintained at the position of maximum and/or optimum gain throughout the testing.

Measurement results, unless otherwise noted, are worst case measurements.

PAGE NO. 8 of 44.
NAME OF TEST: Carrier Output Power (Conducted)
SPECIFICATION: 47 CFR 2.1046(a)
GUIDE: ANSI/TIA/EIA-603-1992, Paragraph 2.2.1
TEST EQUIPMENT: As per attached page

MEASUREMENT PROCEDURE

1. The EUT was connected to a resistive coaxial attenuator of normal load impedance, and the unmodulated output power was measured by means of an R. F. Power Meter.
2. Measurement accuracy is $\pm 3\%$.

MEASUREMENT RESULTS
(Worst case)

FREQUENCY OF CARRIER, MHz = 470.1, 449.9, 490.1

POWER SETTING	R. F. POWER, WATTS
Low	5
High	25

PERFORMED BY:

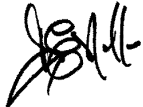
Doug Noble, B.A.S. E.E.T.

TRANSMITTER POWER CONDUCTED MEASUREMENTS

TEST 1: R. F. POWER OUTPUT
 TEST 2: FREQUENCY STABILITY

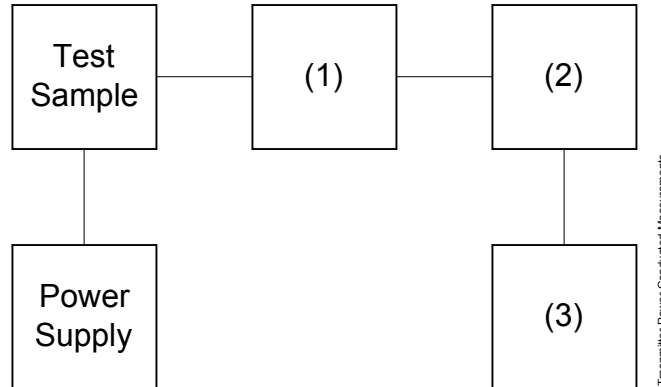

Asset	Description (as applicable)	s/n
(1)	<u>COAXIAL ATTENUATOR</u>	
i00122	Narda 766-10	7802
i00123	Narda 766-10	7802A
i00069	Bird 8329 (30 dB)	1006
i00113	Sierra 661A-3D	1059
(2)	<u>POWER METERS</u>	
i00014	HP 435A	1733A05836
i00039	HP 436A	2709A26776
i00020	HP 8901A POWER MODE	2105A01087
(3)	<u>FREQUENCY COUNTER</u>	
i00042	HP 5383A	1628A00959
i00019	HP 5334B	2704A00347
i00020	HP 8901A FREQUENCY MODE	2105A01087

PAGE NO. 10 of 44.
NAME OF TEST: ERP Carrier Power (Radiated)
SPECIFICATION: TIA/EIA 603A (Substitution Method)

2.2.17.1 Definition: The average radiated power of a licensed device is the equivalent power required, when delivered to a half-wave dipole or horn antenna, to produce at a distant point the same average received power as produced by the licensed device.

2.2.17.2 Method of Measurement:

a) Connect the equipment as illustrated. Place the transmitter to be tested on the turntable in the standard test site.

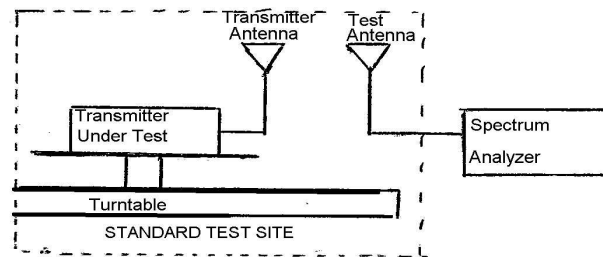

b) Raise and lower the test antenna from 1m to 6 m with the transmitter facing the antenna and record the highest received signal in dB as LVL.

c) Repeat step b) for seven additional readings at 45° interval positions of the turntable.

d) Replace the transmitter under test with a half-wave or horn vertically polarized antenna. The center of the antenna should be at the same location as the transmitter under test. Connect the antenna to a signal generator with a known output power and record the path loss in dB or LOSS.

e) Calculate the average radiated output power from the readings in step c) and d) by the following:

$$\text{average radiated power} = 10 \log_{10} \Sigma 10(\text{LVL} - \text{LOSS})/10 \text{ (dBm)}$$

	RESULTS			Path Loss, db
	449.9 MHz LVL, dbm	470.10 MHz LVL, dbm	490.1 MHz LVL, dbm	
0°	41.7	41.8	41.9	2.1
45°	40.6	40.1	40.2	2.1
90°	40.6	41.4	41.0	2.1
135°	41.4	41.5	41.4	2.1
180°	40.3	40.4	41.7	2.1
225°	41.5	41.0	40.2	2.1
270°	41.3	40.9	40.8	2.1
315°	41.0	41.6	41.0	2.1
	450.013 MHz	465.08 MHz	479.900 MHz	
Av. Radiated Power:	43.15 dbm	43.19 dbm	43.13 dbm	

PAGE NO. 11 of 44.

NAME OF TEST: Unwanted Emissions (Transmitter Conducted)

SPECIFICATION: 47 CFR 2.1051

GUIDE: ANSI/TIA/EIA-603-1992, Paragraph 2.2.13

TEST EQUIPMENT: As per attached page

MEASUREMENT PROCEDURE

1. The emissions were measured for the worst case as follows:
 - (a): within a band of frequencies defined by the carrier frequency plus and minus one channel.
 - (b): from the lowest frequency generated in the EUT and to at least the 10th harmonic of the carrier frequency, or 40 GHz, whichever is lower.
2. The magnitude of spurious emissions that are attenuated more than 20 dB below the permissible value need not be specified.
3. MEASUREMENT RESULTS: ATTACHED FOR WORST CASE

FREQUENCY OF CARRIER, MHz	=	470.1, 449.9, 490.1
SPECTRUM SEARCHED, GHz	=	0 to 10 x F _c
MAXIMUM RESPONSE, Hz	=	2510
ALL OTHER EMISSIONS	=	≥ 20 dB BELOW LIMIT

PERFORMED BY:

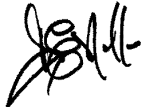
Doug Noble, B.A.S. E.E.T.

TRANSMITTER SPURIOUS EMISSION

TEST A. OCCUPIED BANDWIDTH (IN-BAND SPURIOUS)
 TEST B. OUT-OF-BAND SPURIOUS

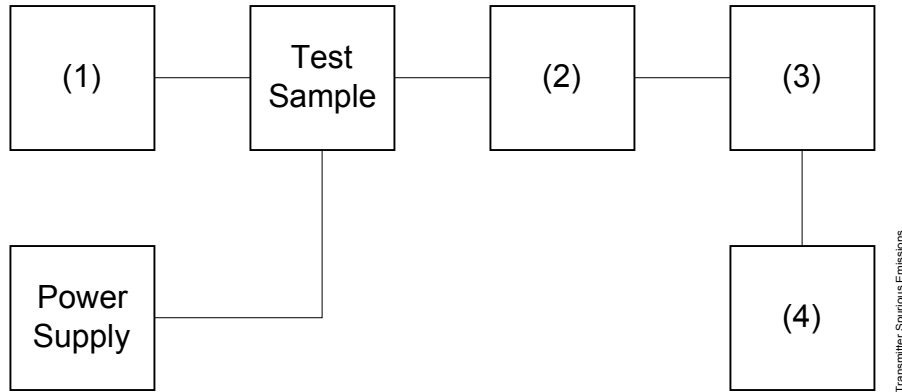

Asset	Description (as applicable)	s/n
(1)	<u>AUDIO OSCILLATOR/GENERATOR</u>	
i00010	HP 204D	1105A04683
i00017	HP 8903A	2216A01753
i00012	HP 3312A	1432A11250
(2)	<u>COAXIAL ATTENUATOR</u>	
i00122	Narda 766-10	7802
i00123	Narda 766-10	7802A
i00069	Bird 8329 (30 dB)	1006
i00113	Sierra 661A-3D	1059
(3)	<u>FILTERS; NOTCH, HP, LP, BP</u>	
i00126	Eagle TNF-1	100-250
i00125	Eagle TNF-1	50-60
i00124	Eagle TNF-1	250-850
(4)	<u>SPECTRUM ANALYZER</u>	
i00048	HP 8566B	2511A01467
i00029	HP 8563E	3213A00104

PAGE NO. 13 of 44.

NAME OF TEST: Unwanted Emissions (Transmitter Conducted)

LIMIT(S), dBc: $-(50+10 \times \text{LOG } P) = -57$ (5 Watts)
 $-(50+10 \times \text{LOG } P) = -64$ (25 Watts)

Low Powerg01b0015: 2001-Nov-01 Thu 08:58:00

FREQUENCY TUNED, MHz	FREQUENCY EMISSION, MHz	LEVEL, dBm	LEVEL, dBc	MARGIN, dB
449.900000	899.418000	-43.9	-80.8	-23.9
470.100000	940.213000	-41.2	-78.1	-21.2
490.100000	980.211000	-42	-78.9	-22
449.900000	1350.030000	-42.9	-79.8	-22.9
470.100000	1410.287000	-42.6	-79.5	-22.6
490.100000	1469.810000	-42.9	-79.8	-22.9
449.900000	1799.968000	-42.2	-79.1	-22.2
470.100000	1879.982000	-42.8	-79.7	-22.8
490.100000	1960.801000	-42.8	-79.7	-22.8
449.900000	2249.343000	-40.7	-77.6	-20.7
470.100000	2350.028000	-41.4	-78.3	-21.4
490.100000	2450.804000	-42	-78.9	-22
449.900000	2699.590000	-44.2	-81.1	-24.2
470.100000	2820.614000	-44.7	-81.6	-24.7
490.100000	2940.781000	-44.6	-81.5	-24.6
449.900000	3149.118000	-45	-81.9	-25
470.100000	3290.381000	-44.1	-81	-24.1
490.100000	3430.635000	-45.3	-82.2	-25.3
449.900000	3599.090000	-45	-81.9	-25
470.100000	3760.311000	-44.8	-81.7	-24.8
490.100000	3920.603000	-44.4	-81.3	-24.4
449.900000	4048.806000	-44.8	-81.7	-24.8
470.100000	4230.878000	-44.7	-81.6	-24.7
490.100000	4410.610000	-43.6	-80.5	-23.6
449.900000	4499.205000	-43.9	-80.8	-23.9
470.100000	4701.100000	-43.5	-80.4	-23.5
490.100000	4901.382000	-44	-80.9	-24
449.900000	4948.522000	-45.2	-82.1	-25.2
470.100000	5171.295000	-44.1	-81	-24.1
490.100000	5391.196000	-44.3	-81.2	-24.3
449.900000	5399.042000	-44.5	-81.4	-24.5
470.100000	5641.041000	-44.3	-81.2	-24.3
449.900000	5848.415000	-39	-75.9	-19
490.100000	5880.710000	-38.4	-75.3	-18.4
470.100000	6111.024000	-37.9	-74.8	-17.9
449.900000	6298.360000	-38.9	-75.8	-18.9
490.100000	6371.532000	-38.4	-75.3	-18.4
470.100000	6581.764000	-38.2	-75.1	-18.2
449.900000	6748.191000	-38.2	-75.1	-18.2
490.100000	6861.305000	-39.4	-76.3	-19.4
470.100000	7051.015000	-38.5	-75.4	-18.5
490.100000	7351.176000	-38.2	-75.1	-18.2

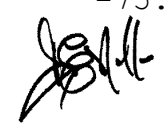

PERFORMED BY:

Doug Noble, B.A.S. E.E.T.

PAGE NO. 14 of 44.

NAME OF TEST: Unwanted Emissions (Transmitter Conducted)

LIMIT(S), dBc: $-(50+10 \times \text{LOG } P) = -57$ (5 Watts)
 $-(50+10 \times \text{LOG } P) = -64$ (25 Watts)

High Powerg01b0014: 2001-Nov-01 Thu 08:55:00

FREQUENCY TUNED, MHz	FREQUENCY EMISSION, MHz	LEVEL, dBm	LEVEL, dBc	MARGIN, dB
449.900000	900.061000	-33	-76.9	-13
470.100000	940.406000	-32.6	-76.5	-12.6
490.100000	979.786000	-33.2	-77.1	-13.2
449.900000	1349.699000	-33.2	-77.1	-13.2
470.100000	1410.256000	-33.6	-77.5	-13.6
490.100000	1470.491000	-32.7	-76.6	-12.7
449.900000	1799.534000	-32.8	-76.7	-12.8
470.100000	1880.361000	-32.3	-76.2	-12.3
490.100000	1960.113000	-32.8	-76.7	-12.8
449.900000	2249.328000	-31.8	-75.7	-11.8
470.100000	2350.872000	-32	-75.9	-12
490.100000	2450.596000	-31.8	-75.7	-11.8
449.900000	2699.144000	-34.2	-78.1	-14.2
470.100000	2820.946000	-34.7	-78.6	-14.7
490.100000	2940.844000	-34.7	-78.6	-14.7
449.900000	3149.285000	-34.9	-78.8	-14.9
470.100000	3290.499000	-34.8	-78.7	-14.8
490.100000	3431.035000	-33.6	-77.5	-13.6
449.900000	3599.059000	-35.2	-79.1	-15.2
470.100000	3760.376000	-34.4	-78.3	-14.4
490.100000	3921.134000	-34.1	-78	-14.1
449.900000	4049.561000	-34.4	-78.3	-14.4
470.100000	4230.877000	-34.2	-78.1	-14.2
490.100000	4411.033000	-33.8	-77.7	-13.8
449.900000	4499.449000	-34.3	-78.2	-14.3
470.100000	4701.177000	-34.3	-78.2	-14.3
490.100000	4901.435000	-34.3	-78.2	-14.3
449.900000	4949.152000	-32.7	-76.6	-12.7
470.100000	5171.257000	-33.8	-77.7	-13.8
490.100000	5390.837000	-34.2	-78.1	-14.2
449.900000	5398.705000	-34.3	-78.2	-14.3
470.100000	5641.436000	-34	-77.9	-14
449.900000	5848.754000	-28.5	-72.4	-8.5
490.100000	5881.648000	-29	-72.9	-9
470.100000	6111.367000	-29.2	-73.1	-9.2
449.900000	6299.071000	-28.4	-72.3	-8.4
490.100000	6370.934000	-27.8	-71.7	-7.8
470.100000	6581.180000	-29	-72.9	-9
449.900000	6748.310000	-28.3	-72.2	-8.3
490.100000	6861.176000	-28.8	-72.7	-8.8
470.100000	7051.266000	-28.4	-72.3	-8.4
490.100000	7351.201000	-27.8	-71.7	-7.8

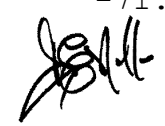

PERFORMED BY:

Doug Noble, B.A.S. E.E.T.

PAGE NO. 15 of 44.
NAME OF TEST: Field Strength of Spurious Radiation
SPECIFICATION: 47 CFR 2.1053(a)
GUIDE: ANSI/TIA/EIA-603-1992, Paragraph 1.2.12

MEASUREMENT PROCEDURE

1.2.12.1 Definition: Radiated spurious emissions are emissions from the equipment when transmitting into a non-radiating load on a frequency or frequencies which are outside an occupied band sufficient to ensure transmission of information of required quality for the class of communications desired.

1.2.12.2 Method of Measurement

- A) Connect the equipment as illustrated
- B) Adjust the spectrum analyzer for the following settings:
 - 1) Resolution Bandwidth ≤ 3 kHz.
 - 2) Video Bandwidth ≥ 10 kHz
 - 3) Sweep Speed ≤ 2000 Hz/second
 - 4) Detector Mode = Positive Peak
- C) Place the transmitter to be tested on the turntable in the standard test site. The transmitter is transmitting into a non-radiating load which is placed on the turntable. The RF cable to this load should be of minimum length.

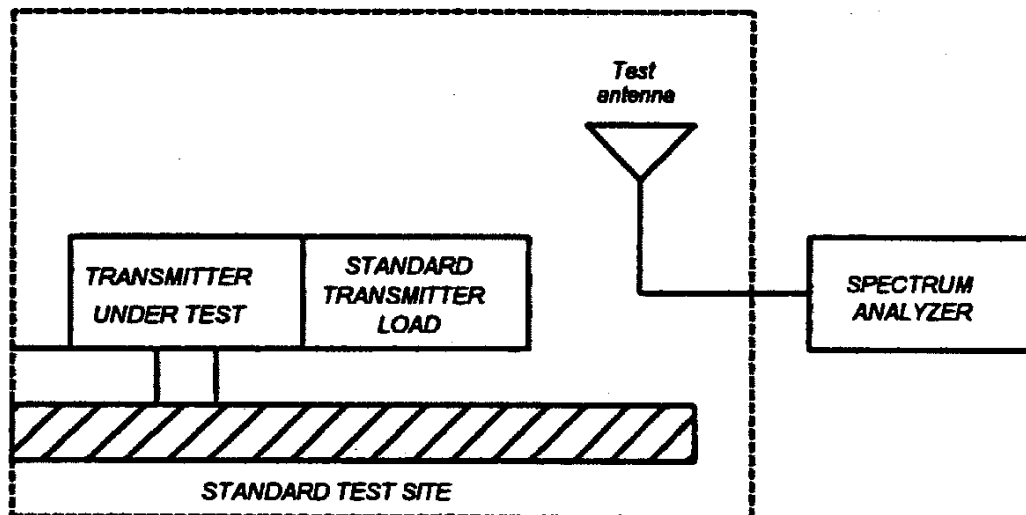

PAGE NO. 16 of 44.

NAME OF TEST: Field Strength of Spurious Radiation (Cont.)

- D) For each spurious measurement the test antenna should be adjusted to the correct length for the frequency involved. This length may be determined from a calibration ruler supplied with the equipment. Measurements shall be made from the lowest radio frequency generated in the equipment to the tenth harmonic of the carrier, except for the region close to the carrier equal to \pm the test bandwidth (see section 1.3.4.4).
- E) For each spurious frequency, raise and lower the test antenna from 1 m to 4 m to obtain a maximum reading on the spectrum analyzer with the test antenna at horizontal polarity. Repeat this procedure to obtain the highest possible reading. Record this maximum reading.
- F) Repeat step E) for each spurious frequency with the test antenna polarized vertically.

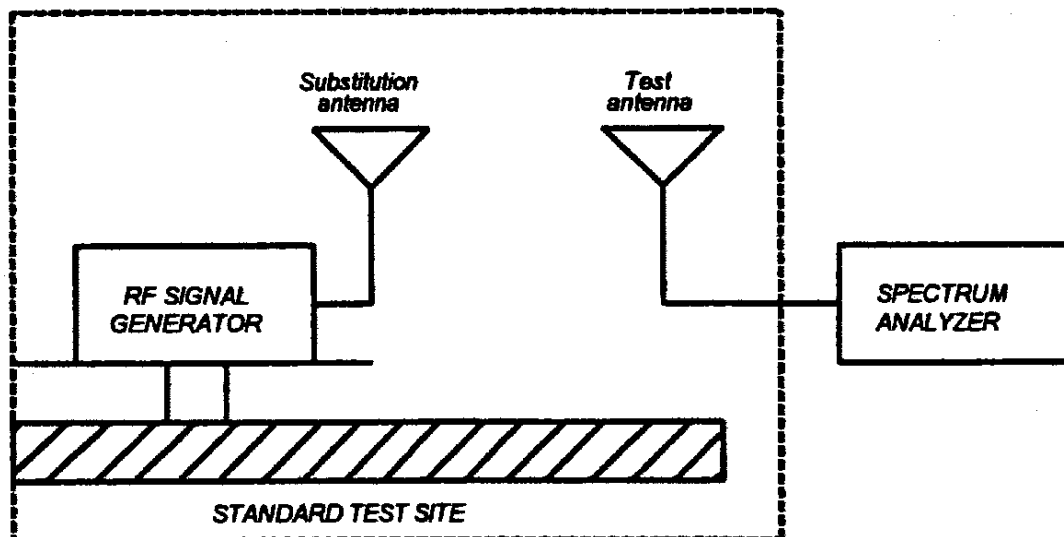

- G) Reconnect the equipment as illustrated.
- H) Keep the spectrum analyzer adjusted as in step B).
- I) Remove the transmitter and replace it with a substitution antenna (the antenna should be half-wavelength for each frequency involved). The center of the substitution antenna should be approximately at the same location as the center of the transmitter. At lower frequencies, where the substitution antenna is very long, this will be impossible to achieve when the antenna is polarized vertically. In such case the lower end of the antenna should be 0.3 m above the ground.

PAGE NO. 17 of 44.

NAME OF TEST: Field Strength of Spurious Radiation (Cont.)

- J) Feed the substitution antenna at the transmitter end with a signal generator connected to the antenna by means of a non-radiating cable. With the antennas at both ends horizontally polarized and with the signal generator tuned to a particular spurious frequency, raise and lower the test antenna to obtain a maximum reading at the spectrum analyzer. Adjust the level of the signal generator output until the previously recorded maximum reading for this set of conditions is obtained. This should be done carefully repeating the adjustment of the test antenna and generator output.
- K) Repeat step J) with both antennas vertically polarized for each spurious frequency.
- L) Calculate power in dBm into a reference ideal half-wave dipole antenna by reducing the readings obtained in steps J) and K) by the power loss in the cable between the generator and the antenna and further corrected for the gain of the substitution antenna used relative to an ideal half-wave dipole antenna.
- M) The levels recorded in step L) are absolute levels of radiated spurious emissions in dBm. The radiated spurious emissions in dB can be calculated by the following:

$$\text{Radiated spurious emissions dB} = 10\log_{10}(\text{TX power in watts}/0.001) - \text{the levels in step l)}$$

NOTE: It is permissible that other antennas provided can be referenced to a dipole.

Test Equipment:

Asset Description (as applicable)	s/n	Cycle	Last Cal
<u>TRANSDUCER</u>			
i00088 EMCO 3109-B 25MHz-300MHz	2336	12 mo.	Sep-01
i00065 EMCO 3301-B Active Monopole	2635	12 mo.	Sep-01
i00089 Aprel 2001 200MHz-1GHz	001500	12 mo.	Sep-01
i00103 EMCO 3115 1GHz-18GHz	9208-3925	12 mo.	Sep-01
<u>AMPLIFIER</u>			
i00028 HP 8449A	2749A00121	12 mo.	Mar-01
<u>SPECTRUM ANALYZER</u>			
i00029 HP 8563E	3213A00104	12 mo.	Aug-01
i00033 HP 85462A	3625A00357	12 mo.	May-01
i00048 HP 8566B	2511AD1467	6 mo.	Nov-01
<u>MICROPHONE, ANTENNA PORT, AND CABELING</u>			
Microphone	Yes/No <u>Y</u>	Cable Length <u>1.0</u>	Meters
Antenna Port Terminated	Yes/No <u>Y</u>	Load <u>N/A</u>	Antenna Gain <u>0dbd</u>
All Ports Terminated by	Load <u>N/A</u>	Peripheral <u>N/A</u>	

PAGE NO. 18 of 44.

NAME OF TEST: Field Strength of Spurious Radiation
 g01b0024: 2001-Nov-05 Mon 09:40:00
 STATE: 2:High Power

FREQUENCY TUNED, MHz	FREQUENCY EMISSION, MHz	ERP, dBm	ERP, dBc
470.100000	940.190000	-32.4	≤-73.5
470.100000	1410.295000	-32.6	≤-73.5
470.100000	1880.395100	-38.6	≤-73.5
470.100000	2350.520200	-29.5	≤-73.5
470.100000	2820.599000	-30.6	≤-73.5
470.100000	3290.687667	-44.8	≤-73.5
470.100000	3760.785500	-45.7	≤-73.5
470.100000	4230.897500	-47.6	≤-73.5
470.100000	4701.002166	-48.9	≤-73.5

SUPERVISED BY:

 Doug Noble, B.A.S. E.E.T.

PAGE NO. 19 of 44.
NAME OF TEST: Emission Masks (Occupied Bandwidth)
SPECIFICATION: 47 CFR 2.1049(c) (1)
GUIDE: ANSI/TIA/EIA-603-1992, Paragraph 2.2.11
TEST EQUIPMENT: As per previous page

MEASUREMENT PROCEDURE

1. The EUT and test equipment were set up as shown on the following page, with the Spectrum Analyzer connected.
2. For EUTs supporting audio modulation, the audio signal generator was adjusted to the frequency of maximum response and with output level set for $\pm 2.5/\pm 1.25$ kHz deviation (or 50% modulation). With level constant, the signal level was increased 16 dB.
3. For EUTs supporting digital modulation, the digital modulation mode was operated to its maximum extent.
4. The Occupied Bandwidth was measured with the Spectrum Analyzer controls set as shown on the test results.
5. MEASUREMENT RESULTS: ATTACHED

PAGE NO. 20 of 44.

NAME OF TEST: Emission Masks (Occupied Bandwidth)
g01b0009: 2001-Nov-01 Thu 08:41:00
STATE: 1:Low Power

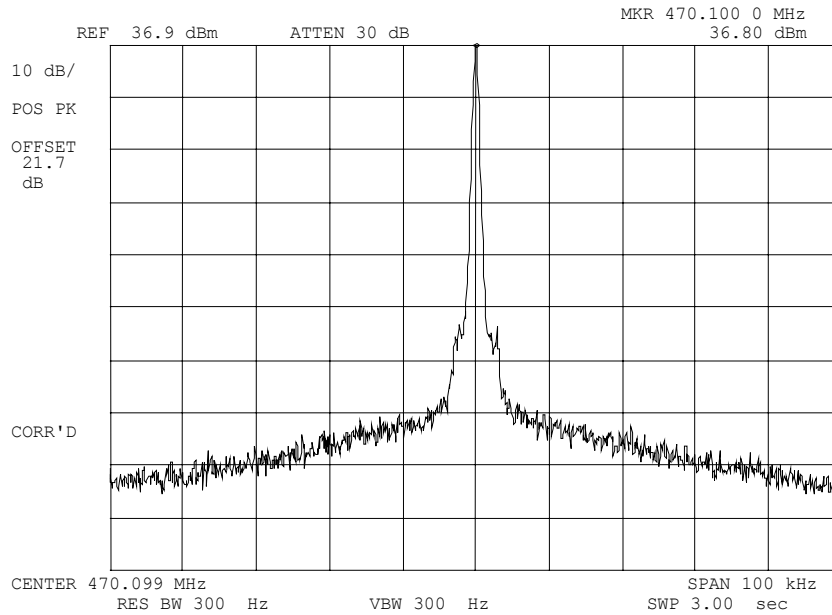

POWER: LOW
MODULATION: NONE

PERFORMED BY:

Doug Noble, B.A.S. E.E.T.

PAGE NO. 21 of 44.

NAME OF TEST: Emission Masks (Occupied Bandwidth)
g01b0010: 2001-Nov-01 Thu 08:46:00
STATE: 1:Low Power

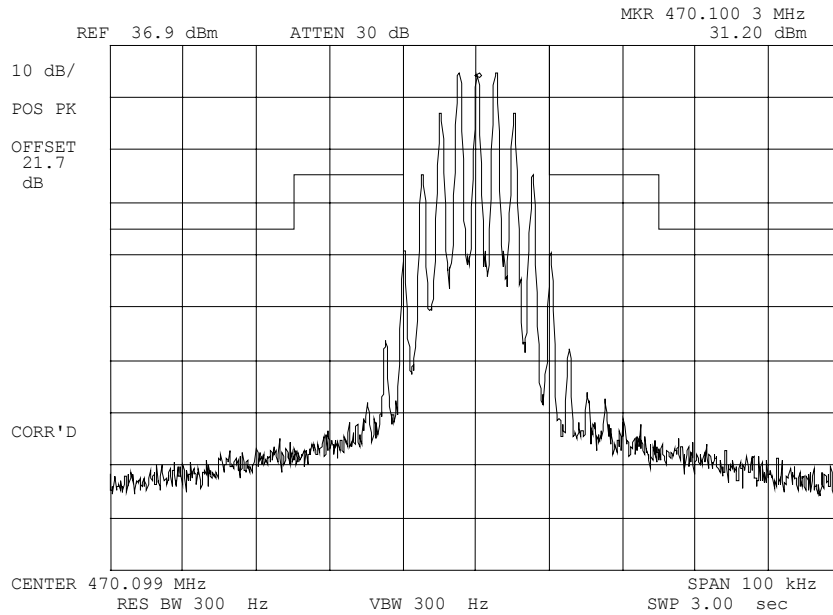

POWER:
MODULATION:

LOW
VOICE: 2500 Hz SINE WAVE
MASK: B, VHF/UHF 25kHz,
w/LPF

PERFORMED BY:

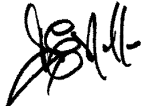
Doug Noble, B.A.S. E.E.T.

PAGE NO. 22 of 44.

NAME OF TEST: Emission Masks (Occupied Bandwidth)
g01b0013: 2001-Nov-01 Thu 08:52:00
STATE: 1:Low Power

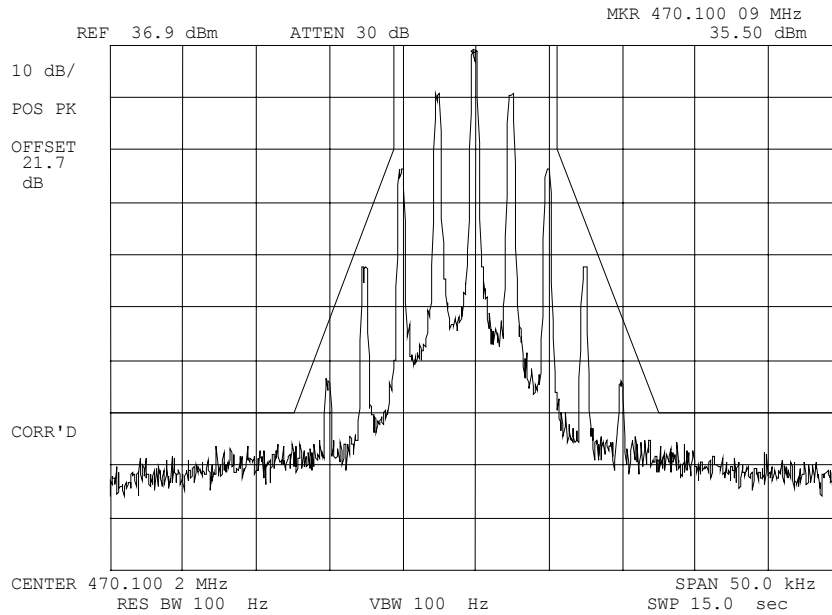

POWER:
MODULATION:

LOW
VOICE: 2500 Hz SINE WAVE
MASK: D, VHF/UHF 12.5kHz BW

PERFORMED BY:

Doug Noble, B.A.S. E.E.T.

PAGE NO. 23 of 44.

NAME OF TEST: Emission Masks (Occupied Bandwidth)
g01b0008: 2001-Nov-01 Thu 08:39:00
STATE: 2:High Power

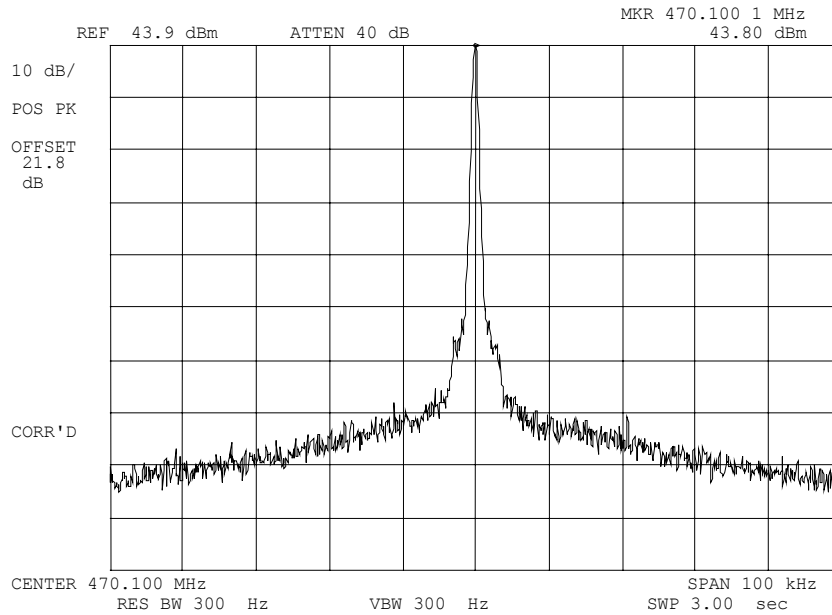

POWER: HIGH
MODULATION: NONE

PERFORMED BY:

Doug Noble, B.A.S. E.E.T.

PAGE NO. 24 of 44.

NAME OF TEST: Emission Masks (Occupied Bandwidth)
g01b0011: 2001-Nov-01 Thu 08:47:00
STATE: 2:High Power

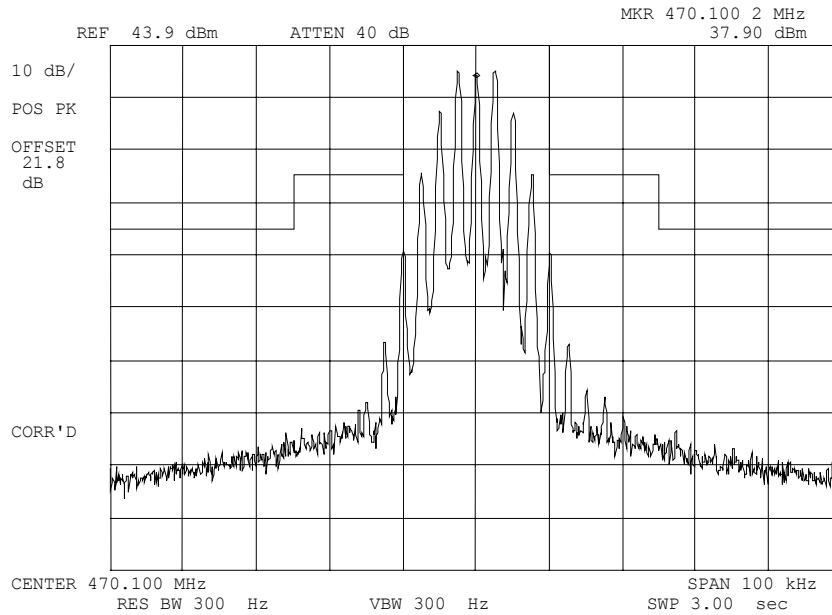

POWER: HIGH
MODULATION: VOICE: 2500 Hz SINE WAVE
MASK: B, VHF/UHF 25kHz,
w/LPF

PERFORMED BY:

Doug Noble, B.A.S. E.E.T.

PAGE NO. 25 of 44.

NAME OF TEST: Emission Masks (Occupied Bandwidth)
g01b0012: 2001-Nov-01 Thu 08:51:00
STATE: 2:High Power

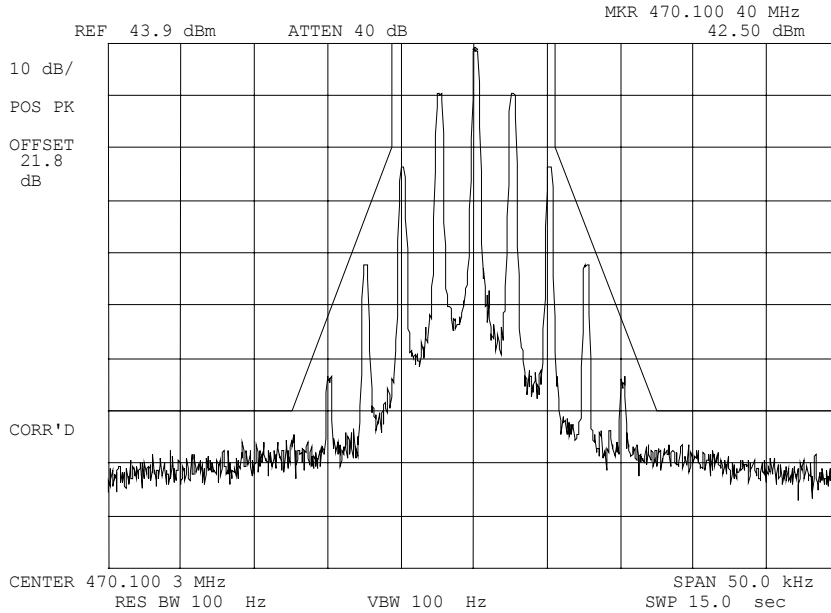

POWER:	HIGH
MODULATION:	VOICE: 2500 Hz SINE WAVE
	MASK: D, VHF/UHF 12.5kHz BW

PERFORMED BY:

Doug Noble, B.A.S. E.E.T.

PAGE NO. 26 of 44.
NAME OF TEST: Transient Frequency Behavior
SPECIFICATION: 47 CFR 90.214
GUIDE: ANSI/TIA/EIA-603-1992, Paragraph 2.2.19
TEST EQUIPMENT: As per attached page

MEASUREMENT PROCEDURE

1. The EUT was setup as shown on the attached page, following TIA/EIA-603 steps a, b, and c as a *guide*.
2. The transmitter was turned on.
3. Sufficient attenuation was provided so that the transmitter carrier level measured at the output of the combiner was 40 dB below the maximum input level of the test receiver. This level was recorded as step f.
4. The transmitter was turned off.
5. An RF signal generator (1) modulated with a 1 kHz tone at either 25, 12.5, or 6.25 kHz deviation, and set to the same frequency as the assigned transmitter frequency, (2) was adjusted to a level -20 dB below the level recorded for step f, as measured at the output of the combiner. This level was then fixed for the remainder of the test and is recorded at step h.
6. The oscilloscope was setup using TIA/EIA-603 steps j and k as a guide, and to either 10 ms/div (UHF) or 5 ms/div (VHF).
7. The 30 dB attenuator was removed, the transmitter was turned on, and the level of the carrier at the output of the combiner was recorded as step l.
8. The carrier on-time as referenced in TIA/EIA-603 steps m, n, and o was captured and plotted. The carrier off-time as referenced in TIA/EIA-603 steps p, q, r, and s was captured and plotted.

LEVELS MEASURED:

<u>step f</u> , dBm	= -14.4
<u>step h</u> , dBm	= -37.7
<u>step l</u> , dBm	= 12.6



PERFORMED BY:

Doug Noble, B.A.S. E.E.T.

TRANSIENT FREQUENCY BEHAVIOR

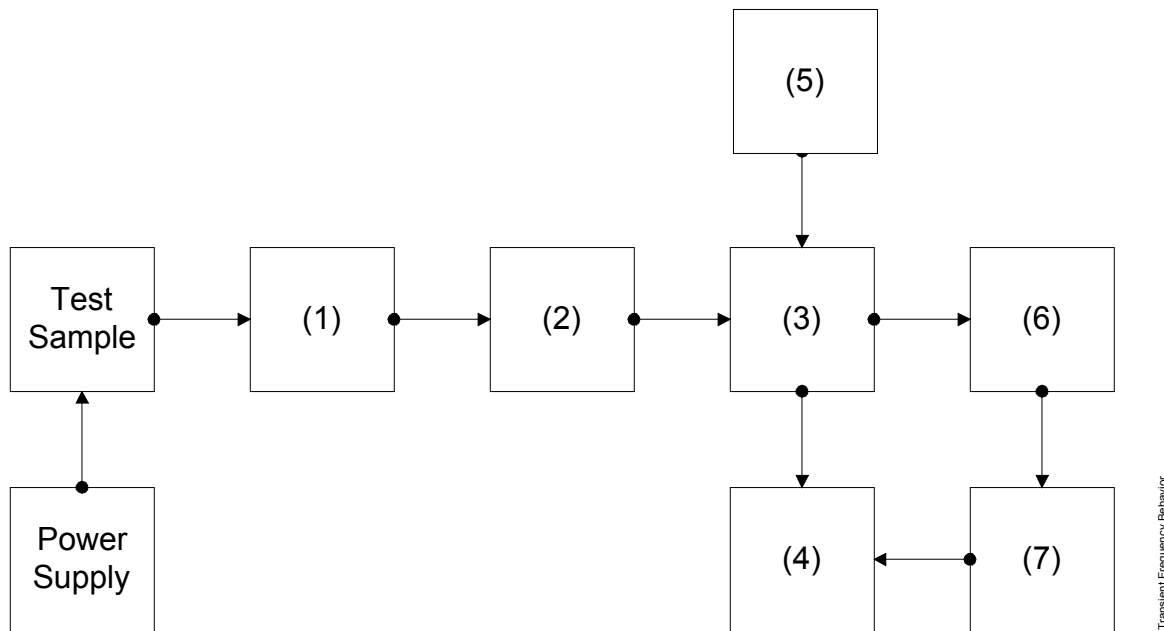

Asset	Description (as applicable)	s/n
(1)	<u>ATTENUATOR</u> (Removed after 1st step) i00112 Philco 30 dB	989
(2)	<u>ATTENUATOR</u> i00112 Philco 30 dB i00172 Bird 30 dB i00122 Narda 10 dB i00123 Narda 10 dB i00110 Kay Variable	989 989 7802 7802A 145-387
(3)	<u>COMBINER</u> i00154 4 x 25 Ω COMBINER	154
(4)	<u>CRYSTAL DETECTOR</u> i00159 HP 8470B	1822A10054
(5)	<u>RF SIGNAL GENERATOR</u> i00018 HP 8656A i00031 HP 8656A i00067 HP 8920A	2228A03472 2402A06180 3345U01242
(6)	<u>MODULATION ANALYZER</u> i00020 HP 8901A	2105A01087
(7)	<u>SCOPE</u> i00030 HP 54502A	2927A00209

PAGE NO.

28 of 44.

NAME OF TEST: Transient Frequency Behavior
g01b0019: 2001-Nov-01 Thu 10:14:00
STATE: 2:High Power

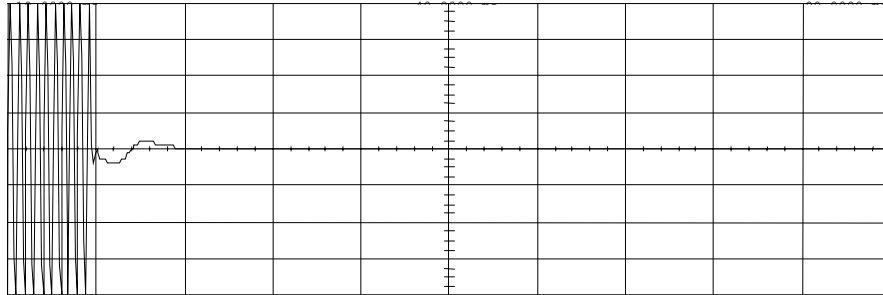

Chan	Min	Max	Ref	Mod
Chan1 1	550	6500	0.0000	dB (1M abn)

Modulation Mode: Freq
 As Modulation Mode: Off
 Resolution: 1.000
 Span: 40.000

POWER:
MODULATION:
DESCRIPTION:

HIGH
Ref Gen=25 kHz Deviation
CARRIER ON TIME

PERFORMED BY:

Doug Noble, B.A.S. E.E.T.

PAGE NO. 29 of 44.

NAME OF TEST: Transient Frequency Behavior
g01b0020: 2001-Nov-01 Thu 10:16:00
STATE: 2:High Power

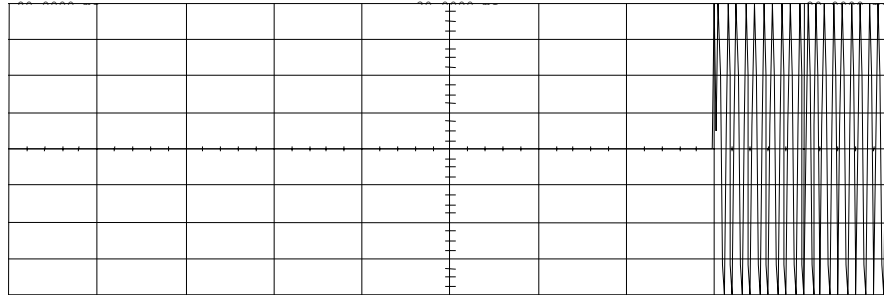

Chan	Min	Max	Ref	Mod
Chan 1	500	100000	0.00000	dB (1M abn)

Modulation: 25 kHz
 Reference: 25 kHz
 Channel 1: 500 kHz to 100 kHz offset ON
 Resolution: 40 kHz

POWER:
MODULATION:
DESCRIPTION:

HIGH
Ref Gen=25 kHz Deviation
CARRIER OFF TIME

PERFORMED BY:

Doug Noble, B.A.S. E.E.T.

PAGE NO.

30 of 44.

NAME OF TEST: Transient Frequency Behavior
g01b0021: 2001-Nov-01 Thu 10:44:00
STATE: 2:High Power

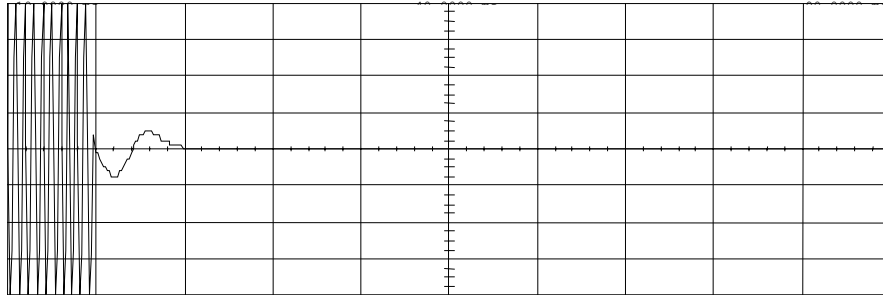

```

MHz         Min/Max     Rate/Dev   Reference  Mode
-----
Channel 1   975 MHz/div  0.00000  1.000 11  dB (1M abn)

Resolution: 975 MHz/div
Offset: 0.00000
Scale: 1.000 11
dB (1M abn)

```

POWER:
MODULATION:
DESCRIPTION:

HIGH
Ref Gen=12.5 kHz Deviation
CARRIER ON TIME

PERFORMED BY:

Doug Noble, B.A.S. E.E.T.

PAGE NO. 31 of 44.

NAME OF TEST: Transient Frequency Behavior
g01b0022: 2001-Nov-01 Thu 10:45:00
STATE: 2:High Power

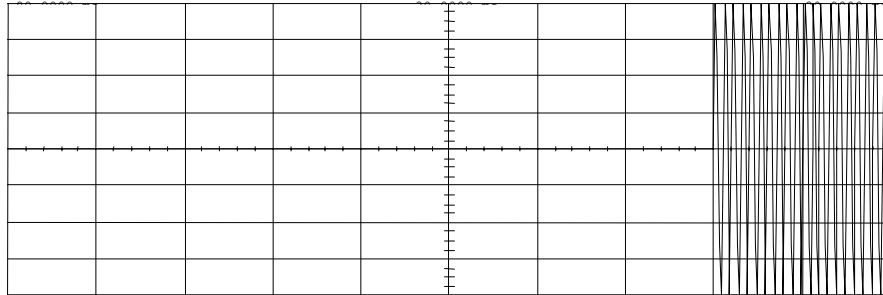

Mode	Modulation	Rate/Dev	Reference	Mod	Resolution
Channel 1	FSK	120000	1.000	12.5	1000

Reference Mode: FSK
 Reference Rate: 120000
 Reference Dev: 12.5
 Reference Mod: 12.5
 Reference Resolution: 1000

POWER:
MODULATION:
DESCRIPTION:

HIGH
Ref Gen=12.5 kHz Deviation
CARRIER OFF TIME

PERFORMED BY:

Doug Noble, B.A.S. E.E.T.

PAGE NO. 32 of 44.
NAME OF TEST: Audio Low Pass Filter (Voice Input)
SPECIFICATION: 47 CFR 2.1047(a)
GUIDE: ANSI/TIA/EIA-603-1992, Paragraph 2.2.15
TEST EQUIPMENT: As per attached page

MEASUREMENT PROCEDURE

1. The EUT and test equipment were set up such that the audio input was connected at the input to the modulation limiter, and the modulated stage.
2. The audio output was connected at the output to the modulated stage.
3. MEASUREMENT RESULTS: ATTACHED

TRANSMITTER TEST SET-UP

- TEST A. MODULATION CAPABILITY/DISTORTION
- TEST B. AUDIO FREQUENCY RESPONSE
- TEST C. HUM AND NOISE LEVEL
- TEST D. RESPONSE OF LOW PASS FILTER
- TEST E. MODULATION LIMITING

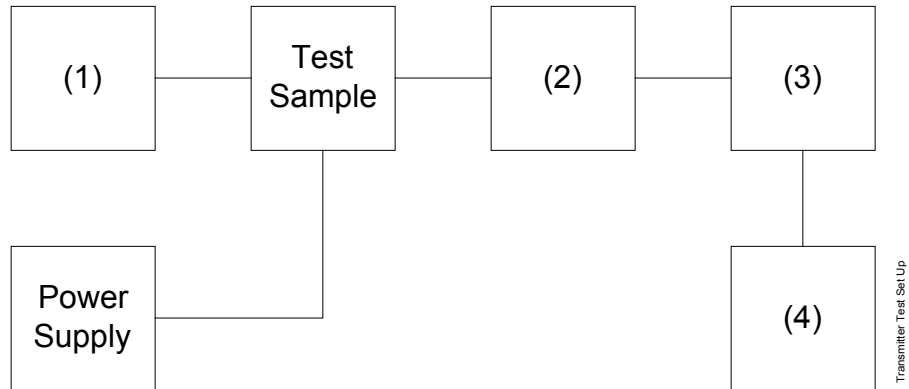

Asset Description (as applicable)	s/n
(1) <u>Audio Oscillator</u>	
i00010 HP 204D	1105A04683
i00017 HP 8903A	2216A01753
i00118 HP 33120A	US36002064
(2) <u>COAXIAL ATTENUATOR</u>	
i00122 NARDA 766-10	7802
i00123 NARDA 766-10	7802A
i00113 SIERRA 661A-3D	1059
i00069 BIRD 8329 (30 dB)	10066
(3) <u>MODULATION ANALYZER</u>	
i00020 HP 8901A	2105A01087
(4) <u>AUDIO ANALYZER</u>	
i00017 HP 8903A	2216A01753

PAGE NO.

34 of 44.

NAME OF TEST: Audio Low Pass Filter (Voice Input)
g01a0107: 2001-Oct-31 Wed 15:46:00
STATE: 0:General

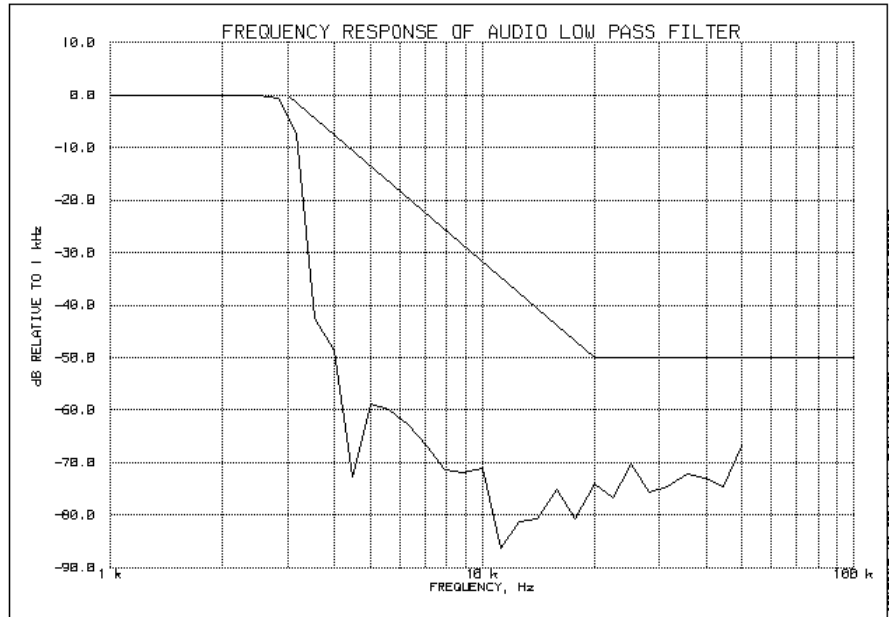

PERFORMED BY:

Doug Noble, B.A.S. E.E.T.

PAGE NO. 35 of 44.
NAME OF TEST: Audio Frequency Response
SPECIFICATION: 47 CFR 2.1047(a)
GUIDE: ANSI/TIA/EIA-603-1992, Paragraph 2.2.6
TEST EQUIPMENT: As per previous page

MEASUREMENT PROCEDURE

1. The EUT and test equipment were set up as shown on the following page.
2. The audio signal generator was connected to the audio input circuit/microphone of the EUT.
3. The audio signal input was adjusted to obtain 20% modulation at 1 kHz, and this point was taken as the 0 dB reference level.
4. With input levels held constant and below limiting at all frequencies, the audio signal generator was varied from 100 Hz to 50 kHz.
5. The response in dB relative to 1 kHz was then measured, using the HP 8901A Modulation Analyzer.
6. MEASUREMENT RESULTS: ATTACHED

PAGE NO. 36 of 44.

NAME OF TEST: Audio Frequency Response
 g01a0104: 2001-Oct-31 Wed 15:24:00
 STATE: 0:General

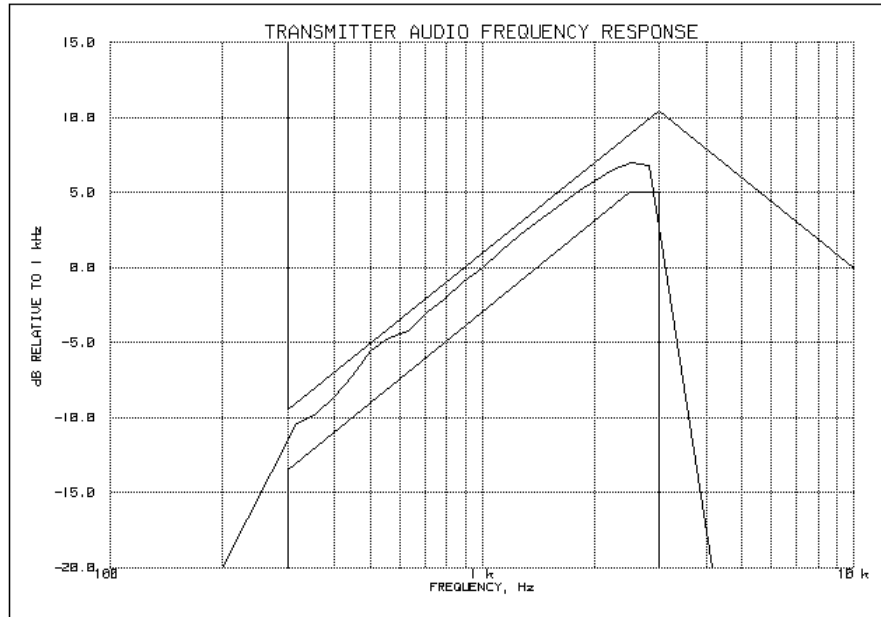

Frequency of Maximum Audio Response, Hz = 2510

Additional points:

FREQUENCY, Hz	LEVEL, dB
300	-12.43
20000	-22.14
30000	-22.12
50000	-22.21

PERFORMED BY:

Doug Noble, B.A.S. E.E.T.

PAGE NO. 37 of 44.
NAME OF TEST: Modulation Limiting
SPECIFICATION: 47 CFR 2.1047(b)
GUIDE: ANSI/TIA/EIA-603-1992, Paragraph 2.2.3
TEST EQUIPMENT: As per previous page

MEASUREMENT PROCEDURE

1. The signal generator was connected to the input of the EUT as for "Frequency Response of the Modulating Circuit."
2. The modulation response was measured for each of three frequencies (one of which was the frequency of maximum response), and the input voltage was varied and was observed on an HP 8901A Modulation Analyzer.
3. The input level was varied from 30% modulation (± 1.5 kHz deviation) to at least 20 dB higher than the saturation point.
4. Measurements were performed for both negative and positive modulation and the respective results were recorded.
5. MEASUREMENT RESULTS: ATTACHED

PAGE NO.

38 of 44.

NAME OF TEST: Modulation Limiting
g01a0108: 2001-Oct-31 Wed 15:49:00
STATE: 0:General

Positive
Peaks:

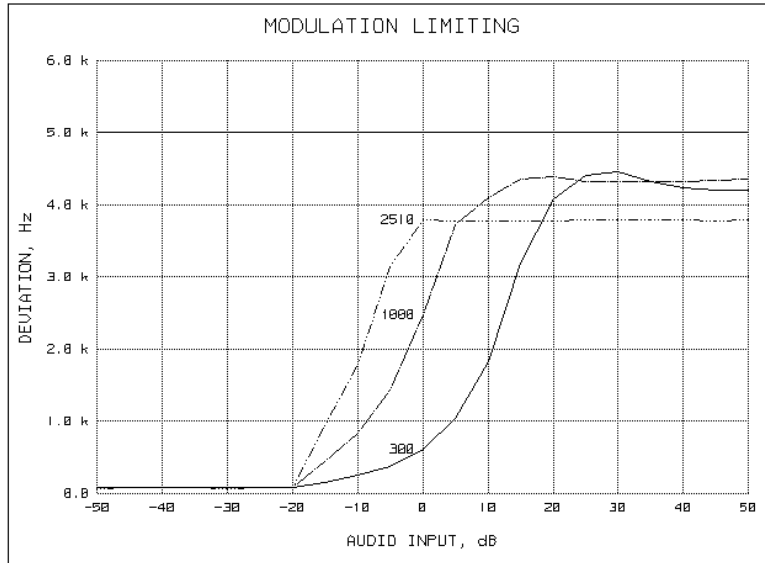

Negative
Peaks:

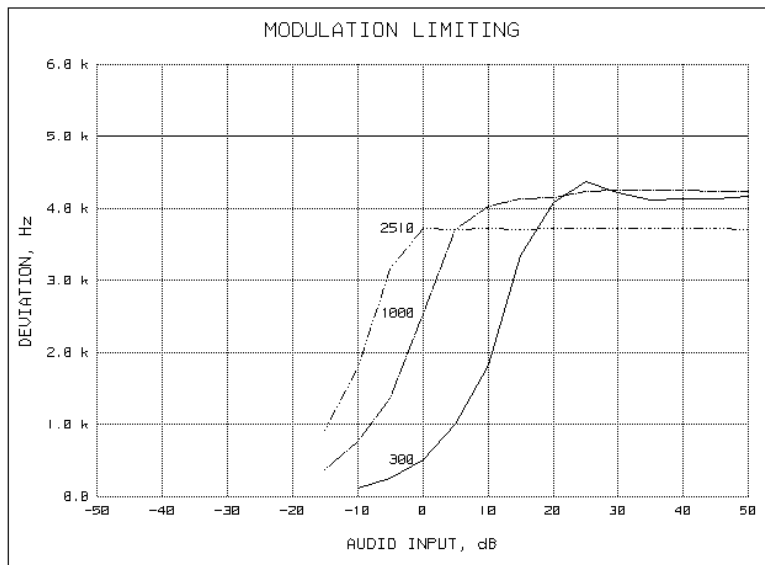

PERFORMED BY:

Doug Noble, B.A.S. E.E.T.

PAGE NO.

39 of 44.

NAME OF TEST: Modulation Limiting
g01a0109: 2001-Oct-31 Wed 15:55:00
STATE: 0:General

Positive
Peaks:

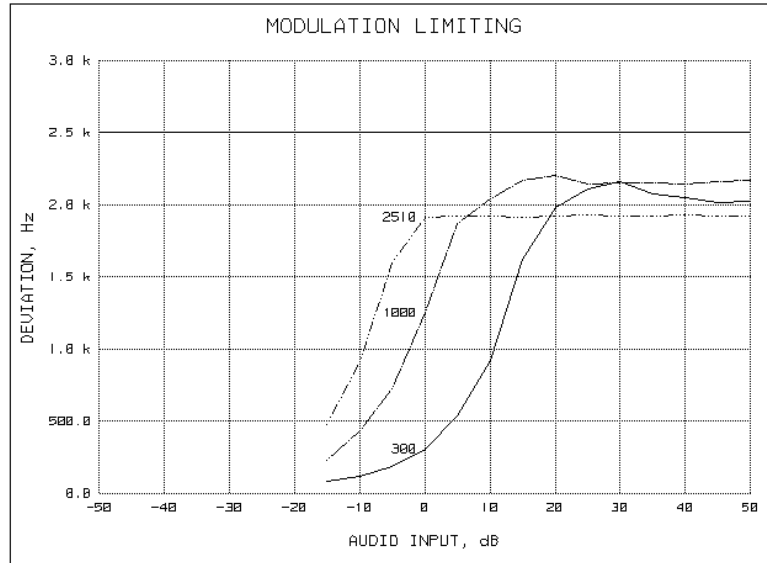

Negative
Peaks:

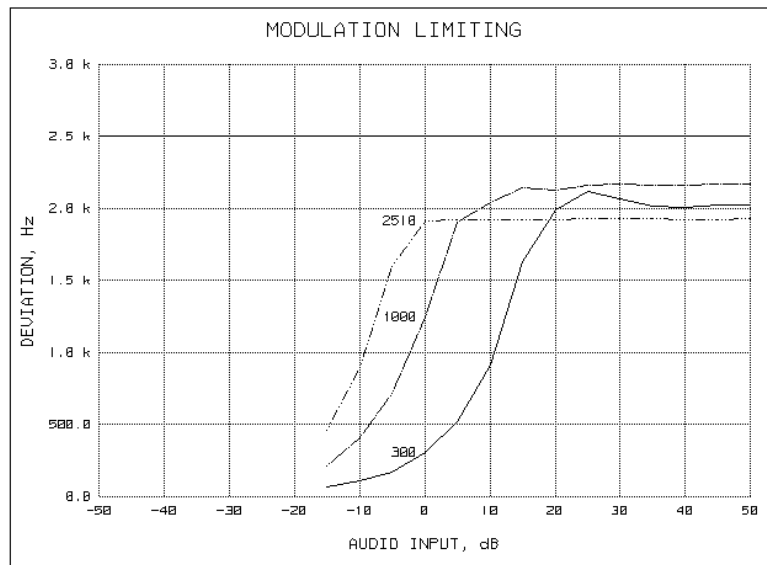

PERFORMED BY:

Doug Noble, B.A.S. E.E.T.

PAGE NO. 40 of 44.
NAME OF TEST: Frequency Stability (Temperature Variation)
SPECIFICATION: 47 CFR 2.1055(a) (1)
GUIDE: ANSI/TIA/EIA-603-1992, Paragraph 2.2.2
TEST CONDITIONS: As Indicated
TEST EQUIPMENT: As per previous page

MEASUREMENT PROCEDURE

1. The EUT and test equipment were set up as shown on the following page.
2. With all power removed, the temperature was decreased to -30°C and permitted to stabilize for three hours. Power was applied and the maximum change in frequency was noted within one minute.
3. With power OFF, the temperature was raised in 10°C steps. The sample was permitted to stabilize at each step for at least one-half hour. Power was applied and the maximum frequency change was noted within one minute.
4. The temperature tests were performed for the worst case.
5. MEASUREMENT RESULTS: ATTACHED

TRANSMITTER TEST SET-UP

- TEST A. OPERATIONAL STABILITY
- TEST B. CARRIER FREQUENCY STABILITY
- TEST C. OPERATIONAL PERFORMANCE STABILITY
- TEST D. HUMIDITY
- TEST E. VIBRATION
- TEST F. ENVIRONMENTAL TEMPERATURE
- TEST G. FREQUENCY STABILITY: TEMPERATURE VARIATION
- TEST H. FREQUENCY STABILITY: VOLTAGE VARIATION

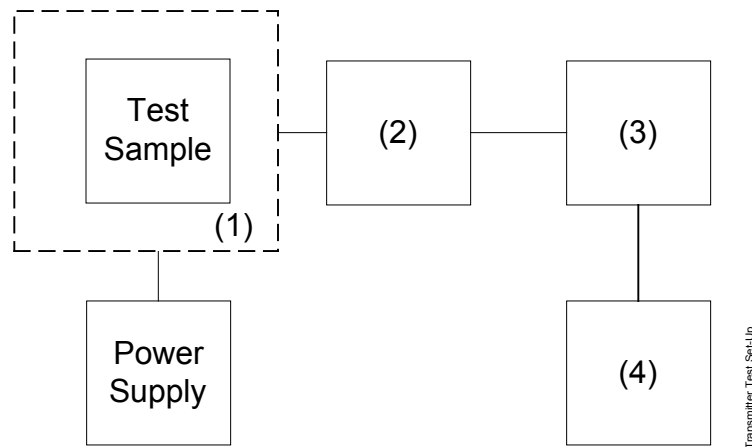

Asset Description (as applicable)	s/n
<u>(1) TEMPERATURE, HUMIDITY, VIBRATION</u>	
i00027 Tenney Temp. Chamber	9083-765-234
i00 Weber Humidity Chamber	
i00 L.A.B. RVH 18-100	
<u>(2) COAXIAL ATTENUATOR</u>	
i00122 NARDA 766-10	7802
i00123 NARDA 766-10	7802A
i00113 SIERRA 661A-3D	1059
i00069 BIRD 8329 (30 dB)	10066
<u>(3) R.F. POWER</u>	
i00014 HP 435A POWER METER	1733A05839
i00039 HP 436A POWER METER	2709A26776
i00020 HP 8901A POWER MODE	2105A01087
<u>(4) FREQUENCY COUNTER</u>	
i00042 HP 5383A	1628A00959
i00019 HP 5334B	2704A00347
i00020 HP 8901A	2105A01087

PAGE NO.

42 of 44.

NAME OF TEST: Frequency Stability (Temperature Variation)
g01b0002: 2001-Nov-02 Fri 08:32:37
STATE: 0:General

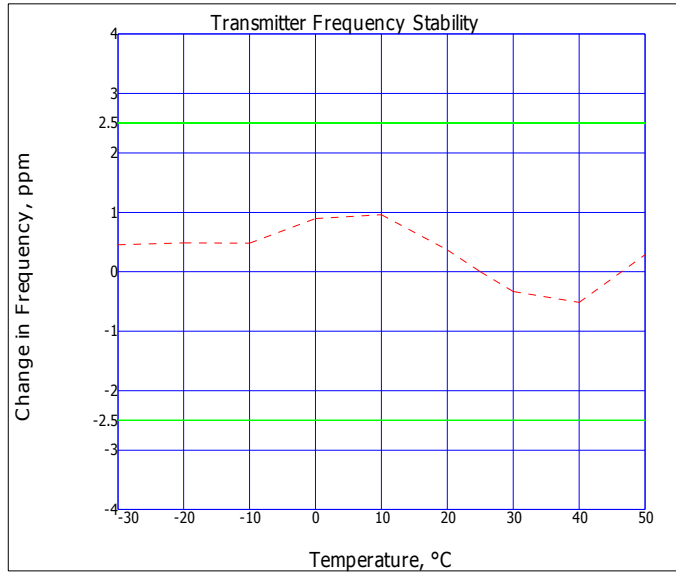

PERFORMED BY:

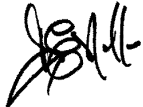
Doug Noble, B.A.S. E.E.T.

PAGE NO. 43 of 44.
NAME OF TEST: Frequency Stability (Voltage Variation)
SPECIFICATION: 47 CFR 2.1055(d) (1)
GUIDE: ANSI/TIA/EIA-603-1992, Paragraph 2.2.2
TEST EQUIPMENT: As per previous page

MEASUREMENT PROCEDURE

1. The EUT was placed in a temperature chamber at 25±5°C and connected as for "Frequency Stability - Temperature Variation" test.
2. The power supply voltage to the EUT was varied from 85% to 115% of the nominal value measured at the input to the EUT.
3. The variation in frequency was measured for the worst case.

RESULTS: Frequency Stability (Voltage Variation)
g01a0111: 2001-Oct-31 Wed 16:05:17
STATE: 0:General

LIMIT, ppm = 2.5
LIMIT, Hz = 1175
BATTERY END POINT (Voltage) = 11.3

% of STV	Voltage	Frequency, MHz	Change, Hz	Change, ppm
85	11.73	470.099940	-60	-0.13
100	13.8	470.100000	0	0.00
115	15.87	470.100070	70	0.15
82	11.3	470.100200	200	0.43

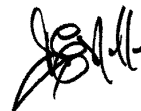

PERFORMED BY: Doug Noble, B.A.S. E.E.T.

PAGE NO. 44 of 44.
NAME OF TEST: Necessary Bandwidth and Emission Bandwidth
SPECIFICATION: 47 CFR 2.202 (g)

MODULATION = 16K0F3E

NECESSARY BANDWIDTH CALCULATION:
 MAXIMUM MODULATION (M), kHz = 3
 MAXIMUM DEVIATION (D), kHz = 5
 CONSTANT FACTOR (K) = 1
 NECESSARY BANDWIDTH (B_N), kHz = (2xM) + (2xDxK)
 = 16.0

MODULATION = 11K0F3E

NECESSARY BANDWIDTH CALCULATION:
 MAXIMUM MODULATION (M), kHz = 3
 MAXIMUM DEVIATION (D), kHz = 2.5
 CONSTANT FACTOR (K) = 1
 NECESSARY BANDWIDTH (B_N), kHz = (2xM) + (2xDxK)
 = 11.0

PERFORMED BY:

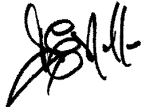
 Doug Noble, B.A.S. E.E.T.

END OF TEST REPORT

TESTIMONIAL
AND
STATEMENT OF CERTIFICATION

THIS IS TO CERTIFY THAT:

1. THAT the application was prepared either by, or under the direct supervision of, the undersigned.
2. THAT the technical data supplied with the application was taken under my direction and supervision.
3. THAT the data was obtained on representative units, randomly selected.
4. THAT, to the best of my knowledge and belief, the facts set forth in the application and accompanying technical data are true and correct.

CERTIFYING ENGINEER:



Morton Flom, P. Eng.