

YAESU MUSEN CO., LTD.
FCC ID: K66GX2350S
EXHIBIT #: 7-3

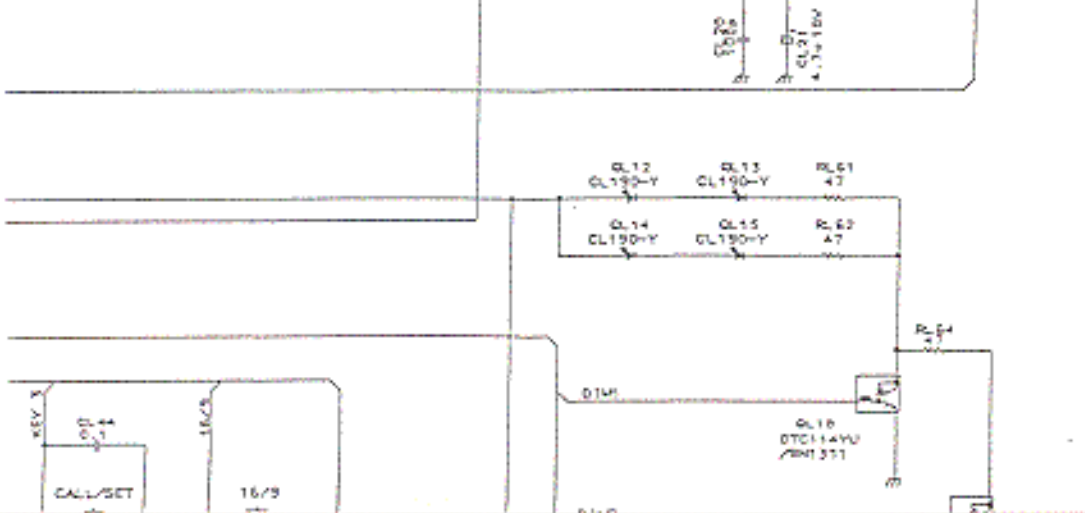

MAIN PCB
P001

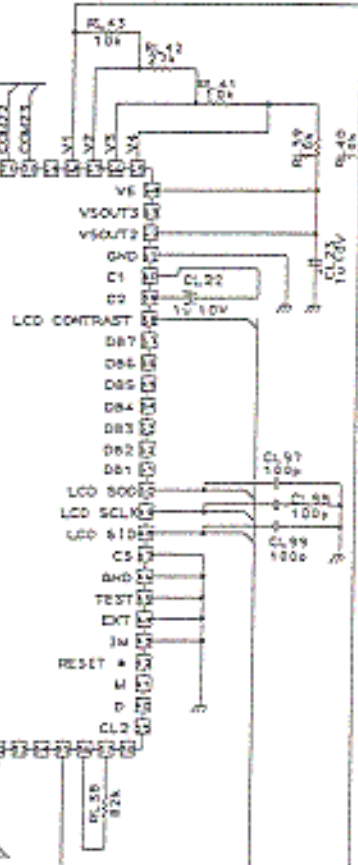
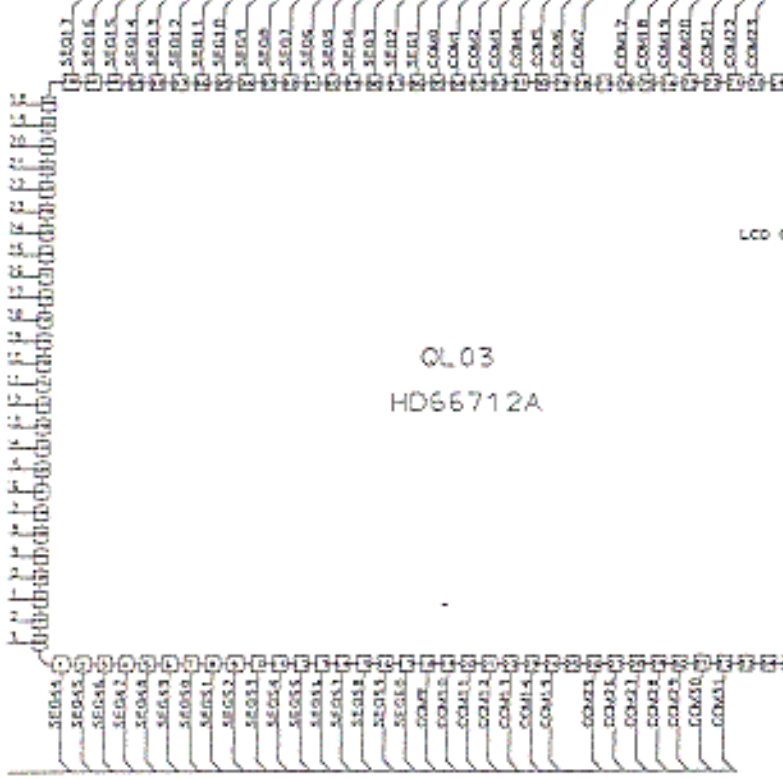
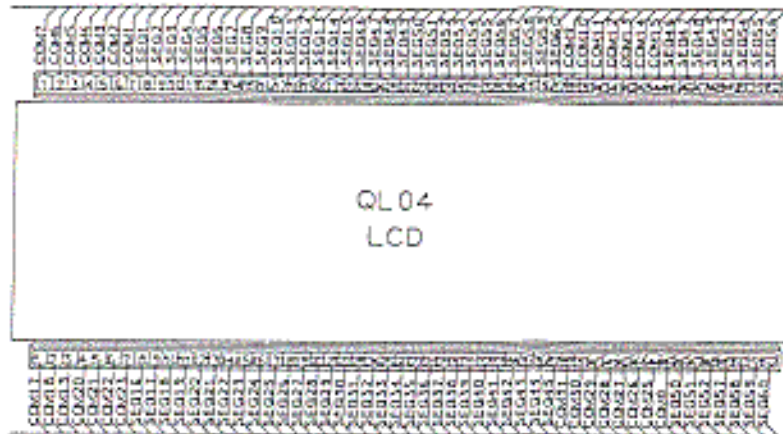
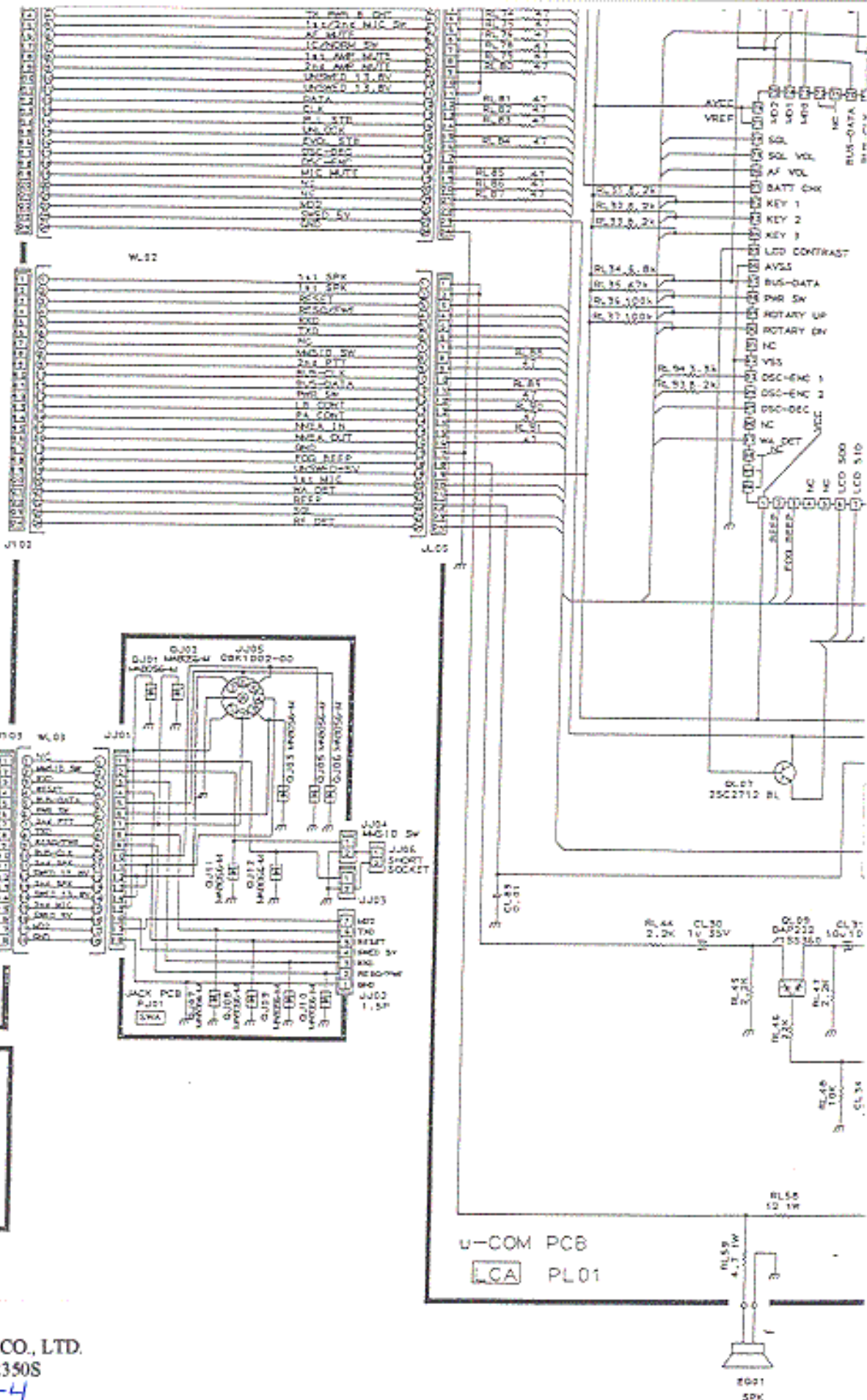

YAESU MUSEN CO., LTD.
FCC ID: K66GX2350S
EXHIBIT #: 7-4

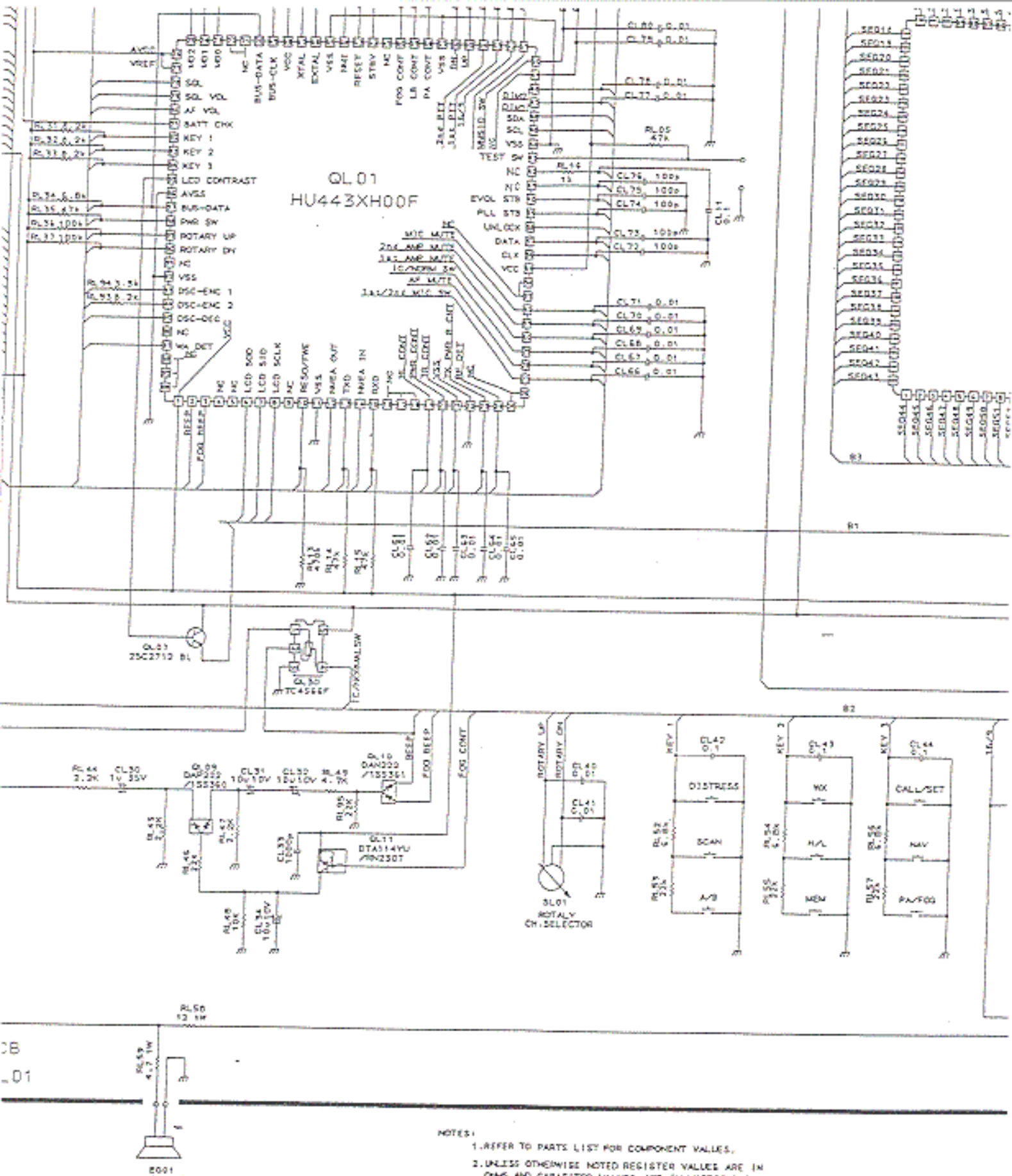

- NOTES:
1. REFER TO PARTS LIST FOR COMPONENT VALUES.
 2. UNLESS OTHERWISE NOTED REGISTER VALUES ARE IN OHMS AND CAPACITOR VALUES ARE IN MICROFARADS
 3. VOLTAGE NOTATIONS ARE AS FOLLOWS. (UNIT: V)
- NO MARKING - BK << >> - UNLOCK
 1 1 - TX (()) - SOL ON
 () - LAMP ON

YAESU MUSEN CO., LTD.
 FCC ID: K66GX2350S
 EXHIBIT #: 7-5

QL03
HD66712A

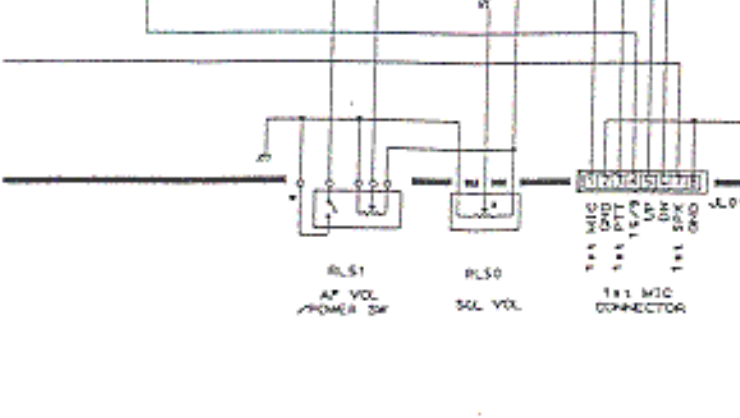
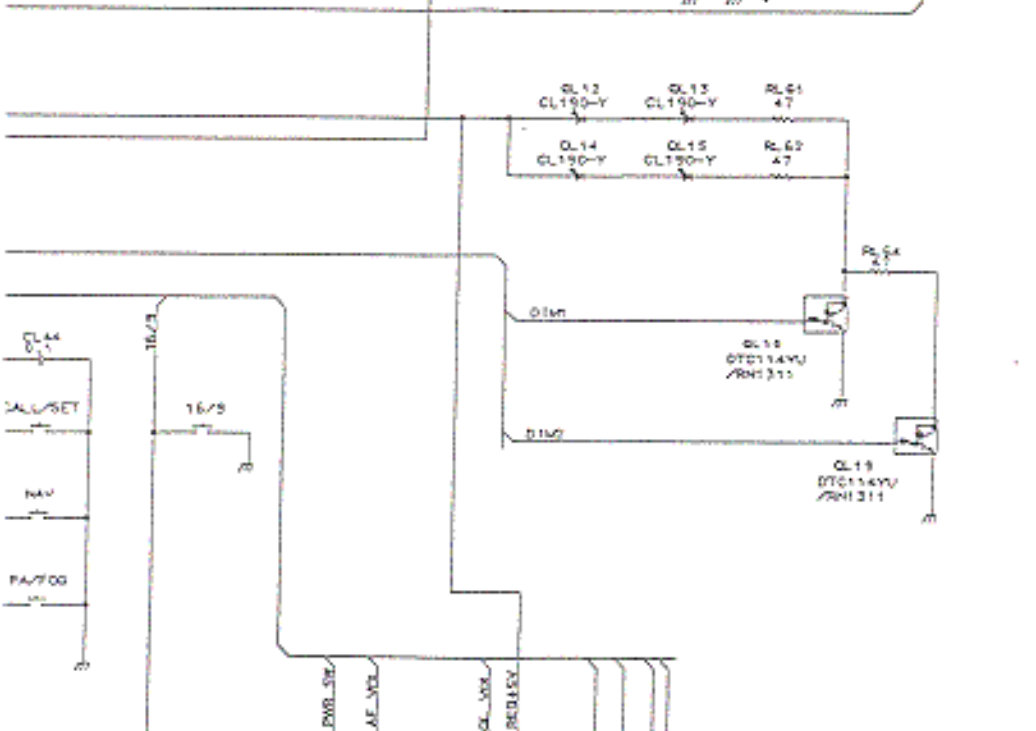
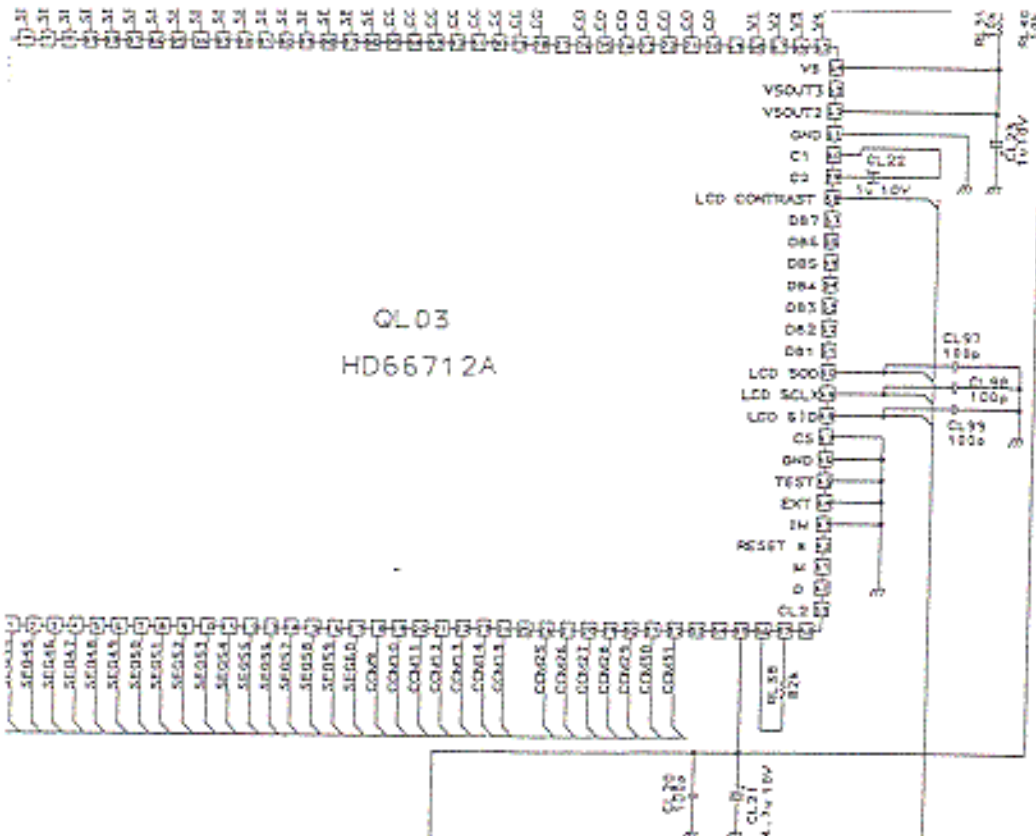

YAESU MUSEN CO., LTD.
FCC ID: K66GX2350S
EXHIBIT #: 7-6

ORDER: 438B	DRAWN BY: K.ATSUTA		
	BLOCK DIAGRAM OF GX2350S FRONT		
	DESIGNED BY: S.KARAKURO	DATE: '95-5-14	438B493B0 0 2/3
	APPROVED BY: <i>[Signature]</i>	MARANTZ JAPAN INC	