

MFA **M. Flom Associates, Inc. - Global Compliance Center**
3356 North San Marcos Place, Suite 107, Chandler, Arizona 85225-7176
www.mflom.com general@mflom.com (480) 926-3100, FAX: 926-3598

T R A N S M I T T E R C E R T I F I C A T I O N

of

FCC ID: K66GX1280S
MODEL: GX1280S

to

FEDERAL COMMUNICATIONS COMMISSION

Rule Part(s) 2.901, 80, Confidentiality

DATE OF REPORT: April 16, 2003

ON THE BEHALF OF THE APPLICANT:

Vertex Standard Co., Ltd.

AT THE REQUEST OF:

P.O. Received UPS 03/31/2003

Vertex Standard USA Inc.
10900 Walker Street
Cypress, CA 90630

Attention of:

Mikio Maruya, Executive Vice President
(800) 255-9237; FAX: (800) 477-9237
(714) 827-7600; FAX: -8100
m.maruya@vxstdusa.com

SUPERVISED BY:



Morton Flom, P. Eng.

LIST OF EXHIBITS
(FCC **CERTIFICATION** (TRANSMITTERS) - REVISED 9/28/98)

APPLICANT: Vertex Standard Co., Ltd.

FCC ID: K66GX1280S

BY APPLICANT:

- | | |
|--|---|
| 1. LETTER OF AUTHORIZATION | x |
| 2. IDENTIFICATION DRAWINGS, 2.1033(c)(11) | |
| <input checked="" type="checkbox"/> LABEL | |
| <input checked="" type="checkbox"/> LOCATION OF LABEL | |
| <input checked="" type="checkbox"/> COMPLIANCE STATEMENT | |
| <input checked="" type="checkbox"/> LOCATION OF COMPLIANCE STATEMENT | |
| 3. PHOTOGRAPHS, 2.1033(c)(12) | x |
| 4. DOCUMENTATION: 2.1033(c) | |
| (3) USER MANUAL | x |
| (9) TUNE-UP/ALIGNMENT PROCEDURE | x |
| (10) SCHEMATIC DIAGRAM | x |
| (10) OPERATIONAL DESCRIPTION | x |
| BLOCK DIAGRAM | x |
| PARTS LIST | x |
| ACTIVE DEVICES | x |
| 5. PART 80 ATTESTATION | x |
| 6. REQUEST FOR CONFIDENTIALITY | x |
| 7. MPE REPORT | x |

BY M.F.A. INC.

- A. TESTIMONIAL & STATEMENT OF CERTIFICATION
- B. STATEMENT OF QUALIFICATIONS

THE APPLICANT HAS BEEN CAUTIONED AS TO THE FOLLOWING:

15.21 INFORMATION TO USER.

The users manual or instruction manual for an intentional radiator shall caution the user that changes or modifications not expressly approved by the party responsible for compliance could void the user's authority to operate the equipment.

15.27(a) SPECIAL ACCESSORIES.

Equipment marketed to a consumer must be capable of complying with the necessary regulations in the configuration in which the equipment is marketed. Where special accessories, such as shielded cables and/or special connectors are required to enable an unintentional or intentional radiator to comply with the emission limits in this part, the equipment must be marketed with, i.e. shipped and sold with, those special accessories. However, in lieu of shipping or packaging the special accessories with the unintentional or intentional radiator, the responsible party may employ other methods of ensuring that the special accessories are provided to the consumer, without additional charge.

Information detailing any alternative method used to supply the special accessories for a grant of equipment authorization or retained in the verification records, as appropriate. The party responsible for the equipment, as detailed in § 2.909 of this chapter, shall ensure that these special accessories are provided with the equipment. The instruction manual for such devices shall include appropriate instructions on the first page of text concerned with the installation of the device that these special accessories must be used with the device. It is the responsibility of the user to use the needed special accessories supplied with the equipment.

TABLE OF CONTENTS

RULE	DESCRIPTION	PAGE
	Test Report	1
2.1033(c)	General Information Required	2
2.1033(c)(14)	Rule Summary	5
	Standard Test Conditions and Engineering Practices	6
2.1046(a)	Carrier Output Power (Conducted)	7
2.1046(a)	ERP Carrier Power (Radiated)	9
2.1047(a)	Audio Frequency Response	10
2.1047(a)	Audio Low Pass Filter (Voice Input)	13
2.1047(b)	Modulation Limiting	15
2.1049(c)(1)	Emission Masks (Occupied Bandwidth)	17
2.1051	Spurious Emissions at Antenna Terminals)	22
2.1053(a)	Field Strength of Spurious Radiation	27
2.1055(a)(1)	Frequency Stability (Temperature Variation)	31
2.1055(b)(1)	Frequency Stability (Voltage Variation)	34
2.202(g)	Necessary Bandwidth and Emission Bandwidth	35

PAGE NO. 1 of 35.

Required information per ISO/IEC Guide 25-1990, paragraph 13.2:

a) TEST REPORT

- b) Laboratory: M. Flom Associates, Inc.
(FCC: 31040/SIT) 3356 N. San Marcos Place, Suite 107
(Canada: IC 2044) Chandler, AZ 85225
- c) Report Number: d0340019
- d) Client: Vertex Standard USA Inc.
10900 Walker Street
Cypress, CA 90630
- e) Identification: GX1280S
FCC ID: K66GX1280S
Description: VHF / FM Marine Transceiver
- f) EUT Condition: Not required unless specified in individual tests.
- g) Report Date: April 16, 2003
EUT Received: April 1, 2003
- h, j, k): As indicated in individual tests.
- i) Sampling method: No sampling procedure used.
- l) Uncertainty: In accordance with MFA internal quality manual.
- m) Supervised by:
- 
- Morton Flom, P. Eng.
- n) Results: The results presented in this report relate only to the item tested.
- o) Reproduction: This report must not be reproduced, except in full, without written permission from this laboratory.

PAGE NO. 2 of 35.

LIST OF GENERAL INFORMATION REQUIRED FOR CERTIFICATION

IN ACCORDANCE WITH FCC RULES AND REGULATIONS,
VOLUME II, PART 2 AND TO

2.901, 80, Confidentiality

Sub-part 2.1033

(c)(1): NAME AND ADDRESS OF APPLICANT:

Vertex Standard Co., Ltd.
4-8-8 Nakameguro, Meguro-Ku
Tokyo 153-8644 Japan

MANUFACTURER:

Applicant

(c)(2): FCC ID: K66GX1280S

MODEL NO: GX1280S

(c)(3): INSTRUCTION MANUAL(S):

PLEASE SEE ATTACHED EXHIBITS

(c)(4): TYPE OF EMISSION: 16K0G3E, 16K0G2B

(c)(5): FREQUENCY RANGE, MHz: 156.025 to 157.425

(c)(6): POWER RATING, Watts: 1 to 25
x Switchable Variable N/A

FCC GRANT NOTE: BB - Power output continuously variable from value listed to less than 0.5 watts.

(c)(7): MAXIMUM POWER RATING, Watts: 25

PAGE NO. 3 of 35.

Subpart 2.1033 (continued)

(c)(8): VOLTAGES & CURRENTS IN ALL ELEMENTS IN FINAL R. F. STAGE, INCLUDING FINAL TRANSISTOR OR SOLID STATE DEVICE:

COLLECTOR CURRENT, A	= 4.7
COLLECTOR VOLTAGE, Vdc	= 13.8
SUPPLY VOLTAGE, Vdc	= 13.8

(c)(9): TUNE-UP PROCEDURE:

PLEASE SEE ATTACHED EXHIBITS

(c)(10): CIRCUIT DIAGRAM/CIRCUIT DESCRIPTION:

Including description of circuitry & devices provided for determining and stabilizing frequency, for suppression of spurious radiation, for limiting modulation and limiting power.

PLEASE SEE ATTACHED EXHIBITS

(c)(11): LABEL INFORMATION:

PLEASE SEE ATTACHED EXHIBITS

(c)(12): PHOTOGRAPHS:

PLEASE SEE ATTACHED EXHIBITS

(c)(13): DIGITAL MODULATION DESCRIPTION:

 ATTACHED EXHIBITS
 x N/A

(c)(14): TEST AND MEASUREMENT DATA:

FOLLOWS

PAGE NO.

5 of 35.

Sub-part

2.1033(c)(14): TEST AND MEASUREMENT DATA

All tests and measurement data shown were performed in accordance with FCC Rules and Regulations, Volume II; Part 2, Sub-part J, Sections 2.947, 2.1033(c), 2.1041, 2.1046, 2.1047, 2.1079, 2.1051, 2.1053, 2.1055, 2.1057 and the following individual Parts:

- ___ 21 - Domestic Public Fixed Radio Services
- ___ 22 - Public Mobile Services
- ___ 22 Subpart H - Cellular Radiotelephone Service
- ___ 22.901(d) - Alternative technologies and auxiliary services
- ___ 23 - International Fixed Public Radiocommunication services
- ___ 24 - Personal Communications Services
- ___ 74 Subpart H - Low Power Auxiliary Stations
- x 80 - Stations in the Maritime Services
- ___ 80 Subpart E - General Technical Standards
- ___ 80 Subpart F - Equipment Authorization for Compulsory Ships
- ___ 80 Subpart K - Private Coast Stations and Marine Utility Stations
- ___ 80 Subpart S - Compulsory Radiotelephone Installations for Small Passenger Boats
- ___ 80 Subpart T - Radiotelephone Installation Required for Vessels on the Great Lakes
- ___ 80 Subpart U - Radiotelephone Installations Required by the Bridge-to-Bridge Act
- ___ 80 Subpart V - Emergency Position Indicating Radiobeacons (EPIRB'S)
- ___ 80 Subpart W - Global Maritime Distress and Safety System (GMDSS)
- ___ 80 Subpart X - Voluntary Radio Installations
- ___ 87 - Aviation Services
- ___ 90 - Private Land Mobile Radio Services
- ___ 94 - Private Operational-Fixed Microwave Service
- ___ 95 Subpart A - General Mobile Radio Service (GMRS)
- ___ 95 Subpart C - Radio Control (R/C) Radio Service
- ___ 95 Subpart D - Citizens Band (CB) Radio Service
- ___ 95 Subpart E - Family Radio Service
- ___ 95 Subpart F - Interactive Video and Data Service (IVDS)
- ___ 97 - Amateur Radio Service
- ___ 101 - Fixed Microwave Services

PAGE NO.

6 of 35.

STANDARD TEST CONDITIONS and ENGINEERING PRACTICES

Except as noted herein, the following conditions and procedures were observed during the testing:

In accordance with ANSIC63.4-1992/2000 Draft, section 6.1.9, and unless otherwise indicated in the specific measurement results, the ambient temperature of the actual EUT was maintained within the range of 10° to 40°C (50° to 104 °F) unless the particular equipment requirements specify testing over a different temperature range. Also, unless otherwise indicated, the humidity levels were in the range of 10% to 90% relative humidity.

Prior to testing, the EUT was tuned up in accordance with the manufacturer's alignment procedures. All external gain controls were maintained at the position of maximum and/or optimum gain throughout the testing.

Measurement results, unless otherwise noted, are worst case measurements.

PAGE NO. 7 of 35.
NAME OF TEST: Carrier Output Power (Conducted)
SPECIFICATION: 47 CFR 2.1046(a)
GUIDE: ANSI/TIA/EIA-603-1992, Paragraph 2.2.1
TEST EQUIPMENT: As per attached page

MEASUREMENT PROCEDURE

1. The EUT was connected to a resistive coaxial attenuator of normal load impedance, and the unmodulated output power was measured by means of an R. F. Power Meter.
2. Measurement accuracy is $\pm 3\%$.

MEASUREMENT RESULTS
(Worst case)

FREQUENCY OF CARRIER, MHz = 156.800

<u>POWER SETTING</u>	<u>R. F. POWER, WATTS</u>
Low	1
High	25



PERFORMED BY:

David Lee

TRANSMITTER POWER CONDUCTED MEASUREMENTS

TEST 1: R. F. POWER OUTPUT
 TEST 2: FREQUENCY STABILITY

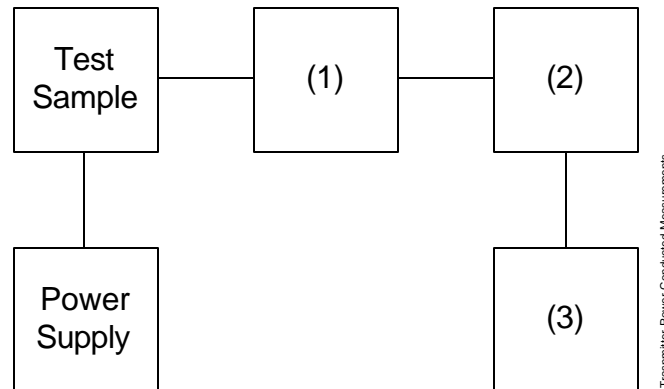

Asset	Description (as applicable)	s/n
(1)	<u>COAXIAL ATTENUATOR</u>	
	i00122 Narda 766-10	7802
	i00123 Narda 766-10	7802A
	i00069 Bird 8329 (30 dB)	1006
	i00113 Sierra 661A-3D	1059
(2)	<u>POWER METERS</u>	
	i00014 HP 435A	1733A05836
	i00039 HP 436A	2709A26776
	i00020 HP 8901A POWER MODE	2105A01087
(3)	<u>FREQUENCY COUNTER</u>	
	i00042 HP 5383A	1628A00959
	i00019 HP 5334B	2704A00347
	i00020 HP 8901A FREQUENCY MODE	2105A01087

PAGE NO. 9 of 35.

NAME OF TEST: ERP Carrier Power (Radiated)

SPECIFICATION: TIA/EIA 603A (Substitution Method)

2.2.17.1 Definition: The average radiated power of a licensed device is the equivalent power required, when delivered to a half-wave dipole or horn antenna, to produce at a distant point the same average received power as produced by the licensed device.

2.2.17.2 Method of Measurement:

a) Connect the equipment as illustrated. Place the transmitter to be tested on the turntable in the standard test site.

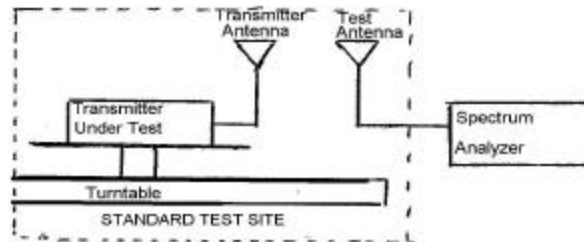

b) Raise and lower the test antenna from 1m to 6 m with the transmitter facing the antenna and record the highest received signal in dB as LVL.

c) Repeat step b) for seven additional readings at 45° interval positions of the turntable.

d) Replace the transmitter under test with a half-wave or horn vertically polarized antenna. The center of the antenna should be at the same location as the transmitter under test. Connect the antenna to a signal generator with a known output power and record the path loss in dB or LOSS.

e) Calculate the average radiated output power from the readings in step c) and d) by the following:

$$\text{average radiated power} = 10 \log_{10} S 10(LVL - LOSS)/10 \text{ (dBm)}$$

	<u>156.045 MHz</u>		<u>156.800 MHz</u>		<u>157.425 MHz</u>	
	LVL, dbm	Path Loss, db	LVL, dbm	Path Loss, db	LVL, dbm	Path Loss, db
0°	38.6	1.7	38.0	1.7	37.9	1.7
45°	40.4	1.7	40.3	1.7	39.4	1.7
90°	36.1	1.7	38.9	1.7	37.0	1.7
135°	37.9	1.7	36.6	1.7	35.7	1.7
180°	37.8	1.7	36.8	1.7	39.0	1.7
225°	36.9	1.7	37.7	1.7	37.3	1.7
270°	39.9	1.7	37.3	1.7	38.0	1.7
315°	39.1	1.7	38.2	1.7	39.8	1.7

	<u>156.045 MHz</u>	<u>156.800 MHz</u>	<u>157.425 MHz</u>
Av. Radiated Power:	39.675 dbm	39.7 dbm	40.04 dbm

PAGE NO. 10 of 35.
NAME OF TEST: Audio Frequency Response
SPECIFICATION: 47 CFR 2.1047(a)
GUIDE: ANSI/TIA/EIA-603-1992, Paragraph 2.2.6
TEST EQUIPMENT: As per attached page

MEASUREMENT PROCEDURE

1. The EUT and test equipment were set up as shown on the following page.
2. The audio signal generator was connected to the audio input circuit/microphone of the EUT.
3. The audio signal input was adjusted to obtain 50% modulation at 1 kHz, and this point was taken as the 0 dB reference level.
4. With input levels held constant and below limiting at all frequencies, the audio signal generator was varied from 100 Hz to 50 kHz.
5. The response in dB relative to 1 kHz was then measured, using the HP 8901A Modulation Analyzer.
6. MEASUREMENT RESULTS: ATTACHED

TRANSMITTER TEST SET-UP

- TEST A. MODULATION CAPABILITY/DISTORTION
- TEST B. AUDIO FREQUENCY RESPONSE
- TEST C. HUM AND NOISE LEVEL
- TEST D. RESPONSE OF LOW PASS FILTER
- TEST E. MODULATION LIMITING

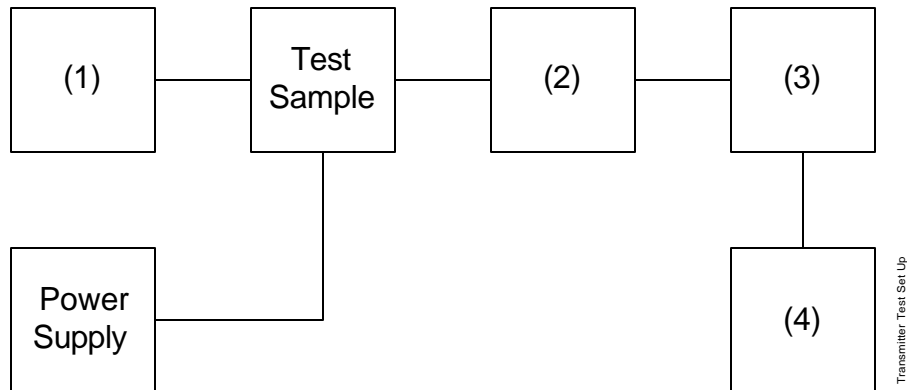

Asset Description
(as applicable)

s/n

(1) AUDIO OSCILLATOR

i00010	HP 204D	1105A04683
i00017	HP 8903A	2216A01753
i00118	HP 33120A	US36002064

(2) COAXIAL ATTENUATOR

i00122	NARDA 766-10	7802
i00123	NARDA 766-10	7802A
i00113	SIERRA 661A-3D	1059
i00069	BIRD 8329 (30 dB)	10066

(3) MODULATION ANALYZER

i00020	HP 8901A	2105A01087
--------	----------	------------

(4) AUDIO ANALYZER

i00017	HP 8903A	2216A01753
--------	----------	------------

PAGE NO. 12 of 35.

NAME OF TEST: Audio Frequency Response
 g0340009: 2003-Apr-10 Thu 09:18:00
 STATE: 0:General

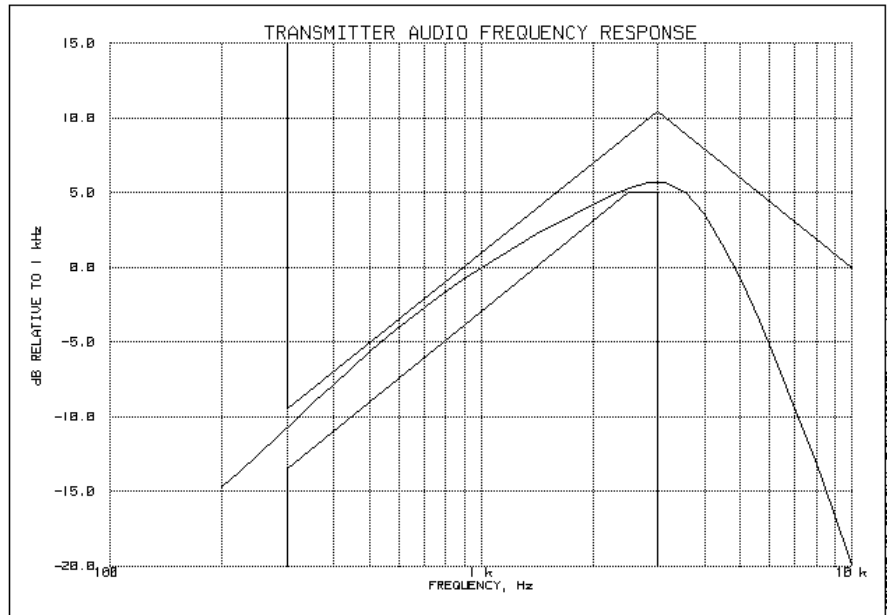

Frequency of Maximum Audio Response, Hz = 2820

Additional points:

FREQUENCY, Hz	LEVEL, dB
300	-10.75
20000	-33.73
30000	-34.08
50000	-34.07

PERFORMED BY:

David Lee

PAGE NO. 13 of 35.
NAME OF TEST: Audio Low Pass Filter (Voice Input)
SPECIFICATION: 47 CFR 2.1047(a)
GUIDE: ANSI/TIA/EIA-603-1992, Paragraph 2.2.15
TEST EQUIPMENT: As per previous page

MEASUREMENT PROCEDURE

1. The EUT and test equipment were set up such that the audio input was connected at the input to the modulation limiter, and the modulated stage.
2. The audio output was connected at the output to the modulated stage.
3. MEASUREMENT RESULTS: ATTACHED

PAGE NO.

14 of 35.

NAME OF TEST: Audio Low Pass Filter (Voice Input)
g0340011: 2003-Apr-10 Thu 09:54:00
STATE: 0:General

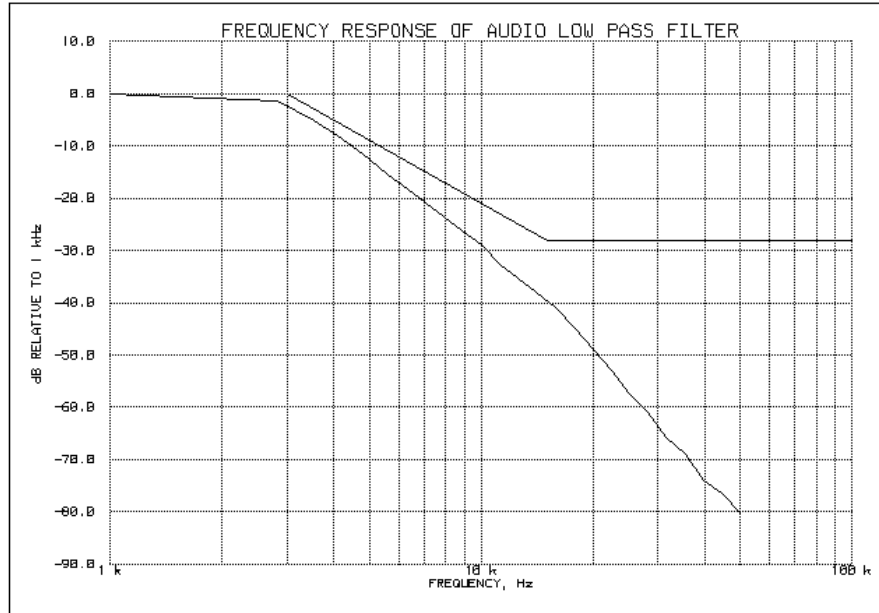

PERFORMED BY:

David Lee

PAGE NO. 15 of 35.
NAME OF TEST: Modulation Limiting
SPECIFICATION: 47 CFR 2.1047(b), 80.211, 80.213
GUIDE: ANSI/TIA/EIA-603-1992, Paragraph 2.2.3
TEST EQUIPMENT: As per previous page

MEASUREMENT PROCEDURE

1. The signal generator was connected to the input of the EUT as for "Frequency Response of the Modulating Circuit."
2. The modulation response was measured for each of three frequencies (one of which was the frequency of maximum response), and the input voltage was varied and was observed on an HP 8901A Modulation Analyzer.
3. The input level was varied from 30% modulation (± 1.5 kHz deviation) to at least 20 dB higher than the saturation point.
4. Measurements were performed for both negative and positive modulation and the respective results were recorded.
5. MEASUREMENT RESULTS: ATTACHED

PAGE NO.

16 of 35.

NAME OF TEST: Modulation Limiting
g0340017: 2003-Apr-10 Thu 10:44:00
STATE: 0:General

Positive
Peaks:

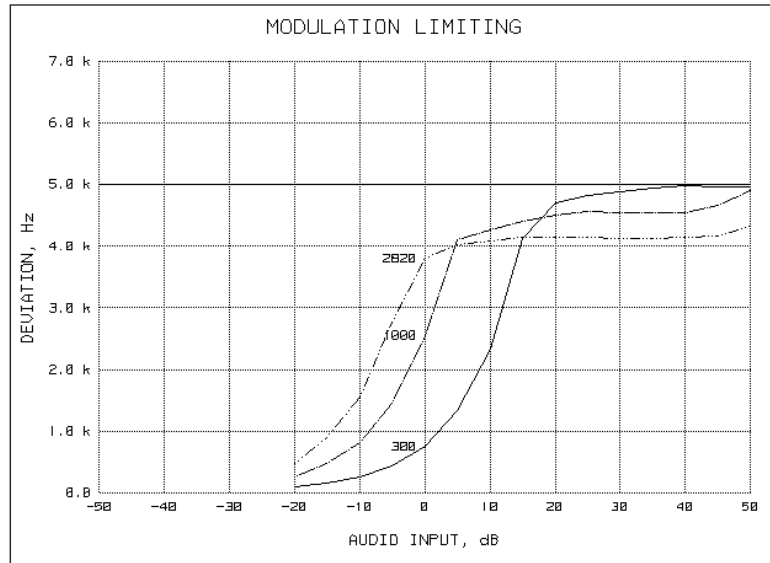

Negative
Peaks:

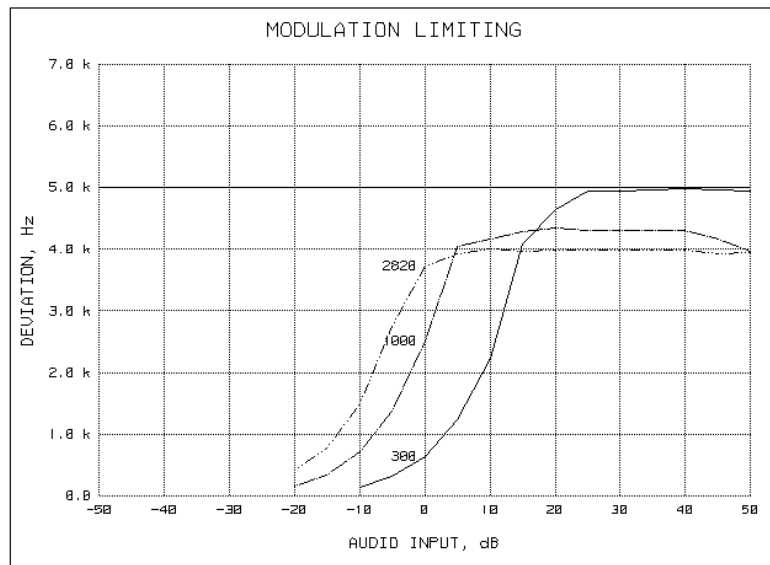

PERFORMED BY:

David Lee

PAGE NO. 17 of 35.
NAME OF TEST: Emission Masks (Occupied Bandwidth)
SPECIFICATION: 47 CFR 2.1049(c)(1)
GUIDE: ANSI/TIA/EIA-603-1992, Paragraph 2.2.11
TEST EQUIPMENT: As per previous page

MEASUREMENT PROCEDURE

1. The EUT and test equipment were set up as shown on the following page, with the Spectrum Analyzer connected.
2. For EUTs supporting audio modulation, the audio signal generator was adjusted to the frequency of maximum response and with output level set for ± 2.5 kHz deviation (or 50% modulation). With level constant, the signal level was increased 16 dB.
3. For EUTs supporting digital modulation, the digital modulation mode was operated to its maximum extent.
4. The Occupied Bandwidth was measured with the Spectrum Analyzer controls set as shown on the test results.
5. MEASUREMENT RESULTS: ATTACHED

PAGE NO.

20 of 35.

NAME OF TEST: Emission Masks (Occupied Bandwidth)
g0340091: 2003-Apr-10 Thu 15:56:00
STATE: 2:High Power

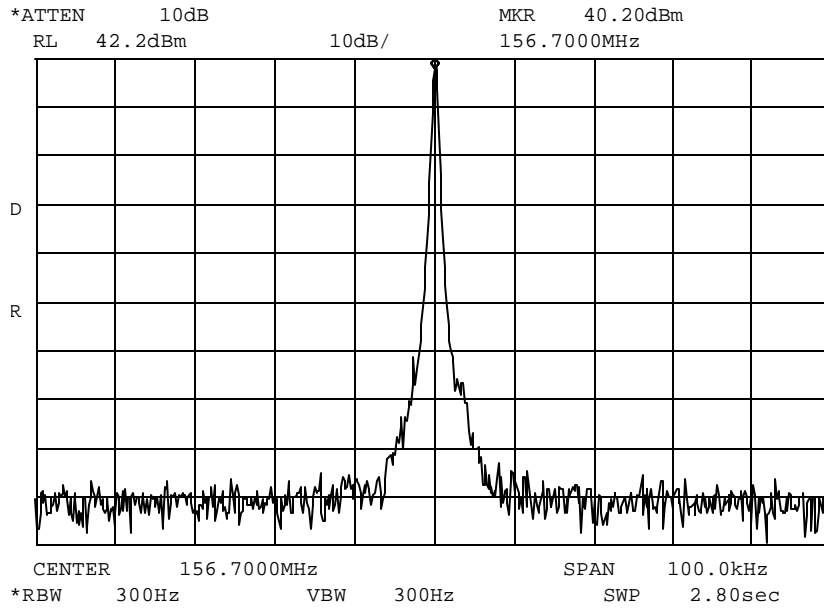

POWER: HIGH
MODULATION: NONE
REFERENCE

PERFORMED BY:

David Lee

PAGE NO.

21 of 35.

NAME OF TEST: Emission Masks (Occupied Bandwidth)
 g0340092: 2003-Apr-10 Thu 16:05:00
 STATE: 2:High Power

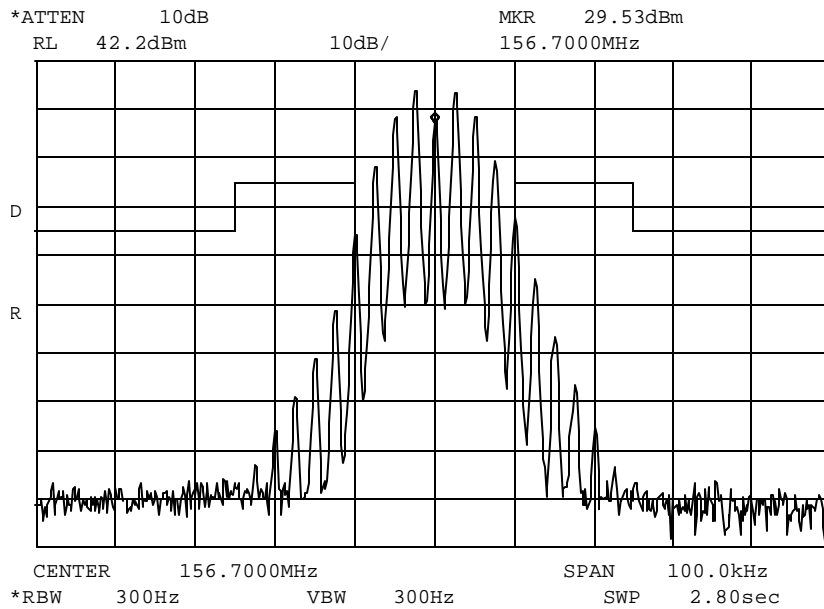

POWER:
 MODULATION:

HIGH
 VOICE: 2500 Hz SINE WAVE
 MASK: B, VHF/UHF 25kHz,
 w/LPF

PERFORMED BY:

David Lee

PAGE NO. 22 of 35.
NAME OF TEST: Spurious Emissions at Antenna Terminals
SPECIFICATION: 47 CFR 2.1051
GUIDE: ANSI/TIA/EIA-603-1992, Paragraph 2.2.13
TEST EQUIPMENT: As per attached page

MEASUREMENT PROCEDURE

1. The emissions were measured for the worst case as follows:
 - (a): within a band of frequencies defined by the carrier frequency plus and minus one channel.
 - (b): from the lowest frequency generated in the EUT and to at least the 10th harmonic of the carrier frequency, or 40 GHz, whichever is lower.
2. The magnitude of spurious emissions that are attenuated more than 20 dB below the permissible value need not be specified.
3. MEASUREMENT RESULTS: ATTACHED FOR WORST CASE

FREQUENCY OF CARRIER, MHz	=	156.800
SPECTRUM SEARCHED, GHz	=	0 to 10 x F _c
MAXIMUM RESPONSE, Hz	=	2820
ALL OTHER EMISSIONS	=	= 20 dB BELOW LIMIT



PERFORMED BY:

David Lee

PAGE NO. 23 of 35.

NAME OF TEST: Unwanted Emissions (Transmitter Conducted)

LIMIT(S), dBc

-(43+10xLOG P) = -43 (1 Watt)

-(43+10xLOG P) = -57 (25 Watts)

STATE: 1:Low Power g0340070: 2003-Apr-09 Wed 08:46:00

FREQUENCY TUNED, MHz	FREQUENCY EMISSION, MHz	LEVEL, dBm	LEVEL, dBc	MARGIN, dB
156.700000	88.566667	-59.3	-6.2	-39.3
156.700000	96.725000	-58.9	-5.8	-38.9
156.700000	117.391667	-58.1	-5	-38.1
156.700000	132.516667	-57.8	-4.7	-37.8
156.700000	197.591667	-57.3	-4.2	-37.3
156.700000	216.383333	-58.4	-5.3	-38.4
156.700000	242.050000	-59.1	-6	-39.1
156.700000	298.191667	-59.6	-6.5	-39.6
156.700000	313.391667	-57.8	-4.7	-37.8
156.700000	334.900000	-58.1	-5	-38.1
156.700000	391.133333	-57.9	-4.8	-37.9
156.700000	398.600000	-58.6	-5.5	-38.6
156.700000	469.906667	-59.3	-6.2	-39.3
156.700000	499.475000	-58.1	-5	-38.1
156.700000	512.533333	-58.6	-5.5	-38.6
156.700000	594.800000	-58.3	-5.2	-38.3
156.700000	600.066667	-58.4	-5.3	-38.4
156.700000	626.914167	-59.1	-6	-39.1
156.700000	656.116667	-57.9	-4.8	-37.9
156.700000	693.058333	-56.9	-3.8	-36.9
156.700000	735.908333	-58.4	-5.3	-38.4
156.700000	765.833333	-56.9	-3.8	-36.9
156.700000	783.692500	-58.6	-5.5	-38.6
156.700000	848.466667	-57.4	-4.3	-37.4
156.700000	881.416667	-57.6	-4.5	-37.6
156.700000	928.300000	-58.1	-5	-38.1
156.700000	940.270000	-58.3	-5.2	-38.3
156.700000	952.541667	-57.6	-4.5	-37.6
156.700000	1030.500000	-57.6	-4.5	-37.6
156.700000	1054.741667	-58.3	-5.2	-38.3
156.700000	1096.716667	-59.3	-6.2	-39.3
156.700000	1105.016667	-57.1	-4	-37.1
156.700000	1150.483333	-57.4	-4.3	-37.4
156.700000	1186.183333	-56.9	-3.8	-36.9
156.700000	1226.650000	-57.6	-4.5	-37.6
156.700000	1253.594167	-58.4	-5.3	-38.4
156.700000	1266.933333	-58.8	-5.7	-38.8
156.700000	1348.925000	-58.4	-5.3	-38.4
156.700000	1364.183333	-58.4	-5.3	-38.4
156.700000	1406.391667	-58.3	-5.2	-38.3
156.700000	1410.184167	-58.1	-5	-38.1
156.700000	1462.350000	-57.8	-4.7	-37.8
156.700000	1543.150000	-58.4	-5.3	-38.4

PAGE NO. 24 of 35.

NAME OF TEST: Unwanted Emissions (Transmitter Conducted)

STATE: 1:Low Power g0340070: 2003-Apr-09 Wed 08:46:00 (Continued)

FREQUENCY TUNED, MHz	FREQUENCY EMISSION, MHz	LEVEL, dBm	LEVEL, dBc	MARGIN, dB
156.700000	1567.077500	-58.9	-5.8	-38.9
156.700000	1592.508333	-57.8	-4.7	-37.8
156.700000	1603.825000	-58.4	-5.3	-38.4
156.700000	1652.816667	-58.1	-5	-38.1
156.700000	1723.777500	-58.6	-5.5	-38.6
156.700000	1725.825000	-58.1	-5	-38.1
156.700000	1768.125000	-58.3	-5.2	-38.3
156.700000	1784.258333	-58.4	-5.3	-38.4
156.700000	1821.883333	-58.1	-5	-38.1
156.700000	1875.183333	-58.1	-5	-38.1
156.700000	1880.454167	-58.1	-5	-38.1
156.700000	1896.266667	-58.1	-5	-38.1
156.700000	1920.416667	-58.1	-5	-38.1
156.700000	1990.033333	-56.9	-3.8	-36.9
156.700000	2036.969167	-58.1	-5	-38.1
156.700000	2194.044167	-58.4	-5.3	-38.4
156.700000	2350.634167	-58.8	-5.7	-38.8



PERFORMED BY:

David Lee

PAGE NO. 25 of 35.

NAME OF TEST: Unwanted Emissions (Transmitter Conducted)

LIMIT(S), dBc

-(50+10xLOG P) = -50 (1 Watt)

-(50+10xLOG P) = -64 (25 Watts)

STATE: 2:High Power g0340069: 2003-Apr-09 Wed 08:43:00

FREQUENCY TUNED, MHz	FREQUENCY EMISSION, MHz	LEVEL, dBm	LEVEL, dBc	MARGIN, dB
156.700000	95.350000	-58.5	< -100.7	-38.5
156.700000	100.525000	-58.2	< -100.7	-38.2
156.700000	146.541667	-60	< -100.7	-40
156.700000	154.558333	-59.2	< -100.7	-39.2
156.700000	175.366667	-59.2	< -100.7	-39.2
156.700000	197.366667	-57.7	< -100.7	-37.7
156.700000	287.650000	-58.8	< -100.7	-38.8
156.700000	306.300000	-59	< -100.7	-39
156.700000	313.635833	-58.7	< -100.7	-38.7
156.700000	402.266667	-58.2	< -100.7	-38.2
156.700000	418.308333	-57.8	< -100.7	-37.8
156.700000	468.583333	-58.7	< -100.7	-38.7
156.700000	470.278333	-59.3	< -100.7	-39.3
156.700000	522.616667	-58.8	< -100.7	-38.8
156.700000	595.075000	-57.8	< -100.7	-37.8
156.700000	606.483333	-58.3	< -100.7	-38.3
156.700000	626.709167	-57.8	< -100.7	-37.8
156.700000	657.125000	-57.7	< -100.7	-37.7
156.700000	693.058333	-56.7	< -100.7	-36.7
156.700000	708.225000	-58	< -100.7	-38
156.700000	783.445833	-57.3	< -100.7	-37.3
156.700000	798.650000	-58.3	< -100.7	-38.3
156.700000	840.766667	-58.5	< -100.7	-38.5
156.700000	872.708333	-57.8	< -100.7	-37.8
156.700000	877.475000	-57.8	< -100.7	-37.8
156.700000	898.966667	-57.8	< -100.7	-37.8
156.700000	940.445833	-58.8	< -100.7	-38.8
156.700000	956.666667	-57.3	< -100.7	-37.3
156.700000	1049.291667	-57.5	< -100.7	-37.5
156.700000	1096.710000	-58.5	< -100.7	-38.5
156.700000	1100.850000	-57.2	< -100.7	-37.2
156.700000	1143.791667	-58	< -100.7	-38
156.700000	1189.208333	-57.3	< -100.7	-37.3
156.700000	1203.733333	-58	< -100.7	-38
156.700000	1253.782500	-57.7	< -100.7	-37.7
156.700000	1266.383333	-58.5	< -100.7	-38.5
156.700000	1316.933333	-58.7	< -100.7	-38.7
156.700000	1385.450000	-58.2	< -100.7	-38.2
156.700000	1410.081667	-58.7	< -100.7	-38.7
156.700000	1449.658333	-58	< -100.7	-38
156.700000	1498.650000	-58.5	< -100.7	-38.5
156.700000	1523.441667	-58.5	< -100.7	-38.5
156.700000	1567.225000	-59.2	< -100.7	-39.2

PAGE NO. 26 of 35.

NAME OF TEST: Unwanted Emissions (Transmitter Conducted)

STATE: 2:High Power g0340069: 2003-Apr-09 Wed 08:43:00 (Continued)

FREQUENCY TUNED, MHz	FREQUENCY EMISSION, MHz	LEVEL, dBm	LEVEL, dBc	MARGIN, dB
156.700000	1594.433333	-58.3	< -100.7	-38.3
156.700000	1628.116667	-58.3	< -100.7	-38.3
156.700000	1674.725000	-58.8	< -100.7	-38.8
156.700000	1723.580000	-59.2	< -100.7	-39.2
156.700000	1734.533333	-58.7	< -100.7	-38.7
156.700000	1757.216667	-58.2	< -100.7	-38.2
156.700000	1828.300000	-58.3	< -100.7	-38.3
156.700000	1861.891667	-57.3	< -100.7	-37.3
156.700000	1880.326667	-58.7	< -100.7	-38.7
156.700000	1949.658333	-58	< -100.7	-38
156.700000	1997.550000	-58	< -100.7	-38
156.700000	2037.003333	-58	< -100.7	-38
156.700000	2193.640000	-58.7	< -100.7	-38.7
156.700000	2350.431667	-57.7	< -100.7	-37.7



PERFORMED BY:

David Lee

PAGE NO. 27 of 35.

NAME OF TEST: Field Strength of Spurious Radiation

SPECIFICATION: 47 CFR 2.1053(a)

GUIDE: ANSI/TIA/EIA-603-1992/2001, Paragraph 1.2.12 and Table 16, 47 CFR 22.917

MEASUREMENT PROCEDURE

1.2.12.1 Definition: Radiated spurious emissions are emissions from the equipment when transmitting into a non-radiating load on a frequency or frequencies which are outside an occupied band sufficient to ensure transmission of information of required quality for the class of communications desired.

1.2.12.2 Method of Measurement

- A) Connect the equipment as illustrated
- B) Adjust the spectrum analyzer for the following settings:
 1) Resolution Bandwidth 100 kHz (<1 GHz), 1 MHz (> 1GHz).
 2) Video Bandwidth = 3 times Resolution Bandwidth, or 30 kHz (22.917)
 3) Sweep Speed ≤ 2000 Hz/second
 4) Detector Mode = Mean or Average Power
- C) Place the transmitter to be tested on the turntable in the standard test site. The transmitter is transmitting into a non-radiating load which is placed on the turntable. The RF cable to this load should be of minimum length.

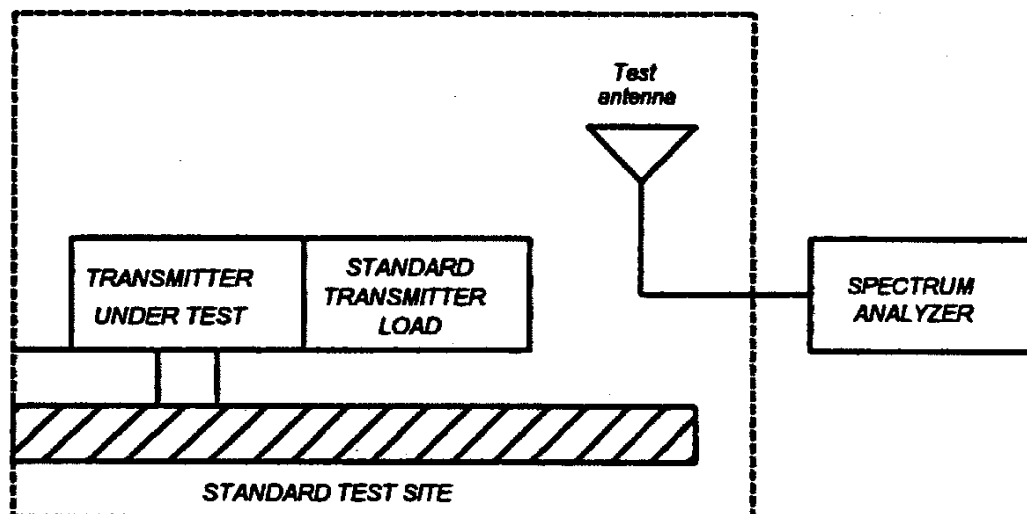

PAGE NO. 28 of 35.

NAME OF TEST: Field Strength of Spurious Radiation (Cont.)

- D) For each spurious measurement the test antenna should be adjusted to the correct length for the frequency involved. This length may be determined from a calibration ruler supplied with the equipment. Measurements shall be made from the lowest radio frequency generated in the equipment to the tenth harmonic of the carrier, except for the region close to the carrier equal to \pm the test bandwidth (see section 1.3.4.4).
- E) For each spurious frequency, raise and lower the test antenna from 1 m to 4 m to obtain a maximum reading on the spectrum analyzer with the test antenna at horizontal polarity. Repeat this procedure to obtain the highest possible reading. Record this maximum reading.
- F) Repeat step E) for each spurious frequency with the test antenna polarized vertically.

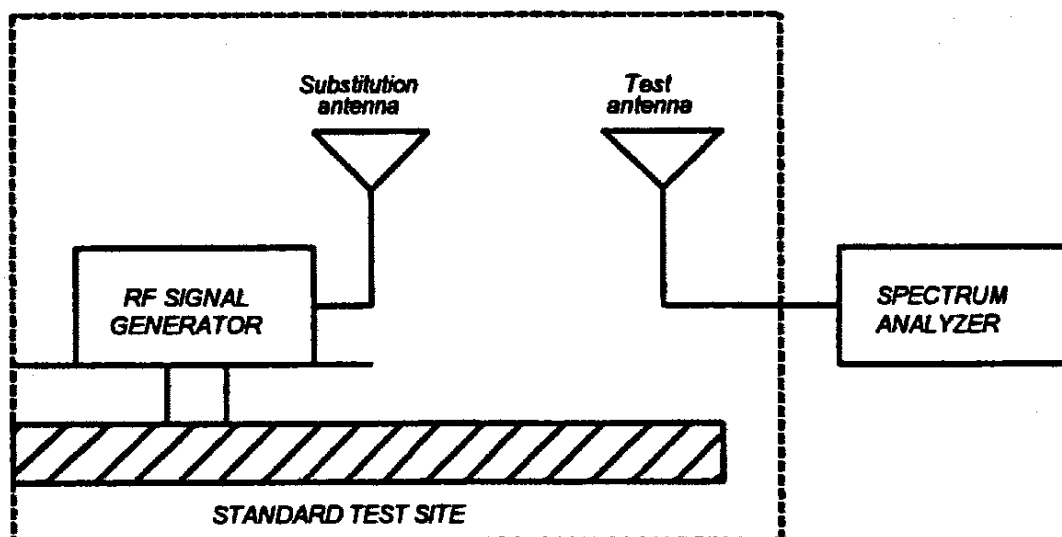

- G) Reconnect the equipment as illustrated.
- H) Keep the spectrum analyzer adjusted as in step B).
- I) Remove the transmitter and replace it with a substitution antenna (the antenna should be half-wavelength for each frequency involved). The center of the substitution antenna should be approximately at the same location as the center of the transmitter. At lower frequencies, where the substitution antenna is very long, this will be impossible to achieve when the antenna is polarized vertically. In such case the lower end of the antenna should be 0.3 m above the ground.

PAGE NO. 29 of 35.

NAME OF TEST: Field Strength of Spurious Radiation (Cont.)

- J) Feed the substitution antenna at the transmitter end with a signal generator connected to the antenna by means of a non-radiating cable. With the antennas at both ends horizontally polarized and with the signal generator tuned to a particular spurious frequency, raise and lower the test antenna to obtain a maximum reading at the spectrum analyzer. Adjust the level of the signal generator output until the previously recorded maximum reading for this set of conditions is obtained. This should be done carefully repeating the adjustment of the test antenna and generator output.
- K) Repeat step J) with both antennas vertically polarized for each spurious frequency.
- L) Calculate power in dBm into a reference ideal half-wave dipole antenna by reducing the readings obtained in steps J) and K) by the power loss in the cable between the generator and the antenna and further corrected for the gain of the substitution antenna used relative to an ideal half-wave dipole antenna.
- M) The levels recorded in step L) are absolute levels of radiated spurious emissions in dBm. The radiated spurious emissions in dB can be calculated by the following:

Radiated spurious emissions dB =
 $10\log_{10}(\text{TX power in watts}/0.001) - \text{the levels in step l)}$

NOTE: It is permissible that other antennas provided can be referenced to a dipole.

Test Equipment:

Asset Description (as applicable)	s/n	Cycle	Last Cal
<u>TRANSDUCER</u>			
i00088 EMCO 3109-B 25MHz-300MHz	2336	12 mo.	Sep-02
i00065 EMCO 3301-B Active Monopole	2635	12 mo.	Sep-02
i00089 Aprel 2001 200MHz-1GHz	001500	12 mo.	Sep-02
i00103 EMCO 3115 1GHz-18GHz	9208-3925	12 mo.	Sep-02
<u>AMPLIFIER</u>			
i00028 HP 8449A	2749A00121	12 mo.	Mar-03
<u>SPECTRUM ANALYZER</u>			
i00029 HP 8563E	3213A00104	12 mo.	Jan-03
i00033 HP 85462A	3625A00357	12 mo.	Jan-03
i00048 HP 8566B	2511AD1467	6 mo.	Jan-03

Per ANSI C63.4-1992/2000 Draft, 10.1.4

PAGE NO. 30 of 35.

NAME OF TEST: Field Strength of Spurious Radiation

STATE: 1:Low Power g0340049: 2003-Apr-03 Thu 13:44:00

FREQUENCY TUNED, MHz	FREQUENCY EMISSION, MHz	METER, dBuV	ERP, dBm	ERP, dbc
156.045	312.090000	45.0	< -62	< -92
156.045	468.135000	22.0	< -62	< -92
156.045	624.180000	23.3	< -62	< -92
156.045	780.225000	12.6	< -62	< -92
156.045	936.270000	14.9	< -62	< -92
156.045	1092.315000	11.3	< -62	< -92
156.045	1248.360000	11.7	< -62	< -92
156.045	1404.405000	9.6	< -62	< -92
156.045	1560.450000	13.3	< -62	< -92

STATE: 1:Mid Power g0340050: 2003-Apr-03 Thu 14:08:00

FREQUENCY TUNED, MHz	FREQUENCY EMISSION, MHz	METER, dBuV	ERP, dBm	ERP, dbc
156.695000	313.390000	44.47	-31.7	< -92
156.695000	470.085000	22.88	-48.1	< -92
156.695000	626.780000	22.4	-44.6	< -92
156.695000	783.475000	13.46	-51.5	< -92
156.695000	940.170000	22.94	-37.8	< -92
156.695000	1096.865000	8.49	-52.1	< -92
156.695000	1253.560000	10.87	-48	< -92
156.695000	1410.255000	10.7	-46.7	< -92
156.695000	1566.950000	12.65	-43.5	< -92

STATE: 1:High Power g0340051: 2003-Apr-03 Thu 14:14:00

FREQUENCY TUNED, MHz	FREQUENCY EMISSION, MHz	METER, dBuV	ERP, dBm	ERP, dbc
157.425	314.850000	44.5	< -62.5	< -106.5
157.425	472.275000	22.8	< -62.5	< -106.5
157.425	629.700000	21.6	< -62.5	< -106.5
157.425	787.125000	12.3	< -62.5	< -106.5
157.425	944.550000	10.9	< -62.5	< -106.5
157.425	1101.975000	16.0	< -62.5	< -106.5
157.425	1259.400000	17.4	< -62.5	< -106.5
157.425	1416.825000	15.4	< -62.5	< -106.5
157.425	1574.250000	16.6	< -62.5	< -106.5



PERFORMED BY:

David Lee

PAGE NO. 31 of 35.
NAME OF TEST: Frequency Stability (Temperature Variation)
SPECIFICATION: 47 CFR 2.1055(a)(1)
GUIDE: ANSI/TIA/EIA-603-1992, Paragraph 2.2.2
TEST CONDITIONS: As Indicated
TEST EQUIPMENT: As per previous page

MEASUREMENT PROCEDURE

1. The EUT and test equipment were set up as shown on the following page.
2. With all power removed, the temperature was decreased to -30°C and permitted to stabilize for three hours. Power was applied and the maximum change in frequency was noted within one minute.
3. With power OFF, the temperature was raised in 10°C steps. The sample was permitted to stabilize at each step for at least one-half hour. Power was applied and the maximum frequency change was noted within one minute.
4. The temperature tests were performed for the worst case.
5. MEASUREMENT RESULTS: ATTACHED

TRANSMITTER TEST SET-UP

- TEST A. OPERATIONAL STABILITY
- TEST B. CARRIER FREQUENCY STABILITY
- TEST C. OPERATIONAL PERFORMANCE STABILITY
- TEST D. HUMIDITY
- TEST E. VIBRATION
- TEST F. ENVIRONMENTAL TEMPERATURE
- TEST G. FREQUENCY STABILITY: TEMPERATURE VARIATION
- TEST H. FREQUENCY STABILITY: VOLTAGE VARIATION

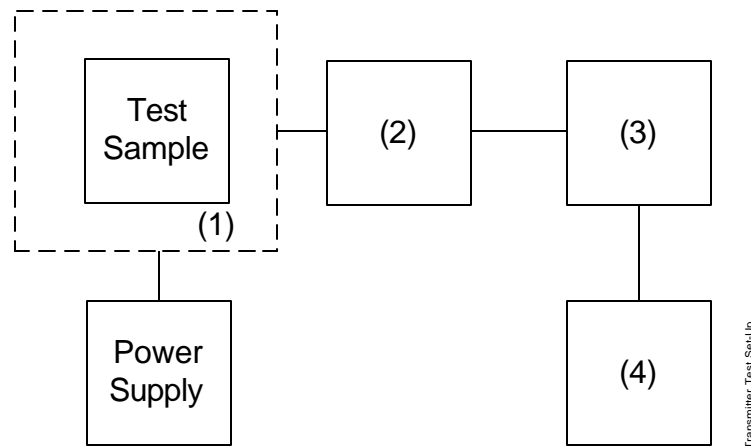

Asset Description (as applicable)	s/n
<u>(1) TEMPERATURE, HUMIDITY, VIBRATION</u>	
i00027 TennEy Temp. Chamber	9083-765-234
i00 Weber Humidity Chamber	
i00 L.A.B. RVH 18-100	
<u>(2) COAXIAL ATTENUATOR</u>	
i00122 NARDA 766-10	7802
i00123 NARDA 766-10	7802A
i00113 SIERRA 661A-3D	1059
i00069 BIRD 8329 (30 dB)	10066
<u>(3) R.F. POWER</u>	
i00014 HP 435A POWER METER	1733A05839
i00039 HP 436A POWER METER	2709A26776
i00020 HP 8901A POWER MODE	2105A01087
<u>(4) FREQUENCY COUNTER</u>	
i00042 HP 5383A	1628A00959
i00019 HP 5334B	2704A00347
i00020 HP 8901A	2105A01087

PAGE NO.

33 of 35.

NAME OF TEST: Frequency Stability (Temperature Variation)
g0340046: 2003-Apr-14 Mon 08:31:36
STATE: 0:General

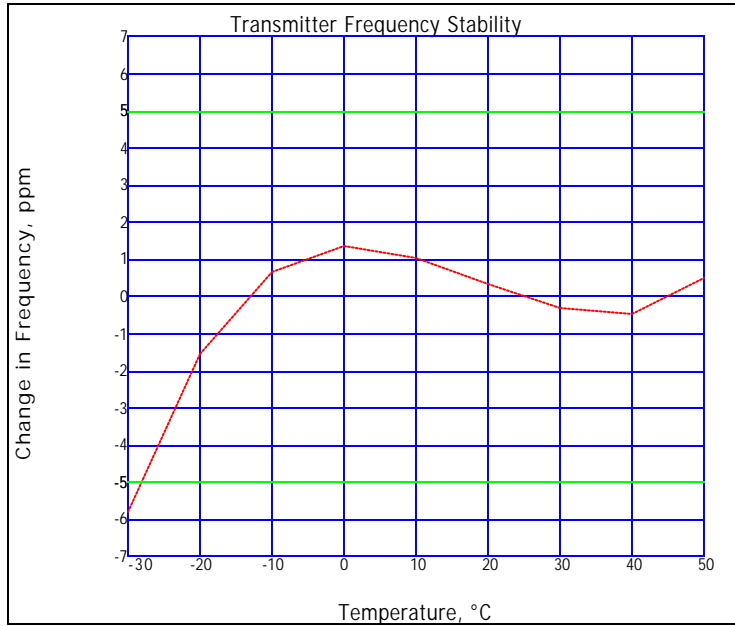

PERFORMED BY:

David Lee

PAGE NO. 34 of 35.
NAME OF TEST: Frequency Stability (Voltage Variation)
SPECIFICATION: 47 CFR 2.1055(d)(1)
GUIDE: ANSI/TIA/EIA-603-1992, Paragraph 2.2.2
TEST EQUIPMENT: As per previous page

MEASUREMENT PROCEDURE

1. The EUT was placed in a temperature chamber at 25±5°C and connected as for "Frequency Stability - Temperature Variation" test.
2. The power supply voltage to the EUT was varied from 85% to 115% of the nominal value measured at the input to the EUT.
3. The variation in frequency was measured for the worst case.

RESULTS: Frequency Stability (Voltage Variation)
g0340089: 2003-Apr-10 Thu 15:31:49
STATE: 0:General

LIMIT, ppm = 5
LIMIT, Hz = 784
BATTERY END POINT (Voltage) = 8.8

% of STV	Voltage	Frequency, MHz	Change, Hz	Change, ppm
85	11.7	156.69992	-80	-0.5
100	13.8	156.69992	-80	-0.5
115	15.9	156.69993	-70	-0.5



PERFORMED BY: David Lee

PAGE NO. 35 of 35.

NAME OF TEST: Necessary Bandwidth and Emission Bandwidth

SPECIFICATION: 47 CFR 2.202(g)

MODULATION = 16K0G3E

NECESSARY BANDWIDTH CALCULATION:

MAXIMUM MODULATION (M), kHz	= 3
MAXIMUM DEVIATION (D), kHz	= 5
CONSTANT FACTOR (K)	= 1
NECESSARY BANDWIDTH (B_N), kHz	= $(2 \times M) + (2 \times D \times K)$
	= 16

MODULATION = 16K0G2B

NECESSARY BANDWIDTH CALCULATION:

MAXIMUM MODULATION (M), kHz	= 3
MAXIMUM DEVIATION (D), kHz	= 5
CONSTANT FACTOR (K)	= 1
NECESSARY BANDWIDTH (B_N), kHz	= $(2 \times M) + (2 \times D \times K)$
	= 16



PERFORMED BY:
END OF TEST REPORT

David Lee

TESTIMONIAL AND STATEMENT OF CERTIFICATION
--

THIS IS TO CERTIFY THAT:

THAT the application was prepared either by, or under the direct supervision of, the undersigned.

THAT the technical data supplied with the application was taken under my direction and supervision.

THAT the data was obtained on representative units, randomly selected.

THAT, to the best of my knowledge and belief, the facts set forth in the application and accompanying technical data are true and correct.

CERTIFYING ENGINEER:



Morton Flom, P. Eng.