

YAESU

AIR BAND TRANSCEIVER

FTA-850L

Operating Manual

CONTENTS

Important Notice!	1	Advanced Operation	27
Introduction	2	Bluetooth® Operation	27
Safety Precautions	3	Pairing the Bluetooth® Headset.....	27
Accessories and Options	5	Connecting to a registered (paired) Bluetooth® headset.....	29
Supplied Accessories.....	5	Transmit operation by pressing the button on the Bluetooth®	
Available Options	5	headset (when the VOX function is OFF)	29
Controls & Connectors	6	Reception of Weather Channel Broadcasts	30
Right Side.....	8	Lock Function	30
LCD Display (COM Band)	9	Changing the Channel Steps	31
VOR CDI Screen	10	Memory Operation	32
ILS CDI Screen.....	10	Recalling the Memories.....	32
Waypoint Navigation Screen.....	11	Instant Storage.....	33
GPS Compass Screen.....	11	Maintenance of the Memory.....	34
GPS Information Screen.....	12	Specifications	36
GPS Status Screen.....	12		
Before You Begin	13		
Battery Installation and Removal	13		
Battery Charging	14		
Alkaline Battery Tray Installation	15		
Low Battery Indication.....	15		
External DC Power Supply Connection	16		
Antenna Installation.....	16		
Belt Clip Installation.....	17		
Headset Connection.....	17		
Precautions	18		
Basic Operation	19		
Reception (COM Band)	19		
Turning the radio on and off	19		
Adjusting the frequency.....	20		
Adjusting the volume	21		
Adjusting the squelch	21		
Accessing the 121.5 MHz Emergency Frequency	22		
Transmission (COM Band).....	23		
Operation Bands	24		
Operation Modes.....	24		
Resetting the Radio.....	25		

IMPORTANT NOTICE!

FCC RF Exposure Compliance Requirements for Occupational Use Only:

The **FTA-850L** have been tested and comply with the Federal Communications Commission (FCC) RF exposure limits for Occupational Use/Controlled Exposure Environment. In addition, both radios comply with the following Standards and Guidelines:

- FCC 96-326, Guidelines for Evaluating the Environmental Effects of Radio-Frequency Radiation.
- FCC OET Bulletin 65 Edition 97-01 (1997) Supplement C, Evaluating Compliance with FCC Guidelines for Human Exposure to Radio Frequency Electromagnetic Fields.
- ANSI/IEEE C95.1-1992, IEEE Standard for Safety Levels with Respect to Human Exposure to Radio Frequency Electromagnetic Fields, 3 kHz to 300 GHz.
- ANSI/IEEE C95.3-1992, IEEE Recommended Practice for the Measurement of Potentially Hazardous Electromagnetic Fields - RF and Microwave.
- This radio is NOT approved for use by the general population in an uncontrolled environment. This radio is restricted to occupational use, work related operations only where the radio operator must have the knowledge to control its RF exposure conditions.**
- When transmitting, hold the radio in a vertical position with its microphone 1 to 2 inches (2.5 to 5 cm) away from your mouth and keep the antenna at least 1 inch (2.5 cm) away from your head and body.**
- The radio must be used with a maximum operating duty cycle not exceeding 75%, in typical Push-to-Talk configurations. DO NOT transmit for more than 75% of total radio use time (75% duty cycle). Transmitting more than 75% of the time can cause FCC RF exposure compliance requirements to be exceeded. The radio is transmitting when the “TX” icon is displayed on the upper left corner of the screen of the radio. You can cause the radio to transmit by pressing the PTT button.**
- Always use YAESU authorized accessories.**

NOTICE

*There are no user-serviceable points inside this transceiver.
All service jobs must be referred to your Authorized Service Center.*

INTRODUCTION

The YAESU **FTA-850L** is compact, stylish, solid hand-held transceivers providing communication (transmit and receive) capability on the International Aircraft Communication Band (“COM” band: 118 to 136.975 MHz), and additionally provide VOR and ILS navigation features on the “NAV” band (108 to 117.975 MHz).

The **FTA-850L** boast a 2.4” (49 x 37 mm) 240 x 320 full-dot, full-color TFT LCD displaying a plenty of information in a row. The **FTA-850L** include NOAA weather band monitoring and 200 memory channels. The channel configurations can be easily reprogrammed in minutes using the optional PC Programming Software and your PC, and additionally provide positioning and navigation features realized by the internal GPS unit.

We recommend that you read this manual in its entirety, so as to understand the many features of the **FTA-850L** completely. Keep this manual handy, so you may use it for reference.

Note: The VOR, ILS, and GPS navigation features of the FTA-850L is for supplemental aids to navigation only, and are not intended to be a substitute for accurate (primary) VOR or landing service equipment. You assume full responsibility for the use of the FTA-850L.

Congratulations!

You now have at your fingertips a valuable communications tool, a YAESU two-way radio! Rugged, reliable and easy to use, your YAESU radio will keep you in constant touch with your friends and colleagues for years to come, with negligible maintenance or down-time.

Please take a few minutes to read this manual carefully. The information presented here will allow you to derive maximum performance from your radio, in case questions arise later on.

We’re glad you joined the YAESU team. YAESU products cover the entire spectrum of radio communications applications, and our worldwide support network is here to serve you. Let us help you get your message across.

SAFETY PRECAUTIONS

Yaesu is not liable for any failures or problems caused by the use or misuse of this product by the purchaser or any third party. Also, Yaesu is not liable for damages caused through the use of this product by the purchaser or any third party, except in cases where ordered to pay damages under the laws.



Types and meanings of the marks



-  **DANGER** This mark indicates an imminently hazardous situation, which, if not avoided, could result in death or serious injury.

-  **WARNING** This mark indicates a potentially hazardous situation, which, if not avoided, could result in death or serious injury.

-  **CAUTION** This mark indicates a potentially hazardous situation, which, if not avoided, may result in minor or moderate injury or only property damage.

Types and meanings of symbols

-  These symbols signify prohibited actions, which must not be done to use this product safely. For example:  indicates that the product should not be disassembled.

-  These symbols signify required actions, which must be done to use this product safely. For example:  indicates that the power plug should be disconnected.

DANGER

-  **Do not use this product in "an area where use of it is prohibited", e.g., inside the hospital or train.**
This product can affect electronic or medical devices.

-  **Do not use this product while riding a bicycle or driving a car. Accidents can result.**
Be sure to stop the bicycle or car at a safe place before using this product.

-  **Do not perform transmission in a crowded place for the safety of persons using a medical device such as a cardiac pacemaker.**
The radio wave emitted from this product can cause the medical device to malfunction and result in an accident.

-  **Do not touch any material leaking from the battery pack with bare hands.**
The chemical that has stuck to your skin or entered your eye can cause chemical burns. In such a case, consult the doctor immediately.

-  **Those who are carrying a medical device such as a cardiac pacemaker should not perform transmission near the device. When transmitting, use an external antenna and keep as far as possible away from the external antenna.**
The radio wave emitted by the transmitter can cause the medical device to malfunction and result in an accident.

-  **Do not use this product or the battery charger in a place where inflammable gas is generated.**
A fire or explosion can occur.

-  **Do not solder or short-circuit the terminal of the battery pack.**
A fire, leak, overheating, explosion, or ignition can result if the battery pack together with a necklace, hair pin, or small metal objects. A short circuit can result.

WARNING

-  **Do not power this transceiver with a voltage other than the specified power supply voltage.**
A fire, electric shock, or damage may result.

-  **Do not use the battery pack for any model other than the specified transceiver.**
A fire, leak, overheating, explosion, or ignition can result.

-  **Do not make very long transmissions.**
The main body of the transceiver may overheat, resulting in a failure or burns.

-  **Do not disassemble or make any alteration to this product.**
An injury, electric shock, or failure can result.

-  When transmitting, keep the transceiver at least 5.0 mm (3/16 inch) away from your body. Use only the supplied antenna. Do not use modified or damaged antennas.

-  **Keep the terminals of the battery pack clean.**
If terminal contacts are dirty or corroded, a fire, leak, overheating, explosion, or ignition can result.

-  **Do not handle the battery pack or charger with wet hands. Do not insert or remove the power plug with wet hands.**
An injury, leak, fire, or failure can result.

 If smoke or strange odor is emitted from the main body, battery pack, or battery charger, immediately turn the transceiver off; remove the battery pack, and remove the power plug from the outlet. A fire, leak, overheating, damage, ignition, or failure can result. Contact the dealer from which you purchased this product or Yaesu Customer Support.

 Do not use the battery pack which is externally damaged or deformed. A fire, leak, heating, explosion, or ignition can result.

 Do not use any battery charger which is not specified by Yaesu. A fire or failure can result.

 If charging of the battery pack cannot be completed within the specified charging time, immediately remove the power plug of the battery charger from the outlet. A fire, leak, overheating, explosion, or ignition can result.

 **CAUTION**

 Do not dangle or throw this product by holding its antenna. This product can hit and injure someone. In addition, doing so can result in a transceiver failure or damage.

 Do not use transceiver in a crowded place. The antenna can hit someone, resulting in an injury.

 Do not place this transceiver in a place subject to direct sun-light or near a heater. The transceiver can deform or discolor.

 Do not place this transceiver in a humid or dusty place. A fire or failure can result.

 During transmission, keep the antenna as far from you as possible. Long-time exposure to electromagnetic waves can have a negative impact on your health.

 Do not clean the case with thinner or benzene. Use a soft, dry cloth to clean the case.

 If the transceiver is not being used for an extended period, turn it off and remove the battery pack for safety.

 Do not drop, strike, or throw the transceiver. A failure or damage may result.

 Keep magnetic cards and video tape away from the transceiver. The data recorded on cash cards or video tape can be erased.

 Charge the battery pack within the temperature range from +5 °C to +35 °C (+41 °F to +95 °F). Charging the battery pack outside this temperature range can cause leak, overheating, decrease in performance, or reduction in service life can result.

 When unplugging the power cord of the battery charger, be sure to hold the power plug. Pulling the power cord can damage it and cause a fire or electronic shock.

 Do not use the earphones or head-phones at an extremely high volume level. Hearing impairment can result.

 Keep this product out of reach of children. An injury, etc. can result.

 Install the belt clip securely. If they are installed improperly, the transceiver may fall or drop, resulting in an injury or damage.

 Do not place a heavy object on the power cord of the battery charger. The battery cord can be dam-aged, resulting in a fire or electric shock.

 Do not use the included battery charger to charge any battery pack which is not specified for use with the charger. A fire can result.

 Do not operate the transmitter near the TV or radio. Radio disturbance can occur in the transceiver, the TV, or the radio.

 Do not use any products other than the specified options and accessories. A failure can result.

 When the battery charger is not in use, remove its power plug from the outlet.

 Before discarding the worn battery pack, affix tape or the like to its terminals.

 Before using this transceiver in a hybrid or fuel-saving car, be sure to check with the auto-mobile manufacturer regarding use of the transceiver in that car.

 Noise generated by an onboard electrical device (inverter, etc.) can disrupt the normal operation of the transceiver.

 Do not use at extremely low atmospheric pressure.

ACCESSORIES AND OPTIONS

Supplied Accessories

Lithium-ion Battery Pack (7.2V 2200mAh)	SBR-39LI
AC Charger	SAD-25
Charger Cradle	SBH-11
Cigarette Lighter DC/DC Converter	SDD-12
Helical Antenna	SRA-20A*1
Belt Clip	SHB-11
Headset Adapter Cable	SCU-42
Alkaline Battery Tray	SBT-12
USB Cable	T9101606
Ferrite Core	L9190192
Operating Manual	

*1 Antenna gain: 2.15 dBi
 Impedance: 50 ohms

Available Options

Bluetooth® Headset	SSM-BT10
Speaker Microphone	SSM-20A
Speaker Microphone	SSM-10A
Earphone	SEP-10A*2
*2(available only with the SSM-20A or SSM-10A)	
Earphone	SEP-11A
Quick Release Holster	SHB-110
PC Programming Software	YCE46
(Download the YCE46 PC Programming Software from the YAESU website.)	

Availability of accessories may vary. Some accessories are supplied as standard per local requirements, while others may be unavailable in some regions. Consult your YAESU Dealer for details regarding these and any newly-available options. Connection of any non-YAESU-approved accessory, should it cause damage, may void the Limited Warranty on this apparatus.

CONTROLS & CONNECTORS

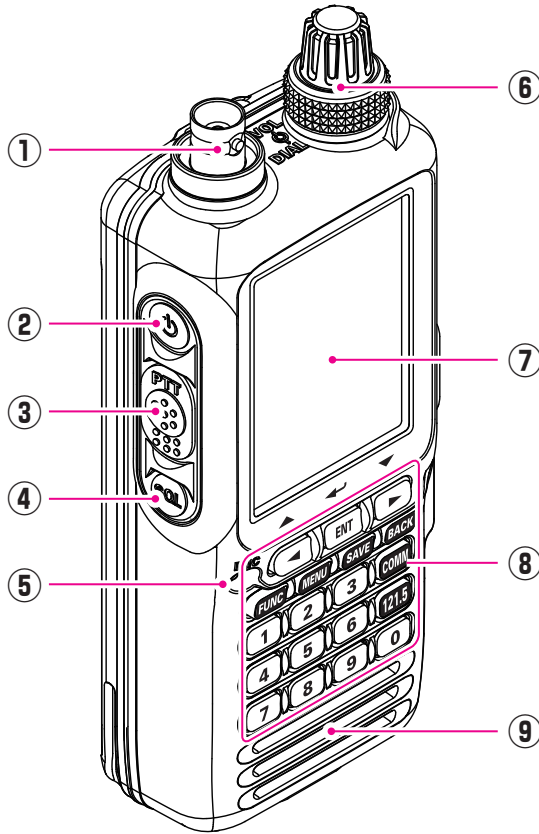

- ① Antenna Jack**
This BNC connector accepts the supplied flexible antenna, or an external antenna designed to provide 50 Ω impedance on the Aircraft Communication Band.
- ② POWER Switch**
Press and hold this button to turn the radio on and off.
- ③ PTT (Push To Talk) Switch**
Press and hold this button to transmit when you are operating in the COM band. Release this button to return to the "Receive" mode. See Page 23 for details.
- ④ SQL (Squelch) Switch**
This button may be pressed to "open" the squelch manually, allowing you to listen for very weak signals. Press and hold this button for 2 seconds to "open" the squelch continuously. Press this button again to resume normal (quiet) monitoring. See Page 21 for details.
- ⑤ Microphone**
Speak into this opening in a normal voice level, while pressing the **PTT** switch, to transmit.

⑥ **VOLUME (Inner) Knob**

Turn this (inner) control clockwise to increase the volume.

DIAL Selector (Outer) Knob

This (outer) 20-position detented rotary switch tunes the operating frequency or selects the memory channels.

⑦ **LCD (Liquid Crystal Display)**

The display shows selected operating conditions, as indicated on Pages 9 to 12.

⑧ **Keypad**

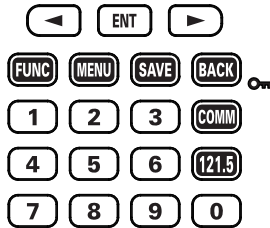

Cursor Keys and ENT Key

The cursor keys [◀] and [▶] are used to select an item displayed on the LCD.

Press the [ENT] key to determine the selection or entered values.

FUNC Key

Press this key to display the SUB MENU screen.

MENU Key

Press this key to display the MENU screen.

Press and hold this key to display the SETUP Mode screen.

BACK Key

Press this key to return the display to the previous screen.

Press and hold this key to enable the lock feature. Controls and keys will be disabled.

Press and hold again to disable the lock feature.

SAVE Key

Press this key to store the current channel information to the memory.

Press and hold this key to enable the lock feature. Controls and keys will be disabled. Press and hold again to disable the lock feature.

121.5 Key

Press and hold this key to access the emergency frequency (121.5 MHz) instantly.

COMM Key

Press this key to enter the COMM mode instantly.

Numeric Keypad

The keypad is used when setting frequencies.

⑨ **Loudspeaker**

The internal speaker is located in this position.

Right Side

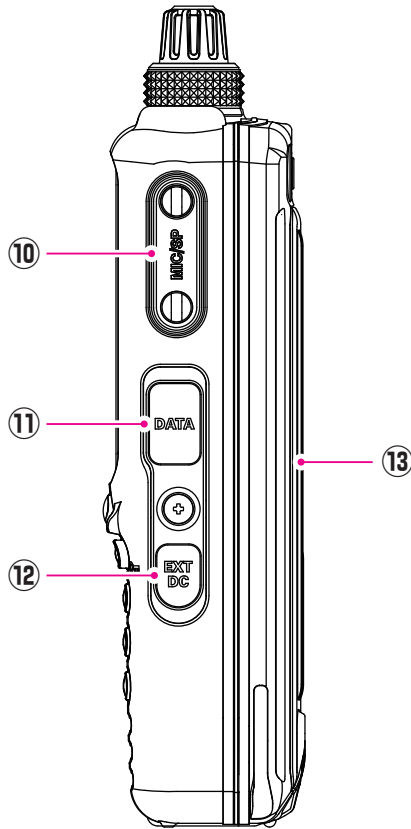

① MIC/SP Jack

You may connect the supplied **SCU-42** Headset Adapter Cable or the optional **SSM-20A** Speaker/Microphone to this jack. To use this jack, you must first remove the cover from the transceiver body.



Do not allow the FTA-850L to get wet while the cover over the MIC/SP jack is removed.

② DATA Jack

You may connect the optional USB cable to this jack. To use this jack, you must first lift the rubber cover away from the transceiver body.



Do not allow the FTA-850L to get wet while the rubber cover is removed.

③ EXT DC Jack

When an external 9.5 to 10.5 Volt DC power source is available, you may connect the **SDD-12** Cigarette Lighter DC/DC Converter here.



- 1) Do not allow the FTA-850L to get wet while the rubber cover is removed.***
- 2) Do not connect any accessory unapproved by YAESU to supply DC power.***

LCD DISPLAY (COM BAND)

“BUSY” icon appears during audio reception, or “TX” during transmission.

This field displays the operating frequency.

This field displays the tag name of the current channel.

This field displays the channels you have previously used.



This field displays the icons indicating various statuses of the transceiver, such as “GPS on”, “Data Logger on”, “Timer on”, “Bluetooth on”, “Battery level”.

This field displays the icons indicating various statuses of functions, such as Dual WATCH on”, “ANL on”, “VOX on”, “Split on”.

This field displays the level of the audio volume or the squelch.

LCD DISPLAY (NAV BAND)

VOR CDI Screen



- ① Compass rose
- ② Course indicator (OBS direction)
- ③ Deviation marks
- ④ Course deviation needle
- ⑤ OBS (omni bearing selector) value
- ⑥ VOR value
- ⑦ TO/FROM indicator
- ⑧ SOG (speed over ground) value according to the GPS signal

ILS CDI Screen

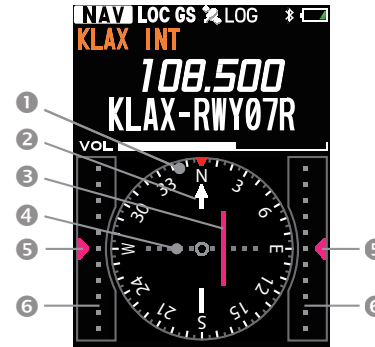

- ① Compass rose
- ② Course (runway) indicator
- ③ Course deviation needle for localizer
- ④ Deviation marks for localizer
- ⑤ Height deviation indicator for glide slope
- ⑥ Deviation marks for glide slope

LCD DISPLAY

Waypoint Navigation Screen



- ① Tag name of the next waypoint
- ② Compass rose
- ③ Course indicator
- ④ Destination indicator
- ⑤ DST (distance) value
- ⑥ COG (course over ground) value
- ⑦ SOG (speed over ground) value
- ⑧ Altitude value

GPS Compass Screen



- ① Compass rose
- ② Course indicator
- ③ COG (course over ground) value
- ④ SOG (speed over ground) value
- ⑤ Altitude value
- ⑥ Date obtained from the GPS signal

GPS Information Screen



- ① Latitude and longitude values
- ② COG (course over ground) value
- ③ Date obtained from the GPS signal
- ④ SOG (speed over ground) value
- ⑤ Altitude value

GPS Status Screen



- ① GPS receiver operation status
- ② Radar scope for captured GPS satellites
- ③ Date obtained from the GPS signal
- ④ Latitude and longitude values
- ⑤ GPS signal strength indicator

BEFORE YOU BEGIN

Battery Installation and Removal

- ❑ To install the battery, insert the battery pack **SBR-39LI** into the battery compartment on the back of the transceiver, press the end of the battery pack while pressing the battery pack latch on the bottom of the transceiver, then lock the pack by sliding the locking plate beside the latch until the entire “**LOCK**” appears.

Note:

Be sure that the rubber gasket on the **SBR-39LI** is not loose when inserting.

- ❑ To remove the battery, turn the transceiver off, slide the locking plate until the “**UNLOCK**” appears entirely, lift up the end of the battery pack by pressing the battery pack latch, then pull out the battery from the radio.

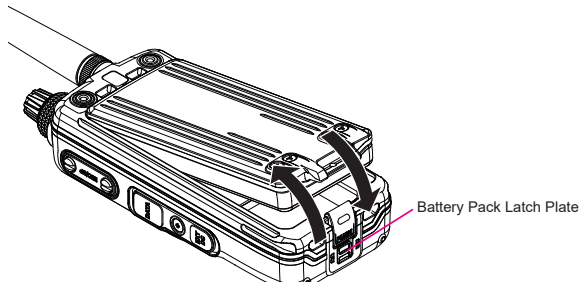

Do not attempt to open any of the rechargeable Lithium-ion packs, as personal injury or damage to the Lithium-ion pack could occur if a cell or cells become accidentally short-circuited.

Note:

To remove the battery pack after the belt clip **SHB-11** is mounted (see Page 14), lift up the clip before you press the battery pack latch.

Caution:

Risk of explosion if battery is replaced by an incorrect type.
Dispose of used batteries according to the instructions.

Battery Charging

It is necessary to charge the Lithium-ion battery fully before its first use. Follow the procedure below:

1. Install the Lithium-ion battery pack onto the transceiver. Ensure that the transceiver is switched off.
2. Insert the cable plug of the **SAD-25** Battery Charger into the jack located on the back of the **SBH-11** Charging Cradle, then plug the **SAD-25** into the AC line outlet.

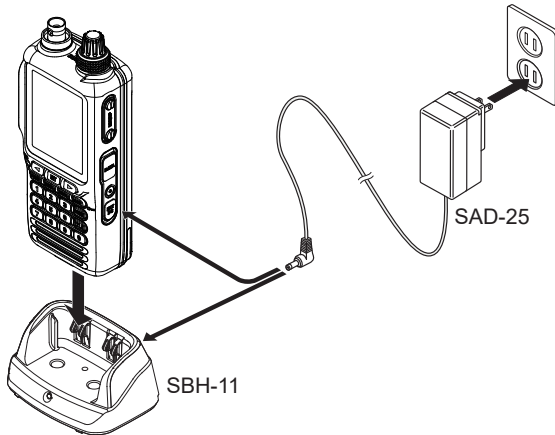

3. Insert the transceiver into the **SBH-11**; the antenna jack should be at the left side when viewing the cradle from the front.

- You may insert the cable plug of the **SAD-25** into the **EXT DC** jack located on the right side of the transceiver directly. In this case, the “⚡” icon will appear in the top right corner of the LCD display.
- 4. If the transceiver is inserted correctly, the RED indicator on the **SBH-11** will glow.
 - A fully-discharged pack will be charged completely in 4 hours, and then the GREEN indicator on the **SBH-11** will glow.
 - It takes 8 hours for full charge with the **SAD-25** connected to the transceiver directly.

Important Notes:

- The **SAD-25** is not designed to power the transceiver for operation (transmission).
- Do not leave the charger connected to the transceiver for continuous periods in excess of 24 hours. Long term overcharging can degrade the Lithium-ion battery pack and significantly shorten its useful life.
- If using a charger other than the **SAD-25**, **SBH-11**, or if using a battery pack other than the **SBR-39LI**, follow the appropriate instructions provided with the charger/battery. Contact your Dealer if you have any doubts about the appropriateness of the particular charger or battery pack you intend to use.

Alkaline Battery Tray Installation

The supplied **SBT-12** Battery Tray allows operation of the **FTA-850L** using six “AA” size alkaline battery cells.

- ❑ When installing a cell, insert the (–) end first, then press in the (+) end so the cell snaps into place. Pay attention to the polarity indicated inside the case.

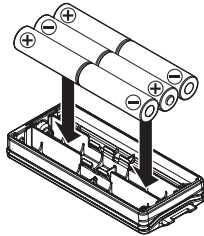

SBT-12
Alkaline Battery Tray



The SBT-12 must not be used with rechargeable cells. The SBT-12 does not contain the thermal and over-current protection circuits required when utilizing Ni-Cd and Ni-MH cells.

Note: Replace all six cells at the same time in case of low battery.

- ❑ To install the **SBT-12**, remove the Lithium-ion battery pack first from the transceiver, turn the open side of the **SBT-12** down, then insert it into the battery compartment.

Note: Be sure that the rubber gasket on the SBT-12 is not loose when inserting.

Low Battery Indication

As your battery discharges during use, the voltage will gradually become lower. When the battery voltage reaches 6.0 Volts, the “” icon will blink on the LCD display, indicating that the battery pack must be recharged or the alkaline battery cells must be replaced before further use.

- Avoid recharging Lithium-ion batteries before the “Low Battery” indicator is observed, as this can degrade the charge capacity of your Lithium-ion battery pack. YAESU recommends that you carry an extra, fully-charged pack with you so you will not lose communications capability due to a depleted Lithium-ion battery.
- The fully-charged battery lasts for 10 hours on the **FTA-850L** under the conditions below:

Battery saver ... ON

Operation ratio ... TX:RX:Standby = 6:6:48 (sec)