

STANDARD HORIZON

Nothing takes to water like Standard Horizon

HX320 HX320E

Floating VHF FM Marine Transceiver

Owner's Manual



TABLE OF CONTENTS

QUICK REFERENCE	1	9. ADVANCED OPERATION	29
1. GENERAL INFORMATION	2	9.1 Bluetooth® Operation	29
1.1 INTRODUCTION	2	9.1.1 Pairing the Bluetooth® Headset	29
2. SAFETY PRECAUTIONS	3	9.1.2 Transmit operation by pressing the button on the Bluetooth® headset ...	31
3. ONLINE WARRANTY REGISTRATION	4	9.1.3 Hands-free VOX operation with a Bluetooth® headset ..	31
4. ABOUT THIS RADIO	4	9.1.4 Connect to another paired Bluetooth® headset	31
4.1 ABOUT THE VHF MARINE BAND	4	9.2 VOX Operation	33
4.2 ABOUT WATER PROTECTION	4	10. MENU ("SETUP")	34
4.3 DISTRESS AND HAILING (CHANNEL 16)	5	10.1 CHANNEL SETUP	34
4.4 CALLING ANOTHER VESSEL (CHANNEL 16 OR 9)	5	10.1.1 CHANNEL GROUP	34
4.5 BRIDGE CHANNELS 13 AND 67	6	10.1.2 WEATHER ALERT (in USA and Canada only)	34
4.6 SIMPLEX/DUPLEX CHANNEL USE	6	10.1.3 SCAN MEMORY	34
4.7 NOTES TO ASSURE WATERPROOF INTEGRITY	7	10.1.4 SCAN TYPE	34
4.8 RADIO CARE	7	10.1.5 SCAN RESUME	35
5. ACCESSORIES	8	10.1.6 MULTI WATCH	35
5.1 PACKING LIST	8	10.1.7 PRIORITY CH	35
5.2 OPTIONS	8	10.1.8 SUB CH	36
6. GETTING STARTED	9	10.1.9 VOX	36
6.1 BATTERIES AND CHARGERS	9	10.2 FM SETUP	36
6.1.1 BATTERY SAFETY	9	10.2.1 ADD	36
6.1.2 BATTERY CHARGING	10	10.2.2 EDIT	37
6.1.3 BATTERY LIFE INFORMATION	11	10.2.3 DELETE	37
6.2 BELT CLIP INSTALLATION / REMOVAL	11	10.3 BLUETOOTH	38
7. CONTROLS AND INDICATORS	12	10.4 ATIS SETUP (HX320E only)	38
7.1 CONTROLS AND SWITCHES	12	10.5 CONFIG	38
7.2 LCD INDICATORS	14	10.5.1 KEY BEEP	38
8. BASIC OPERATION	16	10.5.2 BATTERY SAVE	38
8.1 PROHIBITED COMMUNICATIONS	16	10.5.3 STROBE LED	39
8.2 INITIAL SETUP	16	10.5.4 KEY SETUP	39
8.3 RECEPTION	16	10.5.5 BACKLIT LEVEL	40
8.4 TRANSMISSION	16	10.5.6 BACKLIT TIMER	40
8.4.1 TRANSMIT POWER	17	10.5.7 CONTRAST	40
8.4.2 TRANSMIT TIME - OUT TIMER (TOT)	17	10.5.8 RESET	41
8.5 CHANNEL GROUP	18	10.6 ABOUT...	41
8.6 KEYPAD LOCKING	18	10.7 Tables of Setup Menu Operations	41
8.7 NOAA WEATHER CHANNELS (In USA and Canada only)	18	11. ATIS SETUP (HX320E only)	43
8.7.1 NOAA WEATHER ALERT	19	11.1 ATIS CODE PROGRAMMING	43
8.7.2 NOAA WEATHER ALERT TESTING	19	11.2 ATIS CH GROUP	44
8.8 PRESET CHANNELS: INSTANT ACCESS	20	12. MAINTENANCE	45
8.8.1 PROGRAMMING PRESET CHANNEL BANKS	20	12.1 GENERAL	45
8.8.2 OPERATION on a Preset Channel	20	12.2 FACTORY SERVICE	45
8.8.3 Deleting a Preset Channel	21	12.3 TROUBLESHOOTING CHART	45
8.9 SCANNING	22	13. VHF MARINE CHANNEL ASSIGNMENTS ...	46
8.9.1 PROGRAMMING SCAN MEMORY	22	13.1 HX320 (USA Version)	46
8.9.2 SELECTING SCAN TYPE	22	13.2 HX320E	49
8.9.3 SCANNING OPERATION	23	14. SPECIFICATIONS	51
8.10 MULTI WATCH (TO PRIORITY CHANNEL) ...	24	15. FCC AND CANADA RADIO LICENSE INFORMATION	52
8.10.1 Setting up the Multi Watch Operation	24	15.1 MARITIME STATION LICENSE	52
8.10.2 Starting the Dual Watch	24	15.2 MARINE RADIO CALL SIGN	52
8.10.3 Starting the Triple Watch	25	15.3 CANADIAN SHIP STATION LICENSING	52
8.11 Listening to the FM Broadcast Radio	26	15.4 FCC / ISED INFORMATION	52
8.11.1 FM broadcast Frequency sweep operation	26	16. RF EXPOSURE SAFETY STATEMENT	53
8.11.2 Store the FM frequency	26	16.1 SAFETY INFORMATION	53
8.11.3 Memory Frequency Recall	27	16.2 CONSIGNES DE SECURITE	53
8.12 Soft Keys	27	17. FCC NOTICE	54
8.12.1 Key Assignment	27	STANDARD HORIZON Limited Warranty	56
8.12.2 Key Timer	28		

QUICK REFERENCE

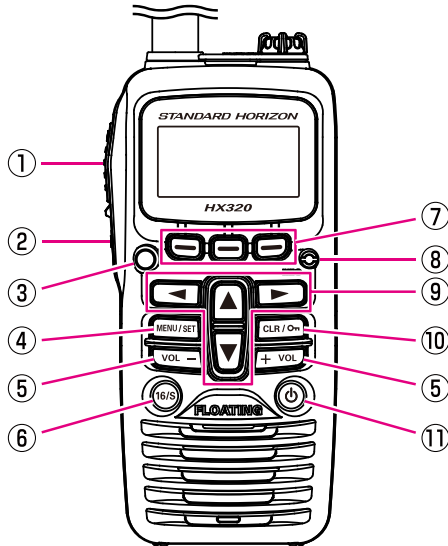

- ① **PTT (Push-To-Talk):** Activates the transmitter when pressed.
- ② **SQL:** Press to display the SQL level setting screen, then press the [▲] / [▶] key to squelch or press the [▼] / [◀] to un-squelch the radio. Press and hold to open the squelch. Press the key to resume normal.
- ③ **Strobe Light:** Glows the Strobe Light continuously by pressing the [STRB] soft key.
- ④ **MENU/SET:** Press to access MENU. Press and hold to enter SETUP Mode.
- ⑤ **VOL- / +VOL:** Press to adjust the speaker audio volume.
- ⑥ **16/S:** Press to recall channel 16. Press and hold to recall the sub channel.
- ⑦ **Soft keys:** These three programmable keys can be customized through the setup menu mode. By pressing one of these keys briefly, display the key functions at the bottom of the display.
- ⑧ **MIC:** Speak slowly and clearly into the **MIC** aperture having it about 1/2 to 1 inch (1.2 to 2.5 cm) away from your mouth while pressing the **PTT** key.
- ⑨ **◀/▶:** Press to toggle the on-screen menus to right/left.
▼/▲: Press to change the operating channel.
- ⑩ **CLR/On:** Press to cancel a function or menu selection.
Press and hold to lock and unlock the keypad.
- ⑪ **⏻:** Press and hold to turn the transceiver ON/OFF.

1. GENERAL INFORMATION

1.1 INTRODUCTION

Congratulations on your purchase of the **HX320**! Whether this is your first portable marine VHF transceiver, or if you have other STANDARD HORIZON equipment, the STANDARD HORIZON organization is committed to ensuring your enjoyment of this high-performance transceiver, which should provide you with many years of satisfying communications even in the harshest of environments. STANDARD HORIZON technical support personnel stand behind every product sold, and we invite you to contact us should you require technical advice or assistance. We appreciate your purchase of the **HX320**, and encourage you to read this manual thoroughly, so as to learn and fully understand the capabilities of the **HX320**.

The **HX320** is a Submersible*¹ Floating 6-Watt (5-Watt)*² portable two-way marine transceiver. The transceiver has all allocated International, USA, or Canadian channels. It has emergency channel 16 which can be immediately selected from any channel by pressing the [16/S] key. The **HX320** is equipped with the Bluetooth® function as standard, it supports hands-free communications using the optional Bluetooth® headset or commercially available products. Connect the USB cable directly to the USB type-C charging terminal of the **HX320** and it will completely charge in about 5 hours.

The **HX320** includes the following features: Memory Scanning, Priority Scanning, Dual and Triple watch, NOAA Weather Alert, easy-to-read large LCD display, Battery Life display on the LCD, and a transmit Time-Out Timer (TOT).

The **HX320** transmitter provides a full 6-Watt (5-Watt)*² of transmit power which is also selectable to 1 Watt to assist the user in ensuring maximum battery life.

The **HX320E** supports ATIS mode which is used in the inland waterways of Europe. Please contact your local PTT administration or Marine Authority to obtain your ATIS number.

We appreciate your purchase of the **HX320**, and encourage you to read this manual thoroughly, so as to learn and fully understand the capabilities of the **HX320**.

*¹(IPX7 Specification for submersibility: 3 ft. (1 m) for 30 minutes)

*²(5-Watt TX required in Some Countries)



The Bluetooth® wordmark and logo are registered trademarks owned by Bluetooth SIG, Inc. and are used under license by Yaesu Musen Co., Ltd.

2. SAFETY PRECAUTIONS





Be sure to read the safety precautions, and use this product safely.

Yaesu is not liable for any failures or problems caused by the use or misuse of this product by the purchaser or any third party. Also, Yaesu is not liable for damages caused through the use of this product by the purchaser or any third party, except in cases where ordered to pay damages under the laws.





Types and meanings of the marks

-  **DANGER** This mark indicates an imminently hazardous situation, which, if not avoided, could result in death or serious injury.
-  **WARNING** This mark indicates a potentially hazardous situation, which, if not avoided, could result in death or serious injury.
-  **CAUTION** This mark indicates a potentially hazardous situation, which, if not avoided, may result in minor or moderate injury or only property damage.







Types and meanings of symbols

-  These symbols signify prohibited actions, which must not be done to use this product safely. For example:  indicates that the product should not be disassembled.
-  These symbols signify required actions, which must be done to use this product safely. For example:  indicates that the power plug should be disconnected.













DANGER

-  **Do not operate the device when flammable gas is generated.**
Doing so may result in fire and explosion.
-  **Do not transmit with this device in a crowded place for the safety of persons using a medical device such as a cardiac pacemaker.**
The radio wave emitted from this product can cause the medical device to malfunction and result in an accident.
-  **Do not touch any liquid leaking from the liquid display with your bare hands.**
There is a risk of chemical burns occurring when the liquid comes into contact with the skin or gets into the eyes. In this case, seek medical treatment immediately.
-  **Do not touch any material leaking from the battery pack with bare hands.**
The chemical that has stuck to your skin or entered your eye can cause chemical burns. In such a case, consult the doctor immediately.
-  **Do not solder or short-circuit the terminals of the battery pack.**
A fire, leak, overheating, explosion, or ignition may result. Do not carry the battery pack together with a necklace, hairpin, or small metal objects. A short circuit can result.

WARNING

-  **Do not power this transceiver with a voltage other than the specified power supply voltage.**
A fire, electric shock, or damage may result.
-  **Do not make very long transmissions.**
The main body of the transceiver may overheat, resulting in component failure or operator burns.
-  **Do not disassemble or make any alteration to this product.**
An injury, electric shock, or failure may result.
-  **Never touch the antenna during transmission.**
This may result in injury, electric shock and equipment failure.
-  **Do not handle the battery pack or charger with wet hands. Do not insert or remove the power plug with wet hands.**
An injury, leak, fire, or failure may result.
-  **If smoke or a strange odor is emitted from the main body, battery pack, or battery charger, immediately turn the transceiver off.**
A fire, chemical leak, overheating, component damage, ignition, or failure may result. Please contact the dealer from which you purchased this product.

CAUTION

-  **Do not place the transceiver on an unsteady or sloping surface, or in a location with extreme vibration.**
The transceiver may fall or drop, resulting in fire, injury and equipment damage.
-  **Stay as far away from the antenna as possible during transmission.**
Long-term exposure to electromagnetic radiation may have a negative effect on the human body.
-  **Do not dangle or throw the transceiver by holding its antenna.**
This may injure others and may also result in damage and failure of the transceiver.
-  **Do not wipe the case using thinner and benzene etc.**
Use only a soft, dry cloth to wipe stains from the case.
-  **Keep this product out of the reach of children.**
Injury to the child, or damage to the transceiver may result.
-  **Do not use any products other than the specified options and accessories.**
Failure or miss operation may result.
-  **If the transceiver will not be used for an extended period, turn it OFF for safety.**
-  **Do not throw the transceiver, or subject it to strong impact forces.**
Physical abuse may result in component damage and equipment failure.
-  **Keep magnetic cards and videotapes away from the transceiver.**
The data recorded on cash cards or videotapes may be erased.
-  **Do not use the transceiver in a crowded place.**
The antenna may strike others and result in an injury.
-  **Install the hand strap and belt clip securely.**
Improper installation may cause the transceiver to fall or drop, resulting in an injury or damage.
-  **Before discarding a depleted battery pack, affix tape or insulating covering to its terminals.**

3. ONLINE WARRANTY REGISTRATION

Please visit www.standardhorizon.com - Owner's Corner to register the HX320 Marine VHF.

NOTE: visiting the STANDARD HORIZON website from time to time may be beneficial. When new products are released, information will appear on the website.

4. ABOUT THIS RADIO

4.1 ABOUT THE VHF MARINE BAND

The radio frequencies used in the VHF marine band lie between 156 and 158 MHz with NOAA Weather stations available between 161 and 163 MHz. The marine VHF band provides communications over distances that are essentially "Line of sight" Actual transmission range depends much more on antenna type, gain and height than on the power output of the transmitter. On a fixed mount 25 W radio transmission expected distances can be greater than 15 miles, for a portable 5 W radio transmission the expected distance can be greater than 5 miles in "Line of sight".

The user of a Marine VHF radio is subject to severe fines if the radio is used on land. The reasoning for this is you may be near an inland waterway, or propagation anomalies may cause your transmission to be heard in a waterway. If this occurs, depending upon the marine VHF channel on which you are transmitting, you could interfere with a search and rescue case, or contribute to a collision between passing ships. For VHF Marine channel assignments refer to section "13. VHF MARINE CHANNEL ASSIGNMENTS".

WARNING

This radio is capable of transmitting on Marine VHF radio frequencies. The FCC allows the use of VHF Marine band on water areas only. Use of the VHF Marine band when on land is not permitted. If persons use the VHF Marine Band on land and interfere with other communications, the FCC will be notified and search for the interference. Responsible parties found to be transmitting on the VHF Marine Band on land could be fined up to \$10,000 for the first offense.

4.2 ABOUT WATER PROTECTION

The HX320 is only submersible* when the MIC/SP jack and the CHG jack are securely covered with the rubber caps.

* (IPX7 Specification for submersibility: 3 ft. (1 m) for 30 minutes)

4.3 DISTRESS AND HAILING (CHANNEL 16)

Channel 16 is designated as the Hail and Distress Channel. An emergency may be defined as a threat to life or property. In such instances, be sure the transceiver is turned ON, and set to "Channel 16". Then use the following procedure:

1. Press the **PTT** (Push-To-Talk) switch and say "**Mayday, Mayday, Mayday**. This is _____, _____, _____" (your vessel's name).
2. Then repeat once: "**Mayday, _____**" (your vessel's name).
3. Now report your position in latitude/longitude, or by giving a true or magnetic bearing (state which) to a well-known landmark such as a navigation aid or geographic feature such as an island or harbor entry.
4. Explain the nature of your distress (sinking, collision, aground, fire, heart attack, life-threatening injury, etc.).
5. State the kind of assistance you desire (pumps, medical aid, etc.).
6. Report the number of persons aboard and condition of any injured.
7. Estimate the present seaworthiness and condition of your vessel.
8. Give your vessel's description: length, design (power or sail), color and other distinguishing marks. The total transmission should not exceed 1 minute.
9. End the message by saying "**OVER**". Release the **PTT** switch and listen.
10. If there is no answer, repeat the above procedure. If there is still no response, try another channel.

4.4 CALLING ANOTHER VESSEL (CHANNEL 16 OR 9)

Channel 16 may be used for initial contact (hailing) with another vessel.

However, its most important use is for emergency messages. This channel must be monitored at all times except when actually using another channel.

It is monitored by the U.S. and Canadian Coast Guards and by other vessels. Use of channel 16 for hailing must be limited to initial contact only. Calling should not exceed 30 seconds, but may be repeated 3 times at 2-minute intervals. In areas of heavy radio traffic, congestion on channel 16 resulting from its use as a hailing channel can be reduced significantly in U.S. waters by using Channel 9 as the initial contact (hailing) channel for non-emergency communications. Here, also, calling time should not exceed 30 seconds but may be repeated 3 times at 2-minute intervals.

Prior to making contact with another vessel, refer to the channel charts in this manual, and select an appropriate channel for communications after initial contact. For example, Channels 68 and 69 of the U.S. VHF Charts are some of the channels available to non-commercial (recreational) boaters. Monitor your desired channel in advance to make sure you will not be interrupting other traffic, and then go back to either channel 16 or 9 for your initial contact.

When the hailing channel (16 or 9) is clear, state the name of the other vessel you wish to call and then **“this is”** followed by the name of your vessel and your Station License (Call Sign). When the other vessel returns your call, immediately request another channel by saying **“go to”**, the number of the other channel, and **“over”**. Then switch to the new channel. When the new channel is not busy, call the other vessel.

After a transmission, say **“over”**, and release the **PTT** (Push-To-Talk) switch. When all communication with the other vessel is completed, end the last transmission by stating your Call Sign and the word **“out”**. Note that it is not necessary to state your Call Sign with each transmission, only at the beginning and end of the contact.

Remember to return to Channel 16 when not using another channel. Some radios automatically monitor Channel 16 even when set to other channels or when scanning.

4.5 BRIDGE CHANNELS 13 AND 67

Channel 13 is used at docks, bridges and by vessels maneuvering in port. Messages on this channel must concern navigation only, such as meeting and passing in restricted waters.

Channel 67 is used for navigational traffic between vessels.

By regulation, power is normally limited to 1 Watt on these channels. Your radio is programmed to automatically reduce power to this limit on these channels. However, in certain situations it may be necessary to temporarily use a higher power. See page 14 for means to temporarily override the low-power limit on these two channels.

4.6 SIMPLEX/DUPLEX CHANNEL USE

Refer to the section **“13. VHF MARINE CHANNEL ASSIGNMENTS”** for instructions on use of simplex and duplex channels.

NOTE

All channels are factory-programmed in accordance with FCC (USA), ISED (Canada) and International regulations. The mode of operation cannot be altered from simplex to duplex or vice-versa. Simplex (ship to ship) or duplex (marine operator) mode is automatically activated, depending on the channel and whether the USA, International or Canadian operating band is selected.

4.7 NOTES TO ASSURE WATERPROOF INTEGRITY

CAUTION!

To ensure the waterproof integrity of the **HX320**, please make sure to observe the precautions described below of the **HX320** observe the precautions regarding waterproofing as described below.

Failure to observe even one of the precautions may degrade the waterproof integrity, resulting in water intrusion into the transceiver. As a result, the transceiver will not float.

- To prevent water intrusion please make sure that the MIC/SP cap and CHG jack cover are properly sealed.
- Make sure that there is no dust, dirt or crack on the jack or the rubber gasket.

NOTE

If you find any cracks on the MIC/SP cap, CHG jack cover or gasket, please contact Standard Horizon or your local dealer to purchase a replacement.

4.8 RADIO CARE

After using the **HX320** in a salt water environment, it is recommended to clean the radio with fresh water by rinsing the radio under a sink faucet or by dunking the radio in a bucket of fresh water. After washing, use a soft cloth and thoroughly dry all parts of the radio. This is to keep the rubber switches and speaker grill clean and in top operating condition.

5. ACCESSORIES

5.1 PACKING LIST

When the package containing the transceiver is first opened, please check it for the following contents:

Transceiver **HX320**
Antenna*
USB AC Adapter
Charger Cradle
Belt Clip
USB Cable for charging (USB Type-A to USB Type-C)
Hand Strap
Owner's Manual

*(Antenna gain: -1.5dBi, Impedance: 50 ohm)

5.2 OPTIONS

Submersible Speaker Microphone with Earphone Jack	SSM-21A
Earphone for SSM-21A	SEP-10A
Submersible Speaker Microphone	MH-73A4B
Speaker Microphone	SSM-17H
VOX Headset	SSM-64A
Earpiece Microphone	SSM-517A
Bluetooth® Headset	SSM-BT10
USB AC Adapter	
Quick Release Holster	
Belt Clip Hanger	
SMA to BNC Adaptor	

NOTE: Charge the battery before operating the **HX320** for the first time. Please see section “**6.1 BATTERIES AND CHARGERS**” for details.

6. GETTING STARTED

6.1 BATTERIES AND CHARGERS

If the radio has never been used, or its charge is depleted, it may be charged by connecting the supplied USB AC adapter, see section “**6.1.2 BATTERY CHARGING**”. The USB AC adapter will charge a completely discharged built-in battery in approximately 5 hours.

Built-in Rechargeable Battery

Capacity	2100mAh			
Nominal Voltage	7.4V			
Temperature Range	Minimum		Maximum	
	°C	°F	°C	°F
Charge	5	41	35	95
Discharge	-20	-4	60	140
Storage	-10	14	35	95

CAUTION

To avoid risk of explosion and injury, the built-in battery pack should only be charged or recharged in non-hazardous environments.

6.1.1 BATTERY SAFETY

The built-in battery of this transceiver contains Li-ion batteries. This type of battery stores a charge powerful enough to be dangerous if misused or abused, especially when removed from the transceiver. Please observe the following precautions:

DO NOT SHORT BATTERY PACK TERMINALS: Shorting the terminals that power the transceiver can cause sparks, severe overheating, burns, and battery cell damage. If the short is of sufficient duration, it is possible to melt battery components. Do not place a loose battery pack on or near metal surfaces or objects such as paper clips, keys, tools, etc.

DO NOT INCINERATE: Do not dispose of any battery in a fire or incinerator. The heat of fire may cause battery cells to explode and/or release dangerous gases.

Battery Maintenance

For safe and proper battery use, please observe the following:

- Use only STANDARD HORIZON approved batteries.
- Do not reverse the charge polarity. Use only the proper charger. If this is tampered with or another charger is used, permanent damage may result.
- Use only a STANDARD HORIZON approved charger. The use of any other charger may cause permanent damage to the battery.

Battery Recycling

**DO NOT PLACE USED BATTERIES IN THE REGULAR TRASH!
LI-ION BATTERIES MUST BE COLLECTED, RECYCLED OR
DISPOSED OF IN AN ENVIRONMENTALLY SOUND MANNER.**



Incinerating Li-ion batteries, placing them in the land fill, or mixing them with the municipal solid waste collection, is **PROHIBITED BY LAW** in most areas.

Return batteries to an approved Li-ion battery recycler. This may be available you purchased the battery.

Contact your local waste management officials for other information regarding the environmentally sound collection, recycling and disposal of Li-ion batteries.

6.1.2 BATTERY CHARGING

Using the supplied USB AC adapter take about 5 hours* to charge the built-in battery fully.

*(Depending on the battery status, the charging time might be increased.)

1. Turn the transceiver **OFF**.
2. Referring to the figure, connect the battery charger plugs.
 - The **HX320's** LCD display will show the battery charging icon "⚡".
 - When charging is completed, the battery charging icon will disappear.

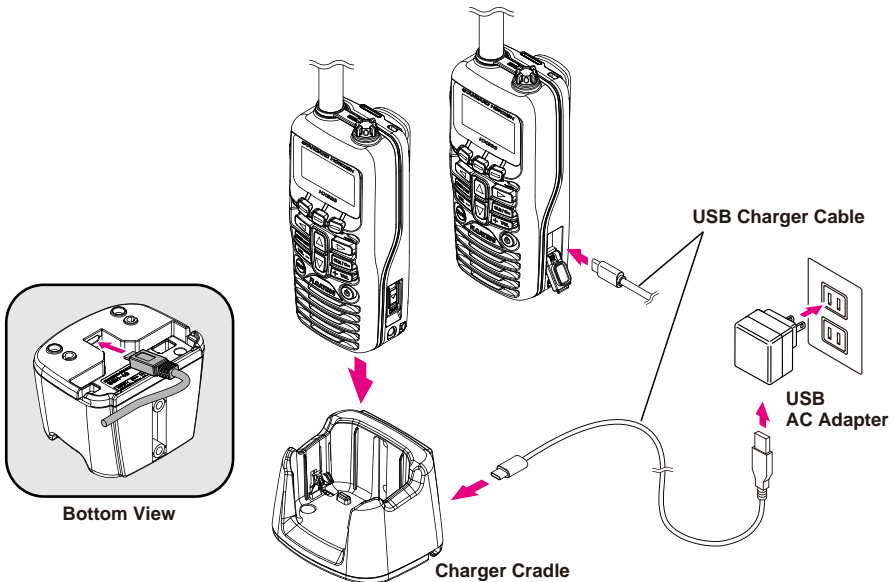





CAUTION

The charger and charger cradle are **NOT** designed to be waterproof.
Do not attempt to charge in water hazardous locations.

NOTES

- The **USB AC adaptor** is only designed for the charging of the **HX320's** built-in battery, and is not suitable for other purposes. The USB AC adaptor may introduce noise to TV and radio reception in the immediate vicinity, so it is not recommended for use adjacent to such devices.
- Contact Standard Horizon dealer or Factory Service about the built-in battery replacement. Refer to the section “**12.2 FACTORY SERVICE**”.

6.1.3 BATTERY LIFE INFORMATION

	: Full battery power
	: Enough battery power
	: Low battery power
	: Poor battery power. Charge battery.
	: Charge the battery immediately

When the “” icon appears, it is recommended that the battery be charged soon.

WARNING

If the transceiver will be unused for a long period of time, be sure to fully charge the built-in battery before storing it. When the transceiver is stored for an extended period, recharge the built-in battery every six months to prevent it from over-discharging.

6.2 BELT CLIP INSTALLATION / REMOVAL

- To install the Belt Clip: align the Belt Clip to the niche on the rear of the transceiver, then slide the Belt Clip downward until it locks in place with a “Click”.
- To remove the Belt Clip: press the Belt Clip Tab away from the rear of the transceiver to unlock the Belt Clip, then slide the Belt Clip upward to remove it.

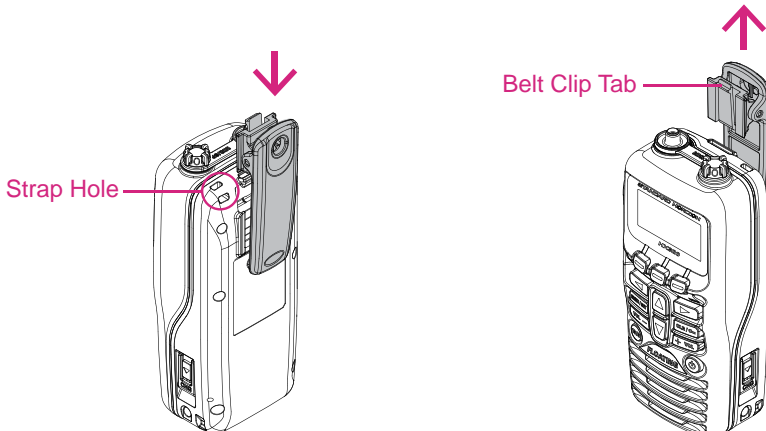

7. CONTROLS AND INDICATORS

7.1 CONTROLS AND SWITCHES

NOTE

This section defines each control of the transceiver. For detailed operating instructions, refer to section "8. BASIC OPERATION". Refer to the below illustration for the locations of the following controls, switches, and connections.

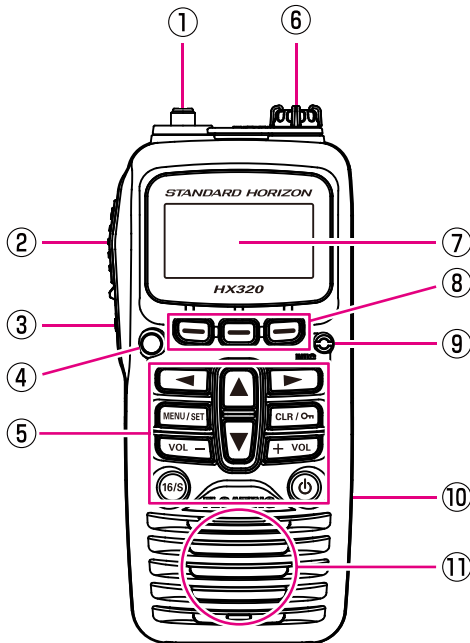

① **ANT Jack**

The supplied antenna is attached here.

② **PTT (PUSH-TO-TALK) Switch**

When pushed activates the transmitter.

③ **SQL Switch**

Press this key to SQL adjustment.

Secondary use:

Press and hold this key to open the squelch, allowing you to monitor the operating channel. Press the key to resume normal (squelch controlled) monitoring.

④ **Water Enabled Light**

When the **HX320** comes in contact with water, the light will blink white to assist finding the radio in low light conditions. This feature operates when the radio is ON or OFF.

⑤ **Keypad**

- **▲ (UP) Key**

Press this key to change the operating channel or the squelch threshold level. Pressing the key momentarily, will increase the channel (or level) will increase one step. Holding the key, will increase the channel (or level) continuously.

- **▼ (DOWN) Key**

Press this key to change the operating channel, or the squelch threshold level.

Pressing the key momentarily, will decrease the channel (or level) will decrease one step. Holding the key, will decrease the channel (or level) continuously.

- **◀ & ▶ Keys**

Press these keys to select a group of softkeys when the softkeys are displayed.

- **MENU/SET Key**

Press to access MENU.

Secondary use:

Press and hold to enter SETUP Mode.

- **CLR/On Key**

Press to cancel a function or menu selection.

Secondary use:

Press and hold to lock and unlock the keypad.

- **VOL- & VOL+ Keys**

Press these keys to enable the audio volume adjustment.

- **16/S Key**

Pressing this key immediately recalls channel 16 from any channel selection. Press and hold this key to recall the sub channel.

- **POWER Key**

Press and hold this key to turn the radio "ON" or "OFF".

⑥ **MIC/SP Jack**

The jack accepts the optional Speaker/Microphone, VOX Headset, or Earpiece/Microphone. When this jack is used, the internal speaker and microphone are disabled.

⑦ **LCD Display**

This display shows current operating conditions, as illustrated the below image.

- ⑧ **Soft key**
These three soft keys can be customized by the Setup Menu mode described in section “8.12 Soft Keys”. When one of the soft keys is pressed briefly, the functions will appear above each key on the display.
- ⑨ **Microphone**
The internal microphone is located here.
When transmitting, position the microphone about 1/2 to 1 inch (1.2 ~ 2.5 cm) away from your mouth. Speak slowly and clearly into the microphone.
- ⑩ **CHG Jack**
The jack accepts the supplied Type-C USB charger cable.
- ⑪ **Speaker**
The internal speaker is located here.

7.2 LCD INDICATORS

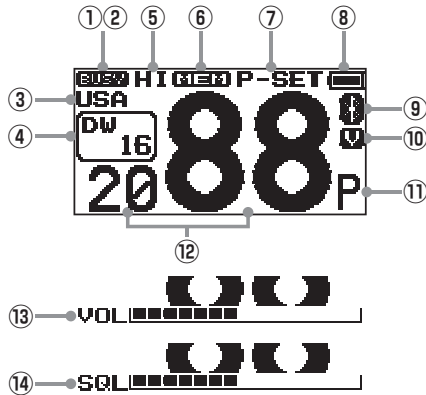

- ① **“TX” Indicator**
This indicator appears during transmission.
- ② **“BUSY” Indicator**
This indicator appears when a signal is being received or the radio is un-squelched.
- ③ **Channel Group Indicator**
These indicators show the selected channel group.
“USA”: USA, “INTL”: International, “CAN”: Canada,
“UK”: United Kingdom (U.K.), “BE”: Belgium, “NL”: Netherlands,
“SW”: Sweden, “GE”: German, “NO”: Norway
- ④ **“DW” Indicator**
DW: Dual Watch is activated.
TW: Tri-Watch is activated.

⑤ **TRANSMIT POWER Indicator**

“HI”: 6 W (5 W)*

“MD”: 2.5 W

“LO”: 1 W

*(5 W TX required in some countries)





⑥ **“MEM” Indicator**

This indicator shows the channel is registered in the transceiver “Scan Memory”.

⑦ **“P-SET” Indicator**

Shown when the channel is programmed into the Preset Channel memory.

⑧ **Battery Indicator**

	: Full battery power
	: Enough battery power
	: Low battery power
	: Poor battery power. Charge battery.
	: Charge the battery immediately

⑨ **“” Bluetooth Indicator**

Shown when the Bluetooth® function is activated.

Appears: Bluetooth® device is connected.

Blinks: Bluetooth® device not connected.

⑩ **“” VOX Indicator**

Shown when the VOX (Voice operated transmission) function is enabled.

⑪ **“P” Indicator**

Shown when the channel is set as the Priority Channel.

“D” Indicator

Shown when the Dual Watch function is enabled in FM radio mode.

“T” Indicator

Shown when the Triple Watch function is enabled in FM radio mode.

⑫ **Channel Display**

The operating channel is shown on the LCD in both the transmit and the receive modes.

⑬ **VOL Indicator**

This indicator shows the receive audio volume level.

⑭ **SQL Indicator**

This indicator shows the squelch setting level.

8. BASIC OPERATION

8.1 PROHIBITED COMMUNICATIONS

The FCC prohibits the following communications:

- False distress or emergency messages.
- Messages to “any boat” except in emergencies and radio tests.
- Messages to or from a vessel on land.
- Transmission while on land.
- Obscene, indecent, or profane language (potential fine of \$10,000).

8.2 INITIAL SETUP

1. To install the antenna onto the transceiver; hold the bottom end of the antenna, then screw it onto the mating connector on the transceiver until it is snug. Do not over-tighten.

8.3 RECEPTION

1. Press and hold the **POWER** key for one second to turn the radio “ON”.
2. Press and hold the [**SQL**] switch until the “**BUSY**” indicator appears on the display. This is the “squelch off” state.
2. Press the [**VOL-**] or [**VOL+**] key until noise or audio from the speaker is heard at a comfortable level.
3. Press the [**SQL**] switch to resume normal (quiet) monitoring.
5. Press the [**▲**] or [**▼**] key to select the desired channel. Refer to the channel chart on page 46 for available channels.
6. When a signal is received, adjust the volume to the desired listening level. The “**BUSY**” indicator on the LCD is displayed indicating that the channel is being used or the radio is not squelched.



8.4 TRANSMISSION

1. Setup the transceiver as described in the “8.3 RECEPTION” discussion above.
2. Before transmitting, monitor the channel and make sure it is clear.

THIS IS AN FCC REQUIREMENT!

3. Press the **PTT** (Push-To-Talk) switch to transmit. During transmission, the “**TX**” indicator will appear on the display.



4. Position the microphone about 1/2 to 1 inch (1.2 ~ 2.5 cm) away from your mouth. Speak slowly and clearly into the microphone.
5. When the transmission is finished, release the **PTT** switch.

8.4.1 TRANSMIT POWER

The TX output power of the **HX320** is set to high level (6 W*) in factory default, and the “**HI**” indicator is displayed on the top part of the screen.

To change the TX output power:

1. Press one of the soft keys.
2. Press the [◀] or [▶] key repeatedly, until [HI], [MD], or [LO] is displayed above a soft key at the bottom of the LCD.
3. Press the [HI], [MD], or [LO] soft key to switch between HI (6 W (5 W)*), MD (2.5 W), or LO (1 W) output power.

*(5 W TX required in Some Countries)



8.4.2 TRANSMIT TIME - OUT TIMER (TOT)

While the **PTT** switch is held down, transmission time is limited to 5 minutes. This prevents prolonged (unintentional) transmissions. About 10 seconds before automatic transmitter shutdown, a warning beep will sound from the speaker. The transceiver automatically switches to receive mode, even if the **PTT** switch continues to be held down. The **PTT** switch must first be released, then wait 10 seconds before transmission may be started again. This Time-Out-Timer (TOT) prevents a continuous transmission that would result from an accidentally stuck **PTT** switch.

WATER ENABLED LIGHT

When the **HX320** comes in contact with water a white light will blink to assist retrieving it in low light conditions. The light will automatically turn off in about 15 seconds when it is removed from water.

The **HX320** has a menu selection to enable and disable. Refer to SETUP Mode Item “STROBE LED (Water Hazard)” on page 39 for details.

8.5 CHANNEL GROUP

Set the Channel Group according to the region.

1. Press and hold the [MENU/SET] key.
2. Press the [▲] or [▼] key to select “CHANNEL SETUP”.
3. Press the [SELECT] soft key.
4. Press the [▲] or [▼] key to select “CHANNEL GROUP”.
5. Press the [SELECT] soft key.
6. Press the [▲] or [▼] key to select the desired channel group “INTERNATIONAL”, “USA”, or “CANADA”*.
*(In the European version, when setting the region, the selected European Channel Group will be displayed instead of “CANADA”. For details, refer to the Note on the Setting the Region on the separate yellow insert sheet.)
7. Press the [ENTER] soft key to store the selected setting.
8. Press the [CLR/On] key to return to radio operation.



8.6 KEYPAD LOCKING

In order to prevent accidental channel change, the HX320's keypad may be locked.

Hold down the [CLR/On] key to lock the keypad (except the PTT, [VOL-], [VOL+] and [CLR/On] keys) so that they are not accidentally changed. “KEY LOCK” will appear on the entire screen, to indicate that the functions are locked.

To unlock the keys, press and hold the [CLR/On] key until “UNLOCK” appears.

8.7 NOAA WEATHER CHANNELS (In USA and Canada only)

1. Press the [MENU/SET] key to display the MENU screen, then press the [WX] soft key. The transceiver changes to the weather channel mode and the radio will be set to the last used NOAA weather channel.
2. Press the [▲] or [▼] key to select a different NOAA weather channel.



3. To exit from the NOAA weather channels, press the [MENU/SET] key to display MENU screen, then press the [CH] soft key. The transceiver will revert to the channel in use prior to switching to the weather channel mode.

8.7.1 NOAA WEATHER ALERT

In the event of extreme weather disturbances, such as storms and hurricanes, the NOAA (National Oceanic and Atmospheric Administration) sends a weather alert accompanied by a 1050 Hz tone and a subsequent weather report on one of the NOAA weather channels.

The **HX320** can respond to weather alerts: when monitoring a weather channel; when stopping on a selected weather channel during scanning modes; while operating on another working channel; or while listening in the FM Radio mode. To enable the weather alert function, refer to section “**10.1.2 WEATHER ALERT (in USA and Canada only)**”.

When an alert is received on a NOAA weather channel, scanning will stop and the transceiver will emit a loud beep to alert the user of a NOAA broadcast. Press any key to stop the alert.



After stopping the beep sound, the weather alert reception confirmation screen will appear. Press any key to display a confirmation screen. The confirmation screen will ask whether to move to the weather channel, or return to the marine channel. Press [YES] to switch to the weather channel, or press [NO] to return to the marine channel.

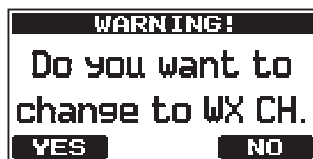

NOTE

If no key is pressed the alert will sound for 5 minutes and then the weather report will be received.



8.7.2 NOAA WEATHER ALERT TESTING

In order to test this system, NOAA broadcasts the 1050 Hz tone every Wednesday sometime between 11 AM and 1 PM local time. You may use this opportunity to test your transceiver periodically to confirm that the Weather Alert feature is working, or for training crew members on how to configure the transceiver to receive the NOAA Weather Alerts.



8.8 PRESET CHANNELS: INSTANT ACCESS

10 preset channels can be programmed for instant access. Press one of the soft keys. Press the [◀] or [▶] key repeatedly, then press the [P-SET] soft key. Pressing the [P-SET] soft key activates the user assigned channel bank. If the [P-SET] soft key is pressed and no preset channels have been assigned, an alert beep will be emitted from the speaker.

8.8.1 PROGRAMMING PRESET CHANNEL BANKS

1. Select the desired channel to be assigned into the Preset Channel Bank using the [▲] or [▼] key.
2. Press one of the soft keys.
3. Press the [◀] or [▶] key repeatedly, until the [P-SET] soft key is displayed at the bottom of the LCD.
4. Press and hold the [P-SET] soft key until the "P-SET" icon and channel number are blinking.
5. Press the [ADD] soft key to program the channel into the preset channel memory. "P-SET" icon will appear.
6. Repeat steps 1 through 5 to program the additional channels into the preset channels. Up to 10 channels can be registered. If you attempt to register an 11th channel, the error beep will sound.

8.8.2 OPERATION on a Preset Channel

1. Press one of the soft keys.
2. Press the [◀] or [▶] key repeatedly, until the [P-SET] soft key is displayed at the bottom of the LCD.
3. Press the [P-SET] soft key, then press the [▲] or [▼] key to select the desired preset channel.

4. To return to the previous operation channel, press one of the soft keys, then press the [P-SET] soft key. The “P-SET” icon will disappear from the display.

8.8.3 Deleting a Preset Channel

1. Press one of the soft keys.
2. Press the [◀] or [▶] key repeatedly, until the [P-SET] soft key is displayed at the bottom of the LCD.



3. Press the [P-SET] soft key, then press the [▲] or [▼] key to select the preset channel to be deleted.



4. Press one of the soft keys, then press and hold the [P-SET] soft key until the “P-SET” icon and channel number are blinking.



5. Press the [DEL] soft key to delete the channel from the preset channel memory.
6. To exit from the preset channels delete operation, press the [BACK] soft key.

8.9 SCANNING

The **HX320** provides two types of scanning, “Memory Scan” or “Priority Scan”. “Memory Scan” scans the channels that were programmed into Scan Memory and also channels stored in the Preset Channel memory. “Priority Scan” is similar to the “Memory Scan” scan, however it scans the priority channel (channel 16) and dual watches to channels programmed in memory scan and preset channel memory. When an incoming signal is detected on one of the channels during scan, the radio will pause on that channel, allowing you to listen to the incoming transmission.

8.9.1 PROGRAMMING SCAN MEMORY

1. Press and hold the **[MENU/SET]** key.
2. Press the **[▲]** or **[▼]** key to select “**CHANNEL SETUP**”.
3. Press the **[SELECT]** soft key, then press the **[▲]** or **[▼]** key to select “**SCAN MEMORY**”.
4. Press the **[SELECT]** soft key.
5. Press the **[▲]** or **[▼]** key to select a desired channel to be scanned, then press the **[MEM]** soft key. The “**ON**” icon will appear at the right side of the selected channel.



6. Repeat step 5 for all the desired channels to be scanned.
7. To REMOVE a channel from the list, select the channel then press the **[MEM]** soft key. The “**ON**” icon of the selected channel will disappear.
8. When the selections are complete, press the **[CLR/On]** key to return to radio operation.

To check channels to be scanned, press the **[▲]** or **[▼]** key repeatedly, to display each channel. The “**MEM**” icon will appear when a designated memory channel is displayed.

8.9.2 SELECTING SCAN TYPE

1. Press and hold the **[MENU/SET]** key.
2. Press the **[▲]** or **[▼]** key to select “**CHANNEL SETUP**”.
3. Press the **[SELECT]** soft key, then select “**SCAN TYPE**” with the **[▲]** or **[▼]** key.
4. Press the **[SELECT]** soft key.
5. Press the **[▲]** or **[▼]** key to select “**M-SCAN**” (Memory Scan) or “**P-SCAN**” (Priority Scan). The default setting is “**M-SCAN**”.

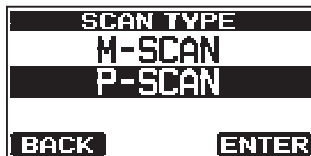

6. Press the **[ENTER]** soft key to store the selected setting.
7. Press the **[CLR/On]** key to return to radio operation.

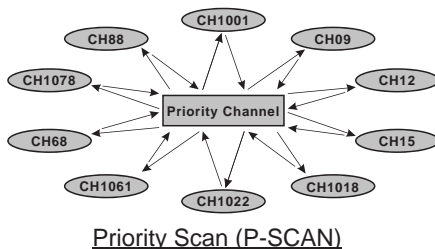
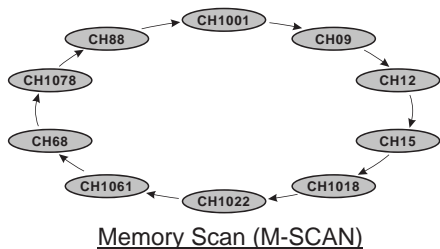

8.9.3 SCANNING OPERATION

Memory Scanning (M-SCAN)

1. Set the scan type to “M-SCAN” in the SETUP menu (refer to “8.9.2 SELECTING SCAN TYPE”).
2. Press the [SQL] switch, then press the [▲] or [▼] key until the squelch background noise disappears.
3. Press one of the soft keys.
4. Press the [◀] or [▶] key repeatedly, until the [SCAN] soft key is displayed at the bottom of the LCD.
5. Press the [SCAN] soft key. “MEM SCAN” will appear on the display. Scanning will proceed from the lowest to the highest programmed channel number and preset channel (described in the next section). Scanning will stop on a channel when a transmission is received.
The channel number will blink during reception.
6. To stop scanning, press the [16/S] or [CLR/On] key.



Priority Scanning (P-SCAN)

1. Set the scan type to “P-SCAN” in the SETUP menu (refer to “8.9.2 SELECTING SCAN TYPE”).
2. Press the [SQL] switch, then press the [▲] or [▼] key until the squelch background noise disappears.
3. Press one of the soft keys.
4. Press the [◀] or [▶] key repeatedly, until the [SCAN] soft key is displayed at the bottom of the LCD.
5. Press the [SCAN] soft key. “PRI SCAN” appears on the display. Scanning will proceed between memory channels, the preset channels, and the priority channel.
The priority channel will be scanned after each programmed channel.
6. To stop scanning, press the [16/S] or [CLR/On] key.

8.10 MULTI WATCH (TO PRIORITY CHANNEL)

Multi watch is used to scan two or three channels for communications.

- In Dual Watch, a normal VHF channel (or an FM broadcast frequency*), and the priority channel, are scanned alternately.
- In Triple Watch, a normal VHF channel (or an FM broadcast frequency*), the priority channel, and the sub channel are scanned sequentially.

*(Start the Dual Watch function or the Triple Watch function, then start receiving the FM broadcast radio. (Refer to section “**8.11 Listening to the FM Broadcast Radio**”.) The “**D**” or “**T**” icon will appear on the FM radio reception screen.)

When a signal is received on the normal channel the radio briefly switches between the normal channel and the priority channel to look for a transmission. If the radio receives communications on the priority channel the radio stops and listens to the priority channel until communication ends and then starts dual or triple watch scan again.

NOTE

The priority channel and sub channel may be changed from CH16 (default) and CH9 (default) to other channels. Refer to section “**PRIORITY CH**” or “**SUB CH**” (see page 35 for details).

8.10.1 Setting up the Multi Watch Operation

1. Press and hold the [MENU/SET] key.
2. Press the [▲] or [▼] key to select “CHANNEL SETUP”.
3. Press the [SELECT] soft key, then select “MULTI WATCH” with the [▲] or [▼] key.
4. Press the [SELECT] soft key.
5. Press the [▲] or [▼] key to select “DUAL” or “TRIPLE” (“DUAL” is default).

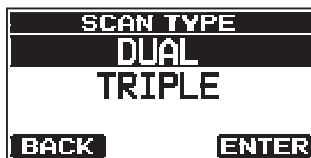

DUAL (Dual Watch): The **HX320** watches the activity of the current channel and the priority channel.

TRIPLE (Triple Watch): The **HX320** watches the activity of the priority channel, the sub channel, and the current channel.

6. Press the [ENTER] soft key to store the selected setting.
7. Press the [CLR/On] key to return to radio operation.

8.10.2 Starting the Dual Watch

1. Press the [SQL] switch, then press the [▲] or [▼] key until the background squelch noise disappears.
2. Press the [▲] or [▼] key to select a channel you wish to dual watch.

3. Press one of the soft keys.
4. Press the [◀] or [▶] key repeatedly, until the [DW] soft key is displayed at the bottom of the LCD.
5. Press the [DW] soft key. The radio will monitor the priority channel and the working channel that were selected in step 2.



6. While a signal is received on the channel selected in step 2, the **HX320** will dual watch to the priority channel periodically.
7. To stop dual watch, press the [CLR/On] key.

8.10.3 Starting the Triple Watch

You may change the Dual Watch feature to Triple Watch via the Menu ("Set") Mode. Triple Watch scans the priority channel, the sub channel, and one working channel.

1. Press the [▲] or [▼] key to select the working channel to scan along with the sub channel and the priority channel.
2. Press one of the soft keys.
3. Press the [◀] or [▶] key repeatedly, until the [TW] soft key is displayed at the bottom of the LCD.
4. Press the [TW] soft key to activate the Triple Watch feature.



5. When a transmission is received on the priority channel, the **HX320** will remain on the priority channel until the incoming signal disappears.
6. When a transmission is received on the sub channel, the **HX320** will Dual watch the priority channel and the sub channel.
7. When the **HX320** receives a transmission on the working channel, the **HX320** will Triple Watch between the working channel, the priority channel, and sub channel.
8. To stop Triple watch, press the [CLR/On] key.

8.11 Listening to the FM Broadcast Radio

The **HX320** includes provision for FM broadcast reception.

1. Press the **[MENU/SET]** key to display MENU screen, then press the “**RADIO**” soft key.

The FM broadcast coverage is 65.000 to 108.000 MHz (100 kHz step) and utilizes Wide-FM mode.



2. Press the **[▲]** or **[▼]** key to select the desired frequency.



3. To exit from the FM Broadcast Reception mode, press the **[MENU/SET]** key to display the MENU screen, then press the **[CH]** soft key. The transceiver will revert to the channel in use prior to switching to the FM Broadcast band.

8.11.1 FM broadcast Frequency sweep operation

1. Recall the FM Broadcast Reception mode (see above).
2. Press the **[SWEEP]** soft key to start sweep operation. Sweeping will proceed from the lowest to the highest frequencies (step 100 kHz). If the radio receives an FM station, the sweep will stop on the received frequency.
3. To cancel sweep operation, press the **[▲]** or **[▼]** key.

8.11.2 Store the FM frequency

1. While listening in the FM Broadcast receive mode, select the desired FM frequency.
2. Press the **[MEM]** soft key to display the “**ADD**” screen.
3. Press the **[SELECT]** soft key.
4. Press the **[▲]** or **[▼]** key to scroll through the letters and choose the first letter of the name for the FM frequency.
5. Press the **[SELECT]** soft key to store the first letter of the name and step to the next letter to the right.
6. Repeat steps 4 and 5 until the name is complete. The name can consist of up to twelve characters, and if you do not use all twelve characters, press the **[▶]** key to move to the next spaces. This method can also be used to enter a blank space within the name.



If a mistake was made entering in the name, press the **[◀]** or **[▶]** soft key until the wrong character is selected, then perform steps 4 and 5.

- When the twelve letters or spaces have been entered, select “**FINISH**”. Press the [ENTER] soft key to store the FM frequency. To return the input, press the [◀] or [▶] key.



8.11.3 Memory Frequency Recall

- Press the [NEXT] soft key to recall the Last displayed FM broadcast memory.
- Then press the [NEXT] soft key repeatedly to step sequentially through the FM broadcast memories.

8.12 Soft Keys

The soft key functions may be reconfigured, and the duration time of the soft key icon display, after a key is pressed, can be changed.

8.12.1 Key Assignment

- Press and hold the [MENU/SET] key.
- Press the [▲] or [▼] key to select “**CONFIG**”, then press the [SELECT] soft key.
- Select “**KEY SETUP**” with the [▲] or [▼] key, then press the [SELECT] soft key.
- Select “**ASSIGNMENT**” with the [▲] or [▼] key, then press the [SELECT] soft key.
- Press the [▲] or [▼] key to select the key number to be programmed, and press the [ENTER] soft key.
- Press the [▲] or [▼] key to select a new function to be assigned to the soft key, and press the [ENTER] soft key. Available functions are listed below.



- Press the [CLR/On] key to return to radio operation.

Display	Function
PRESET	Programs or deletes the preset memory channel.
HI/MD/LO	Selects transmit power.
DW/TW	Turns dual or triple watch scan ON/OFF.
MEMORY	Add or remove channels from memory channel scan.
SCAN	Turns the scanning function ON/OFF.
STROBE	Turns on or off the strobe light LED.

8.12.2 Key Timer

1. Press and hold the [MENU/SET] key.
2. Press the [▲] or [▼] key to select “**CONFIG**”, then press the [SELECT] soft key.
3. Select “**KEY SETUP**” with the [▲] or [▼] key, then press the [SELECT] soft key.
4. Select “**KEY TIMER**” with the [▲] or [▼] key, then press the [SELECT] soft key.
5. Press the [▲] or [▼] key to select the desired time, and press the [ENTER] soft key (“5 sec” is default).
6. Press the [CLR/On] key to return to radio operation.



9. ADVANCED OPERATION

9.1 Bluetooth® Operation

The **HX320** has built-in Bluetooth® functionality. Hands-free operation is possible using the optional Bluetooth® headset (SSM-BT10) or a commercially available Bluetooth® headset.

NOTE: The operation of all commercially available Bluetooth® headsets cannot be guaranteed.

9.1.1 Pairing the Bluetooth® Headset

When using the Bluetooth® Headset for the first time, the Bluetooth® Headset and the **HX320** must be paired.

This step is only necessary when first connecting the headset.

1. To start the Bluetooth® headset in pairing mode.

SSM-BT10: Press and hold the Multi Function Button, until the SSM-BT10 LED blinks red/blue alternately.

Press and hold the Multi Function Button to turn ON.



2. Press and hold the **[MENU/SET]** key.
3. Press the **[▲]** or **[▼]** key to select “**BLUETOOTH**”, then press the **[SELECT]** key.
4. Press the **[SELECT]** key again.
5. Select “**ON**” with the **[▲]** or **[▼]** key, then press the **[ENTER]** soft key.



6. Select “**NEW**” with the **[▲]** or **[▼]** key, then press the **[SELECT]** soft key.



7. Press the **[SEARCH]** soft key.
The search begins and the model name of the found Bluetooth® device is displayed in the list.



- Press the [▲] or [▼] key to select the desired Bluetooth® Headset, then press the [ENTER] soft key.
Pairing will start.



- When pairing is complete, “Connected...” is displayed.
- The LED on the SSM-BT10 blinks blue.



- Press the [OK] soft key, then press the [CLR/Off] key to return to radio operation.
While connected to a Bluetooth® headset, the “” icon appears on the **HX320** screen, and the received audio and operation beep will be heard from the Bluetooth® headset.

● Bluetooth® headset volume control

Adjust the volume of the Bluetooth® headset with either the [VOL-] / [VOL+] button on the **HX320** or the volume control operation of the Bluetooth® headset.

● Disable the Bluetooth® function

To cancel Bluetooth® operation, just repeat the above procedures, selecting “OFF” in step 5 above.

● Subsequent Bluetooth® headset connection when the power is turned ON

- When the power is turned OFF while the Bluetooth® headset is connected, the next time the power is turned ON, the same Bluetooth® headset is searched for and automatically connected when found.
- If the Bluetooth® headset cannot be found, the “” icon flashes on the screen. If the power of the same Bluetooth® headset is turned ON in this state, it will connect automatically. If not, turn the HX320 and Bluetooth® headset OFF and then ON again.
- To connect to other Bluetooth® headsets, refer to the “Connect to another paired Bluetooth® headset”.

9.1.2 Transmit operation by pressing the button on the Bluetooth® headset

Pressing the “Call button”* on the Bluetooth® headset once will keep the HX320 in transmit and a call can be made using the Bluetooth® headset.

Press the “Call button”* again to return the HX320 to receive.

*The button name may differ depending on your Bluetooth® headset.

SSM-BT10: When the Multi Function Key is pressed, a beep will sound and the HX320 will continuously transmit. Press the Multi Function Key again, a beep will sound and the HX320 will return to receive mode.

Press briefly to transmit



9.1.3 Hands-free VOX operation with a Bluetooth® headset

When HX320 VOX (Voice operated transmission) function is turned ON, the Bluetooth® headset can perform hands-free operation and transmit automatically just by talking.

Turn the VOX function ON according to “9.2 VOX Operation”.

9.1.4 Connect to another paired Bluetooth® headset

NOTE: When the HX320 is already connected to a Bluetooth® headset, the connection cannot be changed to another headset. First turn **OFF** the currently connected headset, then try connecting to another headset.

1. Press and hold the [MENU/SET] key to display the SETUP menu screen.
2. Select “**BLUETOOTH**” by pressing the [▲] or [▼] key, and then press the [SELECT] soft key.
3. Select “**DEVICE**” by pressing the [▲] or [▼] key, and then press the [SELECT] soft key.
4. Select “**CONNECT**” by pressing the [▲] or [▼] key, and then press the [SELECT] soft key.
The device list will be displayed.



5. Press the [▲] / [▼] keys, to select the Bluetooth® headset to be connected from the list.
When connecting is complete, “Connected...” is displayed.

A check mark “**✓**” is displayed at the beginning of the row of connected Bluetooth® headsets.



● **Remove all registered (paired) Bluetooth® devices from the list**

1. Select “**DELETE ALL**” on the screen by pressing the [▲] or [▼] key in step 4 above, then press the [ENTER] soft key.
2. Select “**OK?**” on the screen by pressing the [▲] or [▼] key, and then press the [ENTER] soft key to remove all paired Bluetooth Headsets from the list.

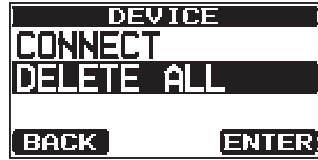

● **Adjust the sensitivity of the Bluetooth® microphone**

NOTE: This feature is only available if the connected Bluetooth® headset supports it. The optional SSM-BT10 does not support this function.

1. Press and hold the [MENU/SET] key to display the SETUP menu screen.
2. Select “**BLUETOOTH**” on the screen by pressing the [▲] or [▼] key, and then press the [ENTER] soft key.
3. Select “**MIC SENSE**” on the screen by pressing the [▲] or [▼] key, and then press the [ENTER] soft key (“3” is default).
4. Select Microphone Sensitivity by pressing the [▲] or [▼] key, and then press the [ENTER] soft key.

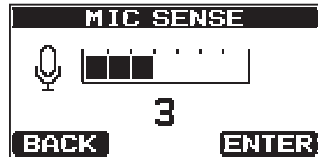

9.2 VOX Operation

If you want to have both hands free, use a headset and activate the VOX (Voice operated transmission) function.

NOTES:

- The VOX function is not active when using only the internal microphone; a Bluetooth® headset or an external headset must be used.
- Do not activate the VOX system when connecting the optional VOX Headset **SSM-64A**.

- ❑ To activate the VOX system, select “**ON**” on the item “**VOX**” of the CHANNEL SETUP menu.

The “” icon, which indicates that the VOX system is active, will appear at the right side of the channel frequency when the display returns to the radio operation screen.

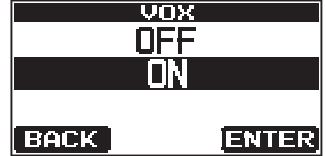

- ❑ To adjust the VOX gain, select one of the following gain levels on the item “**VOX LEVEL**” of the CHANNEL SETUP menu (“2” is default).



- ❑ To set the VOX delay, select one of the following times on the item “**VOX DELAY**” of the CHANNEL SETUP menu (“2.0 sec” is default).

0.5sec / 1.0sec / 1.5sec / 2.0sec / 3.0sec



10. MENU (“SETUP”)

The **HX320**’s Menu Mode allows enables a number of the **HX320** operating parameters to be custom-configured.

Use the following procedure to activate and set The Menu Mode parameters:

1. Press and hold the **[MENU/SET]** key.
2. Press the **[▲]** or **[▼]** key to select the desired menu item, then press the **[SELECT]** soft key.
3. Press the **[▲]** or **[▼]** key to select the desired menu item, then press the **[SELECT]** soft key.
4. Press the **[▲]** or **[▼]** key to select the desired setting.
5. Press the **[ENTER]** soft key to store the selected setting.
6. Press the **[CLR/On]** key to return to radio operation.

10.1 CHANNEL SETUP

10.1.1 CHANNEL GROUP

This menu item enables changing the channel group from International channels, to USA channels, or Canada channels.

Refer to the section “**8.5 CHANNEL GROUP**” for details.

10.1.2 WEATHER ALERT (in USA and Canada only)

Enables/disables the NOAA Weather Alert function. The default setting is “OFF”.

1. Press and hold the **[MENU/SET]** key.
2. Press the **[▲]** or **[▼]** key to select “**CHANNEL SETUP**”, then press the **[SELECT]** soft key.
3. Select “**WEATHER ALERT**” with the **[▲]** or **[▼]** key, then press the **[SELECT]** soft key.
4. Press the **[▲]** or **[▼]** key to select “ON” or “OFF” (“OFF” is default).
5. Press the **[ENTER]** soft key to store the new setting.
6. Press the **[CLR/On]** key to return to radio operation.



10.1.3 SCAN MEMORY

Before scanning can begin, the desired scan channels must be programmed. This selection allows channels to be stored to the scan memory.

Refer to the section “**8.9.1 PROGRAMMING SCAN MEMORY**” for details.

10.1.4 SCAN TYPE

This selection is used to change the scan mode between “M-SCAN” (Memory Scan) and “P-SCAN” (Priority Scan). The default setting is “P-SCAN”.

Refer to section “**8.9.2 SELECTING SCAN TYPE**” for details.

10.1.5 SCAN RESUME

This selection is used to select the time the **HX320** waits after a transmission ends before the radio starts to scan channels again. The default setting is 2 seconds.

1. Press and hold the **[MENU/SET]** key.
2. Press the **[▲]** or **[▼]** key to select “**CHANNEL SETUP**”, then press the **[SELECT]** soft key.
3. Select “**SCAN RESUME**” with the **[▲]** or **[▼]** key, then press the **[SELECT]** soft key.
4. Press the **[▲]** or **[▼]** key to select the desired time. The resume time can be set to “1 sec” through “5 sec” (“2 sec” is default).
5. Press the **[ENTER]** soft key to store the new setting.



6. Press the **[CLR/Off]** key to return to radio operation.

10.1.6 MULTI WATCH

This selection is used to choose between “Dual Watch” and “Triple Watch”.

Refer to section “**8.10.1 Setting up the Multi Watch Operation**” for details.

10.1.7 PRIORITY CH

This procedure may be used to designate a different priority channel when priority scanning. By default, the radio priority channel is set to Channel 16.

1. Press and hold the **[MENU/SET]** key.
2. Press the **[▲]** or **[▼]** key to select “**CHANNEL SETUP**”, then press the **[SELECT]** soft key.
3. Select “**PRIORITY CH**” with the **[▲]** or **[▼]** key, then press the **[SELECT]** soft key.
4. Press the **[▲]** or **[▼]** key to select the desired channel to be a priority (“CH:16” is default).
5. Press the **[ENTER]** soft key to store the new setting.

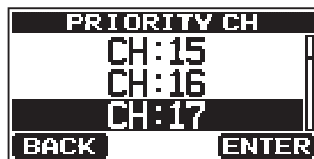

6. Press the **[CLR/Off]** key to return to radio operation.

10.1.8 SUB CH

By default, the sub channel is set to Channel 9. This procedure allows the radio to assign a different sub channel for instant access.

1. Press and hold the **[MENU/SET]** key.
2. Press the **[▲]** or **[▼]** key to select “**CHANNEL SETUP**”, then press the **[SELECT]** soft key.
3. Select “**SUB CH**” with the **[▲]** or **[▼]** key, then press the **[SELECT]** soft key.
4. Press the **[▲]** or **[▼]** key to select the desired channel to be the sub channel (“CH:09” is default).
5. Press the **[ENTER]** soft key to store the new setting.
6. Press the **[CLR/On]** key to return to radio operation.



10.1.9 VOX

Refer to section “9.2 VOX Operation” for details.

10.2 FM SETUP

10.2.1 ADD

1. Press and hold the **[MENU/SET]** key.
2. Press the **[▲]** or **[▼]** key to select “**FM SETUP**”, then press the **[SELECT]** soft key.
3. Press the **[▲]** or **[▼]** key to select “**ADD**”, then press the **[SELECT]** soft key.
4. Press the **[▲]** or **[▼]** key to select “**FREQ**”, then press the **[SELECT]** soft key.
5. Press the **[▲]** or **[▼]** key to scroll through the first position numbers of the frequency.
6. Press the **[SELECT]** soft key to store the first number in the frequency and step to the next position to the right.
7. Repeat steps 5 and 6 until the frequency is complete.
If a mistake was made entering in the frequency, press the **[◀]** or **[▶]** soft key until the wrong entry is selected, then perform steps 5 and 6.
8. After the four numbers have been entered, press the **[SELECT]** soft key, then press the **[ENTER]** soft key to save and exit to the “ADD” screen.
9. Press the **[▼]** key to select “**NAME**”, then press the **[SELECT]** soft key.
10. Press the **[▲]** or **[▼]** key to scroll through the first letter of the name of the frequency.
11. Press the **[SELECT]** soft key to store the first letter in the name and step to the next position to the right.



12. Repeat steps 10 and 11 until the name is complete. The name can consist of up to twelve characters. If you do not use all twelve characters, press the [▶] key to move to the next space. This method can also be used to enter a blank space in the name.

If a mistake was made entering in the name, press the [◀] or [▶] soft key until the wrong character is selected, then perform steps 10 and 11.

13. After the twelve letters or spaces have been entered, press the [SELECT] soft key, then press the [ENTER] soft key to save and exit to radio operation.

10.2.2 EDIT

This selection is used to edit the FM Broadcast frequency and name.

1. Press and hold the [MENU/SET] key.
2. Press the [▲] or [▼] key to select “FM SETUP”, then press the [SELECT] soft key.
3. Press the [▲] or [▼] key to select “EDIT”, then press the [SELECT] soft key.
4. Press the [▲] or [▼] key to select the memory to be edited, then press the [ENTER] soft key.



5. Use the same procedure as described in steps 4 to 13 of “ADD” in the previous section.

10.2.3 DELETE

This selection can delete the frequency data stored on an FM Broadcast memory.

1. Press and hold the [MENU/SET] key.
2. Press the [▲] or [▼] key to select “FM SETUP”, then press the [SELECT] soft key.
3. Press the [▲] or [▼] key to select “DELETE”, then press the [SELECT] soft key.
4. Press the [▲] or [▼] key to select the memory to be deleted, then press the [ENTER] soft key.

The delete confirmation screen will appear.



5. Press the [▲] or [▼] key to select “OK?” (delete) or “CANCEL” (cancel), then press the [ENTER] soft key.

10.3 BLUETOOTH

Refer to section “9.1 Bluetooth® Operation” for details.

10.4 ATIS SETUP (HX320E only)

Refer to section “11. ATIS SETUP (HX320E only)” for details.

10.5 CONFIG

10.5.1 KEY BEEP

This selection is used to select the beep tone volume level when a key is pressed.

1. Press and hold the [MENU/SET] key.
2. Press the [▲] or [▼] key to select “CONFIG”, then press the [SELECT] soft key.
3. Select “KEY BEEP” with the [▲] or [▼] key, then press the [SELECT] soft key.
4. Press the [▲] or [▼] key to select the desired level. The beep level can be set from “1” to “5”, or “OFF” (“3” is default).
5. Press the [ENTER] soft key to store the selected level.

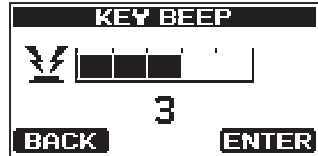

6. Press the [CLR/On] key to return to radio operation.

10.5.2 BATTERY SAVE

This function allows you to change the battery save mode setting.

1. Press and hold the [MENU/SET] key.
2. Press the [▲] or [▼] key to select “CONFIG”, then press the [SELECT] soft key.
3. Select “BATTERY SAVE” with the [▲] or [▼] key, then press the [SELECT] soft key.
4. Press the [▲] or [▼] key to select the desired setting. You can select one from “OFF”, “50%”, “70%”, “80%”, or “90%” (“50%” is default).
5. Press the [ENTER] soft key to store the selected setting.



6. Press the [CLR/On] key to return to radio operation.

10.5.3 STROBE LED

This selection is used to switch and set the function of the strobe LED.

Emergency

1. Press and hold the [MENU/SET] key.
2. Press the [▲] or [▼] key to select “**CONFIG**”, then press the [SELECT] soft key.
3. Select “**STROBE LED**” with the [▲] or [▼] key, then press the [SELECT] soft key.
4. Select “**EMERGENCY**” with the [▲] or [▼] key, then press the [SELECT] soft key.
5. Press the [▲] or [▼] key to select the desired setting. You can select one from “CONTINUOUS”, “SOS”, “BLINK 1”, “BLINK 2”, or “BLINK 3” (“CONTINUOUS” is default).
6. Press the [ENTER] soft key to store the selected setting.
7. Press the [CLR/Off] key to return to radio operation.



Water Hazard

1. Press and hold the [MENU/SET] key.
2. Press the [▲] or [▼] key to select “**CONFIG**”, then press the [SELECT] soft key.
3. Select “**STROBE LED**” with the [▲] or [▼] key, then press the [SELECT] soft key.
4. Select “**WATER HAZARD**” with the [▲] or [▼] key, then press the [SELECT] soft key.
5. Press the [▲] or [▼] key to select the desired setting. You can select one from “OFF”, “ON”, or “ON/PWR ON” (“ON/PWR ON” is default).
OFF: The LED does not light up.
ON: The LED lights up.
ON/PWR ON: The LED lights up and the transceiver turns on even if the transceiver is OFF.
6. Press the [ENTER] soft key to store the selected level.
7. Press the [CLR/Off] key to return to radio operation.



10.5.4 KEY SETUP

The function assigned to the function screen Soft Keys can be changed (see page 27 “8.12 Soft Keys”).

10.5.5 BACKLIT LEVEL

The backlight brightness may be adjusted in 5 levels.

1. Press and hold the **[MENU/SET]** key.
2. Press the **[▲]** or **[▼]** key to select "**CONFIG**", then press the **[SELECT]** soft key.
3. Select "**BACKLIT LEVEL**" with the **[▲]** or **[▼]** key, then press the **[SELECT]** soft key.
4. Press the **[▲]** or **[▼]** key to select the desired setting, from "1" to "5", or "OFF" ("5" is default).
5. Press the **[ENTER]** soft key to store the selected level.

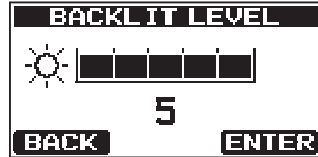

6. Press the **[CLR/On]** key to return to radio operation.

10.5.6 BACKLIT TIMER

This menu selection is used to setup the illumination time of the display and keypad.

1. Press and hold the **[MENU/SET]** key.
2. Press the **[▲]** or **[▼]** key to select "**CONFIG**", then press the **[SELECT]** soft key.
3. Select "**BACKLIT TIMER**" with the **[▲]** or **[▼]** key, then press the **[SELECT]** soft key.
4. Press the **[▲]** or **[▼]** key to select the desired time ("5 sec" is default).

OFF: Disables the display/keypad lamp illumination.

3/5/10/30 Sec: Illuminates the display/keypad for the selected time when any key (except the PTT switch) is pressed.

CONTINUOUS: Illuminates the display/keypad continuously.

5. Press the **[ENTER]** soft key to store the selected level.
6. Press the **[CLR/On]** key to return to radio operation.



10.5.7 CONTRAST

The contrast may be adjusted in 30 levels.

1. Press and hold the **[MENU/SET]** key.
2. Press the **[▲]** or **[▼]** key to select "**CONFIG**", then press the **[SELECT]** soft key.
3. Select "**CONTRAST**" with the **[▲]** or **[▼]** key, then press the **[SELECT]** soft key.

- Press the [**▲**] or [**▼**] key to select the desired level. The contrast level can be set from “1” to “30” (“15” is default).
- Press the [**ENTER**] soft key to store the selected level.



- Press the [**CLR/On**] key to return to radio operation.

10.5.8 RESET

The memories and settings of each setup category may be initialized independently, or the transceiver may be reset to the original factory settings.

- Press and hold the [**MENU/SET**] key.
- Press the [**▲**] or [**▼**] key to select “**CONFIG**”, then press the [**SELECT**] soft key.
- Select “**RESET**” with the [**▲**] or [**▼**] key, then press the [**SELECT**] soft key.
- Press the [**▲**] or [**▼**] key to select the desired category from: “**CHANNEL**”, “**CONFIG**”, or “**ALL**” (all settings except the ATIS will be initialized).
- Press the [**SELECT**] soft key.
- Press the [**▲**] or [**▼**] key to select “**OK?**”, then press the [**ENTER**] soft key.



10.6 ABOUT...

Displays the version of the software currently operating on the transceiver.

10.7 Tables of Setup Menu Operations

Item	Description	Selectable options (Options in bold are the default settings)
CHANNEL SETUP		
CHANNEL GROUP	Selects the channel group	USA: USA version INTERNATIONAL: Europe version
WEATHER ALERT	Turns the Weather Alert function ON or OFF	OFF / ON
SCAN MEMORY	Add or remove a Scan Memory channel	-
SCAN TYPE	Select priority scan or memory scan	M-SCAN (Memory Scan)/ P-SCAN (Priority Scan)
SCAN RESUME	Sets the scanning resume time	1 sec / 2 sec / 3 sec / 4 sec / 5 sec
MULTI WATCH	Selects Dual Watch or Triple Watch	DUAL / TRIPLE
PRIORITY CH	Selects a priority channel	CH:16
SUB CH	Selects a Sub Channel	CH:09
VOX	Turn on or off the VOX function	OFF / ON
VOX LEVEL	Selects the VOX gain	1 / 2 / 3 / 4 / 5
VOX DELAY	Selects the VOX delay time	0.5 sec / 1.0 sec / 1.5 sec / 2.0 sec / 2.5 sec / 3.0 sec
FM SETUP		
ADD	Store the FM frequency	-
EDIT	Edit the FM frequency	-
DELETE	Remove the FM frequency	-

BLUETOOTH		
BLUETOOTH	Turn on or off the Bluetooth function	OFF / ON
DEVICE		
CONNECT	Connects to Bluetooth device on list	-
DELETE ALL	Remove all Bluetooth device list	-
NEW	Searches the Bluetooth device	-
MIC SENSE	Selects the Bluetooth device microphone gain	1 / 2 / 3 / 4 / 5 / 6 / 7
ATIS SETUP (HX320E only)		
ATIS CODE	Sets ATIS code	-
ATIS GROUP	Sets ATIS group	USA / INTERNATIONAL / CANADA* *(Depends on the region settings)
CONFIG		
KEY BEEP	Adjusts the volume of beep tone when a key is pressed	OFF / 1 / 2 / 3 / 4 / 5
BATTERY SAVE	Selects the battery save mode	OFF / 50% / 70% / 80% / 90%
STROBE LED		
EMERGENCY	Sets the operation of the EMERGENCY LED	CONTINUOUS / SOS / BLINKS 1 / BLINKS 2 / BLINKS 3
WATER HAZARD	Sets the operation of the WATER HAZARD LED	OFF/ ON / ON/PWR ON
KEY SETUP		
ASSIGNMENT	Sets the assignment of the soft keys	1:PRESET, 2: HI/MD/LO, 3:DW/TW, 4:MEMORY, 5:SCAN. 6:STROBE
KEY TIMER	Sets the display time of the soft keys	3 sec / 5 sec / 7 sec / 10 sec / 15 sec
BACKLIT LEVEL	Sets the illumination level of the LCD and keypad backlights	OFF / 1 / 2 / 3 / 4 / 5
BACKLIT TIMER	Selects the illumination time of the LCD and keypad backlights	OFF / 3 sec / 5 sec / 10 sec / 30 sec / CONTINUOUS
CONTRAST	Adjusts the contrast of the LCD	1 - 15 - 30
RESET		
CHANNEL	Initializes the memories	-
CONFIG	Initializes the settings	-
ALL	Initializes the memories and settings	-

11. ATIS SETUP (HX320E only)

The **HX320E** supports the ATIS (Automatic Transmitter Identification System) used in Inland waterways in Europe. When enabled ATIS mode transmits a unique ATIS code each time the PTT switch is released at the end of a transmission.

Users should check with their local marine regulatory authority in their country for assistance in obtaining an ATIS code.

WARNING

The ATIS code can be inputted only once, please be careful not to input the incorrect ATIS code. If you need to change the ATIS code after it has been entered, the radio will have to be returned to Factory Service. Refer to the section “**12.2 FACTORY SERVICE**”.

11.1 ATIS CODE PROGRAMMING

1. Press and hold the [MENU/SET] key to display “MENU”.
2. Press the [▲] or [▼] key to select “ATIS SETUP”, then press the [SELECT] soft key.
3. Press the [▲] or [▼] key to select “ATIS CODE”, then press the [SELECT] soft key.
4. Press the [▲] or [▼] key to select the first number of your ATIS, then press the [SELECT] soft key to step to the next number.
5. Repeat step 4 to set your ATIS (ten digits).
6. If a mistake was made entering in the ATIS, press the [DEL] soft key until the wrong number is deleted, then perform step 4.
7. When finished programming the number, press the [ENTER] soft key.
8. The Radio will ask you to input the ATIS number again. Perform steps 4 through 6 above.
9. After the second number has been input, press the [ENTER] soft key to store the ATIS number in memory.
10. Press the [OK] soft key to return to radio operation.



11.2 ATIS CH GROUP

The **HX320E** has the capability to turn on and off the ATIS feature for each channel group.

1. Press and hold the **[MENU/SET]** key to display "MENU".
2. Press the **[▲]** or **[▼]** key to select "**ATIS SETUP**", then press the **[SELECT]** soft key.
3. Press the **[▲]** or **[▼]** key to select "**ATIS GROUP**", then press the **[SELECT]** soft key.
4. Press the **[▲]** or **[▼]** key to select the channel group (INTERNATIONAL, CANADA*, or USA) you wish to change the setting, and press the **[ENTER]** soft key.
*(When setting the region, the selected European Channel Group will be displayed instead of "CANADA". For details, refer to the Note on Setting the Region on the separate yellow insert sheet.)
5. Press the **[▲]** or **[▼]** key to select "ON" or "OFF".
6. Press the **[ENTER]** soft key to save the new setting.
7. If you want to set the ATIS feature to another channel group, repeat step 4 through 6.
8. Press the **[CLR/On]** key to return to radio operation.



12. MAINTENANCE

12.1 GENERAL

The inherent quality of the solid-state components in STANDARD HORIZON radios will provide many years of continuous use. Take the following precautions to prevent damage to the radio:

- Never key the microphone unless an antenna or suitable dummy load is connected to the transceiver.
- Use only STANDARD HORIZON-approved accessories and replacement parts.

12.2 FACTORY SERVICE

In the unlikely event that the radio fails to perform or needs servicing, please contact one of the following:

In USA and Canada

Standard Horizon
Attention Marine Repair Department
6125 Phyllis Drive, Cypress, California 90630, U.S.A.
Telephone (800) 366-4566

In Europe

Yaesu (UK) Ltd
Unit 12, Sun Valley Business Park, Winnall Close
Winchester, Hampshire, SO23 0LB, U.K.
Telephone +44 (0)1962 866667

In Other Countries

Contact the dealer or the distributor.

12.3 TROUBLESHOOTING CHART

SYMPTOM	PROBABLE CAUSE	REMEDY
The USA/INTL/CAN modes do not function.	Proper operation not followed.	Specify the item number from "SET-UP MENU" – "CHANNEL SETUP" – "CHANNEL GROUP".
Cannot output sound by pressing and holding the SQL key.	Low battery.	Charge battery. Refer to section 6.1 of this manual.
	Audio volume level is too low.	Press the [VOL+] key until background noise outputs.
Charge indicator does not appear on the display when charging a battery.	Defective built-in battery.	Contact Standard Horizon dealer.
	The transceiver is not set onto the Charger Cradle properly.	Set the transceiver onto the Charger Cradle properly.
	Power is not supplied to the Charger Cradle.	Connect USB AC Adapter to the Charger Cradle for AC/DC power supplies.
Cannot turn the transceiver OFF . The transceiver is unresponsive to keypad operation.	The Micro Computer has frozen.	Press and hold the POWER switch for over 15 seconds to restart the transceiver.

13. VHF MARINE CHANNEL ASSIGNMENTS

13.1 HX320 (USA Version)

VHF MARINE CHANNEL CHART							
CH	U	C	I	S/D	TX	RX	CHANNEL USE
01		X	X	D	156.050	160.650	Public Correspondence (Marine Operator)
1001	X			S	156.050		Port Operation and Commercial. VTS in selected areas
02		X	X	D	156.100	160.700	Public Correspondence (Marine Operator)
03		X	X	D	156.150	160.750	Public Correspondence (Marine Operator)
1003	X			S	156.150		U.S. Government Only, Coast Guard
04			X	D	156.200	160.800	Public Correspondence (Marine Operator), Port operation, ship movement
1004		X		S	156.200		Pacific coast: Coast Guard, East Coast: Commercial fishing
05			X	D	156.250	160.850	Public Correspondence (Marine Operator), Port operation, ship movement
1005	X	X		S	156.250		Port operation. VTS in Seattle
06	X	X	X	S	156.300		Inter-ship Safety
07			X	D	156.350	160.950	Public Correspondence (Marine Operator), Port operation, ship movement
1007	X	X		S	156.350		Commercial
08	X	X	X	S	156.400		Commercial (Inter-ship only)
09	X	X	X	S	156.450		Boater Calling channel, Commercial & Non-commercial (Recreational)
10	X	X	X	S	156.500		Commercial
11	X	X	X	S	156.550		Commercial. VTS in selected areas.
12	X	X	X	S	156.600		Port operation. VTS in selected areas.
13	X	X	X	S	156.650		Inter-ship Navigation Safety (Bridge-to-bridge)
14	X	X	X	S	156.700		Port operation. VTS in selected areas.
15	X			S	- - -	156.750	Environmental (Receive only)
15		X	X	S	156.750		Commercial, non-commercial, ship movement (1 W)
16	X	X	X	S	156.800		International Distress, Safety and Calling
17	X	X	X	S	156.850		State Controlled (1 W)
18			X	D	156.900	161.500	Port operation, ship movement
1018	X	X		S	156.900		Commercial
19			X	D	156.950	161.550	Port operation, ship movement
1019	X	X		S	156.950		Commercial (USA) Coast Guard (Canada)
1019			X	S	156.950		
2019			X	S	161.550		
20	X	X	X	D	157.000	161.600	Canadian Coast Guard Only, International: port operations and shipment
1020			X	S	157.000		
1020	X			S	157.000		Port operation
2020			X	S	161.600		
21			X	D	157.050	161.650	Port operation, ship movement
1021	X	X		S	157.050		U.S. Government Only (USA) Canadian Coast Guard (Canada)

VHF MARINE CHANNEL CHART							
CH	U	C	I	S/D	TX	RX	CHANNEL USE
2021		X			---	161.650	CMB Service
22			X	D	157.100	161.700	Port operation, ship movement
1022	X	X		S	157.100		US Coast Guard Liaison and Maritime Safety Information Broadcasts announced on channel 16 (USA) Canadian Coast Guard Liaison and Maritime Safety Information Broadcasts announced on channel 16 (Canada)
23		X	X	D	157.150	161.750	Public Correspondence (Marine Operator)
1023	X			S	157.150		U.S. Government Only
2023		X			---	161.750	CMB Service
24	X	X	X	D	157.200	161.800	Public Correspondence (Marine Operator)
25	X	X	X	D	157.250	161.850	Public Correspondence (Marine Operator)
2025		X			---	161.850	CMB Service
26	X	X	X	D	157.300	161.900	Public Correspondence (Marine Operator)
27	X	X	X	D	157.350	161.950	Public Correspondence (Marine Operator)
28	X	X	X	D	157.400	162.000	Public Correspondence (Marine Operator)
2028		X			---	162.000	CMB Service
60		X	X	D	156.025	160.625	Public Correspondence (Marine Operator)
61			X	D	156.075	160.675	Public Correspondence (Marine Operator), Port operation, ship movement
1061	X	X		S	156.075		Public Coast: Coast Guard; East Coast: commercial fishing only
62			X	D	156.125	160.725	Public Correspondence (Marine Operator), Port operation, ship movement
1062		X		S	156.125		Public Coast: Coast Guard; East Coast: commercial fishing only
63			X	D	156.175	160.775	Public Correspondence (Marine Operator), Port operation, ship movement
1063	X	X		S	156.175		Port Operation and Commercial. VTS in selected areas.
64		X	X	D	156.225	160.825	Public Correspondence (Marine Operator), Port operation, ship movement
1064	X	X		S	156.225		Public Correspondence (Marine Operator), Port operation, ship movement
65			X	D	156.275	160.875	Public Correspondence (Marine Operator), Port operation, ship movement
1065	X	X		S	156.275		Port Operations
66			X	D	156.325	160.925	Public Correspondence (Marine Operator), Port operation, ship movement
1066	X	X		S	156.325		Port Operations
67	X	X	X	S	156.375		US: Commercial. Used for Bridge-to-bridge communications in lower Mississippi River. Inter-ship only. Canada: Commercial fishing, S&R
68	X	X	X	S	156.425		Non-commercial (Recreational)
69	X	X	X	S	156.475		US: Non-commercial (Recreational), Canada: Commercial fishing only, International: Inter-ship, Port operations and Ship movement
70	X	X	X	S	---	156.525	Digital selective calling (voice communica- tions not allowed)

VHF MARINE CHANNEL CHART								
CH	U	C	I	S/D	TX		RX	CHANNEL USE
71	X	X	X	S	156.575			US, Canada: Non-commercial (Recreational), International: Port operations and Ship movement
72	X	X	X	S	156.625			Non-commercial (Inter-ship only)
73	X	X	X	S	156.675			US: Port Operations, Canada: Commercial fishing only, International: Inter-ship, Port operations and Ship movement
74	X	X	X	S	156.725			US: Port Operations, Canada: Commercial fishing only, International: Inter-ship, Port operations and Ship movement
75	X	X	X	S	156.775			Port Operations (Inter-ship only) (1 W)
76	X	X	X	S	156.825			Port Operations (Inter-ship only) (1 W)
77	X	X		S	156.875			Port Operations (Inter-ship only) (1 W)
77			X	S	156.875			Port Operations (Inter-ship only)
78			X	D	156.925	161.525		Public Correspondence (Marine Operator), Port operation, ship-movement
1078	X	X		S	156.925			Non-commercial (Recreational)
1078			X	S	156.925			Port operation and Ship movement
2078			X	S	161.525			
79			X	D	156.975	161.575		Port operation and Ship movement
1079	X	X		S	156.975			Commercial
1079			X	S	156.975			Port operation and Ship movement
2079			X	S	161.575			
80			X	D	157.025	161.625		Port operation, ship movement
1080	X	X		S	157.025			Commercial
81			X	D	157.075	161.675		Port operation, ship movement
1081	X	X		S	157.075			U.S. Government Only - Environmental protection operations. (USA) Canadian Coast Guard Only (Canada)
82			X	D	157.125	161.725		Public Correspondence (Marine Operator), Port operation, ship movement
1082	X	X		S	157.125			U.S. Government Only (USA) Canadian Coast Guard Only (Canada)
83			X	D	157.175	161.775		Public Correspondence (Marine Operator)
1083	X	X		S	157.175			U.S. Government Only (USA) Canadian Coast Guard Only (Canada)
2083		X			---	161.775		CMB Service
84	X	X	X	D	157.225	161.825		Public Correspondence (Marine Operator)
85	X	X	X	D	157.275	161.875		Public Correspondence (Marine Operator)
86	X	X	X	D	157.325	161.925		Public Correspondence (Marine Operator)
87	X	X	X	S	157.375			Port operation, ship movement
88	X	X	X	S	157.425			Port operation, ship movement Commercial, Inter-ship Only

NOTE: Simplex channels, 1003, 1021, 1023, 1061, 1064, 1081, 1082 and 1083 CANNOT be lawfully used by the general public in U.S.A. waters.

13.2 HX320E

CH	TX (MHz)	RX (MHz)	SIMPLEX/ DUPLEX	LOW PWR	CHANNEL USE	
					All countries (except Germany)	Germany
01	156.050	160.650	DUPLEX	–	TELEPHONE	NAUTIK
02	156.100	160.700	DUPLEX	–	TELEPHONE	NAUTIK
03	156.150	160.750	DUPLEX	–	TELEPHONE	NAUTIK
04	156.200	160.800	DUPLEX	–	INTL	NAUTIK
05	156.250	160.850	DUPLEX	–	INTL	NAUTIK
06	156.300		SIMPLEX	LOW ^{*4}	SAFETY	SHIP-SHIP
07	156.350	160.950	DUPLEX	–	INTL	NAUTIK
08	156.400		SIMPLEX	LOW ^{*4}	COMMERCIAL	SHIP-SHIP
09	156.450		SIMPLEX	–	CALLING	NAUTIK
10	156.500		SIMPLEX	LOW ^{*4}	COMMERCIAL	SHIP-SHIP
11	156.550		SIMPLEX	LOW ^{*4}	VTS	SHIP-PORT
12	156.600		SIMPLEX	LOW ^{*4}	VTS	SHIP-PORT
13	156.650		SIMPLEX	LOW ^{*4}	BRG/BRG	SHIP-SHIP
14	156.700		SIMPLEX	LOW ^{*4}	VTS	SHIP-PORT
15	156.750		SIMPLEX	LOW	COMMERCIAL	ON-BOARD
16	156.800		SIMPLEX	–	DISTRESS	
17	156.850		SIMPLEX	LOW	SAR	ON-BOARD
18	156.900	161.500	DUPLEX	–	INTL	NAUTIK
19	156.950	161.550	DUPLEX	–	INTL	NAUTIK
1019 ^{*7}	156.950		SIMPLEX	–	–	–
2019 ^{*7}	161.550		SIMPLEX	–	–	–
20	157.000	161.600	DUPLEX	LOW ^{*6}	PORT OPR	NAUTIK
1020 ^{*7}	157.000		SIMPLEX	–	–	–
2020 ^{*7}	161.600		SIMPLEX	–	–	–
21	157.050	161.650	DUPLEX	–	INTL	NAUTIK
22	157.100	161.700	DUPLEX	–	INTL	NAUTIK
23	157.150	161.750	DUPLEX	–	INTL	
24	157.200	161.800	DUPLEX	–	TELEPHONE	
25	157.250	161.850	DUPLEX	–	TELEPHONE	
26	157.300	161.900	DUPLEX	–	TELEPHONE	
27	157.350	161.950	DUPLEX	–	TELEPHONE	
28	157.400	162.000	DUPLEX	–	TELEPHONE	
31 ^{*1}	157.550	162.150	DUPLEX	LOW	NED JACHTHAV	–
37 ^{*2}	157.850		SIMPLEX	LOW	YACHTING UK	–
60	156.025	160.625	DUPLEX	–	TELEPHONE	NAUTIK
61	156.075	160.675	DUPLEX	–	INTL	NAUTIK
62	156.125	160.725	DUPLEX	–	INTL	NAUTIK
63	156.175	160.775	DUPLEX	–	INTL	NAUTIK
64	156.225	160.825	DUPLEX	–	TELEPHONE	NAUTIK
65	156.275	160.875	DUPLEX	–	INTL	NAUTIK
66	156.325	160.925	DUPLEX	–	INTL	NAUTIK
67	156.375		SIMPLEX	–	BRG/BRG	NAUTIK
68	156.425		SIMPLEX	–	SHIP-SHIP	
69	156.475		SIMPLEX	–	PLEASURE	
70	–	156.525	SIMPLEX	–	DSC	
71	156.575		SIMPLEX	LOW ^{*4}	PLEASURE	SHIP-PORT

CH	TX (MHz)	RX (MHz)	SIMPLEX/ DUPLEX	LOW PWR	CHANNEL USE	
					All countries (except Germany)	Germany
72	156.625		SIMPLEX	LOW*4	SHIP-SHIP	
73	156.675		SIMPLEX	–	PORT OPR	NAUTIK
74	156.725		SIMPLEX	LOW*4	PORT OPR	SHIP-PORT
75	156.775		SIMPLEX	LOW	–	SHIP-PORT
76	156.825		SIMPLEX	LOW	–	NAUTIK
77	156.875		SIMPLEX	LOW*4	PORT OPR	SHIP-SHIP
78	156.925	161.525	DUPLEX	–	INTL	NAUTIK
1078*7	156.925		SIMPLEX	–	–	–
2078*7	161.525		SIMPLEX	–	–	–
79	156.975	161.575	DUPLEX	–	INTL	NAUTIK
1079*7	156.975		SIMPLEX	–	–	–
2079*7	161.575		SIMPLEX	–	–	–
80	157.025	161.625	DUPLEX	–	INTL	NAUTIK
81	157.075	161.675	DUPLEX	–	INTL	NAUTIK
82	157.125	161.725	DUPLEX	–	INTL	TELEPHONE
83	157.175	161.775	DUPLEX	–	INTL	TELEPHONE
84	157.225	161.825	DUPLEX	–	TELEPHONE	
85	157.275	161.875	DUPLEX	–	TELEPHONE	
86	157.325	161.925	DUPLEX	–	TELEPHONE	
87	157.375		SIMPLEX	–	PORT OPR	
88	157.425		SIMPLEX	–	PORT OPR	
M*3	157.850		SIMPLEX	–	YACHTING UK	–
M2*3	161.425		SIMPLEX	–	YACHTING UK	–
L1*5	155.500		SIMPLEX	–	PLEASURE	–
L2*5	155.525		SIMPLEX	–	PLEASURE	–
L3*5	155.650		SIMPLEX	–	PLEASURE	–
F1*5	155.625		SIMPLEX	–	FISHING	–
F2*5	155.775		SIMPLEX	–	FISHING	–
F3*5	155.825		SIMPLEX	–	FISHING	–

NOTE: Country Channel assignment are different depending on the ship region.

*1: Channel 31 is assigned to only BELGIUM and NETHERLAND.

*2: Channel 37 is assigned to only NETHERLAND.

*3: Channel M and M2 are assigned to only UNITED KINGDOM.

*4: LOW Power setting for BELGIUM, NETHERLAND and GERMANY.

*5: Channel L1, L2, L3, F1, F2 and F3 are assigned to only SWEDEN.

*6: LOW Power setting for GERMANY.

*7: Not assigned for NORWAY.

14. SPECIFICATIONS

Performance specifications are nominal, unless otherwise indicated, and are subject to change without notice. Measurements*1 are in accordance with TIA/EIA-603 (U.S.A.) and EN301 178 (EXP).

*1(Except the FM Broadcast Receiver)

● GENERAL

Frequency Ranges: TX: 156.025MHz - 161.600MHz
(Frequency differs in some regions) RX: 156.050MHz - 163.275MHz

(Inter National, Including WX channels)

Channel Spacing: 25kHz

Frequency Stability: ± 3 ppm (-20°C to $+60^{\circ}\text{C}$)

Emission Type: 16K0G3E

Antenna Impedance: 50 Ω

Operating Voltage: 7.4VDC, Negative Ground

Current Consumption: 330mA (Receive, Typical at AF MAX.)

100mA (Standby)

1.6 A / 1.0A / 0.7A (TX: 6W (5W)*2 / 2.5W / 1W)

Operating Temperature: (-4°F to $+140^{\circ}\text{F}$) (-20°C to $+60^{\circ}\text{C}$)

Case Size (W x H x D): 2.36" x 5.24" x 1.65" (60mm x 133mm x 42mm)
(w/o knob & antenna)

Weight (Approx.): 10.23oz (290g) (With hand strap, belt clip & antenna)

● TRANSMITTER

RF Power Output: 6W (5W)*2 / 2.5W / 1W (@7.4 V)

Maximum Deviation: ± 5 kHz

Spurious Emission: Less than 0.25 μW

Microphone Impedance: 2k Ω

*2(5 W TX required in Some Countries)

● RECEIVER

Circuit Type: Single Conversion Superheterodyne

Intermediate Frequencies: 1st: 46.35MHz

Adjacent Channel Selectivity: 70 dB typical

Intermodulation: 70 dB typical (U.S.A.)

68 dB typical (EXP)

Hum & Noise Ratio: 40 dB typical

Sensitivity: 0.25 μV for 12 dB SINAD (U.S.A.)

-5dB μ for 20dB SINAD (EXP)

Selectivity: 12kHz / 25kHz (-6 dB / -60 dB)

AF Output (Internal speaker): 700mW @16 Ω for 10% THD (@7.4V)

● FM BROADCAST RECEIVER

Frequency Range: 65MHz - 108MHz

Frequency Step: 100kHz

Sensitivity: 1.0 μV for 12dB SINAD

● Bluetooth

Version: Class 1

Output Power: 10dBm

Symbols placed on the equipment

 Direct current

15. FCC AND CANADA RADIO LICENSE INFORMATION

Standard Horizon radios comply with the Federal Communication Commission (FCC) and the Innovation, Science and Economic Development Canada (ISED) requirements that regulate the Maritime Radio Service.

15.1 MARITIME STATION LICENSE

An FCC ship station license is no longer required for any vessel traveling in U.S. waters which uses a VHF marine radio, RADAR or EPIRB, and which is not required to carry radio equipment. However, any vessel required to carry a marine radio on an international voyage, carrying a HF single side band radiotelephone or marine satellite terminal. FCC license forms, including applications for ship (605) and land station licenses can be downloaded via the Internet at <https://www.fcc.gov/fcc-form-605>. To obtain a form from the FCC, call (888) 225-5322.

15.2 MARINE RADIO CALL SIGN

Currently the FCC does not require recreational boaters to have a Ship Radio Station License. The USCG recommends the boats registration number and the state to be used.

15.3 CANADIAN SHIP STATION LICENSING

Please click on the following link for licensing information:

http://www.ic.gc.ca/eic/site/smt-gst.nsf/eng/h_sf01775.html

The following link lists several Branches/Offices regarding licensing. Licensing depends on the region of operations.

<http://www.ic.gc.ca/eic/site/smt-gst.nsf/eng/sf01742.html>

15.4 FCC / ISED INFORMATION

The following data pertaining to the transceiver is necessary to fill out the license application.

FCC Type Accepted: Part 80

ISED Type Accepted: RSS-182

Output Power with built-in Battery: 1.0/2.5/6.0 W (Low/Mid/High)

Emission: 16K0G3E

Frequency Range: 156.025 to 162.025MHz

FCC Type Number: K6630683X30

ISED Type Approval: 511B-30683X30

16. RF EXPOSURE SAFETY STATEMENT

16.1 SAFETY INFORMATION

Your wireless handheld portable transceiver contains a low power transmitter. When the Push-to-Talk (PTT) button is pushed, the transceiver sends out radio frequency (RF) signals. In August 1996, the Federal Communications Commission adopted RF exposure guidelines with safety levels for hand-held wireless devices.

This device is authorized to operate at a duty factor not to exceed 50% (this corresponds to 50% transmission time and 50% reception time). Even if BT call function is used, the maximum duty cycle of the product is 50%.

WARNING: To maintain compliance with the FCC's RF exposure guidelines, this transmitter and its antenna must maintain a separation distance of at least 1 inch (2.5 centimeters) from your face and 0 inches (0 centimeters) from your body. Speak in a normal voice, with the antenna pointed up and away from the face at the required separation distance.

Use only the supplied antenna. Unauthorized antennas, modifications, or attachments could damage the transmitter, and may violate FCC regulations.

16.2 CONSIGNES DE SECURITE

Votre émetteur-récepteur portatif sans fil contient un émetteur à faible puissance. Lorsque vous appuyez sur le bouton Push-to-Talk (PTT), l'émetteur-récepteur émet des signaux de radiofréquence (RF). En août 1996, la FCC (Commission Fédérale des Communications) a adopté des directives relatives à l'exposition aux RF avec des niveaux de sécurité pour les appareils sans fil portatifs. Le fonctionnement de cet appareil est autorisé à un facteur d'utilisation ne dépassant pas 50 % (correspondant à 50% de la durée de transmission et 50% de la durée de réception).

AVERTISSEMENT: Pour assurer la conformité avec les directives d'exposition RF de la FCC, cet émetteur-récepteur et son antenne doivent être maintenus à une distance minimum d'un pouce (2,5 centimètre) de votre visage. Parlez avec une voix normale, avec l'antenne dirigée vers le haut et éloignée du visage, à la distance requise. Si vous utilisez un casque pour cette radio, et que vous portez la radio sur vous, utilisez exclusivement le clip de ceinture Yaesu pour cet émetteur-récepteur, et assurez-vous que l'antenne se trouve à une distance minimum d'un pouce (2,5 centimètres) de votre corps pendant l'émission. Utilisez exclusivement l'antenne fournie. Les antennes, les modifications ou les accessoires non autorisés peuvent endommager l'émetteur-récepteur et enfreindre les réglementations FCC.

17. FCC NOTICE

NOTICE

Unauthorized changes or modifications to this equipment may void compliance with FCC Rules. Any change or modification must be approved in writing by STANDARD HORIZON, a division of YAESU USA.

THIS DEVICE COMPLIES WITH PART 15 OF THE FCC RULES. OPERATION IS SUBJECT TO THE FOLLOWING TWO CONDITIONS: (1) THIS DEVICE MAY NOT CAUSE HARMFUL INTERFERENCE, AND (2) THIS DEVICE MUST ACCEPT ANY INTERFERENCE RECEIVED, INCLUDING INTERFERENCE THAT MAY CAUSE UNDESIRE OPERATION.

NOTE: THE GRANTEE IS NOT RESPONSIBLE FOR ANY CHANGES OR MODIFICATIONS NOT EXPRESSLY APPROVED BY THE PARTY RESPONSIBLE FOR COMPLIANCE. SUCH MODIFICATIONS COULD VOID THE USER'S AUTHORITY TO OPERATE THE EQUIPMENT.

NOTE: This equipment has been tested and found to comply with the limits for a Class B digital device, pursuant to part 15 of the FCC Rules. These limits are designed to provide reasonable protection against harmful interference in a residential installation. This equipment generates uses and can radiate radio frequency energy and, if not installed and used in accordance with the instructions, may cause harmful interference to radio communications. However, there is no guarantee that interference will not occur in a particular installation. If this equipment does cause harmful interference to radio or television reception, which can be determined by turning the equipment off and on, the user is encouraged to try to correct the interference by one or more of the following measures:

- Reorient or relocate the receiving antenna.
- Increase the separation between the equipment and receiver.
- Connect the equipment into an outlet on a circuit different from that to which the receiver is connected.
- Consult the dealer or an experienced radio/TV technician for help.

This device complies with Industry Canada license-exempt RSS standard(s). Operation is subject to the following two conditions: (1) this device may not cause interference, and (2) this device must accept any interference, including interference that may cause undesired operation of the device.

Le présent appareil est conforme aux CNR d'Industry Canada applicables aux appareils radio exempts de licence. L'exploitation est autorisée aux deux conditions suivantes : (1) l'appareil ne doit pas produire de brouillage, et (2) l'utilisateur de l'appareil doit accepter tout brouillage radioélectrique subi, même si le brouillage est susceptible d'en compromettre le fonctionnement.

This radio transmitter (identify the device by certification number, or model number if Category II) has been approved by Industry Canada to operate with the antenna types listed below with the maximum permissible gain and required antenna impedance for each antenna type indicated. Antenna types not included in this list, having a gain greater than the maximum gain indicated for that type, are strictly prohibited for use with this device.

Le présent émetteur radio (identifier le dispositif par son numéro de certification ou son numéro de modèle s'il fait partie du matériel de catégorie I) a été approuvé par Industry Canada pour fonctionner avec les types d'antenne énumérés ci-dessous et ayant un gain admissible maximal et l'impédance requise pour chaque type d'antenne. Les types d'antenne non inclus dans cette liste, ou dont le gain est supérieur au gain maximal indiqué, sont strictement interdits pour l'exploitation de l'émetteur.

The applicant is responsible for providing proper instructions to the user of the radio device, and any usage restrictions, including limits of exposure durations. The user manual shall provide installation and operation instructions, as well as any special usage conditions, to ensure compliance with SAR and/or RF field strength limits. For instance, compliance distance shall be clearly stated in the user manual.

The user manual of devices intended for controlled use shall also include information relating to the operating characteristics of the device; the operating instructions to ensure compliance with SAR and/or RF field strength limits; information on the installation and operation of accessories to ensure compliance with SAR and/or RF field strength limits; and contact information where the user can obtain Canadian information on RF exposure and compliance. Other related information may also be included.

STANDARD HORIZON Limited Warranty

Limited Warranty is valid only in the country/region where this product was originally purchased.

On-line Warranty Registration:

Thank you for buying STANDARD HORIZON products! We are confident your new radio will serve your needs for many years! Please register your product at www.standardhorizon.com - Owner's Corner

Warranty Terms:

Subject to the Limitations of the Warranty and the Warranty Procedures described below, YAESU MUSEN hereby warrants this product to be free of defects in materials and workmanship in normal use during the "Warranty Period." (the "Limited Warranty").

Limitations of Warranty:

- A. YAESU MUSEN is not liable for any express warranties except the Limited Warranty described above.
- B. The Limited Warranty is extended only to the original end-use purchaser or the person receiving this product as a gift, and shall not be extended to any other person or transferee.
- C. Unless a different warranty period is stated with this YAESU product, the Warranty Period is three years from the date of retail purchase by the original end-use purchaser.
- D. The Limited Warranty is valid only in the country/region where this product was originally purchased.
- E. During the Warranty Period, YAESU MUSEN will, at its sole option, repair or replace (using new or refurbished replacement parts) any defective parts within a reasonable period of time and free of charge.
- F. The Limited Warranty does not cover shipping cost (including transportation and insurance) from you to us, or any import fees, duties or taxes.
- G. The Limited Warranty does not cover any impairment caused by tampering, misuse, failure to follow instructions supplied with the product, unauthorized modifications, or damage to this product for any reasons, such as: accident; excess moisture; lightning; power surges; connection to improper voltage supply; damage caused by inadequate packing or shipping procedures; loss of, damage to or corruption of stored data; product modification to enable operation in another country/purpose other than the country/purpose for which it was designed, manufactured, approved and/or authorized; or the repair of products damaged by these modifications.
- H. The Limited Warranty applies only to the product as it existed at the time of the original purchase, by the original retail purchaser, and shall not preclude YAESU MUSEN from later making any changes in design, adding to, or otherwise improving subsequent versions of this product, or impose upon YAESU MUSEN any obligation to modify or alter this product to conform to such changes, or improvements.
- I. YAESU MUSEN assumes no responsibility for any consequential damages caused by, or arising out of, any such defect in materials or workmanship.
- J. TO THE FULLEST EXTENT PERMITTED BY LAW, YAESU MUSEN SHALL NOT BE RESPONSIBLE FOR ANY IMPLIED WARRANTY WITH RESPECT TO THIS PRODUCT.
- K. If the original retail purchaser timely complies with the Warranty Procedures described below, and YAESU MUSEN elects to send the purchaser a replacement product rather than repair the "original product", then the Limited Warranty shall apply to the replacement product only for the remainder of the original product Warranty Period.
- L. Warranty statutes vary from state to state, or country to country, so some of the above limitations may not apply to your location.

Warranty Procedures:

1. To find the Authorized STANDARD HORIZON Service Center in your country/region, visit www.standardhorizon.com. Contact the STANDARD HORIZON Service Center for specific return and shipping instructions, or contact an authorized STANDARD HORIZON dealer/distributor from whom the product was originally purchased.
2. Include proof of original purchase from an authorized STANDARD HORIZON dealer/distributor, and ship the product, freight prepaid, to the address provided by the STANDARD HORIZON Service Center in your country/ region.
3. Upon receipt of this product, returned in accordance with the procedures described above, by the STANDARD HORIZON Authorized Service Center, all reasonable efforts will be expended by YAESU MUSEN to cause this product to conform to its original specifications. YAESU MUSEN will return the repaired product (or a replacement product) free of charge to the original purchaser. The decision to repair or replace this product is the sole discretion of YAESU MUSEN.

Other conditions:

YAESU MUSEN'S MAXIMUM LIABILITY SHALL NOT EXCEED THE ACTUAL PURCHASE PRICE PAID FOR THE PRODUCT. IN NO EVENT SHALL YAESU MUSEN BE LIABLE FOR LOSS OF, DAMAGE TO OR CORRUPTION OF STORED DATA, OR FOR SPECIAL, INCIDENTAL, CONSEQUENTIAL, OR INDIRECT DAMAGES, HOW EVER CAUSED; INCLUDING WITHOUT LIMITATION TO THE REPLACEMENT OF EQUIPMENT AND PROPERTY, AND ANY COSTS OF RECOVERING, PROGRAMMING OR REPRODUCING ANY PROGRAM OR DATA STORED IN OR USED WITH THE YAESU PRODUCT.

Some Countries in Europe and some States of the USA do not allow the exclusion or limitation of incidental or consequential damages, or a limitation on how long an implied warranty lasts, so the above limitation or exclusions may not apply. This warranty provides specific rights, there may be other rights available which may vary between countries in Europe or from state to state within the USA.

This Limited Warranty is void if the label bearing the serial number has been removed or defaced.

EU Declaration of Conformity

We, Yaesu Musen Co. Ltd of Tokyo, Japan, hereby declare that this radio equipment HX320E is in full compliance with EU Radio Equipment Directive 2014/53/EU. The full text of the Declaration of Conformity for this product is available to view at <http://www.yaesu.com/jp/red>

ATTENTION – Condition of use

This transceiver operates on frequencies that are regulated. Use of the Transmitter in the EU countries shown in the accompanying table is not permitted without authorization. Users should consult their local spectrum management authority for licensing conditions applicable to this equipment.

					
AT	BE	BG	CY	CZ	DE
DK	ES	EE	FI	FR	EL
HR	HU	IE	IT	LT	LU
LV	MT	NL	PL	PT	RO
SK	SI	SE	CH	IS	LI
NO	-	-	-	-	-

Disposal of Electronic and Electrical Equipment

Products with the symbol (crossed-out wheeled bin) cannot be disposed as household waste.

Electronic and Electrical Equipment should be recycled at a facility capable of handling these items and their waste by-products.

Please contact a local equipment supplier representative or service center for information about the waste collection system in your country.



UKCA Declaration of Conformity

We, Yaesu Musen Co. Ltd of Tokyo, Japan declare our sole responsibility that this equipment complies with essential requirements of the Radio Equipment Regulations 2017, Electrical Equipment (Safety Regulations 2016), Electromagnetic Compliance Regulations 2016 and Restrictions of the use of Certain Hazardous Substances in Electrical and Electronic Equipment Regulations 2012 as appropriate.

STANDARD HORIZON

Nothing takes to water like Standard Horizon

Copyright 2023
YAESU MUSEN CO., LTD.
All rights reserved.

No portion of this manual may be
reproduced without the permission of
YAESU MUSEN CO., LTD.

YAESU MUSEN CO., LTD.

Omori Bellport Building D-3F
6-26-3 Minami-Oi, Shinagawa-ku, Tokyo, 140-0013, Japan

YAESU USA

6125 Phyllis Drive, Cypress, CA 90630, U.S.A.

YAESU UK

Unit 12, Sun Valley Business Park, Winnall Close
Winchester, Hampshire, SO23 0LB, U.K.

2301J-DC

Printed in China

