

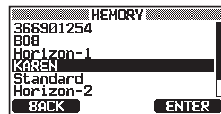

7. Rotate the **DIAL/ENT** knob to select a directory list number, then press the [**SELECT**] soft key.
8. Rotate the **DIAL/ENT** knob to select a member from the Individual directory, then press the [**SELECT**] soft key.
9. Repeat steps 8 to add members to the group, then press the [**BACK**] soft key.
10. Press the [**BACK**] soft key to return to the “NAME:” and “GM ID:” screen.
11. Rotate the **DIAL/ENT** knob to select “**SAVE**” to store the data, then press the [**ENTER**] soft key.
12. To enter another group directory, repeat steps 2 through 11.
13. Press the [**CLEAR**] key to return to radio operation.



### 13.1.2 Setting Up the Polling Time Interval

1. Press & hold [  ] ⇒ “GM SETUP” ⇒ “INTERVAL”
2. Rotate the **DIAL/ENT** knob to select the desired polling interval time, then press the [**ENTER**] soft key.
3. Press the [**CLEAR**] key to return to radio operation.



### 13.1.3 Enabling/Disabling Transmission during GM Operation

1. Press & hold [  ] ⇒ “GM SETUP” ⇒ “GM TX”
2. Rotate the **DIAL/ENT** knob to select the desired transmission type, then press the [**ENTER**] soft key.

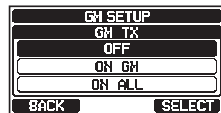

OFF: Disables the transmission during GM operation.

ON GM: Enables the transmission during the GM target display.

ON ALL: Enables the transmission during the GM operation.

3. Press the [**CLEAR**] key to return to radio operation.

## 13.2 STARTING GM OPERATION

### NOTE

To start GM operation, configure the GM Group Directory setting in setup menu. Otherwise, you cannot start the GM operation. Refer to section “**13.1.1 Setting Up GM Group Directory**” for details.

1. [  ] → “GM”

2. Rotate the **DIAL/ENT** knob to select a group you want to monitor, then press the [SELECT] soft key.



The GM operation begins, and the GM target display appears.

3. Press the [CLEAR] key to return to radio operation.

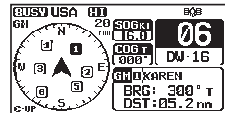

### 13.2.1 Changing the GM Group Being Monitored

1. On the GM target display, press one of the soft keys, then press the [TG LIST] soft key.

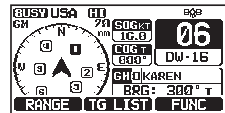

2. Press the [CHG GRP] soft key.

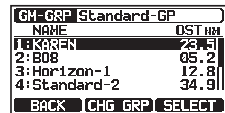

3. Rotate the **DIAL/ENT** knob to select the name of the group you want to monitor, then press the [SELECT] soft key.



The GM group being monitored changes. The GM target display appears.

4. Press the [CLEAR] key to return to radio operation.

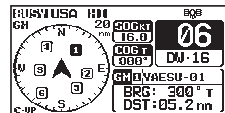

### 13.2.2 Transmitting a DSC Call to a Group Member

1. On the GM target display, press one of the soft keys, then press the **[TG LIST]** soft key.
2. Rotate the **DIAL/ENT** knob to select a member you want to call.
3. Press the **[SELECT]** soft key to display the location, distance, and bearing of the selected member.
4. Press the **[CALL]** soft key to transmit a DSC Individual call to the selected member.

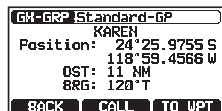
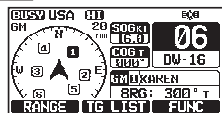

### 13.2.3 Starting Navigation to a Group Member

1. On the GM target display, press one of the soft keys to show the key selections.
2. Press the **[TG LIST]** soft key.
3. Rotate the **DIAL/ENT** knob to select a member you want to approach.
4. Press the **[SELECT]** soft key to display the location, distance, and bearing of the selected member.
5. Press the **[TO WPT]** soft key to start navigation to the selected member. (Press the **[BACK]** soft key twice to cancel and return to the GM target display.)

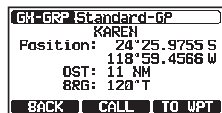
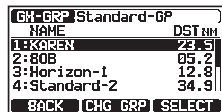
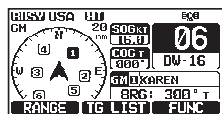

## 14 AUTOMATIC IDENTIFICATION SYSTEM (AIS)

### 14.1 GENERAL

#### NOTE

The **GX2400** does not require a special marine VHF antenna to receive AIS transmissions. The **GX2400** does not transmit AIS signals, it is NOT recommended to use an antenna dedicated for AIS operation.

The Automatic Identification System (AIS) is a short range coastal tracking system. AIS is intended to assist in collision avoidance by seeing positions and courses of AIS equipped vessels around your vessel.

AIS is mandatory on passenger ships, irrespective of size, all ships 300 gross tonnage and larger engaged on international voyages, cargo ships of 500 gross tonnage and larger not engaged on international voyages.

AIS uses two marine VHF channels. Each ship equipped with an AIS transponder transmits a packet every few seconds with information about the ship and its voyage. Radio frequencies: AIS1 = 161.975 MHz and AIS2 = 162.025 MHz. A stand-alone AIS receiver or the AIS receiver built in to a Class A or Class B transponder can pick up these radio signals and translate them into a NMEA data sentence that can be understood by a computer with the proper software or by an AIS-enabled chart plotter.

#### Classes of AIS:

Class A - 12.5W power output - mandated for use on SOLAS Chapter V vessels (and others in some countries).

Class B CS - 2W output - lower cost derivative for leisure and non-SOLAS markets.

The **GX2400** is capable of receiving Class A and Class B CS transmissions with the internal Dual Channel AIS receiver.

### 14.2 AIS OPERATION

The **GX2400** is equipped with an AIS receiver and can display AIS targets around your vessel on the radio's display. Therefore, you can identify and avoid in proximity to your vessel.

#### NOTE

To show AIS targets on the radio's display, the internal or external GPS needs to be fixed own location so the radio knows its position relative to the AIS targets.

1. [  ] → "AIS"

The AIS display shows your vessel as a “” icon in the center of the display. AIS targets are shown as triangles. The line projected from the circle is the AIS vessels course over ground (COG).

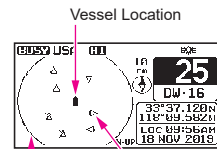

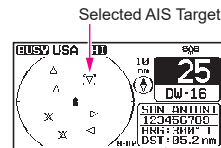

Range Ring AIS Target



Information of the AIS Target

2. Rotate the **DIAL/ENT** knob to change the AIS target. Rotating the **DIAL/ENT** knob counterclockwise sequentially displays AIS vessels in order closest to your ship. Rotating the **DIAL/ENT** knob clockwise sequentially displays AIS vessels in order furthest from your ship.

The selected AIS target is displayed with “” icon, while other stations are displayed with “” icon.

**NOTE:** Up to 15 AIS targets can be shown on the display. All received AIS targets are displayed on the compatible chart plotter or navigation software via NMEA 0183 or NMEA 2000.

3. Press the **[CLEAR]** key to return to radio operation.

#### 14.2.1 Displaying the AIS Target Information Screen

1. On the AIS screen, press one of the soft keys to show the key selections. These selections are described below:

**[RANGE]:** Press this key to change the display range of the screen.

**[TG LIST]:** Press this key to show a list of the MMSI numbers or the vessel names being received.

**[FUNC]:** Press this key to show the function menu.

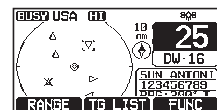

2. Press the **[TG LIST]** soft key to show a list of AIS target being received.
3. Rotate the **DIAL/ENT** knob to select the MMSI number (or vessel name). then press the **[SELECT]** soft key. Pressing the **[DANGER]** soft key changes the order to the TCPA time order.
4. The AIS target information screen appears. To see more information of the AIS target, rotate the **DIAL/ENT** knob. Press the **[BACK]** key to return to a list of AIS target.
5. Press the **[EXIT]** key to return to radio operation.

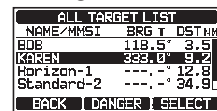

## 14.2.2 Changing the AIS Range

1. On the AIS screen, press one of the soft keys to show the key selections.
2. Press the **[RANGE]** soft key. Press the soft keys at the center and right side to select the radius range to display on the AIS screen.
3. Press the **[BACK]** soft key to return to AIS screen.

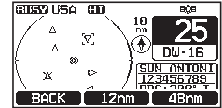
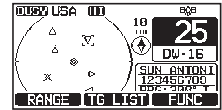

### NOTE

You may change the display range unit of the AIS screen, refer to section **“19.7 UNITS OF MEASURE”**.

## 14.2.3 Transmitting an Individual Call to an AIS Ship

It is possible for the **GX2400** to transmit a DSC individual call to a received AIS target by the procedure below:

1. On the AIS screen, press one of the soft keys to show the key selections.
2. Press the **[TG LIST]** soft key to show a list of AIS target being received.
3. Rotate the **DIAL/ENT** knob to select the MMSI number (or vessel name), then press the **[SELECT]** soft key.
4. Press the **[CALL]** soft key
5. In the INTERSHIP CH list, rotate the **DIAL/ENT** knob to select the operating channel on which you want to communicate, then press the **[SELECT]** soft key. To select operating channels from all voice channels, press the **[MANUAL]** soft key.
6. To transmit an individual DSC call to the select AIS ship, press the **[YES]** soft key.

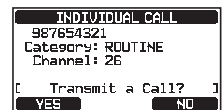
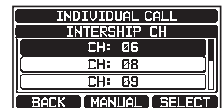
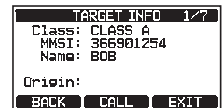
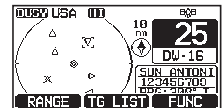

After the **GX2400** transmits, the radio waits for the DSC radio on the AIS ship to transmit a reply, at which time the radio will ring like a telephone. Pick up the microphone, press the **PTT** switch and talk to the AIS vessel.

7. Press the [**QUIT**] soft key to return to AIS screen.
8. Press the [**CLEAR**] key to return to radio operation.



#### 14.2.4 CPA/TCPA Alarm Functions

The CPA (Closest Point of Approach) alarm sounds when other AIS vessels enter within the range set as the CPA Limit. For details, refer to section “**14.3.1 CPA**”.

The TCPA (Time to Closest Point of Approach) alarm sounds according to the time set as the TCPA Limit which is the time taken until other AIS vessels enter within the range set as the CPA Limit. For details, refer to section “**14.3.2 TCPA**”.

1. If other AIS vessels approach your ship, the alarm sounds according to the CPA Limit and TCPA Limit that you set in advance.
2. Press any key to stop the alarm.

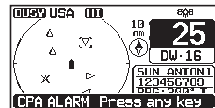

The targets for the CPA/TCPA alarm will appear with “**[ ]**” and flash.

Up to 15 targets for the CPA/TCPA alarm can be shown on the screen.

**NOTE:** If the display is in a mode other than AIS, the radio automatically switches to the AIS mode.

3. On the display you will notice 3 soft key selections. These selections are described below:

[**INFO**]: Pressing this key shows the information screen of the CPA/TCPA alarm targets.

[**CALL**]: Pressing this key switches the screen to the setting screen for transmitting individual DSC calls.

[**EXIT**]: Press this key to return to AIS screen.

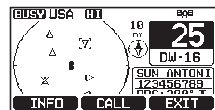

4. To transmit individual calls to the CPA/TCPA alarm targets, follow steps 4 through 8 in “**14.2.3 Transmitting an Individual Call to an AIS Ship**”

## 14.2.5 Changing the Compass Display

The compass display can be switched between “COURSE-UP” and “NORTH-UP”. The default setting is “COURSE-UP”.

Refer to section “**19.2 COMPASS DIRECTION**” for details.

## 14.3 AIS SETUP

### 14.3.1 CPA

This function allows you to set the CPA (Closest Point of Approach)\* alarm distance.

※: CPA means the positions at which two moving vessels reach their closest possible distance.

1. Press & hold [  ] ⇒ “AIS SETUP” ⇒ “CPA”

2. Rotate the **DIAL/ENT** knob to select the distance you want the radio to alert you of an approaching AIS equipped vessel. You can select one from “**0.1nm**” to “**20nm**” (“1nm” is default).
3. Press the [**ENTER**] soft key to store the selected setting.
4. Press the [**CLEAR**] key to return to radio operation.



### 14.3.2 TCPA

This function allows you to set the TCPA (Time to Closest Point of Approach)\* alarm.

※: Setting up a TCPA alarm sets a time point where the radio will alarm when an AIS equipped vessel approaching is within the time selected.

1. Press & hold [  ] ⇒ “AIS SETUP” ⇒ “TCPA”

2. Rotate the **DIAL/ENT** knob to select the time you want the radio to alert you of an approaching AIS equipped vessel. The time can be set from “**1min**” to “**60min**” (“10min” is default).
3. Press the [**ENTER**] soft key to store the selected setting.
4. Press the **CLEAR** key to return to radio operation.





### 14.3.3 CPA/TCPA Alarm

Enable/disable the CPA/TCPA alarm functions. The default setting is “OFF”.

1. Press & hold [  ] ⇒ “AIS SETUP” ⇒ “CPA/TCPA ALARM”

2. Rotate the **DIAL/ENT** knob to select “**CPA**” or “**TCPA**”, then press the [ **SELECT** ] soft key.



3. Rotate the **DIAL/ENT** knob to select “**OFF**” or “**ON**”.
4. Press the [ **ENTER** ] soft key to store the selected setting.
5. Press the [ **CLEAR** ] key to return to radio operation.



#### NOTE

The alarm will sound until it is disabled (1) by pressing any key, (2) following the steps above and selecting “OFF” in step 3, or (3) when the ship is out of the selected CPA/TCPA alarm range. The alarm is produced from the front panel speaker, the speaker in the microphone, the optional external speaker and optional **RAM4** and **RAM4W** microphone when connected.

### 14.3.4 IGNORE VESSELS

This function allows listed registered AIS vessels to be ignored by the CPA / TCPA alarm function.

1. Press & hold [  ] ⇒ “AIS SETUP” ⇒ “CPA/TCPA ALARM”

2. Rotate the **DIAL/ENT** knob to select “**IGNORE VESSELS**”, then press the [ **SELECT** ] soft key.



3. Rotate the **DIAL/ENT** knob to select “**ADD**”, then press the [ **SELECT** ] soft key.



4. Rotate the **DIAL/ENT** knob to select “**NAME:**”, then press the [ **SELECT** ] soft key.

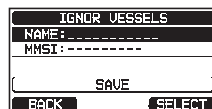

- Press the [◀] or [▶] key to select the letters of the name of the vessel or person you want to reference in the ignore vessel.

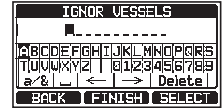

- Press the [SELECT] soft key to store the first letter in the name and step to the next letter to the right.
- Repeat steps 5 and 6 until the name is complete.

The name can consist of up to eleven characters, and if you do not use all fifteen characters, select "→" to move to the next space. This method can also be used to enter a blank space in the name.

If a mistake was made entering in the MMSI number, press the [◀] or [▶] key to select "←" or "→", press the [SELECT] soft key until the wrong character is selected, then perform step 5.

- When finished entering the name (using eleven characters or less), press the [FINISH] soft key to advance to the MMSI number entry.
- Rotate the **DIAL/ENT** knob to select "MMSI:", then press the [SELECT] soft key.

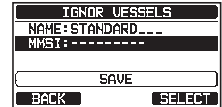

- Press the [◀] or [▶] key to select numbers, 0 - 9. To enter the desired number and move one space to the right by pressing the [SELECT] soft key. Repeat this procedure until all nine space of the MMSI number are entered.

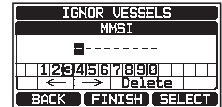

If a mistake was made entering in the MMSI number, press the [◀] or [▶] key to select "←" or "→", press the [SELECT] soft key until the wrong character is selected, then perform step 10.

- When the MMSI number is entered, press the [FINISH] soft key.
- To store the entered data, rotate the **DIAL/ENT** knob to select "SAVE", then press the [SELECT] soft key.
- To enter another AIS vessel, repeat steps 3 through 12.
- Press the [CLEAR] key to return to radio operation.

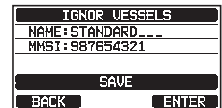

## 15 NMEA 2000 SETUP

Set the device numbers and system numbers of devices connected to the NMEA 2000 network.

### 15.1 SELECT DEVICE

Select the device for which you want to set the device number and system number.

1. Press & hold [  ] ⇒ “NMEA2000 SETUP” ⇒ “SELECT DEVICE”
2. In the SELECT DEVICE list, rotate the **DIAL/ENT** knob to select the external device for which the device number and the system number are to be set.
3. Press the [**SELECT**] soft key to store the selected setting.
4. Press the [**CLEAR**] key to return to radio operation.



#### NOTE

If any devices connected to the network are not displayed in the list, press the [**SEARCH**] soft key to update the list.

### 15.2 DEVICE NUMBER

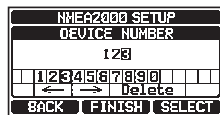

If connecting two or more the **GX2400** series, change the device number of either one. Set the device number of the device selected in “15.1 SELECT DEVICE”.

1. Press & hold [  ] ⇒ “NMEA2000 SETUP” ⇒ “DEVICE NUMBER”
2. Rotate the **DIAL/ENT** knob to select the first digit of the device number, then press the [**SELECT**] soft key to step to the next number.
3. Repeat step 2 to set the device number within the range of 000 to 251. (“000” is default).
4. If a mistake is made entering in the device number, press the [◀] or [▶] key to select “←” or “→”, press the [**SELECT**] soft key until the incorrect character is selected, and perform step 2.
5. When finished programming the device number, press the [**FINISH**] soft key.
6. Press the [**CLEAR**] key to return to radio operation.



## 15.3 SYSTEM NUMBER

Set the system number of the device selected in “15.1 SELECT DEVICE”.

- Press & hold [  ] ⇒ “NMEA2000 SETUP” ⇒ “SYSTEM NUMBER”
- Press the [◀] or [▶] key to select the first digit of the system number, then press the [SELECT] soft key to step to the next number. 
- Repeat step 2 to set the system number within the range of 00 to 15. (“00” is default).
- If a mistake is made entering in the system number, press the [◀] or [▶] key to select “←” or “→”, press the [SELECT] soft key until the incorrect character is selected, then perform step 2.
- When finished programming the system number, press the [FINISH] soft key. 
- Press the [CLEAR] key to return to radio operation.

## 15.4 SUMMARY OF THE NMEA 2000 SETUP

Item	Description	Default Value	Page
SELECT DEVICE	Select the device for which you want to set the device number or the system number	-	94
DEVICE NUMBER	Set the device number	000	94
SYSTEM NUMBER	Set the system number	00	95

## 15.5 COMPATIBLE NMEA 2000 PGN LIST

Receive		Transmit	
059392	ISO Acknowledgement	059392	ISO Acknowledgement
059904	ISO Request	059904	ISO Request
060928	ISO Address Claim	060928	ISO Address Claim
065240	ISO Commanded Address	-	-
126464	Receive/Transmit PGN's group function	126464	Receive/Transmit PGN's group function
126993	Heartbeat	126993	Heartbeat
126996	Product Information	126996	Product Information
127237	Heading/Track Control	-	-
127250	Vessel Heading	-	-
127258	Magnetic Variation	-	-
128259	Speed	-	-
129025	Position, Rapid Update	-	-
129026	COG and SOG, Rapid Update	-	-
129029	GNSS Position Data	129029	GNSS Position Data
129033	Local Time Offset	-	-

Receive		Transmit	
-	-	129038	AIS Class A Position Report
-	-	129039	AIS Class B Position Report
-	-	129040	AIS Class B Extended Position Report
-	-	129041	AIS Aids to Navigation (AtoN) Report
-	-	129793	AIS UTC and Date Report (Base Station)
-	-	129794	AIS Class A Static and Voyage Related Data
-	-	129796	AIS Acknowledge
-	-	129797	AIS Binary Broadcast Message
-	-	129798	AIS SAR Aircraft Position Report
-	-	129799	Radio Frequency/Mode/Power
-	-	129801	AIS Addressed Safety Related Message
-	-	129802	AIS Safety Related Broadcast Message
-	-	129808	DSC Call Information
-	-	129809	AIS Class B "CS" Static Data Report, Part A
-	-	129810	AIS Class B "CS" Static Data Report, Part B
129540	GNSS Sats in View	129540	GNSS Sats in View

## 16 CONFIGURATION SETUP

### 16.1 DISPLAY MODE

The display mode can be selected according to the time of day you operate the radio.

1. Press & hold [  ] ⇒ **“CONFIGURATION”** ⇒ **“DISPLAY MODE”**

2. Rotate the **DIAL/ENT** knob to select the desired setting. Select the **“DAY MODE”** or **“NIGHT MODE”** setting.

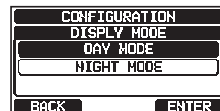

DAY MODE: Normal display mode.

NIGHT MODE: Low brightness display mode for night use.

3. Press the [ **ENTER** ] soft key to store the selected setting.
4. Press the [ **CLEAR** ] key to return to radio operation.

### 16.2 DIMMER ADJUSTMENT

This menu selection adjusts the backlight intensity.

1. Press & hold [  ] ⇒ **“CONFIGURATION”** ⇒ **“DIMMER”**

2. Rotate the **DIAL/ENT** knob to select the desired level (“7” is default). When “OFF” is selected, the lamp is turned OFF.



3. Press the [ **ENTER** ] soft key to store the selected level.
4. Press the [ **CLEAR** ] key to return to radio operation.

### 16.3 DISPLAY CONTRAST

The display contrast can be adjusted to suit your operation environment.

1. Press & hold [  ] ⇒ **“CONFIGURATION”** ⇒ **“CONTRAST”**

2. Rotate the **DIAL/ENT** knob to select the desired level. The contrast level can be set from “1” to “30” (“15” is default).



3. Press the [ **ENTER** ] soft key to store the selected level.
4. Press the [ **CLEAR** ] key to return to radio operation.

## 16.4 KEY BEEP

This selection is used to select the beep tone volume level when a key is pressed.

1. Press & hold [  ]  $\Rightarrow$  "CONFIGURATION"  $\Rightarrow$  "KEY BEEP"

2. Rotate the **DIAL/ENT** knob to select the desired level. The beep level can be set from "1" to "7", or "OFF" ("4" is default).

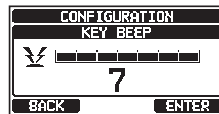

3. Press the [ENTER] soft key to store the selected level.
4. Press the [CLEAR] key to return to radio operation.

## 16.5 FOG ALERT TONE FREQUENCY

The function allows the radio to be setup to send the proper fog frequency which is dependent on vessel size, shown below:

- 70 - 200Hz: Vessel that are 660 feet (200 meters) or more in length
- 130 - 350Hz: Vessel that are 247.5 feet (75 meters) or more but less than 660 feet (200 meters) in length
- 250 - 700Hz: Vessel that are 66 feet (20 meters) or more but less than 247.5 feet (75 meters) in length
- 250 - 700Hz: Vessel that are 39.6 feet (12 meters) or more but less than 66 feet (20 meters) in length

1. Press & hold [  ]  $\Rightarrow$  "CONFIGURATION"  $\Rightarrow$  "FOG FREQUENCY"

2. Rotate the **DIAL/ENT** knob to select the desired level. The frequency level can be set from "200Hz" to "850Hz" ("400Hz" is default).

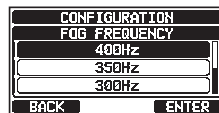

3. Press the [ENTER] soft key to store the selected setting.
4. Press the [CLEAR] key to return to radio operation.

### NOTE

By default, the radio Fog frequency is set to 400 Hz. In most cases this frequency should not be changed unless the vessel is very large.

## 16.6 LISTEN BACK

While in PA, FOG HORN, or HORN mode, toggle the listen back function between ON and OFF.

1. Press & hold [  ] ⇒ **“CONFIGURATION”** ⇒ **“LISTEN BACK”**
2. Rotate the **DIAL/ENT** knob to select **“OFF”** or **“ON”** (“ON” is default).
3. Press the [ **ENTER** ] soft key to store the selected setting.
4. Press the [ **CLEAR** ] key to return to radio operation.

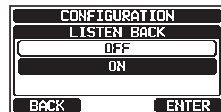

## 16.7 STATION NAME

This function allows you to change the name of the radio or second station microphone.

1. Press & hold [  ] ⇒ **“CONFIGURATION”** ⇒ **“STATION NAME”**

2. With the second station microphone connected, rotate the **DIAL/ENT** knob to select the unit to be named, then press the [ **SELECT** ] soft key.
3. Rotate the **DIAL/ENT** knob to select to scroll through the first letter of the new station name.
4. Press the [ **SELECT** ] soft key to store the first letter in the name and step to the next letter to the right.
5. Repeat steps 3 and 4 until the name is complete. The name can consist of up to ten characters, and if you do not use all ten characters, select “→” to move to the next space. This method can also be used to enter a blank space in the name.



If a mistake was made entering in the station name, rotate the **DIAL/ENT** knob to select “←” or “→”, press the [ **SELECT** ] soft key until the wrong character is selected, then perform steps 3 and 4.

6. When finished entering the station name (using ten characters or less), press the [ **FINISH** ] soft key to advance to the second station name entry.
7. Rotate the **DIAL/ENT** knob to select **“SSM-70H”**, then press the [ **SELECT** ] soft key.
8. Rotate the **DIAL/ENT** knob to select to scroll through the first letter of the new station name.





- Press the **[SELECT]** soft key to store the first letter in the name and step to the next letter to the right.



- Repeat steps 8 and 9 until the name is complete. The name can consist of up to ten characters, and if you do not use all ten characters, select “→” to move to the next space. This method can also be used to enter a blank space in the name.

If a mistake was made entering in the station name, rotate the **DIAL/ENT** knob to select “←” or “→”, press the **[SELECT]** soft key until the wrong character is selected, then perform steps 8 and 9.

- When finished entering the station name (using ten characters or less), press the **[FINISH]** soft key.
- Press the **CLEAR** key to return to radio operation.

## 16.8 SOFT KEYS

From this menu, you can assign desired functions to each soft key from numbers 01 to 12. You can also set how long the soft key icon will be displayed after the corresponding soft key is pressed.

### 16.8.1 Key Assignment

- Press & hold **[MENU/SET]** → “**CONFIGURATION**” → “**SOFT KEY**”

- Rotate the **DIAL/ENT** knob to select “**KEY ASSIGNMENT**”, then press the **[SELECT]** soft key.

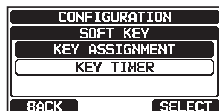





















- Rotate the **DIAL/ENT** knob to select the key number to be programmed, and press the **[SELECT]** soft key.



- Rotate the **DIAL/ENT** knob to select a new function to be assigned, and press the **[ENTER]** soft key. Available functions are listed below. By selecting “**NONE**” the soft key assignment is removed.



- Repeat steps 3 and 4 to program other soft keys. The VHF radio functions can be assigned to a maximum of 12 soft keys.
- Press the **[CLEAR]** key to return to radio operation.

DISPLAY	SOFT KEY ICON	FUNCTION
NONE	–	–
TX HI/LO		Selects transmit power
WX/CH		Switches channels between weather and marine
SCAN		Turns the scanning function ON or OFF
MULTI WATCH		Starts and stops dual watch or triple watch scan
MARK POSITION		Marks the current position for a “Waypoint”
SCAN MEMORY		Add or remove channels from memory channel scan
PRESET		Programs or deletes the preset memory channel
MAN OVERBOARD		Marks the position where a person falls overboard
NOISE CANCEL		Enables the noise canceling settings display
CH NAME		Edit channel names
SCRAMBLER		Configures the secret communication settings.
COMPASS		Enables the “Compass” display
NAVIGATION		Enables the “Waypoint” or “Route” navigation display
FOG HORN		Select FOG HORN mode
INTERCOM		Activates intercom between radio and RAM4 microphone (optional SSM-70H (RAM4) or SSM-71H (RAM4W) required)
GPS LOGGER		Starts and stops logging position data
AIS DISPLAY		Shows the “AIS” display
HORN BUTTON		Activates the Fog Horn function
PUBLIC ADDRESS		Switches channels between weather and marine
RX SENSE		Toggles between LOCAL and DISTANCE
DISPLAY MODE		Switches the display between daytime and nighttime mode

## 16.8.2 Key Timer

1. Press & hold [  ] → “CONFIGURATION” → “SOFT KEY”
2. Rotate the **DIAL/ENT** knob to select “KEY TIMER”, then press the [SELECT] soft key.
3. Rotate the **DIAL/ENT** knob to select the desired time, default is 10 seconds.
4. Press the [ENTER] soft key to store the selected setting.
5. Press the [CLEAR] key to return to radio operation.

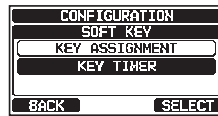

## 16.9 RESET

The memory and the setup categories may be reset independently, or the transceiver may be reset to the original factory settings.

1. Press & hold [  ] → “CONFIGURATION” → “RESET”
2. Rotate the **DIAL/ENT** knob to select the desired category from: “DSC/GM SETUP”, “WAYPOINT SETUP”, “CHANNEL SETUP”, “GPS SETUP”, “CONFIGURATION”, “FACTORY” (all settings\*<sup>1</sup> except the “MMSI” and “ATIS”\*<sup>2</sup> will be initialized), “USER MMSI”, or “ATIS CODE”\*<sup>2</sup>.

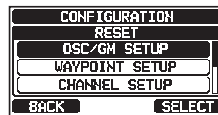

\*<sup>1</sup>(The Individual Directory is also cleared.)

\*<sup>2</sup>(GX2400GPS/E only)

For details on resetting “USER MMSI” and “ATIS CODE”, refer to “16.9.1 Reset the USER MMSI and ATIS CODE”.

3. Press the [SELECT] soft key.
4. Press the [YES] soft key. (To cancel, press the [NO] soft key.)
5. Press the [OK] soft key.
6. Press the [CLEAR] key to return to radio operation.



## 16.9.1 Reset the USER MMSI and ATIS CODE

If the MMSI number and ATIS\* code need to be reset. Please contact Standard Horizon to obtain the required reset codes.

\*(GX2400GPS/E only)

### To request the Reset Code

Contact Standard Horizon and confirm the following required information.

#### • The Information Necessary to obtain the Reset Code:

- Model name
- Serial number
- Current MMSI number and/or ATIS code  
(To check the MMSI number and ATIS code, refer to “8.6.1 Maritime Mobile Service Identity (MMSI)” or “20 ATIS SETUP”).
- Request codes for the MMSI number and/or the ATIS code  
(See “Checking the Request code” below).

#### • Contact Information

##### USA/Canada

E-mail: marinetech@yaesu.com

Telephone: (800) 767-2450

##### Europe

E-mail: service@yaesu.co.uk

Telephone: +44 (0)1962 866667

### Checking the Request code

1. Press & hold [  ] ⇒ “CONFIGURATION” ⇒ “RESET”

2. Rotate the **DIAL/ENT** knob to select the desired category. You can select either “**USER MMSI**”, or “**ATIS CODE**”\*, then press the [SELECT] soft key.  
\*(GX2400GPS/E only)



3. Press the [SELECT] soft key again.  
The request code will be displayed.

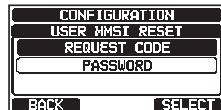

### NOTE

When resetting both “USER MMSI” and “ATIS CODE”, both request codes are required.

Resetting the USER MMSI and ATIS codes

Here is the procedure for resetting the USER MMSI and ATIS codes after obtaining the reset codes.

1. The RESET screen is displayed on step 2 in “**Checking the Request code**”.
2. Rotate the **DIAL/ENT** knob to select “**PASSWORD**”, then press the [**SELECT**] soft key.  
The password input screen will appear.
3. Press the [◀] or [▶] key to select the first digit of the reset password, then press the [**SELECT**] soft key to step to the next number.
4. Repeat steps 3 until the reset password is complete.  
If a mistake is made entering in the station name, press the [◀] or [▶] key to select “←” or “→”, press the [**SELECT**] soft key until the incorrect character is selected, then perform step 3.
5. Press the [**FINISH**] soft key.  
If the reset is successful, “**Completed!**” will appear on the screen.  
If the error message is displayed, input the reset code again.
6. Press the [**OK**] soft key to return to the setup screen.

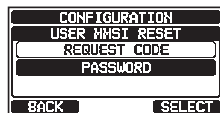
**NOTE**

The acquired reset password is available only one time.

**16.10 SUMMARY OF THE CONFIGURATION SETUP**

<b>Item</b>	<b>Description</b>	<b>Default Value</b>	<b>Page</b>
DISPLAY MODE	Toggles LCD display mode between daytime and nighttime mode	DAY MODE	97
DIMMER	Adjusts the backlight level of the LCD and keypad	7	97
CONTRAST	Adjusts the contrast of the LCD	15	97
KEY BEEP	Adjusts the volume of beep tone when a key is pressed	4	98
FOG ALERT TONE FREQUENCY	Sets the tone frequency of the fog horn	400Hz	98
LISTEN BACK	Turns on or off of listen back function	ON	99
STATION NAME	Sets the names of the radio and external devices	-	99
<b>SOFT KEY</b>			
KEY ASSIGNMENT	Sets the assignment of the soft keys	-	100
KEY TIMER	Sets the display time of the soft keys	10 sec	102
RESET	Initializes the memories and settings	-	102

## 17 CHANNEL FUNCTION SETUP

### 17.1 CHANNEL GROUP

This menu item allows you to selection of a channel group from USA, Canada\*, and International. Refer to section “9.7 CHANNEL GROUP” for details.

### 17.2 WEATHER ALERT (USA version only)

Enables/disables the NOAA Weather Alert function. The default setting is “ON”.

1. Press & hold [  ]  $\Rightarrow$  “CHANNEL SETUP”  $\Rightarrow$  “WX ALERT”

2. Rotate the **DIAL/ENT** knob to select “ON” or “OFF”.
3. Press the [ENTER] soft key to store the selected setting.
4. Press the [CLEAR] key to return to radio operation.

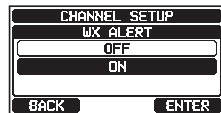

### 17.3 SCAN MEMORY

To be able to scan channels the scan memory must be programmed. This section designates channels to be stored into scan memory.

Refer to section “9.10.2 Programming Scan Memory” for details.

### 17.4 SCAN TYPE

This selection is used to select the scan mode between “MEMORY” and “PRIORITY”. The default setting is “PRIORITY”.

Refer to section “9.10.1 Selecting Scan Type” for details.

### 17.5 SCAN RESUME

This selection is used to set the time after a transmission ends before the radio starts to scan channels again. The default setting is 3 seconds.

1. Press & hold [  ]  $\Rightarrow$  “CHANNEL SETUP”  $\Rightarrow$  “SCAN RESUME”

2. Rotate the **DIAL/ENT** knob to select the desired resume time, default is 3 seconds. The resume time can be set to “1sec” through “5sec”.
3. Press the [ENTER] soft key to store the new setting.
4. Press the [CLEAR] key to return to radio operation.

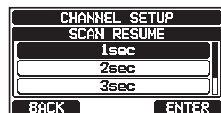

### 17.6 MULTI WATCH

This selection is used to select the watch type between “DUAL” and “TRIPLE”. The default setting is “DUAL”.

Refer to section “9.9 MULTI WATCH (TO PRIORITY CHANNEL)” for details.

## 17.7 PRIORITY CHANNEL

This procedure permits setting a different priority channel to be used when priority scanning. By default, the priority channel is set to Channel 16.

1. Press & hold [  ] ⇒ “CHANNEL SETUP” ⇒ “PRIORITY CHANNEL”

2. Rotate the **DIAL/ENT** knob to select the desired channel to be a priority.
3. Press the [ENTER] soft key to store the new setting.
4. Press the [CLEAR] key to return to radio operation.

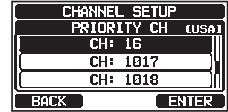

## 17.8 SUB CHANNEL

By default, the sub channel is set to Channel 9. This procedure permits assigning a different sub channel for instant access.

1. Press & hold [  ] ⇒ “CHANNEL SETUP” ⇒ “SUB CHANNEL”

2. Rotate the **DIAL/ENT** knob to select the desired channel to be a sub channel.
3. Press the [ENTER] soft key to store the new setting.
4. Press the [CLEAR] key to return to radio operation.

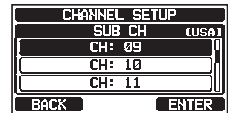

## 17.9 CHANNEL NAME

When the radio (“Normal”) mode is selected, the display will show a name under the channel number. This name describes the use of the channel. The name may be customized with the below procedure.

**Example:** CH69 PLEASURE to HOOKUP

1. Press & hold [  ] ⇒ “CHANNEL SETUP” ⇒ “CHANNEL NAME”

2. Rotate the **DIAL/ENT** knob to select the channel to be named, then press the [SELECT] soft key.
3. Press the [◀] or [▶] key to select the first letter of the new channel name.
4. Press the [SELECT] soft key to store the first letter of the name and step to the next letter to the right.



5. Repeat step 3 and 4 until the name is complete. The name can consist of up to 16 characters, if you do not use all 16 characters, select “→” to move to the next space. This method can also be used to enter a blank space in the name.



If a mistake is made entering the channel name, press the [◀] or [▶] key to select “←” or “→”, press the [SELECT] soft key until the incorrect character is selected, then perform steps 3 and 4.

6. When finished entering the channel name (using fifteen characters or less), press the [FINISH] soft key to save the name.
7. To enter the name of another channel, repeat the steps 2 through 6.
8. Press the [CLEAR] key to return to radio operation.



### NOTE

When “CHANNEL NAME” is assigned to a soft key, the channel name may be displayed directly by pressing the [NAME] soft key during radio operation.

## 17.10 RX LED DIMMER ADJUSTMENT

This menu selection adjusts the RX LED intensity.

1. Press & hold [  ] ⇒ “CHANNEL SETUP” ⇒ “RX LED DIMMER”
2. Rotate the **DIAL/ENT** knob to select the desired level (“7” is default). When “OFF” is selected, the lamp is turned OFF.
3. Press the [ENTER] soft key to store the selected level.
4. Press the [CLEAR] key to return to radio operation.

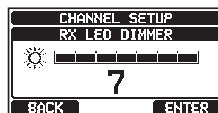

## 17.11 NOISE CANCELLATION

Enables/disables the Noise-canceling function of the transmitter and receiver independently.

1. Press & hold [  ] ⇒ “CHANNEL SETUP” ⇒ “NOISE CANCEL”
2. Rotate the **DIAL/ENT** knob to select “TX MODE”, then press the [SELECT] soft key.
3. Rotate the **DIAL/ENT** knob to select “ON” or “OFF”, then press the [ENTER] soft key.

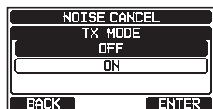
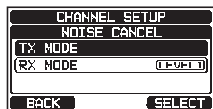

4. Rotate the **DIAL/ENT** knob to select “**RX MODE**”, then press the [**SELECT**] soft key.
5. Rotate the **DIAL/ENT** knob to select the noise level from “**LEVEL1**” through “**LEVEL4**” or “**OFF**”, then press the [**ENTER**] soft key.
6. Press the [**CLEAR**] key to return to radio operation.

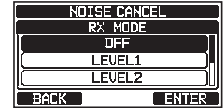

## 17.12 AUDIO FILTER OPERATION

This menu item allows you to select operation of the internal audio filter for the best acoustics in noisy environments. The default setting is “**NORMAL**”.

1. Press & hold [  ] ⇒ “**CHANNEL SETUP**” ⇒ “**AF PITCH CONTROL**”
2. Rotate the **DIAL/ENT** knob to select the desired filter operation.
3. Press the [**ENTER**] soft key to store the new setting.
4. Press the [**CLEAR**] key to return to radio operation.



## 17.13 SCRAMBLER SETUP

The voice scrambler function may only be enabled by your dealer.

Configure the voice scrambler setting. Two types of voice scrambler functions are available: the 4-code type (**CVS2500A** compatible) and the 32-code type (**FVP-42** compatible for Furuno Electric FM-4721).

### NOTE

- The voice scrambler function is not available with the factory default settings. Please contact your dealer to activate the voice scrambler function.
- This function is not available for CH16 and CH70.

1. Press & hold [  ] ⇒ “**CHANNEL SETUP**” ⇒ “**SCRAMBLER**”

2. Rotate the **DIAL/ENT** knob to select “**TYPE**”, then press the [**SELECT**] soft key.
3. Rotate the **DIAL/ENT** knob to select “**CVS2500**” or “**FVP-42**”, then press the [**ENTER**] soft key.

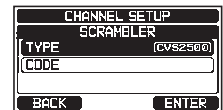
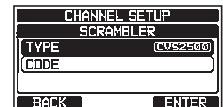

**NOTE:** Changing this setting will delete all scrambler codes set for each channel.

4. Rotate the **DIAL/ENT** knob to select “**CODE**”, then press the [**SELECT**] soft key.
5. Rotate the **DIAL/ENT** knob to select the channel to be scrambled, then press the [**SELECT**] soft key.  
**NOTE:** CH16 and CH70 cannot be used.
6. Rotate the **DIAL/ENT** knob to select the scrambler code. The scrambler code can be set from “**00**” to “**03**” or “**OFF**” (While FVP-42 is selected in step 3, the scrambler code can be set from “**00**” to “**31**” or “**OFF**”). When “**OFF**” is selected the voice scrambler is disabled.
7. Press the [**ENTER**] soft key to store the selected code.
8. Repeat steps 5 through 7 to set other channels.
9. Press the [**CLEAR**] key to return to radio operation.

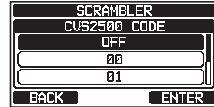
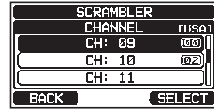
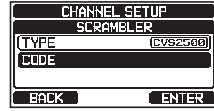

## 17.14 SUMMARY OF THE CANNEL FUNCTION SETUP

Item	Description	Default Value	Page
CHANNEL GROUP	Selects the channel group	(Depending on the transceiver version)	31
WEATHER ALERT (USA version only)	Turns the Weather Alert Function ON or OFF	OFF	106
SCAN MEMORY	Add or remove a channel from Scan Memory	-	34
SCAN TYPE	Select priority scan or memory scan	PRIORITY	34
SCAN RESUME	Sets the resume time of scanning	3 sec	106
MULTI WATCH	Selects Dual Watch or Triple Watch	DUAL	33
PRIORITY CHANNEL	Selects a priority channel	CH16	107
SUB CHANNEL	Selects a Sub Channel	CH09	107
CHANNEL NAME	Edit the name of memory channels	-	107
RX LED DIMMER	Adjusts the RX LED dimmer level	7	108
NOISE CANCEL	Turns on or off of noise cancelling function (independently available for transmission and reception)	OFF	108
AF PITCH CONTROL	Selects the audio filter operation	NORMAL	109
SCRAMBLER*	Configures the secret communication settings	TYPE: CVS2500 CORD: -	109

\*(The voice scrambler function is not available with the factory default settings. Please contact your dealer to activate the voice scrambler function.)

## 18 DSC SETUP

### 18.1 INDIVIDUAL DIRECTORY

The **GX2400** has a DSC directory that allows you to store a vessel or person's name, and the associated MMSI that you may wish to contact via individual calls, position requests and position report transmissions.

To transmit an individual call, program this directory with the information of the vessel you wish to contact, similar to a cellular phone's contact list.

Refer to section "**11.4.1 Setting up the Individual / Position Call Directory**" for details.

### 18.2 INDIVIDUAL REPLY

This menu item sets the radio to automatically (default setting) or manually respond to a DSC Individual call requesting you to switch to a working channel for voice communications. When "MANUAL" is selected, the MMSI of the calling vessel is shown allowing you to see who is calling. This function is similar to caller ID on a cellular phone.

Refer to section "**11.4.2 Setting up the Individual Call Reply**" for details.

### 18.3 INDIVIDUAL ACKNOWLEDGMENT

The radio can be setup to transmit a reply automatically (default), or set so the radio will not reply to an individual DSC call.

Refer to section "**11.4.3 Enabling the Individual Call Acknowledgment**" for details.

### 18.4 INDIVIDUAL RINGER

The radio can be setup to ring like a telephone to alert you that the radio has received a DSC individual call. The default ring time setting is 2 minutes, however this can be changed to 5, 10 or 15 seconds with the procedure below.

Refer to section "**11.4.6 Setting up the Individual Call Ringer**" for details.

### 18.5 GROUP DIRECTORY

For this function to operate, the same group MMSI must be programmed into all the DSC VHF radios within the group of vessels that will be using this feature.

Refer to section "**11.5.1 Setting up a Group Call**" for details.

## 18.6 POSITION REPLY

The **GX2400** can be set up to automatically (default setting) or manually send your position when requested by another vessel. This selection is important if you are concerned about someone polling the position of your vessel that you may not want to. In the manual mode you will see the MMSI (Maritime Mobile Service Identity Number) or persons name, shown on the display allowing you to choose whether or not to send your position to the requesting vessel. Refer to section “**11.6.1 Setting up a Position Request Reply**” for details.

## 18.7 AUTO POSITION POLLING

The **GX2400** has the capability to automatically poll and track seven vessels programmed into the individual directory. Refer to section “**11.8 AUTO POSITION POLLING**” for details.

## 18.8 AUTO POSITION INTERVAL

The time interval between automatic position polling request transmissions may be selected. Refer to section “**11.8.2 Setting up the Polling Time Interval**” for details.

## 18.9 AUTO CHANNEL CHANGE

When a DSC distress call, or an all ships (urgency or safety) call is received, the **GX2400** will automatically switch to Channel 16. The automatic switch time may be changed. The default selection is 30 seconds.

1. Press & hold [  ] → “DSC SETUP” → “AUTO CHANNEL CHANGE”

2. Rotate the **DIAL/ENT** knob to select the desired time, then press the [ENTER] soft key.
3. Press the [CLEAR] key to return to radio operation.

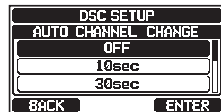

When “**OFF**” is selected, the “” icon will light up on the screen.

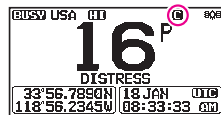

## 18.10 NO ACTION TIMER

If no key is pressed during the “MENU” or “DSC CALL” screen, the transceiver will automatically return to radio operation.

The default selection is 10 minutes.

1. Press & hold [  ] → “DSC SETUP” → “NO ACTION TIMER”

2. Rotate the **DIAL/ENT** knob to select the desired time, then press the [ENTER] soft key.
3. Press the [CLEAR] key to return to radio operation.



## 18.11 WAIT TIME FOR POSITION FIX

This menu allows you to select the maximum wait time till obtaining position information when receiving a distress call, POS Report call, or acknowledgment to POS request call.

The default selection is OFF.

1. Press & hold [  ] → “DSC SETUP” → “POS UNFIX WAITING TIME”

2. Rotate the **DIAL/ENT** knob to select the desired time, then press the [ENTER] soft key.
3. Press the [CLEAR] key to return to radio operation.



## 18.12 DSC BEEP

This feature allows the alarm beeps to be turned ON or OFF when a DSC call is received. The DSC calls that can be customized are: individual, group, all ships, position request, position report, geographical, polling, and DSC test.

Refer to section “11.5.4 Setting up the Group Call Ringer” for details.

## 18.13 SUMMARY OF THE DSC SETUP MENU

Item	Description	Default Value	Page
INDIVIDUAL DIRECTORY	Enter or edit addresses used for individual call	–	52
INDIVIDUAL REPLY	Selects a reply to an individual call	MANUAL	53
INDIVIDUAL ACK.	Selects the message to be sent automatically as an individual call acknowledgement	ABLE	54
INDIVIDUAL RING	Selects the ringing time when an individual call or a position request is received	2 min	57
GROUP DIRECTORY	Enter or edit addresses used for group calling	–	58
POSITION REPLY	Selects reply mode when receiving a position call	AUTO	63
AUTO POSITION POLLING	Selects the AUTO POSITION POLLING operation type	AUTO POS REPORT	70
AUTO POS INTERVAL	Selects the AUTO POSITION POLLING transmission interval	30 sec	70
AUTO CHANNEL CHANGE	Selects the delay time to automatically move to the requested channel after receiving a distress call, All Ship call, or group call	30 sec	112
NO ACTION TIMER	Selects the delay time before automatically returning to routine transceiver operation when no key is pressed	10 min	113
POS UNFIX WAITING TIME	Sets the maximum wait time to obtain position information when receiving a distress call, POS Report call, or acknowledgement to POS request call	OFF	113
DSC BEEP	Turns the audible alarm ON or OFF when receiving a DSC call	INDIVIDUAL CALL:ON GROUP CALL: ON ALL SHIPS: ON POS REQUEST: OFF POS REPORT: OFF GEOGRAPHICAL:ON DSC TEST CALL:OFF	113

## 19 GPS SETUP

The “GPS Setup” mode allows the parameters for the NMEA2000 or the NMEA-0183 or the Internal GPS receiver to be customized for your operating requirements.

### 19.1 ORDER OF PRIORITY

Specify the order of priority of the input devices to be used for obtaining location information. The default setting is “NMEA2000”.

1. Press & hold [  ]  $\Rightarrow$  “GPS SETUP”  $\Rightarrow$  “ORDER OF PRIORITY”
2. Rotate the **DIAL/ENT** knob to select “NMEA2000” or “NMEA-0183”, then press the [ENTER] soft key to save the new setting.
3. Press the [CLEAR] key to return to radio operation.



#### NOTE

The Internal GPS receiver is always set as the lowest priority.

### 19.2 COMPASS DIRECTION

This menu item selects the compass direction to be shown on the transceiver display. The default setting is “COURSE-UP”.

1. Press & hold [  ]  $\Rightarrow$  “GPS SETUP”  $\Rightarrow$  “COMPASS DIRECTION”
2. Rotate the **DIAL/ENT** knob to select the desired compass display to “COURSE-UP” or “NORTH-UP”.
3. Press the [ENTER] soft key to save the new setting.
4. Press the [CLEAR] key to return to radio operation.



### 19.3 LOCATION FORMAT

This menu item selects the coordinate system to be shown on the transceiver display. The default setting is “ddd°mm.mmmm”.

1. Press & hold [  ]  $\Rightarrow$  “GPS SETUP”  $\Rightarrow$  “LOCATION FORMAT”
2. Rotate the **DIAL/ENT** knob to select the desired coordinate system. The location format can be selected from “ddd°mm.mmmm” and “ddd°mm’s’s”.
3. Press the [ENTER] soft key to save the new setting.
4. Press the [CLEAR] key to return to radio operation.





## 19.4 TIME OFFSET

Sets the local time offset between UTC (Universal Time Coordinated) and local time shown on the display. The offset is added or subtracted from the time received from the GPS.

Refer to section “**8.8.1 Setting the GPS Time**” for details.

## 19.5 TIME AREA

This menu selection sets the display to show UTC time or local time with the offset.

Refer to section “**8.8.2 Setting the Time Area**” for details.

## 19.6 TIME FORMAT

This menu selection sets the display to show time in 12-hour or 24-hour format.

Refer to section “**8.8.3 Setting the Time Format**” for details.

## 19.7 UNITS OF MEASURE

This section sets the display units of speed, distance and altitude.

1. Press & hold [  ] → “GPS SETUP” → “UNIT OF MEASURE”

2. Rotate the **DIAL/ENT** knob to select the item to be set.

3. Press the [**SELECT**] soft key.

4. Rotate the **DIAL/ENT** knob to select the unit.

5. Press the [**ENTER**] soft key to store the new setting.

6. Press the [**CLEAR**] key to return to radio operation.

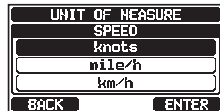
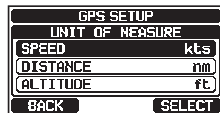

## 19.8 MAGNETIC VARIATION

This selection permits customization of the GPS COG (Course Over Ground) indication on the normal and compass pages, and BRG on the waypoint page.

Refer to section “**8.8.4 Setting COG to True or Magnetic**” for details.

### NOTE

Setting to “ON” is effective only when the RMC sentences with magnetic data are input from external devices such as a GPS chart plotter.

## 19.9 NMEA 0183 IN/OUT

### 19.9.1 Data Speed

This menu is utilized to set the NMEA 0183 baud rate of the GPS input (Yellow and Green wires) and DSC output (White and Brown wires). The default setting is 4800 bps.

When 38400 bps is selected the DSC sentences (DSC & DSE) are output on the Blue and Gray wires after a DSC distress, position request is received.

1. Press & hold [  ] ⇒ “GPS SETUP” ⇒ “NMEA 0183 IN/OUT”

2. Rotate the **DIAL/ENT** knob to select “**DATA SPEED**”, then press the [**SELECT**] soft key.

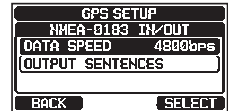

3. Rotate the **DIAL/ENT** knob to select the desired speed from “**4800bps**” and “**38400bps**”.
4. Press the [**ENTER**] soft key to save the new setting.
5. Press the [**CLEAR**] key to return to radio operation.

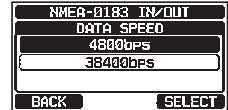

### 19.9.2 Output Sentences

This selection is utilized to set the NMEA output sentences of the transceiver. By default, the “GLL” and the “RMC” sentences are turned “ON”.

1. Press & hold [  ] ⇒ “GPS SETUP” ⇒ “NMEA 0183 IN/OUT”

2. Rotate the **DIAL/ENT** knob to select “**OUTPUT SENTENCES**”, then press the [**SELECT**] soft key.

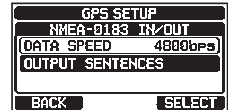

3. Rotate the **DIAL/ENT** knob to select the desired sentence type, then press the [**SELECT**] soft key.

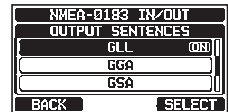

4. Rotate the **DIAL/ENT** knob to select “**ON**” or “**OFF**”.
5. Press the [**ENTER**] soft key to save the new setting.
6. Repeat steps 3 through 5 to set the other sentences.
7. Press the [**CLEAR**] key to return to radio operation.

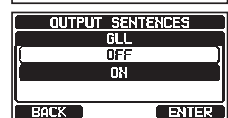

## NOTE

- Data output will be performed according to the data acquisition priority order setting of “ORDER OF PRIORITY”. Refer to section “**19.1 ORDER OF PRIORITY**” for details.
- When “UNIT POWER” of “OPTION GPS UNIT” is set to OFF, NMEA sentences will not be output. (OPTION GPS reception data will be output as is.)
- The output interval of each NMEA sentence depends on the output timing on the input device. However, sentences which include POS data will be output at intervals of two seconds or less.
- When all sentences are set to be output, depending on the baud rate, not all sentences can be output at intervals of one second or less. GSA and GSV sentences will be output at intervals of around five seconds.

## 19.10 INTERNAL GPS UNIT

Change the internal GPS receiver settings. (The settings in this section are also valid when connecting the **SCU-38** External GPS Antenna to the internal GPS receiver.)

### 19.10.1 Position Data Output

Select the connection device to be used when outputting position data.

1. Press & hold [  ] ⇒ “GPS SETUP” ⇒ “INTERNAL GPS UNIT”

2. Rotate the **DIAL/ENT** knob to select “**POS DATA OUTPUT**”, then press the [SELECT] soft key.

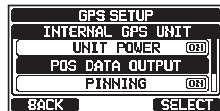

3. Rotate the **DIAL/ENT** knob to select “**NMEA 2000**” or “**NMEA 0183**”, then press the [SELECT] soft key.

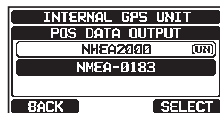

4. Rotate the **DIAL/ENT** knob to select “**OFF**” or “**ON**”.
5. Press the [ENTER] soft key to store the new setting.
6. Press the [CLEAR] key to return to radio operation.

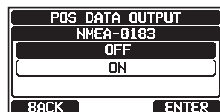

### 19.10.2 Pinning

This selection is utilized to enable or disable position updates when the vessel is not underway. The default setting is “ON”.

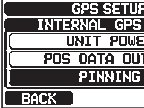
1. Press & hold [  ] ⇒ “GPS SETUP” ⇒ “INTERNAL GPS UNIT”
2. Rotate the **DIAL/ENT** knob to select “PINNING”, then press the [SELECT] soft key.
 
3. Rotate the **DIAL/ENT** knob to select “OFF” or “ON”.
 

ON: When pinning is turned ON, the transceiver will not update its position unless the ship’s speed is over 0.4 knot.

OFF: When the vessel is underway or stopped, the transceiver continuously updates its position. This improves accuracy of the position fix.

4. Press the [ENTER] soft key to save the new setting.
5. Press the [CLEAR] key to return to routine transceiver operation.

### 19.10.3 Differential GPS

This selection enables or disables differential GPS function by SBAS (Satellite Based Augmentation System) such as WAAS, EGNOS, MSAS and GAGAN. In some areas (Australia for example), the GPS reception can have problems enabling the SBAS. The default setting is “ON”.

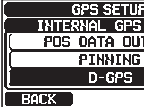
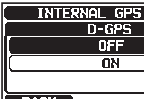
1. Press & hold [  ] ⇒ “GPS SETUP” ⇒ “INTERNAL GPS UNIT”
  2. Rotate the **DIAL/ENT** knob to select “D-GPS”, then press the [SELECT] soft key.
 
  3. Rotate the **DIAL/ENT** knob to select “OFF” or “ON”.
  4. Press the [ENTER] soft key to store the new setting.
  5. Press the [CLEAR] key to return to radio operation.
- 

### 19.10.4 Logger Interval

1. Press & hold [  ] ⇒ “GPS SETUP” ⇒ “OPTION GPS UNIT”

2. Rotate the **DIAL/ENT** knob to select “**LOGGER INTERVAL**”, then press the [SELECT] soft key.



3. Rotate the **DIAL/ENT** knob to select the desired time and press the [ENTER] soft key.

**NOTE:** Log time for each logger interval setting

5 sec: Aprox. 8 hours

15 sec: Aprox. 25 hours

30 sec: Aprox. 50 hours

1 min: Aprox. 100 hours

2 min: Aprox. 200 hours

5 min: Aprox. 500 hours

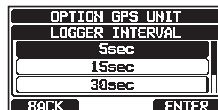

4. Press the [CLEAR] key to return to radio operation.

### 19.10.5 Log Erase

1. Press & hold [  ] ⇒ “GPS SETUP” ⇒ “OPTION GPS UNIT”

2. Rotate the **DIAL/ENT** knob to select “**LOG ERASE**”, then press the [SELECT] soft key.

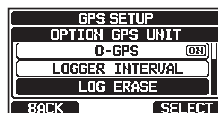

3. Press the [YES] soft key. (To cancel, press the [NO] soft key.)



4. Press the [OK] soft key.

5. Press the [CLEAR] key to return to radio operation.



**19.11 SUMMARY OF THE GPS SETUP**

<b>Item</b>	<b>Description</b>	<b>Default Value</b>	<b>Page</b>
ORDER OF PRIORITY	Sets the priority order of the connection devices when obtaining position information	NMEA-2000	115
COMPASS DIRECTION	Selects the compass direction to be displayed	COURSE-UP	115
LOCATION FORMAT	Selects the coordinate system to be displayed	ddd°mm.mmmm	115
TIME OFFSET	Sets the offset time from UTC (available only when "LOCAL" is selected in the item "TIME AREA")	00:00	116
TIME AREA	Selects the time location to be displayed, from UTC or local	UTC	116
TIME FORMAT	Selects the time format to be displayed, 12-hour or 24-hour (fixed to "24H" when "UTC" is selected in the item "TIME AREA")	24hour	116
UNITS OF MEASURE	Selects the unit of measure when displaying speed, distance, and altitude	SPEED: kts (knots) DISTANCE: nm (nautical mile) ALTITUDE: ft (feet)	116
MAGNETIC VARIATION	Enables/disables the magnetic variation function	OFF	116
<b>NMEA 0183 IN/OUT</b>			
DATA SPEED	Sets the NMEA 0183 data speed	4800bps	117
OUTPUT SENTENCES	Enables/disables NMEA sentences	GLL: OFF GGA: OFF GSA: OFF GSV: OFF RMC: OFF DSC/DSE: OFF	117
<b>INTERNAL GPS UNIT</b>			
POS DATA OUTPUT	Selects the connection device when outputting position data	NMEA 2000: OFF NMEA-0183: OFF	118
PINNING	Turns on or off GPS position updates for vessel not underway	ON	119
D-GPS	Turns SBAS ON or OFF	ON	119
LOGGER INTERVAL	Selects the interval time of logging	2 min	120
LOG ERASE	Erases the log data	-	120

## 20 ATIS SETUP

The **GX2400GPS/E** supports the ATIS (Automatic Transmitter Identification System) used in Inland waterways in Europe. When enabled ATIS mode transmits a unique ATIS code each time the PTT switch is released at the end of a transmission.

Users should check with their local marine regulatory authority in their country for assistance in obtaining an ATIS code.

### WARNING

**The ATIS code can be inputted only once, please be careful not to input the incorrect ATIS code.** If the ATIS code needs to be reset, please contact Standard Horizon to obtain the required reset code. Refer to section “**16.9.1 Reset the USER MMSI and ATIS CODE**”.

## 20.1 ATIS CODE PROGRAMMING

1. Press & hold [  ] ⇒ “ATIS SETUP” ⇒ “ATIS CODE”

2. Press the [◀] or [▶] key to select the first number of your ATIS, then press the [SELECT] soft key to step to the next number.



3. Repeat step 2 to set the ten digits of the ATIS.

4. If a mistake is made in entering the ATIS, press the [◀] or [▶] key to select “←” or “→”, press the [SELECT] soft key until the incorrect number is selected, then perform step 2.

5. When entering the number is complete, press the [FINISH] soft key. The Radio will ask you to input the ATIS number again. Perform steps 2 through 4 above.

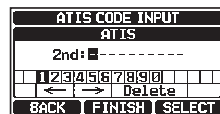

6. After the number has been entered twice, press the [FINISH] soft key to store the ATIS number in memory.

7. Press the [OK] soft key to return to radio operation.



## 20.2 ATIS CH GROUP

The **GX2400GPS/E** has ATIS feature may be turned ON or OFF for each channel group.

1. Press & hold [  ] → “**ATIS SETUP**” → “**ATIS GROUP**”

2. Rotate the **DIAL/ENT** knob to select the channel group (International, Canadian\*, or USA) to change the setting, and then press the [**SELECT**] soft key.



\*(Depending on the region setting.)

3. Rotate the **DIAL/ENT** knob to select “**ON**” or “**OFF**”.
4. Press the [**ENTER**] soft key to save the new setting.
5. To set the ATIS feature for another channel group, repeat steps 2 through 4.
6. Press the [**BACK**] soft key to return to radio operation.



### NOTE

- The “Scan” and “Dual Watch” features are not available on the channel group while the ATIS feature is turned on.
- The TX output power is set to “1 W” automatically on the following channels of the channel group while the ATIS feature is turned on.  
CH 06, 08, 10, 11, 12, 13, 14, 15, 17, 71, 72, 74, 75, 76, and 77



## 21 SSM-70H (RAM4) REMOTE MIC OPERATION

When a remote microphone is connected to the **GX2400**, all VHF, DSC, setup menus, AIS, Navigation, GM (Group Monitor) functions and PA/Fog modes can be remotely operated. The **SSM-70H** operation is the same as the **GX2400** except for the receiver audio volume setting and the squelch level setting. The reason for combined controlling is to make the operation of the radio and **SSM-70H** Remote Microphone uncomplicated. For specific operations of the **SSM-70H** Remote Microphone, review sections in the transceiver operating manual. The **SSM-70H** is supplied with 7 meters of routing cable and can be extended up to 21 meters using three 7-meter extension cables model **CT-100**. The Intercom feature can be used between the **SSM-70H** and the **GX2400**. In addition, speaker wires are supplied at the panel mount of the routing cable for external speakers to be connected for use in noisy environments.

### 21.1 REMOTE MIC CONTROLS

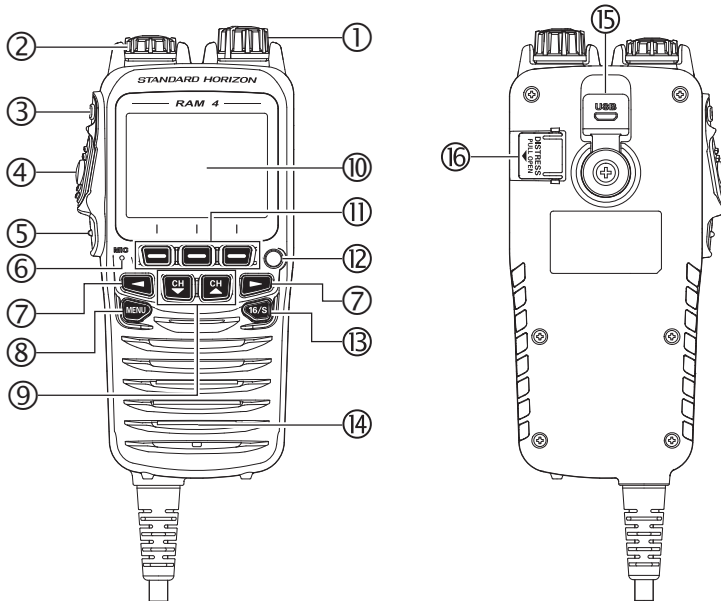

- ① **Power/VOL knob**  
Press and hold this knob to turn the transceiver and the remote mic ON or OFF. Rotate this knob to adjust the internal speaker volume.
- ② **DIAL/ENT knob**  
While the normal screen is displayed, rotate the **DIAL/ENT** knob to select your desired channel. While the MENU screen is displayed, rotate the knob to select the desired menu item.

#### **SECONDARY USE**

Press this knob to enter a selection in the MENU.

③ **SQL key** (Squelch control)

Press this key to activate the squelch adjusting mode. Press the **CH▲** or **CH▼** key to adjust the squelch threshold level.

④ **PTT (Push-To-Talk) switch**

Push this switch to enable the transmitter.

⑤ **CLEAR/🔒 key**

Press this key to cancel a menu selection. Press and hold this key to activate the key lock function. Press and hold this key again to deactivate the key lock function.

⑥ **Microphone**

The internal microphone transmits your voice while reducing background noise using Clear Voice Noise Reduction Technology.

**NOTE:** Position the microphone about 1.5 cm away from your mouth and speak in a normal voice.

⑦ **◀ & ▶ keys**

When the soft keys are displayed, press these keys to switch the function of the soft keys.

**SECONDARY USE**

While the MENU screen is displayed, press the keys to slide the on-screen menu to the right/left side.

⑧ **MENU key**

Press to access the MENU.

Press and hold this key to access the SETUP MENU.

⑨ **CH▼ & CH▲ keys**

These keys are used to change the operating channel.

Press the key momentarily, the channel increases or decreases one step.

Hold the key and the channel increases or decreases continuously.

**SECONDARY USE**

- While the MENU screen is displayed, press the key to slide the on-screen menu upward/downward.
- When in the PA or Fog mode, press the key to change the channel.

⑩ **Display**

Full dot matrix display, 222 by 162 pixels.

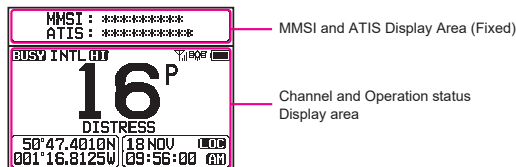

⑪ **Soft keys**

These three programmable keys can be customized utilizing the setup menu.

Press one of these keys, to display the key functions at the bottom of the display. Refer to section “**21.2 RAM4 SOFT KEY ASSIGNMENT**” for details.

**12 Strobe Light**

When the [**STROBE**] soft key is pressed, the internationally recognized Morse Code “S.O.S” message will light and flash repeatedly.

From MENU → SETUP → CONFIGURATION → STROBE LED, the strobe light may be set to one option from: “CONTINUOUS”, “SOS”, “BLINK 1”, “BLINK 2” or “BLINK 3”.

**13 16/S key**

Pressing this key immediately reverts to channel 16 from any channel location. Holding down this key recalls the SUB channel (The default setting is channel 9). Press this key again to revert to the previously selected working channel.

**14 Speaker**

The internal speaker is located here.

**15 DATA jack**

Use the micro USB type B jack for **SSM-70H (RAM4)** firmware updates.







**NOTE:** When the DATA jack is securely covered with the rubber cap, the SSM-70H meets the waterproof performance.















**16 DISTRESS key**

This key is used to send a DSC distress call. Refer to section “**11 DIGITAL SELECTIVE CALLING (DSC)**”.

**21.2 RAM4 SOFT KEY ASSIGNMENT**

From this menu, desired functions may be assigned to each **RAM4** soft key from numbers 01 to 12. Also, the duration the soft key icon will be displayed after the corresponding soft key is pressed may be set. The keys may be setup to control the following functions:

DISPLAY	SOFT KEY ICON	FUNCTION
NONE	-	-
TX HI/LO		Selects transmit power
WX/CH		Switches channels between weather and marine
SCAN		Turns the scanning function ON or OFF
MULTI WATCH		Starts and stops dual watch or triple watch scan
MARK POSITION		Marks the current position for a “Waypoint”
SCAN MEMORY		Add or remove channels from memory channel scan
PRESET		Programs or deletes the preset memory channel

DISPLAY	SOFT KEY ICON	FUNCTION
MAN OVERBOARD		Marks the position where a person falls overboard
NOISE CANCEL		Enables the noise canceling settings display
CH NAME		Edit channel names
STROBE		Turns on or off the strobe LED.
SCRAMBLER		Configures the secret communication settings.
COMPASS		Enables the "Compass" display
NAVIGATION		Enables the "Waypoint" or "Route" navigation display
FOG HORN		Select FOG HORN mode
INTERCOM		Activates intercom between radio and RAM4 microphone (optional SSM-70H (RAM4) or SSM-71H (RAM4W) required)
GPS LOGGER		Starts and stops logging position data
AIS DISPLAY		Shows the "AIS" display
HORN BUTTON		Activates the Fog Horn function
PUBLIC ADDRESS		Switches channels between weather and marine
RX SENSE		Toggles between LOCAL and DISTANCE
DISPLAY MODE		Switches the display between daytime and nighttime mode

## NOTE

Soft key functions may be assigned individually for the transceiver and the optional **SSM-70H (RAM4)** remote microphone.

### 21.2.1 Key Assignment

Customize the functions of **SSM-70H (RAM4)** remote microphone soft keys for personal preferences.

**NOTE:** It is necessary to make the settings using the keys or the **DIAL/ENT** knob on the **SSM-70H (RAM4)**.

1.

Press & hold [  ] ⇒ **"CONFIGURATION"** ⇒ **"SOFT KEY"**  
(RAM4)

2. Rotate the **DIAL/ENT** knob to select “**KEY ASSIGNMENT**”, then press the [**SELECT**] soft key.
3. Rotate the **DIAL/ENT** knob to select the key number to be programmed, and press the [**SELECT**] soft key.
4. Rotate the **DIAL/ENT** knob to select a new function from the choices listed, and then press the [**ENTER**] soft key. When “**NONE**” is selected, the soft key assignment is removed.
5. Repeat steps 3 and 4 to program other soft keys.  
The VHF radio's functions can be assigned to the maximum of 12 soft keys.
6. Press the [**CLEAR/**] key to return to radio operation.

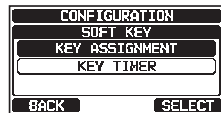

## 22 CONNECTING A USB DATA TERMINAL TO THE PC

The **GX2400** settings can be programmed using the USB terminal and PC Programming Software. You can also download the log data from the radio by using the PC Programming Software which may be downloaded from the Standard Horizon website. The PC Programming Software is compatible with Windows®. To connect a PC, use the supplied USB cable through the **DATA** jack of the **GX2400**.

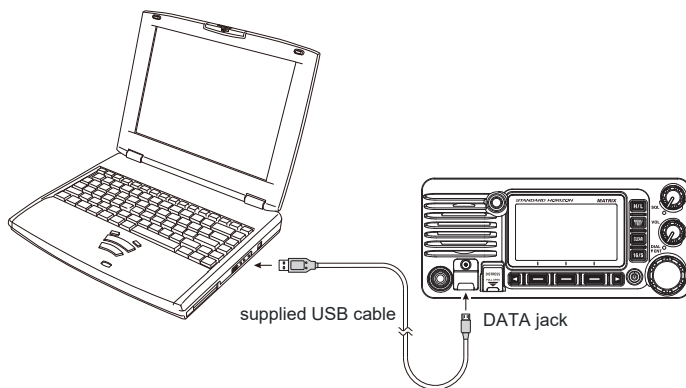

### CAUTION

The **DATA** jack is NOT designed to be waterproof when the cover is opened. Connect the radio and PC in a dry location.

If you have further questions, please feel free to contact Product Support at:  
 Phone: (800) 767-2450  
 Email: [marinetech@yaesu.com](mailto:marinetech@yaesu.com)

## 23 MAINTENANCE

The inherent quality of the solid-state components used in this transceiver will provide many years of continuous use. Taking the following precautions will prevent damage to the transceiver.

- Never key the microphone unless an antenna or suitable dummy load is connected to the transceiver.
- Ensure that the supply voltage to the transceiver does not exceed 16 VDC or fall below 11 VDC.
- Use only STANDARD HORIZON approved accessories and replacement parts.

### 23.1 REPLACEMENT PARTS

Occasionally an owner needs a replacement mounting bracket or knob. These can be ordered from your Dealer.

Commonly requested parts, and their part numbers are listed below.

- **DC Power Cord:** T9025406
- **VOL Knob:** RA6274300
- **SQL Knob:** RA6283700
- **DIAL/ENT Knob:** RA6271400
- **Mounting Bracket:** RA078400C
- **Mounting Bracket Knob:** RA0978600
- **Microphone Hanger:** RA0458800
- **SSM-70H (RAM4 Microphone) Routing Cable Assembly:** S8101512
- **USB Cable:** T9101648

### 23.2 FACTORY SERVICE

In the unlikely event that the transceiver fails to perform or needs servicing, please contact one of following:

#### In USA and Canada

**Standard Horizon**

**Attention Marine Repair Department**

6125 Phyllis Drive, Cypress, California 90630, U.S.A.

Telephone (800) 366-4566

#### In Europe

**Yaesu (UK) Ltd**

Unit 12, Sun Valley Business Park, Winnall Close

Winchester, Hampshire, SO23 0LB, U. K.

Telephone +44 (0)1962 866667

#### In Other Countries

Contact the dealer or the distributor.

## 23.3 TROUBLESHOOTING CHART

SYMPTOM	PROBABLE CAUSE	REMEDY
Transceiver fails to power up.	No DC voltage to the transceiver, or blown fuse.	a. Check the 12 VDC battery connections and the fuse. b. The  key needs to be pressed and held to turn the radio on.
Transceiver blows fuse when connected to power supply.	Reversed power wires.	Check the power cable for DC voltage, or replace the fuse (6A). Make sure the red wire is connected to the positive (+) battery post, and the black wire is connected to the negative (-) battery post. If the fuse still blows, contact your Dealer.
Popping or whining noise from the speaker while engine runs.	Engine noise.	Re-route the DC power cables away from the engine. Add noise suppressor on power cable. Change to resistive spark plug wires and/or add an alternator whine filter.
Sound is not emitted from the internal or external speaker.	Accessory cable.	Check the connections of the accessory cable. External speaker cable (WHITE/SHIELD) may be shorted together.
Receiving station reports low transmit power, even with transceiver set to HI power.	Antenna.	Have the antenna checked or test the transceiver with another antenna. If the problem persists, contact your Dealer for servicing.
“HI BATTERY” or “LO BATTERY” message appears when the power is turned on.	The power supply voltage is too high or too low.	Confirm that the connected power supply voltage is between 11 volts and 16.5 volts DC.
Your position is not displayed.	Accessory cable.	Check the accessory cable connection. Some GPS use the battery ground for NMEA connection.
	<b>SCU-38</b> cable.	Check the <b>SCU-38</b> cable connection.
	Setting of the GPS chart plotter.	Check the output signal format of the GPS navigation receiver. This radio requires NMEA 0183 and NMEA 2000 format with GLL, RMB, or RMC sentence as an output signal. If the GPS has a baud rate setting make sure to select 4800 and parity to NONE.

## 24 CHANNEL ASSIGNMENTS

### 24.1 GX2400GPS

VHF MARINE CHANNEL CHART							
CH	U	C	I	S/D	TX	RX	CHANNEL USE
01		X	X	D	156.050	160.650	Public Correspondence (Marine Operator)
1001	X			S	156.050		Port Operation and Commercial. VTS in selected areas
02		X	X	D	156.100	160.700	Public Correspondence (Marine Operator)
03		X	X	D	156.150	160.750	Public Correspondence (Marine Operator)
1003	<b>X</b>			<b>S</b>	<b>156.150</b>		<b>U.S. Government Only, Coast Guard</b>
04			X	D	156.200	160.800	Public Correspondence (Marine Operator), Port operation, ship movement
1004		X		S	156.200		Pacific coast: Coast Guard, East Coast: Commercial fishing
05			X	D	156.250	160.850	Public Correspondence (Marine Operator), Port operation, ship movement
1005	X	X		S	156.250		Port operation. VTS in Seattle
06	X	X	X	S	156.300		Inter-ship Safety
07			X	D	156.350	160.950	Public Correspondence (Marine Operator), Port operation, ship movement
1007	X	X		S	156.350		Commercial
08	X	X	X	S	156.400		Commercial (Inter-ship only)
09	X	X	X	S	156.450		Boater Calling channel, Commercial & Non-commercial (Recreational)
10	X	X	X	S	156.500		Commercial
11	X	X	X	S	156.550		Commercial. VTS in selected areas.
12	X	X	X	S	156.600		Port operation. VTS in selected areas.
13	X	X	X	S	156.650		Inter-ship Navigation Safety (Bridge-to-bridge)
14	X	X	X	S	156.700		Port operation. VTS in selected areas.
15	X			S	---	156.750	Environmental (Receive only)
15		X	X	S	156.750		Commercial, non-commercial, ship movement (1 W)
16	X	X	X	S	156.800		International Distress, Safety and Calling
17	X	X	X	S	156.850		State Controlled (1 W)
18			X	D	156.900	161.500	Port operation, ship movement
1018	X	X		S	156.900		Commercial
19			X	D	156.950	161.550	Port operation, ship movement
1019	X	X		S	156.950		Commercial (USA) Coast Guard (Canada)
1019			X	S	156.950		
2019			X	S	161.550		
20	X	X	X	D	157.000	161.600	Canadian Coast Guard Only, International: port operations and shipment
1020			X	S	157.000		
1020	X			S	157.000		Port operation
2020			X	S	161.600		
21			X	D	157.050	161.650	Port operation, ship movement
<b>1021</b>	<b>X</b>	<b>X</b>		<b>S</b>	<b>157.050</b>		<b>U.S. Government Only (USA) Canadian Coast Guard (Canada)</b>
2021		X			---	161.650	CMB Service



VHF MARINE CHANNEL CHART							
CH	U	C	I	S/D	TX	RX	CHANNEL USE
22			X	D	157.100	161.700	Port operation, ship movement
1022	X	X		S	157.100		US Coast Guard Liaison and Maritime Safety Information Broadcasts announced on channel 16 (USA) Canadian Coast Guard Liaison and Maritime Safety Information Broadcasts announced on channel 16 (Canada)
23		X	X	D	157.150	161.750	Public Correspondence (Marine Operator)
<b>1023</b>	<b>X</b>			<b>S</b>	<b>157.150</b>		<b>U.S. Government Only</b>
2023		X			---	161.750	CMB Service
24	X	X	X	D	157.200	161.800	Public Correspondence (Marine Operator)
25	X	X	X	D	157.250	161.850	Public Correspondence (Marine Operator)
2025		X			---	161.850	CMB Service
26	X	X	X	D	157.300	161.900	Public Correspondence (Marine Operator)
27	X	X	X	D	157.350	161.950	Public Correspondence (Marine Operator)
28	X	X	X	D	157.400	162.000	Public Correspondence (Marine Operator)
2028		X			---	162.000	CMB Service
60		X	X	D	156.025	160.625	Public Correspondence (Marine Operator)
61			X	D	156.075	160.675	Public Correspondence (Marine Operator), Port operation, ship movement
<b>1061</b>	<b>X</b>	<b>X</b>		<b>S</b>	<b>156.075</b>		<b>Public Coast: Coast Guard; East Coast: commercial fishing only</b>
62			X	D	156.125	160.725	Public Correspondence (Marine Operator), Port operation, ship movement
1062		X		S	156.125		Public Coast: Coast Guard; East Coast: commercial fishing only
63			X	D	156.175	160.775	Public Correspondence (Marine Operator), Port operation, ship movement
1063	X	X		S	156.175		Port Operation and Commercial. VTS in selected areas.
64		X	X	D	156.225	160.825	Public Correspondence (Marine Operator), Port operation, ship movement
<b>1064</b>	<b>X</b>	<b>X</b>		<b>S</b>	<b>156.225</b>		<b>Public Correspondence (Marine Operator), Port operation, ship movement</b>
65			X	D	156.275	160.875	Public Correspondence (Marine Operator), Port operation, ship movement
1065	X	X		S	156.275		Port Operations
66			X	D	156.325	160.925	Public Correspondence (Marine Operator), Port operation, ship movement
1066	X	X		S	156.325		Port Operations
67	X	X	X	S	156.375		US: Commercial. Used for Bridge-to-bridge communications in lower Mississippi River. Inter-ship only. Canada: Commercial fishing, S&R
68	X	X	X	S	156.425		Non-commercial (Recreational)
69	X	X	X	S	156.475		US: Non-commercial (Recreational), Canada: Commercial fishing only, International: Inter-ship, Port operations and Ship movement
70	X	X	X	S	---	156.525	Digital selective calling (voice communications not allowed)

VHF MARINE CHANNEL CHART								
CH	U	C	I	S/D	TX		RX	CHANNEL USE
71	X	X	X	S	156.575			US, Canada: Non-commercial (Recreational), International: Port operations and Ship movement
72	X	X	X	S	156.625			Non-commercial (Inter-ship only)
73	X	X	X	S	156.675			US: Port Operations, Canada: Commercial fishing only, International: Inter-ship, Port operations and Ship movement
74	X	X	X	S	156.725			US: Port Operations, Canada: Commercial fishing only, International: Inter-ship, Port operations and Ship movement
75	X	X	X	S	156.775			Port Operations (Inter-ship only) (1 W)
76	X	X	X	S	156.825			Port Operations (Inter-ship only) (1 W)
77	X	X		S	156.875			Port Operations (Inter-ship only) (1 W)
77			X	S	156.875			Port Operations (Inter-ship only)
78			X	D	156.925	161.525		Public Correspondence (Marine Operator), Port operation, ship-movement
1078	X	X		S	156.925			Non-commercial (Recreational)
1078			X	S	156.925			Port operation and Ship movement
2078			X	S	161.525			
79			X	D	156.975	161.575		Port operation and Ship movement
1079	X	X		S	156.975			Commercial
1079			X	S	156.975			Port operation and Ship movement
2079			X	S	161.575			
80			X	D	157.025	161.625		Port operation, ship movement
1080	X	X		S	157.025			Commercial
81			X	D	157.075	161.675		Port operation, ship movement
<b>1081</b>	<b>X</b>	<b>X</b>		<b>S</b>	<b>157.075</b>			<b>U.S. Government Only - Environmental protection operations. (USA) Canadian Coast Guard Only (Canada)</b>
82			X	D	157.125	161.725		Public Correspondence (Marine Operator), Port operation, ship movement
<b>1082</b>	<b>X</b>	<b>X</b>		<b>S</b>	<b>157.125</b>			<b>U.S. Government Only (USA) Canadian Coast Guard Only (Canada)</b>
83			X	D	157.175	161.775		Public Correspondence (Marine Operator)
<b>1083</b>	<b>X</b>	<b>X</b>		<b>S</b>	<b>157.175</b>			<b>U.S. Government Only (USA) Canadian Coast Guard Only (Canada)</b>
2083		X			---	161.775		CMB Service
84	X	X	X	D	157.225	161.825		Public Correspondence (Marine Operator)
85	X	X	X	D	157.275	161.875		Public Correspondence (Marine Operator)
86	X	X	X	D	157.325	161.925		Public Correspondence (Marine Operator)
87	X	X	X	S	157.375			Port operation, ship movement
88	X	X	X	S	157.425			Port operation, ship movement Commercial, Inter-ship Only

**NOTE:** Simplex channels, 1003, 1021, 1023, 1061, 1064, 1081, 1082 and 1083 CANNOT be lawfully used by the general public in U.S.A. waters.

## 24.2 GX2400GPS/E

CH	TX (MHz)	RX (MHz)	SIMPLEX/DUPLEX	LOW PWR	CHANNEL USE	
					All countries (except Germany)	Germany
01	156.050	160.650	DUPLEX	–	TELEPHONE	NAUTIK
02	156.100	160.700	DUPLEX	–	TELEPHONE	NAUTIK
03	156.150	160.750	DUPLEX	–	TELEPHONE	NAUTIK
04	156.200	160.800	DUPLEX	–	INTL	NAUTIK
05	156.250	160.850	DUPLEX	–	INTL	NAUTIK
06	156.300		SIMPLEX	LOW*4	SAFETY	SHIP-SHIP
07	156.350	160.950	DUPLEX	–	INTL	NAUTIK
08	156.400		SIMPLEX	LOW*4	COMMERCIAL	SHIP-SHIP
09	156.450		SIMPLEX	–	CALLING	NAUTIK
10	156.500		SIMPLEX	LOW*4	COMMERCIAL	SHIP-SHIP
11	156.550		SIMPLEX	LOW*4	VTS	SHIP-PORT
12	156.600		SIMPLEX	LOW*4	VTS	SHIP-PORT
13	156.650		SIMPLEX	LOW*4	BRG/BRG	SHIP-SHIP
14	156.700		SIMPLEX	LOW*4	VTS	SHIP-PORT
15	156.750		SIMPLEX	LOW	COMMERCIAL	ON-BOARD
16	156.800		SIMPLEX	–	DISTRESS	
17	156.850		SIMPLEX	LOW	SAR	ON-BOARD
18	156.900	161.500	DUPLEX	–	INTL	NAUTIK
19	156.950	161.550	DUPLEX	–	INTL	NAUTIK
1019	156.950		SIMPLEX	–	–	–
2019	161.550		SIMPLEX	–	–	–
20	157.000	161.600	DUPLEX	LOW*6	PORT OPR	NAUTIK
1020	157.000		SIMPLEX	–	–	–
2020	161.600		SIMPLEX	–	–	–
21	157.050	161.650	DUPLEX	–	INTL	NAUTIK
22	157.100	161.700	DUPLEX	–	INTL	NAUTIK
23	157.150	161.750	DUPLEX	–	INTL	
24	157.200	161.800	DUPLEX	–	TELEPHONE	
25	157.250	161.850	DUPLEX	–	TELEPHONE	
26	157.300	161.900	DUPLEX	–	TELEPHONE	
27	157.350	161.950	DUPLEX	–	TELEPHONE	
28	157.400	162.000	DUPLEX	–	TELEPHONE	
31*1	157.550	162.150	DUPLEX	LOW	NED JACHTHAV	–
37*2	157.850		SIMPLEX	LOW	YACHTING UK	–
60	156.025	160.625	DUPLEX	–	TELEPHONE	NAUTIK
61	156.075	160.675	DUPLEX	–	INTL	NAUTIK
62	156.125	160.725	DUPLEX	–	INTL	NAUTIK
63	156.175	160.775	DUPLEX	–	INTL	NAUTIK
64	156.225	160.825	DUPLEX	–	TELEPHONE	NAUTIK
65	156.275	160.875	DUPLEX	–	INTL	NAUTIK
66	156.325	160.925	DUPLEX	–	INTL	NAUTIK
67	156.375		SIMPLEX	–	BRG/BRG	NAUTIK
68	156.425		SIMPLEX	–	SHIP-SHIP	
69	156.475		SIMPLEX	–	PLEASURE	
70	–	156.525	SIMPLEX	–	DSC	
71	156.575		SIMPLEX	LOW*4	PLEASURE	SHIP-PORT
72	156.625		SIMPLEX	LOW*4	SHIP-SHIP	
73	156.675		SIMPLEX	–	PORT OPR	NAUTIK
74	156.725		SIMPLEX	LOW*4	PORT OPR	SHIP-PORT
75	156.775		SIMPLEX	LOW	–	SHIP-PORT
76	156.825		SIMPLEX	LOW	–	NAUTIK

CH	TX (MHz)	RX (MHz)	SIMPLEX/DUPLEX	LOW PWR	CHANNEL USE	
					All countries (except Germany)	Germany
77	156.875		SIMPLEX	LOW*4	PORT OPR	SHIP-SHIP
78	156.925	161.525	DUPLEX	–	INTL	NAUTIK
1078	156.925		SIMPLEX	–	–	–
2078	161.525		SIMPLEX	–	–	–
79	156.975	161.575	DUPLEX	–	INTL	NAUTIK
1079	156.975		SIMPLEX	–	–	–
2079	161.575		SIMPLEX	–	–	–
80	157.025	161.625	DUPLEX	–	INTL	NAUTIK
81	157.075	161.675	DUPLEX	–	INTL	NAUTIK
82	157.125	161.725	DUPLEX	–	INTL	TELEPHONE
83	157.175	161.775	DUPLEX	–	INTL	TELEPHONE
84	157.225	161.825	DUPLEX	–	TELEPHONE	
85	157.275	161.875	DUPLEX	–	TELEPHONE	
86	157.325	161.925	DUPLEX	–	TELEPHONE	
87	157.375		SIMPLEX	–	PORT OPR	
88	157.425		SIMPLEX	–	PORT OPR	
M*3	157.850		SIMPLEX	–	YACHTING UK	–
M2*3	161.425		SIMPLEX	–	YACHTING UK	–
L1*5	155.500		SIMPLEX	–	PLEASURE	–
L2*5	155.525		SIMPLEX	–	PLEASURE	–
L3*5	155.650		SIMPLEX	–	PLEASURE	–
F1*5	155.625		SIMPLEX	–	FISHING	–
F2*5	155.775		SIMPLEX	–	FISHING	–
F3*5	155.825		SIMPLEX	–	FISHING	–

**NOTE:** Country Channel assignment are different depending on the region.

\*1: Channel 31 is assigned to only BELGIUM and NETHERLAND.

\*2: Channel 37 is assigned to only NETHERLAND.

\*3: Channel M and M2 are assigned to only UNITED KINGDOM.

\*4: LOW Power setting for BELGIUM, NETHERLAND and GERMANY.

\*5: Channel L1, L2, L3, F1, F2 and F3 are assigned to only SWEDEN.

\*6: LOW Power setting for GERMANY.

## 25 SPECIFICATIONS

Performance specifications are nominal, unless otherwise indicated, and are subject to change without notice. Measured in accordance with TIA/EIA-603.

### ● GENERAL

Channels .....	All International, USA and Canadian* *(Depending on the region setting)
Normal Input Voltage .....	13.8 V DC
Operating Voltage Range .....	11 V to 16.5 V
Current Drain	
Standby .....	0.55 A
Receiver (at Maximum AF Output) .....	0.9 A
Transmit .....	5.0 A (Hi), 1.0 A (Lo)
NMEA 2000 Load Equivalency Number .....	LEN=1
DSC Transmitted Call Log .....	100
DSC Distress Call Log .....	50
DSC Received Call Log .....	100
Individual Directory .....	100
Group Directory .....	30
Waypoint Directory .....	250
Route Directory .....	30
Display Type .....	2.6" x 1.4" (66 x 36 mm) Full Dot Matrix (222 x 122 pixels)
Dimensions (W x H x D) .....	7.1" x 3.1" x 6.0" (180 x 80 x 152.6 mm)
Flush-Mount Dimensions (W x H x D) .....	6.3" x 2.6" x 6.2" (161 x 65 x 157 mm)
Weight .....	3.3 lbs (1.5 kg)

### ● TRANSMITTER

Frequency Range .....	156.025 MHz to 161.600 MHz (INTERNATIONAL)
RF Output Power .....	25 W (Hi), 1 W (Lo)
Conducted Spurious Emissions .....	Less than -80 dBc (Hi), -66 dBc (Lo)
Audio Response .....	within +1/-3dB of a 6 dB/Octave pre-emphasis characteristic at 300 to 3000 Hz
Audio Distortion .....	Less than 5 %
Modulation .....	16K0G3E (for Voice), 16K0G2B (for DSC)
Frequency Stability .....	±0.0003 % (-4 °F to +140 °F [-20 °C to +60 °C])
FM Hum and Noise .....	50 dB

**●RECEIVER (for Voice and DSC)**

Frequency Range .....	156.050 MHz to 163.275 MHz
Sensitivity	
20 dB Quieting .....	0.35 $\mu$ V
12 dB SINAD .....	0.30 $\mu$ V
Squelch Sensitivity (Threshold) .....	0.13 $\mu$ V
Modulation Acceptance Bandwidth .....	$\pm$ 7.5 kHz
Selectivity (Typical)	
Spurious and Image Rejection .....	80 dB for Voice (75 dB for DSC)
Intermodulation and Rejection .....	75 dB for Voice (75 dB for DSC)
Audio Output .....	4.5 W (at 4 ohms external speaker output)
Audio Response .....	within +1/-3dB of a 6 dB/Octave de-emphasis characteristic at 300 to 3000 Hz
Frequency Stability .....	$\pm$ 0.0003 % (-4 °F to +140 °F [-20 °C to +60 °C])
Channel Spacing .....	25 kHz
DSC Format .....	ITU-R M.493-15
Attenuator (Local) .....	Approx. 10 dB

**●RECEIVER (for AIS)**

Frequency .....	161.975 MHz (CH A), 162.025 MHz (CH B)
Sensitivity .....	0.5 $\mu$ V (at 12 dB SINAD)
Selectivity(Typical)	
Spurious and Image Rejection .....	70 dB
Intermodulation and Rejection .....	70 dB

**●INTERNAL GPS RECEIVER**

Receiver Channels .....	66 Channels
Sensitivity .....	Less than -147 dBm
Time to First Fix .....	1 minute typical (@Cold Start) 5 seconds typical (@ Hot Start)
Geodetic Datum .....	WGS84

***NMEA 0183 INPUT/OUTPUT Sentences***

4800 Baud selected:

NMEA 0183 Input (4800 baud) .....	GGA, GLL, GNS, RMC, GSA, & GSV
NMEA 0183 Output (4800 baud) .....	DSC, DSE, GGA, GLL, GNS, RMC, GSA & GSV
NMEA 0183-HS AIS Output (38400 baud) .....	VDM

38400 Baud selected:

NMEA 0183-HS Input (38400 baud) ...	GGA, GLL, GNS, RMC, GSA, & GSV
NMEA 0183-HS Output (38400 baud) .....	DSC, DSE, GGA, GLL, GNS, RMC, GSA & GSV
NMEA 0183-HS AIS Output (38400 baud) .....	VDM

## 25.1 DIMENSIONS

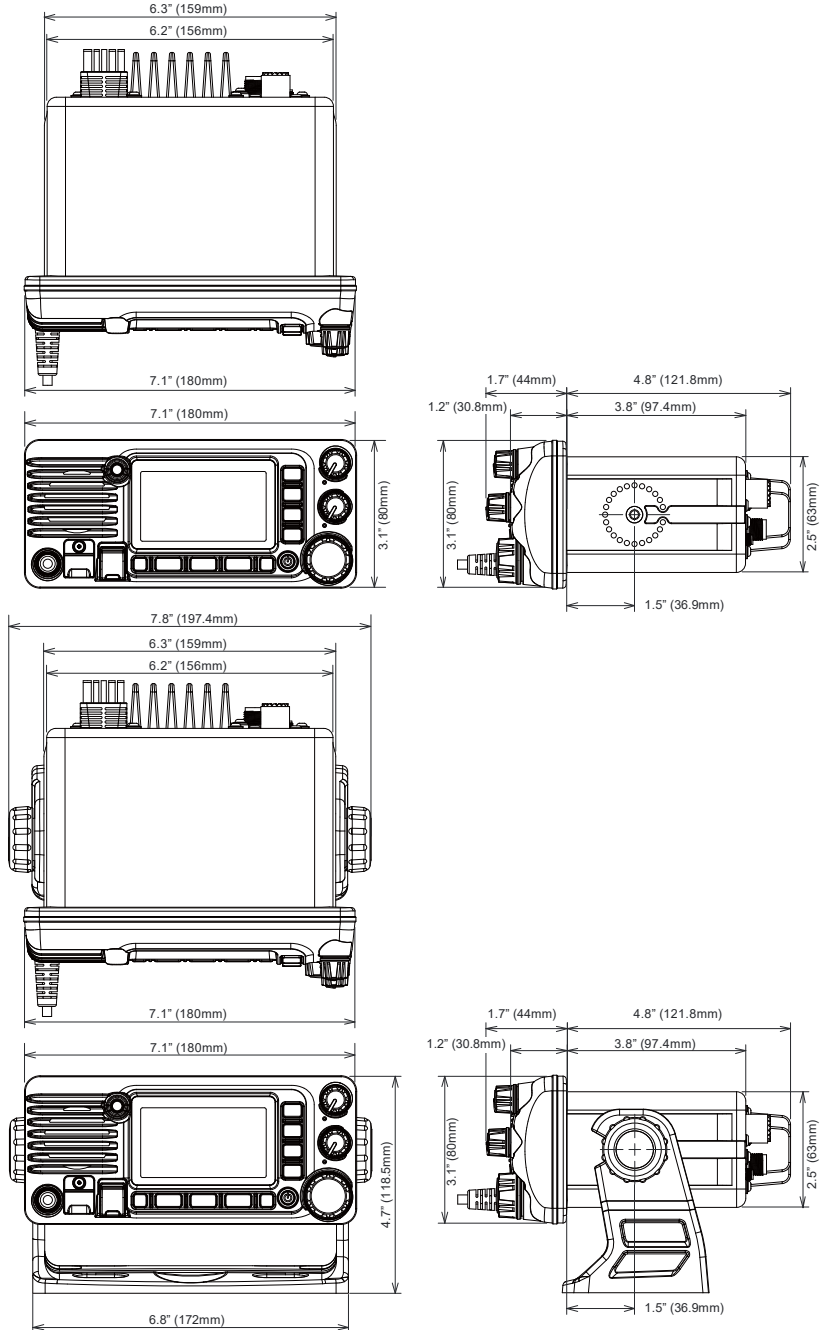

## 26 FCC RADIO LICENSE INFORMATION

Standard Horizon radios comply with the Federal Communication Commission (FCC) requirements that regulate the Maritime Radio Service.

### 26.1 STATION LICENSE

An FCC ship station license is no longer required for any vessel traveling in U.S. waters (except Hawaii) which is under 20 meters in length. However, any vessel required to carry a marine radio on an international voyage, carrying a HF single side band radiotelephone or marine satellite terminal is required to have a ship station license. FCC license forms, including applications for ship (605) and land station licenses can be downloaded via the Internet at <https://www.fcc.gov/fcc-form-605>. To obtain a form from the FCC, call (888) 225-5322.

### 26.2 RADIO CALL SIGN

Currently the FCC does not require recreational boaters to have a Ship Radio Station License. The USCG recommends the boats registration number and the state to be used when calling another vessel.

### 26.3 CANADIAN SHIP STATION LICENSING

Please click on the following link for licensing information:

[http://www.ic.gc.ca/eic/site/smt-gst.nsf/eng/h\\_sf01775.html](http://www.ic.gc.ca/eic/site/smt-gst.nsf/eng/h_sf01775.html)

The following link lists several Branches/Offices regarding licensing. Licensing depends on the region of operations.

<http://www.ic.gc.ca/eic/site/smt-gst.nsf/eng/sf01742.html>

### 26.4 FCC / IC INFORMATION

The following data pertaining to the transceiver is necessary to fill out the license application.

FCC Type Accepted .....	FCC Part 80
IC Type Accepted .....	RSS-182
Output Power .....	1 Watt (low) and 25 Watts (high)
Emission .....	16K0G3E, 16K0G2B
Frequency Range .....	156.025 to 163.275 MHz
FCC ID .....	K6630673X3D
IC .....	511B-30673X3D



## 27 FCC NOTICE

### NOTICE

Unauthorized changes or modifications to this equipment may void compliance with FCC Rules. Any change or modification must be approved in writing by STANDARD HORIZON.

### NOTICE

This equipment has been tested and found to comply with the limits for a Class B digital device, pursuant to Part 15 of the FCC Rules. These limits are designed to provide reasonable protection against harmful interference in a residential installation. This equipment generates, uses and can radiate radio frequency energy and, if not installed and used in accordance with the instructions, may cause harmful interference to radio communications. However, there is no guarantee that interference will not occur in a particular installation. If this equipment does cause harmful interference to radio or television reception, which can be determined by turning the equipment off and on, the user is encouraged to try to correct the interference by one or more of the following measures:

- Reorient or relocate the receiving antenna.
- Increase the separation between the equipment and receiver.
- Connect the equipment into an outlet on a circuit different from that to which the receiver is connected.
- Consult the dealer or an experienced radio/TV technician for help.

### WARNING

It is a violation of the rules of the Federal Communications Commission to input an MMSI that has not been properly assigned to the end user, or to otherwise input any inaccurate data in this device.

THIS DEVICE COMPLIES WITH PART 15 OF THE FCC RULES. OPERATION IS SUBJECT TO THE FOLLOWING TWO CONDITIONS: (1) THIS DEVICE MAY NOT CAUSE HARMFUL INTERFERENCE, AND (2) THIS DEVICE MUST ACCEPT ANY INTERFERENCE RECEIVED, INCLUDING INTERFERENCE THAT MAY CAUSE UNDESIRE OPERATION.

Changes or modifications to this device not expressly approved by YAESU U.S.A. could void the User's authorization to operate this device.

This device contains licence-exempt transmitter(s)/receiver(s) that comply with Innovation, Science and Economic Development Canada's licence-exempt RSS(s). Operation is subject to the following two conditions:

- (1) This device may not cause interference.
- (2) This device must accept any interference, including interference that may cause undesired operation of the device.

L'émetteur/récepteur exempt de licence contenu dans le présent appareil est conforme aux CNR d'Innovation, Sciences et Développement économique Canada applicables aux appareils radio exempts de licence. L'exploitation est autorisée aux deux conditions suivantes:

- (1) L'appareil ne doit pas produire de brouillage;
- (2) L'appareil doit accepter tout brouillage radioélectrique subi, même si le brouillage est susceptible d'en compromettre le fonctionnement.

Under Industry Canada regulations, this radio transmitter may only operate using an antenna of a type and maximum (or lesser) gain approved for the transmitter by Industry Canada. To reduce potential radio interference to other users, the antenna type and its gain should be so chosen that the equivalent isotropically radiated power (e.i.r.p.) is not more than that necessary for successful communication.

Conformément à la réglementation d'Industrie Canada, le présent émetteur radio peut fonctionner avec une antenne d'un type et d'un gain maximal (ou inférieur) approuvé pour l'émetteur par Industrie Canada. Dans le but de réduire les risques de brouillage radioélectrique à l'intention des autres utilisateurs, il faut choisir le type d'antenne et son gain de sorte que la puissance isotrope rayonnée équivalente (p.i.r.e.) ne dépasse pas l'intensité nécessaire à l'établissement d'une communication satisfaisante.

CAN ICES-3 (B) / NMB-3 (B)

## FCC APPLICATION

The antenna(s) used for this transmitter must be installed to provide a separation distance of at least 1.41 meters from all persons and must not be co-located or operating in conjunction with any other antenna or transmitter.

## ISED APPLICATION

The antenna(s) used for this transmitter must be installed to provide a separation distance of at least 1.76 meters from all persons and must not be co-located or operating in conjunction with any other antenna or transmitter.

## STANDARD HORIZON Limited Warranty

Limited Warranty is valid only in the country/region where this product was originally purchased.

### On-line Warranty Registration:

Thank you for buying STANDARD HORIZON products! We are confident your new radio will serve your needs for many years! Please register your product at [www.standardhorizon.com](http://www.standardhorizon.com) - Owner's Corner

### Warranty Terms:

Subject to the Limitations of the Warranty and the Warranty Procedures described below, YAESU MUSEN hereby warrants this product to be free of defects in materials and workmanship in normal use during the "Warranty Period." (the "Limited Warranty").

### Limitations of Warranty:

- A. YAESU MUSEN is not liable for any express warranties except the Limited Warranty described above.
- B. The Limited Warranty is extended only to the original end-use purchaser or the person receiving this product as a gift, and shall not be extended to any other person or transferee.
- C. Unless a different warranty period is stated with this YAESU product, the Warranty Period is three years from the date of retail purchase by the original end-use purchaser.
- D. The Limited Warranty is valid only in the country/region where this product was originally purchased.
- E. During the Warranty Period, YAESU MUSEN will, at its sole option, repair or replace (using new or refurbished replacement parts) any defective parts within a reasonable period of time and free of charge.
- F. The Limited Warranty does not cover shipping cost (including transportation and insurance) from you to us, or any import fees, duties or taxes.
- G. The Limited Warranty does not cover any impairment caused by tampering, misuse, failure to follow instructions supplied with the product, unauthorized modifications, or damage to this product for any reasons, such as: accident; excess moisture; lightning; power surges; connection to improper voltage supply; damage caused by inadequate packing or shipping procedures; loss of, damage to or corruption of stored data; product modification to enable operation in another country/purpose other than the country/purpose for which it was designed, manufactured, approved and/or authorized; or the repair of products damaged by these modifications.
- H. The Limited Warranty applies only to the product as it existed at the time of the original purchase, by the original retail purchaser, and shall not preclude YAESU MUSEN from later making any changes in design, adding to, or otherwise improving subsequent versions of this product, or impose upon YAESU MUSEN any obligation to modify or alter this product to conform to such changes, or improvements.
- I. YAESU MUSEN assumes no responsibility for any consequential damages caused by, or arising out of, any such defect in materials or workmanship.
- J. TO THE FULLEST EXTENT PERMITTED BY LAW, YAESU MUSEN SHALL NOT BE RESPONSIBLE FOR ANY IMPLIED WARRANTY WITH RESPECT TO THIS PRODUCT.
- K. If the original retail purchaser timely complies with the Warranty Procedures described below, and YAESU MUSEN elects to send the purchaser a replacement product rather than repair the "original product", then the Limited Warranty shall apply to the replacement product only for the remainder of the original product Warranty Period.
- L. Warranty statutes vary from state to state, or country to country, so some of the above limitations may not apply to your location.

### Warranty Procedures:

1. To find the Authorized STANDARD HORIZON Service Center in your country/region, visit [www.standardhorizon.com](http://www.standardhorizon.com). Contact the STANDARD HORIZON Service Center for specific return and shipping instructions, or contact an authorized STANDARD HORIZON dealer/distributor from whom the product was originally purchased.
2. Include proof of original purchase from an authorized STANDARD HORIZON dealer/distributor, and ship the product, freight prepaid, to the address provided by the STANDARD HORIZON Service Center in your country/region.
3. Upon receipt of this product, returned in accordance with the procedures described above, by the STANDARD HORIZON Authorized Service Center, all reasonable efforts will be expended by YAESU MUSEN to cause this product to conform to its original specifications. YAESU MUSEN will return the repaired product (or a replacement product) free of charge to the original purchaser. The decision to repair or replace this product is the sole discretion of YAESU MUSEN.

### Other conditions:

YAESU MUSEN'S MAXIMUM LIABILITY SHALL NOT EXCEED THE ACTUAL PURCHASE PRICE PAID FOR THE PRODUCT. IN NO EVENT SHALL YAESU MUSEN BE LIABLE FOR LOSS OF, DAMAGE TO OR CORRUPTION OF STORED DATA, OR FOR SPECIAL, INCIDENTAL, CONSEQUENTIAL, OR INDIRECT DAMAGES, HOW EVER CAUSED; INCLUDING WITHOUT LIMITATION TO THE REPLACEMENT OF EQUIPMENT AND PROPERTY, AND ANY COSTS OF RECOVERING, PROGRAMMING OR REPRODUCING ANY PROGRAM OR DATA STORED IN OR USED WITH THE YAESU PRODUCT.

Some Countries in Europe and some States of the USA do not allow the exclusion or limitation of incidental or consequential damages, or a limitation on how long an implied warranty lasts, so the above limitation or exclusions may not apply. This warranty provides specific rights, there may be other rights available which may vary between countries in Europe or from state to state within the USA.

This Limited Warranty is void if the label bearing the serial number has been removed or defaced.

cut here

## TEMPLATE for the GX2400 series

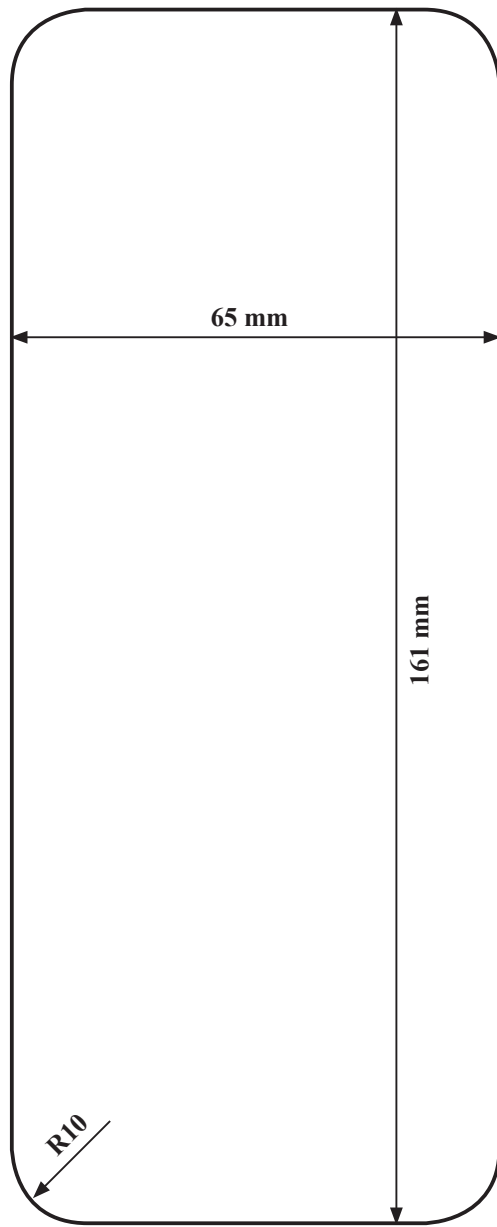

**Use this template to mark the location where the rectangular hole for the flush mount is to be cut.**



***YAESU*****Declaration of Conformity**

Type of Equipment:	25 Watt VHF/FM Marine Transceiver
Brand Name:	STANDARD HORIZON
Model Number:	GX2400GPS
Manufacturer:	YAESU MUSEN CO., LTD.
Address of Manufacturer:	Tennozu Parkside Building, 2-5-8 Higashi-Shinagawa, Shinagawa-ku, Tokyo 140-0002 Japan

This device complies with part 15 of the FCC Rules. Operation is subject to the following two conditions; (1) this device may not cause harmful interference, and (2) this device must accept any interference received, including interference that may cause undesired operation.

The technical documentation as required by the Conformity Assessment procedures is kept at the following address:

Company: Yaesu U.S.A.  
Address: 6125 Phyllis Drive, Cypress, CA 90630, U.S.A.  
Telephone: (714) 827-7600

**EU Declaration of Conformity**

We, Yaesu Musen Co. Ltd of Tokyo, Japan, hereby declare that this radio equipment GX2400GPS/E is in full compliance with EU Radio Equipment Directive 2014/53/EU. The full text of the Declaration of Conformity for this product is available to view at <http://www.yaesu.com/jp/red/>

***Disposal of Electronic and Electrical Equipment***

Products with the symbol (crossed-out wheeled bin) cannot be disposed as household waste.

Electronic and Electrical Equipment should be recycled at a facility capable of handling these items and their waste by-products.

Please contact a local equipment supplier representative or service center for information about the waste collection system in your country.

**ATTENTION – Conditions of usage**

This transceiver works on frequencies that are regulated and not permitted to be used without authorisation in the EU countries shown in this table. Users of this equipment should check with their local spectrum management authority for licensing conditions applicable for this equipment.



AT	BE	BG	CY	CZ	DE
DK	ES	EE	FI	FR	UK
EL	HR	HU	IE	IT	LT
LU	LV	MT	NL	PL	PT
RO	SK	SI	SE	CH	IS
LI	NO	–	–	–	–

# ***STANDARD HORIZON***

*Nothing takes to water like Standard Horizon*

Copyright 2020  
YAESU MUSEN CO., LTD.  
All rights reserved.

No portion of this manual may be  
reproduced without the permission of  
YAESU MUSEN CO., LTD.

## **YAESU MUSEN CO., LTD.**

Tennozu Parkside Building  
2-5-8 Higashi-Shinagawa, Shinagawa-ku, Tokyo 140-0002 Japan

## **YAESU USA**

6125 Phyllis Drive, Cypress, CA 90630, U.S.A.

## **YAESU UK**

Unit 12, Sun Valley Business Park, Winnall Close  
Winchester, Hampshire, SO23 0LB, U.K.

2001D-AC  
Printed in China

\*EM067N200\*  
E M 0 6 7 N 2 0 0