

STANDARD HORIZON

Nothing takes to water like Standard Horizon

HX407

UHF FM Marine Transceiver

Owner's Manual

WARNING! FCC RF EXPOSURE REQUIREMENTS

This Radio has been tested and complies with the Federal Communications Commission (FCC) RF exposure limits for Occupational Use/Controlled exposure environment. In addition, it complies with the following Standards and Guidelines:

- ❑ FCC 96-326, Guidelines for Evaluating the Environmental Effects of Radio-Frequency Radiation.
- ❑ FCC OET Bulletin 65 Edition 97-01 (2001) Supplement C, Evaluating Compliance with FCC Guidelines for Human Exposure to Radio Frequency Electromagnetic Fields.
- ❑ ANSI/IEEE C95.1-1992, IEEE Standard for Safety Levels with Respect to Human Exposure to Radio Frequency Electromagnetic Fields, 3 kHz to 300 GHz.
- ❑ ANSI/IEEE C95.3-1992, IEEE Recommended Practice for the Measurement of Potentially Hazardous Electromagnetic Fields - RF and Microwave.



WARNING:

This radio generates RF electromagnetic energy during transmit mode. This radio is designed for and classified as **Occupational Use Only**, meaning it must be used only during the course of employment by individuals aware of the hazards, and the ways to minimize such hazards. This radio is not intended for use by the General Population in an uncontrolled environment.



CAUTION:

To ensure that your exposure to RF electromagnetic energy is within the FCC allowable limits for occupational use, always adhere to the following guidelines:

- This radio is NOT approved for use by the general population in an uncontrolled exposure environment. This radio is restricted to occupational use, work related operations only where the radio operator must have the knowledge to control his or her RF exposure conditions.
- When transmitting, hold the radio in a vertical position with its microphone 1 inch (2.5 cm) away from your mouth and keep the antenna at least 1 inch (2.5 cm) away from your head and body.
- The radio must be used with a maximum operating duty cycle not exceeding 50%, in typical Push-to-Talk configurations.
DO NOT transmit for more than 50% of total radio use time (50% duty cycle). Transmitting more than 50% of the time can cause FCC RF exposure compliance requirements to be exceeded.

- SAR compliance for body-worn use was only demonstrated for the specific belt-clip (**CLIP-22**). Other body-worn accessories or configurations may NOT comply with the FCC RF exposure requirements and should be avoided.
- The **CLIP-22** belt-clip must be used in order to comply with the FCC/IC RF exposure requirements.
- Always use Standard Horizon authorized accessories.
- The information listed above provides the user with the information needed to make him or her aware of RF exposure, and what to do to assure that this radio operates with the FCC RF exposure limits of this radio.
- Electromagnetic Interference/Compatibility
During transmissions, this radio generates RF energy that can possibly cause interference with other devices or systems. To avoid such interference, turn off the radio in areas where signs are posted to do so. Do not operate the transmitter in areas that are sensitive to electromagnetic radiation such as hospitals, health care facilities, aircraft, and blasting sites.

1. GENERAL INFORMATION

1.1 INTRODUCTION

Congratulations on your purchase of the **HX407**! Whether this is your first portable marine UHF transceiver, or if you have other STANDARD HORIZON equipment, the STANDARD HORIZON organization is committed to ensuring your enjoyment of this high performance transceiver, which should provide you with many years of satisfying communications even in the harshest of environments. STANDARD HORIZON technical support personnel stands behind every product sold, and we invite you to contact us should you require technical advice or assistance.

The **HX407** is a JIS-8 / IPX8 (1.5 m (about 5Ft) for 30 minutes) Submersible 2-Watt portable two way marine transceiver with the capability to be programmed with CTCSS or DCS signalling by a dealer.

The **HX407** transmitter provides a full 5 Watt of transmit power and also is selectable to 1 Watt to assist the user in ensuring maximum battery life.

We appreciate your purchase of the **HX407**, and encourage you to read this manual thoroughly, so as to learn and fully understand the capabilities of the **HX407**.

1.2 RF EXPOSURE SAFETY STATEMENT

Your wireless handheld portable transceiver contains a low power transmitter. When the Push-To-Talk (**PTT**: ) button is pushed, the transceiver sends out radio frequency (RF) signals.

This device is authorized to operate at a duty factor not to exceed 50% (this corresponds to 50% transmission time and 50% reception time).

This transmitter and its antenna must maintain a separation distance of at least 1 inch (2.5 cm) from your face. Speak in a normal voice, with the antenna pointed up and away from the face at the required separation distance.

Use only the supplied antenna. Unauthorized antennas, modifications, or attachments could damage the transmitter.

2. ACCESSORIES

2.1 PACKING LIST

When the package containing the transceiver is first opened, please check it for the following contents:

- **HX407** Transceiver
- **SRA-14G/SRA-14H/SRA-14J** Antenna
Antenna Gain -2.5 dBi, Impedance 50 ohm
- **FNB-115LI** 7.4 V Li-Ion Battery Pack
- **CD-50** Charger Cradle for **HX407**
- **PA-45B** 120VAC Wall Charger for **CD-50**
- Belt Clip
- Hand Strap
- Owner's Manual

2.2 OPTIONS

MH-73A4B	Speaker/Microphone
MH-57A4B	Mini Speaker/Microphone
SSM-64A	VOX Headset
SSM-55A	Earpiece/Microphone
CN-3	Radio-to-Ship's Antenna Adapter
CD-50	Charger Cradle
FNB-115LI	7.4 V Li-Ion Battery Pack
FBA-42	Alkaline Battery Case
PA-45B/C/U [※]	AC Wall Charger for the FNB-115LI
E-DC-30	DC Cable with 12 V Cigarette Lighter Plug
SAD-1460	6-Unit Multi Charger

※: “**B**” suffix is for use with 120 VAC (Type-A plug), “**C**” suffix is for use with 230 VAC (Type-C plug), and “**U**” suffix is for use with 230 VAC (Type-BF plug).

Note: Before operating the **HX407** for the first time, it is recommended that the battery be charged. Please see section “**3.3.3 BATTERY CHARGING**” for details.

3. GETTING STARTED

3.1 RADIO CARE

CAUTION

Before following the instructions below, insure the battery pack is in place and firmly connected. Care must be taken if the radio was dropped and a close inspection may be needed to insure the radio case and gaskets are in adequate condition.

The design of the **HX407** allows water to enter between the radio and the battery pack, however waterproof performance is not compromised.

After using the **HX407** in salt water environment is recommended to clean the radio with fresh water by rinsing the battery and radio (separately) under a sink facet or by dunking in a fresh water. After washing, use a soft cloth to thoroughly dry all parts of the radio and battery.

This will keep the radio parts and the battery clean and in top operating condition.

3.2 BELT CLIP INSTALLATION AND REMOVAL

- To install the Belt Clip: align the Belt Clip to the groove of the Battery pack, then press the Belt Clip downward until it locks in place with a “Click.”
- To remove the Belt Clip: press the Belt Clip Tab away from the battery pack to unlock the Belt Clip, then slide the Belt Clip upward to remove it.

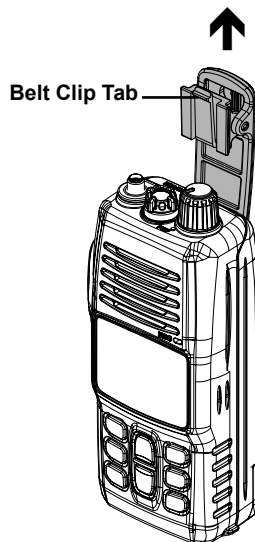
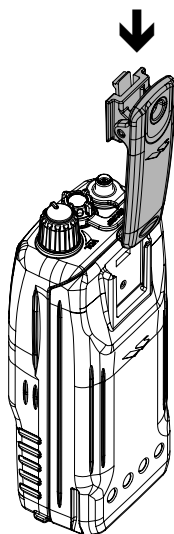

3.3 BATTERIES AND CHARGERS

If the radio has never been used, or its charge is depleted, it may be charged by connecting the **CD-50** Charger Cradle with the **PA-45B** Battery Charger, as shown in the illustration. If 12V DC power is available, the supplied **E-DC-30** DC Cable with 12 V Cigarette Lighter Plug may be used for charging the battery. The **PA-45B** and **E-DC-30** will charge a completely discharged **FNB-115LI** battery pack in approximately 3 hours.

The **FNB-115LI** is a high performance Li-Ion battery providing high capacity in a compact package.

CAUTION

To avoid risk of explosion and injury, **FNB-115LI** battery pack should only be removed, charged or recharged in non-hazardous environments.

3.3.1 BATTERY SAFETY

Battery packs for your transceiver contain Li-Ion batteries. This type of battery stores a charge powerful enough to be dangerous if misused or abused, especially when removed from the transceiver. Please observe the following precautions:

DO NOT SHORT BATTERY PACK TERMINALS: Shorting the terminals that power the transceiver can cause sparks, severe overheating, burns, and battery cell damage. If the short is of sufficient duration, it is possible to melt battery components. Do not place a loose battery pack on or near metal surfaces or objects such as paper clips, keys, tools, etc. When the battery pack is installed on the transceiver, the terminals that transfer current to the transceiver are not exposed. The terminals that are exposed on the battery pack when it is mounted on the transceiver are charging terminals only and do not constitute a hazard.

DO NOT INCINERATE: Do not dispose of any battery in a fire or incinerator. The heat of fire may cause battery cells to explode and/or release dangerous gases.

Battery Maintenance

For safe and proper battery use, please observe the following:

- Battery packs should be charged only in non-hazardous environments;
- Use only STANDARD HORIZON-approved batteries;
- Use only a STANDARD HORIZON approved charger. The use of any other charger may cause permanent damage to the battery.
- Follow charging instructions provided with the chargers.
- Keep the battery contacts clean and dry.

Battery Storage

Store the batteries in a cool place to maximize storage life. Since batteries are subject to self-discharge, avoid high storage temperatures that cause large self-discharge rates. After extended storage, a full recharge is recommended.

Battery Recycling

**DO NOT PLACE USED BATTERIES IN YOUR REGULAR TRASH!
LI-ION BATTERIES MUST BE COLLECTED, RECYCLED OR DISPOSED
OF IN AN ENVIRONMENTALLY SOUND MANNER.**

The incineration, land filling or mixing of Li-Ion batteries with the municipal solid waste stream is PROHIBITED BY LAW in most areas.

Return batteries to an approved Li-Ion battery recycler. This may be where you purchased the battery.

Contact your local waste management officials for other information regarding the environmentally sound collection, recycling and disposal of Li-Ion batteries.

3.3.2 BATTERY INSTALLATION AND REMOVAL

- To install the battery pack, hold the transceiver with your left hand, so your palm is over the speaker. Insert the battery pack into the battery compartment on the back of the radio, then push the bottom side of the battery pack until the battery pack locks with the Battery Pack Latch.
- To remove the battery, turn the radio off. Slide the Battery Pack Latch on the bottom of the radio, then lift up on the bottom of the battery and remove it from the radio.

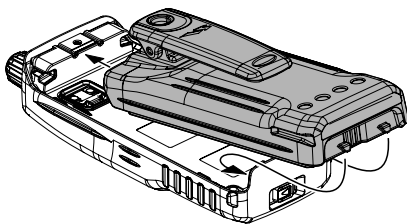

HAND STRAP INSTALLATION

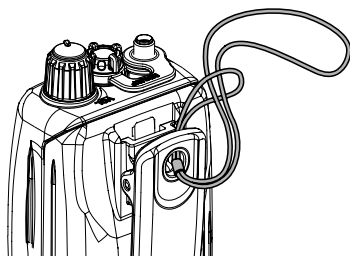

3.3.3 BATTERY CHARGING

1. Turn the transceiver off.
2. Insert the DC plug from the **PA-45B** into the DC jack on the **CD-50** side panel, then plug the **PA-45B** into the AC line outlet.
3. Insert the **HX407** (with the battery pack) into the **CD-50**; the antenna should be at the left side when viewing the charger from the front.
4. If the **HX407** is inserted correctly, the Red "**CHARGING**" indicator will glow. A fully-discharged pack will be charged completely in approximately 3 hours.
5. When charging is completed, the red LED indicator will change to green. Remove the transceiver from the **CD-50**, and unplug the **PA-45B** from the AC line outlet.

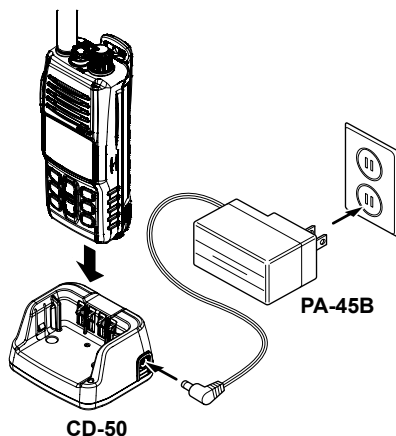

⚠ WARNING ⚠

- Do not reverse-connect the battery terminals.
- Do not parallel-connect the battery terminals.
- Do not change batteries in hazardous locations.
- To reduce the risk of explosion, recharge the batteries outside of hazardous locations.

CAUTION

The **CD-50** cradle is NOT designed to be waterproof. Do not attempt to charge in water hazardous locations.

NOTE

The **CD-50** cradle is only designed for the charging of the **HX407**'s battery, and is not suitable for other purposes. The **CD-50** may contribute noise to TV and radio reception in the immediate vicinity, so we do not recommend its use adjacent to such device.

4. CONTROLS AND INDICATORS

4.1 CONTROLS AND SWITCHES

NOTE

This section defines each control of the transceiver. For detailed operating instructions, refer to section “6. BASIC OPERATION”. Refer to illustrations for the location of the following controls, switches, and connections.

- ① **ANT Jack (Top Panel)**
The supplied **CAT460** flexible antenna is attached here.

- ② **MIC/SP Jack (Top Panel)**
The jack accepts the optional **MH-73A4B** Speaker/Microphone, **MH-57A4B** Mini Speaker/Microphone, **SSM-64A** VOX Headset, or **SSM-55A** Earpiece/Microphone. When this jack is used, the internal speaker and microphone are disabled.

- ⚠ **1) Do not allow the HX407 to become submerged in water while the plastic cover over the MIC/SP jack is removed.**
2) Do not remove/install the optional Speaker Microphone in a hazardous location.

- ③ **POWER Switch / VOLUME Control (VOL)**

Turns the transceiver on and off as well as adjusts the audio volume level.

Turn this knob clockwise to turn the radio on and increase the speakers audio volume.

Turn fully counter-clockwise to turn the radio off.

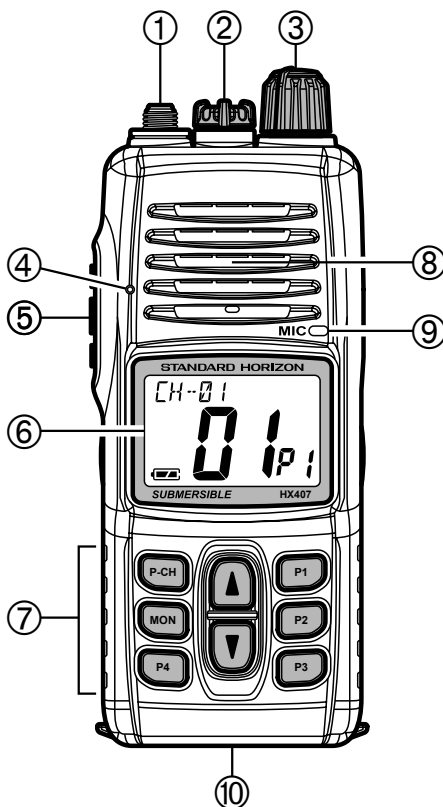

- ④ **Noise Canceling Microphone**
The noise canceling microphone is located here.
Note: To cancel background noise when transmitting, care should be taken not to cover this mic hole with your hand.
- ⑤ **PTT (PUSH-TO-TALK) Switch**
When pushed activates the transmitter.
- ⑥ **LCD Display**
This display shows current operating conditions. Refer to page 19 for details.
- ⑦ **Keypad**
[P-CH], [MON], [P1] - [P4] Key
The Programmable key functions can be customized, via programming by your STANDARD HORIZON dealer, to meet your communications/network requirements.

 **Key**
Press the key momentarily to increase the channel one step. Hold the key down to increase the channel continuously.

 **Key**
Press the key momentarily to decrease the channel one step. Hold the key down to decrease the channel continuously.
- ⑧ **Speaker**
The internal speaker is located here.
- ⑨ **Microphone**
The internal microphone is located here.
When transmitting, position your mouth 1 inch (2.5 cm) away from the small mic hole. Speak slowly and clearly into the microphone.
- ⑩ **Battery Pack Lock (Bottom side)**
Slide the Battery Pack Lock to the “◀” position for battery removal.

4.2 LCD INDICATORS

- ① Alpha/numeric “Tag” display
Indicates the current channel name or operating mode.
- ② “PRI” Indicator
This indicator is shown when the Priority channel is selected.
- ③ “TX” Indicator
This indicator appears during transmission.
- ④ “BUSY” Indicator
This indicator appears when a signal is being received or when the radio is unscelched.
- ⑤ “🔇” Indicators
This indicator shows the Voice Scrambler function is assigned to a channel.
- ⑥ “CTCSS” Indicator
This indicator shows the CTCSS function is assigned to a channel.
- ⑦ “DCS” Indicator
This indicator shows the DCS function is assigned to a channel.
- ⑧ “🔋” Battery Indicator
“🔋”: Full battery
“🔋”: Lower battery
“🔋”: Battery is very low
“🔋 (Blinking)”: Prepare to charge the battery
- ⑨ Channel Display
The operating channel is shown on the LCD in both the transmission and reception modes.
- ⑩ “🔇” Indicator
When the “🔇” icon is shown on the LCD, all keys are disabled except for the PTT (🔇) key.
- ⑪ “🔊” Indicators
This indicator shows when the TX output power is selected to “Low” (1 Watt) power.

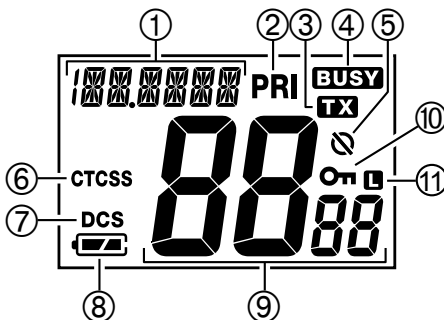



MEMO

5. BASIC OPERATION

5.1 INITIAL SETUP



1. Install the battery pack on the transceiver (see section “**3.3.2 BATTERY INSTALLATION AND REMOVAL**”).
2. Install the antenna onto the transceiver; hold the bottom end of the antenna, then screw it onto the mating connector on the transceiver until it is snug. Do not over-tighten.

5.2 RECEPTION

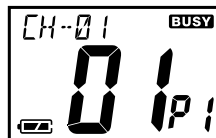
1. Turn the **VOL** knob clockwise to turn the transceiver on.
The battery voltage will appear briefly at the upper left corner on the display, then the channel name will appear.
2. Turn the **VOL** knob clockwise until the noise or audio from the speaker is at a comfortable level.
3. Press the  or  key to select the desired channel.
4. When a signal is received, adjust the **VOL** knob to the desired listening level. The “**BUSY**” indicator on the LCD is displayed indicating that the channel is being used.



5.3 TRANSMISSION

1. Perform “**5.2 RECEPTION**” discussion above.
2. Before transmitting, monitor the channel and make sure it is clear.
THIS IS AN FCC REQUIREMENT!
3. When receiving a signal, wait until the incoming signal stops before transmitting. The transceiver cannot transmit and receive simultaneously.
4. Press and hold the **PTT** (Push-To-Talk: ) switch to transmit. During transmission, the “**TX**” indicator will appear on the display.
5. Position your mouth 1 inch (2.5 cm) away from the mic hole. Speak slowly and clearly into the microphone.
6. When the transmission is finished, release the **PTT** () switch.

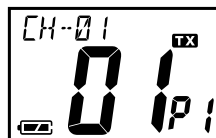

5.3.1 TRANSMIT TIME - OUT TIMER (TOT)

While the **PTT** () switch is held down, transmission time is limited to 5 minutes. This prevents prolonged (unintentional) transmissions. About 10 seconds before automatic transmitter shutdown, a warning beep will sound from the speaker. The transceiver automatically switches to the receiving

mode, even if the **PTT** (Ⓜ) switch is held down. Before transmitting again, the **PTT** (Ⓜ) switch must first be released. This Time-Out-Timer (TOT) prevents a continuous transmission that would result from an accidentally stuck **PTT** (Ⓜ) switch.

NOTE

The **PTT** (Ⓜ) switch is disabled for 10 seconds after the transceiver automatically switches to the receiving mode by the TOT feature.

6. ADVANCED OPERATION

6.1 Programmable Key Functions

The Programmable key functions can be customized, via programming by your STANDARD HORIZON dealer, to meet your communications/network requirements.

The possible Programmable key programming features are illustrated on the next page, and their functions are explained beginning after page 18. For further details, contact your STANDARD HORIZON dealer.

P-ch

Press (or press and hold) the assigned programmable key to recall the pre-programmed priority channel.

Sql Set

You can manually adjust the squelch level using this function.

Sql Mute off

Press (or press and hold) the assigned Programmable key to cancel any signaling features; the “**BUSY**” indicator will appear on the display.

Tx Power H/L

Press to toggle the transmit power between High (5 W) and Low (1 W).

Ch Up/DN

Press (or press and hold) the assigned Programmable key to select a different channel within the current Group.

Ch Continuation Up/Dn

Press and hold the assigned programmable key causes the radio to begin stepping (repeatedly) upward or downward through the channels.

Key Lock

In order to prevent accidental channel change, the **HX407**'s keypad may be locked.

Lamp

Press (or press and hold) the assigned Programmable key to illuminate the display for five seconds.

Scan

The Scanning feature is used to monitor multiple signals programmed into the transceiver. While scanning, the transceiver will check each channel for the presence of a signal, and will stop on a channel if a signal is present.

Dual Watch

The Dual Watch feature allows the radio to scan between the Priority Channel and one other channel.

Noise Cancel

Press (or press and hold) the assigned Programmable key to toggle the Noise Cancel feature “On” and “Off”.

Scrambler

Press (or press and hold) the assigned Programmable key to toggle the Encryption feature “On” and “Off”.

Vox

Press (or press and hold) the assigned programmable key to turn the VOX function “On” or “Off”. You may disable the VOX function temporarily by pressing the PTT switch.

Group Change Up/Dn

Press (or press and hold) the assigned Programmable key to select a different Group channel.

Tx Save Disable

Press (or press and hold) the assigned Programmable key to disable the TX Save feature.

Group Scan On/Off

Press (or press and hold) the assigned Programmable key to toggle the Group Scan feature “On” and “Off”.

Ta Scan

Press (or press and hold) the assigned Programmable key to toggle the TA (Talk Around) scan feature “On” and “Off”.

Talk Around

Press (or press and hold) the assigned Programmable key to activate the Talk Around feature.





Direct Ch1 - 4

Press (or press and hold) the assigned Programmable key to recall the Dealer pre-programmed channel directly.

7. MENU (“SET”) MODE

The Setup Menu allows a number of the **HX407** operating parameters to be custom-configured for your operating requirements.

The Menu Mode is easy to activate and set, using the following procedure:

1. Turn the transceiver off by rotating the **VOL** knob fully counter-clockwise.
2. Hold down the [P1] key, then turn on the transceiver while still holding down the [P1] key.
3. The Menu item will scroll on the upper left corner of the display and its current status or value will appear on the large display.
4. Press the  or  key to select the Menu item to be adjusted.
5. Press the [P1] key to enable adjustment of the selected Menu item. The current status or value will blink.
6. Press the  or  key to select the desired status or value of the Menu item.
7. After completing your adjustment, press the [P3] key to save the new setting.
8. If you wish to change another Menu item, repeat steps 4 to 7 above.
9. Turn the transceiver off to exit to normal operation.

LAMP

Function: Selects the Lamp illumination condition.

Available Values: OFF / 2 / 5 / 7 / 10 / 15 (sec)

DIMMER

Function: Selects the display brightness level.

Available Values: OFF / 1 / 2 / 3 (level)

BEEP

Function: Setting the Keypad beep.

Available Values: OFF / Lo / Mi / Hi (level)

PRI-CH

Function: Select the Priority Channel.

Available Values: OFF / Ch No

SCAN TYPE

Function: Selects the Scan Type.

Available Values: PS (Pri-Scan) / MS (MEM-Scan)

SCAN MEMORY

Function: Add or remove a channel to Scan Memory.

NOISE CANCEL TX

Function: Enables/Disables the TX Noise Canceling function.

Available Values: on / oFF

NOISE CANCEL RX

Function: Enables/Disables the RX Noise Canceling function.

Available Values: oFF / 1 / 2 / 3 / 4 (level)

AF PITCH CONTL

Function: Selects the audio filter operation.

Available Values: oFF / HLc / HLb / Lb / Hb

VOICE SCRAMBLER

Function: Enables/Disables the Voice Scrambler and selects its scramble code.

Available Values: oFF / 0 to 31

VOX

Function: Enables/Disables the VOX function.

Available Values: oFF / 0 to 31

VOX SENSE

Function: Select the VOX gain.

Available Values: 1 / 2 / 3 / 4 / 5 (level)

VOX TIMER

Function: Select the VOX delay time.

Available Values: 1 / 2 / 3 / 4 / 5 (sec)

8. MAINTENANCE

8.1 GENERAL

The inherent quality of the solid-state components in STANDARD HORIZON radios will provide many years of continuous use. Take the following precautions to prevent damage to the radio.

- To prevent corrosion of electrical contacts and keep the water resistance, keep the microphone or the jack connected at all times.
- Never press the **PTT** switch unless an antenna or suitable dummy load is connected to the antenna receptacle.
- Ensure that the input voltage does not exceed the value specified in your Owner's Manual.
- Use only STANDARD HORIZON-approved accessories and replacement parts.

8.2 REPLACEMENT PARTS

Occasionally an owner needs a replacement part. Items can be ordered from our Parts Department by writing or calling (in USA or Canada), or Standard Horizon/Yaesu authorized dealers (outside USA or Canada).

Marine Division of YAESU U.S.A.

6125 Phyllis Drive, Cypress, CA 90630, U.S.A.

Telephone (800) 767-2450

8.3 FACTORY SERVICE

In the unlikely event that the radio fails to perform or needs servicing, please contact the following:

For repairs In USA

Standard Horizon

Attention Marine Repair Department

6125 Phyllis Drive, Cypress, CA 90630

Telephone (800) 366-4566

For repairs In Canada

Westcom Marine

488 East 62 nd Avenue

Vancouver BC V5X2G1

Telephone (604) 327-6280

9. WARRANTY

Marine Products Limited Warranty

PLEASE NOTE

The following “Limited Warranty” is for valid for products that have been purchased in the United States and Canada. For limited Warranty details outside the United States, contact the dealer in your country.

STANDARD HORIZON (a division of YAESU U.S.A.) warrants, to the original purchaser only, each new Marine Communications Product (“Product”) manufactured and/or supplied by STANDARD HORIZON against defects in materials and workmanship under normal use and service for a period of time from the date of purchase as follows:

Fixed Mount and Portable Transceivers

1 year - if purchased before 01/01/91

3 years - if purchased between 01/01/91 and 01/01/94

3 years Waterproof - if purchased after 01/01/94

Loud hailers

1 year - if purchased before 01/01/91

3 years - if purchased after 01/01/91

Associated Chargers

1 year - if purchased before 01/01/91

3 years - if purchased after 01/01/91

Associated Batteries - 1 year. Note: Batteries will be deemed defective only if storage capacity drops below 80% of rated capacity or if leakage develops.

Associated Accessories - 1 year. Includes: Microphones/Handsets, External Speakers, Antennas, Carrying Accessories, Power Supplies, and Signaling Boards.

To receive warranty service, the purchaser must deliver the Product, transportation and insurance prepaid, to STANDARD HORIZON (a division of YAESU U.S.A.), Attention Marine repairs 6125 Phyllis Drive, Cypress, CA 90630. Include proof of purchase indicating model, serial number, and date of purchase. STANDARD HORIZON will return the Product to the purchaser freight prepaid. Products purchased prior to January 1, 1991 will bear the STANDARD HORIZON warranty terms in effect prior to that date.

In the event of a defect, malfunction or failure of the Product during the warranty period, STANDARD HORIZON's liability for any breach of contract or any breach of express or implied warranties in connection with the sale of Products shall be limited solely to repair or replacement, at its option, of the

Product or part(s) therein which, upon examination by STANDARD HORIZON, appear to be defective or not up to factory specifications. STANDARD HORIZON may, at its option, repair or replace parts or subassemblies with new or reconditioned parts and subassemblies. Parts thus repaired or replaced are warranted for the balance of the original applicable warranty.

STANDARD HORIZON will not warrant installation, maintenance or service of the Products. In all instances, STANDARD HORIZON's liability for damages shall not exceed the purchase price of the defective Product.

This warranty only extends to Products sold within the 50 States of the United States of America and the District of Columbia.

STANDARD HORIZON will pay all labor to repair the product and replacement parts charges incurred in providing the warranty service except where purchaser abuse or other qualifying exceptions exist. The purchaser must pay any transportation expenses incurred in returning the Product to STANDARD HORIZON for service.

This limited warranty does not extend to any Product which has been subjected to misuse, neglect, accident, incorrect wiring by anyone other than STANDARD HORIZON, improper installation, or subjected to use in violation of instructions furnished by STANDARD HORIZON, nor does this warranty extend to Products on which the serial number has been removed, defaced, or changed. STANDARD HORIZON cannot be responsible in any way for ancillary equipment not furnished by STANDARD HORIZON which is attached to or used in connection with STANDARD HORIZON's Products, or for the operation of the Product with any ancillary equipment, and all such equipment is expressly excluded from this warranty. STANDARD HORIZON disclaims liability for range, coverage, or operation of the Product and ancillary equipment as a whole under this warranty. STANDARD HORIZON reserves the right to make changes or improvements in Products, during subsequent production, without incurring the obligation to install such changes or improvements on previously manufactured Products.

The implied warranties which the law imposes on the sale of this Product are expressly LIMITED, in duration, to the time period specified above. STANDARD HORIZON shall not be liable under any circumstances for consequential damages resulting from the use and operation of this Product, or from the breach of this LIMITED WARRANTY, any implied warranties, or any contract with STANDARD HORIZON. IN CONNECTION WITH THE SALE OF ITS PRODUCTS, STANDARD HORIZON MAKES NO WARRANTIES, EXPRESS OR IMPLIED AS TO THE MERCHANTABILITY OR FITNESS FOR A PARTICULAR PURPOSE OR OTHERWISE, EXCEPT AS EXPRESSLY SET FORTH HEREIN.

Some states do not allow the exclusion or limitation of incidental or consequential damages, or limitation on how long an implied warranty lasts, so the above limitations or exclusions may not apply. This warranty gives specific legal rights, and there may be other rights which may vary from state to state.

ONLY PRODUCTS SOLD ON OR AFTER JANUARY 1, 1991 ARE COVERED UNDER THE TERMS OF THIS LIMITED WARRANTY.

ON-LINE WARRANTY REGISTRATION

THANK YOU for purchasing a Standard Horizon products! We are confident your new radio will serve your needs for many years!

Please visit www.standardhorizon.com to register the **HX407** Marine UHF. It should be noted that visiting the Web site from time to time may be beneficial to you, as new products are released they will appear on the STANDARD HORIZON Web site. Also a statement regarding product support should be added to the manual.

Product Support Inquiries

If you have any questions or comments regarding the use of the **HX407**, you can visit the STANDARD HORIZON Web site to send an E-Mail or contact the Product Support team at (800) 767-2450 M-F 8:00AM to 5:00PM PST.

In addition to the warranty, STANDARD HORIZON includes a lifetime "flat rate" and "customer loyalty" programs to provide service after the warranty period has expired. If you wish to obtain the flat rate price for out-of-warranty repair, you must include the information on the Owner's Record with the unit when you return it to your Dealer or to STANDARD HORIZON.

Lifetime Flat Rate Service Program: For the original Owner only, for the lifetime of the unit, STANDARD HORIZON will repair the unit to original specifications.

Note: The flat rate amount is payable by the Owner only if STANDARD HORIZON or the STANDARD HORIZON Dealer determines that a repair is needed. After the repair, a 90-day warranty will be in effect from the date of return of the unit to the Owner.

This service program is not available for equipment which has failed as a result of neglect, accident, breakage, misuse, improper installation or modification, or water damage (depending on the product).

10. INSTALLATION OF OPTION

10.1 FBA-42 ALKALINE BATTERY TRAY

FBA-42 is a battery tray that holds six AA size Alkaline batteries and is used with the **HX407** transceiver. When the **FBA-42** is installed into the **HX407** the radio can withstand immersion in water up to 1.5 m (about 5Ft) for 30 minutes.

1. On the **FBA-42**, remove the battery tray cover. Due to the battery tray water proof characteristics, it may be difficult to remove the battery tray cover, put a coin to the edge of the battery compartment () then pry open the battery tray cover.
2. Slide the six AA size Alkaline batteries into the **FBA-42** Battery Tray with the Negative (-) side of the batteries touching the spring connections inside the **FBA-42** Battery Tray.
3. Attach the battery cover to the **FBA-42** Battery Tray while being careful so that o-ring is not twisted.
4. Insert the **FBA-42** Battery Tray into the battery compartment on the back of the **HX407** transceiver, then push the bottom side of the **FBA-42** Battery Tray until the Battery Tray locks with the Battery Pack Latch.

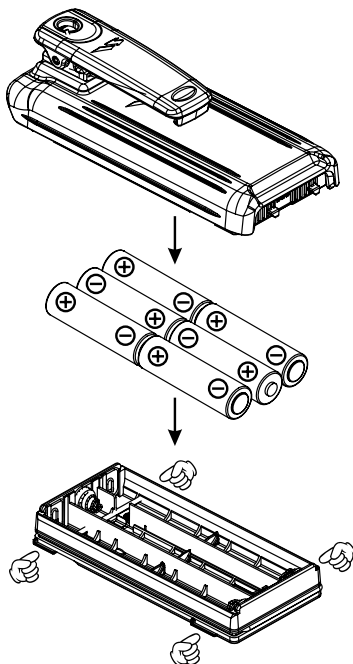

11. SPECIFICATIONS

Performance specifications are nominal, unless otherwise indicated, and are subject to change without notice.

11.1 GENERAL

Frequency Ranges:	400.000 MHz to 470.000 MHz
Channel Spacing:	25 kHz / 12.5 kHz
Frequency Stability:	±2.5 ppm
Emission Type:	16K0G3E / 11K0G3E
Antenna Impedance:	50 Ω
Supply Voltage:	7.4V DC, Negative Ground (Battery Terminal)
Operating Temperature:	-22 °F to +140 °F (-30 °C to +60 °C)
Battery Type and capacity:	Lithium-Ion, 2300 mAh (Rated) 2400 mAh (Typ)
Waterproof Rating:	JIS-8 / IPX8 (1.5 m (about 5 Ft) for 30 minutes)

11.2 TRANSMITTER

RF Power Output:	5 W / 1 W (@7.4 V)
Maximum Deviation:	±5.0 kHz (Wide) / ±2.5 kHz (Narrow)
Hum and Noise Ratio:	More than 40 dB
Spurious Emission:	Less than 0.25 uW

11.3 RECEIVER

Adjacent Channel Selectivity:	More than 70 dB (Wide), More than 60 dB (Narrow)
Intermodulation:	More than 68 dB
Spurious Response Rejection:	More than 70 dB
Hum and Noise Ratio:	More than 40 dB
Maximum Audio Output Power:	700 mW @16 Ω for 10 % THD (@7.4 V)
AF Output (External SP):	300 mW @8 Ω for 10 % THD (@7.4 V)
Spurious Emission:	Less than 2 nW

Measured in accordance with TIA/EIA-603.

FCC AND CANADA RADIO LICENSE INFORMATION

Standard Horizon radios comply with the Federal Communication Commission (FCC) and Industry-Canada requirements that regulate the Maritime Radio Service.

MARITIME STATION LICENSE

An FCC ship station license is no longer required for any vessel traveling in U.S. waters which uses a UHF marine radio, RADAR or EPIRB, and which is not required to carry radio equipment. However, any vessel required to carry a marine radio on an international voyage, carrying a HF single side band radiotelephone or marine satellite terminal. FCC license forms, including applications for ship (605) and land station licenses can be downloaded via the Internet at www.fcc.gov/Forms/Form605/605.html. To obtain a form from the FCC, call (888) 225-5322.

MARINE RADIO CALL SIGN

Currently the FCC does not require recreational boaters to have a Ship Radio Station License. The USCG recommends the boats registration number and the state to be used.

CANADIAN SHIP STATION LICENSING

You may need a license when traveling in Canada. If you do need a license contact their nearest field office or regional office or write:

**Industry Canada
Radio Regulatory Branch
Attn: DOSP
300 Slater Street
Ottawa, Ontario
Canada, KIA 0C8**

THIS DEVICE COMPLIES WITH PART 15 OF THE FCC RULES. OPERATION IS SUBJECT TO THE FOLLOWING TWO CONDITIONS: (1) THIS DEVICE MAY NOT CAUSE HARMFUL INTERFERENCE, AND (2) THIS DEVICE MUST ACCEPT ANY INTERFERENCE RECEIVED, INCLUDING INTERFERENCE THAT MAY CAUSE UNDESIRE OPERATION.

Changes or modifications to this device not expressly approved by YAESU U.S.A. could void the User's authorization to operate this device.

This device complies with Industry Canada license-exempt RSS standard(s). Operation is subject to the following two conditions: (1) this device may not cause interference, and (2) this device must accept any interference, including interference that may cause undesired operation of the device.

Le présent appareil est conforme aux CNR d'Industrie Canada applicables aux appareils radio exempts de licence. L'exploitation est autorisée aux deux conditions suivantes : (1) l'appareil ne doit pas produire de brouillage, et (2) l'utilisateur de l'appareil doit accepter tout brouillage radioélectrique subi, même si le brouillage est susceptible d'en compromettre le fonctionnement.

Under Industry Canada regulations, this radio transmitter may only operate using an antenna of a type and maximum (or lesser) gain approved for the transmitter by Industry Canada. To reduce potential radio interference to other users, the antenna type and its gain should be so chosen that the equivalent isotropically radiated power (e.i.r.p.) is not more than that necessary for successful communication.

Conformément à la réglementation d'Industrie Canada, le présent émetteur radio peut fonctionner avec une antenne d'un type et d'un gain maximal (ou inférieur) approuvé pour l'émetteur par Industrie Canada. Dans le but de réduire les risques de brouillage radioélectrique à l'intention des autres utilisateurs, il faut choisir le type d'antenne et son gain de sorte que la puissance isotrope rayonnée équivalente (p.i.r.e.) ne dépasse pas l'intensité nécessaire à l'établissement d'une communication satisfaisante.

This radio transmitter (identify the device by certification number, or model number if Category II) has been approved by Industry Canada to operate with the antenna types listed below with the maximum permissible gain and required antenna impedance for each antenna type indicated. Antenna types not included in this list, having a gain greater than the maximum gain indicated for that type, are strictly prohibited for use with this device.

Le présent émetteur radio (identifier le dispositif par son numéro de certification ou son numéro de modèle s'il fait partie du matériel de catégorie I) a été approuvé par Industrie Canada pour fonctionner avec les types d'antenne énumérés ci-dessous et ayant un gain admissible maximal et l'impédance requise pour chaque type d'antenne. Les types d'antenne non inclus dans cette liste, ou dont le gain est supérieur au gain maximal indiqué, sont strictement interdits pour l'exploitation de l'émetteur. l'établissement d'une communication satisfaisante.

STANDARD HORIZON

Nothing takes to water like Standard Horizon

Copyright 2015
YAESU MUSEN CO., LTD.
All rights reserved.

No portion of this manual
may be reproduced
without the permission of
YAESU MUSEN CO., LTD.

YAESU USA

6125 Phyllis Drive, Cypress, CA 90630

Printed in Japan