

YAESU
The radio

C4FM/FM 144/430MHz
DIGITAL/ANALOG TRANSCEIVER

FT3DR

Operating Manual



Contents

Quick Guide	3	Split Memory	26
Controls & Connections	4	Using Memory Tag	26
Transceiver.....	4	Using Memory Bank.....	26
Touch Screen Display	6	Scanning Function	27
Supplied Accessories and Options	9	VFO Scan.....	27
Supplied Accessories.....	9	Memory Channel Scanning	27
Available Options.....	9	Programmable Memory scan (PMS)	28
Preparation	10	Dual Receive (DW) feature	28
Installing the Antenna	10	Convenient Functions	29
Attaching the Belt Clip	10	Bluetooth® Operation.....	29
Installing the Battery Pack	10	When connecting to a Bluetooth Headset for the	
Charging the Battery Pack	11	first time -Pairing-.....	29
Charging the Battery Pack using the		Hands-free operation with a Bluetooth headset	
Battery Charger (SAD-25B).....	11	(VOX function)	30
Charging the Battery Pack using the		Send by pressing the button on the Bluetooth	
Rapid Charger (CD-41)	11	headset (when the VOX function is off).....	30
External Power Supply	12	VOX Operation.....	31
Connecting an External Power Supply for Use in		Setting VOX function.....	31
Vehicle	12	Set the VOX (automatic voice transmission)	
Connecting to an External Power Supply Using a		delay time.....	31
Power Cable.....	12	Band Scope.....	32
Using a microSD Memory Card	12	GPS Function.....	33
Usable microSD Memory Cards	12	Tone squelch feature	33
Formatting a microSD Memory Card.....	12	Digital Code squelch (DCS) feature	33
Operation	13	Digital Personal ID (DP-ID) feature	33
Turning the Transceiver ON	13	Using Set Mode	34
Adjusting the Volume Level.....	13	Set Mode Operation	34
Adjusting the squelch setting.....	13	Tables of Set Mode Operations	35
Toggling the Operating Band.....	14	Restoring to Defaults (Reset)	41
Selecting a Frequency Band.....	14	All Reset	41
Tuning to a Frequency	14	Set Mode Reset	41
Changing the Frequency Step	15	Specifications	42
Selecting the Communication Mode	16		
Fixing the Communication Mode.....	17		
Transmission	17		
Changing the Transmission Power Level	18		
Locking Keys and DIAL knob.....	18		
Using the convenient Digital C4FM feature ..	19		
About the Digital Group ID (DG-ID) feature.....	19		
Communicating with the DG-ID feature.....	19		
Repeater Operation	23		
Communicating Via the Repeater	23		
Using the Memory	24		
Registering to Memory Channels.....	24		
Recalling a Memory Channel	24		
Clearing Memories	25		
Restored erased memory	25		
Recalling the Home Channels.....	25		
Changing the Home Channel Frequency	25		

Turning the Power ON



Install the charged battery pack and then press and hold the  switch.

Inputting the Call sign

When turning the power ON for the first time after purchasing, input the call sign of your own station.

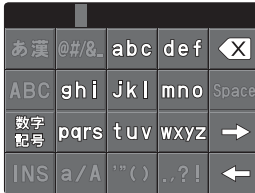
1. When turning the power ON for the first time after purchasing, the call sign input screen will be displayed.
2. Press the [DISP] key.



3. Input the call sign.
Rotate the **DIAL** knob to select each character.
Touch  to move the cursor to the right.
4. Repeat step 3 to input the remaining call sign characters.
Touch  to move the cursor to the left.
5. Press the  switch to conclude inputting.
Normal operation (VFO Mode) screen will be displayed.

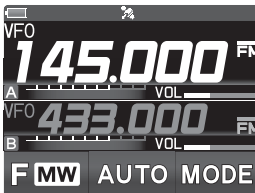

Selecting the Operating Band

Press the [BAND] key.

Tuning the frequency

Rotate the **DIAL** knob.

Adjusting the volume

Rotate the **VOL** knob to adjust the volume to a comfortable level.

Adjusting the squelch setting

The squelch level may be adjusted to mute the background noise when no signal is received.

1. Press the **SQL** switch.
2. Rotate the **VOL** knob to adjust the squelch to a level at which the background noise is muted.
* When the squelch level is increased, the noise is more likely to be silenced, but it may become more difficult to receive weak signals.
3. Press the **SQL** switch to save the setting.

Selecting the Communication Mode



The communication mode is automatically selected to correspond to the signal being received.

Touch [MODE] to manually select the communication mode.

Transmitting/Receiving Signals

Transmitting

While pressing and holding the PTT  switch, speak into the microphone.

Receiving 
Release the  to return to receive mode.

Controls & Connections

Transceiver

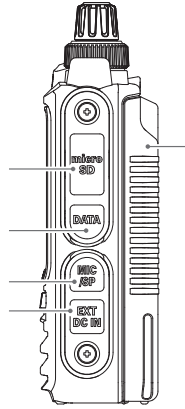
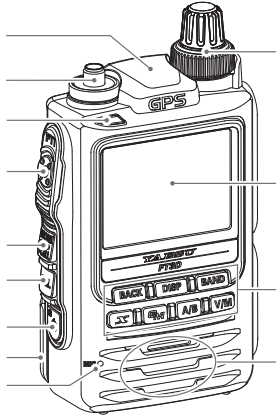

GPS Antenna
Antenna Jack (SMA)*
TX/BUSY LED Lights green (A-band) or blue (B-band) during receive and lights red during transmit.
PTT Switch Press and hold the PTT switch to transmit, and release it to receive.
MONI/T-CALL Switch Press the MONI/T-CALL switch to open the squelch.
SQL Switch Press the SQL switch, then rotate the VOL knob to adjust the squelch level.
Power (Lock) Switch <ul style="list-style-type: none"> • When the power is OFF, press and hold this switch to turn the Power ON. • When the power is ON, press and hold the switch again to turn the Power OFF. • When the power is ON, press this button briefly to engage, or release the key lock.
Battery Pack*
Microphone
DIAL knob Rotate the DIAL Knob to change the frequency or select a memory channel.
VOL knob Rotate the VOL Knob to adjust the audio volume level.

Full Color Touch screen display Touch to set the frequency and various other settings.
Keypad <p>[BACK] key</p> <ul style="list-style-type: none"> • Press to return to the previous screen. <p>[DISP] key</p> <ul style="list-style-type: none"> • Pressing each time switches between the frequency display and the backtrack display. • Press and hold for over one second to enter Set mode. <p>[BAND] key</p> <ul style="list-style-type: none"> • Pressing each time increases the frequency band. <p>[X] key</p> <ul style="list-style-type: none"> • In normal mode, press to start WIRES-X. • When WIRES-X is activated, press and hold for over one second to return to the normal mode. <p>[GM] key</p> <ul style="list-style-type: none"> • Press to turn the GM function on/off. • Press and hold for over one second to enter DG-ID number setting screen. <p>[A/B] key</p> <ul style="list-style-type: none"> • Pressing each time switches between A-band and B-band. • Press and hold for over one second to switch between the Dual Band Receive mode and the Mono Band Receive mode. <p>[V/M] key</p> <ul style="list-style-type: none"> • Pressing each time switches between VFO mode and memory mode.

	Speaker
	microSD memory card slot*
	DATA Terminal* When updating the firmware, connect to a PC using a USB cable.
	MIC/SP jack* Connect the optional speaker microphone or earpiece microphone to this jack. When an external microphone or cable is connected, the dust and splash protection does not function.  Do not connect any microphone which is not specified by Yaesu.
	EXT DC IN jack* <ul style="list-style-type: none"> • When charging the battery pack, connect the battery charger (SAD-25B) to this jack. • Connect an external power supply adapter with a cigarette lighter plug (SDD-13) or an external power cable (E-DC-6) to this jack.

* When the included antenna and battery pack are installed and the MIC/SP jack, DATA terminal, micro SD card slot and EXT DC IN jack are securely covered with rubber caps, the FT3DR meets the waterproofing performance conforming to IPX5.

Touch Screen Display

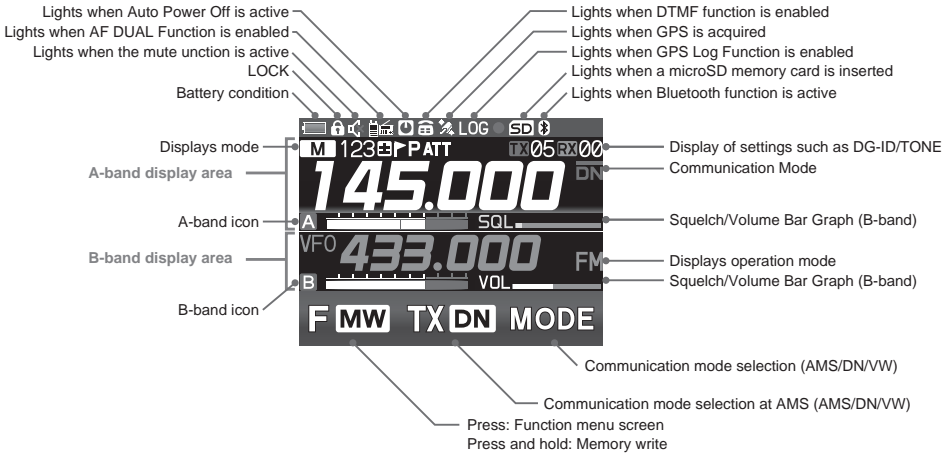

Status Bar



The battery condition is displayed in 8 steps.



: Full battery power

: Battery is depleted. Charge battery.

: (When blinking) Charge battery immediately.



Appears when the lock function is enabled.



Appears when the Mute function is enabled.



Appears when the AF DUAL function is enabled.



Appears when the APO (Automatic Power-Off) function is enabled.



Appears when the DTMF Autodialer function is activated.



Appears when the Built-in GPS function is activated.



Appears when the Voice memory function is enabled.



Appears when the GPS Log function is enabled.



Appears when a microSD card is inserted.



Appears when the Bluetooth function is activated.

Dual Band Screen

A-band and B-band are displayed in a top-down fashion.

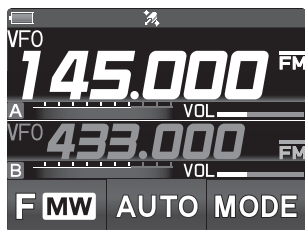

Function Menu Screen

Touching [F MW] displays the function menu screen.

Function Menu Screen 1

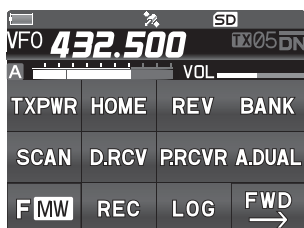

Function Menu Screen 2

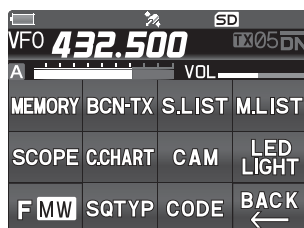

GPS Screen

The GPS satellite statuses are shown with number.

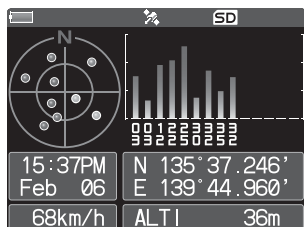

Band Scope Screen

The screen appears as shown, when the band scope is turned on.

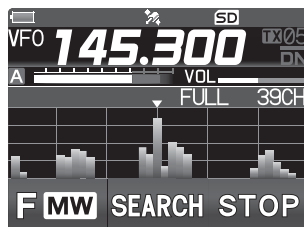

SETUP MENU Screen

Set Mode allows selecting various functions from the list and setting each function according individual preferences.

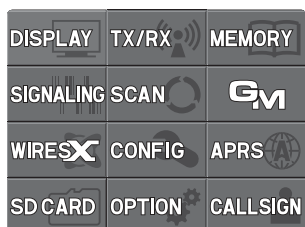

About Waterproofing Feature Conforming to IPX5

When the included antenna and battery pack are installed and the MIC/SP jack, EXT DC IN jack, DATA terminal, and micro SD slot are securely covered with rubber caps, this product is moisture and splash resistant. To ensure continued waterproofing protection, be sure to check the following points before use.

- Check for damages, deterioration, and dirt.

Antenna rubber, key switch rubber, MIC/SP jack, EXT DC IN jack, DATA terminal, micro SD slot rubber cap, and battery pack joint.

- Cleaning

When this product is contaminated with seawater, sand, or dirt, rinse with fresh water, and then wipe with a dry cloth immediately.

- Recommended maintenance interval

To insure continued water resistance and optimal performance, it is recommended that maintenance be performed annually, or when any damage or deterioration is found. Note that the maintenance service is subject to fees.

- Do not immerse this product in the following liquids:

Sea, pool, hot spring, water containing soap, detergent, or bath additive, alcohol, or chemicals.

- Do not leave this product for an extended time in the following places:

Bathroom, kitchen, or humid place

- Other precautions

Since this product is not totally waterproof, it cannot be immersed in water.

Supplied Accessories and Options

Supplied Accessories

- Rechargeable Li-Ion Battery Pack (7.2 V, 2,200 mAh) **SBR-14LI**
- Battery Charger **SAD-25B**
- Antenna
- Belt Clip
- USB Cable
- Operating Manual (This Manual)
- SBR-14LI Manual
- Battery Pack protective cap



If any item is missing, contact the dealer from which you purchased the transceiver.

Available Options

- Speaker / Microphone **MH-34B4B**
- Earpiece Microphone **SSM-57A**
- VOX Headset **SSM-63A**
- Bluetooth® Headset **SSM-BT10**
- Microphone Adapter **CT-44**
- DC Cable with and Cigarette-Lighter Plug **SDD-13**
- DC Cable **E-DC-6**
- Soft Case **SHC-34**
- 3x "AA" Cell Battery Case **FBA-39**
- Li-Ion Battery Packs (7.2 V, 2,200 mAh) **SBR-24LI**
- Li-Ion Battery Packs (7.4 V, 1,100 mAh) **FNB-101LI**
- Battery Charger **SAD-25B**
- Rapid Charger **CD-41**
- Speaker Microphone with Snapshot camera **MH-85A11U**
- Cloning Cable **CT-168**
- Data Cable **CT-170**
- PC connection cable **SCU-39**
- PC connection cable **CT-169**
- Data cable (2.5) **CT-176**
- Belt Clip **SHB-13**
- BNC-to-SMA Adapter (BNCJ-SMAP) **CN-3**

Preparation

Installing the Antenna

1. Turn the antenna clockwise until it is secured.



- Do not hold or twist the upper part of the antenna when installing or removing it. To do so may break the conductors inside the antenna.
- Do not key the transmit without installing the antenna. The transmitter components may be damaged.

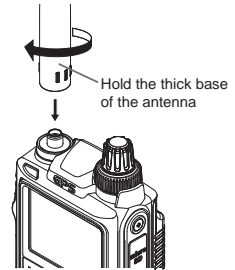

Attaching the Belt Clip

1. Attach the belt clip on the back of transceiver using the supplied screws (two).



Be sure to use the supplied screws when attaching the belt clip. If any other screws are used, the belt clip cannot be secured firmly to the battery pack and the transceiver may drop off together with the battery pack; the transceiver and battery pack may fall off, causing injury, breakage and other damage.

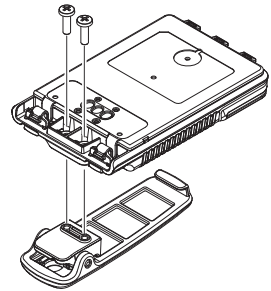

Installing the Battery Pack

1. Insert the bottom tabs of the battery pack in the slots on the back side lower part of the transceiver.
2. Push the battery in until the battery latches click securely.



Charge the battery pack before using the transceiver for the first time after purchase, or when it has not been used for a long period time.

Battery Latches

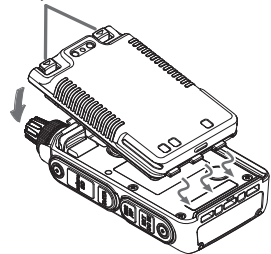

Removing the Battery Pack

1. While pressing down the latches, remove the battery pack.
Press the latches down in the direction of the arrows as shown in the illustration.

Charging the Battery Pack

Charging the Battery Pack using the Battery Charger (SAD-25B)

Using the supplied battery charger (SAD-25B), it takes about 9 hours* to charge the SBR-14LI battery pack fully.

*Depending on the battery status, the charging time might be increased

1. Turn the transceiver OFF to install the battery pack.
2. Referring to the figure at the right, connect the battery charger plugs.

When the battery is being charged, the TX/BUSY Indicator lights red, and "CHGING" is displayed.

3. When charging is completed, the display will change to indicate "CHGFUL" and the TX/BUSY Indicator will light green.

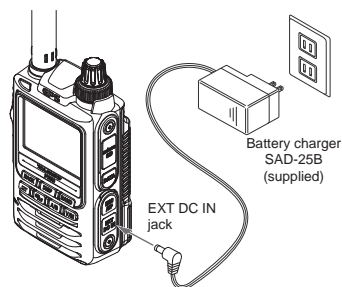

- When charging is completed, the charging is automatically ended.
- If "CHGERR" appears on the LCD during the charging and the battery pack is not charged after a lapse of 10 or more hours, stop charging the battery pack immediately. The battery pack is presumed to be at the end of its service life, or defective. In this case, replace the battery pack with a new one.
- Charge the battery pack within the temperature range from +41°F to +95°F (+5°C to +35°C).



Charging the Battery Pack using the Rapid Charger (CD-41)

For details on the Rapid Charger (CD-41), see Optional CD-41 manual

Approximate Operating Time and Remaining Charge Level Indication

Approximate operating time for the transceiver with the fully charged battery pack or new AA alkaline batteries is as follows:

Band in Use Digital: OFF		Battery pack SBR-14LI	Battery pack FNB-101LI	Battery FBA-39
Amateur Band	144 MHz Band	Approx. 10 hours	Approx. 5 hours	Approx. 12 hours
	430 MHz Band	Approx. 8.3 hours	Approx. 4.1 hours	Approx. 11 hours
AM Broadcast Band		Approx. 20 hours	Approx. 10 hours	Approx. 14 hours
FM Broadcast Band		Approx. 20 hours	Approx. 10 hours	Approx. 14 hours

Band in Use Digital: ON		Battery pack SBR-14LI	Battery pack FNB-101LI	Battery FBA-39
Amateur Band	144 MHz Band	Approx. 8.8 hours	Approx. 4.4 hours	Approx. 12 hours
	430 MHz Band	Approx. 7.6 hours	Approx. 3.8 hours	Approx. 11 hours

The battery charge level calculations are based on an operating cycle of: Transmitting 6 seconds (5 W): Receiving 6 seconds (VOL Level 16): Stand By 48 seconds (RX SAVE 1:5)

The actual times the transceiver will operate as indicated in the above table, varies depending on use, conditions, ambient temperature, etc.

External Power Supply

Connecting an External Power Supply for Use in Vehicle

The optional DC Cable with Cigarette-Lighter plug (SDD-13) allows power to be supplied from a motor vehicle type cigarette lighter socket.

Connecting to an External Power Supply Using a Power Cable

The optional DC cable (E-DC-6) allows the transceiver to be connected to an external DC power supply.

Using a microSD Memory Card

Using a microSD memory card with the transceiver allows the following functions.

- Backing up the transceiver data and information
- Saving memory information
- Saving GPS log data
- Saving image data captured with the optional camera-equipped microphone (MH-85A11U)
- Saving messages downloaded with the GM function or WIRES-X function

Usable microSD Memory Cards

This transceiver only supports the following capacity of microSD and microSDHD memory cards.

•2GB •4GB •8GB •16GB •32GB



- microSD memory cards formatted on other devices may not properly save information when used with this transceiver. Format microSD memory cards again with this transceiver when using memory cards formatted with another device.
- Do not remove the microSD memory card or turn the transceiver off, while saving data to a microSD memory card is in progress.

Formatting a microSD Memory Card

Format a new microSD memory card following the steps below before use.



Formatting a microSD memory card erases all data saved on it. If you are going to format the microSD memory card you are using, be sure to check the data saved on it before formatting.

1. Press and hold the **[DISP]** key.
The “SETUP MENU” screen appears.
2. Touch **[SD CARD]**.
3. Touch **[4 FORMAT]**.
“FORMAT?” appears on the LCD.
4. Touch **[OK]**.
Initialization starts and “Waiting” appears.
 - To cancel formatting, select **[CANCEL]**.
5. When formatting is completed, a beep sounds and “COMPLETED” appears on the LCD.

Turning the Transceiver ON

1. Press and hold the Power (Lock) switch to turn the transceiver ON.

Inputting the call sign

The first time the transceiver is turned ON after it is purchased; input your own call sign.

1. Press the **[DISP]** key to proceed to the call sign input screen.
 - When the transceiver is turned on the second time, and subsequently, the opening screen appears followed by the frequency screen.
2. Input the call sign (toggle the alphabet input screen, and the number input screen when necessary).
3. Saving the inputted call sign:
4. Press the **[PTT]** switch or press and hold the **[DISP]** key.

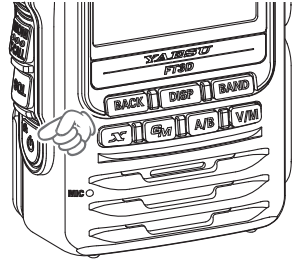

- Up to 10 characters (letters, numbers, and symbols) can be entered.
- Characters that may be inputted for the call sign are the numbers 0-9, letters "A – Z" in upper case, the hyphen and the slash.

Adjusting the Volume Level

1. Rotate the DIAL knob to adjust the volume to a comfortable level.
 - The transceiver volume levels for the A-band and B-band are adjusted separately.

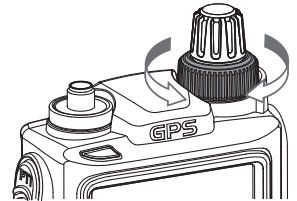

Adjusting the squelch setting

The squelch level may be adjusted to mute the background noise when no signal is present.

1. Press the SQL switch and then rotate the VOL knob to adjust to a level at which the background noise is muted.

SQL  appear on the display.

- The transceiver squelch levels for the A-band and B-band are adjusted separately.



- The default setting is "1".
- When the squelch level is increased, the noise is more likely to be silenced, but it may become more difficult to receive weak signals.

2. Press the SQL switch to save the setting.

Toggling the Operating Band

Normally, both operating bands are displayed on the top half and bottom half of the transceiver touch screen. This is Dual band.

With one of the bands selected, change the frequency and radio operating mode.

- The selected band (displayed in white letters) is called Operating band.
- The other band (displayed in gray letters) is called Sub-band.
- Each time pressing the [A/B] key toggles the operating band.
- The desired operating band may also be selected by touching the frequency display.

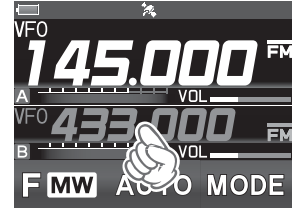
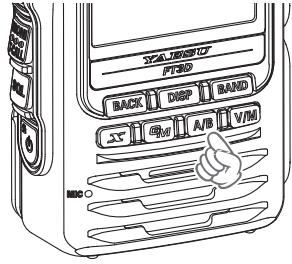

Pressing and hold the [A/B] key displays only the operating band, this is Mono-band.

Selecting a Frequency Band

1. Press the [BAND] key to select the desired frequency band.
 - Press the [F MW] key, then press the [BAND] key to switch the frequency bands in reverse order.

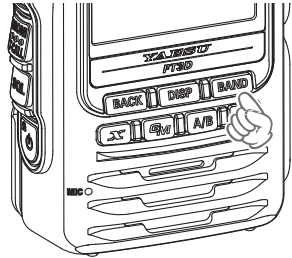

Tuning to a Frequency

DIAL knob

By pressing the [F MW] key and then rotating the DIAL knob, the frequency will change in 1 MHz steps.

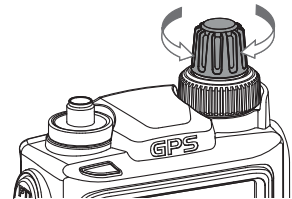

The numeric keys

1. Touch the frequency displayed on the LCD.
The numeric keypad appears.

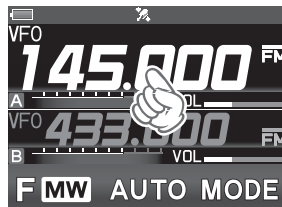

2. Enter the frequency using the numeric keys.

Example: To input 145.520 MHz

[1] → [4] → [5] → [5] → [2]

Example: To input 430.000 MHz

[4] → [3] → [ENT]

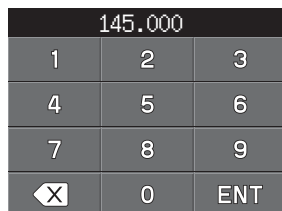

When entering a frequency using the numeric keys, it may be canceled by pressing the PTT switch or the [BACK] key.

Changing the Frequency Step

The DIAL knob rotation frequency step may be changed. Normally, the factory default setting will provide a good frequency step.

1. Press and hold the [DISP] key, then touch [CONFIG].
2. Touch [18 STEP] then rotate the DIAL knob to change the frequency step.
3. Press the PTT switch to save the setting and return to normal operation.



In the default setting, of the frequency step is set to "AUTO", which automatically provides a suitable frequency step according to the frequency band.

Selecting the Communication Mode

Using AMS

The FT3DR transceiver is equipped with the AMS (Automatic Mode Select) function which automatically selects the communication mode corresponding to the received signal.

To utilize the AMS function, touch [MODE] to display “FM”* on the display. After receiving the signal, “FM” of “FM” will be changed according to the received signal.

*The display differs depending on the received signal.

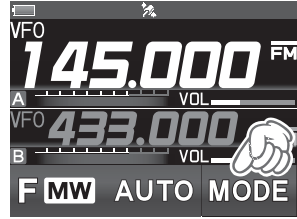

Setting the transmission mode when using the AMS function

The AMS function will automatically set the receiver to the mode of the received signal, but the transmission mode may be fixed regardless of the received mode.

1. Touch [AUTO]* to tune to the desired transmission mode as follows.

*The display differs depending on the transmission mode.

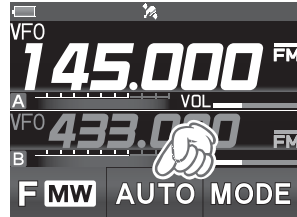

Transmit Mode	Receive and Transmit
AUTO (default)	Receive: Automatically selects the communication mode of transmission according to the signal being received. Transmit: Transmits automatically in the communication mode selected by the AMS function.
TX FM	Receive: Automatically selects the communication mode of transmission according to the signal being received. Transmit: Always transmits in the analog FM mode.
TX DN (TX DIGITAL)	Receive: Automatically selects the communication mode of transmission according to the signal being received. Transmit: Always transmits in the DN mode.

Fixing the Communication Mode

- To fix the transmission mode for operation, touch [MODE] to switch the communication mode.

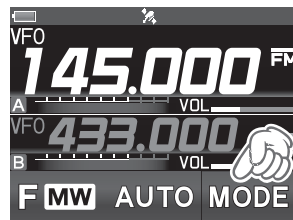

Communication Mode	Icon	Description of Modes
V/D Mode (Voice/Data simultaneous transmission mode)	DN	This is the standard digital mode. Calls are less prone to interruptions caused by detection and correction of the received digital voice signal.
Voice FR Mode* ¹ (Voice Full Rate Mode)	VW * ¹	High speed data communication using entire 12.5 kHz band. Enables high-quality voice communication.
FM Mode	FM	Analog communication using FM mode.
AM Mode (receive only)* ²	AM	The AM mode for receive only.

*1 When the Set Mode [TX/RX] → [2 DIGITAL] → [4 DIGITAL VW] is set to “ON” (factory default is “OFF”), the Voice FR mode (VW) may be selected.

*2 When the Set Mode [TX/RX] → [1 MODE] → [3 RX MODE] is set to “AUTO” (factory default setting), AM mode is automatically selected within the AIR band (108 - 136.995 MHz).

Transmission

- While pressing and holding the **PTT** switch, speak into the microphone.

The TX/BUSY indicator will glow red during transmission.



If the PTT switch is pressed when a frequency other than the amateur ham radio band is selected, an alarm tone (beep) will be emitted and “ERROR” appears on the LCD, disabling transmission.

- Release the **PTT** switch to return to receive mode.

When receiving a signal, the TX/BUSY Indicator lights according to the receive mode.



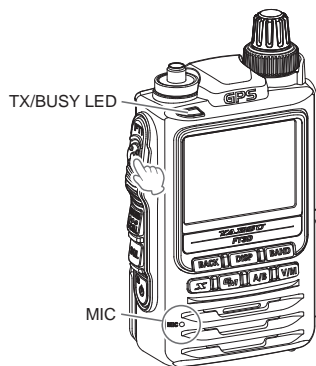

Receive Band	TX/BUSY LED
A-band receiving	Green
B-band receiving	Blue
Receiving A and B simultaneously	Light Blue



If transmission is continued for a long period, the transceiver overheats and the high temperature protection function is activated. As a result, the transmitting power level is automatically set to Low Power. If transmission continues while the high temperature protection function is active, the transceiver will be forcibly returned to the receive mode.

Changing the Transmission Power Level

1. Touch [**F MW**], then touch [**TX PWR**].
2. Rotate the **DIAL** knob to select one of the following transmission power levels.

TX PO Level	PO Meter
HIGH (5 W)*	
LOW3 (2.5 W)	
LOW2 (1 W)	
LOW1 (0.1 W)	

*The default setting.

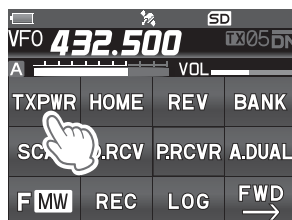

3. Press the **PTT** switch to save the setting and return to the normal operation.



The transmission power level may be set separately for each frequency band.

Locking Keys and DIAL knob

1. Press the Power (Lock) switch, "**LOCK**" is displayed on the display for one second, the "**LOCK**" icon appears on the LCD, and then the keys and **DIAL** knob are locked.

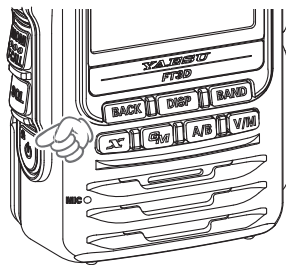

- The keys, the DIAL knob, and the PTT switch may be selected to be locked using Set Mode [**CONFIG**] → [**9 LOCK**]. The default setting is the "**KEY&DIAL**" (the keys and the DIAL knob are locked).
- The **MONI/T-CALL** switch, **SQL** switch and the **VOL** knob cannot be locked.

2. Press the **POWER** (Lock) switch again, "**UNLOCK**" will be displayed on the Display and keys and the **DIAL** knob are unlocked.

Using the convenient Digital C4FM feature

About the Digital Group ID (DG-ID) feature

1. Digital Group ID (DG-ID) function allows communications with only the specific group members using the two-digit ID numbers. The desired DG-ID number from 00 to 99 is set in advance by all the group members. This ID number may be set separately for transmit and receive, when the same ID number is set for both transmit and receive, only group members with the same ID number will be heard. This feature may be used to communicate only with group members that have the same DG-ID number. The GM function may also be utilized to automatically monitor whether or not group member stations with the same DG-ID number are operating within communication range.

The DG-ID number 00 detects signals with all ID numbers. Normally setting the ID number to "00" for both transmit and receive will permit reception of the signals from all other stations using the digital C4FM mode, regardless of the transmit DG-ID number settings of the other stations.

Also note that when the receive DG-ID number of your transceiver is set to a DG-ID number other than "00", received signals that do not have the same DG-ID number may not be heard.

2. When accessing the C4FM digital repeater controlled by the DG-ID number, set the transmit DG-ID number of the FT3DR to that of the repeater input. Even in that case, if the receive DG-ID number of the FT3DR is set to "00", all the downlink signals from the repeater may be received.

Communicating with the DG-ID feature



- Digital C4FM mode transceivers compatible with the DG-ID function are required in order to utilize this function.
- If the firmware is not compatible with the DG-ID function, update the latest firmware to use the DG-ID function. The latest firmware is available on the YAESU website.

Setting the transmit and receive DG-ID number to "00" for communicating with all other stations using C4FM digital mode

1. Press and hold the **[GM]** key.

The DG-ID number setting screen will be displayed.

If the transmit DG-ID (DG-ID TX) number is not set to "00", press the **[GM]** key then rotate the DIAL knob to set "00".

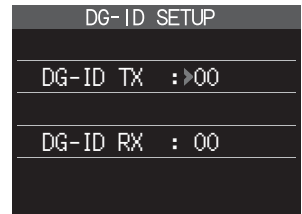

2. Press the **[GM]** key again to select the receive DG-ID (DG-ID RX).

If the receive DG-ID number is not set “00”, press the **[GM]** key then rotate the DIAL knob to set “00”.

DG-ID SETUP	
DG-ID TX	: 00
DG-ID RX	:>00

3. Press and hold the **[GM]** key, or press the **PTT** switch to save the setting and return to the normal operation.

The setting is complete.

4. To check whether or not other stations are operating within communications range, press the **[GM]** key to turn the GM (Group Monitor) function ON.

- The other stations also need to turn the GM (Group Monitor) function ON.

5. Press the **[GM]** key to turn the GM (Group Monitor) function OFF and return to the normal operation.

- While setting the DG-ID number, pressing and holding the **[DISP]** key will set the transmit and the receive DG-ID numbers to “00”.



- If the receive DG-ID is set to a number other than “00”, only signals with that DG-ID will be received. Normally, set the receive DG-ID number to “00” except when communication is desired only with group members.

- The transmit and receive DG-ID default number is set to “00”.

Communicating only with the specific members by setting the DG-ID number except for “00”

Example: Set the DG-ID number of to “50”

1. Press and hold the **[GM]** key.

The DG-ID number setting screen will be displayed.

DG-ID SETUP	
> DG-ID TX	: 00
DG-ID RX	: 00

2. Press the **[GM]** key, then rotate the **DIAL** knob to set the transmit DG-ID (DG-ID TX) to “50”.

DG-ID SETUP	
DG-ID TX	:>50
DG-ID RX	: 00

3. Press the **[GM]** key again, then rotate the **DIAL** knob to select the receive DG-ID (DG-ID RX).

DG-ID SETUP	
DG-ID TX	: 50
▶ DG-ID RX	: 00

4. Press the **[GM]** key, then rotate the **DIAL** knob to set the receive DG-ID (DG-ID RX) to "50".

DG-ID SETUP	
DG-ID TX	: 50
DG-ID RX	: ▶50

5. Press and hold the **[GM]** key, or press the **PTT** switch to save the setting and return to the normal operation.
6. Press the **[GM]** key to turn the GM (Group Monitor) function ON and check whether or not other stations that are operating on frequency, with the GM (Group Monitor) function ON, and have the same GD-ID number setting, are in the communication range.
- The other stations also need to turn the GM (Group Monitor) function ON.
7. Press the **[GM]** key to turn the GM (Group Monitor) function OFF and return to the normal operation.



- While setting the DG-ID number, pressing and holding the [DISP] key will set the transmit and the receive DG-ID numbers to "00".
- If the receive DG-ID is set to a number other than "00", only signals with that DG-ID will be received. Normally, set the receive DG-ID number to "00" except when communication is desired only with group members.



For example, if the transmit and receive DG-ID numbers of group members are all set to "50", communications from other DG-ID numbers is not received and only the group members setting the same DG-ID numbers may communicate. Also, the other stations set the receive DG-ID to any number except for "00" may not be received the signals of your stations.

The group member set the DG-ID number to "50"

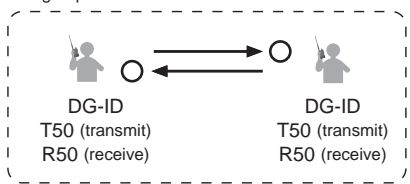

Only group members set to the same DG-ID number may communicate.

Setting the receive DG-ID number to "00", all the C4FM digital stations may be received signals.

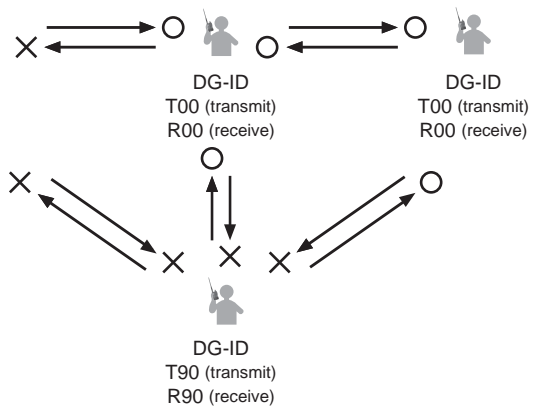

The other station set the receive DG-ID number to the number except for "00" may not received the signals that is not matching the DG-ID number.

Communicating Via the Repeater

The transceiver includes an ARS (Automatic Repeater Shift) function which sets the repeater operation automatically when the receiver is tuned to the repeater frequency.

1. Set the downlink (output) frequency from the repeater.
2. “” or “” and “TN” icons may automatically appear above the frequency.
3. Speak into the microphone while pressing and holding the PTT switch.

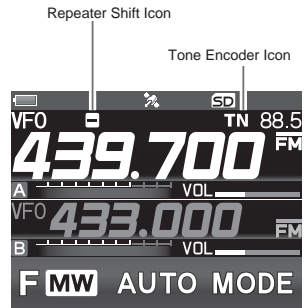

The reverse state

The “reverse” state temporarily reverses the transmit and receive frequencies. This allows checking to find if direct communication with the other station is possible.

1. Touch [F MW], then touch [REV].
 - The transmit and receive frequencies are temporarily reversed (“reverse” state).
 - In the “reverse” state, the “” or “” blinks on the display.
2. Touch [F MW], then touch [REV] to exit from the “reverse” state.

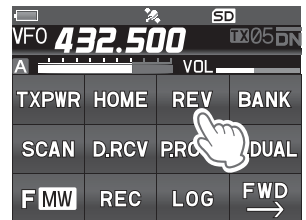

- The repeater settings may be changed from the Set Mode.
Set Mode [CONFIG] → [15 RPT SHIFT] Allows setting the repeater shift direction.
Set Mode [CONFIG] → [16 RPT SHIFT FREQ] Allows changing the repeater shift offset.
Set Mode [SIGNALING] → [12 TONE SQL FREQ] Allows setting the tone encoder frequency.
- The ARS function may be set to OFF in the Set Mode [CONFIG] → [14 RPT ARS].

Using the Memory

Caution

The information registered to memory channels can be corrupted by incorrect operation, static electricity, or electrical noise. Also, it can be erased in the event of a failure or repair. Be sure to keep a record of the settings on paper or back up the data to the microSD memory card. For details on saving a backup onto a microSD memory card, see “Set Mode: SD CARD Menu Operations” on page xxx.

Registering to Memory Channels

1. Set the frequency and the communication mode to be registered to a memory channel.
2. Touch and hold [F MW].
3. Rotate the DIAL knob to select the desired channel number.

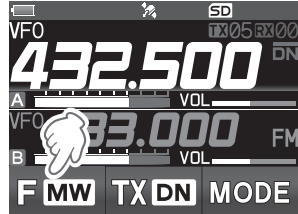

4. Touch [M.WRITE].
 - If you attempt to register a frequency to a memory channel that already contains frequency data, “OVERWRITE?” will appear on the LCD. Touch [OK] twice to overwrite the memory channel.
 - The beep sounds and the memory is saved.

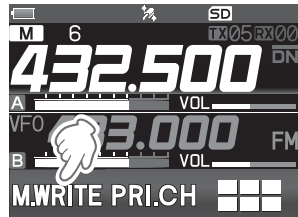

Recalling a Memory Channel

1. Press the [V/M] key.

The memory channel most recently used appears on the display.
2. Rotate the **DIAL** knob to select the desired memory channel.
3. Press the [V/M] key to exit the memory mode, and return to the normal operation.

- The data registered to a memory channel can be transferred to the VFO operating band by following the procedure below:
Touch and hold [F MW] → Touch [] → Touch [V.WRITE] → “OVERWRITE?” appears → Touch [OK] twice.
- The transceiver may be placed into a Memory Channel Only mode, (which restricts the FT3DR to operate only on the memory channels), by pressing the [V/M] key, while pressing the Power (Lock) switch to turn the transceiver ON. To cancel the Memory Channel Only mode, turn the transceiver OFF, then press the [V/M] key again, while pressing Power (Lock) switch to turn the transceiver ON.



Clearing Memories

1. Touch and hold [F MW].
2. Rotate the **DIAL** knob to select the memory channel from which the data is to be cleared.
3. Touch [], then touch [M.DEL].
Confirmation screen “DELETE?” is displayed.
4. Touch [OK] twice to clear the memory channel.



Data on memory channel One, and the Home channel may not be cleared.

Restored erased memory

1. Press the [V/M] key to enter the memory mode.
2. Touch and hold [F MW].
3. Rotate the **DIAL** knob to restore the channel.
4. Touch [].
5. Touch [M.REV].
Confirmation screen “DELETE?” is displayed.
6. Touch [OK] to restore the memory channel.



Recalling the Home Channels

1. Touch [F MW], and then touch [HOME].
2. Press the [V/M] key, or touch [F MW], and then touch [HOME] to return to the previous frequency.



While recalling the home channel, rotate the DIAL knob to transfer the home channel frequency to the VFO operating band.

Changing the Home Channel Frequency

1. Set the frequency and the operating mode you want to store as a home channel.
2. Touch and hold [F MW].
3. Touch [].
4. Touch [H.WRITE].
Confirmation screen “OVERWRITE?” is displayed.
5. Touch [OK] twice.
The beep sounds and the home channel frequency is changed.

Split Memory

Two different frequencies, one for receive and another for transmit, can be registered to a memory channel.

Using Memory Tag

Memory name tags may be assigned to the memory channels and home channels.

Using Memory Bank

The transceiver allows using up to 24 memory banks to allow sorting and registering the channels in convenient groups.

Scanning Function

The FT3DR supports the following four scanning functions:

- VFO Scan
- Memory Channel Scan
- Programmable Memory Scan (PMS)
- Memory Bank Scan



For additional details on the Programmable Memory Scan (PMS) and Memory Bank Scan, refer to the Advanced Manual which may be downloaded from the Yaesu website.

VFO Scan

VFO scan function scans the frequencies, and detects signals.

1. Pres the **[V/M]** key to enter the VFO mode.
2. Touch **[F MW]**, and then touch **[SCAN]**.
 - Scanning starts toward higher frequencies.
 - If the **DIAL** knob is rotated while scanning is in progress, the scanning will continue up or down in frequency according to the direction of the **DIAL** Knob rotation.
 - If the scanner halts on an incoming signal, the back light will turn ON and the decimal point between the “MHz” and “kHz” digits of the frequency display will blink. Scanning will resume in about five seconds.
3. Press the **PTT** switch or touch **[STOP]** to cancel the scanning.

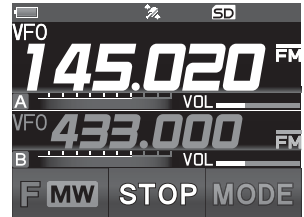
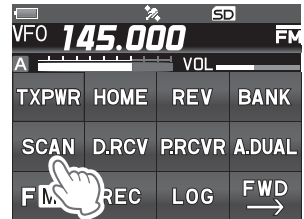

- If the scan has paused on a signal, rotating the DIAL knob will cause scanning to resume instantly.
- When turning the transceiver OFF while scanning, turning the transceiver ON, will cause scanning to resume.

Memory Channel Scanning

The receiver may be set to scan memory channels:

1. Recall a memory channel to begin memory scanning.
2. Touch **[F MW]**, and then touch **[SCAN]**.
 - Scanning starts toward higher memory channel numbers.
 - If the **DIAL** knob is rotated while scanning is in progress, the scanning will continue up or down in frequency according to the direction of the **DIAL** Knob rotation.
 - If the scanner halts on an incoming signal, the back light will turn ON and the decimal point between the “MHz” and “kHz” digits of the frequency display will blink. Scanning will resume in about five seconds.
3. Press the **PTT** switch or touch **[STOP]** to cancel the scanning.



If the scan has paused on a signal, rotating the DIAL knob will cause scanning to resume next memory channel.

Programmable Memory scan (PMS)

This function scans only the range of frequencies between the lower and upper limits registered in a pair of PMS Programmable Memory channels. 50 sets of PMS memory channels (L1/U1 to L50/U50) are available.

Dual Receive (DW) feature

The transceiver checks for signals on the frequency registered to the selected memory channel (Priority Memory Channel) once approximately every 5 seconds.

Bluetooth® Operation

The FT3DR has built-in Bluetooth® functionality, so hands-free operation is possible using the optional Bluetooth® headset (SSM-BT10) or a commercially available Bluetooth® headset.

About communicable range

The communicable distance between SSM-BT10 and FT3DR is about 10m, but it changes greatly depending on the surrounding conditions and the human body.

When connecting to a Bluetooth Headset for the first time -Pairing-

When using the Bluetooth Headset for the first time, the Bluetooth Headset and the FT3DR must be paired.

This step is necessary only once at the beginning.

1. Bluetooth headset into pairing mode.

SSM-BT10: Press and hold the Multi Function Button for 3 seconds, until the SSM-BT10 LED blinks red/blue alternately.

2. Press the **[DISP]** key, and then touch **[OPTION]**.

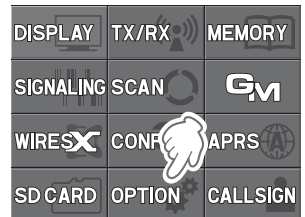

3. Touch **[2 Bluetooth]**, and then rotate the **DIAL** knob to select **[ON]**.

4. Touch **[LIST]**, and then touch **[SEARCH]**.

“**Searching**” is displayed and the model name of the found Bluetooth device is displayed in the list.

5. Rotate the **DIAL** knob to select the desired Bluetooth device.

6. Touch **[CONNECT]**.

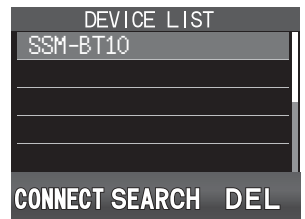

7. When pairing is complete and connected, the Bluetooth headset model name is displayed.

SSM-BT10: LED blinks blue.

8. Press the **PTT** switch to return to the normal operation.

Hands-free operation with a Bluetooth headset (VOX function)

When FT3DR's VOX (automatic voice transmission) function is turned on, you can use the Bluetooth headset to perform hands-free operation that transmits automatically just by talking.

Turn on the VOX function according to "VOX (automatic voice transmission) function".

Send by pressing the button on the Bluetooth headset (when the VOX function is off)

When the VOX function is OFF, pressing the "Call button"* on the Bluetooth headset once will keep the FT3DR in transmission and you can make a call using the Bluetooth headset.

If you press the "Call button"* again, FT3DR will return to the reception state.

*The button name may differ depending on your Bluetooth headset.

SSM-BT10: When press the Multi Function Key, a beep will sound and the FT3DR will continue to transmit.

Press the Multi Function Key again, a beep will sound and the FT3DR will be in receive mode.

VOX Operation

The VOX system provides automatic transmit/receive switching based on voice input to the microphone or Bluetooth Headset. With the VOX system enabled, you do not need to press the PTT switch in order to transmit, and it is not necessary to use a VOX headset in order to utilize VOX operation.

Setting VOX function

1. Press and hold the [DISP] key, and then touch [TX/RX].

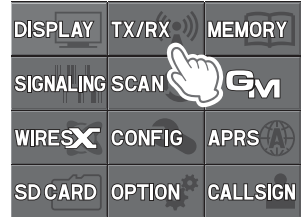

2. Touch [AUDIO], and then touch [4 VOX].
3. Press the [DISP] key, and then rotate the DIAL knob to select "LOW" or "HIGH".
OFF: VOX function OFF
LOW: VOX function ON (VOX Gain Lev "LOW")
HIGH: VOX function ON (VOX Gain Lev "HIGH")
4. Press the PTT switch to return to the normal operation.

Disable the VOX function

To cancel VOX and return to PTT operation, just repeat the above procedures, selecting "OFF" in step 3 above.

Set the VOX (automatic voice transmission) delay time

During transmission with VOX (automatic voice transmission) function, set the time to stop speaking and return to reception.

1. Press and hold the [DISP] key, and then touch [TX/RX].

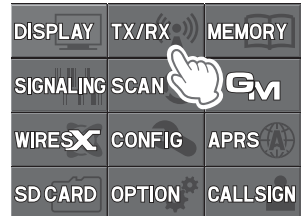

2. Touch [AUDIO], and then touch [4 VOX].
3. Rotate the DIAL knob to select [DELAY].
4. Press the [DISP] key, and then rotate the DIAL knob to select to select the delay time (the transmit-receive delay after the cessation of speech).
0.5sec / 1.0sec / 1.5sec / 2.0sec / 2.5sec / 3.0sec
5. Press the PTT switch to return to the normal operation.

Band Scope

The Spectrum Analyzer presents a view of operating activity on channels above and below the current main band operating frequency as the center.

1. Touch [**F MW**].
2. Touch [**FWD →**], and then touch [**SCOPE**].
3. With the current frequency in the center, the signal strengths of 39 channels bandwidth are shown on a graph.
4. Touch [**STOP**].

The band scope scanning stops.

- To resume band scope scanning, touch [**SEARCH**].
5. To turn the Band Scope OFF, press the [**BACK**] key.

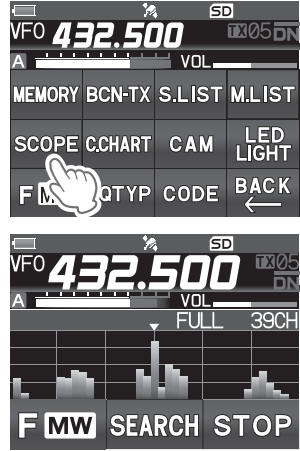

- Press and hold the [DISP] key → [DISPLAY] → [3 BAND SCOPE]. The number of band scope channels can be changed to 19, 39 or 79.
- The band scope channel interval is the same as the VFO frequency step.

GPS Function

FT3DR is equipped with GPS (Global Positioning System) reception function. When receiving signals from GPS satellites, the current position (latitude, longitude, altitude) can be calculated and displayed within the tolerance of several meters. In addition, GPS can receive the exact time from a satellite-mounted atomic clock.



For additional details on the following Functions, refer to the Advanced Manual which may be downloaded from the Yaesu website.

Tone squelch feature

The tone squelch opens the speaker audio only when a signal containing the specified CTCSS tone is received. By matching the tone frequency with the partner station in advance, a quiet standby is possible.

Digital Code squelch (DCS) feature

DCS (Digital Coded Squelch) function that allows audio to be heard only when signals containing the same DCS code are received.

Digital Personal ID (DP-ID) feature

Digital Personal ID (DP-ID) feature opens the speaker audio only when a signal set to the same DP-ID in the Digital Mode is received.

Using Set Mode

The Set Mode permits configuring the various functions according to individual operating needs and preferences.

Set Mode Operation

1. Press and hold the **[DISP]** key.
The SET MODE screen will be displayed.

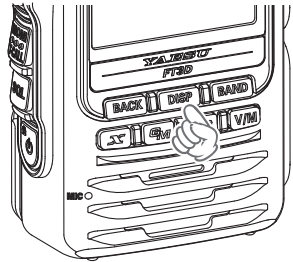

2. Touch the desired item in Set Mode.
The Sub-menu screen will be displayed.

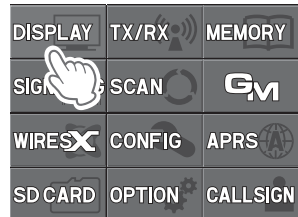

3. Touch the desired Set Mode Sub-menu.
4. Rotate the **DIAL** knob to select the desired item to set.
[When there is no deeper level of menu items]
Go step 6.
[When there is deeper level of menu items]
5. Press the **[DISP]** key.
6. Rotate the **DIAL** to select the desired item to set.
7. Press the **PTT** switch to save the settings and return to normal operation.
On some setting screens, pressing **PTT** switch does not exit from Menu Mode. In this case, press the **[BACK]** key several times to return to the frequency display screen.

Tables of Set Mode Operations

Set mode no. / item	Description	Selectable options (Options in bold are the default settings)
DISPLAY		
1 TARGET LOCATION	Set what to display using the smart navigation function.	COMPASS / NUMERIC
2 COMPASS	Set the compass display of the smart navigation function.	HEADING UP / NORTH UP
3 BAND SCOPE	Set the number of search channels for the band scope function.	17ch / 35ch / 71ch
4 LAMP	Set the duration time of the backlight and keys to be lit.	KEY: OFF / 2 to 180 / CONTINUOUS KEY 30Sec SAVE: ON / OFF
5 LANGUAGE	Switch between Japanese/English for the menus and Set mode, etc.	ENGLISH / JAPANESE
6 LCD DIMMER	Set the brightness level of the LCD backlight and numeric keypad light.	LEVEL1 to LEVEL6
7 OPENING MESSAGE	Set the opening message type.	OFF / DC / MESSAGE
8 SENSOR INFO	Display the voltage.	DC
9 SOFTWARE VERSION	Display the software version.	Main / Sub / DSP
TX/RX		
1 MODE		
1 ANTENNA ATT	Switch the attenuator between ON/OFF.	ON / OFF
2 FM BANDWIDTH	Set the FM transmission modulation level.	WIDE / NARROW
3 RX MODE	Select the receive mode.	AUTO / FM / AM
2 DIGITAL		
1 DIGI POPUP	Set the POP UP time.	OFF / BAND2s / BAND4s / BAND6s / BAND8s / BAND10s / BAND20s / BAND30s / BAND60s / BNCNT
2 LOCATION SERVICE	Set whether or not to display your current location in digital mode.	ON / OFF
3 STANDBY BEEP	Switch the standby beep function between ON/OFF.	ON / OFF
4 DIGITAL VW	Turn the VW mode selection ON or OFF.	OFF / ON
3 AUDIO		
1 MIC GAIN	Adjust the microphone gain level.	LEVEL1 to LEVEL9 LEVEL5
2 MUTE	Set the muting level on the nonoperating band side when a signal is received on the operating band side.	OFF / MUTE 30% / MUTE 50% / MUTE 100%
3 RX AF DUAL	Set the resumption time of radio reception in the AF Dual mode.	Transmit and receive 1 second to 10 seconds, Fixed, or transmission 1 second to 10 seconds. Transmit and receive 2 seconds
4 VOX	VOX function setting.	VOX: OFF / LOW / HIGH DELAY: 0.5s / 1.0s / 1.5s / 2.0s / 2.5s / 3.0s
5 RECODE	Voice recode function setting.	BAND: A / B / A+B MIC: ON / OFF

Set mode no. / item	Description	Selectable options (Options in bold are the default settings)
MEMORY		
1 BANK LINK	Set the memory bank link.	BANK1 to BANK24 BANK LINK ON / OFF
2 BANK NAME	Assign a name to each memory bank.	BANK1 to BANK24
3 MEMORY NAME	Input the memory channel tag.	Up to 16 letters
4 MEMORY PROTECT	Set whether to allow or prohibit memory channel registration.	ON / OFF
5 MEMORY SKIP	Set for skip memory / specify memory.	OFF / SKIP / SELECT
6 MEMORY WRITE	Set the automatic channel number increment when registering to a memory channel.	NEXT / LOWER
SIGNALING		
1 BELL	Set the bell function settings.	SELECT: OFF / BELL RINGER: 1Time to 20Time / CONTINUOUS
2 DCS CODE	Set the DCS code.	DCS 023 to DCS 754
3 DCS INVERSION	Select a combination of DCS inversion codes in terms of communication direction.	RX (Receive): NORMAL (Homeomorphic) / INVERT (Inversion) / BOTH (Both Phase) TX (Transmission): NORMAL (Homeomorphic) / INVERT (Inversion)
4 DTMF MODE	Set the transmission of DTMF code registered to a DTMF memory channel, DTMF code transmission delay time, and DTMF code transmission speed.	MODE: MANUAL / AUTO DELAY: 50ms / 250ms / 450ms / 750ms / 1000ms SPEED: 50ms / 100ms
5 DTMF MEMORY	Set the DTMF auto dialer channel and code (16 characters).	CH1 to CH10
6 PAGER	Turn the pager answerback Function ON/OFF, and specify a personal code (transmit/receive).	ANS-BACK: ON / OFF CODE-RX: 01 to 50 for each, 05 47 CODE-TX: 01 to 50 for each, 05 47
7 PR FREQUENCY	Set a non-communication squelch.	300Hz to 3000Hz 1600Hz
8 SQL LEVEL	Select a squelch level.	LEVEL0 to LEVEL15 LEVEL1
9 SQL S-METER	Select an S-Meter squelch level.	OFF / LEVEL1 to LEVEL10
10 SQL EXPANTION	Set a squelch type separately for Receive and transmit.	ON / OFF
11 SQL TYPE	Select a squelch type.	OFF / TONE / TONE SQL / DCS / REV TONE / PR FREQ / PAGER / (D CD) / (TONE-DCS) / (D CD-TONE SQL) * The options in the parentheses are available when the SQL expansion is ON.
12 TONE SQL FREQ	Set a tone frequency.	67.0Hz to 254.1Hz
13 TONE-SRCH	Set the audio output during tone search. Turn the muting function on/off and select a tone search speed.	MUTE: ON / OFF SPEED: FAST / SLOW
14 WX ALEAT	Enables/Disables the Weather Alert Feature.	ON / OFF
SCAN		
1 DW TIME	Set the priority memory channel monitoring interval.	0.1sec to 10sec 5.0sec
2 SCAN LAMP	Set whether or not to light up the scan lamp when scanning stops.	ON / OFF
3 SCAN RE-START	Set the scanning restart time.	0.1sec to 10sec 2.0sec
4 SCAN RESUME	Configure the scan stop mode settings.	SCAN: BUSY / HOLD / 2.0sec to 10sec 5.0sec DW: BUSY / HOLD / 2.0sec to 10.0sec
5 SCAN WIDTH	Set the scan mode operation.	VFO: ALL / BAND MEMORY: ALL CH / BAND BANK LINK: ON / OFF

Set mode no. / item	Description	Selectable options (Options in bold are the default settings)
6 PRIORITY REVERT	Turn the "Priority Channel Revert" feature ON or OFF during Dual Receive.	ON / OFF
GM		
* For details of the functions, refer to the GM Function Instruction Manual.		
1 DP-ID LIST	Displays the DP-ID list screen.	-
2 RADIO ID CHECK	Display the transceiver specific number (ID). (Uneditable)	-
WIRES-X		
* For details of the functions, refer to the WIRES-X Instruction Manual.		
1 RPT/WIRES FREQ	Set the frequency to be used for Repeater/WIRES.	MANUAL / PRESET
2 SEARCH SETUP	Set the WIRES ROOM selection method.	HISTORY / ACTIVITY
3 EDIT CATEGORY TAG	Edit category tags.	C1 to C5
4 REMOVE ROOM/NODE	Delete registered Category ROOMs.	C1 to C5
5 DG-ID	Set the DG-ID number for WIRES-X.	01 to 99 / AUTO
CONFIG		
1 APO	Set the length of time until the transceiver turns off automatically.	OFF / 0.5HOUR to 12HOUR
2 BCLO	Turn on/off the busy channel lockout function.	ON / OFF
3 BEEP	Set the beep emitting function, and set whether or not to emit the beep sound when a band edge/CH1 is encountered.	SELECT: KEY&SCAN / KEY / OFF EDGE: ON / OFF
4 BUSY LED	Turn on/off the BUSY indicator.	A BAND: ON / OFF B BAND: ON / OFF RADIO: ON / OFF
5 CLOCK TYPE	Set the clock shift function.	A / B
6 GPS LOG	Set the GPS log recording time interval.	OFF / 1sec / 2sec / 5sec / 10sec / 30sec / 60sec
7 HOME VFO	Enable/disable VFO transmission in Home Channel.	ENABLE / DISABLE
8 LOCK	Configure the lock mode setting.	KEY&DIAL / PTT / KEY&PTT / DIAL&PTT / ALL / KEY / DIAL
9 MONI/T-CALL	Select the function of the MONI/ T-CALL switch.	MONI / T-CALL
10 TIMER	Switch the timer between ON and OFF.	POWER ON: 00:00 ~ 23:59 POWER OFF: 00:00 ~ 23:59
11 PASSWORD	Input the password.	OFF / ON : - - - -
12 PTT DELAY	Set the PTT delay time.	OFF / 20ms / 50ms / 100ms / 200ms
13 RPT ARS	Turn the ARS function on/off.	ON / OFF
14 RPT SHIFT	Set the repeater shift direction.	SIMPLEX / -RPT / +RPT
15 RPT SHIFT FREQ	Set the repeater shift width.	0.000MHz to 150.000MHz
16 SAVE RX	Set the receive save time.	OFF / 0.2sec (1:1) to 60.0sec (1:300)
17 STEP	Set the channel step.	AUTO / 5.0KHz / 6.25KHz / (8.33KHz) / (9.0KHz) / 10.0KHz / 12.5KHz / 15.0KHz / 20.0KHz / 25.0KHz / 50.0KHz / 100KHz
18 DATE & TIME ADJ	Set the built-in clock.	-
19 TOT	Set the timeout timer.	OFF / 30sec to 10MIN
20 VFO MODE	Select the frequency selection range in the VFO mode.	ALL / BAND
21 DIAL KNOB CHANGE	Select a vibrator mode and set up the vibrator function.	-

Set mode no. / item	Description	Selectable options (Options in bold are the default settings)
APRS		
* For details of the functions, refer to the APRS Instruction Manual.		
1 APRS AF DUAL	Turn ON/OFF the muting function when both the APRS function and AF dual function are active.	ON / OFF
2 APRS DESTINATION	Display the model code.	APY03D (Uneditable)
3 APRS FILTER	Select the filter function.	Mic-E: ON / OFF POSITION: ON / OFF WEATHER: ON / OFF OBJECT: ON / OFF ITEM: ON / OFF STATUS: ON / OFF OTHER: ON / OFF ALTNET: ON / OFF
4 APRS MODEM	Set the APRS baud rate.	OFF / 1200bps / 9600bps
5 APRS MSG FLASH	Set the strobe to flash when there is an incoming message.	MSG: OFF / 2sec to 60sec / CONT / EVERY 2s to EVERY 10m 4sec GRP: OFF / 2sec to 60sec / CONT / EVERY 2s to EVERY 10m 4sec BLN: OFF / 2sec to 60sec / CONT / EVERY 2s to EVERY 10m 4sec
6 APRS MSG GROUP	Group filtering for received messages.	G1: ALLxxxxxx G2: CQxxxxxx G3: QSTxxxxxx G4: YAESUxxxxxx G5: - - - - - B1: BLNxxxxxx B2: BLNxxxxxx B3: BLNxxxxxx
7 APRS MSG TXT	Input the fixed text message.	1 to 8
8 APRS MUTE	Set the B-band AF muting function on/off when APRS is active.	ON / OFF
9 APRS POPUP	Set the beacon type, message type and time for pop-up display.	The setting values of Mic-E, POSITION, WEATHER, OBJECT, ITEM, STATUS, OTHER, MY PACKET, MSG, GRP and BLN are as follows. OFF / ALL2s to ALL60s / ALLCNT / BND2s to BND60s / BNDCNT ALL10s The setting values of MY MSG, DUP.BCN, DUP.MSG, ACK.REJ and OTHER MSG are as follows.: OFF / BND2s to BND60s BND10s

Set mode no. / item	Description	Selectable options (Options in bold are the default settings)
10 APRS RINGER	Set the bell ring on/off when a beacon or message is received.	Mic-E: ON / OFF POSITION: ON / OFF WEATHER: ON / OFF OBJECT: ON / OFF ITEM: ON / OFF STATUS: ON / OFF OTHER: ON / OFF MY PACKET: ON / OFF MSG: ON / OFF GRP: ON / OFF BLN: ON / OFF MY MSG: ON / OFF DUP.BCN: ON / OFF DUP.MSG: ON / OFF ACK.REJ: ON / OFF OTHER MSG: ON / OFF TX BCN: ON / OFF TX MSG: ON / OFF
11 APRS UNIT	Select the units for APRS display.	POSITION: MM.MM' / MM'SS" DISTANCE: km / mile SPEED: km/h / knot / mph ALTITUDE: m / ft TEMP: / RAIN: mm / inch WIND: m/s / mph
12 APRS TX DELAY	Set the data sending delay time.	100ms to 1000ms 300ms
13 BEACON INFO	Set the transmission beacon information.	AMBIGUITY: OFF / 1dig / 2dig / 3dig / 4dig SPD/CSE: ON / OFF ALTITUDE: ON / OFF
14 BEACON INTERVAL	Set a beacon automatic sending interval.	30sec / 1min / 2min / 3min / 5min / 10min / 15min / 20min / 30min / 60min
15 BEACON STATS TXT	Input setting for status text.	S.TXT: ON / OFF TX RATE: 1/1 to 1/8 TEXT: TEXT1 to TEXT5
16 BEACON TX	Select automatic or manual sending of beacon.	AUTO / MANUAL / (SMART)
17 COM PORT SETTING	Set the COM port.	STATUS: ON / OFF SPEED: 4800 / 9600 / 19200 / 38400 INPUT: OFF / GPS OUTPUT: OFF / GPS / WAY.P WAYPOINT: NMEA9 / NMEA6 / NMEA7 / NMEA8 Mic-E: ON / OFF POSIT: ON / OFF WEATHER: ON / OFF OBJECT: ON / OFF ITEM: ON / OFF
18 DIGI PATH	Set the digital repeater route.	P1 OFF P2(1) 1 WIDE1-1 P3(2) 1 WIDE2-1 / 2 WIDE2-1 P4(2) 1..... -.. / 2..... -.. P5(2) 1..... -.. / 2..... -.. P6(2) 1..... -.. / 2..... -.. P7(2) 1..... -.. / 2..... -.. P8(8) 1..... -.. to 8..... -..
19 GPS SETUP	Select a datum used for the GPS function.	DATUM: WGS-84 / Tokyo (Mean) PINNING: ON / OFF DGPS: ON / OFF
20 GPS POWER	Turn the GPS function ON/OFF.	ON / OFF
21 GPS TIME SET	Turn on/off the GPS time and date automatic acquisition function.	AUTO / MANUAL

Set mode no. / item	Description	Selectable options (Options in bold are the default settings)
22 GPS UNIT	Select the units for GPS display.	POSITION: .MMM' / 'SS" SPEED: km/h / knot / mph ALTITUDE: m / ft
23 CALLSIGN (APRS)	Specify the call sign of your station.	-----
24 MY POSITION	Set your location.	GPS / Manual / P1 to P10
25 MY SYMBOL	Set your station symbol.	48 icons including 1 (/[Human/Person]) / 2(/b Bicycle) / 3(/> Car) / 4(YY Yaesu Radios)
26 POSITION COMMENT	Set up the position comment function.	Off Duty / En Route / In Service / Returning / Committed / Special / Priority / Custom 0 to 6 / EMERGENCY!
27 SmartBeaconing	Set the smart beaconing function.	STATUS: OFF / TYPE1 / TYPE2 / TYPE3 * For details on the following setting items for each type, refer to the APRS Instruction Manual. LOW SPD, HIGH SPD, SLOW RATE, FAST RATE, TURN ANGL, TURN SLOP, TURN TIME
28 TIME ZONE	Set the time zone.	UTC -13:00 to UTC 0:00 to UTC +13:00 UTC 0:00
SD CARD		
1 BACKUP	Save the data stored on the transceiver onto a microSD memory card or load the data from a microSD card.	Write to SD / Read from SD
2 MEMORY CH	Save or load the memory channel information onto or from a microSD memory card.	Write to SD / Read from SD
3 MEMORY INFO	Displays the total capacity and free space of the SD Memory Card.	-
4 FORMAT	Initialize microSD memory cards.	-
OPTION		
1 USB CAMERA	Set the USB camera resolution and Speaker.	QUALITY: LOW / NORMAL / HIGH SP SEL: CAMERA / INT SP
2 Bluetooth	Sets the Bluetooth function.	OFF / ON CONNECT/DISCON
3 DEVICE LIST	Bluetooth device list.	-
4 Bluetooth Save	Turn ON/OFF the Bluetooth save function	OFF / ON
CALLSIGN		
1 CALLSIGN	Set the call sign.	xxxxxxxxxx

Caution

When the All Reset function is performed, all data registered in the memory will be deleted. Be sure to note the settings on paper or back up the data on a microSD memory card. For details on how to save backup onto a microSD memory card.

All Reset

To restore all transceiver settings and memory content to the factory defaults.

1. Turn the transceiver **OFF**.
2. Press and hold the **[BACK]** key, the **[DISP]** key and the **[BAND]** key and turn the transceiver **ON** simultaneously.
The beep sounds and the confirmation screen is displayed.
3. Touch **[OK]**.
 - The beep will sound, and the transceiver will reset all factory defaults.
 - After resetting all defaults, the call sign input message appears on the LCD. Set the call sign.
 - To cancel the resetting, touch **[CANCEL]**.

Set Mode Reset

All the Set mode only, settings can be restored to the default settings.

1. Turn the transceiver **OFF**.
2. Press and hold the **[BACK]** key and the **[DISP]** key and turn the transceiver **ON** simultaneously.
The beep sounds and the confirmation screen is displayed.
3. Touch **[OK]**.
 - The beep will sound, and the transceiver will reset all Set mode settings are reset to defaults.
 - To cancel the resetting, touch **[CANCEL]**.

Specifications

General

Frequency Range	: TX 144 - 148 MHz, 430 - 450 MHz : RX: A- Band 0.5 MHz - 729 MHz, 800 MHz - 985 MHz (Cellular Blocked) B- Band 108 MHz - 580 MHz
Channel Steps	: 5/6.25/(8.33)/10/12.5/15/20/25/50/100 kHz () Air Band
Mode of Emission	: F2D, F3E, F7W
Frequency Stability	: ± 2.5 ppm (-4°F to +140°F [-20°C to +60°C])
Antenna Impedance	: 50 Ω
Supply Voltage	: Nominal 7.2 V DC, Negative Ground (SBR-14LI) Nominal 7.4 V DC, Negative Ground (FNB-101LI) Operating 4 - 14 V DC, Negative Ground (Battery Connect) 11 - 16 V DC, Negative Ground (EXT DC JACK, Charging)
Current Consumption (Approx.)	: 140 mA (Mono Band Receive) 180 mA (Dual Band Receive) 80 mA (Mono Band Receive, Standby) 110 mA (Dual Band Receive, Standby) 67 mA (Mono Band Receive, Standby, Saver On "Save Ratio 1:10") 67 mA (Dual Band Receive, Standby, Saver On "Save Ratio 1:10") + 18 mA (GPS On) + 6mA (Digital) 120mA (AM / FM Radio) 900 μ A (Auto Power Off) 1.6 A (5 W TX, 144 MHz 7.4 V DC) 1.9 A (5 W TX, 430 MHz 7.4 V DC)
Operating Temperature Range	: -4°F to +140°F (-20°C to +60°C)
Case Size (W x H x D)	: 2.44" x 3.94" x 1.28" (62 x 100 x 32.5 mm) (with SBR-14LI, w/o knob, antenna & Belt clip)
Weight (Approx.)	: 9.95 oz (282 g) (with SBR-14LI & Antenna)
Transmitter	
Output Power	: 5 W (@ 13.8 V or SBR-14LI) (MID3: 2.5 W / LOW2: 1.0 W / LOW1: 0.5W) 0.9 W (FBA-39) (LOW1: 0.5 W)
Modulation Type	: F1D, F2D, F3E: Variable Reactance Modulation F7W: 4 FSK (C4FM)
Spurious Emission	: At least 60 dB below (@TX Power HI, LOW3) At least 50 dB below (@TX Power LOW2, LOW1)

Receiver

Circuit Type	: Double-conversion super heterodyne (FM / AM) Direct-conversion (AM / FM Radio)
Intermediate Frequency	: 1st: A- Band 58.05 MHz 1st: B- Band 57.15 MHz 2nd: A- Band, B- Band 450 kHz
Sensitivity	: 0.5 - 30 MHz (AM)* 3 μ V typ @10 dB SN 30 - 54 MHz (NFM)* 0.35 μ V typ @12 dB SINAD 54 - 76 MHz (NFM)* 1 μ V typ @12 dB SINAD 76 - 108 MHz (WFM)* 1.5 μ V typ @12 dB SINAD 108 - 137 MHz (AM) 1.5 μ V typ @10 dB SN 137 - 140 MHz (NFM) 0.2 μ V @12 dB SINAD 140 - 150 MHz (NFM) 0.16 μ V @12 dB SINAD 150 - 174 MHz (NFM) 0.2 μ V @12 dB SINAD 174 - 222 MHz (NFM) 1 μ V @12 dB SINAD 222 - 225 MHz (NFM) 0.5 μ V @12 dB SINAD 300 - 350 MHz (NFM) 0.5 μ V @12 dB SINAD 350 - 400 MHz (NFM) 0.2 μ V @12 dB SINAD 400 - 470 MHz (NFM) 0.18 μ V @12 dB SINAD 470 - 580 MHz (NFM) 1.5 μ V @12 dB SINAD 580 - 800 MHz (NFM)* 3 μ V @12 dB SINAD 800 - 985 MHz (NFM)* 1.5 μ V @12 dB SINAD Digital Mode 0.19 μ V typ @BER1% * A- Band only
Selectivity (-6 dB/-60 dB)	: NFM, AM 12 kHz/35 kHz
AF Output	: 700 mW (16 Ω for THD 10 % 7.4 V DC) internal speaker 300 mW (8 Ω for THD 10 % 7.4 V DC) internal speaker

Bluetooth

Version	: Version 4.2
Class	: Class 2
Output Power	: 2 dBm typ

Specifications are subject to change without notice, and are guaranteed within the 144/430 MHz amateur bands only.

Changes or modifications to this device that are not expressly approved by YAESU MUSEN could void the user's authorization to operate this device.

This device complies with part 15 of the FCC Rules. Operation is subject to the following two conditions: (1) This device may not cause harmful interference, and (2) this device must accept any interference including received, interference that may cause undesired operation.

The scanning receiver in this equipment is incapable of tuning, or readily being altered, by the User to operate within the frequency bands allocated to the Domestic public Cellular Telecommunications Service in Part 22.

The YAESU MUSEN is not responsible for any changes or modifications not expressly approved by the party responsible for compliance. Such modifications could void the user's authority to operate the equipment.

This device complies with ISED's applicable license-exempt RSS standard(s). Operation is subject to the following two conditions: (1) this device may not cause interference, and (2) this device must accept any interference, including interference that may cause undesired operation of the device.

Le présent appareil est conforme aux CNR d'Industrie Canada applicables aux appareils radio exempts de licence. L'exploitation est autorisée aux deux conditions suivantes : (1) l'appareil ne doit pas produire de brouillage, et (2) l'utilisateur de l'appareil doit accepter tout brouillage radioélectrique subi, même si le brouillage est susceptible d'en compromettre le fonctionnement.

DECLARATION BY MANUFACTURER

The Scanner receiver is not a digital scanner and is incapable of being converted or modified to a digital scanner receiver by any user.

WARNING: MODIFICATION OF THIS DEVICE TO RECEIVE CELLULAR RADIOTELEPHONE SERVICE SIGNALS IS PROHIBITED UNDER FCC RULES AND FEDERAL LAW.

CAN ICES-3 (B) / NMB-3 (B)

This equipment has been tested and found to comply with the limits for a Class B digital device, pursuant to part 15 of the FCC Rules. These limits are designed to provide reasonable protection against harmful interference in a residential installation. This equipment generates, uses, and can radiate radio frequency energy; and, if not installed and used in accordance with the instructions, may cause harmful interference to radio communications. However, there is no guarantee that interference will not occur in a particular installation.

If this equipment does cause harmful interference to radio or television reception, which can be determined by turning the equipment off and on, the user is encouraged to try to correct the interference by one or more of the following measures:

- Reorient or relocate the receiving antenna.
- Increase the separation between the equipment and receiver.
- Connect the equipment into an outlet on a circuit different from that to which the receiver is connected.
- Consult the dealer or an experienced radio/TV technician for help.

This equipment complies with FCC/IC radiation exposure limits and meets the FCC radio frequency (RF) Exposure Guidelines and RSS-102 of the IC radio frequency (RF) Exposure rules. This equipment has very low levels of RF energy that is deemed to comply without testing of specific absorption rate (SAR).

This transmitter must not be co-located or operated in conjunction with any other antenna or transmitter.

YAESU

Declaration of Conformity

Type of Equipment:	144/430MHz Digital/Analog Transceiver
Brand Name:	YAESU
Model Number:	FT3DR
Manufacturer:	YAESU MUSEN CO., LTD.
Address of Manufacturer:	Tennozu Parkside Building, 2-5-8 Higashi-Shinagawa, Shinagawa-ku, Tokyo 140-0002 Japan

This device complies with part 15 of the FCC Rules. Operation is subject to the following two conditions; (1) this device may not cause harmful interference, and (2) this device must accept any interference received, including interference that may cause undesired operation.

The technical documentation as required by the Conformity Assessment procedures is kept at the following address:

Company: Yaesu U.S.A.

Address: 6125 Phyllis Drive, Cypress, CA 90630, U.S.A.

Telephone: (714) 827-7600

YAESU

The radio

Copyright 2019
YAESU MUSEN CO., LTD.
All rights reserved.

No portion of this manual may be
reproduced without the permission of
YAESU MUSEN CO., LTD.

YAESU MUSEN CO., LTD.

Tennozu Parkside Building
2-5-8 Higashi-Shinagawa, Shinagawa-ku, Tokyo 140-0002 Japan

YAESU USA

6125 Phyllis Drive, Cypress, CA 90630, U.S.A.

YAESU UK

Unit 12, Sun Valley Business Park, Winnall Close
Winchester, Hampshire, SO23 0LB, U.K.

Printed in Japan

EH072M100
E H 0 7 2 M 1 0 0