

YAESU
The radio

VHF/UHF

DUAL BAND TRANSCEIVER

FT-65R/E

OPERATING MANUAL

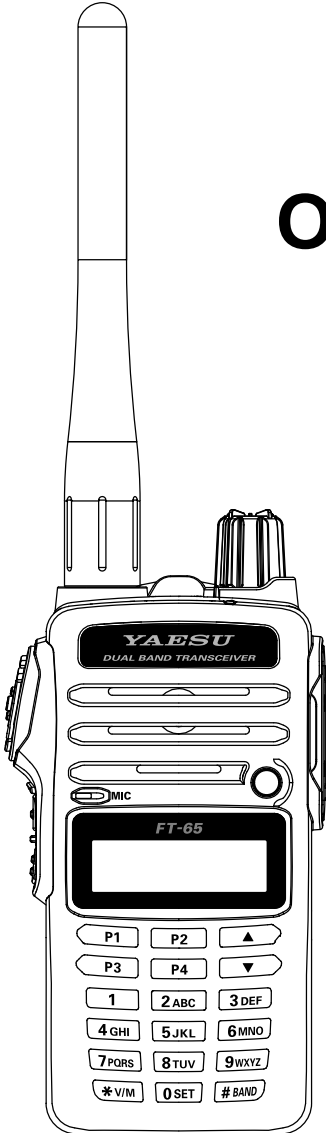

YAESU MUSEN CO., LTD.

Tennozu Parkside Building
2-5-8 Higashi-Shinagawa, Shinagawa-ku, Tokyo 140-0002 Japan

YAESU USA

6125 Phyllis Drive, Cypress, CA 90630, U.S.A.

YAESU UK

Unit 12, Sun Valley Business Park, Winnall Close
Winchester, Hampshire, SO23 0LB, U.K.

CONTENTS

Accessories & Options	1
Supplied Accessories	1
Available Options	1
Control & Connections (Top & Front Panel)	2
Control & Connections (Side Panel)	3
Installation of Accessories	4
Antenna Installation	4
Installation of SBR-25LI Battery Pack	4
Battery Charging	5
Low Battery Indication	5
Operation	6
Switching Power On and Off	6
Adjusting the Audio Volume Level and Squelch Setting	6
Selecting the Operating Band	6
Frequency Navigation	7
Transmission	8
Advanced Operation	9
Keypad Locking	9
Repeater Operation	10
Repeater Shifts	10
Automatic Repeater Shift (ARS)	10
Manual Repeater Shift Activation	10
CTCSS/DCS Operation	12
CTCSS Operation	12
DCS Operation	13
Memory Mode	14
Memory Storage	15
Memory Recall	15
HOME Channel Memory Recall	16
Deleting Memories	16
Weather Broadcast Channels (U. S. Version)	16
FM Broadcast Receiving	17
Scanning	18
VFO Scanning	18
Memory Scanning	19
Weather Alert Scan	21
Miscellaneous Settings	23
Changing the Channel Steps	23
Reset Procedures	24
Set (Menu) Mode	25
Specifications	27

ACCESSORIES & OPTIONS

SUPPLIED ACCESSORIES

- SBR-25LI** 7.4 V, 2,000 mAh
Rechargeable Lithium-Ion Battery Pack
 - SAD-20B** AC Adapter (for USA/EXP model)
 - SAD-20C/U** AC Adapter (for European model)
 - SBH-22** Rapid Charger
 - Belt Clip
 - Antenna
 - Operating Manual
 - Warranty Card
-

AVAILABLE OPTIONS

- SBR-26LI** 7.4 V, 2600 mAh
Rechargeable Lithium-Ion Large-Capacity Battery Pack

Availability of accessories may vary. Some accessories are supplied as standard per local requirements, while others may be unavailable in some regions. This product is designed to perform optimally when used with genuine Yaesu accessories. Yaesu shall not be liable for any damage to this product and/or accidents such as fire, leakage or explosion of a battery pack, etc., caused by the malfunction of non-Yaesu accessories. Consult your Yaesu dealer for details regarding these and any newly-available options. Connection of any non-Yaesu-approved accessory, should it cause damage, may void the Limited Warranty on this apparatus.

CONTROL & CONNECTIONS (TOP & FRONT PANEL)

① Antenna Jack

Connect the supplied rubber flex antenna (or another antenna presenting a 50-Ohm impedance) here.

② Emergency Switch

- Pressing this switch shortly turns on the LED Flash-Light.
- Pressing and hold it for 3sec enables the Emergency Alarm beep functions.
- Press the **FW** key on the keypad first, then press this switch to blink the LED Flash-Light for SOS

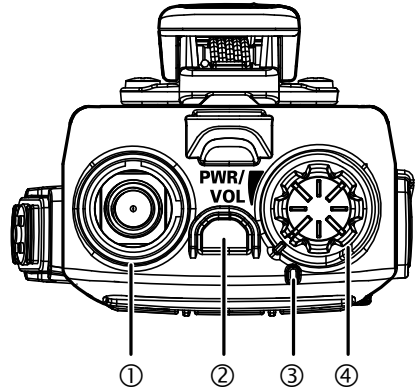

③ TX/BUSY Indicator Lamp

This indicator glows green when the squelch opens, and turns red during transmit.

④ PWR/VOL Knob

Turn this control clockwise to turn the radio on and to increase the volume. Counter-clockwise rotation into the click-stop will turn the radio off.

⑤ Speaker

The internal speaker is located here.

⑥ Microphone

The internal microphone is located here.

⑦ LED Flash-Light

⑧ LCD (Liquid Crystal Display)

The display shows current operating condition.

⑨ Keypad

These 18 keys select many of most important operating features on the FT-65R/E.

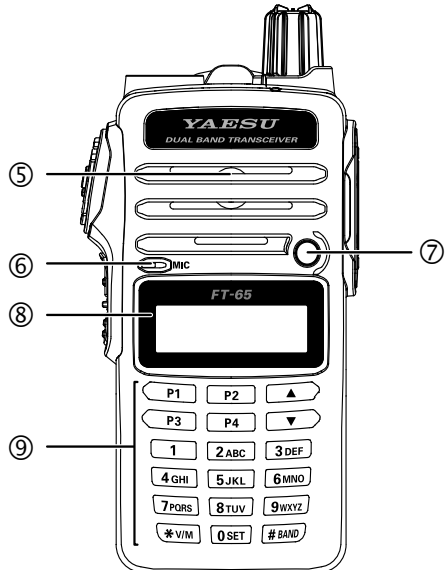

CONTROL & CONNECTIONS (SIDE PANEL)

① PTT (Push To Talk) Switch

- Press this switch to transmit, and release it (to receive) after your transmission is completed.
- In the Set mode, press this switch to save the new setting and return to normal operation.

② MONI/T.CALL Switch(selectable version from Set mode)

USA/EXP Version:

Pressing this switch opens the noise squelching action, allowing you to hear very weak signals near the background noise level temporarily.

Europe Version:

Pressing this switch activates the T-CALL (1750 Hz) for repeater access.

③ F/W key

- Press this key, then press [0 SET] to activate Set mode.
- Press this key, then press the [6] key to lock out the keypad.

④ SP Jack

This three-conductor miniature jack provides connection points for external speaker.

⑤ MIC Jack

This three-conductor miniature jack provides connection points for microphone audio, earphone audio, PTT, and ground.

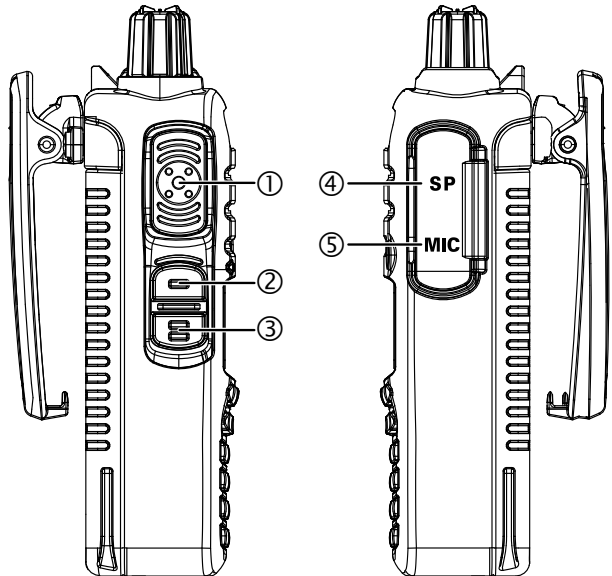

INSTALLATION OF ACCESSORIES

ANTENNA INSTALLATION

The supplied antenna provides good results over the entire frequency range of the transceiver. However, for enhanced reception on certain non-Amateur frequencies, you may wish to connect an antenna designed specifically for that frequency range, as the supplied antenna is necessarily a compromise outside the Amateur bands, and cannot be expected to provide high performance at all frequencies.

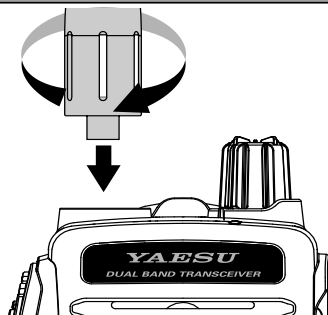

To install the supplied antenna, hold the bottom end of the antenna, then screw it onto the mating connector on the transceiver until it is snug. Do not over-tighten by use of extreme force.

Notes:

- Never transmit without having an antenna connected.
- When installing the supplied antenna, never hold the *upper* part of the antenna while screwing it onto the mating connector on the transceiver.
- If using an external antenna for transmission, ensure that the SWR presented to the transceiver is 1.5:1 or lower, to avoid excessive feedline loss.

INSTALLATION OF SBR-25LI BATTERY PACK

The **SBR-25LI** is a high-performance Li-Ion battery providing high capacity in a compact package. Under normal use, the **SBR-25LI** may be used for approximately 300 charge cycles, after which operating time may be expected to decrease. If you have an old battery pack which is displaying capacity which has become diminished, you should replace the pack with a new one.

Installation of the battery is easy and quick:

- ❑ Insert the battery pack into the battery compartment on the back of the radio while tilting the Belt Clip outward, then close the Battery Pack Latch until it locks in place with a “Click.”
- ❑ To remove the battery, turn the radio off and remove any protective cases. Open the Battery Pack Latch on the bottom of the radio, then slide the battery downward and out from the radio while tilting the Belt Clip out of the way.

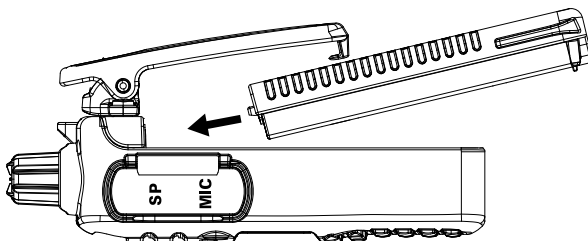

INSTALLATION OF ACCESSORIES

BATTERY CHARGING

If the battery has never been used, or its charge is depleted, it may be charged by connecting the **SAD-20** AC adapter to the **SBH-22** desktop charger, and place the **FT-65R/E** in the desktop charger cradle.

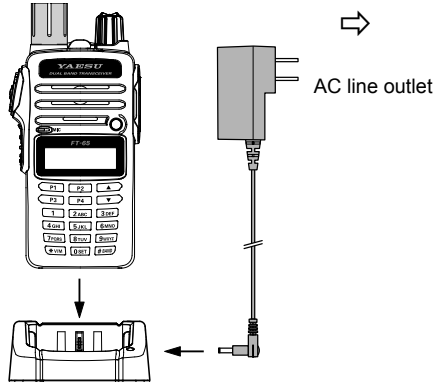



FT-65R/E / SBH-22 with SAD-20

A fully-discharged pack will be charged completely in **10 hours**. Disconnect the **SAD-20** from the **EXT DC** jack and the AC line outlet. If you use the **SBH-22** Rapid Charger, a fully-discharged pack will charge completely in 2.5 - 3 hours (de-pending on the battery being charged).

Important Note

- The SAD-20 is not designed to power the transceiver for operation (reception or transmission).**
- Do not leave the SAD-20 connected to the transceiver for continuous periods in excess of 24 hours. Long term overcharging can degrade the Li-Ion battery pack and significantly shorten its useful life (European and Asian versions).**
- Please be advised that the SAD-20 may contribute noise to TV and radio reception in the immediate vicinity, so we do not recommend its use adjacent to such devices.**

LOW BATTERY INDICATION

- As your battery discharges during use, the voltage will gradually become lower. When the battery voltage is becoming too low for reliable operation, the “” icon will blink on the LCD display, indicating that the battery pack must be recharged before further use.
- Avoid recharging Li-Ion batteries before the “” indicator is observed, as this can degrade the charge capacity of your Li-Ion battery pack.



OPERATION

SWITCHING POWER ON AND OFF

- ❑ Be sure the Battery Pack is installed, and that the battery is fully charged. Connect the antenna to the top panel Antenna jack.
- ❑ Rotate the top panel's **PWR/VOL** knob out of the click-stop to turn on the radio. The current DC supply voltage will be indicated on the display for 2 seconds. After this 2 second interval, the display will resume its normal indication of the operating frequency.
- ❑ To turn the radio off, turn the **PWR/VOL** knob fully counter-clockwise into the click stop position.

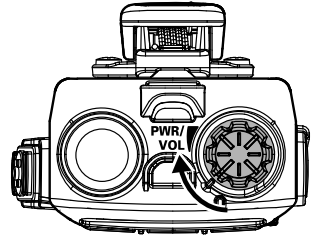

ADJUSTING THE AUDIO VOLUME LEVEL AND SQUELCH SETTING

- ❑ You may rotate The **PWR/VOL** knob to adjust the receiver level for a comfortable listening level, using the background noise as a reference.
- ❑ To set the squelch level, press **F/W key** and then press **MONI/T.CALL Switch** to open the SQ LEVEL mode. Press the [▲] or [▼] key to select the level which the background noise is muted. Press **PTT switch** to save the squelch setting and back to the normal operation.

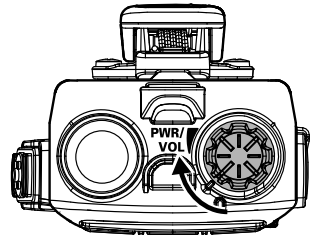

SELECTING THE OPERATING BAND

- ❑ Press the [**#BAND**] key repetitively. This key toggles frequency control between 144 MHz Band and 430 MHz Band each time you press the [**#BAND**] key.
- ❑ Once you have selected the desired band, you may initiate manual tuning (or scanning) per the discussion in the next chapter.

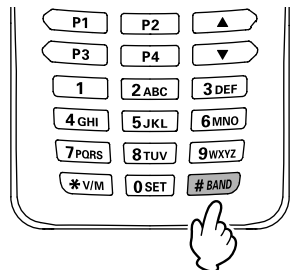

Frequency Range				
	RX	TX	RX	TX
USA model	136-174 MHz	144-148 MHz	400-480 MHz	430-450 MHz
EU model	136-174 MHz	144-146 MHz	400-480 MHz	430-440 MHz
EXP model	136-174 MHz	136-174 MHz	400-480 MHz	400-470 MHz

OPERATION

FREQUENCY NAVIGATION

The **FT-65R/E** will initially be operating in the “VFO” mode, a channelized system which allows free tuning throughout the currently-selected operating band. Three basic frequency navigation methods are available on the **FT-65R/E**:

1) Tuning Frequency

Pressing the [▲] or [▼] key allows tuning in the pre-programmed steps established for the current operating band. [▲] key causes the **FT-65R/E** to be tuned toward a higher frequency, while [▼] key will lower the operating frequency.

2) Direct Keypad Frequency Entry

The desired operating frequency may be entered directly from the keypad. To enter a frequency from the keypad, just press the numbered digits on the keypad in the proper sequence.

Examples:

To enter 145.560 MHz, press [1] → [4] → [5] → [5] → [6] → [0]

3) Scanning

Press and hold in either the [▲] or [▼] key for one second to initiate upward or downward scanning, respectively (Manual VFO Scan).

For scanning within a limited sub-band range, from the VFO mode, press and hold in the [#BAND] key for one second and to begin scanning toward a higher frequency within the previously-defined sub-band (Programmed VFO Scan).

If you wish to reverse the direction of the scan (i.e. toward a lower frequency, instead of a higher frequency), just push the [▼] key **while the FT-65R/E is scanning**. The scanning direction will be reversed. To revert to scanning toward a higher frequency once more, push the [▲].

The scanner will stop when it receives a signal strong enough to break through the Squelch threshold. The **FT-65R/E** will then hold on that frequency according to the setting of the “RESUME” mode (Set Mode Item **25: RESUME**). Press the **PTT** switch momentarily to cancel the scanning. This only stops the scan; it does not cause transmission to occur.

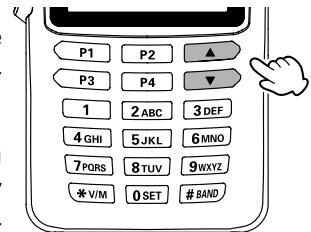

OPERATION

TRANSMISSION

Once you have set up an appropriate frequency inside one of the 144 MHz or 430 MHz Amateur bands on which the **FT-65R/E** can transmit, you're ready to go on the air! These are the most basic steps; more advanced aspects of transmitter operation will be discussed later.

- ❑ To transmit, press the **PTT** switch, and speak into the front panel microphone (located in the lower left-hand corner of the speaker grille) in a normal voice level. The **TX/BUSY** indicator will glow red during transmission.
- ❑ To return to the receive mode, release the **PTT** switch.
- ❑ During transmission, the relative power level will be indicated on the bar graph at the bottom of the LCD; full scale deflection confirms "**High Power**" operation, while deflection of one bar indicates "**Low Power**" operation. Five bars indicates "**Medium Power**" operation. Additionally, the "**LOW**" icon will appear at the bottom of the display while operating on the "**Low Power**" and "**Medium Power**" settings.

Changing the Transmitter Power Level

To change the power level:

- ❑ Press the **F/W** key, then press the [**3**] key. The LCD shows the current power output level.
- ❑ Press the [**▲**] or [**▼**] key to select the desired power output level. Available selections are "HI" (5 W), "MID" (2.5 W), and "LOW" (0.5 W).
- ❑ When you have made your choice, press the **PTT** switch to save the new setting and return to normal operation.

ADVANCED OPERATION

Now that you're mastered the basics of **FT-65R/E** operation, let's learn more about some of the really neat features.

KEYPAD LOCKING

In order to prevent accidental frequency change or inadvertent transmission, various aspects of the **FT-65R/E**'s keypad may be locked out. The possible lock-out combinations are:

Display	Operation
KEY	Just the front panel keypad is locked out
PTT	The PTT switch is locked out (TX not possible)
P+K	Both the PTT switch and keypad are locked out

To lock out the keys:

1. Press the **F/W** key, then press the [**0 SET**] key to enter the Set mode.
2. Press the [**▲**] or [**▼**] key to select Set Mode Item **15: KEY LOCK**.
3. Press the **F/W** key momentarily to enable adjustment of this Item.
4. Press the [**▲**] or [**▼**] key to choose between one of the locking schemes as outlined above.
5. When you have made your selection, press the **PTT** switch to save the new setting and return to normal operation.

To activate the locking feature, (1) **press and hold** in the [**6**] key for one second, or (2) press the **F/W** key, then press the [**6**] key. The "🔒" icon will appear on the LCD. To cancel locking, repeat this process.

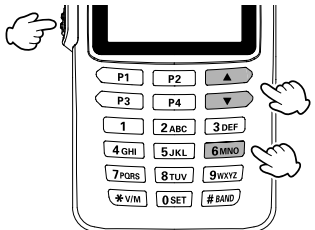
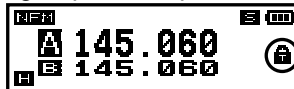

REPEATER OPERATION

Repeater stations, usually located on mountaintops or other high locations, provide a dramatic extension of the communication range for low-powered hand-held or mobile transceivers. The **FT-65R/E** includes a number of features which make repeater operation simple and enjoyable.

REPEATER SHIFTS

Your **FT-65R/E** has been configured, at the factory, for the repeater shifts customary in your country. For the 144 MHz band shift will be 600 kHz; on the 430 MHz band, the shift may be 1.6 MHz, 7.6 MHz, or 5 MHz (USA version).

Depending on the part of the band in which you are operating, the repeater shift may be either downward (+) or upward (−), and one of these icons will appear at the top of the LCD when repeater shifts have been enabled.



AUTOMATIC REPEATER SHIFT (ARS)

The **FT-65R/E** provides a convenient Automatic Repeater Shift feature, which causes the appropriate repeater shift to be applied automatically whenever you tune into the designated repeater sub-bands in your country. These sub-bands are shown below.

If the ARS feature does not appear to be working, you may have accidentally disabled it.

To re-enable ARS:

1. Press the **F/W** key, then press the [**0 SET**] key to enter the Set mode.
2. Press the [**▲**] or [**▼**] key to select Set Mode Item **24: REPEATER**.
3. Press the **F/W** key to enable adjustment of this Item.
4. Press the [**▲**] or [**▼**] key to select “**ARS**”, then press the **F/W** key.
5. Press the [**▲**] or [**▼**] key to select “**ARS. ON**”, then press the **F/W** key.
6. When you have made your selection, press the **PTT** switch to save the new setting and return to normal operation.

MANUAL REPEATER SHIFT ACTIVATION

If the ARS feature has been disabled, or if you need to set a repeater shift direction other than that established by the ARS, you may set the direction of the repeater shift manually.

To do this:

1. Press the **F/W** key, then press the [**4**] key to enable selection of the repeater shift direction.
The [**4**] key is a “short-cut” to Set Mode Item **24: REPEATER**.
2. Press the **F/W** key to enable adjustment of this Item.

REPEATER OPERATION

3. Press the [▲] or [▼] key to select “**ARS**”, then press the **F/W** key.
4. Press the [▲] or [▼] key to select “**ARS. ON**”, then press the **F/W** key.
5. Press the [▲] or [▼] key to select “**MODE**”, then press the **F/W** key.
6. Press the [▲] or [▼] key to select “**-REP**,” “**+REP**” and “**SIMPLEX**”, then press **F/W** key.
7. Press the [▲] or [▼] key to select “**SHIFT**”, then press the **F/W** key.
8. Press the [▲] or [▼] key to set the **SHIFT** frequency, then press the **F/W** key.
7. When you have made your selection, press the **F/W** key, then press the **PTT** switch to save the new setting and return to normal operation.

CTCSS/DCS OPERATION

CTCSS OPERATION

Many repeater systems require that a very-low-frequency audio tone be superimposed on your FM carrier in order to activate the repeater. This helps prevent false activation of the repeater by radar or spurious signals from other transmitters. This tone system, called “CTCSS” (Continuous Tone Coded Squelch System), is included in your **FT-65R/E**, and is very easy to activate.

1. Press the **F/W** key, then press the [1] or [0] key to enable selection of the CTCSS/DCS mode.
2. Press the [▲] or [▼] key so that “**TONE**” indication appears on the display; this activates the CTCSS Encoder, for access to repeaters requiring a CTCSS tone.
3. Pressing the [▲] or [▼] key one more “click” in step “2” above will cause the “**TSQL**” notation to appear. When “**TSQL**” is displayed, this means that the Tone Squelch system is active, which mutes your **FT-65R/E**'s receiver until it receives a call from another radio sending out a matching CTCSS tone. This can help keep your radio quiet until a specific call is received, which may be helpful while operating in congested areas of the band.
4. When you have made your selection of the CTCSS tone mode, press the **PTT** switch to save the new setting.
5. Press the **F/W** key, then press the [2] key to enable adjustment of the CTCSS frequency.
6. Press the [▲] or [▼] key until the display indicates the Tone Frequency you need to be using (ask the repeater owner/operator if you don't know the tone frequency).
7. When you have made your selection, press the **F/W** key momentarily to save the new settings and exit to normal operation. This is different than the usual method of restoring normal operation, and it applies only to the configuration of the CTCSS/DCS frequencies.

CTCSS TONE FREQUENCY (Hz)					
67.0	69.3	71.9	74.4	77.0	79.7
82.5	85.4	88.5	91.5	94.8	97.4
100.0	103.5	107.2	110.9	114.8	118.8
123.0	127.3	131.8	136.5	141.3	146.2
151.4	156.7	159.8	162.2	165.5	167.9
171.3	173.8	177.3	179.9	183.5	186.2
189.9	192.8	196.6	199.5	203.5	206.5
210.7	218.1	225.7	229.1	233.6	241.8
250.3	254.1	–	–	–	–

CTCSS/DCS OPERATION

DCS OPERATION

Another form of tone access control is Digital Code Squelch, or DCS. It is a newer, more advanced tone system which generally provides more immunity from false paging than does CTCSS. The DCS Encoder/Decoder is built into your **FT-65R/E**, and operation is very similar to that just described for CTCSS. Your repeater system may be configured for DCS; if not, DCS is frequently quite useful in Simplex operation if your friend(s) use transceivers equipped with this advanced feature.

Just as in CTCSS operation, DCS requires that you set the Tone Mode to DCS and that you select a tone code.

1. Press the **F/W** key, then press the **[1]** key to enable selection of the CTCSS/DCS mode.
2. Press the **[▲]** or **[▼]** key until the “DCS” indication appears on the display; this activates the DCS Encoder/Decoder.
3. Press the **PTT** key to save the new setting.
4. Press the **F/W** key, then press the **[2]** key to enable adjustment of the DCS code.
5. Press the **[▲]** or **[▼]** key to select the desired DCS Code (a three-digit number), then press **[F/W]** key to enter the select item.
 Ask the repeater owner/operator if you don't know DCS Code; if you are working simplex, just set up the DCS Code to be the same as that used by your friend(s).
6. When you have made your selection, press the **F/W** key momentarily to save the new settings and exit to normal operation.

DCS CODE									
023	025	026	031	032	036	043	047	051	053
054	065	071	072	073	074	114	115	116	122
125	131	132	134	143	145	152	155	156	162
165	172	174	205	212	223	225	226	243	244
245	246	251	252	255	261	263	265	266	271
274	306	311	315	325	331	332	343	346	351
356	364	365	371	411	412	413	423	431	432
445	446	452	454	455	462	464	465	466	503
506	516	523	526	532	546	565	606	612	624
627	631	632	654	662	664	703	712	723	731
732	734	743	754	-	-	-	-	-	-

MEMORY MODE

The **FT-65R/E** provides a wide variety of memory system resources. These include:

- 200 “Standard” memory channels, numbered “001” through “200.”
- 2 “Home” channels, providing storage and quick recall of one prime frequency on each operating band.
- 10 sets of band-edge memories, also known as “Programmable Memory Scan” channels, labeled “L01/U01” through “L10/U10.”
- 10 Memory Banks, labeled “BANK 1” through “BANK10.” Each Memory Bank can be assigned up to 1000 channels from the “standard” and “PMS” memory channels.
- 10 “Weather Broadcast” Channels.

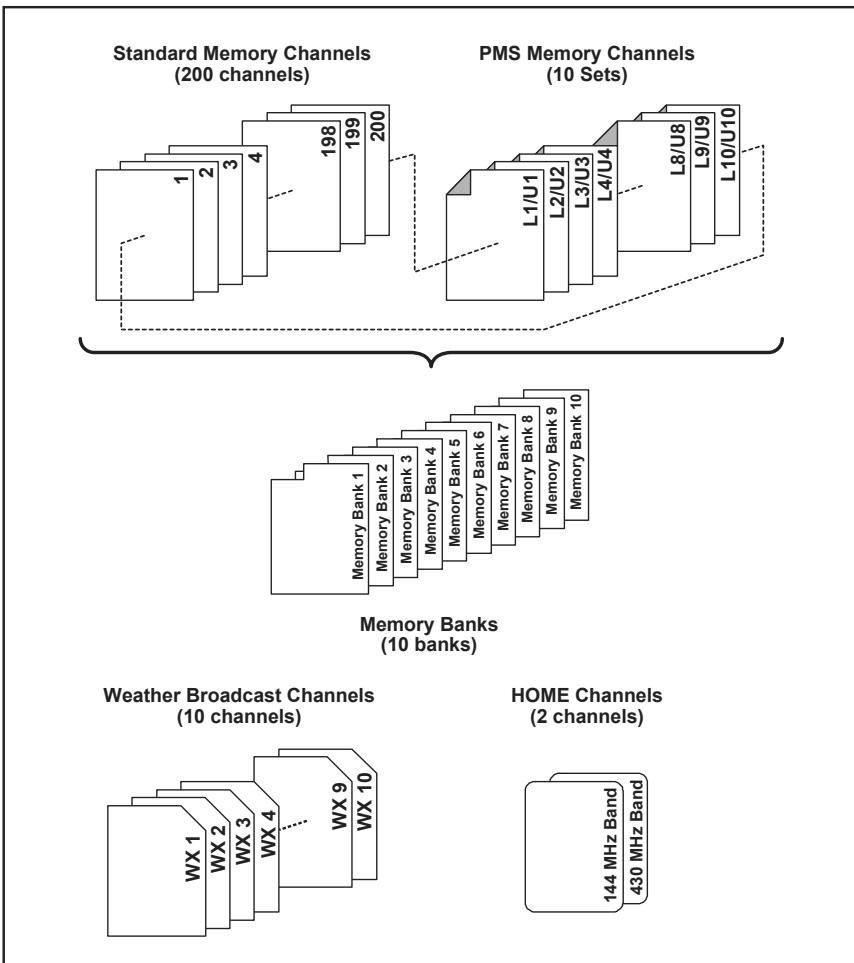

MEMORY MODE

MEMORY STORAGE

1. Select the desired frequency, while operating in the VFO mode. Be sure to set up any desired CTCSS or DCS tones, as well as any desired repeater offset. The power level may also be set at this time, if you wish to store it.
 2. Press and hold in the **F/W** key for one second.
 3. Within ten seconds of releasing the **F/W** key, you need to make a decision regarding channel storage. The microprocessor will automatically select the next-available “free” channel (a memory register on which no data has been stored), so you may not wish to make any change; if this is the case, proceed to step 4. If you wish to select a different channel number into which to store the data, press the [▲] or [▼] key to select the desired memory channel. You may jump 100 memory channels, if you’re in a hurry (101 → 201 → 301 ...) by pressing the [#BAND] key (multiple times, if necessary).
 4. Press the **F/W** key once more to store the frequency into memory.
 5. You still will be operating in the “VFO” mode, so you may now enter other frequencies, and store them into additional memory locations, by repeating the above process.
-

MEMORY RECALL

1. While operating in the VFO mode, press the [* **V/M**] key twice to enter the Memory mode.
2. Press [▲] or [▼] key to select the desired channel.
3. To return to the VFO mode, press the [* **V/M**] key.

When the radio is already set to the Memory mode, an easy way to recall memories is to key in the memory channel number, then press the **F/W** key.

For example, to recall memory channel #14, press [1] → [4] → **F/W**.

You may also recall the Memory Channel #000 and Programmable Memory channels (“L1/U1” through “L10/U10.”) using the following numbers: Memory Channel #000 = “200,” Programmable Memory channels #L1 = “201,” U1 = “202,” L50 = “209,” and U50 = “210.”

MEMORY MODE

HOME CHANNEL MEMORY RECALL

“HOME” channel is available for each of operating bands, to allow quick recall of a favorite operating frequency on each band.

Home Channel is simple to accomplish:

1. Press the **F/W** key, then press [**P1**] key.
 The following default home channels is displayed.
2. Press **F/W** key, then press [**P1**] key to exit to normal operation.
3. You may repeat this process on the another operating band..

DEFAULT HOME CHANNELS		
BAND	FREQUENCY	
	USA Version	EXP/EU Version
144 MHz Band	146.520 MHz	144.000 MHz
430 MHz Band	446.000 MHz	430.000 MHz

DELETING MEMORIES

You may desire to delete the memories (except the Memory Channel “1” and Home Channel). The procedure for deleting a channel is quite simple.

1. Press **F/W** key ,then [**0 SET**] key to enter the Set mode.
2. Press [**▲**] or [**▼**] key to select Set Mode item “**18: MEM DEL**”.
3. Press **F/W** key.
3. Press [**▲**] or [**▼**] key to select the memory you want to delete.
4. Press **F/W** key to delete selected memory channel
5. Press **PTT** Switch to return to normal operation.

Important Notice! Once deleted, the channel data cannot be recovered!

WEATHER BROADCAST CHANNELS (U. S. VERSION)

The VHF Weather Broadcast Station Memory Channel Bank has been pre-programmed at the factory, for quick selection of NOAA weather information stations.

1. Press and hold in the [**1**] key for one second to recall the Weather Broadcast Memory Bank.
2. Press the [**▲**] or [**▼**] key to select the desired Weather Broadcast channel.
3. If you want to scan this Weather bank to search for strong stations, just press the **PTT** Switch.

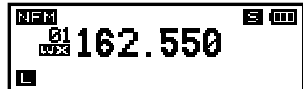

When the SCAN pauses on a station, press the **PTT** Switch once to stop the scan, or press it again to restart the scan.

CH	FREQUENCY	CH	FREQUENCY
01	162.550 MHz	06	162.500 MHz
02	165.400 MHz	07	165.525 MHz
03	162.475 MHz	08	161.650 MHz
04	162.425 MHz	09	161.775 MHz
05	162.450 MHz	10	163.275 MHz

MEMORY MODE

- To exit to normal operation, press the [* **V/M**] key, or press and hold in the [1] key again

Severe Weather Alert

In the event of extreme weather disturbances, such as severe thunderstorms and hurricanes, the NOAA (National Oceanic and Atmospheric Administration) sends a weather alert accompanied by a 1050 Hz tone and subsequent weather report on one of the NOAA weather channels.

FM BROADCAST RECEIVING

FM Broadcast Radio can input the VFO-B and Memory Mode only.(Not setting in VFO-A)

Frequency Range			
VFO-A	136-174MHz	136-174MHz	
VFO-B	65-108MHz(WFM)	136-174MHz	400-480MHz

To activate the FM Broadcast

- Press [***V/M**] key repeatedly to select the VFO-B.
- Press the numeric key to input the desired frequency.

To set FM Broadband Radio(WFM) mode ON/OFF

- Press **F/W** key and then press [0 **SET**] key to enter the Set mode.
- Press [▲] or [▼] key to select the “**37: WFM RCV**”, then press **F/W** key
- Set the WFM mode ON/OFF by pressing the [▲] or [▼] key.

WFM ON	Enable FM Broadcast Radio to input on VFO-B
WFM OFF	Not Receiving the FM Broadcast Radio and inputting WFM in VFO-B.

SCANNING

The **FT-65R/E** allows you to scan just the memory channels, the entire operating band, or a portion of that band. It will halt on signals encountered, so you can talk to the station(s) on that frequency, if you like.

Scanning operation is basically the same in each of the above modes. Before you begin, take a moment to select the way in which you would like the scanner to resume scanning after it halts on a signal.

Setting the Scan-Resume Technique

Three options for the Scan-Resume mode are available:

BUSY: In this mode, the scanner will halt on a signal it encounters. One seconds after the carrier has dropped because the other station(s) ceased transmission, the scanner will resume. In the case of constant-carrier signals like Weather Station broadcasts, the scanner will likely remain on this frequency indefinitely.

HOLD: In this mode, the scanner will halt on a signal it encounters. It will not restart automatically; you must manually re-initiate scanning if you wish to resume.

TIME: In this mode, the scanner will halt on a signal it encounters, and will hold there for five seconds. If you do not take action to disable the scanner within that time period, the scanner will resume even if the stations are still active.

To set the Scan-Resume mode:

1. Press the **F/W** key, then press the **[0 SET]** key to enter the Set mode.
2. Press **[▲]** or **[▼]** key to select Set Mode Item “**25:RESUME**”.
3. Press **F/W** key to enable adjustment of this Set Mode Items.
4. Press **[▲]** or **[▼]** key to select the desired scan-resume mode.
5. Press **[PTT]** Switch to save and exit to normal operation.

The default condition for this Set Mode Item is “BUSY”.

VFO SCANNING

The **FT-65R/E** provides two VFO scanning functions: “Manual VFO Scanning” and “Programmed VFO Scanning.”

Manual VFO Scan

1. Press the **[* V/M]** key to set the VFO mode, if necessary.
2. Press and hold **[▲]** or **[▼]** key for one second to initiate upward or downward scanning, respectively.
3. Press and hold in either the **[▲]** or **[▼]** key for one second to initiate upward or downward scanning, respectively.
4. If and when the scanner encounters a signal strong enough to open the squelch, the scanner will halt temporarily; the decimal point of the frequency display will blink this “Resuming” condition.

SCANNING

- The scanning will then resume according to the Scan-Resume mode selected in the Set Mode Item “**25:RESUME**”.
- To cancel scanning, press the **PTT** switch or [**▲**] or [**▼**] key.

Programmed VFO Scan

- Press the [*** V/M**] key to set the VFO mode, if necessary.
- Press and hold in the [**#BAND**] key for one second, then press [**▲**] [**▼**] key to select the bandwidth for the Programmed VFO scanner.
Available selections are below.

Display	Operation
BAND	The scanner will sweep frequencies only on the current band.
±1MHz	The scanner will sweep frequencies within the ±1MHz frequency.
±2MHz	The scanner will sweep frequencies within the ±2MHz frequency.
±5MHz	The scanner will sweep frequencies within the ±5MHz frequency.
ALL	The scanner will sweep all frequencies.
PMS channels(1-10)	The scanner will sweep frequencies within the currently-selected PMS frequency pair.

- Press the [**#BAND**] key momentarily to save the new setting and exit to normal operation.
- Press and hold the [*** V/M**] key for one second to start scanning.
PMS icon will appear on the LCD.
- If and when the scanner encounters a signal strong enough to open the squelch, the scanner will halt temporarily; the decimal point of the frequency display will blink during this “Pause” condition.
- The scanner will then resume according to the Scan-Resume mode selected in the Set Mode Item “**25:RESUME**”.
- To cancel scanning, press the **PTT** switch, [*** V/M**] key, [**▲**] [**▼**] key, [**#BAND**], or [**MONI**] key.

MEMORY SCANNING

Memory scanning is similarly easy to initiate:

- Press the [*** V/M**] key to set the Memory mode, if necessary.
- Press and hold in either the [**▲**] or [**▼**] key for one second to initiate upward or downward scanning, respectively.
During Scanning memory number will blink this “Resuming” condition.
- To cancel scanning, press the **PTT** switch or [*** V/M**] key, [**▲**] [**▼**] key, [**#BAND**], [**MONI**] key.

How to Skip (Omit) a Channel during Memory Scan Operation

As mentioned previously, some continuous-carrier stations like a Weather Broadcast station will seriously impede scanner operation if you are using the “Carrier Drop” Scan-Resume mode, as the incoming signal will not pause long enough for the transceiver to resume scanning. Such channels may be “Skipped” during scanning, if you like:

SCANNING

1. Recall the Memory Channel to be skipped during scanning.
2. Press the **F/W** key, then press the [**0 SET**] key to enter the Set mode.
3. Press [**▲**] [**▼**] key to select Set Mode Item "**29: SKIP**"
4. Press the **F/W** switch momentarily to enable adjustment of this Set Mode Item.
5. Press [**▲**] [**▼**] key so as to select "SKIP." then press **F/W** switch.
The current Memory Channel will now be ignored during scanning and black color.
6. If skipped memory select then press **F/W** switch, will be not skip during the memory scanning.
7. When you have made your selection, press the [**PTT**] switch to save the setting and exit to normal operation.

To re-institute a channel into the scanning loop, select "OFF" in step 5 above (the "Skipped" channel will, of course, still be accessible via manual channel selection methods using [**▲**] or [**▼**] key in the MR mode, whether or not it is locked out of the scanning loop).

Preferential Memory Scan

The **FT-65R/E** also allows you to set up a "Preferential Scan List" of channels which you can "flag" within the memory system. These channels are designated by a blinking "▶" icon when you have selected them, one by one, for the Preferential Scan List.

Here is the procedure for setting up and using the Preferential Scan List:

1. Recall the Memory Channel which you wish to add to the Preferential Scan List.
2. Press the **F/W** key, then press the [**0 SET**] key to enter the Set mode.
3. Press [**▲**] or [**▼**] key to select Set Mode Item **29: SKIP**.
4. Press the **F/W** key momentarily to enable adjustment of this Set Mode Item.
5. Press [**▲**] or [**▼**] key so as to select "ONLY."
6. When you have made your selection, press the **PTT** key to save the settings and exit to normal operation.
7. To remove a channel from the Preferential Scan List, just repeat the above procedure, pressing [**▲**] or [**▼**] key to select "OFF" in step 5 above.

In the factory default configuration, you may recall Set Mode Item 29: SKIP by pressing F/W → [8(P2)].

To initiate Preferential Memory Scan:

1. Press the **F/W** key, then press the [**0 SET**] key to enter the Set mode.
2. Press [**▲**] or [**▼**] key to select Set Mode Item **#####**.
3. Press the **F/W** key momentarily to enable adjustment of this Set Mode Item.
4. Press [**▲**] or [**▼**] key so as to select "ONLY."
5. Press the **PTT** key to save the settings and exit to normal operation.

SCANNING

6. Now, press and hold in either the [**▲**(MHz)] or [**▼**(MHz)] key for one second to initiate the Preferential Memory Scan. Only the channels which have the blinking “▶” icon appended to the channel number will be scanned.
7. To cancel the Preferential Memory Scan, just repeat the above procedure, pressing [**▲**] or [**▼**] key to select “MEM” in step 4 above.

Memory Bank Scan

When the Memory Bank feature is engaged, the scanner sweeps only memory channels in the current Memory Bank. However, if the Memory Bank Link Scan feature is enabled, you may sweep the memory channels in several Memory Banks which you have selected.

To enable the Memory Bank Link Scan feature:

1. Set the radio to the Memory mode by pressing the [*** V/M**] key, if necessary.
2. Press and hold in the [**#BAND**] key for one second, then press [**▲**] or [**▼**] key to select the first Memory Bank (“**BANK 1**” ~ “**BANK10**”) you wish to sweep using Memory Bank Link Scan.
3. Press the **F/W** key momentarily. The current Memory Bank will now be swept during Memory Bank Scan. A “decimal point” will be appended between the “N” and “K” of the Memory Bank number indication (such as BAN. K 2).
4. Repeat steps 2 and 3 above, to append the “decimal point” to any other Memory Banks you wish to sweep.
5. Now, press and hold in the [*** V/M**] key for one second to initiate the Memory Bank Link Scan.
6. To remove a Memory Bank from the Memory Bank Link Scan, repeat steps 2 and 3 above, to delete the “decimal point” from the Memory Bank number indication.

WEATHER ALERT SCAN

This feature allows you to check the Weather Broadcast Memory Channels for the presence of the NOAA Alert Tone while operating using VFO scan or Memory channel scan.

When the Weather Alert Scan feature is engaged, the **FT-65R/E** will check the Weather Broadcast Memory Channels for activity every five seconds while scanning. If you watch the display carefully, you'll observe the scanner periodically shifting to the Weather Broadcast bank, scanning the Weather channels quickly in search of the Alert Tone, after which regular scanning will resume for another five seconds.

To enable the Weather Alert Scan feature:

1. Press **F/W** key then press [**0 SET**] key to enter the Set mode.
2. Press the [**▲**] or [**▼**] key to select Set Mode item “**39: WX ALERT**”.

3. Press the **F/W** key momentarily to enable adjustment of this Set Mode Item.
4. Press [**▲**] [**▼**] key to select the “**ALT.ON**”.
5. When you have made your selection, press the [**PTT**] switch to save the setting and exit to normal operation.
6. To disable the Weather Alert Scan feature, select “**ALT.OFF**” in step 4 above.

MISCELLANEOUS SETTINGS

CHANGING THE CHANNEL STEPS

The **FT-65R/E**'s synthesizer provides the option of utilizing channel steps of 5/6.25/10/12.5/15/20/25/50/100 kHz per step, as well as an automatic step selection based on the current operating frequency ("**AUTO**"), any number of which may be important to your operating requirements. The **FT-65R/E** is set up at the factory in the "**AUTO**" configuration, which probably is satisfactory for most operation. However, if you need to change the channel step increments, the procedure to do so is very easy.

1. Press the **F/W** key, then press the [**0 SET**] key to enter the Set mode.
2. Press the [**▲**] or [**▼**] key to select Set Mode Item "**31: STEP**".
3. Press the **F/W** key momentarily to enable adjustment of this Item.
4. Press [**▲**] [**▼**] key to select the new channel step size.
5. When you have made your selection, press the **PTT** switch to save the new setting and return to normal operation.

RESET PROCEDURES

In the event of erratic operation of the transceiver, it is possible that data on the microprocessor may have become corrupted. While this is a highly unusual situation, the only path to recovery may involve resetting of the microprocessor. Here's how to do this:

1. Turn the radio off.
2. Press and hold [**MONI**] and [**PTT**] switch and turn the radio on simultaneously.
3. Press [**▲**] [**▼**] key to select one choice from the reset menu:

Display	Operation
F1 SET RESET	Reset the Set Mode settings to factory defaults.
F2 MEM RESET	Clear the Memory settings to factory defaults.
F3 BANK RESET	Clear the Memory Bank assignments.
F4 ALL RESET	Clear the All memories and other settings to factory defaults.
F5 MEM-ONLY	Operation on the Memory only.
F6 VHF-ONLY	Operation on the VHF Band only.
F7 UHF-ONLY	Operation on the UHF Band only.
F8 FM-ONLY	Operation on the FM-RADIO only.
F9 CLONE	Clone mode.

4. Press the **F/W** key momentarily to complete the reset procedure.

SET (MENU) MODE

The **FT-65R/E** Set Mode, already described in parts of many previous chapters, is easy to activate and set. It may be used for configuration of a wide variety of transceiver parameters, some of which have not been detailed previously. Use the following procedure to activate the Set Mode:

1. Press the **F/W** key, then press the **[0 SET]** key to enter the Set mode.
2. Press **[▲] [▼]** key to select the Set Mode Item to be adjusted.
3. Press the **F/W** key momentarily to enable adjustment of the Set Mode Item.
4. Press **[▲] [▼]** key to adjust or select the parameter to be changed on the Set Mode Item selected in above step.
5. After completing your selection and adjustment, press the **PTT** switch momentarily to save the new setting and exit to normal operation.

No.	ITEM	Function	Values	Default Value
1	APO	Auto power off	OFF/0.5H to 12.0H (Step 0.5H)	OFF
2	ARTS	Setting the ARTS function. ARTS BEEP function type. ARTS Polling time (Interval)	BEEP= INRANGE / ALWAYS / OFF INT= 25sec / 15sec	ARTS=OFF INT= 25Sec
3	BATTSAVE	Selects the Receive-mode Battery Saver interval ("sleep" ratio)	200 mS / 300 mS /500 mS / 1 SEC / 2 SEC / OFF	200mS
4	B-CH.L/O	Busy Channel Lock-Out	B-CH.L/O ON / B-CH.L/O OFF	OFF
5	BEEP	Beep function Enable/Disable	KEY+SC/KEY/OFF	KEY+SC
6	BELL	Select the number of CTCSS/DCS Bell ringer repetitions.	OFF / 1Time / 3Times/ 5Times / 8Times / CONTINUE	OFF
7	COMPANDER	Voice Comander	CMP.ON / CMP.OFF	OFF
8	CTCSS	Setting the CTCSS Frequency TX and RX	50 CTCSS tones and OFF	TX=OFF RX=OFF
9	CW ID	CW identifier during ARTS operation. Transmission every 10 minutes.	TX= ON/ OFF ID=***** (6cara)	TX= OFF ID= blank
10	DC VOLT	Indicate Battery DC Voltage.		
11	DCS CODE	Setting the DCS CODE TX and RX	104 DCS CODEs	TX=OFF RX=OFF
12	DTMF SET	Setting the DTMF autodialer sending delay time and Speed and Delay time.	MODE= Manual / Auto Delay= 50mS / 250mS / 450mS / 750mS / 1000mS Speed= 50mS / 100mS	M=Manual D=450mS S=50mS
13	DTMF WRT	Programing to DTMF autodialer.		
14	EDG.BEEP	Enables/Disables the Band-edge beeper while selecting the frequency via the [▲] or [▼] key.	BEEP OFF / BEEP ON	BEEP OFF
15	KEY LOCK	Keyboard Lock function	KEY / PTT / P+K	KEY
16	LAMP	Selects the LCD/Keypad Lamp mode.	5secKEY / 10secKEY / 30secKEY / CONT / OFF	5secKEY
17	LED	Selects the active or disable TX/BUSY LED function.	TX= ON / OFF BUSY= ON/ OFF	TX=ON BUSY=ON
18	MEM DEL	Delete Memory Channel mode	Select Delete memory	
19	MON/T-CL	Selects the MONI switch function.	MONI / T-CALL1750 / T-CALL2100 / T-CALL1000 / T-CALL1450	MONITOR
20	NAME TAG	Stores Alpha-Numeric "Tags" for the Memory channels.		-

21	PAGER	Enables/disables the Enhanced CTCSS Paging & Code Squelch function. TX CTCSS of 2 tone RX CTCSS of 2 tone Enables/Disables the Answer Back (acknowledgement) function. CODE for 2tone.	PAGER: ON / OFF RX: * * * TX: * * * ACK : ON / OFF	PAGER=OFF RX=05 47 TX=05 47 ACK=OFF
22	PASSWORD	Enables/disables the Password feature	PWD.OFF / PWD. ON / WRITE	PWD.OFF
23	PRI.RVT	Enables/disables the Priority Revert feature.	RVT.OFF / RVT. ON	RVT.OFF
24	REPEATER	ARS/MODE/SHIFT function setting	ARS= ON / OFF MODE= +RTP / -RTP / SIMPLEX SHIFT= xx.xxMHz	ARS ON MODE SIMPLEX SHIFT=1.60M
25	RESUME	Selects the Scan Resume mode.	BUSY/HOLD/TIME	BUSY
26	RF SQL	Adjusts the RF Squelch threshold level.	S-1 / S-2 / S-3 / S-4 / S-5 / -6 / S-8 / S-FULL / OFF	OFF
27	SCN.LAMP	Enables/Disables the Scan lamp while paused.	ON / OFF	ON
28	SCRABLE	Inversion scrambling (Encryption)	SCRB.ON/SCRB.OFF	SCRB.OFF
29	SKIP	Selects the Memory Scan "Skip" channel-selection mode.	Selective Skip MEM	
30	SQL TYPE	Selects the Tone Encoder and/or Decoder mode.	OFF / TONE / TSQ / REV TN / DCS / ECS	OFF
31	STEP	Setting of the synthesizer steps.	5 / 10 / 12.5 / 15 / 20 / 25 / 50 / 100 kHz, or AUTO	AUTO
32	TOT	Setting of the TOT time.	1min - 30min or OFF	3min
33	TX PWR	Select TX Power	LOW(0.5W) / MID(2.5W) / HI(5W)	HI(5W)
34	TX SAVE	Enables/Disables the Transmitter Battery Saver.	SAVE OFF / SAVE ON	SAVE OFF
35	VFO.SPL	Enables or disables "VFO Split" operation.	VSP.OFF / VSP.ON	VSP.OFF
36	VOX	Enable / Disable VOX function.	VOX OFF / VOX ON	VOX OFF
37	WFM.RCV	Broadband FM Radio(WFM) function Enables/Disables	WFM.ON / WFM.OFF / WFM.OLY	WFM.ON
38	WIDE/NAR	Select Wide (±5 kHz) or Narrow (±2.5 kHz) TX Deviation.	WIDE / NARROW	WIDE
39	WX ALERT	Enables/Disables the Weather Alert Scan feature.	ALT.OFF / ALT. ON	ALT.OFF

SPECIFICATIONS

General

Frequency Ranges:	RX 65 - 108 MHz (FM Broadcast), 136 - 174 MHz (FM) 400 - 500 MHz (FM) TX 144-148 MHz or 144-146 MHz 430-450 MHz or 430-440 MHz
Channel Steps:	5/6.25/10/12.5/15/20/25/50/100 kHz
Frequency Stability:	±5 ppm @ 14 °F to 140 °F (-10 °C to +60 °C)
Repeater Shift:	±600 kHz (144 MHz), ±1.6/(5.0)/7.6 MHz (430 MHz) (5.0 MHz: USA)
Emission Type:	F2D, F3E
Antenna Impedance:	50 Ω
Supply Voltage:	Nominal: 7.4 V DC, Negative Ground
(Negative Ground)	Operating: 6.0 ~ 9.0 V DC
Current Consumption:	125 mA (Receive)
(Approx. @7.2 V)	115 mA (144 MHz, Standby, Saver Off) 115 mA (430 MHz, Standby, Saver Off) 40 mA (Standby, Saver On) 0.8 mA (Auto Power Off) 1.6 A (5 W TX, 144 MHz) 1.8 A (5 W TX, 430 MHz)
Operating Temperature:	-4 °F to 140 °F (-20 °C to +60 °C)
Case Size:	2.3" (W) x 4.3" (H) x 1.2" (D) (58 x 109 x 30 mm) (W/O knob, antenna, and belt clip)
Weight:	13.05 Oz (370 g) with FNB-83, and antenna

Transmitter

RF Power Output:	5.0 W (High) / 2.5 W (Middle) / 0.5 W (Low) (Approx.)
Modulation Type:	Variable Reactance F2D, F3E
Maximum Deviation:	±5.0 kHz (F2D, F3E)
Spurious Emission:	At least 60 dB down (@ High and Middle power) At least 40 dB down (@ Low power)
Microphone Impedance:	2 kΩ

Receiver

Circuit Type:	Double-Conversion Superheterodyne
Intermediate Frequencies:	1st: 47.25 MHz, 2nd: 450 kHz
Sensitivity :	0.2 μV for 12 dB SINAD (136-174 MHz, FM)
(Cellular Blocked)	0.2 μV for 12 dB SINAD (400-480 MHz, FM)
Selectivity:	12 kHz/35 kHz (-6 dB /-60 dB)
AF Output:	400 mW @ 8 W for 10 % THD (@ 7.5 V)

Specifications are subject to change without notice, and are guaranteed within the 144 and 430 MHz amateur bands only. Frequency ranges will vary according to transceiver version; check with your dealer.

1. Changes or modifications to this device that are not expressly approved by YAESU MUSEN could void the user's authorization to operate this device.
2. This device complies with part 15 of the FCC Rules. Operation is subject to the following two conditions: (1) This device may not cause harmful interference, and (2) this device must accept any interference including received, interference that may cause undesired operation.
3. The scanning receiver in this equipment is incapable of tuning, or readily being altered, by the User to operate within the frequency bands allocated to the Domestic public Cellular Telecommunications Service in Part 22.

This device complies with Industry Canada license-exempt RSS standard(s). Operation is subject to the following two conditions: (1) this device may not cause interference, and (2) this device must accept any interference, including interference that may cause undesired operation of the device.

Le présent appareil est conforme aux CNR d'Industrie Canada applicables aux appareils radio exempts de licence. L'exploitation est autorisée aux deux conditions suivantes : (1) l'appareil ne doit pas produire de brouillage, et (2) l'utilisateur de l'appareil doit accepter tout brouillage radioélectrique subi, même si le brouillage est susceptible d'en compromettre le fonctionnement.

DECLARATION BY MANUFACTURER

The Scanner receiver is not a digital scanner and is incapable of being converted or modified to a digital scanner receiver by any user.

WARNING: MODIFICATION OF THIS DEVICE TO RECEIVE CELLULAR RADIOTELEPHONE SERVICE SIGNALS IS PROHIBITED UNDER FCC RULES AND FEDERAL LAW.

YAESU

The radio

Copyright 2016
YAESU MUSEN CO., LTD.
All rights reserved.
No portion of this manual
may be reproduced
without the permission of
YAESU MUSEN CO., LTD.



1609x-XX

Printed in Japan



E H 0 6 6 M 3 0 1