

TEST REPORT

For

HF Transceiver

In conformity with

FCC CFR 47 Part15 Subpart B (CSR)

Model : FT-410
FCC ID : K6620621X50
Test Item : HF Transceiver
Report No. : ERY1505P21R3
Issue Date : 21 May. 2015

Prepared for

YAESU MUSEN CO., LTD.
Tennozu Parkside Building 2-5-8 Higashi-Shinagawa,
Shinagawa-ku, Tokyo 140-0002 JAPAN

Prepared by

SGS RF Technologies Inc.
3-5-23, Kiyatamata, Tsuzuki-ku, Yokohama, 224-0021, Japan
Telephone: +81+(0)45- 550-3520
FAX: +81+(0)45- 592-7506

This document is issued by the Company subject to its General Conditions of Service printed overleaf, available on request or accessible at www.sgs.com/terms_and_conditions.htm and, for electronic format documents, subject to Terms and Conditions for Electronic Documents at www.sgs.com/terms_e-document.htm. Attention is drawn to the limitation of liability, indemnification and jurisdiction issues defined therein. Any holder of this document is advised that information contained hereon reflects the Company's findings at the time of its intervention only and within the limits of Client's instructions, if any. The Company's sole responsibility is to its Client and this document does not exonerate parties to a transaction from exercising all their rights and obligations under the transaction documents. This document cannot be reproduced except in full, without prior written approval of the Company. Any unauthorized alteration, forgery or falsification of the content or appearance of this document is unlawful and offenders may be prosecuted to the fullest extent of the law.

SGS RF Technologies Inc. is managed to ISO17025 and has the necessary knowledge and test facilities for testing according to the referenced standards. The test results in this report apply only to the sample tested.

Table of contents

1	General information.....	4
1.1	Product description	4
1.2	Test(s) performed/ Summary of test result	4
1.3	Test facility	5
1.4	Measurement uncertainty.....	5
1.5	Summary of test results.....	6
1.6	Setup of equipment under test (EUT)	6
1.6.1	Test configuration of EUT	6
1.6.2	Operating condition:	7
1.6.3	Setup diagram of tested system.....	7
1.7	Equipment modifications	7
1.8	Deviation from the standard	7
2	Test procedure and test data	8
2.1	Radiated emissions	8
2.2	Conducted emissions for receiver	15
2.3	AC power line conducted emissions.....	17
3	Test setup photographs	21
3.1	Radiated emissions	21
3.2	AC power line conducted emissions.....	21
4	List of utilized test equipment / calibration	22

History

Report No.	Date	Revisions	Issued By
ERY1505P08R3	08 May, 2015	Initial Issue	T.Kato
ERY1505P21R3	21 May, 2015	Revise the year of ANSI standard (Sec 1.2)	T.Kato

1 General information

1.1 Product description

Test item : HF Transceiver
Manufacturer : YAESU MUSEN CO., LTD.
Address : 43 Utsuroda, Morijuku, Sukagawa-shi, Fukushima-ken 962-0001 JAPAN
Model : FT-410
FCC ID : K6620621X50
Serial number : 5F000015
Hardware version : SPP01.02
Software version : SPP01
Operating frequency range : 0.03 - 30 MHz
Highest internal operating Freq. : 368.64 MHz
Receipt date of EUT : 17 Apr. 2015
Nominal power source voltages : DC 13.8 V (This is supplied AC/DC power supply)

1.2 Test(s) performed/ Summary of test result

Test specification(s) : FCC CFR 47 Part 15 Subpart B (01 Oct. 2014)
Test method(s) : ANSI C63.4: 2009
Test(s) started : 01 May. 2015
Test(s) completed : 07 May. 2015
Purpose of test(s) : Certification

Summary of test result : *Complied*

Note: The above judgment is only based on the measurement data and it does not include the measurement uncertainty. Accordingly, the statement below is applied to the test result.
The EUT complies with the limit required in the standard in case that the margin is not less than the measurement uncertainty in the Laboratory.
Compliance of the EUT is more probable than non-compliance is case that the margin is less than the measurement uncertainty in the Laboratory.

Test engineer

: 
T. Kato
EMC testing Department

Reviewer

: 
K. Onishi
Manager
EMC testing Department

1.3 Test facility

The Federal Communications Commission has reviewed the technical characteristics of the test facilities at SGS RF Technologies Inc., located in 472, Nippa-cho, Kohoku-ku, Yokohama, 223-0057, Japan, and has found these test facilities to be in compliance with the requirements of 47 CFR Part 15, section 2.948, per October 1, 2014.

The description of the test facilities has been filed under registration number 319924 at the Office of the Federal Communications Commission. The facility has been added to the list of laboratories performing these test services for the public on a fee basis.

The list of all public test facilities is available on the Internet at <http://www.fcc.gov>.

Registered by Industry Canada (IC): The registered facility number is as follows;

Test site No. 1 (Semi-Anechoic chamber 3m): 6974A-1

Accredited by **National Voluntary Laboratory Accreditation Program (NVLAP)** for the emission tests stated in the scope of the certificate under Certificate Number 200780-0

This report must not be used by the client to claim product certification, approval, or endorsement by NVLAP, NIST, or any agency of the Federal Government.

1.4 Measurement uncertainty

The treatment of uncertainty is based on the general matters on the definition of uncertainty in “Guide to the expression of uncertainty in measurement (GUM)” published by ISO. The Lab’s uncertainty is determined by referring UKAS Publication LAB34: 2002 “The Expression of Uncertainty in EMC Testing” and CISPR16-4-2: 2011 “Uncertainty in EMC Measurements”.

The uncertainty of the measurement result in the level of confidence of approximately 95% ($k=2$) is as follows;

AC conducted emission: ± 3.4 dB (150 kHz - 30 MHz)

RF conducted emission: ± 1.0 dB (30 MHz - 6 GHz)

Radiated emission (9 kHz - 30 MHz): ± 3.3 dB

Radiated emission (30 MHz - 200 MHz): ± 5.0 dB

Radiated emission (200 MHz - 1000 MHz): ± 6.2 dB

Radiated emission (1 GHz - 6 GHz): ± 4.7 dB

1.5 Summary of test results

Requirement	Section in specification	Result	Section in this report
Radiated emissions (30 to 2000 MHz) (*)	15.109	Complied	2.1
Conducted emission for receiver	15.111	Complied	2.2
AC power line conducted emissions	15.107	Complied	2.3
38 dB Rejection (cellular band)	15.121 (b)	- (**)	-

(*) The highest internal operating frequency is 368.64 MHz

(**) This item was not tested in this report.

1.6 Setup of equipment under test (EUT)

1.6.1 Test configuration of EUT

Equipment(s) under test

No.	Item	Manufacture	Model No.	Serial No.
A	HF Transceiver	YAESU MUSEN CO., LTD.	FT-410	5F000015
-	-	-	-	-

Support Equipment(s)

No.	Item	Manufacture	Model No.	Serial No.
B	DC Power Supply	YAESU MUSEN CO., LTD.	FP-1030A	1412167017
C	Hand Microphone	YAESU MUSEN CO., LTD.	MH-31B8J	5F000015
D	Headphone	YAESU MUSEN CO., LTD.	YH-77STA	YTS03
E	External Speaker	YAESU MUSEN CO., LTD.	MLS-100	064
F	USB Interface Unit	YAESU MUSEN CO., LTD.	SCU-17	17
G	PC	Panasonic	CF-W8GWYAJP	9GKSA91771
H	LAN Hub	NEC	PA-WR8700N-HP	87N1111286973B0
I	AC adaptor for Hub	NEC	AL1-002292-002	-

Connected cable(s)

No.	Item	Identification (Manu.etc.)	Cable Shielded	Ferrite Core	Length [m]
1	DC Power cable	YAESU MUSEN CO., LTD.	No	No	2.0
2	Mic. cable	YAESU MUSEN CO., LTD.	No	No	0.6
3	Headphones cable	YAESU MUSEN CO., LTD.	No	No	1.8
4	EXT SPKR cable	YAESU MUSEN CO., LTD.	No	No	1.8
5	TUNER cable	YAESU MUSEN CO., LTD.	No	No	1.1
6	LINER cable	YAESU MUSEN CO., LTD.	No	No	1.2
7	DATA cable	YAESU MUSEN CO., LTD.	No	No	1.6
8	KEY cable	YAESU MUSEN CO., LTD.	No	No	0.5
9	GND cable	YAESU MUSEN CO., LTD.	No	No	2.0
10	CAT cable	SANWA SUPPLY INC.	No	No	1.5
11	USB cable	YAESU MUSEN CO., LTD.	Yes	No	2.0
12	LAN Cable	-	No	No	2.0
13	DC cable for AC adaptor	NEC	No	No	1.3

1.6.2 Operating condition:

- Rx 0.03 MHz
- Rx 14 MHz
- Rx 30 MHz

1.6.3 Setup diagram of tested system

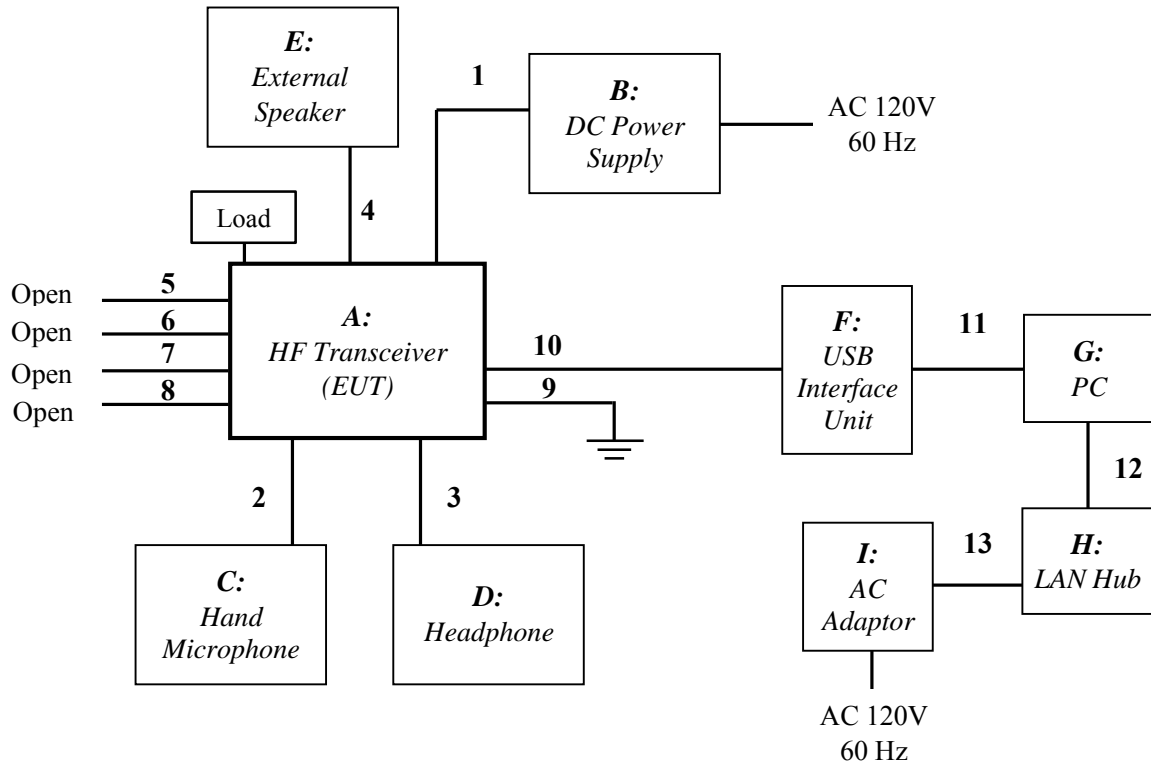

Note: The signal cable 5 to 8 were connected to no AE by a request from the manufacturer. 50 ohm terminals were connected to the antenna terminals.

1.7 Equipment modifications

No modifications have been made to the equipment in order to achieve compliance with the applicable standards described in clause 1.2.

1.8 Deviation from the standard

No deviations from the standards described in clause 1.2.

2 Test procedure and test data

2.1 Radiated emissions

Test setup

Test setup was implemented according to the method of ANSI C63.4 clause 6 “General requirements for EUT equipment arrangements and operation”, clause 8.2 and Annex H.3 “Radiated emission measurements setup”.

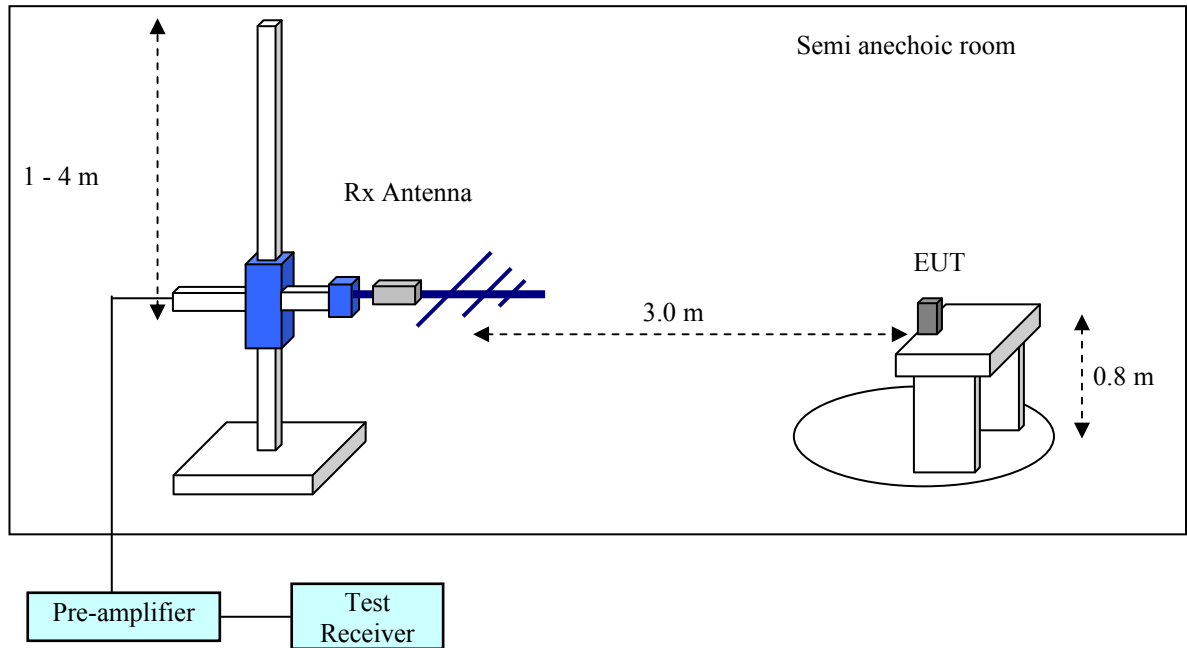

Test procedure

Measurement procedures were implemented according to the method of ANSI C63.4 clauses 8.2.

The EUT is placed on a non-conducted table which is 0.8 m height from a ground plane and the measurement antenna to EUT distance is 3 meters. The turn table is rotated for 360 degrees to determine the maximum emission level.

The antenna height scanned between 1 m and 4 m, and the antenna rotated to repeat the measurements for both the horizontal and vertical antenna polarizations.

The spectrum analyzer and receiver are set to the followings;

RBW=100 kHz (up to 1000 MHz) or 1 MHz (above 1000 MHz),

VBW= 300 kHz (up to 1000 MHz) or 3 MHz (above 1000 MHz)

Final measurement is carried out with a receiver RBW of 120 kHz (up to 1000 MHz), or 1 MHz (above 1000 MHz).

Applicable rule and limitation

FCC 15.109 Radiated emissions limits

Frequency [MHz]	Field Strength [$\mu\text{V}/\text{m}$]	Measurement Distance [m]	Field Strength [dB $\mu\text{V}/\text{m}$]
30 – 88	100	3	40.0
88 – 216	150	3	43.5
216 – 960	200	3	46.0
Above 960	500	3	53.9

In the emission table above, the tighter limit applies at the band edges.

The emission limits shown in the above table are based on measurements employing a QP detector (up to 1000 MHz) or AVE/PEAK detector (above 1000 MHz).

Test results - Complied with requirement

Test equipment used (refer to List of utilized test equipment)

AC01	TR06	CL11	PR15	BA10	CL29	CL30
PR12	DH01					

Test software used

EMI Ver. 5.6

Calculation method

The Correction Factor and Result are calculated as followings.

$$\text{Correction Factor [dB/m]} = \text{Ant. Factor [dB/m]} + \text{Loss [dB]} - \text{Gain [dB]}$$

$$\text{Result [dB}\mu\text{V/m]} = \text{Reasding [dB}\mu\text{V]} + \text{Correction Factor [dB/m]}$$

Test Data

Operating mode: Rx 0.03 MHz

Range: 30 - 1000 MHz

No.	Frequency [MHz]	Reading [dBμV]	Factor [dB/m]	Loss [dB]	Gain [dB]	Result [dBμV/m]	Limit [dBμV/m]	Margin [dB]	Ant.
1	184.318	41.6	9.0	8.4	30.0	29.0	43.5	14.5	Hori.
2	258.045	45.4	12.7	8.9	29.9	37.1	46.0	8.9	Hori.
3	331.772	36.7	14.3	9.4	29.9	30.5	46.0	15.5	Hori.
4	120.045	45.5	11.6	7.9	30.1	34.9	43.5	8.6	Vert.
5	135.855	40.3	11.7	8.0	30.0	30.0	43.5	13.5	Vert.
6	184.318	45.1	9.0	8.4	30.0	32.5	43.5	11.0	Vert.
7	258.044	42.5	12.7	8.9	29.9	34.2	46.0	11.8	Vert.
8	331.772	32.8	14.3	9.4	29.9	26.6	46.0	19.4	Vert.

Range: 1000 - 2000 MHz

No.	Frequency [MHz]	Reading PK [dBμV]	Reading AVE [dBμV]	C.Factor [dB/m]	Result PK [dBμV/m]	Result AVE [dBμV/m]	Limit PK [dBμV/m]	Limit AVE [dBμV/m]	Margin PK [dB]	Margin AVE [dB]	Ant.
1	1000.350	61.8	33.5	-11.8	50.0	21.7	73.9	53.9	23.9	32.2	Hori.
2	1329.534	58.6	33.5	-9.9	48.7	23.6	73.9	53.9	25.2	30.3	Hori.
3	1662.067	63.7	33.3	-8.5	55.2	24.8	73.9	53.9	18.7	29.1	Hori.
4	1992.350	53.0	30.4	-5.0	48.0	25.4	73.9	53.9	25.9	28.5	Hori.
5	1328.884	60.3	34.1	-9.9	50.4	24.2	73.9	53.9	23.5	29.7	Vert.
6	1661.817	66.6	33.8	-8.5	58.1	25.3	73.9	53.9	15.8	28.6	Vert.
7	1708.915	53.4	31.8	-8.0	45.4	23.8	73.9	53.9	28.5	30.1	Vert.
8	1992.000	54.5	30.7	-5.0	49.5	25.7	73.9	53.9	24.4	28.2	Vert.

[Chart]

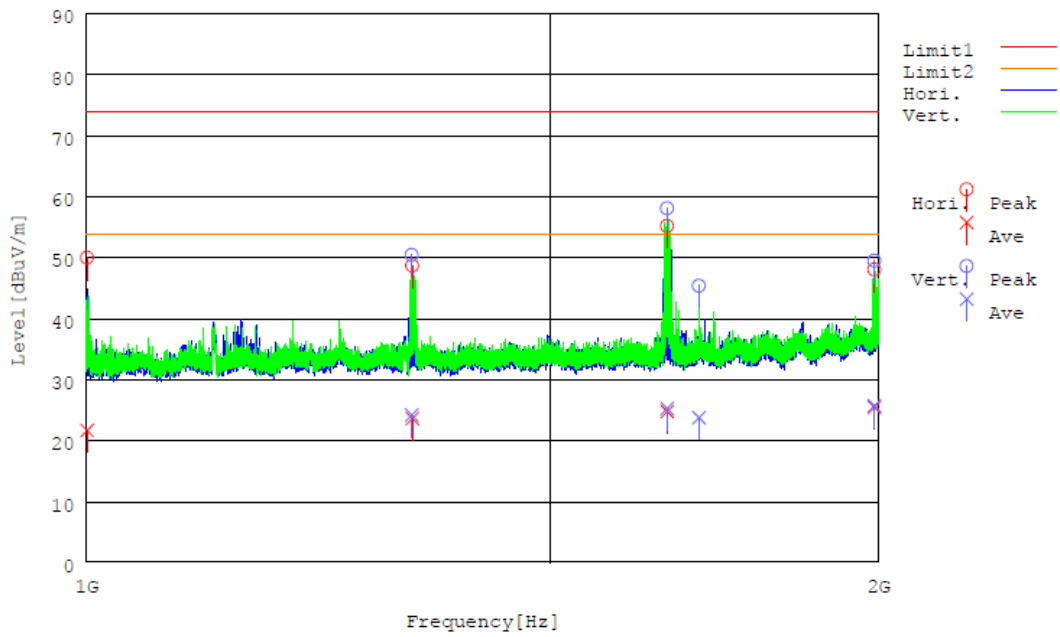
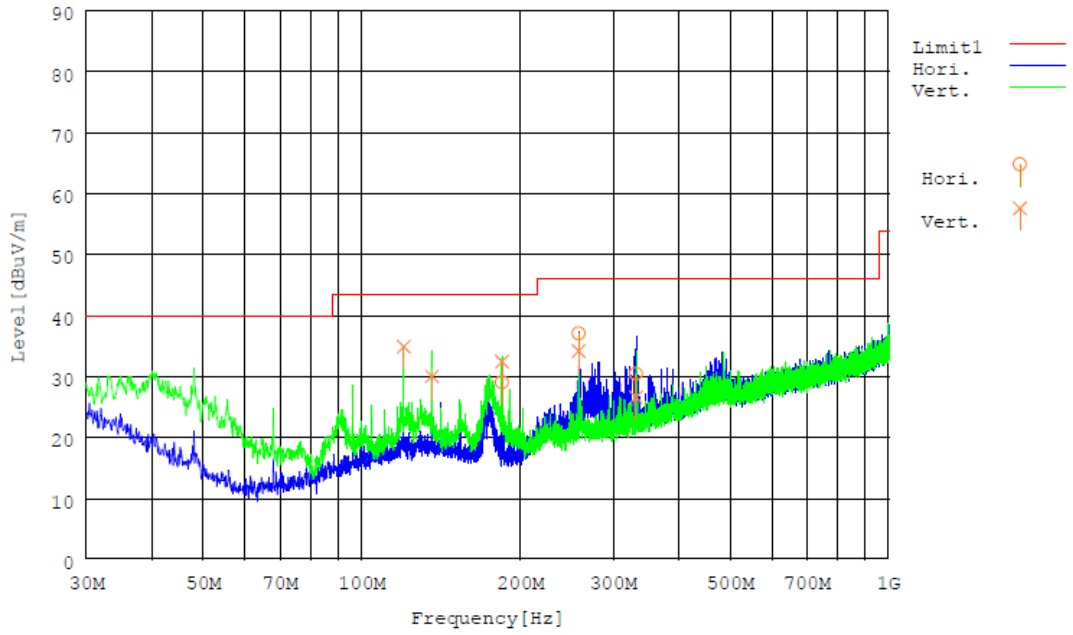

Operating mode: Rx 14 MHz

Range: 30 - 1000 MHz

No.	Frequency [MHz]	Reading [dB μ V]	Factor [dB/m]	Loss [dB]	Gain [dB]	Result [dB μ V/m]	Limit [dB μ V/m]	Margin [dB]	Ant.
1	184.318	41.6	9.0	8.4	30.0	29.0	43.5	14.5	Hori.
2	258.045	45.2	12.7	8.9	29.9	36.9	46.0	9.1	Hori.
3	306.352	30.1	13.6	9.2	29.9	23.0	46.0	23.0	Hori.
4	331.772	35.1	14.3	9.4	29.9	28.9	46.0	17.1	Hori.
5	452.446	25.0	17.2	10.1	29.7	22.6	46.0	23.4	Hori.
6	47.937	39.0	9.5	7.1	30.2	25.4	40.0	14.6	Vert.
7	120.045	45.5	11.6	7.9	30.1	34.9	43.5	8.6	Vert.
8	135.749	42.4	11.7	8.0	30.0	32.1	43.5	11.4	Vert.
9	184.318	45.0	9.0	8.4	30.0	32.4	43.5	11.1	Vert.
10	258.044	42.5	12.7	8.9	29.9	34.2	46.0	11.8	Vert.
11	331.772	32.8	14.3	9.4	29.9	26.6	46.0	19.4	Vert.
12	995.144	29.4	24.3	12.5	30.1	36.1	53.9	17.8	Vert.

Range: 1000 - 2000 MHz

No.	Frequency [MHz]	Reading PK [dB μ V]	Reading AVE [dB μ V]	C.Factor [dB/m]	Result PK [dB μ V/m]	Result AVE [dB μ V/m]	Limit PK [dB μ V/m]	Limit AVE [dB μ V/m]	Margin PK [dB]	Margin AVE [dB]	Ant.
1	1000.500	61.1	33.3	-11.8	49.3	21.5	73.9	53.9	24.6	32.4	Hori.
2	1143.493	55.6	32.9	-10.7	44.9	22.2	73.9	53.9	29.0	31.7	Hori.
3	1327.884	58.2	33.2	-10.0	48.2	23.2	73.9	53.9	25.7	30.7	Hori.
4	1659.267	63.7	33.4	-8.6	55.1	24.8	73.9	53.9	18.8	29.1	Hori.
5	1996.050	52.3	30.4	-4.9	47.4	25.5	73.9	53.9	26.5	28.4	Hori.
6	1330.583	60.0	34.4	-9.9	50.1	24.5	73.9	53.9	23.8	29.4	Vert.
7	1660.467	67.1	33.4	-8.5	58.6	24.9	73.9	53.9	15.3	29.0	Vert.
8	1990.950	54.6	30.5	-5.0	49.6	25.5	73.9	53.9	24.3	28.4	Vert.

[Chart]

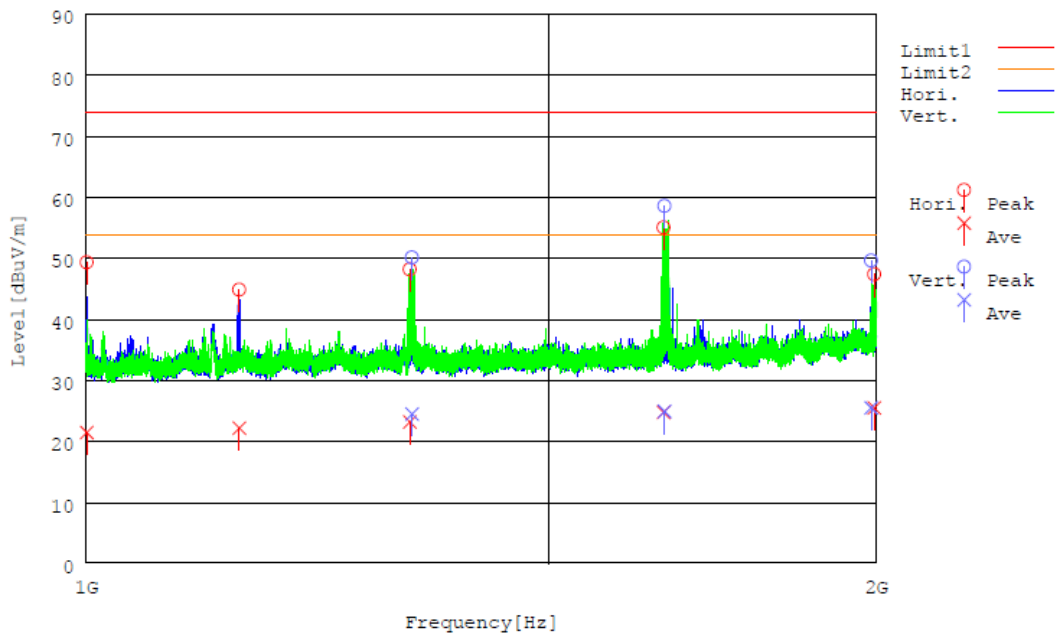
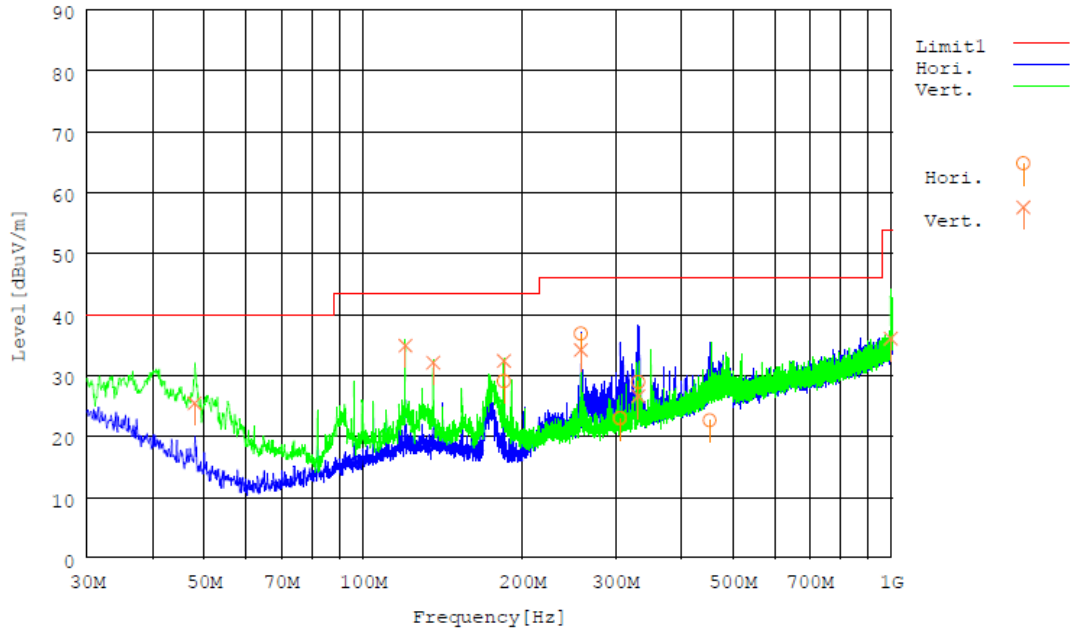

Operating mode: Rx 30 MHz

Range: 30 - 1000 MHz

No.	Frequency [MHz]	Reading [dB μ V]	Factor [dB/m]	Loss [dB]	Gain [dB]	Result [dB μ V/m]	Limit [dB μ V/m]	Margin [dB]	Ant.
1	184.318	41.5	9.0	8.4	30.0	28.9	43.5	14.6	Hori.
2	258.045	45.1	12.7	8.9	29.9	36.8	46.0	9.2	Hori.
3	331.772	36.3	14.3	9.4	29.9	30.1	46.0	15.9	Hori.
4	473.759	31.5	17.6	10.3	29.7	29.7	46.0	16.3	Hori.
5	47.937	39.8	9.5	7.1	30.2	26.2	40.0	13.8	Vert.
6	97.898	47.5	9.9	7.7	30.1	35.0	43.5	8.5	Vert.
7	120.045	45.5	11.6	7.9	30.1	34.9	43.5	8.6	Vert.
8	135.749	42.5	11.7	8.0	30.0	32.2	43.5	11.3	Vert.
9	184.318	45.0	9.0	8.4	30.0	32.4	43.5	11.1	Vert.
10	258.044	42.4	12.7	8.9	29.9	34.1	46.0	11.9	Vert.
11	331.772	32.8	14.3	9.4	29.9	26.6	46.0	19.4	Vert.
12	470.012	30.6	17.6	10.2	29.7	28.7	46.0	17.3	Vert.
13	995.144	29.4	24.3	12.5	30.1	36.1	53.9	17.8	Vert.

Range: 1000 - 2000 MHz

No.	Frequency [MHz]	Reading PK [dB μ V]	Reading AVE [dB μ V]	C.Factor [dB/m]	Result PK [dB μ V/m]	Result AVE [dB μ V/m]	Limit PK [dB μ V/m]	Limit AVE [dB μ V/m]	Margin PK [dB]	Margin AVE [dB]	Ant.
1	1000.450	61.9	33.3	-11.8	50.1	21.5	73.9	53.9	23.8	32.4	Hori.
2	1331.333	58.0	33.5	-9.9	48.1	23.6	73.9	53.9	25.8	30.3	Hori.
3	1664.217	63.5	33.2	-8.5	55.0	24.7	73.9	53.9	18.9	29.2	Hori.
4	1997.100	52.5	30.4	-4.9	47.6	25.5	73.9	53.9	26.3	28.4	Hori.
5	1002.700	57.1	32.7	-11.8	45.3	20.9	73.9	53.9	28.6	33.0	Vert.
6	1142.943	54.2	33.5	-10.7	43.5	22.8	73.9	53.9	30.4	31.1	Vert.
7	1329.534	60.1	33.9	-9.9	50.2	24.0	73.9	53.9	23.7	29.9	Vert.
8	1660.717	66.4	33.4	-8.5	57.9	24.9	73.9	53.9	16.0	29.0	Vert.
9	1992.750	53.8	30.5	-5.0	48.8	25.5	73.9	53.9	25.1	28.4	Vert.

[Chart]

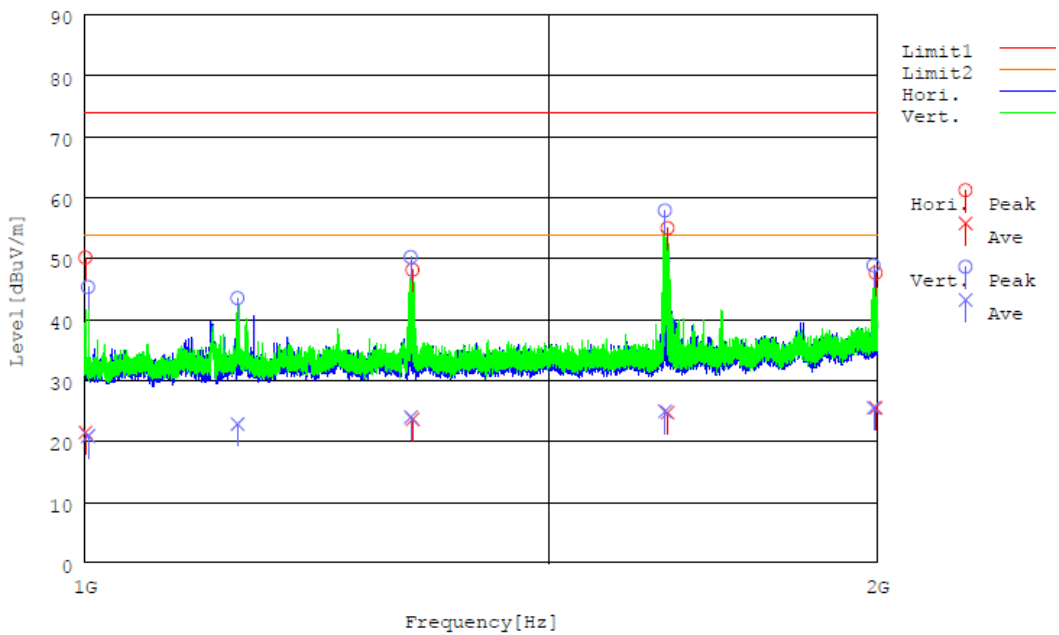
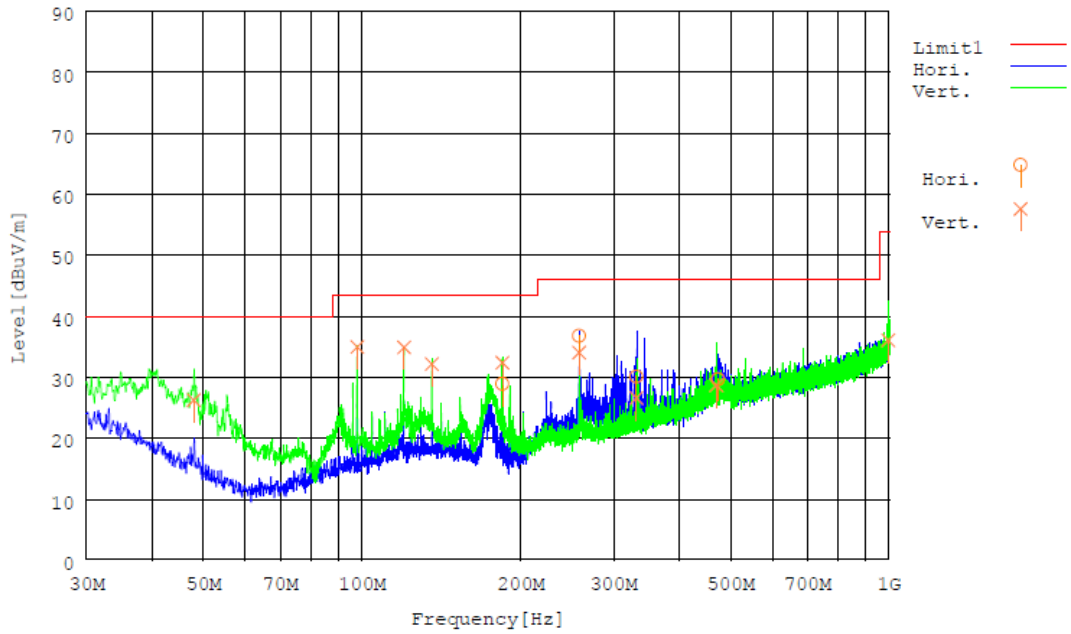

[Test condition]

Tested Date: 01 May, 2015
 Humidity: 57 %

Temperature: 21 degC
 Atmos. Press: 1017 hPa

2.2 Conducted emissions for receiver

Test setup

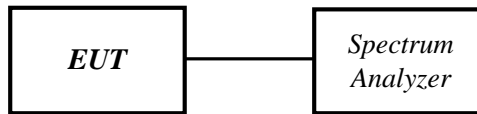

Applicable rule and limitation

§15.111 (b) Antenna power conducted limit : 2 nW (= -57 dBm)

Test equipment used (refer to List of utilized test equipment)

TR06		
------	--	--

Test results - Complied with requirement

Test Data

[The maximum spurious level at antenna port]

Operating freq. [MHz]	Frequency range 30 - 1000 MHz		Frequency range 1000 - 2000 MHz	
	Freq. [MHz]	Level [dBm]	Freq. [MHz]	Level [dBm]
0.03	-	-	-	-
14	-	-	-	-
30	-	-	-	-

Note: No emission above noise floor was found.

[Test condition]

Tested Date: 07 May, 2015
 Humidity: 52 %

Temperature: 21 degC
 Atmos. Press: 1013 hPa

[Chart]

Operating mode: Rx 0.03 MHz

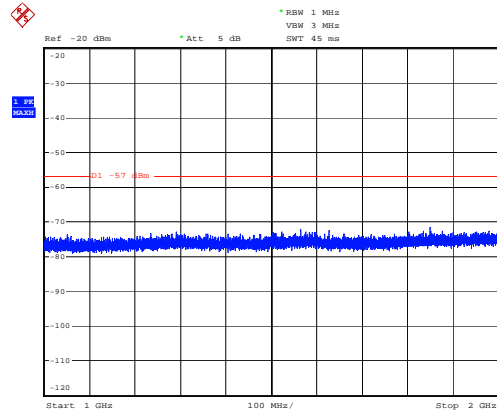
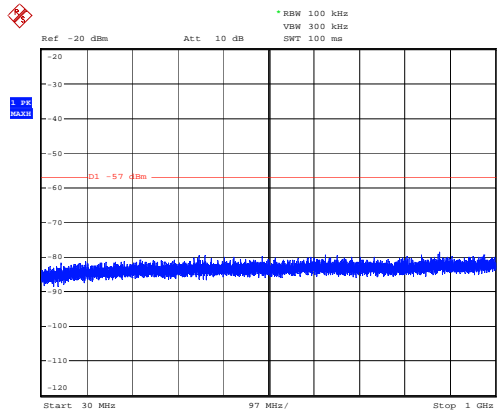

Operating mode: Rx 14 MHz

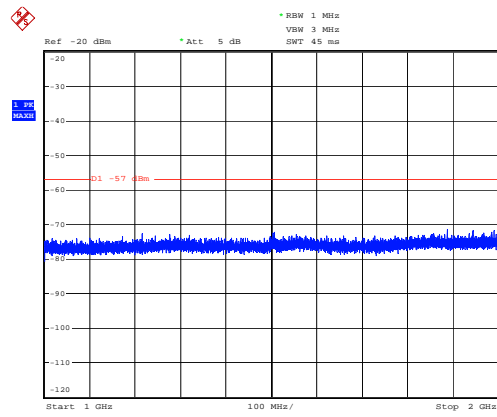
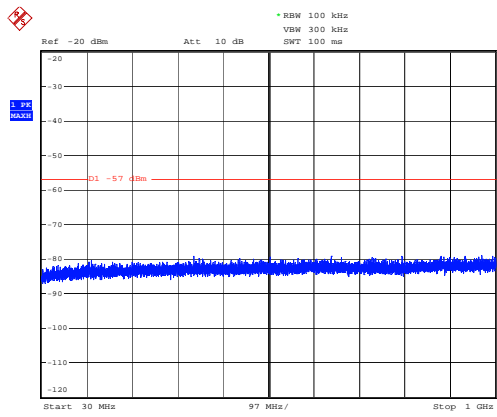

Operating mode: Rx 30 MHz

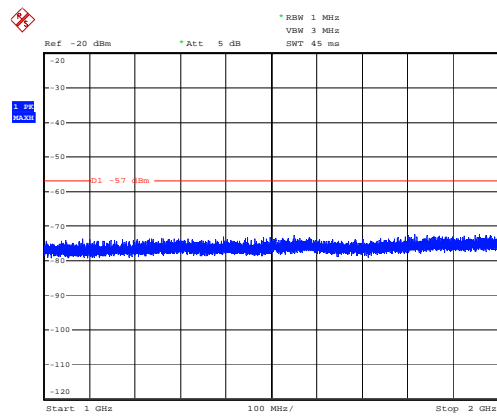
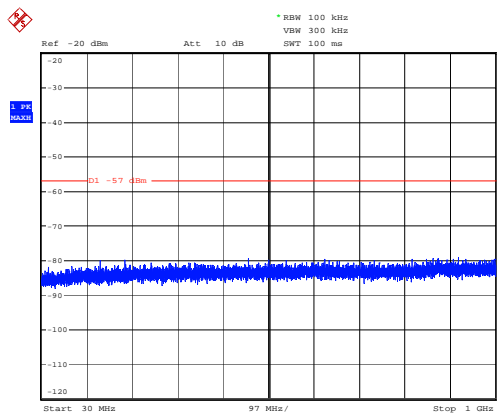

2.3 AC power line conducted emissions

Test setup

Test setup was implemented according to the method of ANSI C63.4 clause 6 “General requirements for EUT equipment arrangements and operation” and Annex H.1 “AC power line conducted emission measurements setup”.

Test procedure

Measurement procedures were implemented according to the method of ANSI C63.4 clauses 7, clause 13.1.3 and Annex H.2 “AC power line conducted emission measurements”.

Exploratory measurements were used the spectrum analyzer to identify the frequency of the emission that has the highest amplitude relative to the limit by operating the EUT in a range of typical modes of operation, cable positions, and with a typical system equipment configuration and arrangement.

Final ac power line conducted emission measurements were performed based on the exploratory tests.

The EUT cable configuration and arrangement and mode of operation that produced the emission with the highest amplitude relative to the limit are selected for the final measurement.

When the measurement value is greater than average limitation the average detection measurements were performed.

Applicable rule and limitation

§15.107 (b) AC power line conducted limits

Frequency of Emission [MHz]	Conducted emissions Limit [dBμV]	
	Quasi-peak	Average
0.15 - 0.5	66 to 56 *	56 to 46 *
0.5 - 5	56	46
5 - 30	60	50

* Decreases with the logarithm of the frequency. The lower limit applies at the band edges.

Test equipment used (refer to List of utilized test equipment)

TR06	LN05	CL18
------	------	------

Test software used

EMI Ver. 5.6

Calculation method

The Correction Factor and Result are calculated as followings.

$$\text{Correction Factor [dB]} = \text{ISN Factor [dB]} + \text{Loss [dB]}$$

$$\text{Result [dBμV]} = \text{Reading [dBμV]} + \text{Correction Factor [dB]}$$

Test results - Complied with requirement

Test Data

[Emission level]

Operating mode: Rx 0.03 MHz

No.	Frequency [MHz]	Reading		C.F. [dB]	Result		Limit		Phase	Pass/Fail
		QP [dB μ V]	AV [dB μ V]		QP [dB μ V]	AV [dB μ V]	QP [dB μ V]	AV [dB μ V]		
1	0.15370	19.0	1.4	10.3	29.3	11.7	65.8	55.8	Va	Pass
2	0.16332	17.3	1.0	10.3	27.6	11.3	65.3	55.3	Va	Pass
3	16.34953	27.9	21.9	10.4	38.3	32.3	60.0	50.0	Va	Pass
4	0.15148	19.2	1.5	10.3	29.5	11.8	65.9	55.9	Vb	Pass
5	0.16739	16.4	0.9	10.3	26.7	11.2	65.1	55.1	Vb	Pass
6	16.43311	27.6	21.8	10.4	38.0	32.2	60.0	50.0	Vb	Pass

[Chart]

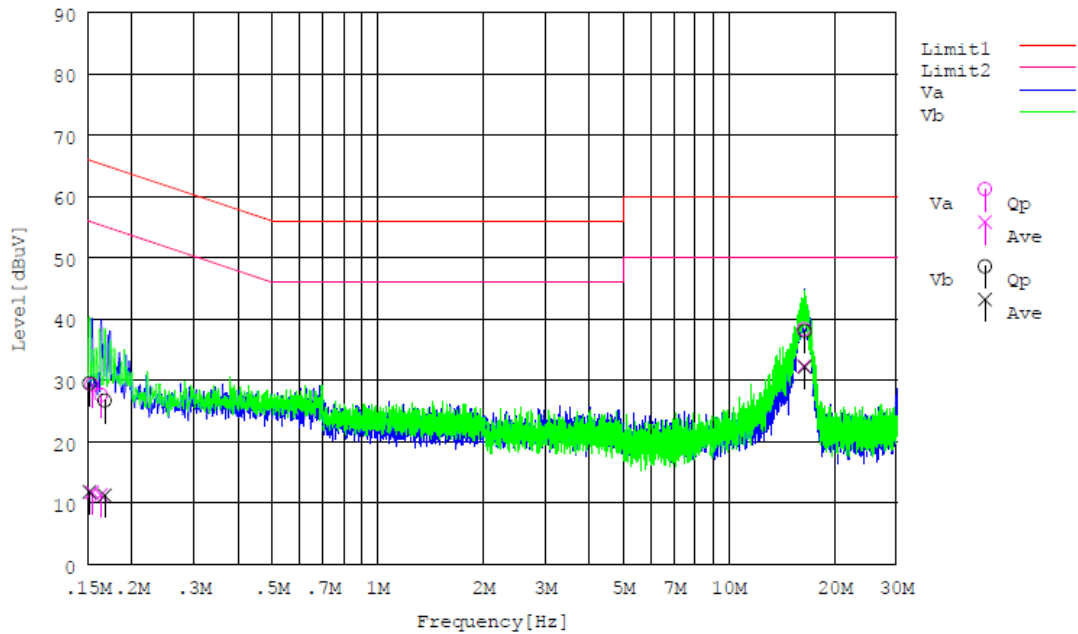

Operating mode: Rx 14 MHz

No.	Frequency [MHz]	Reading		C.F. [dB]	Result		Limit		Phase	Pass/Fail
		QP [dB μ V]	AV [dB μ V]		QP [dB μ V]	AV [dB μ V]	QP [dB μ V]	AV [dB μ V]		
1	0.15555	18.5	1.4	10.3	28.8	11.7	65.7	55.7	Va	Pass
2	0.16295	17.3	1.2	10.3	27.6	11.5	65.3	55.3	Va	Pass
3	16.30994	23.3	17.1	10.4	33.7	27.5	60.0	50.0	Va	Pass
4	0.15222	18.9	1.5	10.3	29.2	11.8	65.9	55.9	Vb	Pass
5	0.16369	17.0	1.2	10.3	27.3	11.5	65.3	55.3	Vb	Pass
6	16.36713	25.0	19.1	10.4	35.4	29.5	60.0	50.0	Vb	Pass

[Chart]

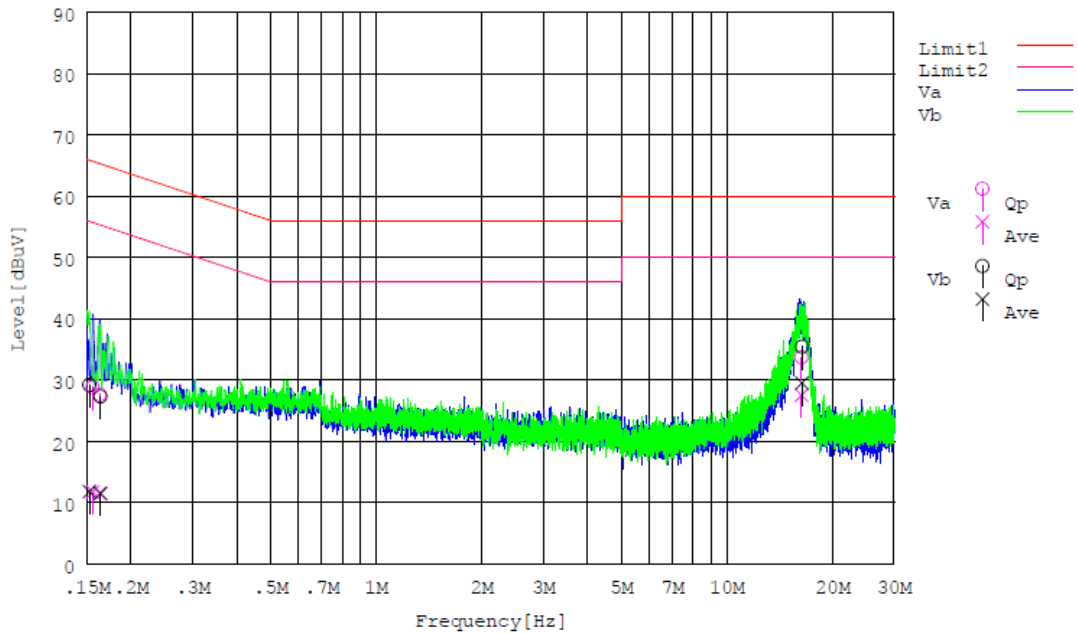

Operating mode: Rx 30 MHz

No.	Frequency [MHz]	Reading		C.F. [dB]	Result		Limit		Phase	Pass/Fail
		QP [dB μ V]	AV [dB μ V]		QP [dB μ V]	AV [dB μ V]	QP [dB μ V]	AV [dB μ V]		
1	0.15111	19.3	1.6	10.3	29.6	11.9	65.9	55.9	Va	Pass
2	0.15888	18.0	1.4	10.3	28.3	11.7	65.5	55.5	Va	Pass
3	16.22195	18.0	11.0	10.4	28.4	21.4	60.0	50.0	Va	Pass
4	0.15074	19.1	1.6	10.3	29.4	11.9	66.0	56.0	Vb	Pass
5	0.15518	18.3	1.4	10.3	28.6	11.7	65.7	55.7	Vb	Pass
6	16.38912	19.1	12.1	10.4	29.5	22.5	60.0	50.0	Vb	Pass

[Chart]

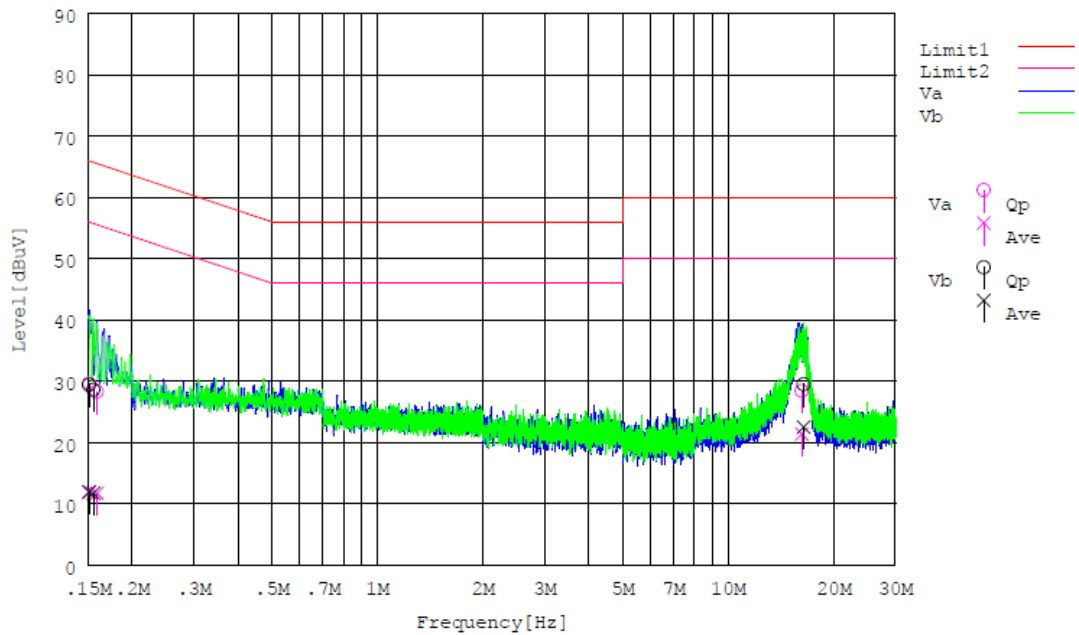

[Test condition]

Tested Date: 07 May, 2015 Temperature: 21 degC
 Humidity: 52 % Atmos. Press: 1013 hPa

4 List of utilized test equipment / calibration

RFT ID No.	Kind of Equipment and Precision	Manufacturer	Model No.	Serial Number	Calibration Date	Calibrated until
AC01(EM)	Anechoic Chamber (1st test room)	JSE	203397C	-	2015/4/18	2016/4/30
AC01(EG)	Anechoic Chamber (1st test room)	JSE	203397C	-	2014/11/24	2015/11/30
BA10	Biological Antenna	TESEQ	CBL6111D	32342	2014/6/9	2015/6/30
CL11	RF Cable for RE	RFT	-	-	2015/3/13	2016/3/31
CL18	RF Cable for CE	RFT	-	-	2015/5/1	2016/5/31
CL29	RF Cable 2 m	SUHNER	SUCOFLEX104PE	94709	2015/1/26	2016/1/31
CL30	RF Cable 5 m	SUHNER	SUCOFLEX104PE	MY3599	2014/8/28	2015/8/31
DH01	DRG Horn Antenna	A.H. Systems	SAS-571	785	2014/1/21	2016/1/31
LN05	LISN	Kyoritsu	KNW-407F	8-1773-2	2014/5/22	2015/5/31
PR12	Pre. Amplifier (1-26G)	Agilent Technologies	8449B	3008A02513	2015/1/26	2016/1/31
PR15	Pre. Amplifier	Anritsu	MH648A	6201156141	2014/6/10	2015/6/30
TR06	Test Receiver (F/W : 3.93 SP2)	Rohde & Schwarz	ESU26	100002	2014/9/5	2015/9/30

The measuring equipment, which was utilized in performing the tests documented herein, has been calibrated in accordance with the manufacturer's recommendations for utilizing calibration equipment, which is traceable to recognized national standards.