

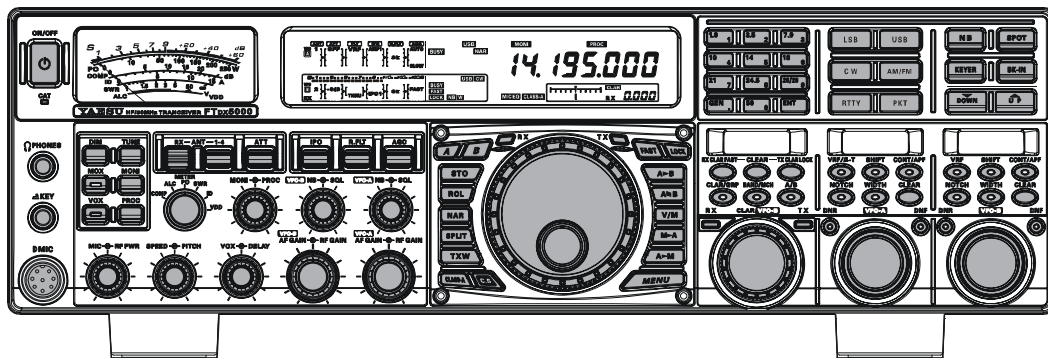

HF/50 MHz TRANSCEIVER

FTDX5000 SERIES

OPERATING MANUAL



VERTEX STANDARD CO., LTD.

4-8-8 Nakameguro, Meguro-Ku, Tokyo 153-8644, Japan

VERTEX STANDARD

US Headquarters

10900 Walker Street, Cypress, CA 90630, U.S.A.

YAESU UK LTD.

Unit 12, Sun Valley Business Park, Winnall Close
Winchester, Hampshire, SO23 0LB, U.K.

VERTEX STANDARD HK LTD.

Unit 5, 20/F., Seaview Centre, 139-141 Hoi Bun Road,
Kwun Tong, Kowloon, Hong Kong

VERTEX STANDARD (AUSTRALIA) PTY., LTD.

Normanby Business Park, Unit 14/45 Normanby Road
Notting Hill 3168, Victoria, Australia

FRONT PANEL CONTROLS & SWITCHES

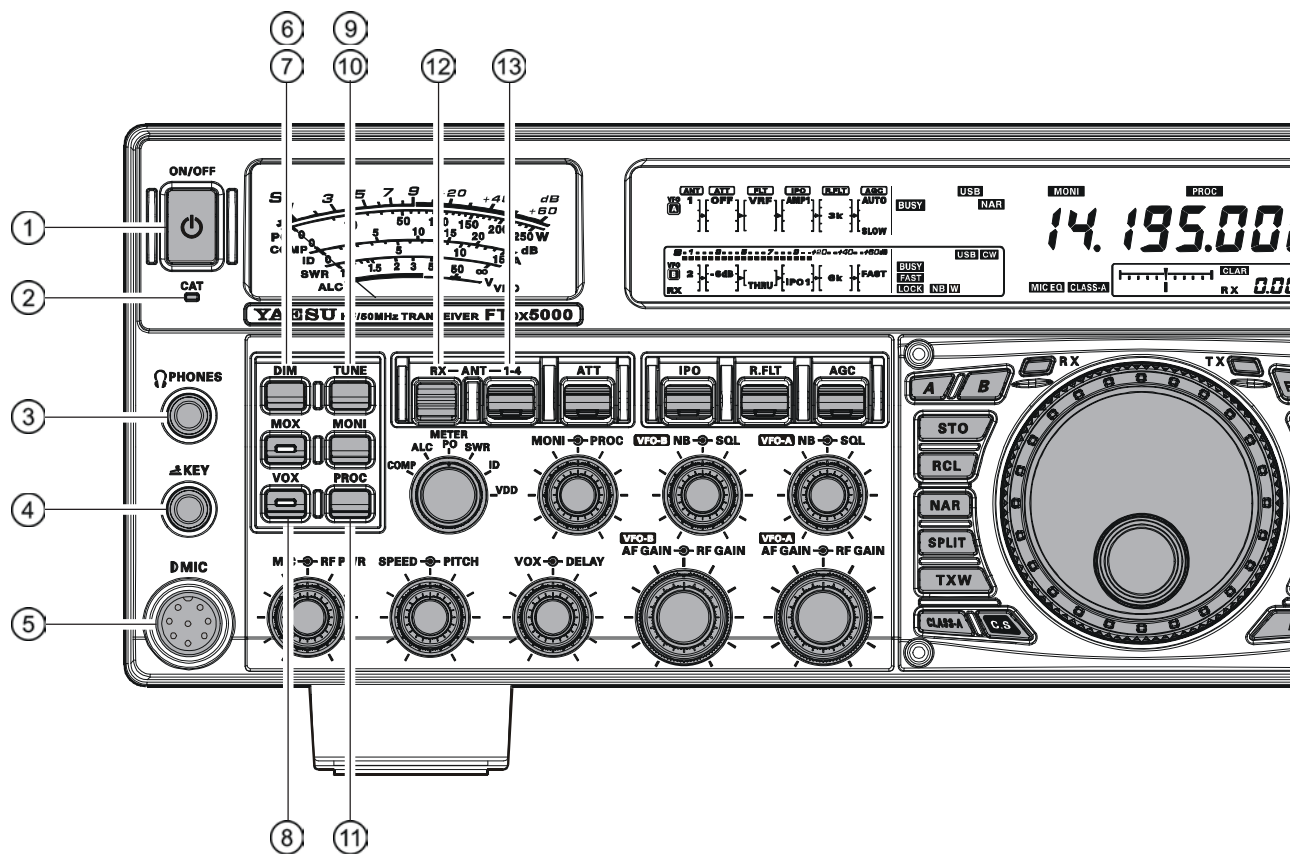

① [POWER] Switch

Press and hold in this switch for two seconds to turn the transceiver on, after first setting the rear panel [MAIN POWER] switch to the “I” position. Press and hold in this switch for two seconds, similarly, to turn the transceiver off. If the rear panel [MAIN POWER] switch is set to the “O” position, the front panel [POWER] switch will not function.

ADVICE:

- ❑ If you press this switch briefly while the transceiver is turned on, the transceiver’s audio will be muted for three seconds.
- ❑ This is the actual power On/Off switch for turning on the transceiver. When the rear panel [MAIN POWER] switch is set to the “I” position, power is supplied to the OXCO to stabilize the reference oscillator, and the remainder of the transceiver is set in a “stand-by” mode, awaiting the command for the transceiver to switch on via the front panel [POWER] switch. For further information on the rear panel [MAIN POWER] switch, please see the discussion on page ??.

② CAT Indicator

This LED indicator will flash red when the transmit and receive serial CAT command signals are being exchanged.

ADVICE:

You may disable the LED function (flashes in conjunction with CAT command) via Menu item “031 GEN E CAT IND.” See page ??? for details.

③ PHONES Jack

A 1/4-inch, 3-contact jack accepts either monaural or stereo headphones with 2- or 3-contact plugs. When a plug is inserted, the loudspeaker is disabled. With stereo headphones such as the optional YH-77STA, you can monitor both VFO-A and VFO-B receiver channels at the same time during Dual Receive operation.

NOTE:

When wearing headphones, we recommend that you turn the AF Gain levels down to their lowest settings before turning power on, to minimize the impact on your hearing caused by audio “pops” during switch-on.

④ KEY Jack

This 1/4-inch, 3-contact jack accepts a CW key or keyer paddles (for the built-in electronic keyer), or output from an external electronic keyer. Pinout is shown on page 15. Key up voltage is 5 V, and key down current is 1 mA. This jack may be configured for keyer, “Bug,” “straight key,” or computer keying interface operation via Menu item “054 A1A F-TYPE” (see page ???). There is another jack with the same name on the rear panel, and it may be configured independently for Internal Keyer or pseudo-straight-key operation.

NOTE:

You cannot use a 2-contact plug in this jack (to do so produces a constant “key down” condition).

⑤ Microphone Connector

This 8-pin jack accepts input from a microphone utilizing a traditional YAESU HF-transceiver pinout.

FRONT PANEL CONTROLS & SWITCHES

⑥ [DIM] Switch

Press this button to lower the illumination intensity of the analog meter and the frequency display. Press it once more to restore full brightness.

ADVICE:

Menu Items “008 diSP DIM MTR” and “009 diSP DIM VFD” allow you to configure the dimming levels for the analog meter and the frequency display independently, so you can customize the brightness levels.

⑦ [MOX] Switch

Pressing this button engages the PTT (Push to Talk) circuit, to activate the transmitter (the LED inside this button will glow red). It must be turned off (the red LED will be off) for reception. This button replicates the action of the Push to Talk (PTT) switch on the microphone. When engaging the [MOX] button (the LED inside this button glows red) or otherwise causing a transmission to be started, be certain you have either an antenna or 50-Ohm dummy load connected to the selected Antenna jack.

⑧ [VOX] Switch

This button enables automatic voice-actuated transmitter switching in the SSB, AM, and FM modes. While activated, the LED inside this button glows red. The controls affecting VOX operation are the front panel’s [VOX] and [DELAY] knobs. By proper adjustment of these controls, hands-free voice-actuated operation is possible.

⑨ [TUNE] Switch

This is the on/off switch for the FTdx5000’s Automatic Antenna Tuner.

Pressing this button momentarily places the antenna tuner in line between the transmitter final amplifier and the antenna jack (“TUNER” icon will appear in the display). Reception is not affected.

Pressing and holding in this button for 1/2 second, while receiving in an amateur band, activates the transmitter for a few seconds while the automatic antenna tuner rematches the antenna system impedance for minimum SWR. The resulting setting is automatically stored in one of the antenna tuner’s 100 memories, for instant automatic recall later when the receiver is tuned near the same frequency.

Pressing this button briefly, while the Tuner is engaged, will take the Automatic Antenna tuner out of the transmit line.

NOTE:

When the Automatic Antenna Tuner is tuning itself, a signal is being transmitted. Therefore, be absolutely certain that an antenna or dummy load is connected to the selected antenna jack before pressing and holding in the [TUNE] button to start antenna tuning.

⑩ [MONI] (Monitor) Switch

This button enables the transmit monitor in all modes. While activated, the “MONI” icon appears in the display. Adjustment of the Monitor level is accomplished using the [MONI] knob.

ADVICE:

When using headphones, the Monitor is highly useful for making adjustments to the Parametric Equalizer or other voice quality adjustments, because the voice quality heard in the headphones is such a “natural” reproduction of the transmitted audio quality.

⑪ [PROC] (Processor) Switch

This button enables the Speech Processor for SSB transmission. While activated, the “PROC” icon appears in the display. Adjustment of the Processor level is accomplished using the [PROC] knob.

ADVICE:

- The Speech Processor is a tool for increasing the average power output through a compression technique. However, if the [PROC] knob is advanced too far, the increase in compression becomes counter-productive, as intelligibility will suffer. We recommend that you monitor the sound of your signal using the Monitor (with headphones).
- When the optional DMU-2000 Data Management Unit is connected, you may use the Audio Scope/Oscilloscope page to help you adjust the setting of the compression level of the Speech Processor for optimum performance using your voice and microphone.

⑫ [RX ANT] Switch

Press this button to use the RX ANT jack on the rear panel while receive.

The “RX” icon appears in the display when the RX ANT is used.

⑬ [ANT 1-4] Switch

Move this knob up and down to select one of the ANT 1 through 4 jack on the rear panel, and allows convenient antenna switching at the move of knob. The selected antenna jack is indicated in the ANT column of the Block Diagram Display on the display.

ADVICE:

Press this knob briefly to select the ANT 1 jack for quick selection.

FRONT PANEL CONTROLS & SWITCHES

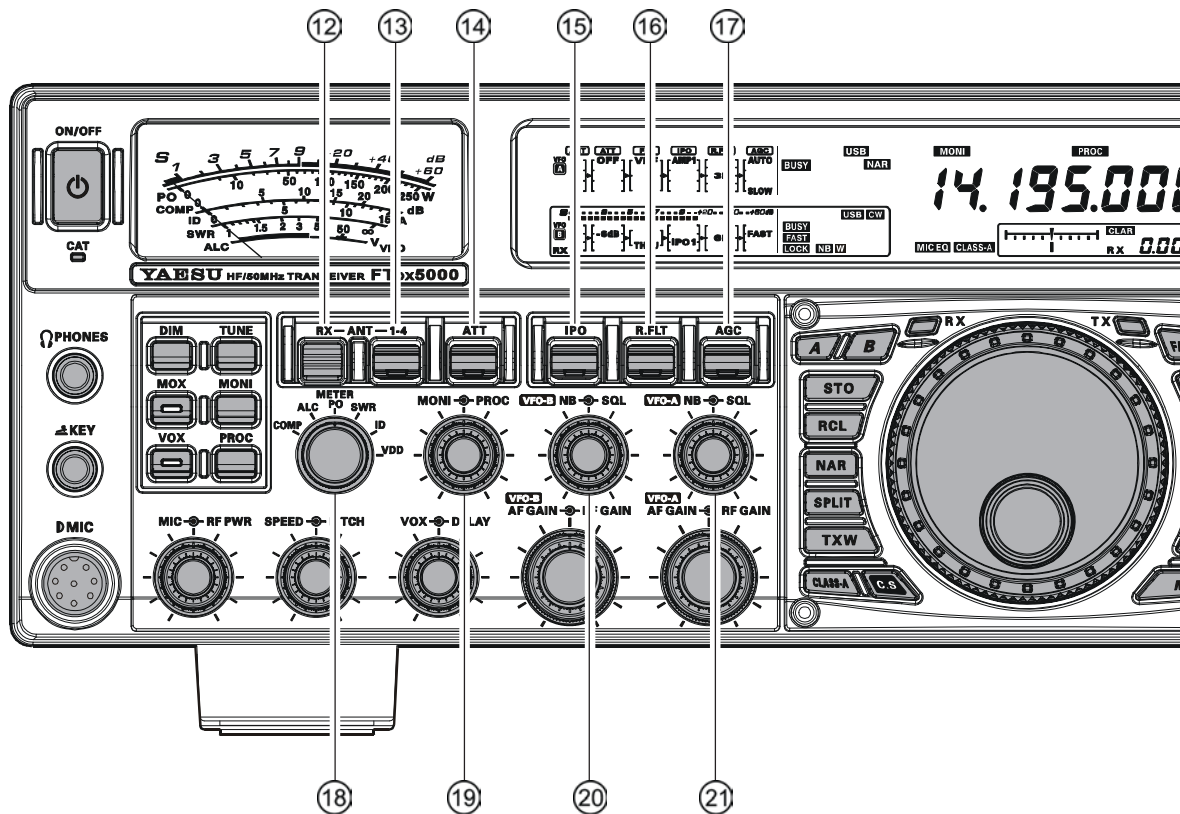

14 [ATT] Switch

Move this knob up and down to select the degree of attenuation, if any, to be applied to the receiver input. Available selections are “-6 dB”, “-12 dB”, “-18 dB”, or “OFF”, and the selected attenuation level appears in the ATT column of the Block Diagram Display on the display.

ADVICE:

- Press this knob briefly to select the attenuation level to “OFF” for quick selection.
- The Attenuator may be used in conjunction with the [IPO] switch to provide two stages of signal reduction when an extremely strong signal is being received.

15 [IPO] (INTERCEPT POINT OPTIMIZATION) Switch

Move this knob up and down to select the optimum front end characteristics of the receiver circuit for a very strong-signal environment. Available selections are “AMP 1”, “AMP 2”, “IPO 1”, or “IPO 2”.

Normally, this selection is set to “AMP1”. If you want to increase the sensitivity, this selection selects to “AMP2”. When this selection is set to “IPO1”, the IPO is improved. When this selection is set to “IPO2”, bypasses the RF preamplifier, yielding direct feed to the first mixer. As a result, the IPO is improved more.

ADVICE:

- Press this knob briefly to select the IPO setting to “AMP1” for quick selection.
- “IPO 2” selection can not select in VFO-B.

16 [R.FLT] Switch

Move this knob up and down to select the bandwidth for the first IF Roofing Filter. Available selections are “300 Hz”, “600 Hz”, “3 kHz”, “6 kHz”, “15 kHz”, or “AUTO” (“300 Hz” and “600 Hz” are select only in VFO-A, additionally, “300 Hz” is option, except MP version), and the selected bandwidth appears in the R.FLT column of the Block Diagram Display on the display.

ADVICE:

- Press this knob briefly to select to “AUTO” for quick selection.
- Because the roofing filter is in the first IF, the protection it provides against interference is quite significant. When set to “AUTO”, the SSB bandwidth is 6 kHz, while CW is 3 kHz, and FM/RTTY are 15 kHz. On a crowded SSB band, however, you may wish to select the 3 kHz filter, for the maximum possible interference rejection.

FRONT PANEL CONTROLS & SWITCHES

⑰ [AGC] Switch

Move this knob up and down to select the AGC characteristics (receiver-recovery time) for the receiver. Available selections are FAST, MID, SLOW, or AUTO, and the selected receiver-recovery time appears at the AGC column of the Block Diagram Display on the display.

Hold up or hold down this knob for two seconds to disable the AGC (for testing or weak-signal reception).

ADVICE:

- Press this knob briefly to select to AUTO for quick selection.
- If the AGC is set to disabled by holding up or down the [AGC] knob, the S-meter will no longer deflect. Additionally, you will likely encounter distortion on stronger signals, as the IF amplifiers and the following stages are probably being overloaded.

⑱ [METER] Switch

This control switch determines the function of the meter during transmission.

COMP: Indicates the speech compressor level (SSB mode only).

ALC: Indicates the relative ALC voltage.

PO: Indicates the average power output level.

SWR: Indicates the Standing Wave Ratio (Forward: Reflected).

ID: Indicates the final amplifier drain current.

VDD: Indicates the final amplifier drain voltage.

⑲ [MONI]↔[PROC] Knobs

[MONI] Knob

The inner [MONI] knob adjust the audio level of the transmit RF monitor during transmission (relative to the AF GAIN control), when activated by the [MONI] button.

[PROC] Knob

The outer [PROC] knob sets the compression (input) level of the transmitter Speech Processor in the SSB, AM, and FM modes, when activated by the [PROC] button.

ADVICE:

The **SUB DISPLAY-III** will show the relative compression level of the Speech Processor for 3 seconds whenever the outer [PROC] knob is turned. You may disable this feature (displaying the relative compression level) via Menu item “015 diSP LVL IND.” See page 113 for details.

⑳ (VFO-B) [NB]↔[SQL] Knobs

[NB] Knob

The inner [NB] knob adjusts the VFO-B noise blanking level when the (analog) IF noise blanker is activated by pressing the [NB] button.

[SQL] Knob

The outer [SQL] knob sets the signal level threshold at which the VFO-B receiver audio is muted, in all modes. It is very useful during local rag-chews, to eliminate noise between incoming transmissions. This control is normally kept fully counter-clockwise (off), except when scanning and during FM operation.

㉑ (VFO-A) [NB]↔[SQL] Knobs

[NB] Knob

The inner [NB] knob adjusts the VFO-A noise blanking level when the (analog) IF noise blanker is activated by pressing the [NB] button.

[SQL] Knob

The outer [SQL] knob sets the signal level threshold at which the VFO-A receiver audio is muted, in all modes. It is very useful during local rag-chews, to eliminate noise between incoming transmissions. This control is normally kept fully counter-clockwise (off), except when scanning and during FM operation.

FRONT PANEL CONTROLS & SWITCHES

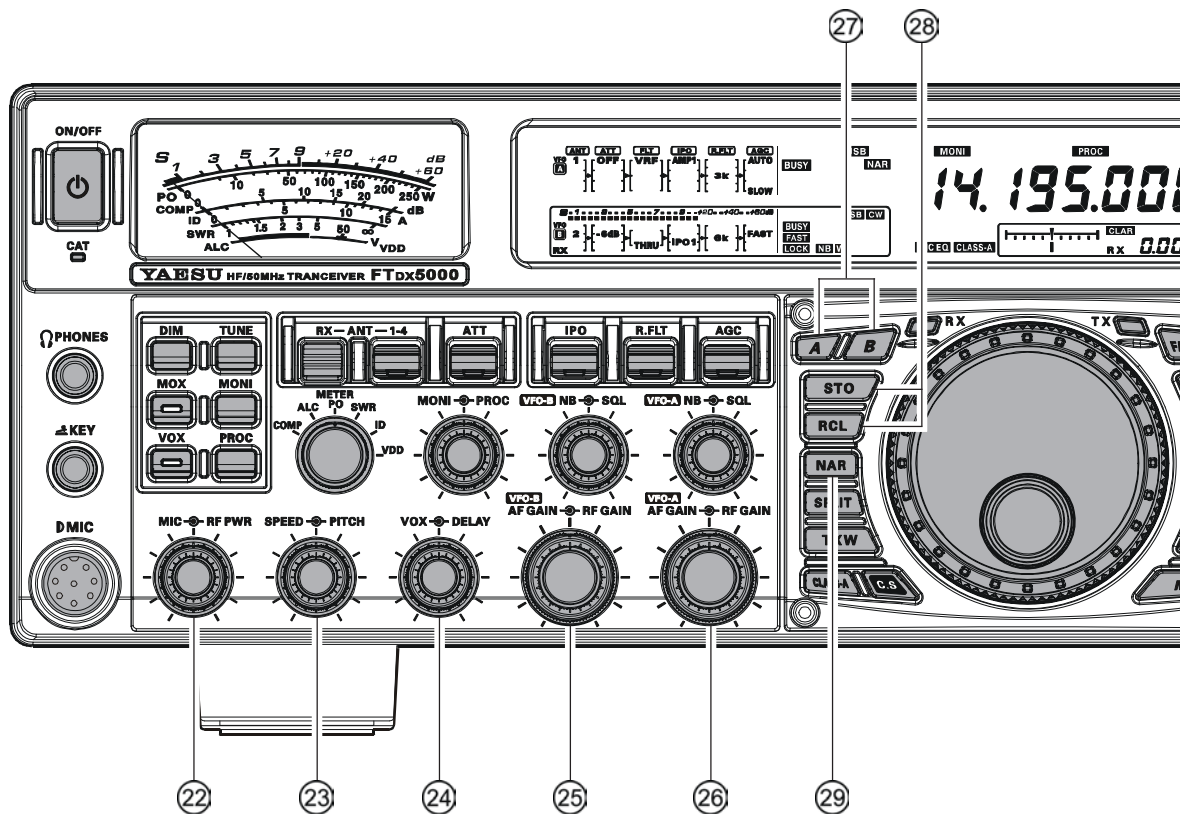

22 [MIC] ↔ [RF PWR] Knobs

[MIC] Knob

The inner [MIC] knob adjusts the microphone input level for (non-processed) SSB transmission.

ADVICE:

□ If you adjust the MIC Gain while speaking in a somewhat-louder-than-normal voice level, watch the ALC level and adjust the MIC Gain so that the ALC reaches just to the right edge of the ALC scale. Then, when you speak in a more normal voice level, you'll be certain not to be over-driving the mic amplifier stage.

□ The **SUB DISPLAY-III** will show the relative Microphone Gain level for 3 seconds whenever the inner [MIC] knob is turned.

You may disable this feature (displaying the relative Microphone Gain level) via Menu item "015 diSP LVL IND." See page 113 for details.

[RF PWR] Knob

The outer [RF PWR] knob is the main RF Power output control for the transceiver, active in all operating modes. Clockwise rotation increases the power output. Adjust this control for the desired power output from the **FTDX5000**.

ADVICE:

The **SUB DISPLAY-III** will show the RF Power Output for 3 seconds whenever the outer [RF PWR] knob is turned.

You may disable this feature (displaying the RF Power Output) via Menu item "015 diSP LVL IND." See page 113 for details.

23 [SPEED] ↔ [PITCH] Knobs

[SPEED] Knob

The inner [SPEED] knob adjusts the keying speed of the internal CW keyer (4 ~ 60 WPM). Clockwise rotation increases the sending speed.

When turning this knob while pressing the [KEYER] button, the Sub (VFO-B) frequency display shows the keying speed.

ADVICE:

The **SUB DISPLAY-III** will show the keying speed for 3 seconds whenever the inner [SPEED] knob is turned.

You may disable this feature (displaying the keying speed) via Menu item "015 diSP LVL IND." See page ??? for details.

[PITCH] Knob

The outer [PITCH] knob selects your preferred CW tone pitch (from 300 ~ 1050 Hz, in 50 Hz increments). The Tx sidetone, receiver IF passband, and display offset from the BFO (carrier) frequency are all affected simultaneously. The Pitch control setting also affects the operation of the CW Tuning Indicator, as the center frequency of the CW Tuning Indicator will follow the setting of this control.

ADVICE:

The **SUB DISPLAY-III** will show the CW tone pitch frequency for 3 seconds whenever the outer [PITCH] knob is turned.

You may disable this feature (displaying the CW tone pitch frequency) via Menu item "015 diSP LVL IND." See page ??? for details.

FRONT PANEL CONTROLS & SWITCHES

24 [VOX] → [DELAY] Knobs

[VOX] Knob

The inner [VOX] knob sets the gain of the VOX circuit, to set the level of microphone audio needed to activate the transmitter during voice operation while the [VOX] switch is engaged. The [VOX] switch must be switched “ON” to engage the VOX circuit.

[DELAY] Knob

The outer [DELAY] knob sets the hang time of the VOX circuit for voice operation and keying delay for CW operation.

During voice operation, this knob sets the hang time, between the moment you stop speaking, and the automatic switch from transmit back to receive. Adjust this for smooth VOX operation, so the receiver is only activated when your transmission is ended and you wish to receive.

For CW operation, this knob sets the keying delay, between the moment you stop sending, and the automatic switch from transmit back to receive during “Semi-break-in” operation. Adjust this just long enough to prevent the receiver from being restored during word spaces at your preferred sending speed.

ADVICE:

The **SUB DISPLAY-III** will show the hang time of the VOX circuit for 3 seconds whenever the outer [DELAY] knob is turned.

You may disable this feature (displaying the hang time of the VOX circuit) via Menu item “015 diSP LVL IND.” See page ??? for details.

25 (VFO-B) [AF GAIN] → [RF GAIN] Knobs

[AF GAIN] Knob

The inner [AF GAIN] knob sets the VFO-B receiver’s audio volume level. Typically, you will operate with this control set between the 9 o’clock and 10 o’clock positions.

[RF GAIN] Knob

The outer [RF GAIN] knob is the VFO-B receiver’s RF gain control, which adjusts the gain of the VFO-B receiver’s RF and IF amplifier stages. This control is normally left in the fully clockwise position.

26 (VFO-A) [AF GAIN] → [RF GAIN] Knobs

[AF GAIN] Knob

The inner [AF GAIN] knob sets the VFO-A receiver’s audio volume level. Typically, you will operate with this control set between the 9 o’clock and 10 o’clock positions.

[RF GAIN] Knob

The outer [RF GAIN] knob is the VFO-A receiver’s RF gain control, which adjusts the gain of the VFO-A receiver’s RF and IF amplifier stages. This control is normally left in the fully clockwise position.

27 [A], [B] Switches

Pressing the [A] or [B] button will illuminate the respective indicator imbedded within the switch, allowing adjustment of the major functions (such as mode and band selection etc) on the VFO-A or VFO-B band. Usually, the [A] button glow red, signifying that the VFO-A is being adjusted. Similarly, pressing the [B] button will cause its indicator glow orange, signifying VFO-B adjustment.

ADVICE:

The [A]/[B] switch’s function is effect for following switches:

- [RX ANT] switch
- [ANT 1-4] switch
- [ATT] switch
- [IPO] switch
- [R.FLT] switch
- [AGC] switch
- [NAR] switch
- [BAND] switches
- [MODE] switches
- [NB] switch
- [RX ANT] switch

28 QMB (Quick Memory Bank) Switches

[STO] (Store) Button

Pressing this button copies operating information (frequency, mode, bandwidth, and also repeater direction/shift frequency and CTCSS functions on the FM mode) into consecutive QMB Memories.

[RCL] (Recall) Button

Pressing this button recalls one of up to five Quick Memory Bank memories for operation.

29 [NAR] (Narrow) Switch

This button is used to set the DSP (digital) filters to narrow bandwidth. The default values are follows:

MODE	NAR SWITCH	
	OFF	ON
LSB/USB	2.4 kHz* (1.8 kHz - 4.0 kHz / 16 steps)	1.8 kHz* (200 Hz - 1.8 kHz / 9 steps)
CW	2.4 kHz* (500 Hz - 2.4 kHz / 7 steps)	500 Hz* (50 Hz - 500 Hz / 10 steps)
RTTY (LSB)	500 Hz* (500 Hz - 2.4 kHz / 7 steps)	300 Hz* (50 Hz - 500 Hz / 10 steps)
PKT (LSB/USB)	500 Hz* (500 Hz - 2.4 kHz / 7 steps)	300 Hz* (50 Hz - 500 Hz / 10 steps)
PKT (FM)	25 kHz (±5.0 kHz Deviation)	12.5 kHz (±2.5 kHz Deviation)
AM	9 kHz	6 kHz
FM	25 kHz (±5.0 kHz Deviation)	12.5 kHz (±2.5 kHz Deviation)

※: You may enable to adjust the bandwidth by the [WIDTH] knob.

FRONT PANEL CONTROLS & SWITCHES

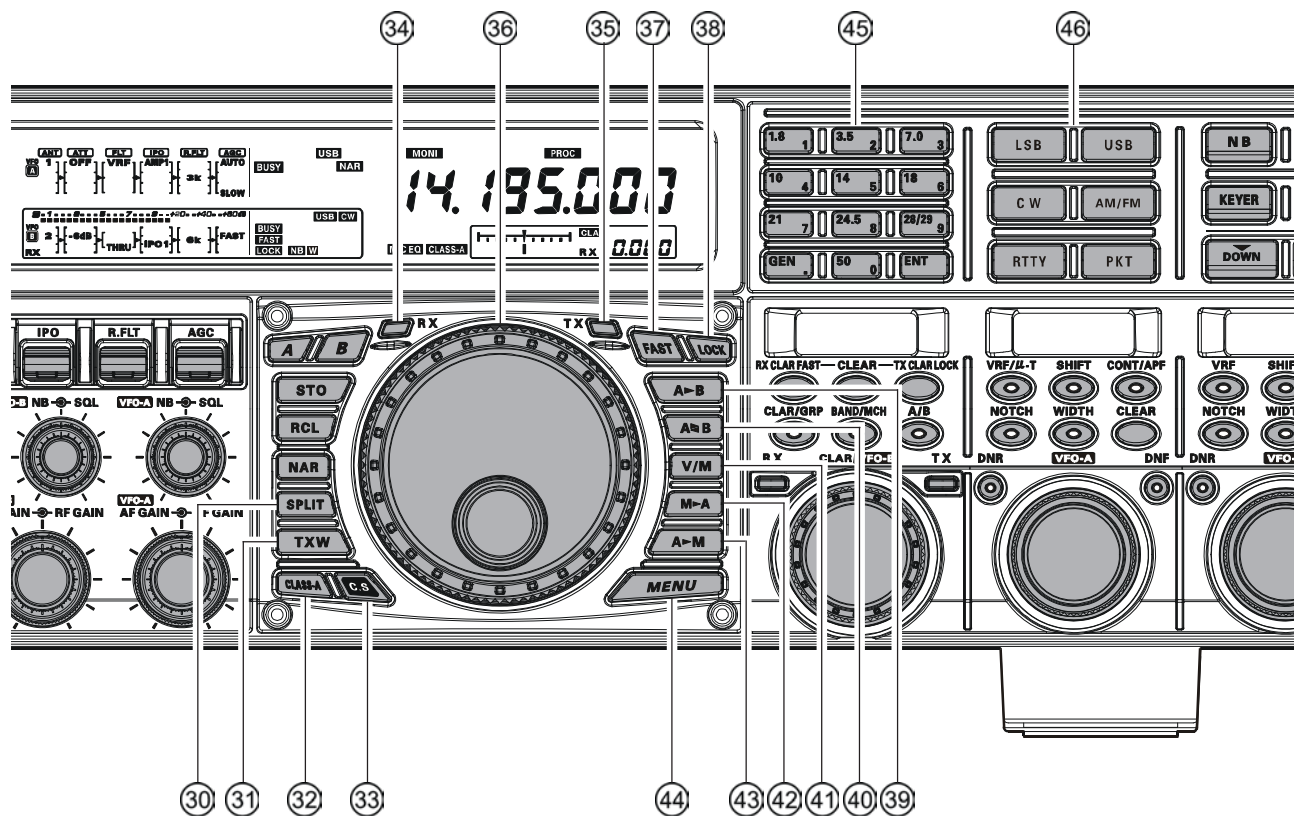

30 [SPLIT] Switch

Pressing this button to activate split frequency operation between the VFO-B, used for reception, and the VFO-A, used for transmission. If you press and hold in this button for two seconds, the “Quick Split” feature will be engaged, whereby the VFO-B will automatically be set to a frequency 5 kHz higher than the VFO-A frequency with same operating mode, and the transceiver will be placed in the Split mode.

31 [TXW] (TX Watch) Switch

Pressing this button lets you monitor the transmit frequency when split frequency operation is engaged. Release the button to return to normal operation.

32 [CLASS-A] Switch

Pressing this button engages the Class-A capability for the transmitter. The power output will be reduced to a maximum of 75 Watts, however, the Class-A operation provides an ultra-clean SSB wave-form. When Class-A operation is engaged, the “CLASS-A” icon appears in the display. Press this button once more to return to Class-AB operation at a maximum power output of 200 Watts; the “CLASS-A” icon disappears to confirm Class-AB operation.

ADVICE:

You may adjust the bias level between “Class-AB” and “Class-A” via Menu item “015 tGen BAIS”. See page ??? for details.

33 [C.S] Switch

Press this button briefly to recall a favorite Menu Selection directly.

To program a Menu selection as the short-cut, press the [MENU] button to enter the Menu, then select the Menu item you want to set as the short-cut. Now press and hold in the [C.S] button for two seconds; this will lock in the selected Menu item as the short-cut.

34 (VFO-A)[RX] Indicator/Switch

This button, when pressed, engages the VFO-A receiver; the LED inside this button will glow green when the VFO-A receiver is active.

When the VFO-A receiver is active, pressing this button briefly will mute the receiver, and the indicator will blink. Pressing the button once more will restore receiver operation, and the indicator will glow green steadily.

35 (VFO-A)[TX] Indicator/Switch

When this button is pressed, the LED inside this button will glow red, and the transmitter will be engaged on the same frequency and mode as set up for the VFO-A (subject to any Clarifier offset, of course).

ADVICE:

If this indicator is not illuminated, it means that the VFO-B TX indicator has been selected (it will be glowing red). In this case, transmission will be effected on the frequency and mode programmed for the VFO-B.

FRONT PANEL CONTROLS & SWITCHES

36 Main Tuning Dial Knob

This large knob adjusts the operating frequency of the VFO-A or a recalled memory. Clockwise rotation of this knob increases the frequency. Default tuning increments are 10 Hz (100 Hz in AM and FM modes); when the [FAST] button is pressed, the tuning steps increase. The available steps are:

OPERATING MODE	1 STEP	1 DIAL ROTATION
LSB/USB/CW/RTTY/PKT(SSB)	10 Hz (100 Hz)	10 kHz (100 kHz)
AM/FM/PKT(FM)	100 Hz (1 kHz)	100 kHz (1 MHz)

Numbers in parentheses indicate steps when the [FAST] button is On.

ADVICE:

The tuning steps for the Main Tuning Dial knob are set, at the factory, to 10 Hz per step. Via Menu item “118 tun DIAL STEP,” however, you may change this setting from 10 Hz to 5 Hz or 1 Hz instead. When press the [FAST] button, the tuning step change to 100 Hz.

37 [FAST] Switch

Pressing this button will change the VFO-A’s tuning step to 100 Hz.

When this function is activated, the “FAST” icon appears in the display.

38 [LOCK] Switch

This button toggles locking of the Main Tuning Dial knob, to prevent accidental frequency changes. When the button is active, the Main Tuning Dial knob can still be turned, but the VFO-A frequency will not change, and the “LOCK” icon appears in the display.

39 [A▶B] Switch

Press this button briefly to transfer data from the VFO-A frequency (or a recalled memory channel) to the VFO-B, overwriting any previous contents in the VFO-B. Use this button to set both VFO-A and VFO-B receivers to the same frequency and mode.

40 [A▶B] Switch

Pressing this button momentarily exchanges the contents of the Main band (VFO-A) (or a recalled memory channel) and the Sub band (VFO-B).

41 [V/M] Switch

This button toggles VFO-A receiver operation between the memory system and the VFO. Either “MR” or “MT” will be displayed to the under the main frequency display field to indicate the current selection. If you have tuned off of a Memory channel frequency (MT), pressing this button returns the display to the original memory contents (MR), and pressing it once more returns operation to the VFO-A (no icon).

42 [M▶A] Switch

Pressing this button momentarily displays the contents of the currently-selected memory channel for three seconds.

Holding this button in for 2 seconds copies the data from the currently-selected memory to the VFO-A, as two beeps sound. Previous data in the VFO-A will be overwritten.

43 [A▶M] Switch

Pressing and holding in this button for 1/2 second (until the double beep) copies the current operating data from the VFO-A into the currently selected memory channel, overwriting any previous data stored there. See page ??? for details.

Also, pressing and holding in this button after recalling a memory, without first retuning, causes the memory channel to be “masked,” and repeating the process restores the masked memory.

44 [MENU] Switch

This button is used for gaining access to the Menu system, for configuring various transceiver characteristics. Menu operation is described in detail, in this manual, beginning on page ???.

IMPORTANT NOTE:

Pressing this button briefly activates the Menu, and the Menu items will appear on the SUB DISPLAYS; once you are finished, you must press and hold in the [MENU] button for two seconds to save any configuration changes (momentarily pressing the [MENU] button to exit will not save the changes).

45 [BAND] Keys

These buttons allow one-touch selection of the desired amateur band (1.8 ~ 50 MHz).

What’s more, these buttons may be used for direct entry of a desired operating frequency during VFO operation.

46 [MODE] Switches

Pressing one of these buttons, selects the operating mode. Repeated presses of a particular switch will toggle to the alternate mode, or step through the available selections, as shown in the chart below.

FRONT PANEL CONTROLS & SWITCHES

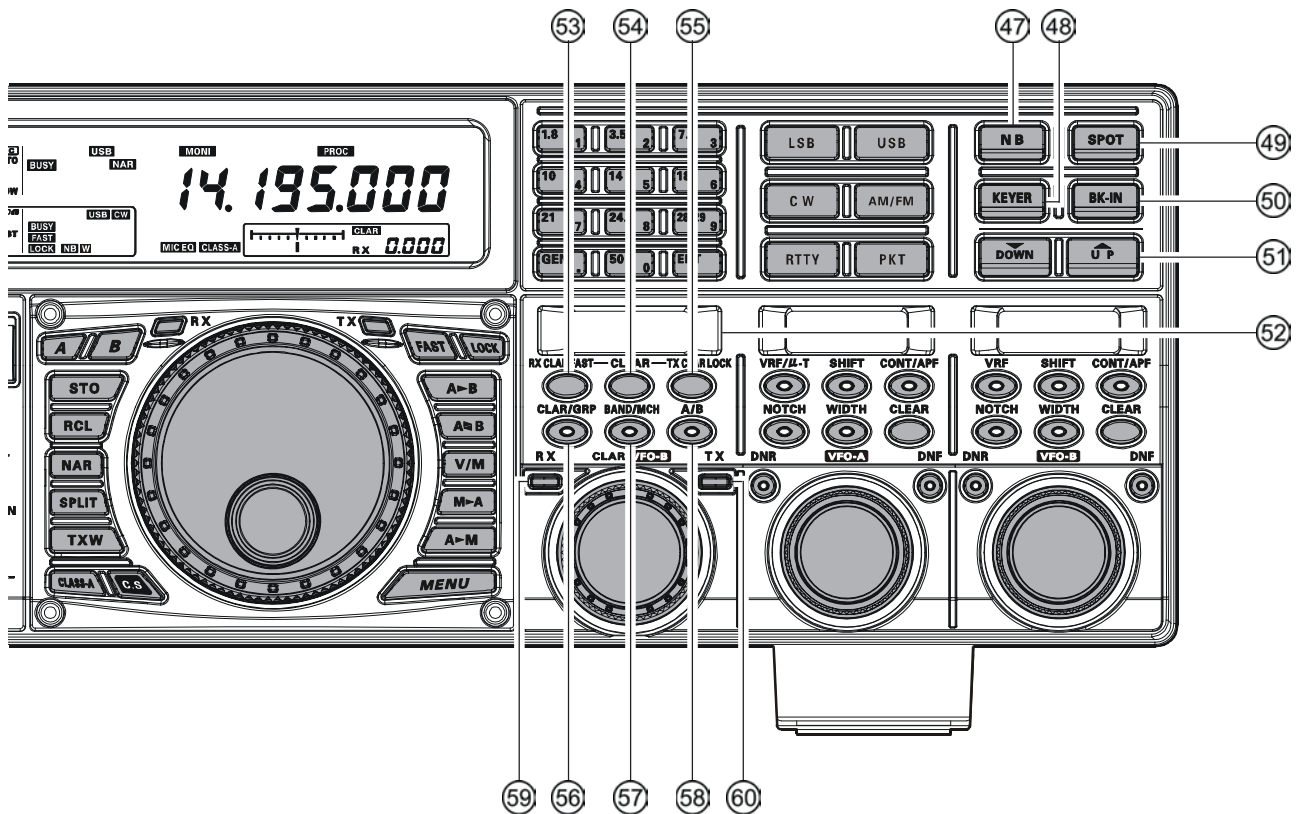

47 [NB] Switch

This button turns the IF Noise Blanker on and off. Press this button briefly to reduce a short-duration pulse noise; the “**NB**” icon will appear in the display. Press and hold in this button for one second to reduce a longer-duration man-made pulse noise; the “**NB W**” icon will appear in the display. Press this button again to disable the noise blanker; the “**NB**” or “**NB W**” icon will disappear.

48 [KEYER] Switch

This button toggles the internal CW keyer on and off. While activated, the “**KEYER**” icon appears in the display. The keyer sending speed is adjusted via the front panel’s [SPEED] knob and the CW Hang Time is adjusted via the Menu item “044 A1A DELAY”.

ADVICE:

When press an holding this button to shows the keying speed on the **SUB DISPLAY-III**.

You may disable this feature (displaying the keying speed) via Menu item “015 diSP LVL IND.” See page ??? for details.

49 [SPOT] Switch

This button turns on the CW receiver spotting tone; by matching the SPOT tone to that of the incoming CW signal (precisely the same pitch), you will be “zero beating” your transmitted signal on to the frequency of the other station.

ADVICE:

The **SUB DISPLAY-III** will indicate the offset tone frequency when this button is pressed.

50 [BK-IN] Switch

This button turns the CW break-in capability on and off. While the CW break-in is activated, the “**BK-IN**” icon appears in the display.

51 [▼(DOWN)]/[▲(UP)] Switches

These buttons adjust the operating frequency of the VFO or a recalled memory in 100 kHz step.

52 SUB DISPLAY-I

This LCD display shows the VFO-B frequency, and it indicates the Menu List while the Menu Mode is active.

FRONT PANEL CONTROLS & SWITCHES

⑤③ [RX CLAR(FAST)] Switch

The function of this button is different by the setting of the [A/B] button (described later).

When the imbedded LED of the [A/B] button is turned off, pressing this button activates the RX Clarifier, to allow offsetting the VFO-A receiving frequency temporarily. Press this button once more to return the Main receiver to the frequency shown on the main frequency display field; the Clarifier offset will still be present, though, in case you want to use it again. To cancel the Clarifier offset, press the [CLEAR] button.

When the imbedded LED of the [A/B] button glows orange, pressing this button will change the VFO-B's tuning step to 100 Hz.

When this function is activated, the “**FAST**” icon appears in the display.

⑤④ [CLEAR] Switch

Pressing this button clears out any frequency offset you have programmed into the Clarifier register (thereby setting the offset to “Zero”).

⑤⑤ [TX CLAR/LOCK] Switch

The function of this button is different by the setting of the [A/B] button (described later).

When the imbedded LED of the [A/B] button is turned off, pressing this button activates the TX Clarifier, to allow offsetting the VFO-A transmit frequency temporarily. Press this button once more to return the transmitter to the VFO-A frequency shown on the main frequency display field; the Clarifier offset will still be present, though, in case you want to use it again. To cancel the Clarifier offset, press the [CLEAR] button.

When the imbedded LED of the [A/B] button glows orange, this button toggles locking of the [CLAR(VFO-B)] knob, to prevent accidental frequency changes. When this button is active, the [CLAR(VFO-B)] knob can still be turned, but the VFO-B frequency will not change, and the “**LOCK**” icon appears in the display.

⑤⑥ [CLAR/GRP] Switch

This button has two functions.

When press this button briefly, the [CLAR/VFO-B] knob will be enabled for the purpose of utilizing the [CLAR/VFO-B] knob as an “offset tuning” control to allow tuning away from the VFO-A, and the imbedded LED of the [CLAR/GRP] button is glows red.

When press and hold this button for one second, allows you to select the memory group using the [CLAR(VFO-B)] knob, and the imbedded LED of the [CLAR/GRP] button is glows yellow.

⑤⑦ [BAND(MCH)] Switch

This button has two functions.

When press this button briefly, allows you to select the VFO-A operating band (Amateur bands) using the [CLAR(VFO-B)] knob, and the LED inside of the [CLAR/GRP] button is glows red.

When press and hold this button for one second, allows you to select the memory channel using the [CLAR(VFO-B)] knob, and the imbedded LED of the [CLAR/GRP] button is glows yellow.

⑤⑧ [A/B] Switch

This button determines whether the actions of the [CLAR(VFO-B)] knob will be applied to the VFO-A or the VFO-B.

Pressing this button once causes the imbedded LED of this button glows yellow; in this case, rotation of the [CLAR(VFO-B)] knob affects operation on the VFO-B (tuning, etc.). Pressing this button once more causes the imbedded LED of this button to turn off; in this instance, rotation of the [CLAR(VFO-B)] knob affects operations associated with the VFO-A (Clarifier function, etc.).

⑤⑨ (VFO-B)[RX] Indicator/Switch

This is the button that turns the VFO-B receiver “On” and “Off”. When this button is pressed to make the VFO-B receiver active, the imbedded LED will glows green. Pressing this button again will disable this receiver, and the imbedded green LED will turn off.

⑥⑩ (VFO-B)[TX] Indicator/Switch

This is the button that turns the VFO-B transmitter “On” and “Off”. When this button is pressed to transfer transmitter control to the VFO-B frequency and mode, the imbedded LED will glows red. Pressing this button once more will transfer frequency/mode control back to the VFO-A side, and the red LED imbedded within this button will turn off.

FRONT PANEL CONTROLS & SWITCHES

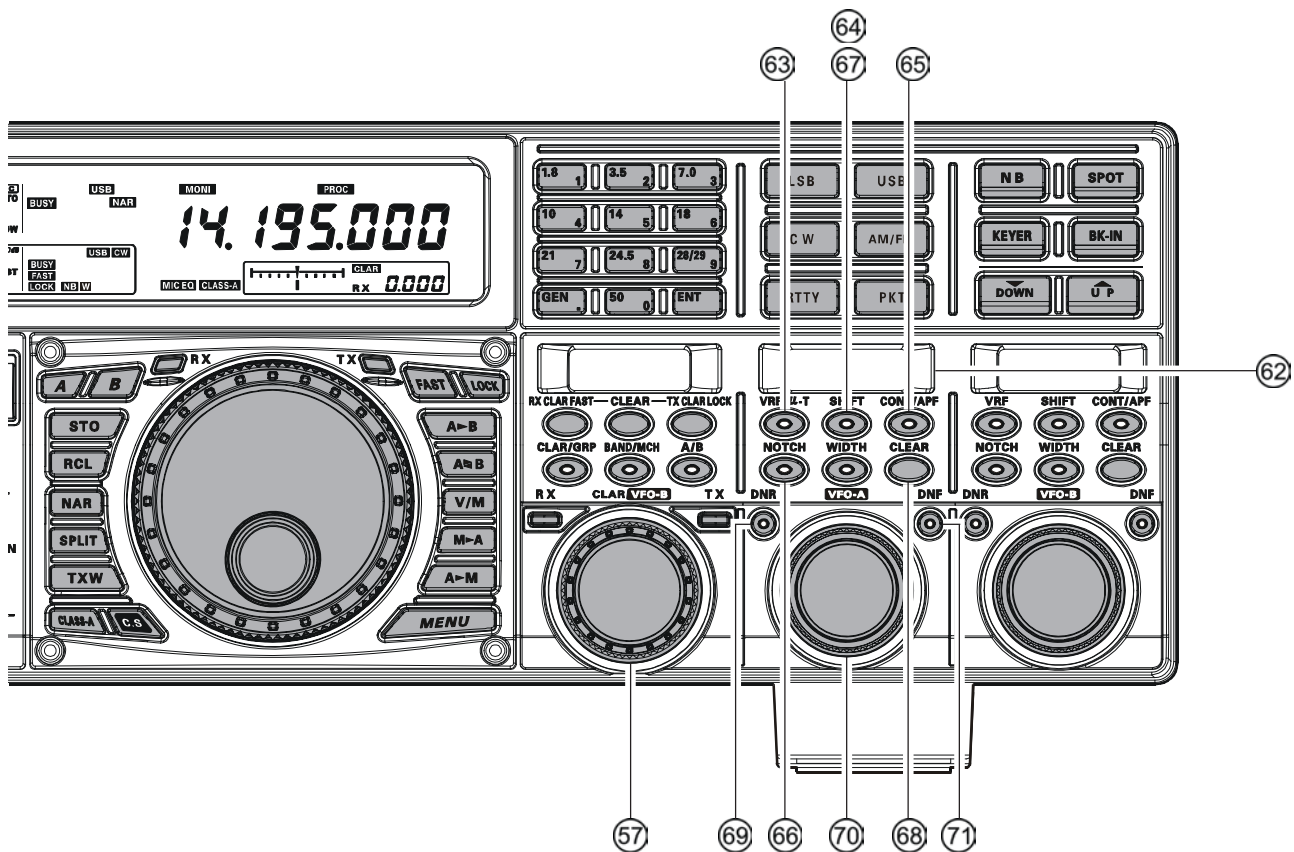

61 [CLAR(VFO-B)] Knob

The function of this knob is different by the setting of three switches located above this knob. See next page for details.

62 SUB DISPLAY-II

This LCD display shows the character of the VFO-A receiver's DSP function selected by the five buttons located below of this display, and the (VFO-A)[SELECT] knob located below this window works as an adjustment knob that displayed to this window. Furthermore, when the Menu Mode is activated, this LCD display indicates the Menu item.

63 (VFO-A)[VRF/μ-T] Switch

This button turns the VFO-A receiver's contour filter "on" and "off", and allows you to adjust the center frequency of the VRF filter by the (VFO-A)[SELECT] knob. While activated, the red imbedded LED in this button will light up, and the "VRF" icon will appear in the FLT column of the Block Diagram Display on the display.

ADVICE:

When the optional RF μTuning Kit is connected, pressing this button will engage the μ-Tuning filter. The μTuning Kit provides much better RF selectivity than any other RF filter in the Amateur industry, yielding outstanding protection from high RF levels not far removed from the current operating frequency.

64 (VFO-A)[SHIFT] Switch

Pressing this button allows you to move the IF DSP bandwidth of VFO-A "higher" or "lower" by the (VFO-A)[SELECT] knob. When the IF passband is shifted, the red LED imbedded in this button will light up. To the contrary, when the IF passband is just centered, the red LED imbedded in this button turns off.

65 (VFO-A) [CONT/APF] Switch

In the SSB, AM, and FM modes, this button turns the VFO-A receiver's contour filter "on" and "off", and allows you to adjust the center frequency of the contour filter by the (VFO-A)[SELECT] knob. When the contour filter is activated, the red imbedded LED in this button will light up.

In the CW mode, this button turns the VFO-A receiver's APF (Audio Peak Filter) "on" and "off", and allows you to adjust the bandwidth of the APF filter by the (VFO-A)[SELECT] knob. When the APF filter is activated, the red imbedded LED in this button will light up.

66 (VFO-A)[NOTCH] Switch

This button turns the VFO-A receiver's IF notch filter "on" and "off", and allows you to adjust the center frequency of the notch filter by the (VFO-A)[SELECT] knob. When the notch filter is activated, the red imbedded LED in this button will light up.

FRONT PANEL CONTROLS & SWITCHES

67 (VFO-A)[WIDTH] Switch

Pressing this button allows you to adjust the overall bandwidth of the VFO-A receiver's IF DSP filter by the (VFO-A)[SELECT] knob. When the bandwidth is set to different than the factory default, the red imbedded LED in this button will light up. To the contrary, when the bandwidth is set to default, the red imbedded LED in this button turns off.

68 (VFO-A)[CLEAR] Switch

Pressing this button will reset to factory default the function, which are selected with five buttons located at the upper left of this button.

69 (VFO-A)[DNR] Knob

This button toggles the VFO-A receiver's Digital Noise Reduction circuit "on" and "off", and allows you to adjust the noise reduction level by the (VFO-A)[SELECT] knob. When the Digital Noise Reduction is activated, the red LED imbedded with in this button will light up.

70 (VFO-A)[SELECT] Knob

This knob is used to adjust status of the functions selected by the five buttons located above the knob.

71 (VFO-A)[DNF] Switch

This button toggles the VFO-A receiver's Digital Notch Filter "on" and "off". When the Digital Notch Filter is activated, the red LED imbedded in this button will light up. This is an automatic circuit, and there is no adjustment knob for the DNF.

[CLAR(VFO-B)] Knob Functions

When the imbedded LED of the [A/B] button is turned "off"

In this case, the [CLAR(VFO-B)] knob is used for Clarifier tuning, as well as Up/Down selection of the Amateur band, Memory Channels, 1 MHz tuning steps, or Memory Groups.

Clarifier Operation

When the the [CLAR/GRP] button is pressed briefly, the imbedded LED in the button will glow red, and the [CLAR(VFO-B)] knob may be used to program an offset of up to ± 9.999 kHz from the VFO-A frequency. This offset is only applied, however, to the receive or transmit frequency if the [RX CLAR/FAST] button and/or [TX CLAR/LOCK] button, respectively, have been pushed.

To apply the programmed frequency offset to the Receive frequency, press the [RX CLAR/FAST] button briefly. To return to the VFO-A frequency, without the offset, press the [RX CLAR/FAST] button once more.

To apply the programmed frequency offset to the Transmit frequency, press the [TX CLAR/LOCK] button briefly. To return the transmitter to the VFO-A frequency, without the offset, press the [TX CLAR/LOCK] button once more.

To reset the Clarifier frequency to "0" offset, press the [CLEAR] button.

BAND Up / Down Control

When the [BAND/MCH] button is pressed briefly, the imbedded LED in the button will glow red, and you may enable the use of the [CLAR(VFO-B)] knob for selecting the desired amateur band. If you have engaged the "My Bands" feature via Menu #145, the [CLAR(VFO-B)] knob will select from among just the amateur bands that you have included in the "My Bands" list.

Memory Channel / Memory Group Control

Pressing and holding in the [BAND/MCH] button for two seconds, the imbedded LED in the button will glow yellow, and you may enable the use of the [CLAR(VFO-B)] knob for selection of the desired Memory Channel.

Pressing and holding in the [CLAR/GRP] button for two seconds, the imbedded LED in the button will glow yellow, and you may enable the use of the [CLAR(VFO-B)] knob for selecting the desired Memory Group.

When the imbedded LED of the [A/B] button glows orange

When the [A/B] button is pressed, the imbedded LED in the button will glow orange, and the [CLAR(VFO-B)] knob will now be exercising control functions associated with the VFO-B frequency control register.

VFO-B FAST Tuning

When the [RX CLAR/FAST] button is pressed, the "FAST" icon appears in the display, and the VFO-B's tuning step changes to 100 Hz. Press the [RX CLAR/FAST] button once more to return to the normal tuning rate.

VFO-B FAST Tuning

When the [TX CLAR/LOCK] button is pressed, the "LOCK" icon appears in the display, and the the [CLAR(VFO-B)] knob is locked. Press the [RX CLAR/FAST] button once more to disable the lock feature.

FRONT PANEL CONTROLS & SWITCHES

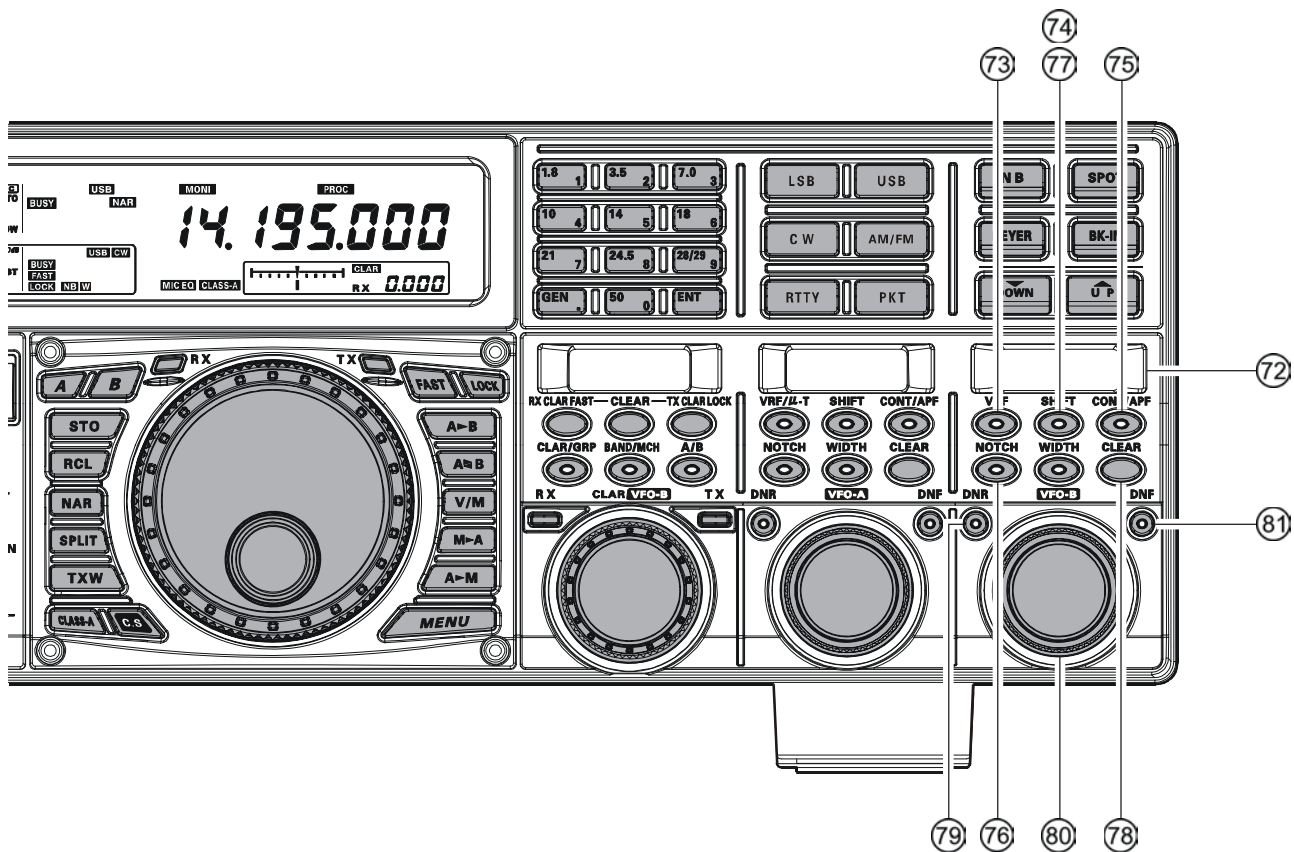

72 SUB DISPLAY-III

This LCD display shows the character of the VFO-B receiver's DSP function selected by the five buttons located below of this display, and the **(VFO-B)[SELECT]** knob located below this window works as an adjustment knob that displayed to this window. Furthermore, when the Menu Mode is activated, this LCD display indicates the current setting.

73 (VFO-B)[VRF] Switch

This button turns the VFO-B receiver's contour filter "on" and "off", and allows you to adjust the center frequency of the VRF filter by the **(VFO-B)[SELECT]** knob. While activated, the orange imbedded LED in this button will light up, and the "VRF" icon will appear in the FLT column of the Block Diagram Display on the display.

74 (VFO-B)[SHIFT] Switch

Pressing this button allows you to move the IF DSP bandwidth of VFO-B "higher" or "lower" by the **(VFO-B)[SELECT]** knob. When the IF passband is shifted, the orange LED imbedded in this button will light up. To the contrary, when the IF passband is just centered, the red LED imbedded in this button turns off.

75 (VFO-B)[CONT/APF] Switch

In the SSB, AM, and FM modes, this button turns the VFO-B receiver's contour filter "on" and "off", and allows you to adjust the center frequency of the contour filter by the **(VFO-B)[SELECT]** knob. When the contour filter is activated, the orange imbedded LED in this button will light up.

In the CW mode, this button turns the VFO-B receiver's APF (Audio Peak Filter) "on" and "off", and allows you to adjust the bandwidth of the APF filter by the **(VFO-B)[SELECT]** knob. When the APF filter is activated, the orange imbedded LED in this button will light up.

76 (VFO-B)[NOTCH] Switch

This button turns the VFO-B receiver's IF notch filter "on" and "off", and allows you to adjust the center frequency of the notch filter by the **(VFO-B)[SELECT]** knob. When the notch filter is activated, the orange imbedded LED in this button will light up.

77 (VFO-B)[WIDTH] Switch

Pressing this button allows you to adjust the overall bandwidth of the VFO-B receiver's IF DSP filter by the **(VFO-B)[SELECT]** knob. When the bandwidth is set to different than the factory default, the orange imbedded LED in this button will light up. To the contrary, when the bandwidth is set to default, the orange imbedded LED in this button turns off.

FRONT PANEL CONTROLS & SWITCHES

78 (VFO-B)[CLEAR] Switch

Pressing this button will reset to factory default the function, which are selected with five buttons located at the upper left of this button.

79 (VFO-B)[DNR] Knob

This button toggles the VFO-B receiver's Digital Noise Reduction circuit "on" and "off", and allows you to adjust the noise reduction level by the (VFO-B)[SELECT] knob. When the Digital Noise Reduction is activated, the orange LED imbedded with in this button will light up.

80 (VFO-B)[SELECT] Knob

This knob is used to adjust status of the functions selected by the five buttons located above the knob.

81 (VFO-A)[DNF] Switch

This button toggles the VFO-A receiver's Digital Notch Filter "on" and "off". When the Digital Notch Filter is activated, the orange LED imbedded in this button will light up. This is an automatic circuit, and there is no adjustment knob for the DNF.

DISPLAY INDICATIONS (LEFT SIDE)

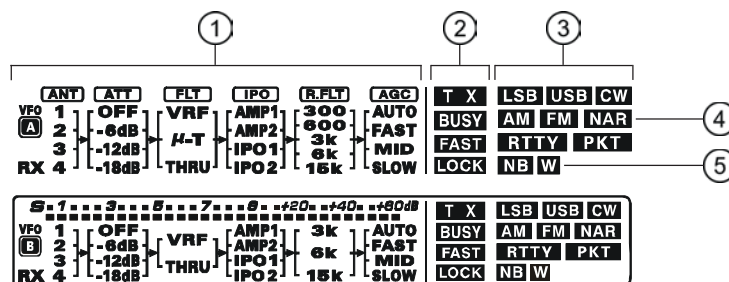

① (VFO-A) Block Diagram Display

ANT (1, 2, 3, 4, RX):

Indicates the antenna selected for operation by the front panel [ANT 1-4] and [RX ANT] switches.

ATT (OFF, -6 dB, -12 dB, -18 dB):

Indicates the attenuation level selected for operation by the front panel [ATT] button.

FLT (VRF, μ -TUNE, THRU):

Indicates the RF filter selected for operation by the front panel (VFO-A)[VRF/ μ -T] button.

ADVICE:

The μ -TUNE filter is an option. The " μ -TUNE" icon will not appear when the optional μ -TUNE unit is not connected.

IPO (AMP1, AMP2, IPO1, IPO2):

Indicates the front end RF amplifier selected for operation by the front panel [IPO] button.

R.FLT (300, 600, 3k, 6k, 15k):

Indicates the 1st IF Roofing Filter selected for operation by the front panel [R.FLT] button.

ADVICE:

The 300 Hz Roofing Filter is an option except the MP version. The "300" icon will not appear when the optional 300 Hz Roofing Filter is not installed.

AGC (AUTO, FAST, MID, SLOW):

Indicates the AGC decay time selected for operation by the front panel [AGC] switch.

② (VFO-A) Status Indicator

T X :

This indicator appears during transmission on the VFO-A frequency.

BUSY :

This indicator appears whenever the VFO-A receiver squelch is open. If this indicator is not showing, and reception seems to have been lost on the VFO-A receiver for no apparent reason, check the position of the (VFO-A)[SQL] knob and rotate it fully counter-clockwise to restore reception.

FAST :

This indicator appears when the Main Tuning Dial knob's tuning rate is selected to fast.

LOCK :

This indicator appears when the Main Tuning Dial knob is locked.

③ LSB, USB, CW, AM, FM, RTTY, PKT

Displays the currently-selected operating mode for the VFO-A.

④ NAR

This indicator appears whenever the VFO-A receiver's narrow IF DSP filter is engaged.

⑤ NB W

The "NB" icon appears when the VFO-A receiver's (short duration) Noise Blanker is activated.

The "NB W" icon appears when the VFO-A receiver's (longer-pulse) Noise Blanker is activated.

DISPLAY INDICATIONS (LEFT SIDE)

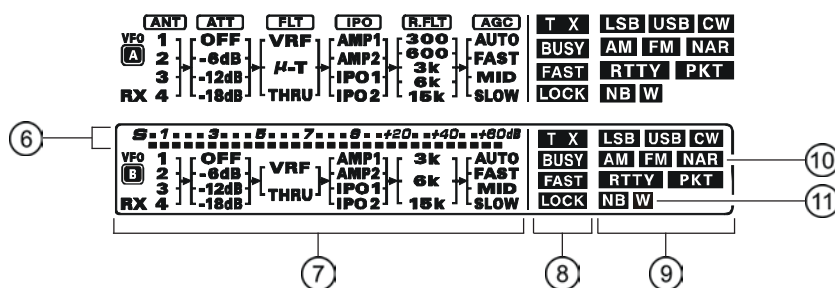

⑥ (VFO-B) Block Diagram Display

ANT (1, 2, 3, 4, RX):

Indicates the antenna selected for operation by the front panel [ANT 1-4] and [RX ANT] switches.

ATT (OFF, -6 dB, -12 dB, -18 dB):

Indicates the attenuation level selected for operation by the front panel [ATT] button.

FLT (VRF, THRU):

Indicates the RF filter selected for operation by the front panel (VFO-A)[VRF] button.

ADVICE:

The μ -TUNE filter is an option. The “ μ -TUNE” icon will not appear when the optional μ -TUNE unit is not connected.

IPO (AMP1, AMP2, IPO1, IPO2):

Indicates the front end RF amplifier selected for operation by the front panel [IPO] button.

R.FLT (3k, 6k, 15k):

Indicates the 1st IF Roofing Filter selected for operation by the front panel [R.FLT] button.

AGC (AUTO, FAST, MID, SLOW):

Indicates the AGC decay time selected for operation by the front panel [AGC] switch.

This indicator appears whenever the Digital Noise Reduction feature is activated.

⑦ (VFO-B) Receiver S-Meter

Displays the strength of signals received on the VFO-B.

⑧ (VFO-B) Status Indicator

T X:

This indicator appears during transmission on the VFO-B frequency.

BUSY:

This indicator appears whenever the VFO-B receiver squelch is open. If this indicator is not showing, and reception seems to have been lost on the VFO-B receiver for no apparent reason, check the position of the (VFO-B)[SQL] knob and rotate it fully counter-clockwise to restore reception.

FAST:

This indicator appears when the [CLAR(VFO-B)] knob's tuning rate is selected to fast.

LOCK:

This indicator appears when the [CLAR(VFO-B)] knob is locked.

⑨ LSB, USB, CW, AM, FM, RTTY, PKT

Displays the currently-selected operating mode for the VFO-B.

⑩ NAR

This indicator appears whenever the VFO-B receiver's narrow IF DSP filter is engaged.

⑪ NB W

The “NB” icon appears when the VFO-B receiver's (short duration) Noise Blanker is activated.

The “NB W” icon appears when the VFO-B receiver's (longer-pulse) Noise Blanker is activated.

DISPLAY INDICATIONS (RIGHT SIDE)

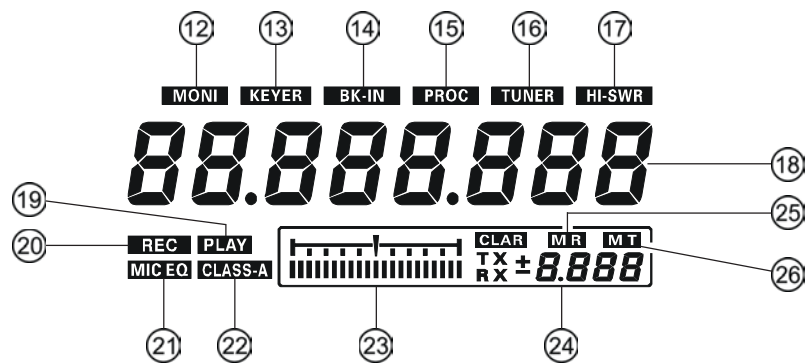

12 MONI

This indicator appears whenever the transmit monitor circuit is activated.

13 KEYER

This indicator appears whenever the internal CW keyer is activated.

14 BK-IN

This indicator appears whenever CW break-in operation is activated.

15 PROC

This indicator appears whenever the DSP Speech Processor is activated.

16 TUNER

This indicator appears when the internal Automatic Antenna Tuner is activated.

17 HI-SWR

This indicator appears if the directional coupler and microprocessor detect an abnormally high SWR condition (over 3.0:1) that cannot be resolved by the Automatic Antenna Tuner.

NOTE:

If this indicator appears, check to be sure that you have the correct antenna selected on the current operating band. If so, you will need to check the condition of the antenna, its coaxial cable, and/or the connectors on the cable so as to locate and correct the fault.

18 VFO-A Frequency Display

This is the VFO-A frequency display.

19 PLAY

This indicator appears while the voice recorder is playing back the recorded audio, and/or the memory is playing back the recorded CW or voice message.

20 REC

This indicator appears while the voice recorder is recording the receiver audio, and/or the memory is recording your CW or voice message.

21 MICEQ

This indicator appears whenever the Three-Band Parametric Microphone Equalizer is activated via the Menu.

22 CLASS-A

This indicator appears when Class-A operation is engaged.

23 Tuning Offset Indicator

This is a tuning scale that, as configured from the factory, provides a visual CW tuning indication of the incoming signal's offset from your transceiver's CW carrier frequency, as programmed by the relative clarifier offset, or the peak position of the VRF/ μ -TUNE filter.

24 CLAR

This indicator appears whenever the Clarifier function is activated.

25 MR

This indicator appears when the transceiver is in the Memory Recall mode.

26 MT

This indicator appears when the transceiver is in the Memory Tune mode to indicate that the memory contents have been temporarily changed.

REAR PANEL CONNECTIONS

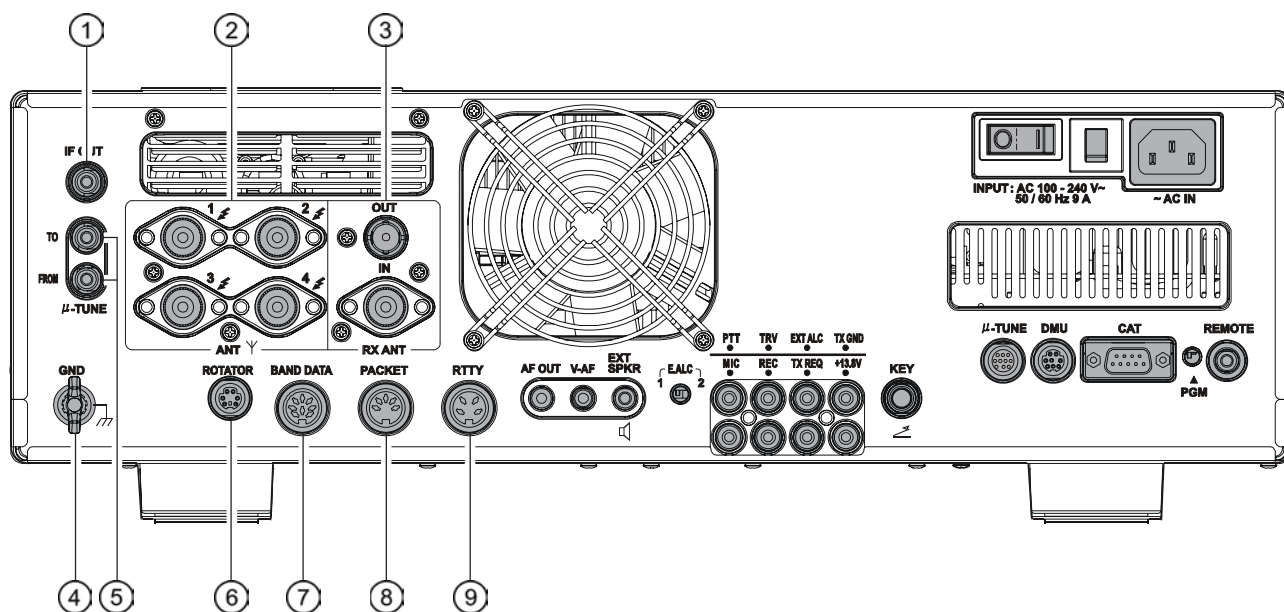

① IF OUT Jacks

This RCA output jack is used for connection to the optional **SM-5000** Station Monitor.

② ANT 1, 2, 3, 4 Jacks

Connect your main antenna(s) here, using a type-M (PL-259) plug and coaxial feedline for each. These antenna ports are always used for transmission, and also are used for reception unless a separate receive antenna is also used for the receiver. The internal antenna tuner affects only the antenna(s) connected here, and only during transmission.

③ RX ANT IN Jack

The BNC jack provides output of the receiver signal lines from the Antenna jacks which are connected to “RX” side of the transceiver’s main T/R switching circuitry.

The type-M jack is for a separate receive-only antenna. An antenna connected here can be used when the [RX ANT] button on the front panel is pressed.

If you want to use some special kind of external bandpass filter or preamplifier, you may connect it between the “RX ANT OUT” and “RX ANT IN” jacks.

④ GND

Use this terminal to connect the transceiver to a good earth ground, for safety and optimum performance. Use a large diameter, short braided cable for making ground connections, and please refer to page 9 for other notes about proper grounding.

⑤ μ-TUNE Jacks

These jacks are used for signal input/output of the optional RF μ Tuning Kit.

⑥ ROTATOR Jack

This 6-pin MINI-DIN Jack accepts a cable connected to a YAESU **G-800DXA/-1000DXA/-2800DXA** Antenna Rotator (listed models are current as of early 2010). You may control the antenna azimuth rotation (and rotation speed) using the Function buttons on the front panel.

⑦ BAND DATA Jack

This 8-pin output jack provides band selection data which may be used for control of optional accessories such as the **VL-1000** Solid-state Linear Amplifier.

⑧ PACKET Jack

This 5-pin input/output jack provides receiver audio and squelch signals, and accepts transmit (AFSK) audio and PTT control, from an external Packet TNC. Pinout is shown on page 15. The receiver audio level at this jack is approximately 100 mVp-p (@600 Ohms).

⑨ RTTY Jack

This 4-pin input/output jack provides connections for an RTTY terminal unit. Pinout is shown on page 15. The receiver audio level at this jack is at a constant 100-mV (@600 Ohms) level. FSK keying at this jack is accomplished by a closure of the SHIFT line to ground by the terminal unit.

REAR PANEL CONNECTIONS

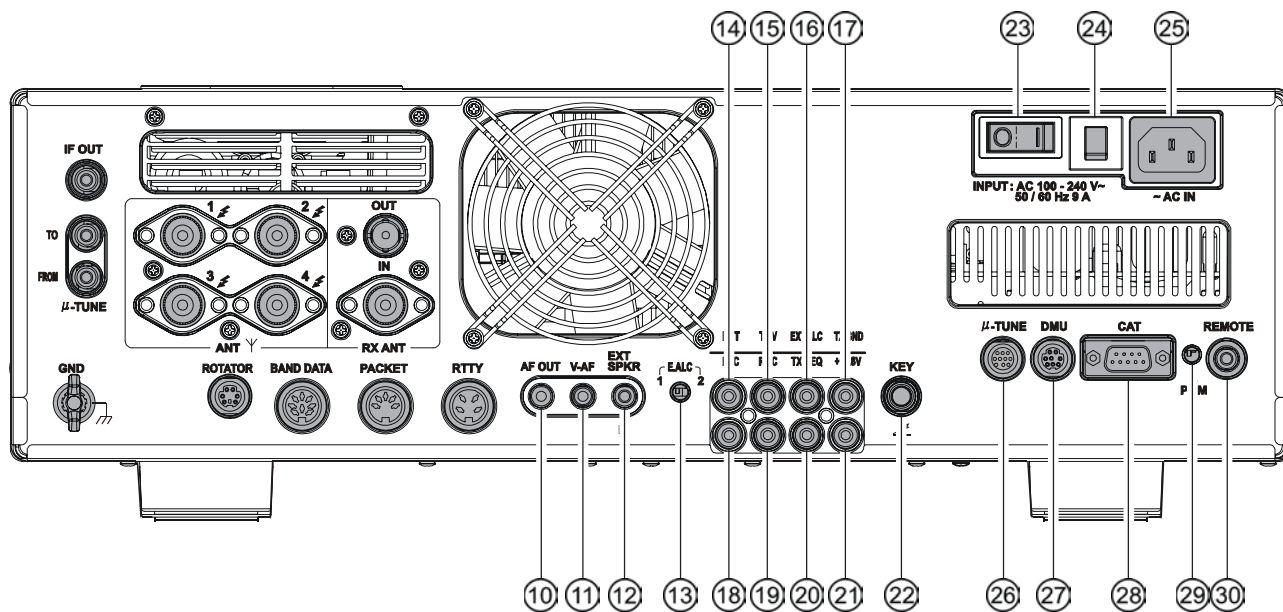

⑩ AF OUT Jack

This 3.5-mm, 3-contact jack provides dual-channel low-level receiver output, for recording or external amplification. Peak signal level is 300 mVp-p at 10 k-Ohms. The VFO-A receiver audio is on the left channel (tip), and the VFO-B receiver audio is on the right channel (ring). A stereo amplifier or recorder is recommended, to record each receiver's audio separately when dual reception is enabled (audio from either receiver, or both, may be used via this jack). The front panel [AF GAIN] knobs do not affect the signals at this jack.

⑪ V-AF Jack

This 3.5-mm, 3-contact jack is used for connection to the optional **SM-5000** Station Monitor.

⑫ EXT SPKR Jack

This 3.5-mm, 2-contact jack provides receiving audio output from the VFO-A and VFO-B receivers for an external loudspeaker or speakers, such as the **SP-2000**. Inserting a plug into this jack disables the internal loudspeaker. Impedance is 4 ~ 8 Ohms.

⑬ E.ALC Switch

This slide switch is used for selecting the recovery time of the ALC.. Set this switch to "1" position when this transceiver connects to the optional **VL-1000** Solid-state Linear Amplifier.

⑭ PTT Jack

This RCA input jack may be used to provide manual transmitter activation using a footswitch or other switching device. Its function is identical to the [MOX] button on the front panel. The same line is available at the **PACKET** and **RTTY** jacks for TNC control. Open-circuit voltage is +13.5 VDC, and closed-circuit current is 5 mA.

⑮ TRV Jack

This RCA jack provides a low level RF output for use with a transverter. Maximum output is approximately -10 dBm (0.1 mW) at 50 Ohms.

⑯ EXT ALC Jack

This RCA input jack accepts negative-going external ALC (Automatic Level Control) voltage from a linear amplifier, to prevent over-excitation by the transceiver. Acceptable input voltage range is 0 to -4 VDC.

⑰ TX GND Jack

This RCA jack's center pin is closed to ground while the transceiver's transmitter is engaged. It may be used for control of a peripheral device, most typically a linear amplifier. To enable this jack, please set Menu item "146 tGEn ETX-GND" to the "EnA" (Enable) selection.

The relay circuit of this transceiver used for this jack is capable of switching AC voltage of 100 Volts at up to 300 mA, or DC voltages or 60 V at 200 mA or 30 V at up to 1 Amp.

⑱ MIC (PATCH) Jack

This RCA input jack accepts transmitter audio - either AFSK or voice - for transmission. This line is mixed with the microphone audio input line, so the microphone should be disconnected if using this jack and mixing is not desired. The optimum impedance is 500 ~ 600 Ohms, and the nominal input level should be 5 mV.

⑲ REC Jack

This RCA jack provides low-level receiver audio output and transmit (monitor) audio (requires the [MONI] button is turned on), for recording or external amplification. Peak signal level is 30 mVp-p at 10 k-Ohms.

⑳ TX REQ Jack

When this RCA jack shorted to ground, it puts the transceiver into the transmit mode, and sends out a steady CW carrier, for linear amplifier or manual antenna tuner adjustment.

㉑ +13.8 V Jack

This RCA output jack provides regulated, separately fused 13.8 VDC at up to 200 mA, to power an external device such as a packet TNC. Make sure your device does not require more current (if it does, use a separate power source).

㉒ KEY Jack

This 1/4-inch phone jack accepts a CW key or keyer paddle. A 2-contact plug cannot be used in this jack. Key-up voltage is +5 V, and key-down current is 1 mA. Plug wiring is shown on page 15, and this jack may be configured for keyer, "Bug," "straight key," or computer keying interface operation via Menu item "056 A1A R-TYPE."

㉓ Main Power Switch

This is main power "on" (I)/"off" (O) switch of the transceiver. Always turn this switch on before turning on the front panel's [POWER] button. If this switch is not turned "on", the front panel [POWER] switch will not function.

㉔ Circuit Breaker Switch

This circuit breaker shuts off in the event of dangerously high current consumption by the transceiver.

ADVICE:

If the Circuit Breaker interrupts power, by all means try to determine the cause of the over-current condition before re-applying power. To restore the Circuit Breaker after verifying that all is normal, push this switch in until you hear a "click."

㉕ ~AC IN Jack

Connect the supplied 3-wire AC line cord to this socket. AC voltages of 100-240 V may be accommodated by the transceiver any sort of modification (universal voltage input).

㉖ μ-TUNE Jack

This 10-pin MINI-DIN jack used for control of the optional RF μTuning Kit.

㉗ DMU Jack

This 8-pin MINI-DIN jack accepts a cable connected to an optional **DMU-2000** Data Management Unit.

㉘ CAT Jack

This 9-pin serial DB-9 jack allows external computer control of the transceiver. Connect a serial cable here and to the RS-232C COM port on your personal computer (no external interface is required).

㉙ PGM (PROGRAM) Switch

This slide switch is used for updating the transceiver's firmware. The update software and instructions are available for download from the Vertex Standard website (<http://www.yaesu.com/>).

㉚ REMOTE Jack

By plugging in the supplied **FH-2** Remote Control Keypad to this jack, direct access to the CPU of the transceiver is provided for control functions such as audio playback feature, contest memory keying, plus frequency and function control.

FH-2 SWITCHES

The supplied Remote Control Keypad “**FH-2**” can be used to control the voice memory capability for the SSB/AM/FM modes, and the contest memory keyer for the CW mode. You can also play-back up to 15 seconds of incoming received audio, as well, for verification of a missed call sign or other purposes. Among the specific capabilities of the **FH-2** are:

- On SSB/AM/FM modes, five channels of storage and playback of voice memory (20 seconds each), using your own voice for recording (see page ???).
- On CW mode, the **FH-2** provides storage and recall of CW messages for repetitive CQ and contest number transmissions (see page ???).
- Play-back of the last 15 seconds of incoming receiver audio (see page ???).

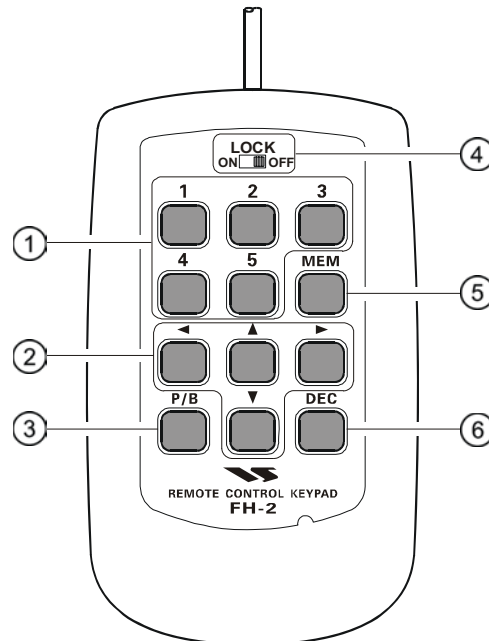

① [1], [2], [3], [4], [5] Switches

These buttons work as the Voice Memory and CW Message Memory Selection Key.

In the case of Voice Memory, up to 20 seconds of audio may be stored on each channel.

For CW Messages and CW Text Messages, up to 50 characters (“PARIS” specification) may be stored into each channel.

② [◀], [▶], [▲], [▼] Switches

These buttons are used for navigation when selecting text characters for the programming of Contest and Text memories.

③ [P/B] Switch

This button is used for playing back the last 15 seconds of recorded receiver audio.

④ [LOCK] Switch

This button may be used to lock out the **FH-2**'s keys, to prevent accidental activation of **FH-2** operation.

⑥ [MEM] Switch

This button is pressed for the purpose of storing either a Voice Memory or a Contest Keyer Memory channel's contents.

⑦ [DEC] Switch

When utilizing the sequential contest number capability of the Contest Keyer, press this button to decrement (back up) the current Contest Number by one digit (i.e. to back up from #198 to #197, etc.).

BASIC OPERATION: RECEIVING ON AMATEUR BANDS

Before turning on main power, please verify the following items once more.

- Have you made all ground connections securely? See page 9 for details.
- Do you have your antenna(s) connected to the rear-panel Antenna jack(s)? See page 35 for details.
- Is your microphone (and/or key or paddle) connected? See pages 16 and 34 for details.
- If using a linear amplifier, have all interconnections been successfully completed? See pages 33 and 34 for details.
- Please rotate both [**AF GAIN**] controls to their fully counter-clockwise positions, to avoid a loud blast of audio when the transceiver turns on. See page 20 for details.
- Rotate the [**RF PWR**] control fully counter-clockwise, to set minimum power at first. See page 20 for details.
- If your AC mains power should suffer a significant fluctuation or interruption, we recommend that you go through a complete power-up cycle, in order to ensure that all circuits are properly initialized. To do this, be sure the front panel [**POWER**] switch is turned off, then set the rear panel main power switch to the “**O**” position. Now unplug the AC cable from the rear panel, and wait ten seconds before proceeding with the start-up procedure described on next page.

BASIC OPERATION: RECEIVING ON AMATEUR BANDS

Here is the typical start-up procedure for normal operation:

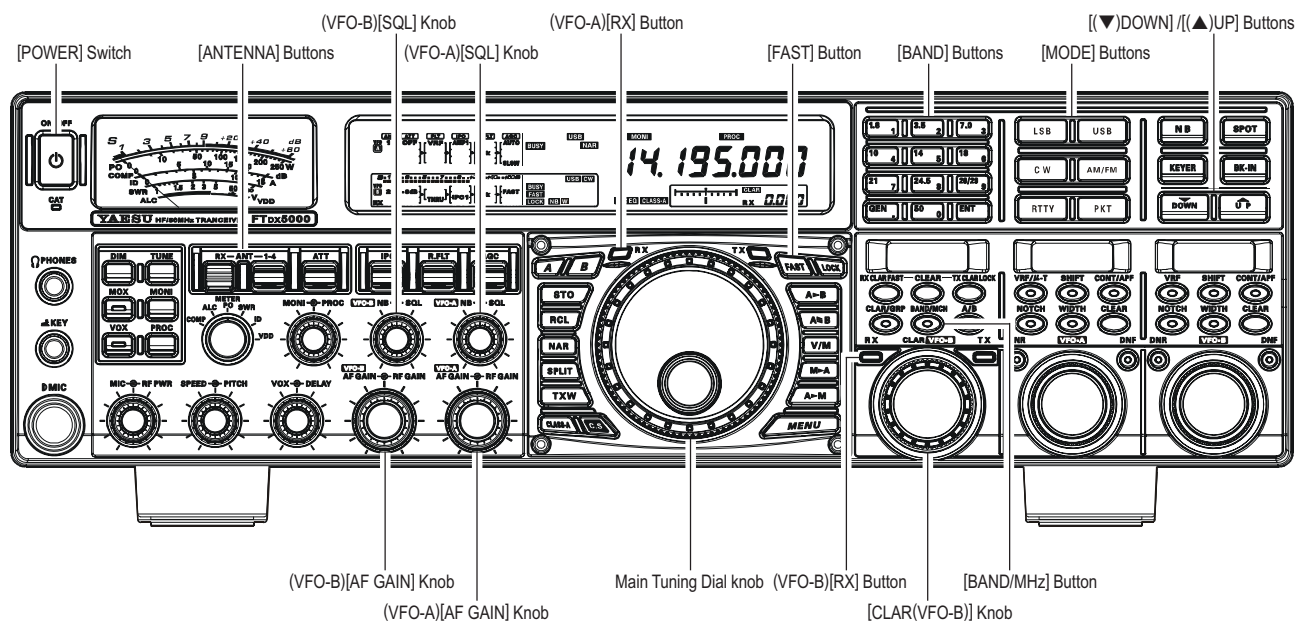

1. Plug the AC cable back in, set the rear panel main power switch to "I" position.
2. Press and hold in the front panel [POWER] switch for one second to turn the transceiver on.
3. The transceiver will start up on 7.000.00 MHz LSB, and normal operation may begin.

NOTE:

To turn power off, press and hold in the front panel [POWER] switch for one second.

4. Rotate the (VFO-A)[AF GAIN] knob to set a comfortable audio level on incoming signals or noise. Clockwise rotation of the (VFO-A)[AF GAIN] knob increases the volume level.

NOTE:

When using headphones, start by rotating the (VFO-A)[AF GAIN] knob counter-clockwise, then bring the volume level up after you put the headphones on. This will minimize the chance of damage to your hearing caused by an unexpectedly-high audio level.

5. Press the (VFO-A)[RX] button to engage the VFO-A receiver; the imbedded LED will glow green.

ADVICE:

- If you press the (VFO-A)[RX] button when the imbedded LED is already glowing green, the LED will now blink; this indicates that the VFO-A receiver is temporarily muted. Just press the (VFO-A) [RX] button once more to restore VFO-A receiver operation.

- Press the (VFO-B)[RX] button to engage Dual Reception (using the VFO-B receiver in addition to the VFO-A receiver). When you press the (VFO-B)[RX] button, its imbedded LED will glow green; pressing this button once more will turn off the VFO-B receiver, and the imbedded LED will go dark. Use the VFO-B receiver's (VFO-B)[AF GAIN] knob to adjust the VFO-B receiver volume level.

6. Press the [BAND] button corresponding to the Amateur band on which you wish to begin operation.

ADVICE:

- One-touch selection of each Amateur band between 1.8 and 50 MHz is provided.
- The FTdx5000 utilizes a triple band-stack VFO selection technique, which permits you to store up to three favorite frequencies and modes onto each band's VFO register. For example, you may store one frequency each on 14 MHz CW, RTTY, and USB, then recall these VFOs by successive, momentary presses of the [14] MHz band button. Each Amateur band button may similarly have up to three frequency/mode settings applied.



BASIC OPERATION: RECEIVING ON AMATEUR BANDS

- If you press the [BAND/MCH] button briefly, the imbedded LED of the [BAND/MCH] button glows red, and the [CLAR(VFO-B)] knob may be used as a band selection knob.

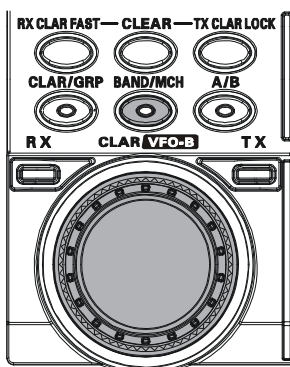

- Press the [▼(DOWN)]/[▲(UP)] buttons to tune the VFO-A frequency in 1 MHz step.



ADVICE!

You may change the tuning step to 100 kHz via the Menu item “140 TUN MHz SEL”. See page 127.

- Move the [ANT 1-4] button up and down to select the appropriate antenna for the band in use; alternatively, if one is connected, you may also press the [RX ANT] button. Up to four TX/RX antennas may be connected, or one RX-only antenna.



ADVICE!

Once you have made your antenna selection, that antenna is “remembered” by the microprocessor in conjunction with the VFO register (frequency and mode) in use when you chose that particular antenna.

- Press the appropriate [MODE] button to select the desired operating mode.

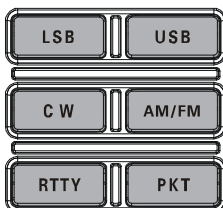

ADVICE!

- By convention in the Amateur bands, LSB is used on the 7 MHz and lower bands (with the exception of 60 meters), while USB is utilized on the 14 MHz and higher bands.
- When changing modes from SSB to CW, you will observe a frequency shift on the display. This shift represents the BFO offset between the “zero beat” frequency and the audible CW pitch (tone) you can hear (the pitch is programmed by the [PITCH] knob), even though the actual tone that you hear is not changing. If you do not want this frequency shift to appear when changing modes from (for example) USB to CW, use the Menu item “063 A1A FRQDISP,” described on page 122.

- When operating on the FM mode in the VFO-A, rotate the (VFO-A)[SQL] (Squelch) knob clockwise just to the point where the background noise is just silenced. This is the point of maximum sensitivity to weak signals. Excessive advancement of the Squelch knob will degrade the ability of the receiver to detect weak signals. Adjustment of the VFO-B Squelch is accomplished using the (VFO-B)[SQL] knob.

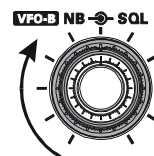
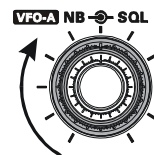

- Rotate the Main Tuning Dial knob to tune around the band, and begin normal operation.

ADVICE!

- Clockwise rotation of the Main Tuning Dial knob increases the operating frequency, one “step” of the synthesizer at a time; similarly, counter-clockwise rotation of the Main Tuning Dial knob will decrease the frequency.

Two steps, one “normal” and one “fast,” are available on each operating mode. Pressing the [FAST] button engages the “Fast” tuning selection.

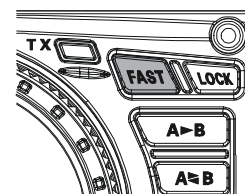

OPERATING MODE	1 STEP	1 DIAL ROTATION
LSB, USB, CW, RTTY, PKT(LSB)	10Hz [100Hz]	10kHz [100kHz]
AM, FM, PKT(FM)	100Hz [1kHz]	100kHz [1MHz]

[] : [FAST] switch set to “ON”

- It is possible to separate the frequency change over one dial rotation, only while operating solely on the CW mode, using the Menu items “138 TUN DIAL STP”, and “139 TUN CW FINE”. See page 127.
- If you want to navigate quickly, so as to effect rapid frequency change, there are several techniques available:
 - Direct keyboard entry of the frequency (see page 49).
 - Use the microphone’s [UP]/[DWN] scanning keys, if your microphone is so equipped (see page 49).

BASIC OPERATION: RECEIVING ON AMATEUR BANDS

CLAR (CLARIFIER) OPERATION ON VFO-A

The [RX CLAR/FAST], [CLEAR], [TX CLAR/LOCK] buttons and [CLAR(VFO-B)] knob are used to offset either the receive, transmit, or both frequencies from their settings on the VFO-A frequency (the Clarifier does not affect the VFO-B, however). The four small numbers on the LCD display show the current Clarifier offset. The Clarifier controls on the **FTDX5000** are designed to allow you to preset an offset (up to ± 9.999 kHz; frequency step depends on the Main Tuning Dial knob) without actually retuning, and then to activate it via the Clarifier's [RX CLAR/FAST] and [TX CLAR/LOCK] buttons. This feature is ideal for following a drifting station, or for setting small frequency offsets sometimes utilized in DX "Split" work.

Here is the technique for utilizing the Clarifier:

1. Press the [RX CLAR/FAST] button. The "CLAR" and "RX" icon will appear in the display, and the programmed offset will be applied to the receive frequency.

CLAR
RX 0.000

ADVICE!

If the "CLAR" and "RX" icon does not appear, check to see if the LED imbedded in the [A/B] button glows orange. If so, pressing the [A/B] button will cause the LED imbedded in the [A/B] button to go out. Now, press the [RX CLAR/FAST] button to begin clarifier operation.

2. Rotation of the [CLAR(VFO-B)] knob will allow you to modify your initial offset on the fly. Offsets of up to ± 9.999 kHz may be set using the Clarifier.

CLAR
RX -9.999

To cancel Clarifier operation, press the [RX CLAR/FAST] button. The "CLAR" and "RX" icon will disappear from the display.

ADVICE!

Turning the clarifier "off" simply cancels the application of the programmed offset from the receive and/or transmit frequencies. To clear out the programmed clarifier offset altogether, and reset it to "zero," press the [CLEAR] button.

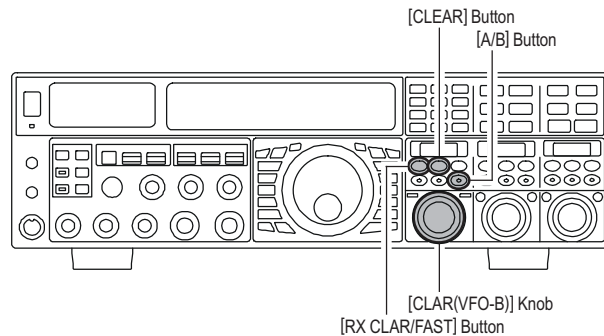

TX CLAR

Without changing the receive frequency, you may alternatively apply the Clarifier offset to the transmit frequency (typically, for "split" DX pile-ups). See page 79 for details.

The Tuning Offset Indicator provides a graphical representation of the Clarifier offset.

On CW mode, the Tuning Offset Indicator is used for CW Center Tuning, instead of Clarifier Offset, as the transceiver is configured at the factory. If you wish to change this, so that the Clarifier Offset is also displayed on CW, use the following procedure:

1. Press the [MENU] button to enter the Menu mode.
2. Rotate the (VFO-A)[SELECT] knob to select Menu item "010 DISP BAR SEL".
3. Rotate the (VFO-B)[SELECT] knob to select "CLAR (Clarifier)" (replacing the default "CW TUNE (CW TUNING)" selection).

CLAR
RX +1.234

[Plus (+) Offset]

4. Press and hold in the [MENU] button for two seconds to save the new setting and exit to normal operation.

CLAR
RX 0.000

[Zero Offset]

CLAR
RX -1.234

[Minus (-) Offset]

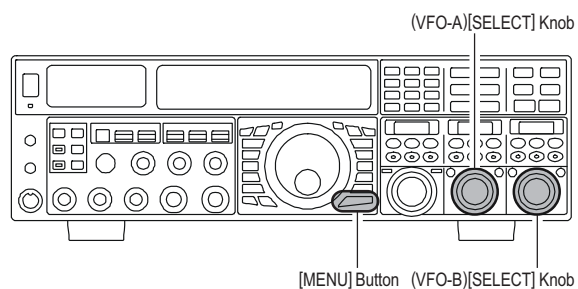

BASIC OPERATION: RECEIVING ON AMATEUR BANDS

LOCK

You may lock the setting of the Main Tuning Dial knob, to prevent accidental frequency change.

To lock out the Main Tuning Dial knob, just press the **[LOCK]** button that is located to the right of the Main Tuning Dial knob. To unlock the Dial setting, and restore normal tuning, just press the **[LOCK]** button once more.

When the Main Tuning Dial knob is “locked”, the blue **“LOCK”** icon will appear on the display.

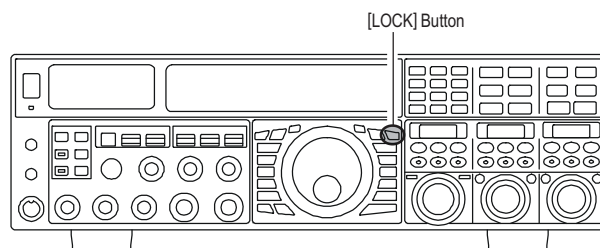

DIM

The illumination level of the analog meter and frequency display may be reduced, if you are using the transceiver in a dark environment where high brightness is not desired.

To reduce the illumination level, press the **[DIM]** button, located to the left of the analog meter. To restore full brightness, press the **[DIM]** button once more.

ADVICE:

You may also customize the amount of brightness reduction engaged by the pressing of the **[DIM]** button, and may use different brightness levels for different front panel areas. Menu item **“008 DISP DIM MTR”** adjusts the brightness level of the analog meter; while menu item **“009 DISP DIM VFD”** sets the brightness levels of the frequency display (these settings are effective only when the **[DIM]** button is pressed).

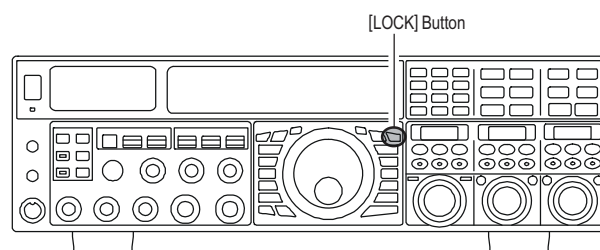

OPERATION ON 60-METER (5 MHz) BAND (U.S. VERSION ONLY)

The recently-released 60-meter band is covered, in the **FTDX5000**, by five special, fixed memory channels. These channels are set to USB, and they appear between the “last” PMS channel (**“P-9U”**) and the first “regular” memory channel (Channel 1).

To operate on the 60-meter (5 MHz) band:

1. Press the **[V/M]** button once, if necessary, to enter the “Memory” mode (the **“MR”** icon will appear on the display).
2. Press and hold in the **[BAND/MCH]** button for two seconds. The LED imbedded in the button will glow yellow to signify that rotation of the **[CLAR(VFO-B)]** knob will allow selection the memory channel.
3. Memory channels **“US-1”** through **“US-5”** are pre-programmed, at the factory, with the permitted frequencies in the 5 MHz band, and the USB mode is automatically selected on these channels.
4. To exit from 60-meter operation and return to the VFO mode, just press the **[V/M]** button.

NOTE:

The frequencies and operating mode for 5 MHz band operation are both fixed, and may not be changed.

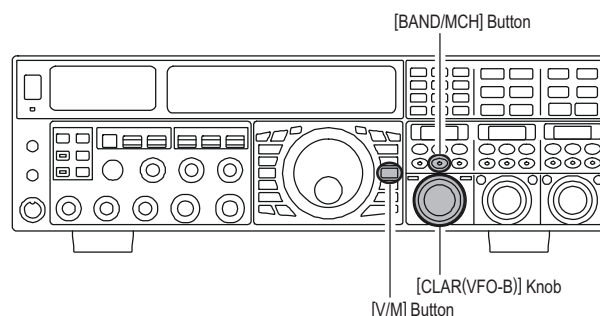

CHANNEL NUMBER	FREQUENCY
US-1	5.3320 MHz
US-2	5.3480 MHz
US-3	5.3680 MHz
US-4	5.3730 MHz
US-5	5.4050 MHz

CONVENIENCE FEATURES

DUAL RECEIVE

The **FTdx5000** is capable of simultaneous reception on the *same amateur band*, using the VFO-A and VFO-B receivers, in what is called the “Dual Receive” mode. Especially useful for DX work, here is the operating procedure for Dual Receive operation.

1. While receiving on the VFO-A, engage the VFO-B receiver by pressing the **(VFO-B)[RX]** button, located to the upper left of the **[CLAR(VFO-B)]** knob. You will now be receiving on the two frequencies shown on the LCD display (for VFO-A) and **SUB DISPLAY-I** (for VFO-B).
2. Adjusting the volume:
To adjust the VFO-A audio level, rotate the **(VFO-A)[AF GAIN]** knob. To adjust the VFO-B audio level, rotate the **(VFO-B)[AF GAIN]** knob. In both cases, clockwise rotation of the knob will increase the volume level.
3. Press the **[B]** button, located to the upper left of the Main Tuning Dial knob. An orange LED imbedded in the **[B]** button, and you may now change the operating mode of the VFO-B receiver by pressing the appropriate **[MODE]** selection button.
4. You may also press the **[BAND]** buttons to select the operating band on which you want to set up the VFO-B receiver.
5. To return the mode and band selections to VFO-A, press the **[A]** button, located to the left of the **[B]** button. A red LED imbedded in the **[A]** button, and you may now change the operating mode and band of the VFO-A receiver.
6. Rotate the Main Tuning Dial knob to adjust the Main VFO-A frequency, and rotate the **[CLAR(VFO-B)]** knob to adjust the VFO-B frequency.

ADVICE:

If the VFO-B frequency does not change, check to see if the orange LED imbedded in the **[A/B]** button does not light up. If so, pressing the **[A/B]** button will cause the LED imbedded in the **[A/B]** button glows orange. Now, rotate the **[CLAR(VFO-B)]** knob to begin to adjust the VFO-B frequency.

7. To cancel Dual Receive operation, and receive just on the VFO-A receiver, press the **(VFO-B)[RX]** button; the imbedded green LED will go out, and monoband operation on the VFO-A receiver will resume.

NOTE:

Please remember that, while the **[B]** button glows orange, any mode or band changes will still be applied to the VFO-B receiver, whether or not Dual Receive is engaged.

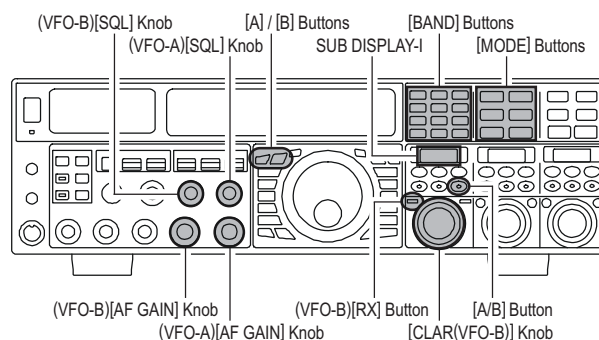

QUICK POINTS:

By convention in the amateur bands, LSB is used on the 7 MHz and lower bands (with the exception of 60 meters), while USB is utilized on the 14 MHz and higher bands.

ADVICE:

- When operating in Dual Receive, the manner in which the audio is fed to the left and right sides of your headphones (Stereo, Monaural, or Mixed) may be configured using Menu item “**104 ROUT HEADPHN**” (see page 124).
- When changing modes from SSB to CW, you will observe a frequency shift on the display. This shift represents the BFO offset between the “zero beat” frequency and the audible CW pitch (tone) you can hear (the pitch is programmed by the **[PITCH]** knob), even though the actual tone that you hear is not changing. If you do not want this frequency shift to appear when changing modes from (for example) USB to CW, use the Menu item “**062 A1A FRQ DISP**”, described on page 122.
- When operating on the FM mode on the VFO-B receiver, rotate the **(VFO-B)[SQL]** knob clockwise just to the point where the background noise is just silenced. This is the point of maximum sensitivity to weak signals. Excessive advancement of the **(VFO-B)[SQL]** knob will degrade the ability of the receiver to detect weak signals. Adjustment of the VFO-A squelch is accomplished using the **(VFO-A)[SQL]** knob.

DUAL RECEIVE

Using Headphones for Dual Receive

To take advantage of dual reception, you will want to connect stereo headphones to the **PHONES** jack. Like the **AF GAIN** control, headphone audio mixing can also be configured as desired from Menu item “**104 ROUT HEADPHN**”. Three audio mixing schemes are selectable as follows:

SEPARATE: Audio from the VFO-A receiver is heard only in the left ear, and VFO-B receiver audio solely in the right ear.

CONBINE1: Audio from both VFO-A and VFO-B receivers can be heard in both ears, but VFO-B audio is attenuated in the left ear and VFO-A audio is attenuated in the right ear.

CONBINE2: Audio from both VFO-A and VFO-B receivers are combined and heard equally in both ears (“Monaural” mode).

Sideband Diversity Reception

Here you receive a single AM signal through the two receivers, each receiving the opposite sideband. Skywave-propagated signals often show phase distortion in this mode, but it gives you a view of the entire passband, from which you can then select the best sideband for listening (or for SWL Dx’ing, you may want to listen to both sidebands at the same time, to get the best copy). On groundwave signals, where the phase of the sidebands is likely to be the same, there is an interesting sense of depth to the signal.

To tune in a signal using this mode, you should have stereo headphones connected to the front panel **PHONES** jack.

- Set the VFO-A to either LSB or USB mode, and tune for zero beat on the desired signal.
- Press the [**A►B**] button to copy this mode and frequency into the VFO-B, then press the [**MODE**] button to select the opposite sideband for the VFO-A.
- If using headphones, set the headphone mixing scheme to the “**CONBINE1**” mode via the Menu item “**104 ROUT HEADPHN**”, and activate dual reception.
- Adjust the [**AF GAIN**] knob(s) to balance the volume of the two receivers.
- If interference is present on one of the channels, you may have to turn its [**AF GAIN**] knob to suppress that channel (or press the green [**RX**] button to disable the receiver with the sideband experiencing interference). Otherwise, try changing the headphone audio mixing scheme to “**CONBINE2**” or “**SEPARATE**” in the Menu item “**104 ROUT HEADPHN**”, for different effects (or try settings with similar effects on your external amplifier). Although you don’t get the “stereophonic” effect in the monaural mode, the two signals are still mixed, offering the potential for much better copy than in regular AM or even single-sideband ECSS modes.

CONVENIENCE FEATURES

DUAL RECEIVE

Bandwidth Diversity Reception

This mode involves receiving the same signal through two different bandpass filters. The frequency and mode of both the VFO-A and VFO-B are the same. The VFO-A can be set up for a wide bandpass, using the [WIDTH] knobs, and the VFO-B for a narrow bandpass, resulting in a spatial perception of the channel. Although any mode (except FM) can be used, CW offers the widest array of choices, and perhaps the most startling effects on crowded channels.

Stereo headphones or an external stereo speaker are recommended for this mode. To set up the transceiver for bandwidth diversity reception:

- Select the desired mode on the VFO-A.
- Tune to the signal of interest.
- Press the [A►B] button to copy this mode and frequency into the VFO-B.
- If using headphones, set the headphone mixing scheme to the “**COMBINE1**” mode via the Menu item “**104 ROUT HEADPHN**”, and activate dual reception.
- Adjust the [AF GAIN] knob(s) to balance the volume of the two receivers.
- Now try manipulating the [SHIFT] and [WIDTH] knobs to observe the interesting effects of bandwidth diversity.

Polarity Diversity

Similar in concept to the bandwidth diversity capability just described, another interesting capability of the **FTdx5000** is the ability to use two different antennas on the same frequency, using dual reception. For example, you might have a horizontal Yagi on the main band, and a vertical antenna on the sub band, then lock the two frequencies together and engage dual reception.

Frequently, the fading observed on the HF bands is not so much a change in ionization level, but rather a shift in the polarization of the signal as it travels to and from the ionosphere. Having an opposite-polarization antenna available can fill in the signal during deep fades, and you may then transmit on whichever antenna is providing the strongest signal at the moment (see the discussion below on Split Frequency operation).

P.BACK (AUDIO PLAYBACK) FROM MAIN (VFO-A) RECEIVER

Once engaged by the operator, the **FTdx5000** begins the automatic recording of the last 15 seconds of incoming receiver audio on the VFO-A by plugging in the supplied **FH-2** Remote Control Keypad into the rear panel's **REMOTE** jack. This capability is especially useful for confirming a callsign that may have been difficult to copy due to noise or QRM, etc.

Recording

- ❑ Press and hold in the **FH-2**'s **[P/B]** key for two seconds to initiate recording. The "**REC**" icon will appear in the display to confirm that recording is in progress.
- ❑ Press the **FH-2**'s **[P/B]** key momentarily to halt recording; the "**REC**" icon will go out.

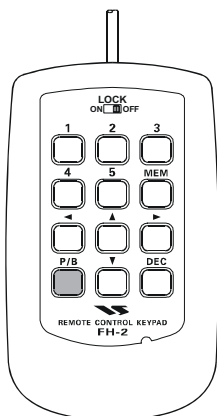

Playback

- ❑ Press the **FH-2**'s **[P/B]** key *briefly*, after recording has been halted, to begin playback of the recorded audio; the "**PLAY**" icon will appear in the display to confirm that playback is in progress. The last 15 seconds of audio will be heard in the speaker or headphones. If you do not intervene, the entire 15 seconds will be played back endlessly.
- ❑ To halt playback at any time, just press the **[P/B]** key briefly again. The next time you press the **[P/B]** key, it will pick up the playback where you left off.

ADVICE

You may adjust the playback level of the recording by the main **[AF GAIN]** knob.

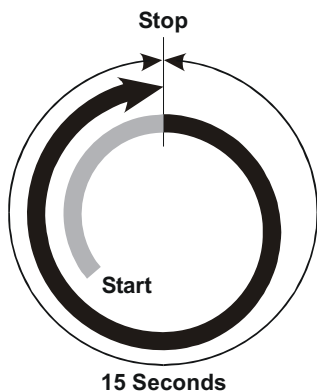

CONVENIENCE FEATURES

“MY BANDS” OPERATION

When operating on an amateur band, it is possible to use the [BAND] buttons to engage the use of the [CLAR(VFO-B)] knob for amateur band selection. The “My Bands” feature allows you to select several amateur bands, and make *only* those bands available for selection via the [CLAR(VFO-B)] knob.

This feature can be *very* useful in a contest, where the 10/18/24 MHz band are not used, or if you do not have antennas for some bands.

“My Bands” Setup

1. Press the [MENU] button to engage the Menu mode.
2. Rotate the (VFO-A)[SELECT] knob to select Menu item “144 TUN MY BAND.”
3. Rotate the (VFO-B)[SELECT] knob to choose a band that you wish to *skip* (omit) from the band-selection loop (when using the [CLAR(VFO-B)] knob for band selection). The available choices are 1.8M/3.5M/7M/10M/14M/18M/21M/24M/28M/50M/GEN(General Band)/T14M(Transverter “1”)/T28M(Transverter “2”)/T50M(Transverter “3”).
4. Press the [ENT] button (one of the [BAND] button) to set the selected band to “skipped”. The “ON” notation at the right of the band notation will change to “OFF”.
5. Repeat steps 3 and 4 to select (“ON”)/deselect (“OFF”) as many bands as you like.
6. Press and hold in the [MENU] button for two seconds to lock in the new configuration and exit to normal operation.

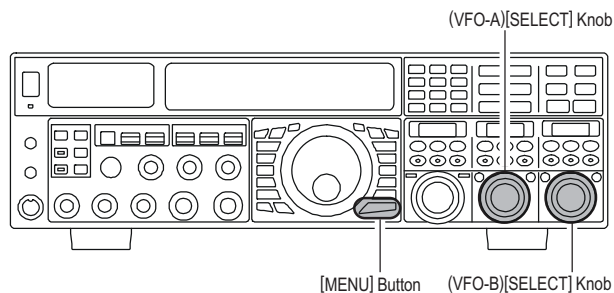

ADVICE:

The “My Band” feature affects *only* VFO-A band.

“My Band” Operation

1. Press the [V/M] button once, if necessary, to enter the “VFO” mode.
2. Press the [BAND/MCH] button briefly; the imbedded LED will glow Red.
3. Rotate the [CLAR(VFO-B)] knob knob to choose the amateur band on which you wish to operate. Only those amateur bands that have not been skipped will appear as you scroll through the bands.

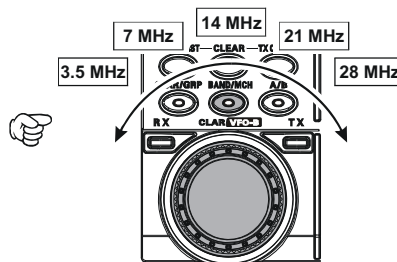
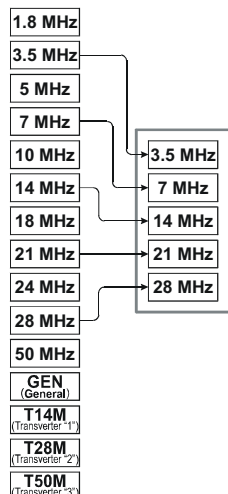
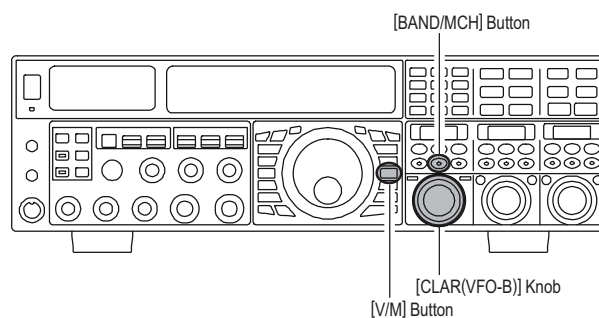

BAND STACK OPERATION

The **FTdx5000** utilizes a triple band-stack VFO selection technique, that permits you to store up to three favorite frequencies and modes onto each band's VFO register. For example, you may store one frequency each on 14 MHz CW, RTTY, and USB, then recall these VFOs by successive, momentary presses of the [**14**] MHz band button. Each Amateur band key may similarly have up to three frequency/mode settings applied. Both the VFO-A and VFO-B systems have their own, independent, band stacks.

A typical setup, for the 14 MHz band, might be arranged like this:

1. Program 14.025 MHz, CW Mode, then press the [**14**] MHz band button;
2. Program 14.080 MHz, RTTY Mode, then press the [**14**] MHz band button;
3. Program 14.195 MHz, SSB Mode, then press the [**14**] MHz band button.

With this configuration, successive momentary presses of the [**14**] MHz band button will allow you to toggle sequentially through these three VFOs.

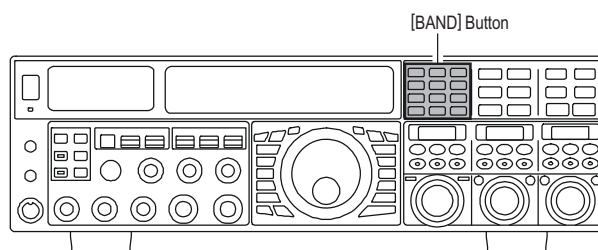

C.S (CUSTOM SWITCH)

An often-used Menu mode selection may be brought out to the front panel's [C.S] button.

C.S Setup

1. Press the [**MENU**] button to engage the Menu mode; the Menu list will appear on the **SUB DISPLAYS**.
2. Rotate the (**VFO-A**)[**SELECT**] knob to select the Menu item you want to be able to access via the [**C.S**] button.
3. Press and hold in the [**C.S**] button for two seconds to lock in your selection.
4. Press and hold in the [**MENU**] button for two seconds to save the new configuration and exit to normal operation.

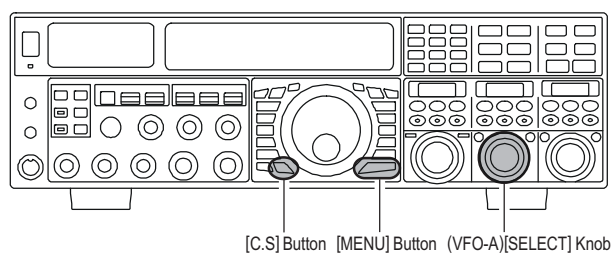

Menu Selection Recall via [C.S] button

1. Press the [**C.S**] button. The programmed Menu item will appear on the display.
2. You may now rotate the (**VFO-B**)[**SELECT**] knob to change the setting of this menu item.
3. Press the [**MENU**] button for two seconds, when you are done, to save the new configuration and exit to normal operation.

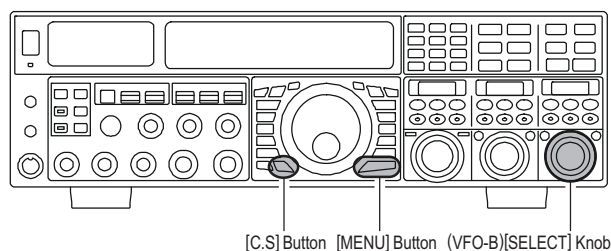

CONVENIENCE FEATURES

ROTATOR CONTROL FUNCTIONS

When using a YAESU model **G-800DXA**, **G-1000DXA**, or **G-2800DXA** rotator (not supplied), it is possible to control it from the front panel of the **FT-2000D**.

- 1 Press and hold in the **[ENT]** button (one of the **[BAND]** button) for two seconds. The **SUB DISPLAY**s will change over to the “Rotator Control” configuration.
- 2 Press either the **[3.5(2)]** button or the **[7.0(3)]** button to rotate the antenna. Pressing the **[3.5(2)]** button will cause rotation to the left (counter-clockwise), while pressing the **[7.0(3)]** button will cause rotation to the right (clockwise).
- 3 Press the **[14(5)]** button or the **[18(6)]** button to control the speed of rotation. Pressing the **[14(5)]** button will cause slower rotation, while pressing the **[18(6)]** button will speed up rotation. Usually, you will be using the “100%” setting.

When you are through exercising rotator control, press the **[ENT]** button briefly. The **SUB DISPLAY**s will return to the normal display.

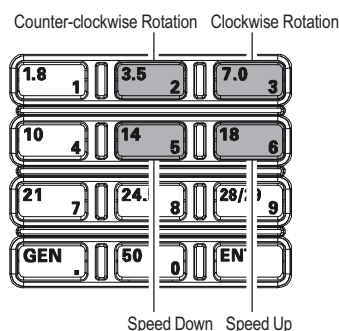
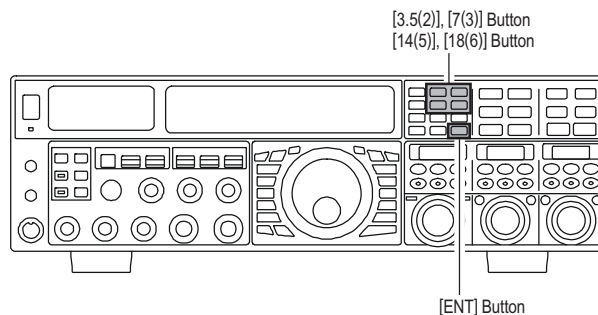

IMPORTANT NOTE

- ❑ Set to match the starting point of your rotator control indicator needle via the Menu item “**012 DISP RTR STU.**” The default setting is zero (north). If your controller starting point is south, the Menu item “**012 DISP RTR STU.**” must be set to “**180°.**” If not set properly the **FTdx5000** display will not show the correct direction.
- ❑ When the rotator control indicator needle does not indicate the precise antenna direction, adjusts the indicator needle precisely to the antenna direction via the Menu item “**013 DISP RTR ADJ.**”

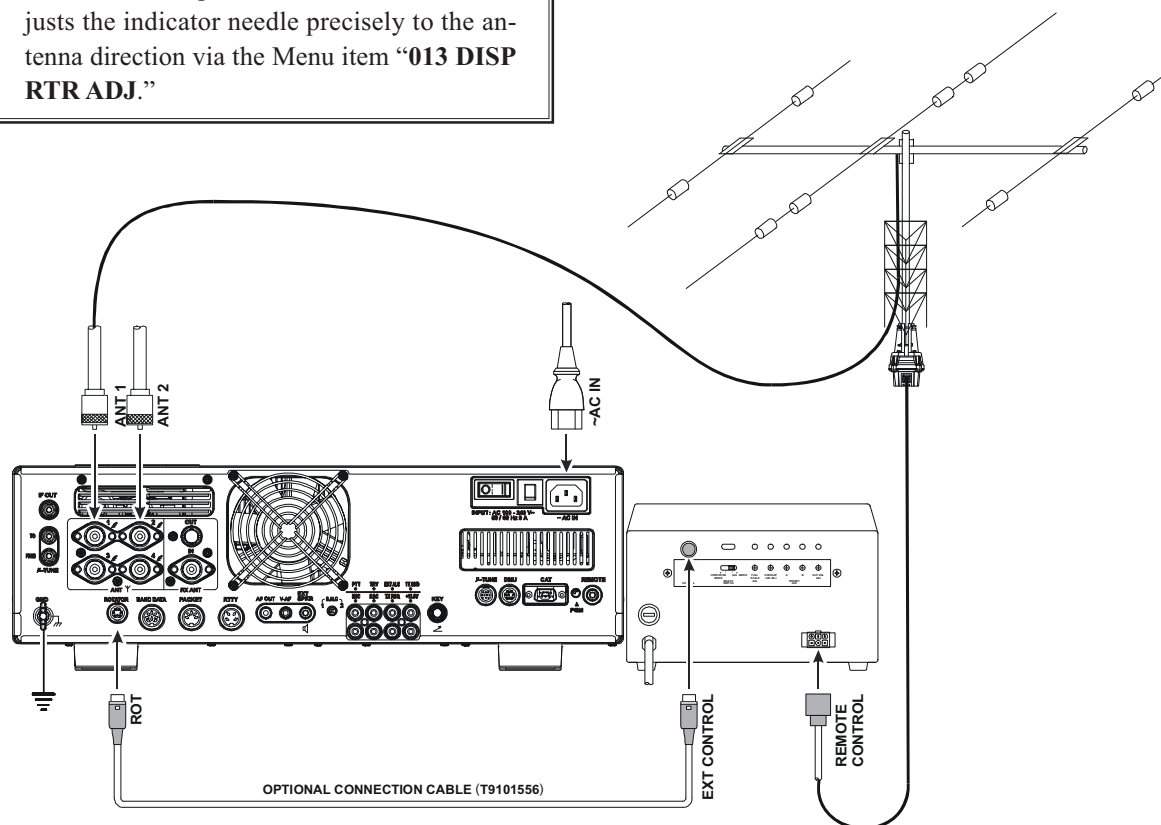

MORE FREQUENCY NAVIGATION TECHNIQUES

Keyboard Frequency Entry

You may enter operating frequencies, for either the VFO-A or VFO-B bands, using the front panel band/frequency selection keys.

Example 1: Enter 14.250.000 MHz into the VFO-A

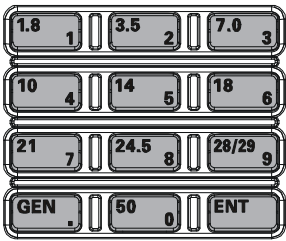
1. Press the **[ENT]** button to engage the direct frequency entry process. Now, beginning with the “10 MHz” digit of the frequency (the leftmost digit), we will enter the required digits of the frequency. 
2. Press, in order, the digits of the operating frequency, using the **[BAND]** buttons (which have the frequency-entry digit or decimal point on the right side of the slash bar). In this example, enter **[1.8/1]** → **[10/4]** → **[GEN./.]** → **[3.5/2]** → **[14/5]** → **[50/0]** → **[50/0]** → **[50/0]** → **[50/0]**
The decimal point after the “MHz” portion of the frequency must be entered, but no decimal point is required after the “kHz” portion.
3. Press the **[ENT]** button once more. A short “beep” will confirm that the frequency entry was successful, and the new operating frequency will appear on the Main (VFO-A) frequency display fields.

Example 2: Enter 7.100.000 MHz into the VFO-B

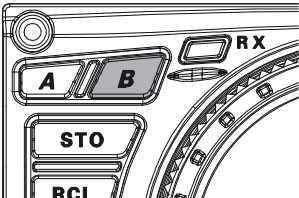
1. Press the **[B]** button, located to the upper left of the Main Tuning Dial knob. The imbedded LED in the **[B]** button is glows orange. 
2. Press the **[ENT]** button to engage the direct frequency entry process. Now, beginning with the “10 MHz” digit of the frequency (the leftmost digit), we will enter the required digits of the frequency to be entered into the VFO-B register.
3. Press, in order, the digits of the operating frequency, using the **[BAND]** buttons (which have the frequency-entry digit or decimal point on the right side of the slash bar). In this example, enter **[21/7]** → **[GEN./.]** → **[1.8/1]** → **[50/0]** → **[50/0]** → **[50/0]** → **[50/0]** → **[50/0]**
4. Press the **[ENT]** button once more. A short “beep” will confirm that the frequency entry was successful, and the new operating frequency will appear on the VFO-B frequency display fields.

ADVICE:

If you attempt to enter a frequency outside the operating range of 30 kHz ~ 60 MHz, the microprocessor will ignore the attempt, and you will be returned to your previous operating frequency. If this happens, please try again, taking care not to repeat the error in the frequency entry process.

Using the [▼(DOWN)]/[▲(UP)] Buttons

- Press the **[▼(DOWN)]/[▲(UP)]** button to tune the VFO-A frequency in 1 MHz step. 
- Press the **[B]** button first (The imbedded LED in the **[B]** button is glows orange), then press the **[▼(DOWN)]/[▲(UP)]** button to tune the VFO-B frequency in 1 MHz step.

ADVICE:

You may change the tuning step of the **[▼(DOWN)]/[▲(UP)]** button to 100 kHz via the Menu item “140 TUN MHz SEL”. See page 127.

Using the [UP]/[DWN] Switches of the Supplied MH-31B8 Hand Microphone

The **[UP]/[DWN]** switches on the supplied **MH-31B8** Hand Microphone may also be used for manually scanning upward or downward in frequency, respectively.

The microphone’s **[UP]/[DWN]** switches utilize the tuning steps of the Main Tuning Dial knob; moreover, when the microphone’s **[FAST]** key is pressed, the tuning rate increases by a factor of ten, in a manner similar to the effect of the transceiver’s front-panel **[FAST]** button.

ADVICE:

In the AM and FM modes, you may independently set the tuning steps when using the **[UP]/[DWN]** switches. To set new tuning steps, use Menu items “141 TUN AM STEP” and “142 TUN FM STEP”.

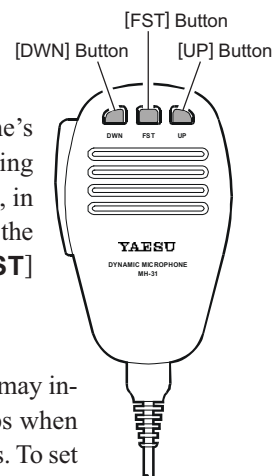

CONVENIENCE FEATURES

RECEIVER OPERATION (FRONT END BLOCK DIAGRAM)

The **FTdx5000** includes a wide range of special features to suppress the many types of interference that may be encountered on the HF bands. However, real world interference conditions are constantly changing, so optimum setting of the controls is somewhat of an art, requiring familiarity with the types of interference and the subtle effects of some of the controls. Therefore, the following information is provided as a general guideline for typical situations, and a starting point for your own experimentation.

We provide the RF-TUNING Unit (Narrow-bandwidth High-Q RF Filter) for the option.

VRF (SEE PAGE 53)

On the 1.9 - 28 MHz amateur bands, Yaesu's powerful VRF (Variable RF Filter) preselector circuit provides excellent suppression of out-of-band interference, with a passband much narrower than that provided by traditional fixed bandpass filters.

R. FLT (IF Roofing Filters) (SEE PAGE 54)

On the VFO-A receiver, three automatically-selected Roofing filters, in bandwidths of 15 kHz, 6 kHz, 3 kHz, 600 Hz, and 300 Hz are provided in the 9 MHz First IF, right after the first mixer. These filters provide narrow-band selectivity to protect the following IF and DSP stages, and the filters' automatically-selected bandwidths may be manually changed by the operator, if desired, for special operating circumstances.

The VFO-B receiver's 40 MHz IF includes a fixed Roofing filter, with a bandwidth of 15 kHz, 6 kHz, and 3 kHz.

CONTOUR Filter (SEE PAGE 55)

The DSP Contour filter is a unique capability on the **FTdx5000**, providing either nulling or peaking of tunable segments of the receiver passband, so as to suppress interference or excessive frequency components on an incoming signal, or to peak those tunable frequency segments. The amount of nulling/peaking, and the bandwidth over which it is applied, are adjustable via the Menu.

IF SHIFT (SEE PAGE 56)

The passband center frequency response of the IF DSP filtering may be adjusted using this control.

IF WIDTH (SEE PAGE 57)

The width of the IF DSP filtering may be adjusted using this control.

IF NOTCH (SEE PAGE 58)

The IF Notch filter is a high-Q notch filter that can significantly reduce, if not eliminate, an interfering carrier. The Q (sharpness) of the filter may be adjusted using the Menu.

DNR (DIGITAL NOISE REDUCTION) (SEE PAGE 59)

The DSP's Digital Noise Reduction (DNR) feature utilizes sixteen different mathematical algorithms to analyze and suppress different noise profiles encountered on the HF/50 MHz bands. Choose the selection that provides the best noise suppression, which concurrently will allow the signal to rise up out of the noise.

DNF (DIGITAL NOTCH FILTER) (SEE PAGE 59)

When multiple interfering carriers are encountered during reception, the Digital Notch Filter can significantly reduce the level of these signals.

AGC (SEE PAGE 62)

The AGC system is highly adaptable to changing signal and fading characteristics, making reception possible under the most difficult conditions.

SLOPED AGC (SEE PAGE 63)

The Sloped AGC system, instead of clamping a fixed upper bound on audio output across a wide range of input signals, actually allows the audio output to rise, very gently, with ever-increasing signal strength. This capability allows you to separate signals, using your brain, according to signal strength in addition to slight frequency differences.

IF Filter Quality Adjustment (SEE PAGE 125)

The "Q" (quality factor) of the IF DSP filters may be adjusted using the Menu.

Variable IF Filter Shape Factor (SEE PAGE 125)

You may adjust the shape factor of the receiver IF DSP filters using the Menu.

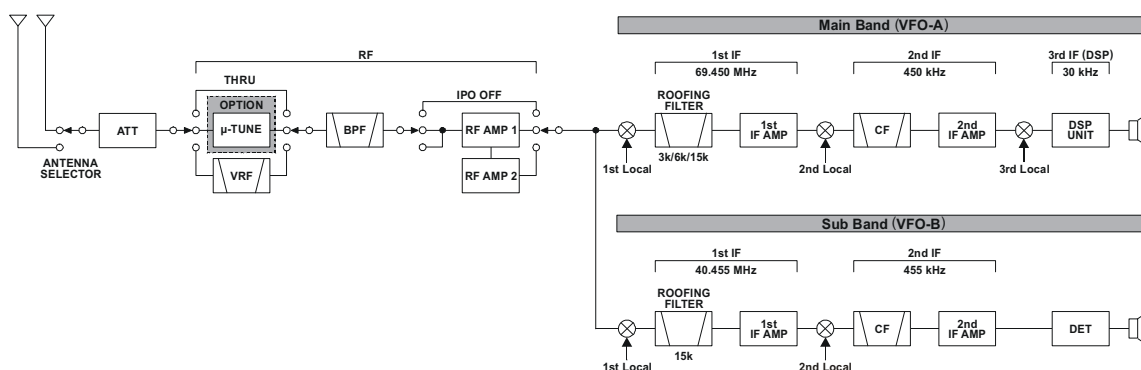

IPO (INTERCEPT POINT OPTIMIZATION)

The IPO feature allows the operator to optimize the characteristics of the receiver front end, depending on the current noise level and the strength of incoming signals.

VFO-A IPO Setup

- Press the [A] button (the imbedded LED in the [A] button is glows red), if desired.
- Move the [IPO] knob up and down to set the desired characteristic of the VFO-A receiver front end, per the chart below.

AMP1: Amplifies the incoming signal path using a low distortion RF preamplifier (normally, the IPO selection is set to this position).

AMP2: Increases the sensitivity.

IPO1: Improves the IPO.

IPO2: Bypasses the RF preamplifier, yielding direct feed to the first mixer. As a result, the IPO is improved more.

The selected receiver RF preamplifier will be indicated in the IPO column of the Block Diagram Display on the display.



- Press the [IPO] knob briefly to select the IPO setting to “AMP1” for quick selection.

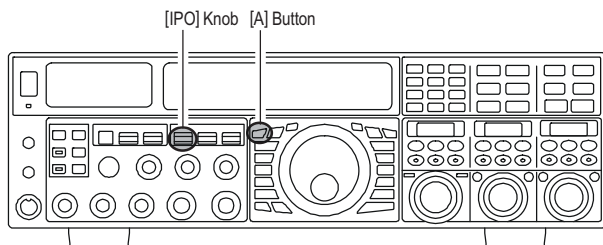

VFO-B IPO Setup

- Press the [B] button (the imbedded LED in the [B] button is glows orange).
- Move the [IPO] knob up and down to set the desired characteristic of the VFO-B receiver front end, per the chart below.

AMP1: Amplifies the incoming signal path using a low distortion RF preamplifier (normally, the IPO selection is set to this position).

AMP2: Increases the sensitivity.

IPO1: Improves the IPO.

The selected receiver RF preamplifier will be indicated in the IPO column of the Block Diagram Display on the display.

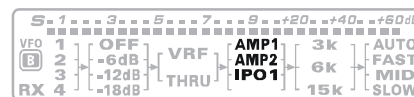

- Press the [IPO] knob briefly to select the IPO setting to “AMP1” for quick selection.

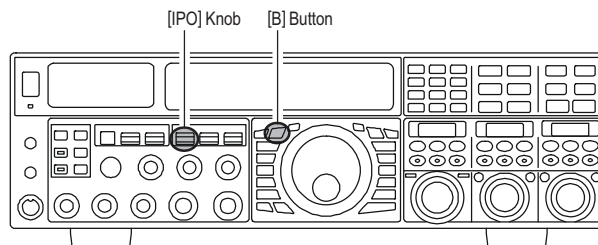

ADVICE:

On the 10 MHz and lower bands, it generally is not necessary to use any preamplifier at all; selecting the “ON” position described above will increase the strong-signal-handling capability of the receiver, and generally will result in more pleasant reception due to reduced noise. If you can hear band noise with the preamplifiers disengaged, then a preamplifier is generally not needed.

CONVENIENCE FEATURES

ATT

Even with the IPO function on, extremely strong local signals or high noise can still degrade reception. In such situations, you can use the [ATT] button to insert 6, 12, or 18-dB of RF attenuation in front of the RF amplifier.

VFO-A IPO Setup

- Press the [A] button (the imbedded LED in the [A] button is glows red), if desired.
- Move the [ATT] knob up and down to set the desired attenuation level of the VFO-A receiver, per the chart below.

OFF: Attenuator is Off
-6 dB: The incoming signal power is reduced by 6 dB (Signal voltage reduced by 1/2)
-12 dB: The incoming signal power is reduced by 12 dB (Signal voltage reduced by 1/4)
-18 dB: The incoming signal power is reduced by 18 dB (Signal voltage reduced by 1/8)

The selected attenuation level will be indicated in the ATT column of the Block Diagram Display on the display.



- To restore full signal strength through the Attenuator circuit area, press the [ATT] knob briefly to select the ATT setting to “OFF” for quick selection or move the [ATT] knob to restore the ATT display to the “OFF” position.

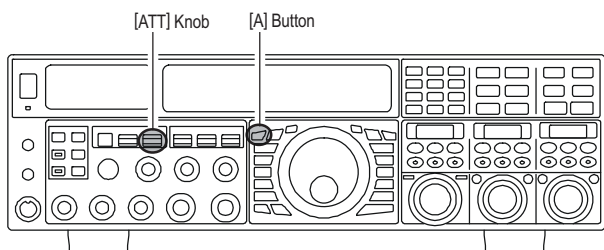

ADVICE:

If background noise causes the S-meter to deflect on clear frequencies, move the [ATT] knob until the S-meter drops to about “S-1”. This setting optimizes the trade-offs between sensitivity, noise, and interference immunity. Also, once you have tuned in a station you want to work, you may want to reduce sensitivity further (or add more attenuation) by moving the [ATT] knob to a more setting. This reduces the strength of all signals (and noise) and can make reception more comfortable, important especially during long QSOs. When looking for weak signals on a quiet band, you will want maximum sensitivity, so the IPO should be disabled and the [ATT] knob should be set to “OFF” by pressing the [ATT] knob. This situation is typical during quiet times on frequencies above 21 MHz, and when using a small or negative-gain receiving antenna on other bands.

VFO-A IPO Setup

- Press the [B] button (the imbedded LED in the [B] button is glows orange).
- Move the [ATT] knob up and down to set the desired attenuation level of the VFO-B receiver, per the chart below.

OFF: Attenuator is Off
-6 dB: The incoming signal power is reduced by 6 dB (Signal voltage reduced by 1/2)
-12 dB: The incoming signal power is reduced by 12 dB (Signal voltage reduced by 1/4)
-18 dB: The incoming signal power is reduced by 18 dB (Signal voltage reduced by 1/8)

The selected attenuation level will be indicated in the ATT column of the Block Diagram Display on the display.



- To restore full signal strength through the Attenuator circuit area, press the [ATT] knob briefly to select the ATT setting to “OFF” for quick selection or move the [ATT] knob to restore the ATT display to the “OFF” position.

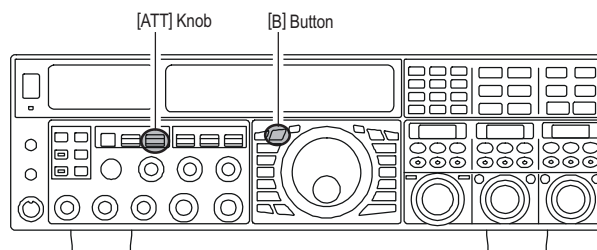

RF GAIN (SSB/CW/AM MODES)

The RF Gain controls provide manual adjustment of the gain levels for the receiver RF and IF stages, to account for noise and/or signal strength conditions at the moment.

VFO-A Receiver's RF GAIN Adjustment

The (VFO-A)[RF GAIN] knob should, initially, be rotated to the fully clockwise position. This is the point of maximum sensitivity, and counter-clockwise rotation will gradually reduce the system gain.

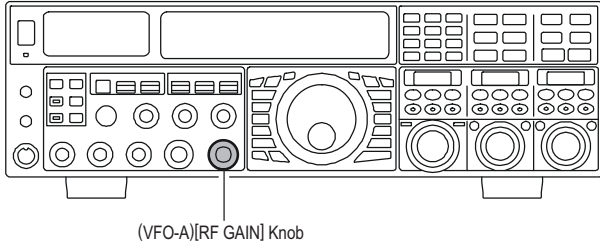

VFO-B Receiver's RF GAIN Adjustment

The VFO-B receiver's RF Gain operates identically to the VFO-A receiver's RF Gain.

- Press the (VFO-B)[RX] button to engage the Dual Receive operation. The imbedded LED in the (VFO-B)[RX] button is glows green.
- The fully clockwise position of the (VFO-B)[RF GAIN] knob should always be utilized as a starting point for operation.

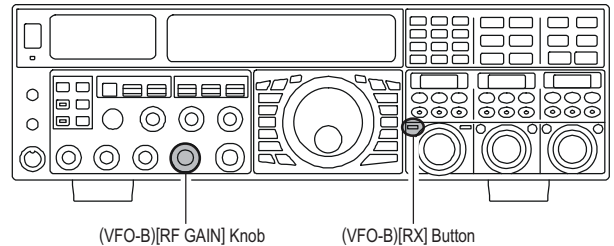

ADVICE:

- As the [RF GAIN] knob is rotated counterclockwise to reduce the gain, the S-meter reading will rise. This indicates that the AGC voltage being applied to the receiver is increasing (which causes a *reduction* in receiver gain).
- Rotating the [RF GAIN] knob control to the fully counter-clockwise position will essentially disable the receiver, as the gain will be greatly reduced. In this case, as well, the S-meter will appear to be "pegged" against the right edge of the analog S-meter scale.
- The (VFO-B)[RF GAIN] knob operates identically to the (VFO-A)[RF GAIN] knob. The effects of counter-clockwise rotation of the VFO-B receiver's RF Gain control may be observed visually on the VFO-B S-meter.

QUICK POINT:

- Reception frequently can be optimized by rotating the [RF GAIN] knob slightly counter-clockwise to the point where the incoming noise level is just about the same as the "stationary" meter needle position as set by the adjustment of the [RF GAIN] knob. This setting ensures that excessive gain is not being utilized, without so much gain reduction that incoming signals cannot be heard.
- The RF GAIN control, along with the IPO and ATT(enuator) features, all affect the system receiver gain in different ways. As a first step in dealing with high noise or a crowded, high-level signal environment, the IPO generally should be the first feature engaged, if the frequency is low enough to allow the preamplifier to be bypassed. Thereafter, the RF GAIN and ATT(enuator) features may be employed to provide precise, delicate adjustment of the receiver gain so as to optimize performance fully.

ADVANCED INTERFERENCE-SUPPRESSION FEATURES: RF FRONT END

The **FTdx5000** includes an unmatched array of RF selectivity-enhancing features. Please study the material below carefully, so as to understand the various features completely.

USING THE VRF (VARIABLE RF FRONT-END FILTER)

The VRF system is a high-performance RF front-end preselector that has high Q factor and low insertion loss. VRF provides outstanding rejection of out-of-band signals, and can significantly improve reception in tough co-location operations such as a contest or DX-pedition. The **FTdx5000**'s VRF system affects the 1.8 - 28 MHz amateur bands only.

VFO-A VRF Setup

- Press the **(VFO-A)[VRF]** button. The imbedded LED in the **(VFO-A)[VRF]** button is glows red, and the “**VRF**” icon will appear at the FLT column of the Block Diagram Display on the display. The VRF system will be engaged, centered on your current amateur band. The **(VFO-A)[SELECT]** knob will now functions as the VRF knob.

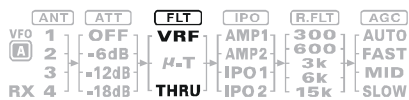

- You may rotate the **(VFO-A)[SELECT]** knob to skew the position of the VRF system relative to your operating frequency.

ADVICE:

- You may observe the relative skew of the VRF system in the Tuning Offset Indicator on the display and the **SUB DISPLAY-II**.
- After moving the passband of the VRF system manually, you may re-center it on the current Amateur band by pressing the **(VFO-A)[CLEAR]** button.
- To switch VRF off, press the **(VFO-A)[VRF]** button until the “**VRF**” icon shows “**THRU**” in the FLT column of the Block Diagram Display on the display; this confirms that the VRF circuit has been removed from the incoming received signal path.

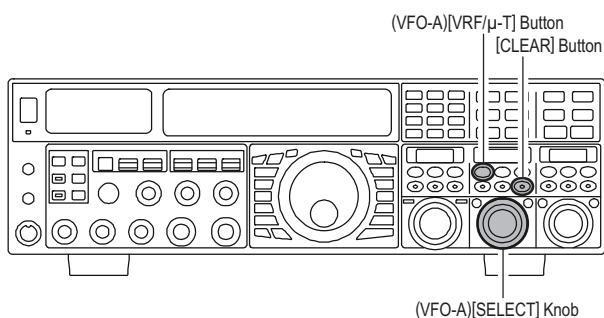

VFO-B VRF Setup

- Press the **(VFO-B)[RX]** button to engage the Dual Receive operation. The imbedded LED in the **(VFO-B)[RX]** button is glows green.
- Press the **(VFO-B)[VRF]** button. The imbedded LED in the **(VFO-B)[VRF]** button is glows red, and the “**VRF**” icon will appear at the FLT column of the Block Diagram Display on the display. The VRF system will be engaged, centered on your current amateur band. The **(VFO-B)[SELECT]** knob will now functions as the VRF knob.

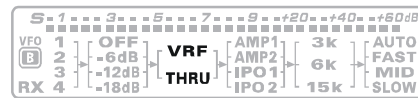

- You may rotate the **(VFO-B)[SELECT]** knob to skew the position of the VRF system relative to your operating frequency.

ADVICE:

- You may observe the relative skew of the VRF system in the **SUB DISPLAY-III**.
- After moving the passband of the VRF system manually, you may re-center it on the current Amateur band by pressing the **(VFO-B)[CLEAR]** button.
- To switch VRF off, press the **(VFO-B)[VRF]** button. The “**VRF**” icon shows “**THRU**” in the FLT column of the Block Diagram Display on the display; this confirms that the VRF circuit has been removed from the incoming received signal path.

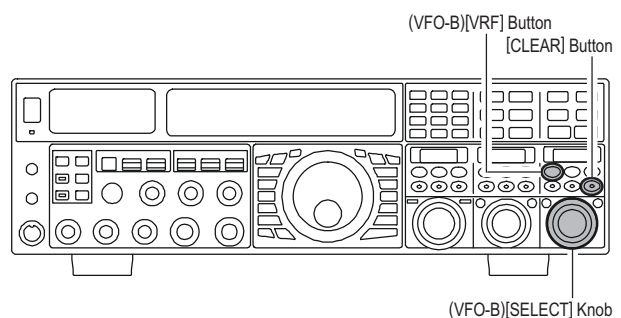

USING THE VRF (VARIABLE RF FRONT-END FILTER)

ADVICE:

- ❑ Because the VRF system is relatively broad, although still much narrower than the fixed bandpass filter), you may not hear much difference in the background noise or signal quality when you make minor adjustments. However, if you have receiving problems associated by a very strong signal, rotation of the **[SELECT]** knob may help reduce the strength of the interfering station, allowing improved reception of the desired signal if overload was degrading reception.
- ❑ The VRF Filter operational status will be memorized independently on each VFO in the VFO stack.

QUICK POINT:

The VRF filter, utilizing high-quality coils and capacitors that provide high Q, yields a passband that is approximately 20% to 30% the width of a traditional, fixed bandpass filter. As a result, significantly more “unwanted” signal rejection is provided. Within each amateur band, the following adjustment steps are provided, if you wish to skew the response in a particular direction so as to enhance interference rejection even more. The actual “sound” of the signal you are listening to will remain unchanged, however.

AMATEUR BAND	VRF ADJUSTMENT STEPS
1.8 MHz	62 steps
3.5 MHz	62 steps
5 MHz	62 steps
7 MHz	62 steps
10 MHz	30 steps
14 MHz	30 steps
18 MHz	20 steps
21 MHz	20 steps
24.5 MHz	20 steps
28 MHz	20 steps

INTERFERENCE REJECTION (SIGNALS OFF FREQUENCY BY JUST A FEW KHZ)

R.FLT (ROOFING FILTERS)

Narrow-band Roofing Filters of 15 kHz, 6 kHz, 3 kHz, 600 Hz*, and 300 Hz* bandwidths are provided in the first IF, right after the first mixer. These filters provide protection for the 2nd mixer, DSP, and other circuitry that follow and can dramatically improve reception on a very crowded band (during a contest, etc.). Typically, the AUTO selection mode is satisfactory for most operating situations, but in an extremely crowded phone band you may wish to select, for example, the 3 kHz roofing filter for SSB operation.

*: The roofing filter of 600 Hz is select in VFO-A only (The roof filter of 600Hz can not select in VFO-B). Furthermore, the roofing filter of 300 Hz is select in VFO-A of the MP version only (The roof filter of 300Hz is optional in the other versions).

VFO-A Roofing Filter Setup

- Press the [A] button (the imbedded LED in the [A] button is glows red), if desired.
- Move the [R.FLT] knob up and down to set the desired bandwidth of the VFO-A Roofing Filter. The selected bandwidth of the Roofing Filter will be indicated in the R.FLT column of the Receiver Configuration Indicator on the display.



- Press the [R.FLT] knob briefly to select the Roofing Filter setting to “AUTO”, that selection of the Roofing Filter is based on the operating mode. When the Roofing Filter setting is to “AUTO”, the bandwidth of the Roofing Filter will blink for three seconds and thereafter will appear continuously. Typically, this selection will be set to “AUTO”.

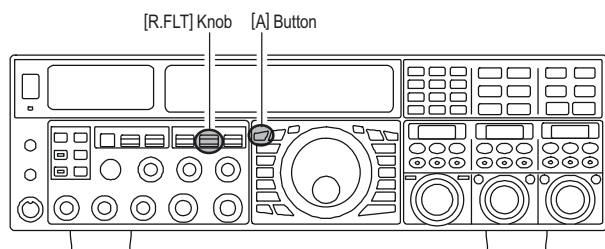

VFO-B Roofing Filter Setup

- Press the [B] button (the imbedded LED in the [B] button is glows orange).
- Move the [R.FLT] knob up and down to set the desired bandwidth of the VFO-B Roofing Filter. The selected bandwidth of the Roofing Filter will be indicated in the R.FLT column of the Receiver Configuration Indicator on the display.

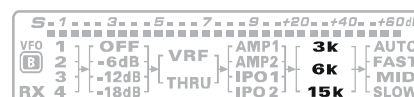

- Press the [R.FLT] knob briefly to select the Roofing Filter setting to “AUTO”, that selection of the Roofing Filter is based on the operating mode. When the Roofing Filter setting is to “AUTO”, the bandwidth of the Roofing Filter will blink for three seconds and thereafter will appear continuously. Typically, this selection will be set to “AUTO”.

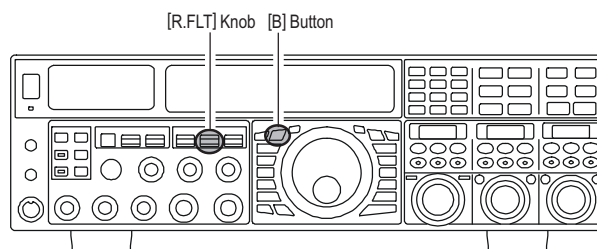

ADVICE:

- The Roofing Filter selection will be memorized independently on each VFO in the VFO stack.

QUICK POINT:

- The AUTO mode Roofing Filter selections are shown below:

AM/FM/FM-PKT: 15 kHz
 LSB/USB/PKT: 6 kHz
 CW/RTTY: 3 kHz

TERMINOLOGY:

A “Roofing Filter,” as its name implies, places a “Roof” over the receiver’s IF system bandwidth. This “Roof” protects the circuitry downstream from the first mixer from interference, just as a roof on a house protects the contents from rain and snow.

NOTE

CONTOUR CONTROL OPERATION

The Contour filtering system provides a gentle perturbation of the IF filter passband, so as to suppress or enhance certain frequency components, thus enhancing the sound and/or readability of a received signal.

VFO-A Contour Operation

- Press the **(VFO-A)[CONT/APF]** button. The imbedded LED in the **(VFO-A)[CONT/APF]** button is glows red, and current “null” (or “Peak”) position of the contour filter will appears in the **SUB DISPLAY-II**. The **(VFO-A)[SELECT]** knob will now functions as the contour knob.
- Rotate the **(VFO-A)[SELECT]** knob to achieve the most natural-sounding audio reproduction on the incoming signal.
- Press the **(VFO-A)[CLEAR]** button to move the “null” (or “Peak”) position to center.
- To cancel Contour tuning, press the **(VFO-A)[CONT/APF]** button once more.

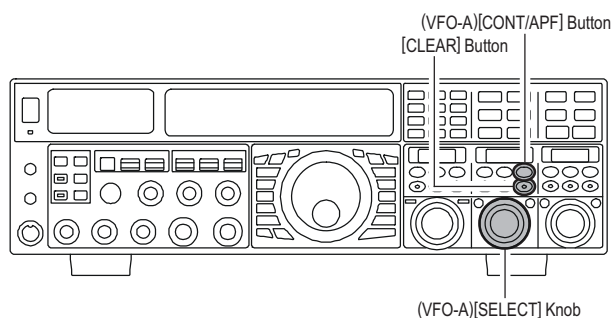

VFO-B Contour Operation

- Press the **(VFO-B)[CONT/APF]** button. The imbedded LED in the **(VFO-B)[CONT/APF]** button is glows red, and current “null” (or “Peak”) position of the contour filter will appears in the **SUB DISPLAY-III**. The **(VFO-B)[SELECT]** knob will now functions as the contour knob.
- Rotate the **(VFO-B)[SELECT]** knob to achieve the most natural-sounding audio reproduction on the incoming signal.
- Press the **(VFO-B)[CLEAR]** button to move the “null” (or “Peak”) position to center.
- To cancel Contour tuning, press the **(VFO-A)[CONT/APF]** button once more.

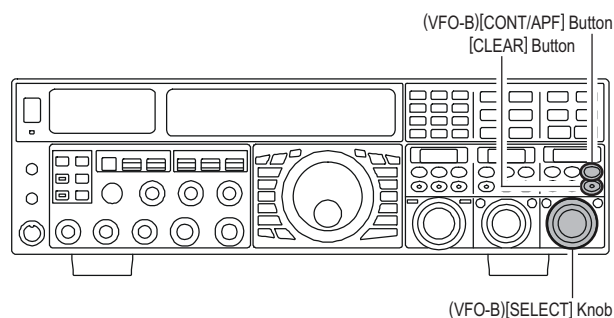

ADVICE:

- The contour filter’s level (either nulling or peaking) may be adjusted using Menu item “**108 RDSP CNTR LV**”. The factory default setting is for a null of “**-15**” (dB).
- The bandwidth over which the contour filter effect is applied may be adjusted using Menu item “**109 RDSP CNTR WI**.” The factory default setting is “**10**.”
- When the optional **DMU-2000** Data Management Unit is connected, the Audio Scope (on the “Oscilloscope” page) is particularly useful when adjusting the Contour control. Not only can you see the effect of the null/peak of the Contour system, but you also can see the position of the null/peak with respect to frequency components of interest on the incoming signal. You may then observe (on the Audio Scope) the effect of the Contour control while listening to the effect on the signal, and this will help build your intuition on how best to use Contour tuning in the future.

QUICK POINT:

The steep slopes of the DSP filtering can, when adjusted aggressively, impart an unnatural sound to an incoming signal. Oftentimes, though, a narrow bandwidth is not the key to improving copy; the incoming signal itself may have undesirable or excessive frequency components, especially in the low-frequency range around 100-400 Hz. By judicious use of the Contour filter, the “shoulder” of the passband response may be altered, or components removed from within the passband, allowing the desired signal to rise above the background noise and interference in a manner not obtainable with other filtering systems.