

Taking Pictures with the optional Camera (Snapshot Function)

Snapshots can be easily taken with the camera that is built into the optional speaker microphone “MH-85A11U”.

The picture taken will appear on the display for several seconds and can also be transmitted to other transceivers simply by pressing the transmit picture button on the microphone.

Tips

- Refer to our YAESU website and catalog for the transceiver models that can transmit pictures.
- The picture transmit button on the microphone can only transmit picture data after the image has been taken.
- The snapshot function will not operate unless the micro-SD card is inserted into the card slot on the main body.

The picture taken will be saved in the micro-SD card inserted into the main body card slot. The saved picture data can be transmitted to transceivers operating in the digital mode.

Connecting the speaker microphone with camera

- 1 Switch the power supply to the radio OFF
- 2 Connect the MH-85A11U to the main body
 Refer to the figure on the right to plug the connector of the microphone into the [DATA] jack at the front of the main body.

Caution Check the direction of the connector and plug it in all the way.

- 3 Referring to the figure, mount the provided microphone cord holder to secure the MH-85A11U cord to the main body.

Caution Remove the screws at the side of the radio and use the provided screw and washer to mount the microphone cord holder.

Tip As the microphone connector can be passed through the microphone cord holder attached to the radio, there is no need to remove it once it is mounted.

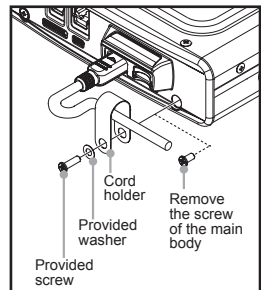
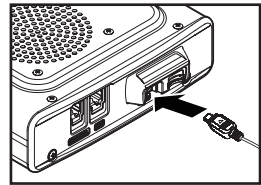

- 4 Switch on the power supply to the main device
- 5 Press **[DISP]** for one second or longer
 The set-up menu will be displayed.
- 6 Touch **[DATA]**

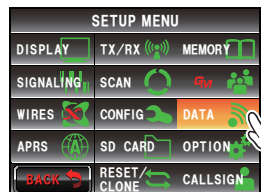

Taking Pictures with the optional Camera (Snapshot Function)

7 Touch [1 COM PORT SETTING]

The screen for the detailed settings will be displayed.

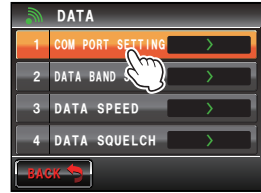

8 Touch [OUTPUT] to select "OFF(camera)"

The setting changes as follows each time it is touched.

"OFF(camera)" → "GPS OUT" → "PACKET" → "WAYPOINT"

Tip Factory default value: OFF (camera)

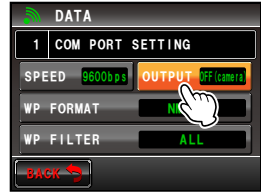

9 Press [DISP/SEND] for one second or longer

The display will return to the previous screen.

Tip The display can also be returned to the previous screen by touching [BACK] twice.

Taking pictures

1 Insert the micro-SD card and turn the radio ON

2 Point the camera lens at the object to be photographed and press the shutter button on the microphone

Caution Keep a focal distance of at least 50 cm between the object and the camera. The picture will be out of focus when the object is too near and the image will not be clear.

Tip In factory default, pictures will be taken with a size of 320 * 240 in the NORMAL picture quality.

The size (resolution) and quality (compression ratio) of the picture can be set using "OPTION" → "1 USB CAMERA" in the set-up menu (P.200).

The picture taken will appear in the display for 10 seconds.

Subsequently, the picture will be stored in JPEG format, on the microSD card that has been inserted into the main body card slot.

While the picture appears in the display, touch [BACK], [DEL] or [FORWARD], you can save the data, delete or transfer it to other stations.

[BACK]: Save the picture to the microSD card, then return to the original screen.

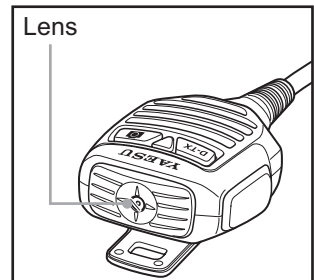
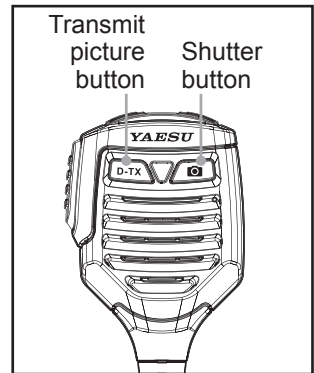

Functions to be Used when Necessary

Taking Pictures with the optional Camera (Snapshot Function)

[DEL]: Delete the picture*, then return to the original screen.*:Deleted images, can be seen on the PC.

[FORWARD]: Send the picture to other transceivers.Press the microphone [PTT] button to cancel the picture transmission (the picture will be stored in the microSD card).

While the picture appears in the display, press the shutter button again, the picture will be saved to the microSD card, then the pic-ture taken will appear in the display.

- Tip**
- It takes about 30 seconds to transmit a picture taken with a resolution of 320 * 240 to another transceiver.
 - Press the microphone **[PTT]** button to cancel the picture transmission (it may take a while for the transmission to be canceled).
 - After the picture is transmitted, the mode will automatically switch to DN of the AMS mode.

Tip

The first picture taken will be saved under the filename "M*****000001.jpg" while the pictures taken subsequently will be saved under the filenames "M*****000002.jpg", "M*****000003.jpg" and so on in increasing order.

The folder configuration in the micro-SD card is as follows and the data of the pictures taken is saved in the folder named "PHOTO" under the root directory.

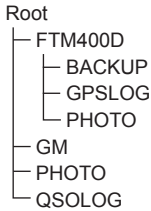

Taking Pictures with the optional Camera (Snapshot Function)

Viewing a saved picture

1 Press **[F.MENU]**
 The function menu will be displayed.

2 Touch **[LOG]**
 A list of the text messages or the pictures saved in the micro-SD card will be displayed.

- Tip** • A list of the text messages will be displayed when the touch key is **[MSG]**. This will change to a list of pictures when **[LOG]** is touched.
- The date and time the picture was taken will be used as the tag of the picture.
 - Newly taken pictures will be displayed at the top of the list.



3 Select and touch the picture that you want to see
 The picture will appear after the message "Waiting..." is shown.

- Tip** • Pictures taken with the resolution set to "320 * 240" (unit: pixel) in the set-up menu under "OPTION" → "1 USB CAMERA" → "PICTURE SIZE" will be displayed in full screen when touched. After 10 seconds or when the picture is touched again, it will return to the original screen.
- Touch **[EDIT]** at the top right of the screen to edit the tag.
 - Touch **[DEL]** to erase the picture from the micro-SD card.
 - Touch **[FORWARD]** or **[REPLY]** to send the picture to other transceivers (see P.129).



4 Touch **[BACK]**
 The display will return to the screen showing the list of pictures.



Tip The pictures can be viewed on a personal computer by reading the contents of the micro-SD card into the personal computer.

Caution When the filename of the picture is changed on the personal computer, the picture can not longer be shown in the display of the FTM-400XDR/DE.

Functions to be Used when Necessary

Optional receive Audio Record and Playback

The receive audio received can be recorded and then played back later using the optional voice guide unit “FVS-2”.

The voice announcing the frequency of the operating band can also be heard when the announce function is set to on.

Mounting the voice guide unit “FVS-2”

● Preparations

- Voice guide unit “FVS-2” (optional)
- Plus driver

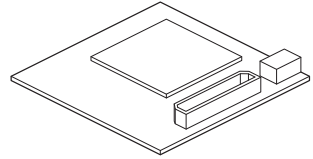

● Mounting procedure

Cautions

- Unless necessary, do not touch any parts with your hands as the semiconductors may be damaged by static electricity.
- Note that labor charges to install optional items by our company's customer service support staff shall be separately chargeable.

- 1 Switch off the power supply to the radio
- 2 Switch off the external power supply
- 3 Unplug the control cable, microphone and DC power supply cable from the main body
- 4 Remove the eight screws from the main body, four on top and two each at the sides

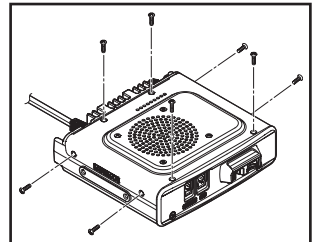

Optional receive Audio Record and Playback

- 5 Slowly lift up the front side of the top cover of the main body

Caution Do not lift up the top cover by force. This may result in cables connected to the boards inside the main body and the speaker inside the cover to be cut.

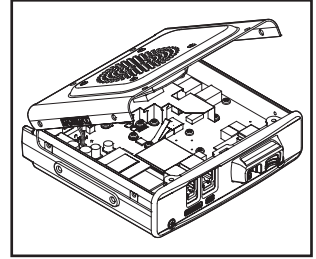

- 6 Unplug the speaker cables extending from the top cover from the socket of the board inside the main body first before removing the cover

Caution Hold the connector when unplugging the cable without pulling the cable itself.

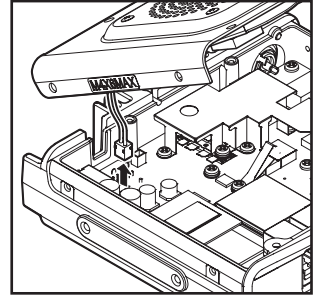

- 7 Refer to the figure on the right to mount the FVS-2

Caution Check the direction of the connector and plug the FVS-2 in all the way to the back.

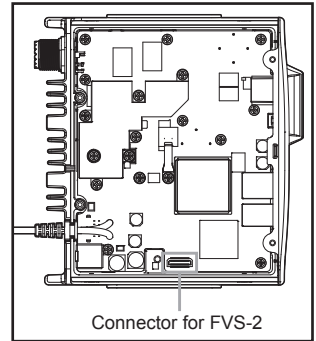

- 8 Plug in the speaker cables extending from the main body top cover to the original socket on the board
- 9 Attach the main body top cover and secure using the screws eight

Optional receive Audio Record and Playback

Using the voice memory

The voice memory is a function for recording the audio received. The audio is saved in FVS-2 that is mounted to the radio. The saved audio can be replayed on the radio and erased later.

Setting the voice memory operation

- 1 Switch on the power supply to the radio
 - 2 Press  for one second or longer
 The set-up menu will be displayed.
 - 3 Touch **[OPTION]**

 - 4 Select and touch **[3 VOICE MEMORY]**
 The screen for the detailed settings will be displayed.

 - 5 Touch **[PLAY/REC]** to set the recording time
 The setting will switch between “FREE 5min” and “LAST 30sec” each time it is touched.
 “FREE 5min”: A total of 5 minutes of audio in 8 recording areas can be recorded.
 “LAST 30sec”: The last 30 seconds will be recorded.
- Tip** Factory default value: FREE 5 min
- 6 Press  for one second or longer
 The display will return to the previous screen.

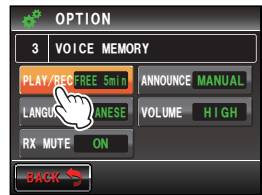
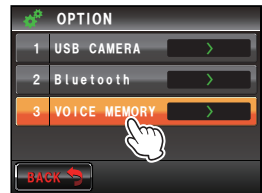
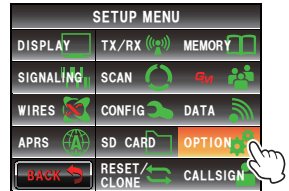

Functions to be Used when Necessary

Optional receive Audio Record and Playback

Recording the receive audio

1 Press **[F REC]**
 The function menu will be displayed.

2 Touch **[REC]**
 The recording will be started.

- Tips**
- When **[REC]** is not displayed in the menu, use **[BACK]** or **[FWD]** to switch the menu.
 - Set the recording time set using “**OPTION**” → “**3 VOICE MEMORY**” in the set-up menu will be displayed under **[REC]**.

3 Touch **[STOP]**
 The recording will stop.
 The track number of the audio recorded will be displayed under **[PLAY TRACK]**.



4 Press **[F REC]**
 The display will return to the previous screen.

Replaying the recorded audio

1 Press **[F REC]**
 The function menu will be displayed.

2 Touch **[PLAY/REC]** to select the track number to be replayed

- Tips**
- This is not available if there is only one recording.
 - When there are two or more recordings, the track number will change in the order “ALL”, “1”, “2”... each time it is touched.
 - All recorded tracks will be replayed in sequence when “ALL” is selected.



Functions to be Used when Necessary

Optional receive Audio Record and Playback

3 Touch [PLAY]

Replay will be started.

The replay will stop automatically at the end of the selected track.



Touch [STOP] to stop the replay.



4 Press [F.MENU]

The display will return to the previous screen.

Erasing the recorded audio

1 Press [F.MENU]

The function menu will be displayed.

2 Touch [CLR]

The confirmation screen will be displayed.



3 Touch [OK?]

Erasure will be started.

Caution All recorded audio will be erased. When there are two or more recordings, the track number to be erased cannot be chosen.

When the recordings are erased, [ALL] will be displayed under [PLAY TRACK].



4 Press [F.MENU]

The display will return to the previous screen.

Optional receive Audio Record and Playback

Listening to the frequency voice announcement

Setting the announce function operation

Set the following voice announcement parameters.

- Automatically reading out the frequency or not
- Reading out the frequency in English or Japanese
- Reading out aloud
- Mute the receive audio during a voice announcement or replaying recorded audio.

1 Press **[DISP/SCAN]** for one second or longer
 The set-up menu will be displayed.

2 Touch **[OPTION]**

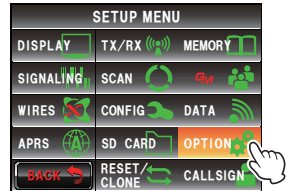

3 Select and touch **[3 VOICE MEMORY]**
 The screen for the detailed settings will be displayed.

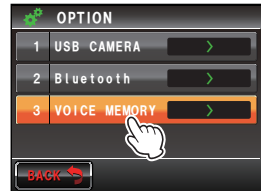

4 Touch **[ANNOUNCE]** to select the condition for reading out of the frequency

The setting will switch between “AUTO”, “OFF” and “MANUAL” each time it is touched.

“AUTO”: The frequency is read out when the band is changed after touching **[VOICE]**.

“OFF”: The frequency is not read out.

“MANUAL”: The frequency is read out when **[VOICE]** is touched.

Tip Factory default value: AUTO

5 Touch **[LANGUAGE]** to select the language in which to read out the frequency

The setting will switch between “ENGLISH” and “JAPANESE” each time it is touched.

Tip Factory default value: ENGLISH



Functions to be Used when Necessary

Optional receive Audio Record and Playback

6 Touch **[VOLUME]** to select the announcement volume
 The setting will switch between “HIGH”, “MID” and “LOW” each time it is touched.

Tip Factory default value: HIGH



7 Touch **[RX MUTE]** to select ON/OFF
 The setting will switch between “ON” and “OFF” each time the symbol is touched.

ON: The receive audio will be muted during a voice announcement or replaying recorded audio.

OFF: The receive audio will not be muted during a voice announcement or replaying recorded audio.

Tip Factory default value: ON



8 Press **[DSP]** for one second or longer

The announce function operation will be set and the display will return to the previous screen.

Listening to the frequency voice announcement

(1) When the operation is set to “AUTO”

The frequency of the operating band will be automatically announced in the following cases.

- When the VFO mode and memory mode are switched
- When the operating band is changed

Tips

- The frequency will also be announced when **[VOICE]** is touched.
- The volume may be adjusted by turning of the operating band.

(2) When the operation is set to “MANUAL”

1 Press **[F]**
 The function menu will be displayed.

2 Touch **[VOICE]**
 The frequency of the operating band will be announced.



Tip

- The volume can also be adjusted by turning of the operating band.

Functions to be Used when Necessary