

 **Vertex Standard**

VX-4600 SERIES

OPERATING MANUAL

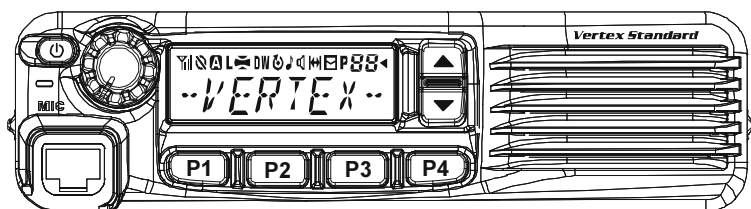

VERTEX STANDARD CO., LTD.

4-8-8 Nakameguro, Meguro-Ku, Tokyo 153-8644, Japan

VERTEX STANDARD

US Headquarters

10900 Walker Street, Cypress, CA 90630, U.S.A.

YAESU UK LTD.

Unit 12, Sun Valley Business Park, Winnall Close
Winchester, Hampshire, SO23 0LB, U.K.

VERTEX STANDARD HK LTD.

Unit 5, 20/F., Seaview Centre, 139-141 Hoi Bun Road,
Kwun Tong, Kowloon, Hong Kong

VERTEX STANDARD (AUSTRALIA) PTY., LTD.

Normanby Business Park, Unit 14/45 Normanby Road
Notting Hill 3168, Victoria, Australia

Congratulations!

You now have at your fingertips a valuable communications tool: a Vertex Standard two-way radio! Rugged, reliable and easy to use, your Vertex Standard radio will keep you in constant touch with your colleagues for years to come, with negligible maintenance downtime.

Please take a few minutes to read this manual carefully. The information presented here will allow you to derive maximum performance from your radio.

We're glad you joined the Vertex Standard team. Call on us anytime, because communications is our business. Let us help you get your message across.

NOTICE !

There are no owner-serviceable parts inside the transceiver. All service jobs must be referred to an authorized Vertex Standard Service Representative. Consult your Authorized Vertex Standard dealer for installation of optional accessories.

SAFETY/WARNING INFORMATION

WARNING - DO NOT operate the **VX-4500/-4600** radio when any person(s) (bystanders) outside the vehicle are within the distances shown in the chart at the bottom of this section.

Safety Training information:

Antennas used for this transmitter must not exceed an antenna gain of 3 dBi. The radio must be used in vehicle-mount configurations with a maximum operating duty cycle not exceeding 50 %, in typical Push-to-Talk configurations.

This radio is restricted to occupational use, work related operations only where the radio operator must have the knowledge to control the exposure limits of passengers and bystanders by maintaining the minimum separation distance shown below.

Failure to observe these restrictions will result in exceeding the FCC RF exposure limits.

Antenna Installation:

For rear deck trunk installation, the antenna must be located at least the following distance away from rear-seat passengers in order to comply with the FCC RF exposure requirements.

For roof top installations, the antenna must be placed in the center of the roof.

Unsafe Radiation Distance

VHF Model	UHF Model
1.85 Feet (0.56 m)	2.08 Feet (0.64 m)

CONTROLS & CONNECTORS

Front Panel

Important! - All buttons located on the Front Panel are Programmable Function (PF) Buttons, configured according to your network requirements and programmed by your VERTEX STANDARD dealer. The instructions below describe a typically-configured radio.

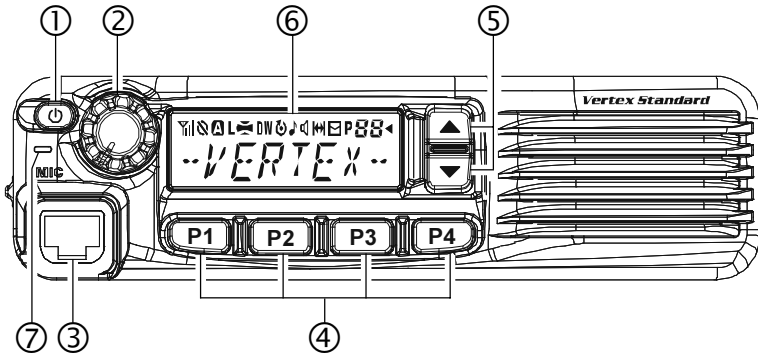

① PWR (⏻) Button

Press and hold in this button for 2 seconds to toggle the transceiver's power "on" and "off".

② VOL Knob

Turn this control clockwise to increase the volume.

③ Microphone Jack

Connect the microphone plug to this jack.

④ [P1] - [P4] Buttons (Programmable Function Buttons)

These buttons can be set up for special applications, such as High/Low power selection, Monitor, Talk-Around, etc., as determined by your network requirements and programmed by your VERTEX STANDARD dealer.

⑤ [▼]/[▲] Buttons (Programmable Function Buttons)

In the factory default, pressing either button changes the current channel (and displayed channel number or name). Holding in either button for more than 1.5 second causes the radio to begin stepping (repeatedly) upward or downward through the channels.

CONTROLS & CONNECTORS

⑥ LCD (Liquid Crystal Display)

The display includes a 8-character alpha-numeric section showing Channel name tags/identity information and error messages, and an upper icon row displaying feature status (see below).

⑦ TX/BUSY Indicator

Indicates transceiver's Transmit/Receive Status

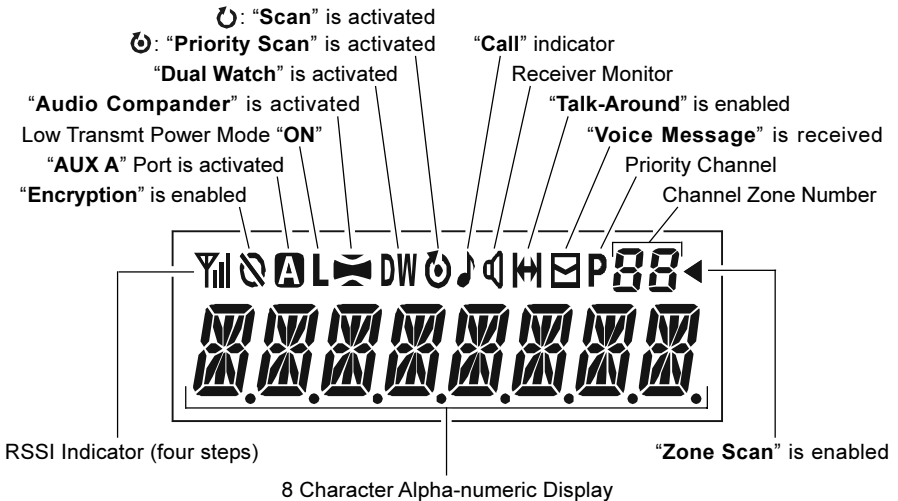

CONTROLS & CONNECTORS

Rear Panel

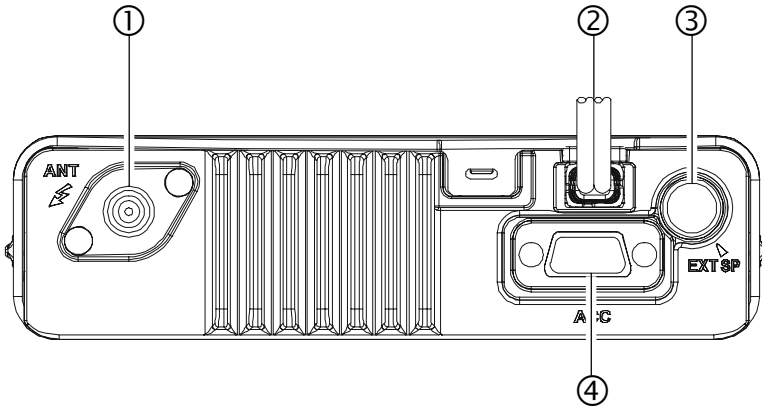

① Antenna Socket

The 50-Ohm coaxial feedline to the antenna must be connected here, using a mini-UHF plug.

② 13.6V DC Cable Pigtail with Connector

The supplied DC power cable must be connected to this 2-pin connector. Use only the supplied fused cable, extended if necessary, for power connection.

③ External Speaker Jack

An external loudspeaker may be connected to this 2-contact, 3.5-mm mini-phone jack.

Caution: Do not connect either wire of this line to ground, and be certain that the speaker has adequate capability to handle the audio output (12 W) from the radio.



④ D-Sub 15-Pin Accessory Connector

External TX audio line input, PTT (Push To Talk), Squelch, and external RX audio line output signals may be obtained from this connector for use with accessories such as data transmission/reception modems, and external Channel control input etc.

BASIC OPERATION OF THE TRANSCEIVER

Important! - Before turning on the radio the first time, confirm that the power connections have been made correctly and that a proper antenna is connected to the antenna jack.

Switching Power ON/OFF

- Press and hold in the **PWR**() button for 2 seconds to turn the radio on. The display will become illuminated.
- Press the []/[] button to choose the desired operating channel. A channel name will appear on the display. If you want to select an operating channel from a different group, press the **PF** (Programmable Function) button which is programmed to the Group Up/Down feature to select the group you want before selecting the operating channel. See page 7 for more information on the Programmable Function keys.

Setting the Volume

- Turn the **VOL** knob clockwise to increase the volume, and counterclockwise to decrease it.

Transmitting

- To transmit, monitor the channel and make sure it is clear.
THIS IS AN FCC REQUIREMENT!
- Press the **PF** button which is programmed to the Monitor feature to listen for channel activity.
- When receiving a call, transmit only after the incoming call ends. The radio cannot receive a call and transmit simultaneously.
- Press the **PTT** switch.
- If the channel is clear, the **TX/BUSY** indicator will glow red. The radio is now transmitting. While holding in the **PTT** switch, speak across the face of the microphone in a clear and normal voice. For best transmission, hold the microphone about 1-1/2 to 2 inches away from your mouth. Release the **PTT** switch to receive.
- If the Busy Channel Lockout feature has been programmed on a channel, the radio will not transmit when a carrier is present. Instead, the radio will generate a short beep three times and indicate “* ERROR *” on the display. Release the **PTT** switch and wait for the channel to be clear of activity.
- If CTCSS or Digital Coded Squelch (DCS) Lockout has been programmed on a channel, the radio can transmit only when there is no carrier being received or when the carrier being received includes the correct CTCSS tone or DCS code.

BASIC OPERATION OF THE TRANSCEIVER

Automatic Time-Out Timer

If the selected channel has been programmed for automatic time-out, you must limit the length of each transmission. While transmitting, a beep will sound 10 seconds before time-out. Another beep will sound just before the deadline; the red “**TX**” indicator will disappear and transmission will cease soon thereafter. To resume transmitting, you must release the **PTT** switch and wait for the “penalty timer” to expire (if you press the **PTT** switch before this timer expires, the timer restarts, and you will have to wait another “penalty” period)

Key Lock

In order to prevent accidental frequency change or inadvertent transmission, various aspects of the **VX-4600**’s keys may be locked out.

To activate the Locking feature, press and hold in the [**P1**] key while turning the radio on. To disable the Locking feature, repeat this power-on procedure.

ADVANCED OPERATION

Programmable Function (PF) Buttons

The **VX-4600** Series includes six Programmable Function (**PF**) Buttons. The PF button functions can be customized, via programming by your Vertex Standard dealer, to meet your communications/network requirements. Some features may require the purchase and installation of optional internal accessories. The possible **PF** button programming features are illustrated below, and these functions are explained on the pages to follow. For further details, contact your Vertex Standar dealer. For future reference, check the box next to the function that has been assigned to each **PF** button on your particular radio, and keep it handy.

ADVANCED OPERATION

Function	PF Button (PRESS KEY/PRESS AND HOLD KEY)					
	P1	P2	P3	P4	▲	▼
MONI	/	/	/	/	/	/
SQL OFF	/	/	/	/	/	/
SQL SET	/	/	/	/	/	/
DIMMER	/	/	/	/	/	/
Channel Up	/	/	/	/	/	/
Channel Down	/	/	/	/	/	/
Continuous Ch Up	-/	-/	-/	-/	-/	-/
Continuous Ch Down	-/	-/	-/	-/	-/	-/
Zone Up	/	/	/	/	/	/
Zone Down	/	/	/	/	/	/
SCAN	/	/	/	/	/	/
SCAN SET	/	/	/	/	/	/
Zone SCAN	/	/	/	/	/	/
Zone SCAN SET	/	/	/	/	/	/
DW (Dual Watch)	/	/	/	/	/	/
Follow-Me SCAN	/	/	/	/	/	/
Follow-Me DW	/	/	/	/	/	/
LOW	/	/	/	/	/	/
TA (Talk Around)	/	/	/	/	/	/
TA SCAN	/	/	/	/	/	/
Encryption*	/	/	/	/	/	/
Emergency	/	/	/	/	/	/
RESET	/	/	/	/	/	/
CALL 1	/	/	/	/	/	/
CALL 2	/	/	/	/	/	/
CALL 3	/	/	/	/	/	/
DTMF CODE SET	/	/	/	/	/	/
Code Up	/	/	/	/	/	/
Code Down	/	/	/	/	/	/
Code SET	/	/	/	/	/	/
Speed Dial	/	/	/	/	/	/
Public Address	/	/	/	/	/	/
EXT. ACC1	/	/	/	/	/	/
EXT. ACC2	/	/	/	/	/	/
Direct CH#1	/	/	/	/	/	/
Direct CH#2	/	/	/	/	/	/
AF Min Vr	/	/	/	/	/	/
Lone Worker	/	/	/	/	/	/
HA (Horn Alert)	/	/	/	/	/	/
Key Lock	/	/	/	/	/	/
SET	/	/	/	/	/	/

※: Requires optional unit

ADVANCED OPERATION

Description of Operating Functions

MONITOR (MONI)

Press (or press and hold) the assigned programmable key to cancel CTCSS- and DCS-controlled squelch; the **TX/BUSY** indicator will glow green

SQUELCH (SQL) OFF

Press (or press and hold) the assigned programmable key to open the SQL to hear background noise (unmute the audio); the **TX/BUSY** indicator will blink green.

SQUELCH (SQL) SET

You can manually adjust the squelch level using this function:

- Press (or press and hold) the assigned programmable key. A tone will sound, and the current squelch level appears on the display.
- Press the [▼]/[▲] button to select the desired squelch level.
- Press this key again. A tone will sound, and the display will revert to the normal channel indication.

DIMMER

Press (or press and hold) the assigned programmable key to select the brightness level of the display. Available selections are four levels.

CHANNEL UP/DOWN

Press (or press and hold) the assigned programmable key (generally the [▼]/[▲] button) to select a different channel within the current group.

CC UP/DOWN (CONTINUOUS CH UP/DOWN)

Press and holding in the assigned programmable key causes the radio to begin stepping (repeatedly) upward or downward through the channels.

ZONE UP/DOWN

Press (or press and hold) the assigned programmable key to select a different zone of channels.

ADVANCED OPERATION

CHANNEL SCAN (SCAN)

The Scanning feature is used to monitor multiple channels programmed into the transceiver. While scanning, the transceiver will check each channel for the presence of a signal, and will stop on a channel if a signal is present.

To activate scanning:

- Press (or press and hold) the assigned programmable key to activate scanning on the current group.
- The scanner will search the programmed channels, looking for active ones; it will pause each time it finds a channel on which someone is speaking.
- Press (or press and hold) the assigned programmable key again to disable scanning. Operation will revert to the programmed revert channel.

Note: Your dealer may have programmed your radio to stay on one of the following channels:

- Current channel (“Talk Back”)
- “Last Busy” channel
- “Priority” channel
- “Scan Start” channel

SCAN SET

Press (or press and hold) the assigned programmable key to delete the Current Memory channel from the Scanning. When you delete a Group or channel, “- SKIP -” will appear on the LCD for one second after pressing the assigned programmable key. To restore a particular channel to your scanning list, press (or press and hold) the assigned programmable key again; “- STOP -” will appear on the LCD for one second after pressing the assigned programmable key.

ZONE SCAN

The Scanning feature is used to monitor multiple channels programmed into the transceiver. While scanning, the transceiver will check each channel of the programmed zone for the presence of the signal, and will stop on a channel if a signal is present.

Press (or press and hold) the assigned programmable key to activate the scanning on the selected zones.

ADVANCED OPERATION

ZONE SCAN SET

You may wish to have the Scanner pass through more than one Zone during the scanning process (normally, scanning is performed within the current zone only). **To include the current Zone in the scanning loop**, press (or press and hold) the assigned programmable key. **To remove a Zone from Zone Scan**, press (or press and hold) the assigned programmable key again.

DUAL WATCH (DW)

The Dual Watch feature is similar to the SCAN feature, except that only two channels are monitored:

- The current operating channel; and
- The Priority channel.

To activate Dual Watch:

- Press (or press and hold) the assigned programmable key.
- The scanner will search the two channels; it will pause each time it finds a channel on which someone is speaking.

To stop Dual Watch:

- Press (or press and hold) the assigned programmable key.
- Operation will revert to the “Dual Watch Start” channel.

FOLLOW-ME SCAN

“Follow-Me” Scan feature checks a User-assigned Priority Channel regularly as you scan the other channels. Thus, if only Channels 1, 3, and 5 (of the 8 available channels) are designated for “Scanning,” the user may nonetheless assign Channel 2 as the “User-assigned” Priority Channel via the “Follow-Me” feature.

To activate “Follow-Me” scanning, first select the channel you want to designate as the “User-Assigned Priority Channel” and press (or press and hold) the assigned programmable key. Then press (or press and hold) the Channel Up/Down key (generally the [▼]/[▲] button) to recall to the “Scanning Start” channel which has been programmed by your dealer to activate the scanner. When the scanner stops on an “Active” channel, the User-assigned Priority Channel will automatically be checked every few seconds; if activity is found on the User-assigned Priority Channel, the radio will switch between it and the Dealer-Assigned Priority Channel, if any.

ADVANCED OPERATION

FOLLOW-ME DUAL WATCH (DW)

To set up a “Dual Watch” frequency pair using the “Follow-Me” feature, select a channel using the Channel Up/Down key (generally the [▼]/[▲] button). Now press (or press and hold) the assigned programmable key; pressing the assigned programmable key locks the current channel as the User-assigned Priority Channel. Now press (or press and hold) the Channel Up/Down key to select another channel (not the “Scanning Start” channel). Your radio will now switch back-and-forth between the currently-selected channel and the User-assigned Priority Channel.

During “Follow-Me” scanning (after you have pressed the key), you can set up the “Dual Watch” feature by pressing (or press and holding) the Channel Up/Down key to another channel. The radio will then scan back and forth between the original User-assigned Priority Channel and the newly-selected channel.

The Priority Channel you have assigned (before pressing the key) will be retained in memory until you change it.

LOW POWER (LOW)

Press (or press and hold) the assigned programmable key to set the radio’s transmitter to the “Low Power” mode. Press (or press and hold) the key again to return to “High Power” operation when in difficult terrain.

When the radio’s transmitter is set to “Low Power” mode, the “**Low**” icon will be indicated on the display.

TALK AROUND (TA)

Press (or press and hold) the assigned programmable key to activate the Talk Around feature when you are operating on duplex channel systems (separate receive and transmit frequencies, utilizing a “repeater” station). The Talk Around feature allows you to bypass the repeater station and talk directly to a station that is nearby. This feature has no effect when you are operating on “simplex” channels, where the receive and transmit frequencies are already the same.

When the “TA” function is activated, the “” icon will be indicated on the display.

Note that your dealer may have mode provision for “Talk Around” channels by programming “repeater” and “Talk Around” frequencies on two adjacent channels. If so, the key may be used for one of the other Pre-Programmed Functions.

ADVANCED OPERATION

TA SCAN

The “TA SCAN” is one of “DW Scan” between Rx and Tx frequency. It works the Rx channel as priority channel and the radio will always transmit on the Tx Channel if the PTT is pressed in the TA SCAN mode.

Press (or press and hold) the assigned programmable key to activate/deactivate the TA SCAN feature.

ENCRYPTION (OPTION)

When the Voice Scrambler feature is enabled, press (or press and hold) the assigned programmable key to toggle the voice encryption on and off.

When the Voice Scrambler feature is activated, the “” icon will be indicated on the display.

EMERGENCY

The **VX-4600** series include an “Emergency” feature which may be useful if you have someone monitoring on the same frequency as your transceiver’s channel.

Press (or press and hold) the assigned programmable key to initiate an emergency call. For further details contact your Vertex Standard dealer.

RESET

Press (or press and hold) the assigned programmable key to reset the RFC (Ready for Communication) condition, or to reset the keypad entry condition.

CALL 1 TO CALL 3

Press (or press and hold) the assigned programmable key to send a 2-Tone or 5-Tone sequential burst which is pre-defined.

DTMF CODE SET

Press (or press and hold) the assigned programmable key to start storing the DTMF dialing sequence. After completion to enter all DTMF digits, you can transmit the codes by pressing the **PTT** key.

CODE UP/DOWN

Press (or press and hold) the assigned programmable key to select a 2-Tone or 5-Tone encode code from pre-defined encode list.

ADVANCED OPERATION

CODE SET

Press (or press and hold) the assigned programmable key to change the 5-Tone encoding digit. To change the tones, select the desired digit using the [P1]/[P2] keys, then change the number using the [▼]/[▲] keys.

SPEED DIAL

Your Dealer may have pre-programmed Auto-Dial telephone number memories into your radio.

To dial a number, press (or press and hold) the assigned programmable key, then press the microphone's key corresponding to the Auto-Dial memory number list provided by your Dealer if the keypad microphone is using, or press the **PTT** key if the normal (without keypad) microphone is using. The DTMF tones sent during the dialing sequence will be heard in the speaker.

PUBLIC ADDRESS

Press (or press and hold) the assigned programmable key to use the transceiver as a PA amplifier. When you enable this function, a tone sounds and "PUBLIC A" will appear on the display. The public address can be used even while scanning and receiving a call.

EXT. ACC1

Press (or press and hold) the assigned programmable key to toggle output port on "1" "on" and "off."

EXT. ACC2

Press (or press and hold) the assigned programmable key to toggle output port on "2" "on" and "off."

DIRECT CH#1/CH#2

Press (or press and hold) the assigned programmable key to recall the Dealer pre-programmed channel directly.

ADVANCED OPERATION

AF MIN VR

Press (or press and hold) the assigned programmable key to reduce the audio output to the (lower) level programmed by your Dealer.

LONE WORKER

Press (or press and hold) the assigned programmable key to toggle the Lone Worker feature “On” and “Off.”

The Lone Worker feature is designed to emit an alarm for 30 seconds when the Lone Worker Timer (programmed by your Dealer) has expired. If the user does not reset the timer by pressing the PTT switch, the radio switches to the Emergency mode.

To revive the radio from the Emergency mode, just press (or press and hold) the programmable key which is assigned the Emergency feature or turn off the radio.

HA (HORN ALERT)

Press (or press and hold) the assigned programmable key to turn the Horn Alert function “ON” or “OFF.” If you receive a call from the base station with 2-Tone, 5-Tone or DTMF signaling, horn alert will be activated and your vehicles horn will sound.

When you turn the Horn Alert “ON,” a tone will sound and the “HORN ALT” will appear on the display.

KEY LOCK

Press (or press and hold) the assigned programmable key to lock the various aspects of the **VX-4600**'s keys. The precise lockout configuration must be programmed by your Vertex Standard dealer.

SET

Press the assigned programmable key to activate the “User Set” (Menu) Mode.

ADVANCED OPERATION

ARTS™ (Auto Range Transpond System)

This system is designed to inform you when you and another ARTS™-equipped station are within communication range.

During ARTS™ operation, when the radio receives an incoming ARTS™ signal, a short beep will sound, and “**IN SVC**” (“In Service”) will be displayed on the LCD for 2 seconds. If you move out of range for more than two minutes, your radio senses that no signal has been received; a short triple-beep will sound, and “**OUT SVC**” (“Out of Service”) will be displayed on the LCD for 2 seconds. If you subsequently move back into communication range, as soon as the other station transmits, a short beep will sound and “**In**” will be displayed again on the LCD for 2 seconds.

DTMF Paging System

(Requires the optional FVP-25 Encryption/DTMF Pager Unit)

This system allows paging and selective calling, using DTMF tone sequences.

When your radio is paged by a station bearing a tone sequence which matches yours, your radio’s squelch will open and the alert will sound. The three-digit code of the station which paged you will be displayed on your radio’s LCD.

USER SET MODE

The **VX-4600** Series includes a “User Set” (Menu) Mode which allows the user to define or configure various settings, such as Squelch, Display contrast, etc. To activate the “User Set” (Menu) Mode:

- Press the programmable key assigned to the “**SET**” function.
- Select the User Set Mode item you wish to change using the [**P1**]/[**P2**] keys, then use the [**▼**]/[**▲**] keys to adjust the setting of the selected item.
- Press the [**P1**] or [**P2**] key to store the new configuration.
- Press the programmable key assigned to the “**SET**” function to exit to normal operation.

DISPLAY	DESCRIPTION
SQL	Sets the Squelch level.
BEEP	Enables/Disables the Key Beeper.
BELL	Enables/Disables the Bell function. (alert tone activated by incoming subaudible CTCSS/DCS tone)
LIGHTING	Enables/Disables the BUSY/TX LED.
GROUP	Select the desired Channel Group.
SCAN	Engages/Disengages Scanning (same as the programmable [SCAN] key).
DW	Engages/Disengages Dual Watch (same as the programmable [DW] key).
TA	Engages/Disengages Talk Around (same as the programmable [TA] key).
ENCRYPT*	Enables/Disables the disabling the Encryption Unit temporarily. ENB: Enables the disabling the Encryption Unit. DIS: Disables the disabling the Encryption Unit.
AF MINVR	Sets the minimum Audio Volume level.
BEEP VR	Sets the Beep Volume level.
CONTRAST	Sets the LCD Contrast level.
DIMMER	Sets the brightness of the LCD backlighting.

※: Requires optional unit

Part 15.21: Changes or modifications to this device not expressly approved by Vertex Standard could void the user's authorization to operate this device.



Copyright 2010
VERTEX STANDARD CO., LTD.
All rights reserved.

Printed in Japan

No portion of this manual
may be reproduced
without the permission of
VERTEX STANDARD CO., LTD.