REPORT ON
Radio testing of the VERTEX STANDARD VX-2100-G7-25 / VX-2200-G7-25
In accordance with ANSI/TIA/EIA-603, RSS-119

Report number TA000446

January 2007

GENERAL INFORMATION

MODEL NAME:	VX-2100-G7-25 / VX-2200-G7-25	
FCC ID:	K6610614730	
MANUFACTURER:	Vertex Standard Co., Ltd.	
TRADE NAME:	VERTEX STANDARD	
EUT DESCRIPTION:	UHF FM Transceiver	
SERIAL NUMBER:	7C000001	
VOLTAGE REQUIREMENTS:	13.6	[V]
	DC	
NUMBER OF CHANNELS:	501	
SPECIFICATION ARE REFERENCED:	ANSI/TIA/EIA-603	
	RSS-119	

TRANSMITTERS

TYPE OF EMISSION:	16K0F3E , 11K0F3E	
FREQUENCY RANGE:	450 to 512	[MHz]
POWER OUTPUT RATING:	1 to 25	[W]
	<input type="checkbox"/> Switchable	
	<input checked="" type="checkbox"/> Variable	
	<input type="checkbox"/> N/A	

RECEIVERS

MAXIMUM POWER RATING:	300	[W]
INPUT IMPEDANCE (MIC):	600	[Ω]
OUTPUT IMPEDANCE (RF):	50	[Ω]
Collector Voltage:	13.6	[V]
Collector Current:	6	[A]

FREQUENCY RANGE:	450 to 512	[MHz]
INTERMEDIATE FREQUENCIES:	1st -67.65	[MHz]
	2nd -450	[kHz]
INPUT IMPEDANCE (RF):	50	[Ω]
OUTPUT IMPEDANCE (SP):	4	[Ω]
AUDIO OUTPUT POWER:	12	[W]

This report was prepared by Vertex Standard Co., Ltd.

Test performed by M.Kurihara

Date 17 / January /2007

VX-2100-G7-25 / VX-2200-G7-25 Channel Settings

CH No.	Shown on LCD	Transmit Frequency [MHz]	Receive Frequency [MHz]	CH Spacing	Power	
					High	Low
1	450M WH	450.000	450.000	25k	25W	
2	481M WH	481.000	481.000	25k	25W	
3	512M WH	512.000	512.000	25k	25W	
4	450M NH	450.000	450.000	12.5k	25W	
5	481M NH	481.000	481.000	12.5k	25W	
6	512M NH	512.000	512.000	12.5k	25W	
7	450M WL	450.000	450.000	25k		1W
8	481M WL	481.000	481.000	25k		1W
9	512M WL	512.000	512.000	25k		1W
10	450M NL	450.000	450.000	12.5k		1W
11	481M NL	481.000	481.000	12.5k		1W
12	512M NL	512.000	512.000	12.5k		1W
13						
14						
15						
16						
17						
18						
19						
20						

NAME OF TEST: R.F. Power Output (Conducted)
SPECIFICATION: 47 CFR 2.1046 (a)
GUIDE: ANSI/TIA/EIA-603, Paragraph 2.2.1
TEST EQUIPMENT: As per attached page

MEASUREMENT PROCEDURE

1. The EUT was connected to a resistive coaxial attenuator of normal load impedance, and the modulated output power was measured by means of an R.F. power meter.
2. Measurement accuracy is $\pm 4\%$

MEASUREMENT RESULTS

NOMINAL, MHz	CHANNEL	R.F. POWER, WATTS	
		LOW	HIGH
450.000	1	1.040	23.980
481.000	2	1.100	26.120
512.000	3	1.050	25.400

TRANSMITTER POWER CONDUCTED MEASUREMENTS

TEST 1: R.F. POWER OUTPUT
 TEST 2: FREQUENCY STABILITY

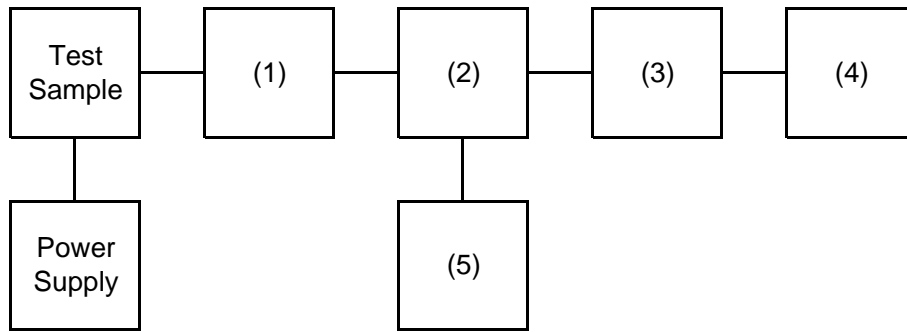

Instruments	Description	Serial Number
(1) COAXIAL ATTENUATOR	WEINSHELL 49-10-43	***
(2) RF COUPLER	ADVANTEST TR4153	***
(3) POWER SENSOR	Agilent 8482B	***
(4) POWER METER	Agilent 8901B POWER MODE	***
(5) FREQUENCY COUNTER	Agilent 8901B FREQUENCY MODI	***

NAME OF TEST: Unwanted Emissions (Conducted)
SPECIFICATION: 47 CFR 2.1051
GUIDE: ANSI/TIA/EIA-603, Paragraph 2.2.13
TEST EQUIPMENT: As per attached page

MEASUREMENT PROCEDURE

1. The emissions were measured for the worst case as follows:
 - (a): within a band of frequencies defined by the carrier frequency plus and minus one channel.
 - (b): from the lowest frequency generated in the EUT and to at least the 10th harmonic of the carrier frequency, or 40GHz, whichever is lower.
2. The magnitude of spurious emissions that are attenuated more than 20dB below the permissible value need not be specified.

3. MEASUREMENT RESULTS:

FREQUENCY OF CARRIER, MHz = 450 , 481 , 512
SPECTRUM SEARCHED, GHz = 0 to 10 x Fc
MAXIMUM RESPONSE, Hz = 2700
ALL OTHER EMISSIONS = >= 20dB BELOW LIMIT

TRANSMITTER SPURIOUS EMISSION

TEST 1: OCCUPIED BANDWIDTH (IN-BAND SPURIOUS)
 TEST 2: OUT-OF-BAND SPURIOUS

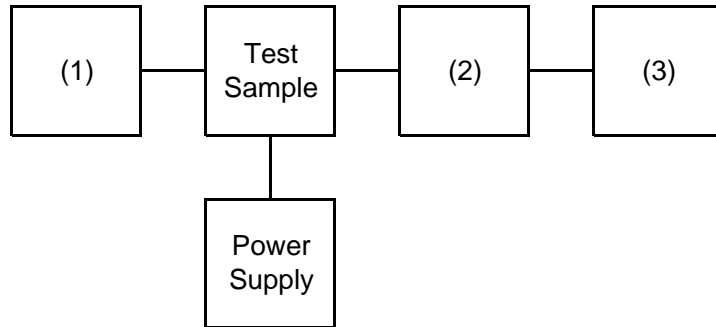

Instruments	Description	Serial Number
(1) AUDIO GENERATOR	Agilent 8903B	***
(2) COAXIAL ATTENUATOR	WEINSHELL 49-10-43	***
(2) COAXIAL ATTENUATOR	Agilent 8498A	***
(3) SPECTRUM ANALYZER	ADVANTEST TR4173	***

NAME OF TEST: Unwanted Emissions (Conducted)

LIMIT'S), dBc: $-(50+10 \times \text{LOG}(P)) = -64$ (25 Watts)
 $-(50+10 \times \text{LOG}(P)) = -50$ (1 Watts)

High Power

FREQUENCY TUNED, MHz	FREQUENCY EMISSION, MHz	LEVEL, dBm	LEVEL, dBc	MARGIN, dB
450.0000	900.0000	-27.0	-71.0	7.0
481.0000	962.0000	-25.7	-69.7	5.7
512.0000	1024.0000	-28.0	-72.0	8.0
450.0000	1350.0000	-34.0	-78.0	14.0
481.0000	1443.0000	-29.7	-73.7	9.7
512.0000	1536.0000	-28.8	-72.8	8.8
481.0000	3367.0000	-28.7	-72.7	8.7
450.0000	3600.0000	-33.6	-77.6	13.6
481.0000	3848.0000	-38.7	-82.7	18.7

NAME OF TEST: Unwanted Emissions (Conducted)

LIMIT'S), dBc: $-(50+10 \times \text{LOG}(P)) = -64$ (25 Watts)
 $-(50+10 \times \text{LOG}(P)) = -50$ (1 Watts)

Low Power

FREQUENCY TUNED, MHz	FREQUENCY EMISSION, MHz	LEVEL, dBm	LEVEL, dBc	MARGIN, dB
450.0000	900.0000	-43.6	-73.6	23.6
481.0000	962.0000	-41.9	-71.6	21.6
512.0000	1024.0000	-43.2	-73.2	23.2
481.0000	1443.0000	-47.4	-77.4	27.4
512.0000	1536.0000	-49.9	-79.9	29.9

NAME OF TEST: Field Strength of Spurious Radiation
SPECIFICATION: 47 CFR 2.1053 (a)
GUIDE: ANSI/TIA/EIA-603, Paragraph 1.2.12

MEASUREMENT PROCEDURE

1.2.12.1 Definition: Radiated spurious emissions are emissions from the equipment when transmitting load on a frequency or frequencies which are outside an occupied band sufficient to ensure transmission of information of required quality for the class of communications desired.

1.2.12.2 Method of measurement

- A) Connect the equipment as illustrated.
- B) Adjust the spectrum analyzer for the following settings:
 - 1) Resolution Bandwidth $\leq 3\text{kHz}$
 - 2) Video Bandwidth $\geq 10\text{kHz}$
 - 3) Sweep Speed $\leq 2000\text{Hz/second}$
 - 4) Detector Mode = Positive Peak
- C) Place the transmitter to be tested on the turntable in the standard test site. The transmitter is transmitting into a non-radiating load which is placed on the turntable. The RF cable to this load should be of minimum length.

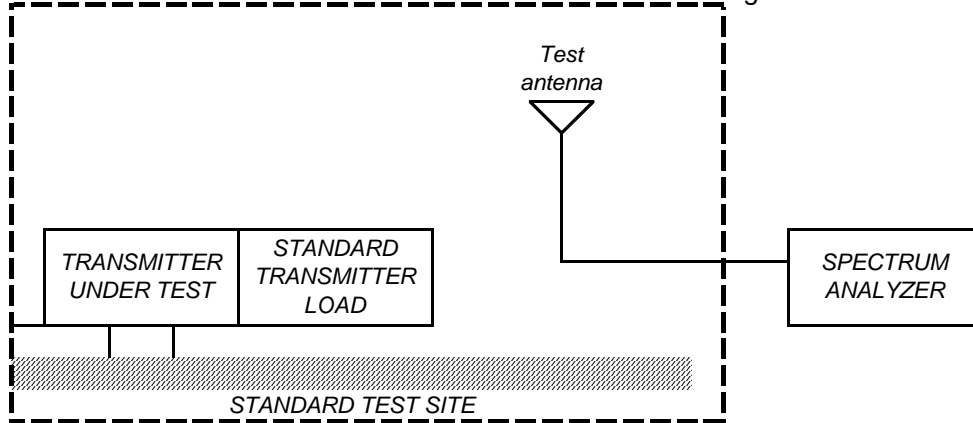

- D) For each spurious measurement the test antenna should be adjusted to the correct length for the frequency involved. This length may be determined from a calibration ruler supplied with the equipment. Measurements shall be made from the lowest radio frequency generated in the equipment to the tenth harmonic of the carrier, except for the region close to the carrier equal to \pm the test bandwidth (see section 1.3.4.4).
- E) For each spurious frequency, raise and lower the test antenna from 1 m to 4 m to obtain a maximum reading on the spectrum analyzer with the test antenna at horizontal polarity.

NAME OF TEST: Field Strength of Spurious Radiation

F) Repeat step E) for each spurious frequency with the test antenna polarized vertically

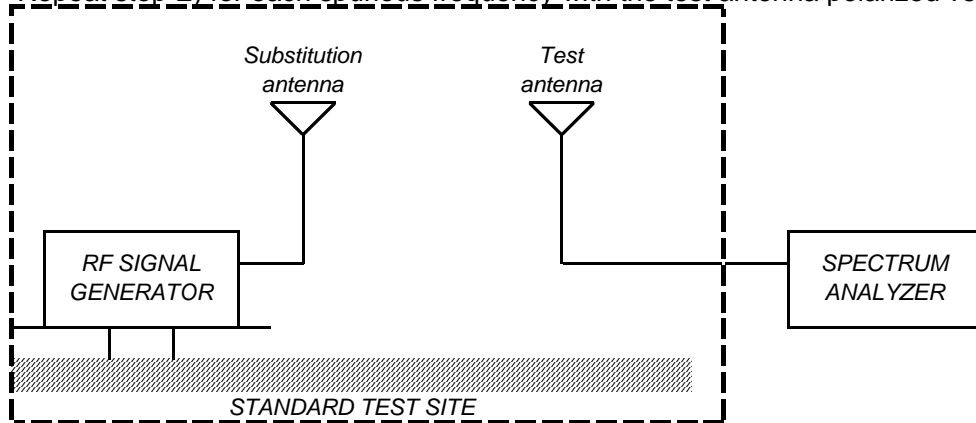

- G) Reconnect the equipment as illustrated.
- H) Keep the spectrum analyzer adjusted as in step B).
- I) Remove the transmitter and replace it with a substitution antenna (the antenna should be half-wavelength for each frequency involved). The center of the substitution antenna should be approximately at the same location as the center of the transmitter. At lower frequencies, where the substitution antenna is very long, this will be impossible to achieve when the antenna is polarized vertically. In such case the lower end of the antenna should be 0.3m above the ground.
- J) Feed the substitution antenna at the transmitter end with a signal generator connected to the antenna by means of a non-radiating cable. With the antennas at both ends horizontally polarized and with the signal generator tuned to a particular spurious frequency, raise and lower the test antenna to obtain a maximum reading at the spectrum analyzer. Adjust the level of the signal generator output until the previous recorded maximum reading for the set of conditions is obtained. This should be done carefully repeating the adjustment of the test antenna and generator output.
- K) Repeat step J) with both antennas vertically polarized for each spurious frequency.
- L) Calculate power in dBm into a reference ideal half-wave dipole antenna by reducing the readings obtained in step J) and K) by the power loss in the cable between the generator and the antenna and further corrected for the gain of the substitution antenna used relative to an ideal half-wave dipole antenna.
- M) The levels recorded in step L) are absolute levels of radiated spurious emissions in dBm. The radiated spurious emissions in dB can be calculated by the following:

Radiated spurious emissions dB = $10\log(\text{TX power in watts}/0.001)$ - the levels in step L)

NAME OF TEST: Field Strength of Spurious Radiation

Note: It is permissible that other antennas provided can be referenced to a dipole.

Instruments	Description	Serial Number
TRANSDUCER	Schaffner-Chase CBL6143	***
TRANSDUCER	EMCO 3115	***
AMPLIFIER	Agilent 8447D	***
AMPLIFIER	Agilent 8449B	***
SPECTRUM ANALYZER	Agilent 8561B	***

NAME OF TEST: Field Strength of Spurious Radiation

LIMIT'S), dBc: $-(50+10 \times \text{LOG}(P)) = -64$ (25 Watts)
 $-(50+10 \times \text{LOG}(P)) = -50$ (1 Watts)

High Power

FREQUENCY TUNED, MHz	FREQUENCY EMISSION, MHz	METER, dBuV	C.F., dB	ERP, dBm	ERP, dBc
450.0000	900.0000	46.0	30.8	-30.2	-74.2
481.0000	962.0000	43.6	30.9	-32.5	-76.5
512.0000	1024.0000	71.1	-2.4	-38.3	-82.3
450.0000	1350.0000	68.9	1.1	-37.0	-81.0
481.0000	1443.0000	70.0	2.0	-35.0	-79.0
512.0000	1536.0000	73.4	2.6	-31.0	-75.0
450.0000	1800.0000	63.8	4.0	-39.2	-83.2
450.0000	2250.0000	63.2	4.8	-39.0	-83.0
481.0000	2405.0000	59.7	12.0	-35.3	-79.3
512.0000	2560.0000	62.0	9.3	-35.7	-79.7
512.0000	3072.0000	56.7	14.3	-36.0	-80.0

NAME OF TEST: Field Strength of Spurious Radiation

LIMIT'S), dBc: $-(50+10 \times \text{LOG}(P)) = -64$ (25 Watts)
 $-(50+10 \times \text{LOG}(P)) = -50$ (1 Watts)

Low Power

FREQUENCY TUNED, MHz	FREQUENCY EMISSION, MHz	METER, dBuV	C.F., dB	ERP, dBm	ERP, dBc
450.0000	900.0000	38.8	30.8	-37.4	-67.4
450.0000	1443.0000	69.8	2.0	-35.2	-65.2
512.0000	1536.0000	72.4	2.6	-32.0	-62.0

NAME OF TEST: Emission Masks (Occupied Bandwidth)
SPECIFICATION: 47 CFR 2.1049 (c) (1)
GUIDE: ANSI/TIA/EIA-603, Paragraph 2.2.11
TEST EQUIPMENT: As per previous page

MEASUREMENT PROCEDURE

1. The EUT and test equipment were set up as shown on the following page, with the spectrum analyzer connected.
2. For EUT's supporting audio modulation, the audio signal generator was adjusted to the frequency of maximum response and with output level set for $\pm 2.5/\pm 1.5$ kHz deviation (or 50% modulation). With level constant, the signal level was increased 16dB.
3. For EUT's supporting digital modulation, the digital modulation mode was operated to its maximum extent.
4. The occupied bandwidth was measured with the spectrum analyzer controls set as shown on the test results.
5. MEASUREMENT RESULTS: ATTACHED

NAME OF TEST: Emission Masks (Occupied Bandwidth)

STATE: 1 : High Power

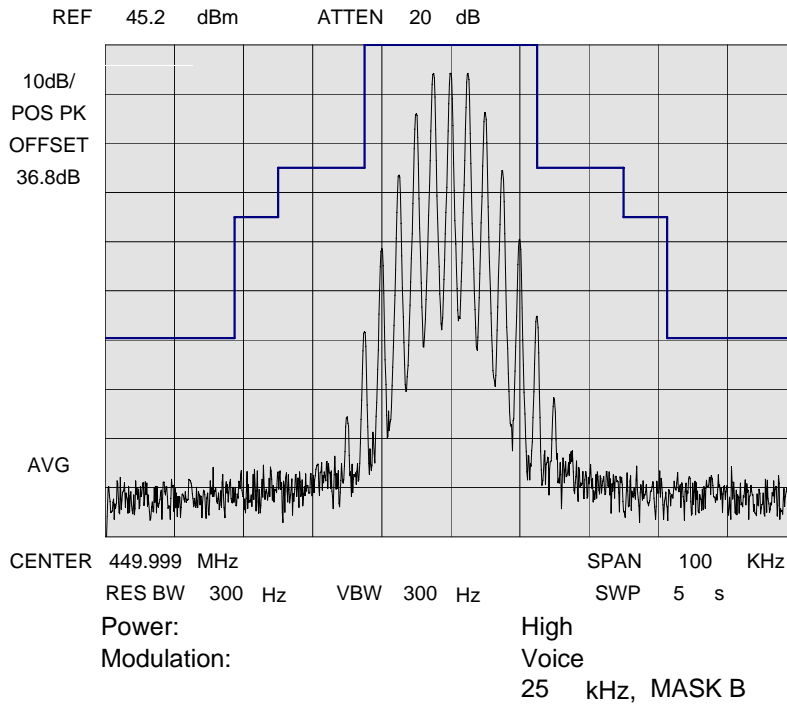
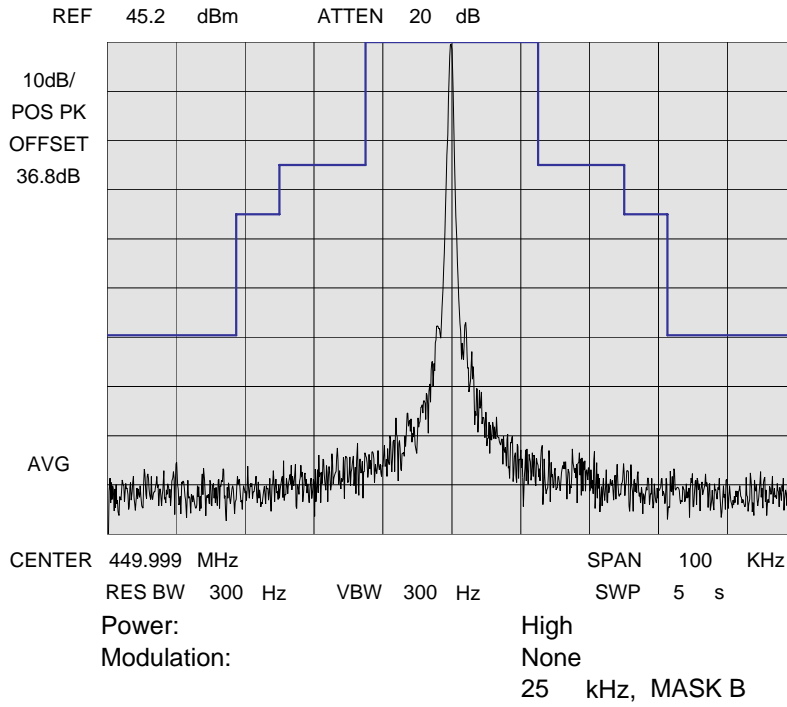

NAME OF TEST: Emission Masks (Occupied Bandwidth)

STATE: 1 : High Power

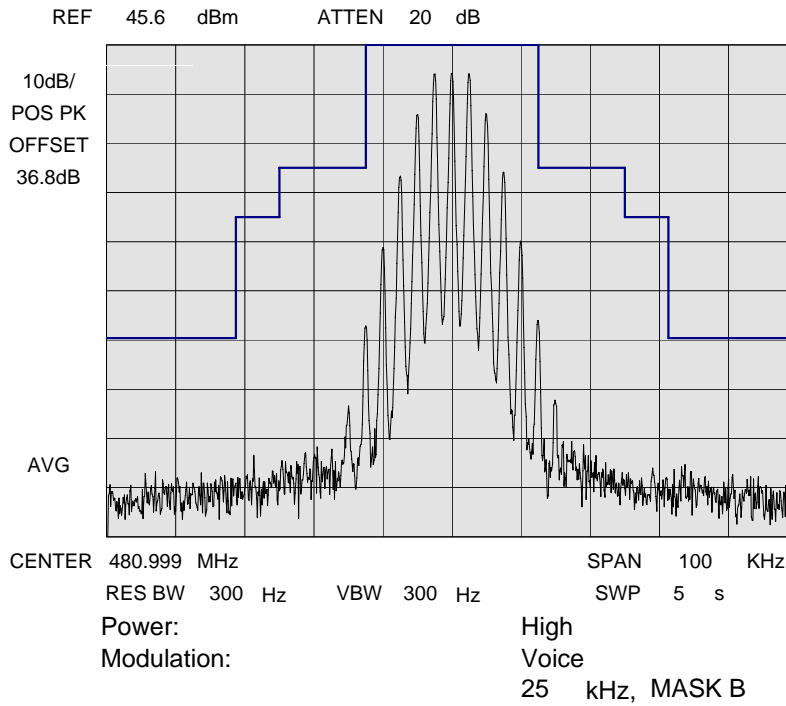
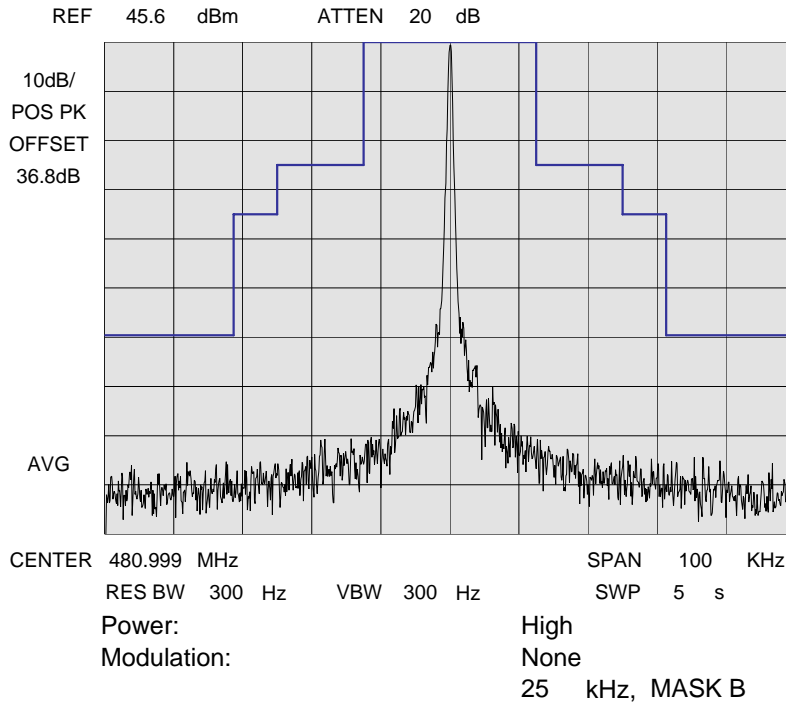

NAME OF TEST: Emission Masks (Occupied Bandwidth)

STATE: 1 : High Power

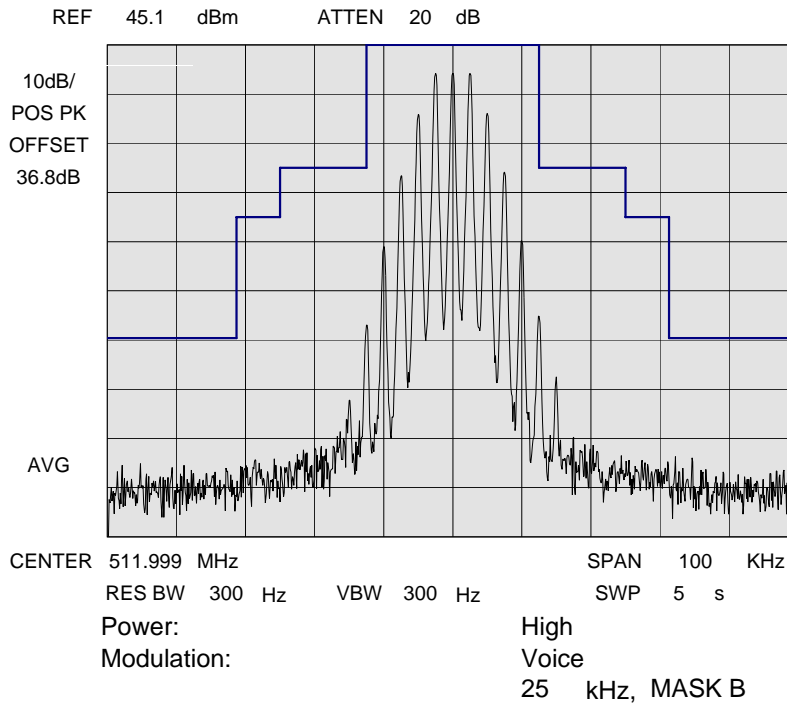
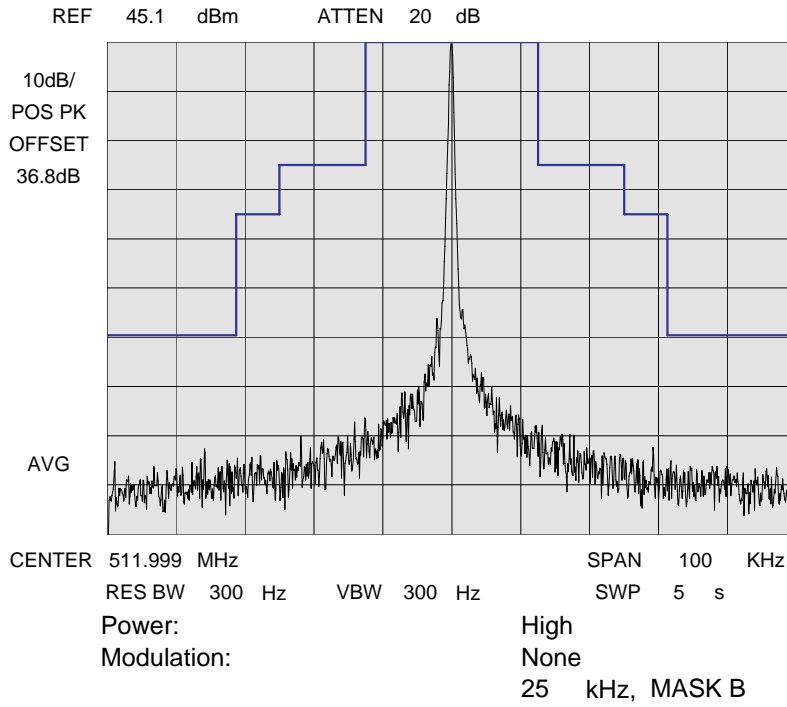

NAME OF TEST: Emission Masks (Occupied Bandwidth)

STATE: 2 : Low Power

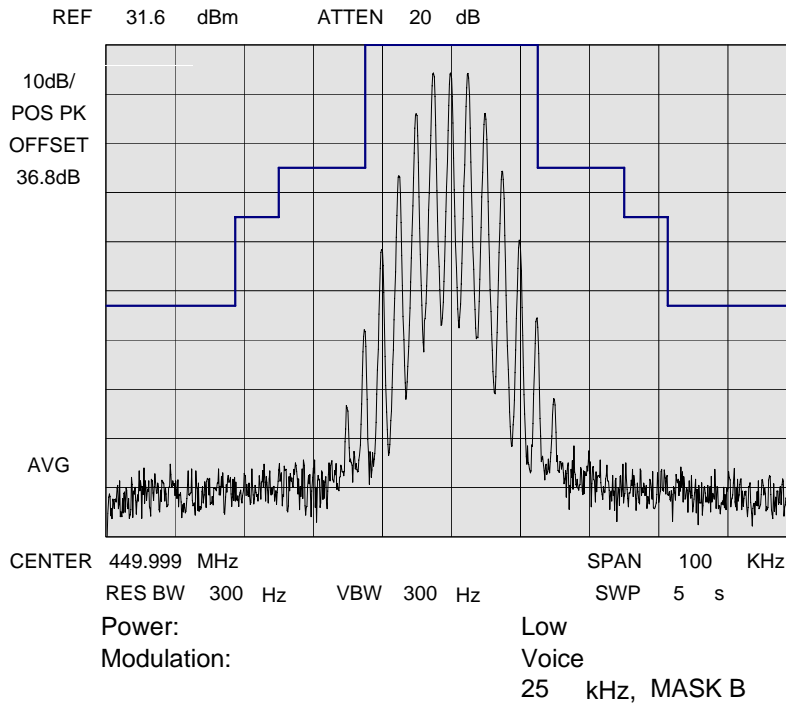
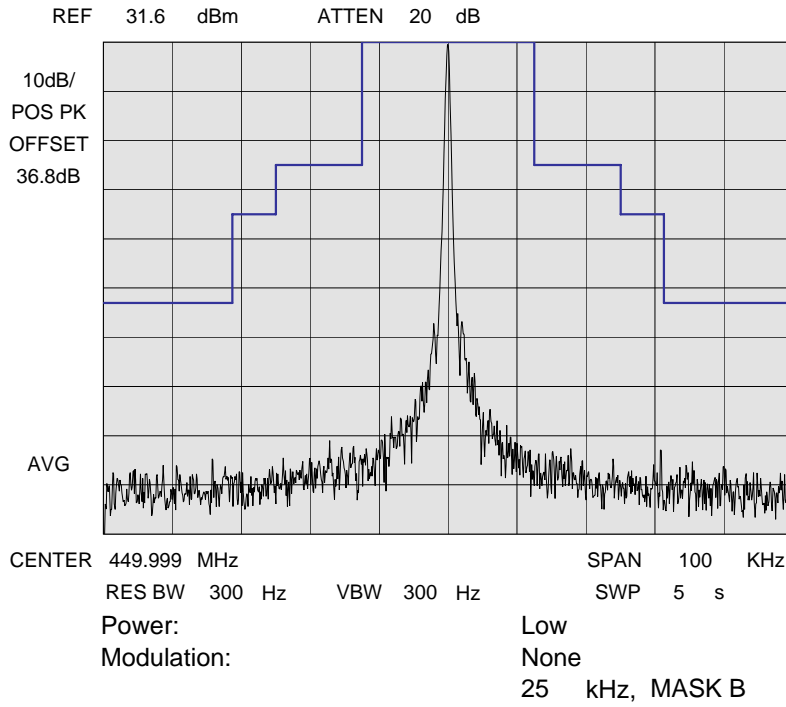

NAME OF TEST: Emission Masks (Occupied Bandwidth)

STATE: 2 : Low Power

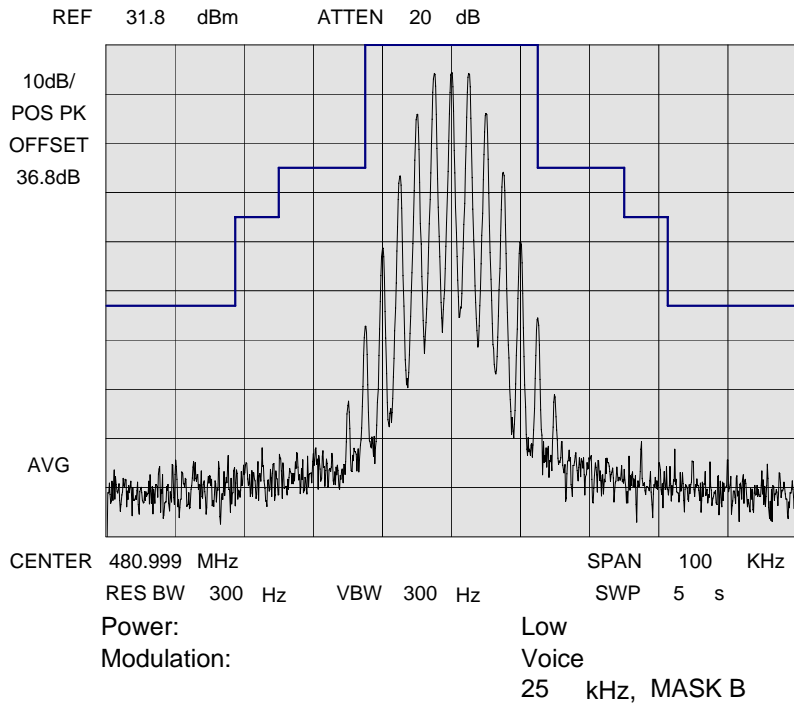
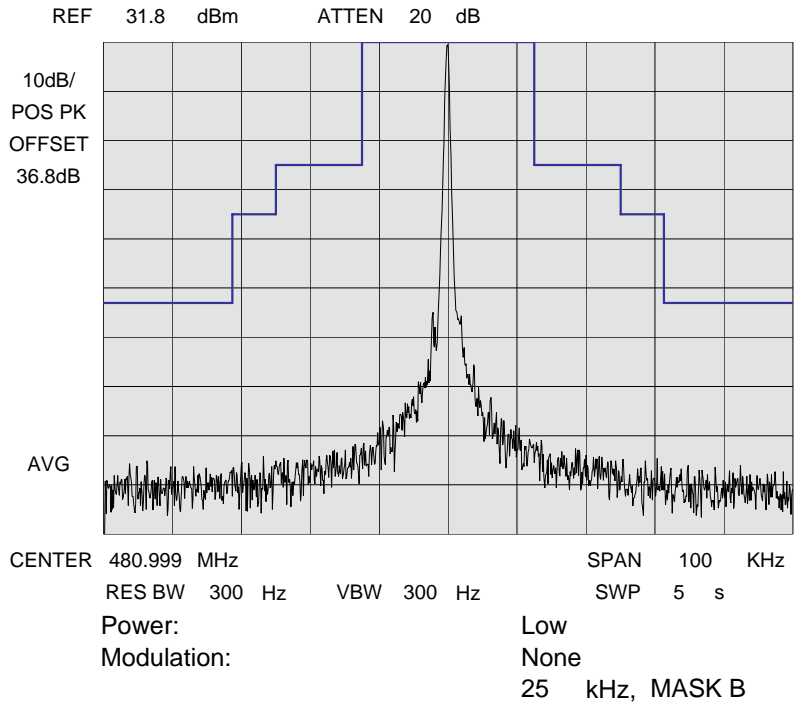

NAME OF TEST: Emission Masks (Occupied Bandwidth)

STATE: 2 : Low Power

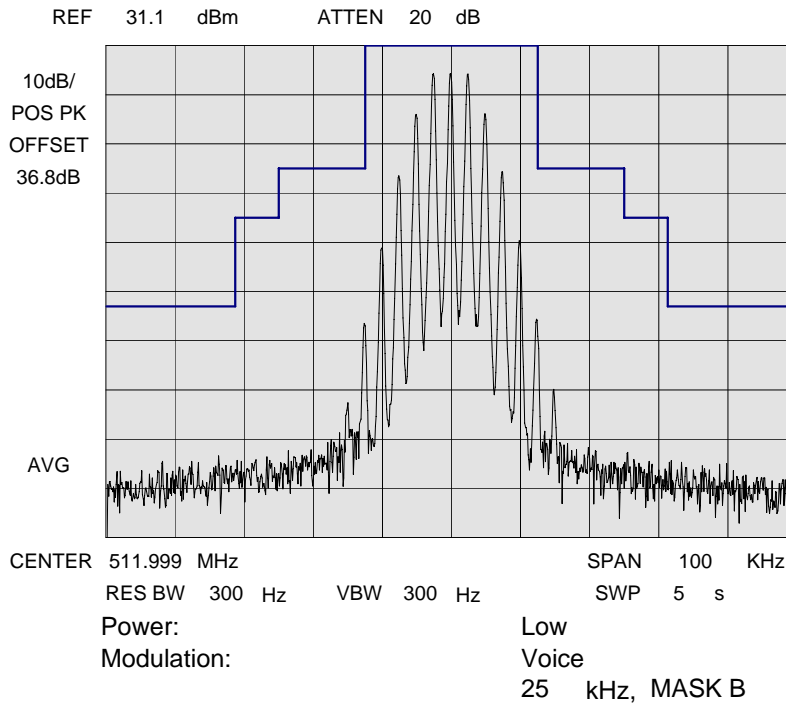
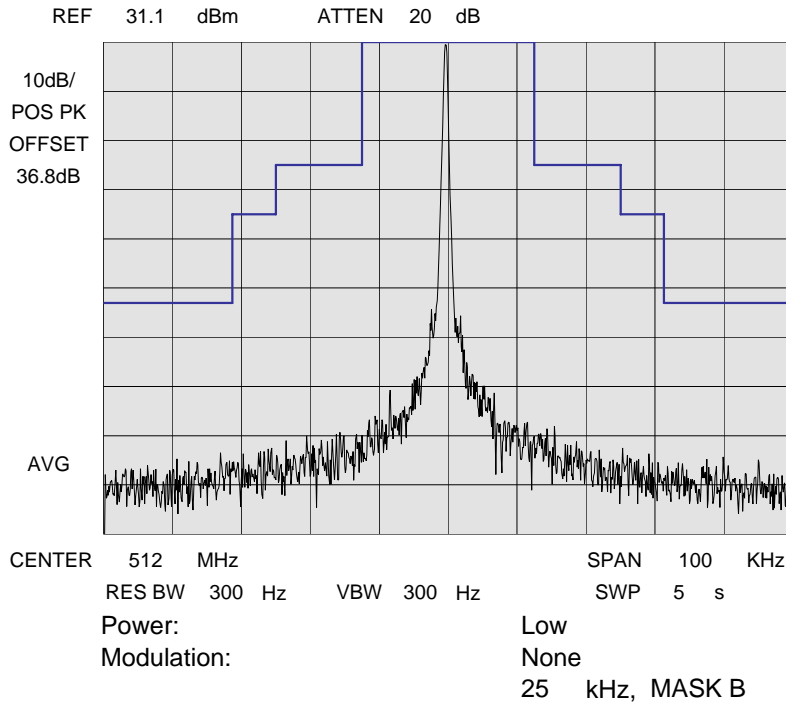

NAME OF TEST: Emission Masks (Occupied Bandwidth)

STATE: 1 : High Power

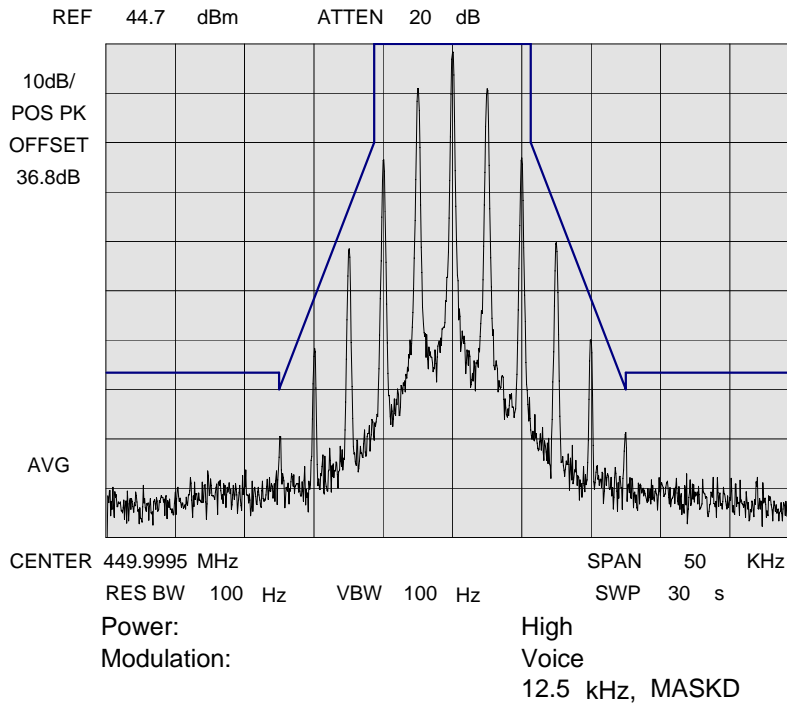
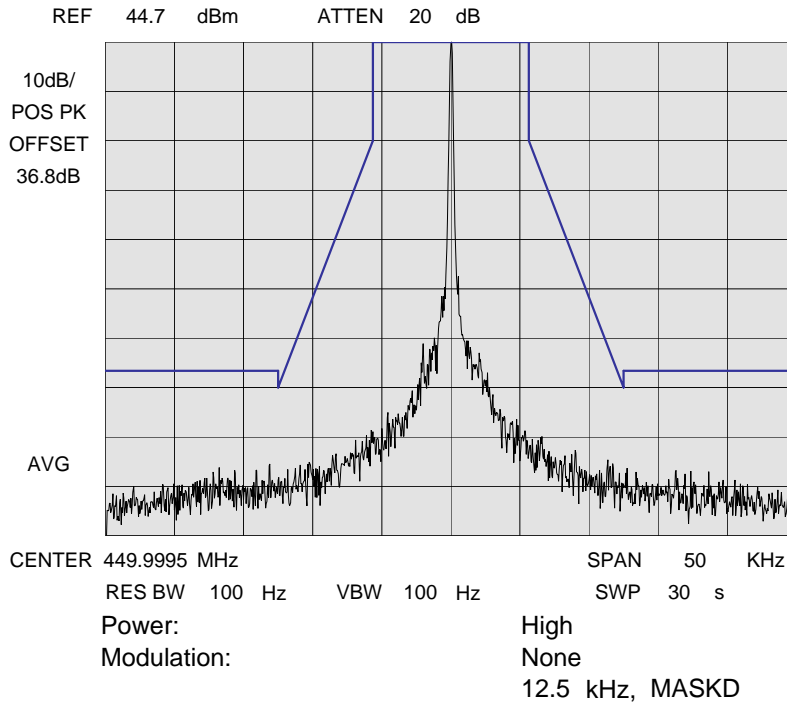

NAME OF TEST: Emission Masks (Occupied Bandwidth)

STATE: 1 : High Power

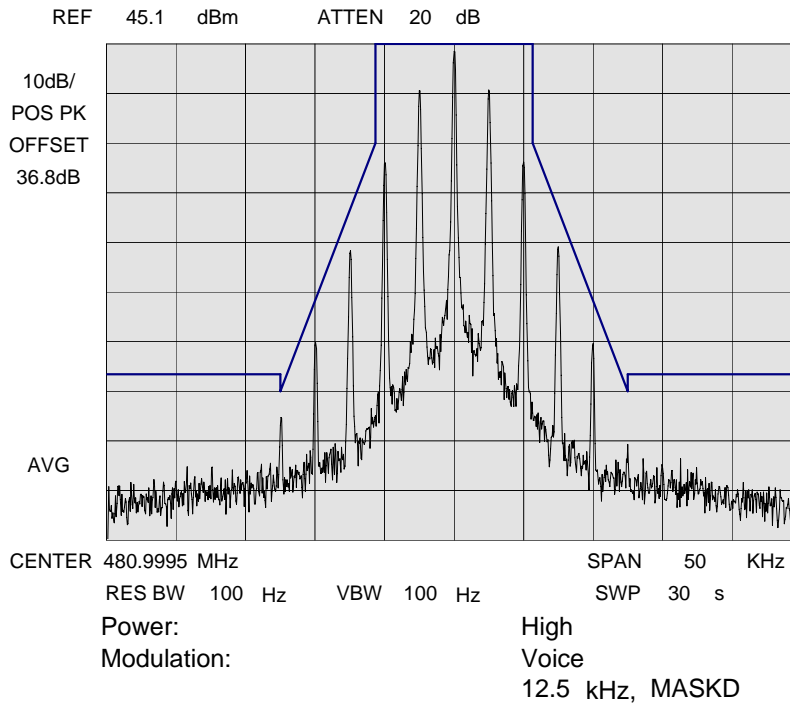
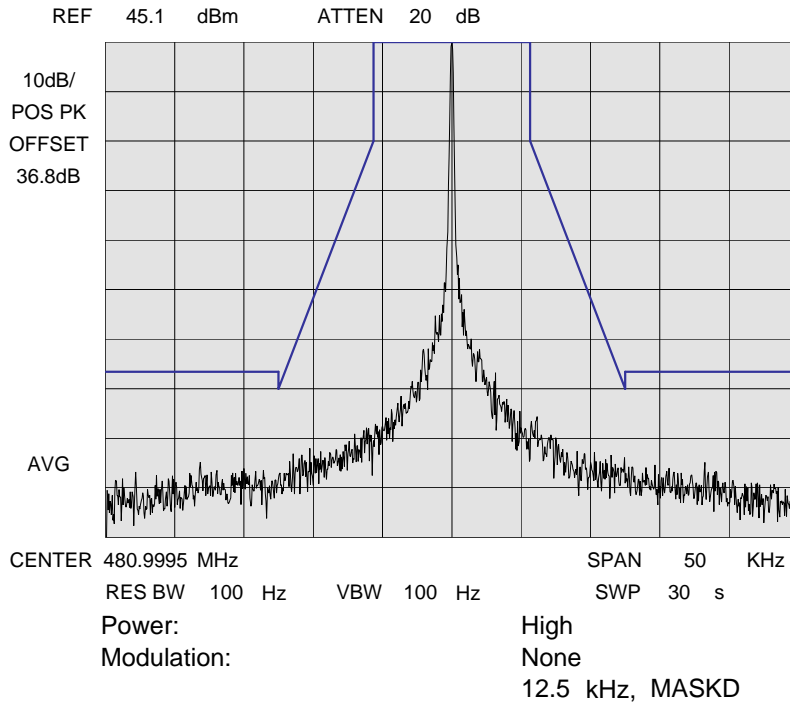

NAME OF TEST: Emission Masks (Occupied Bandwidth)

STATE: 1 : High Power

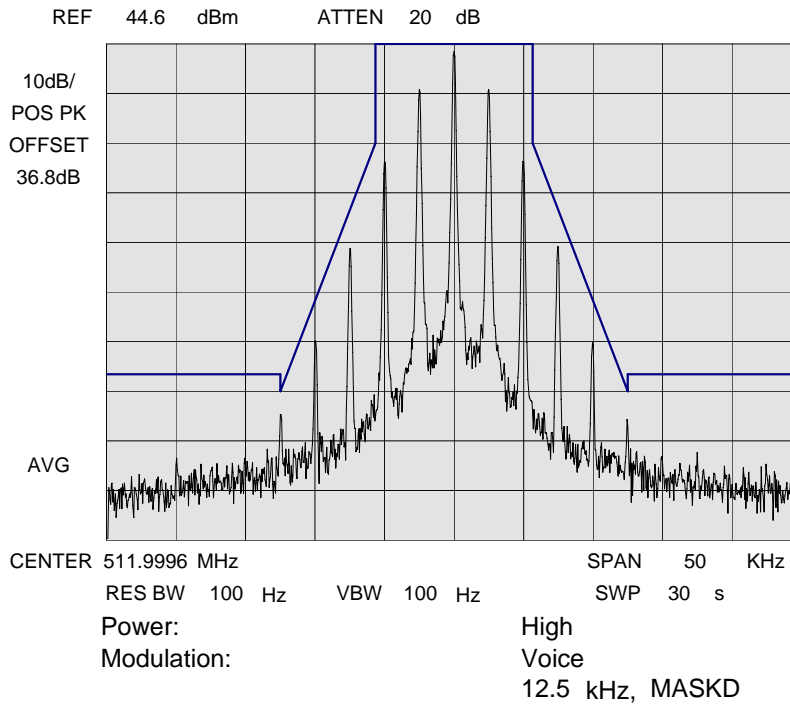
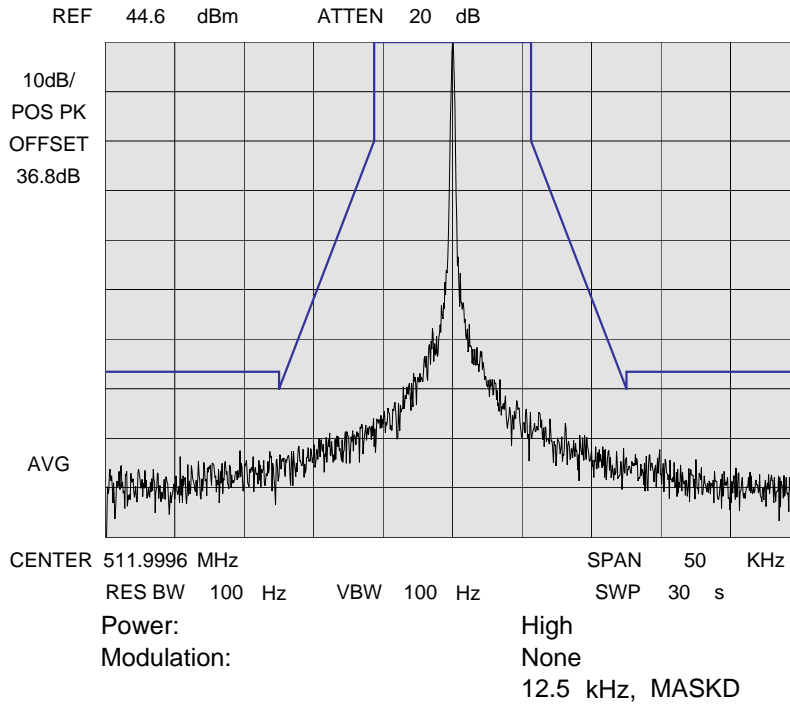

NAME OF TEST: Emission Masks (Occupied Bandwidth)

STATE: 2 : Low Power

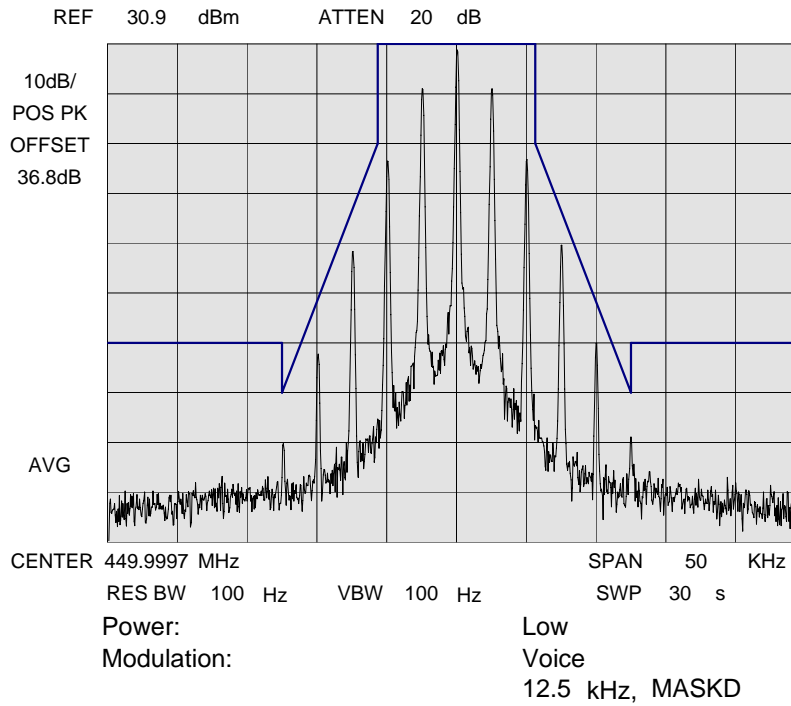
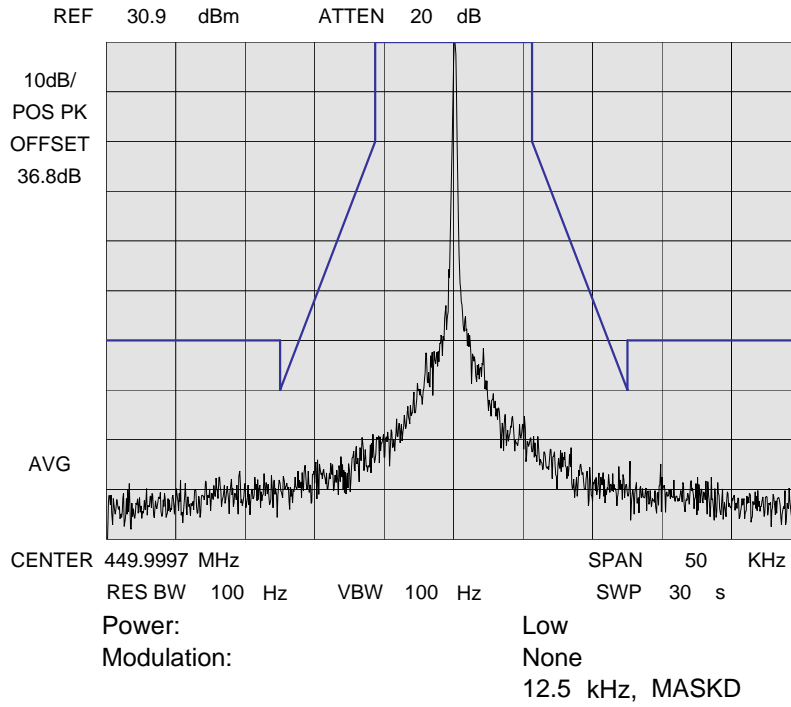

NAME OF TEST: Emission Masks (Occupied Bandwidth)

STATE: 2 : Low Power

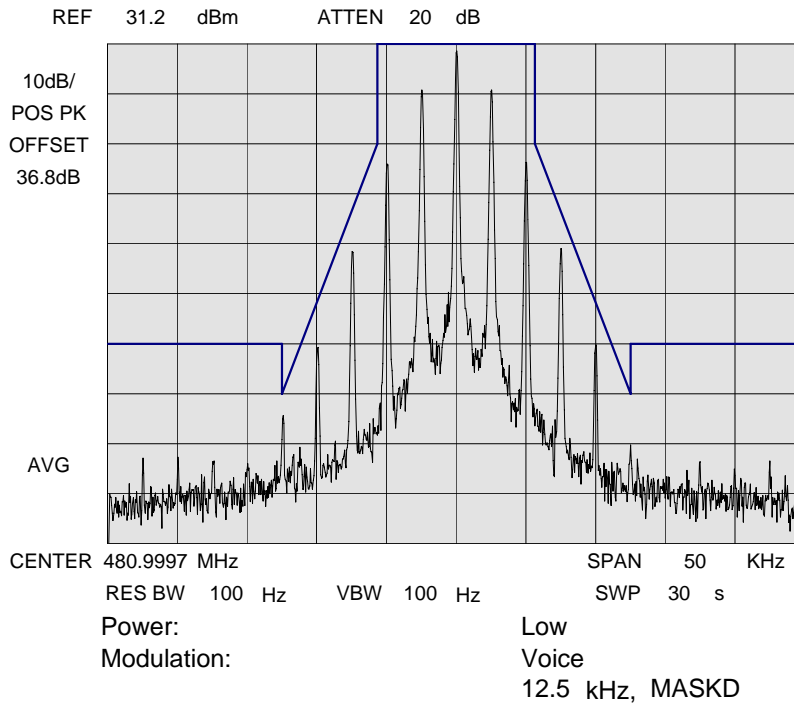
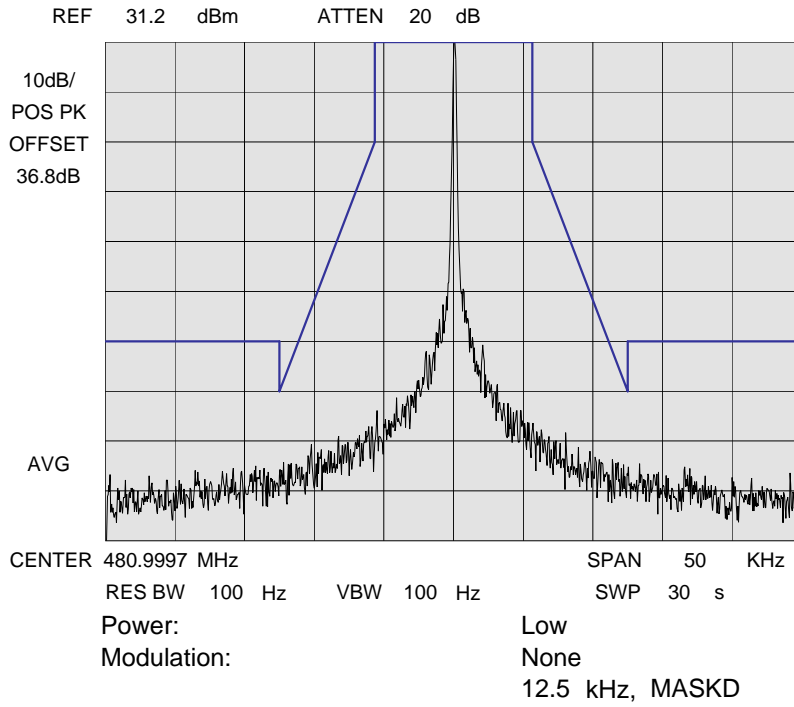

NAME OF TEST: Emission Masks (Occupied Bandwidth)

STATE: 2 : Low Power

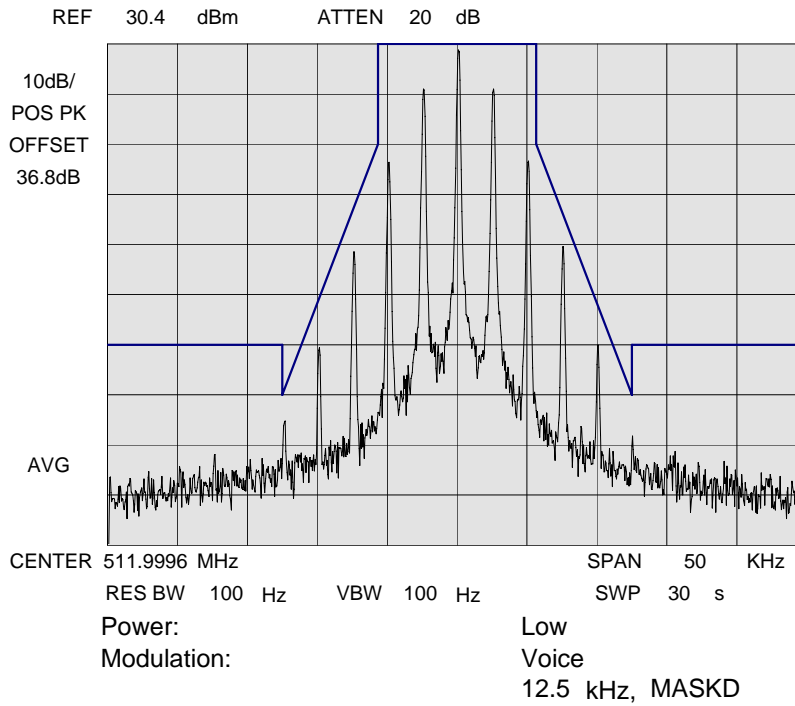
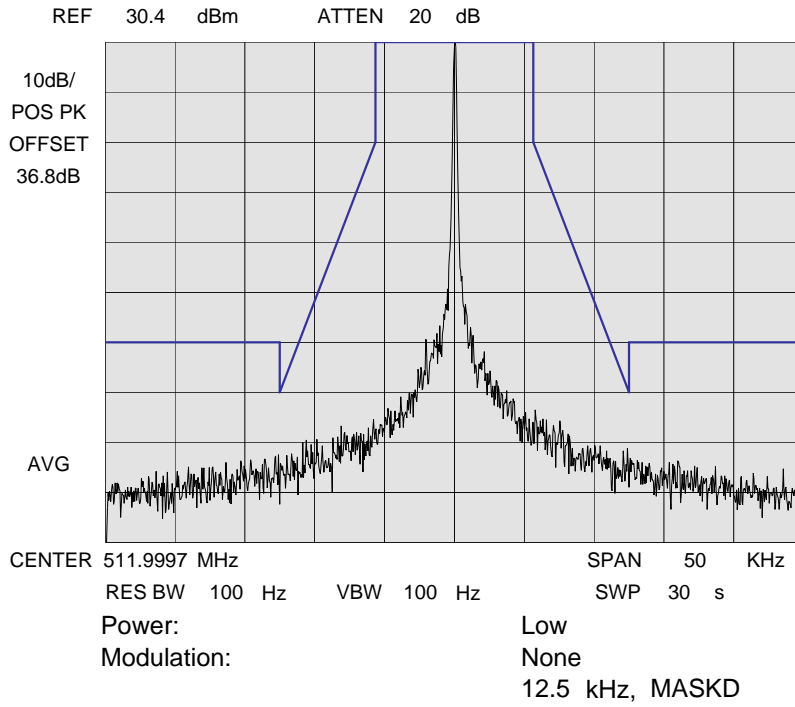

TRANSIENT FREQUENCY BEHAVIOR

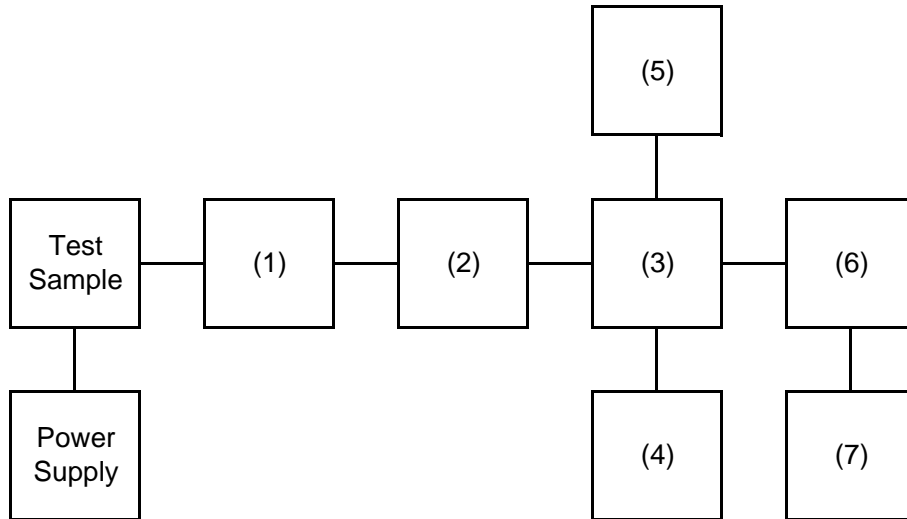

Instruments	Description	Serial Number
(1) COAXIAL ATTENUATOR	WEINSHELL 49-10-43	***
(2) COAXIAL ATTENUATOR	WEINSHELL 49-10-43	***
(3) COMBINER	IWATSU B-504D	***
(4) CRYSTAL DETECTOR	Agilent 8470B	***
(5) RF SIGNAL GENERATOR	Agilent 8642B	***
(5) MODULATION ANALYZER	Agilent 8901B	***
(5) SCOPE	Agilent 54504A	***

NAME OF TEST: Transient Frequency Behaviour

STATE: 1 : High Power

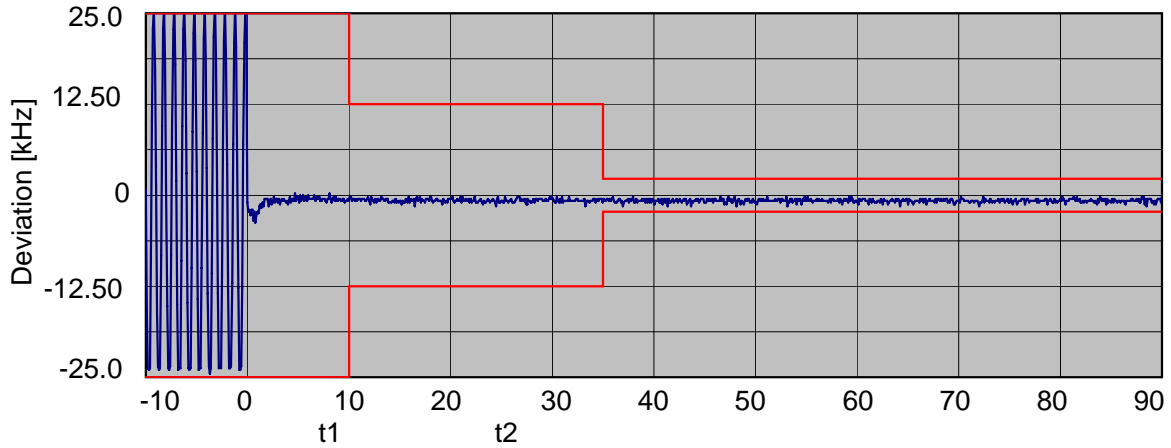

Model Name:	VX-2200-G7-25	Type:	Mobile/Portable
Serial Number:	7C000001	Trigger Direction:	Rise
Test Frequency:	450	Ref. Standard	EIA
Channel Spacing:	25		

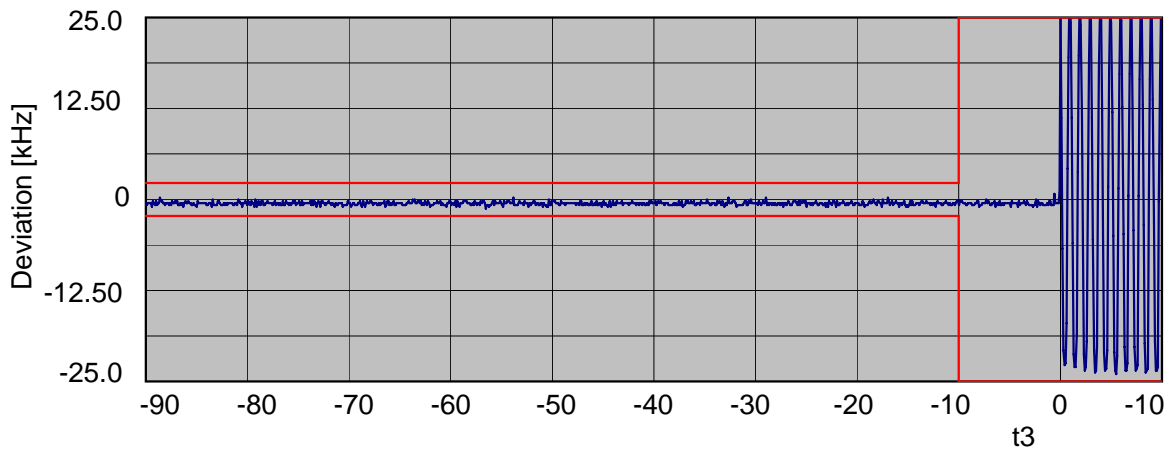

Model Name:	VX-2200-G7-25	Type:	Mobile/Portable
Serial Number:	7C000001	Trigger Direction:	Fall
Test Frequency:	450	Ref. Standard	EIA
Channel Spacing:	25		

NAME OF TEST: Transient Frequency Behaviour

STATE: 1 : High Power

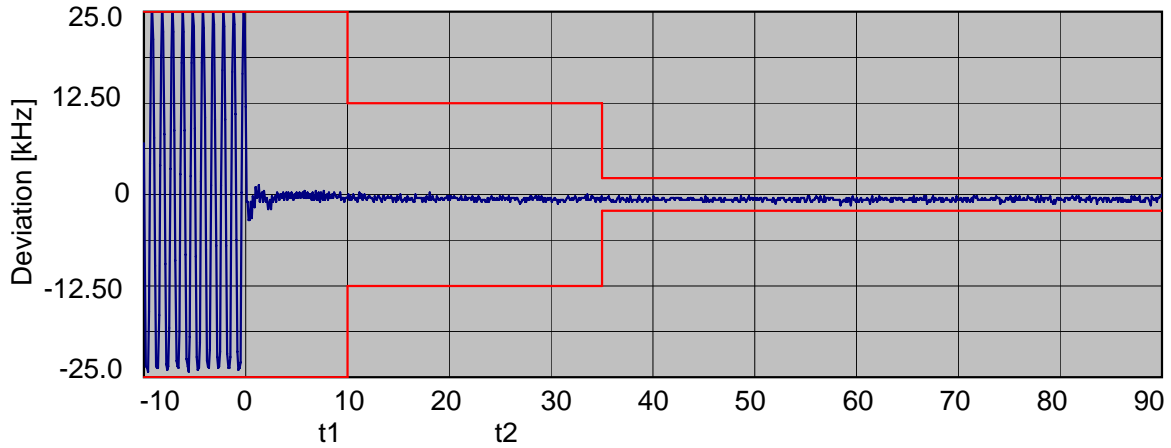

Model Name:	VX-2200-G7-25	Type:	Mobile/Portable
Serial Number:	7C000001	Trigger Direction:	Rise
Test Frequency:	481	Ref. Standard	EIA
Channel Spacing:	25		

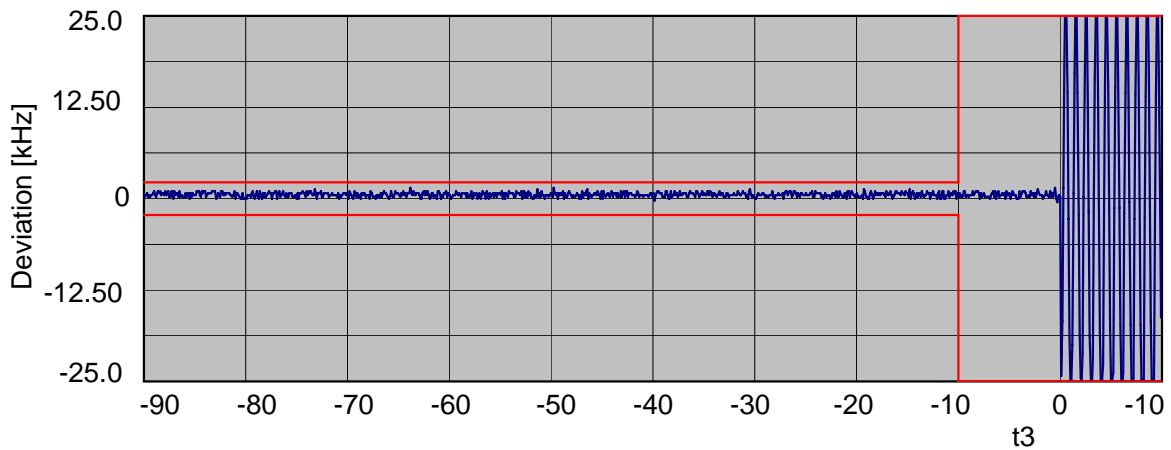

Model Name:	VX-2200-G7-25	Type:	Mobile/Portable
Serial Number:	7C000001	Trigger Direction:	Fall
Test Frequency:	481	Ref. Standard	EIA
Channel Spacing:	25		

NAME OF TEST: Transient Frequency Behaviour

STATE: 1 : High Power

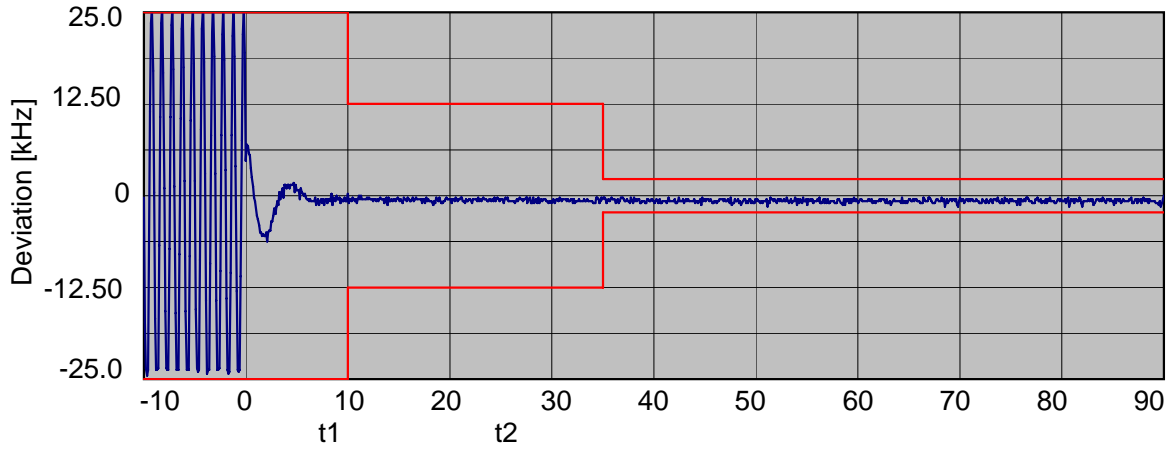

Model Name:	VX-2200-G7-25	Type:	Mobile/Portable
Serial Number:	7C000001	Trigger Direction:	Rise
Test Frequency:	512	Ref. Standard	EIA
Channel Spacing:	25		

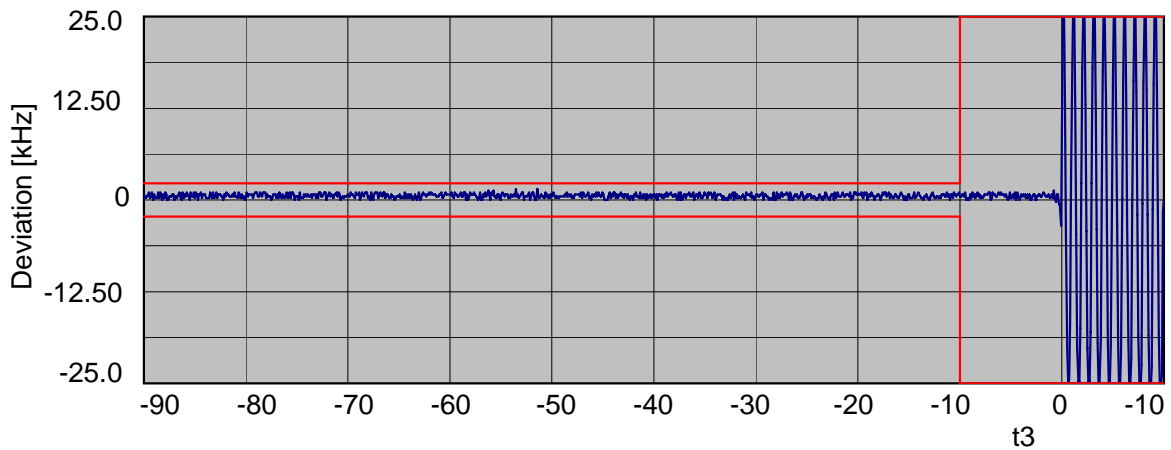

Model Name:	VX-2200-G7-25	Type:	Mobile/Portable
Serial Number:	7C000001	Trigger Direction:	Fall
Test Frequency:	512	Ref. Standard	EIA
Channel Spacing:	25		

NAME OF TEST: Transient Frequency Behaviour

STATE: 1 : High Power

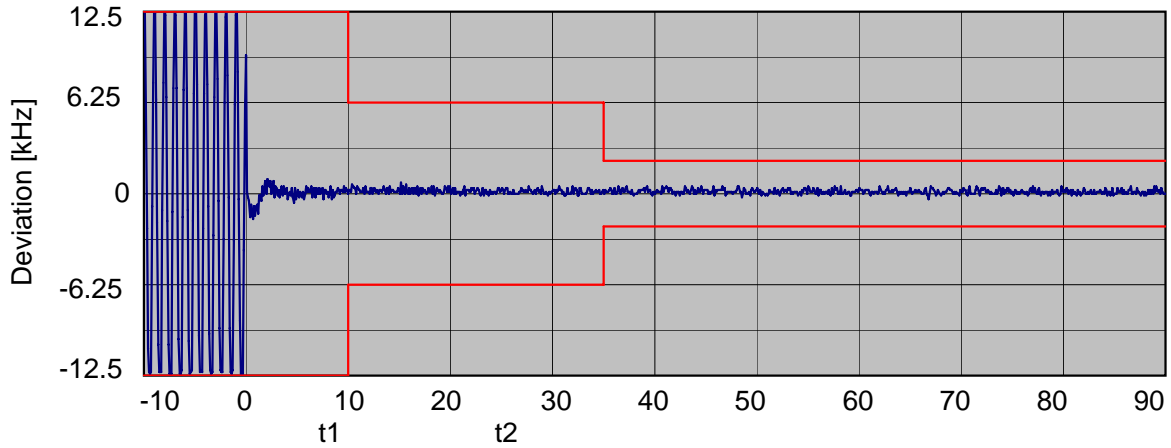

Model Name:	VX-2200-G7-25	Type:	Mobile/Portable
Serial Number:	7C000001	Trigger Direction:	Rise
Test Frequency:	450	Ref. Standard	EIA
Channel Spacing:	12.5		

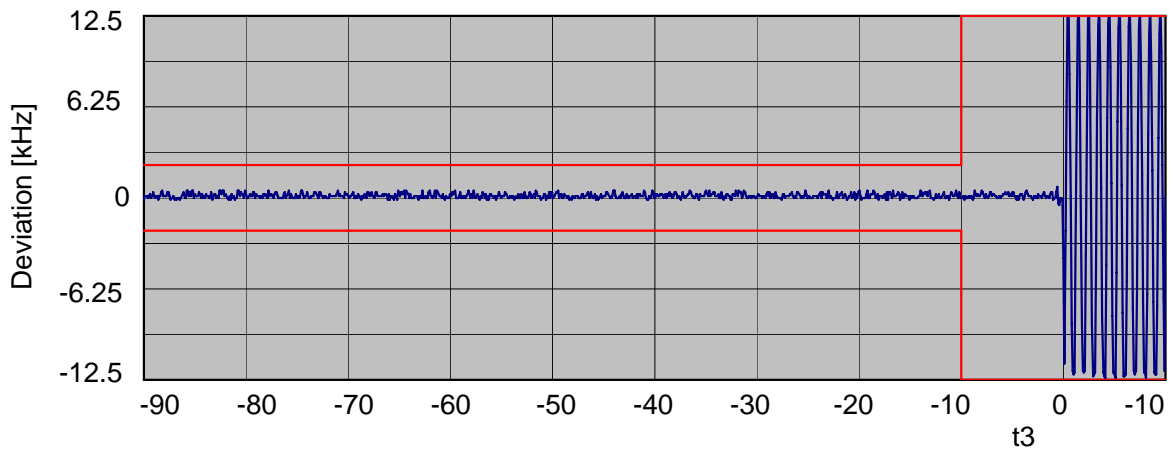

Model Name:	VX-2200-G7-25	Type:	Mobile/Portable
Serial Number:	7C000001	Trigger Direction:	Fall
Test Frequency:	450	Ref. Standard	EIA
Channel Spacing:	12.5		

NAME OF TEST: Transient Frequency Behaviour

STATE: 1 : High Power

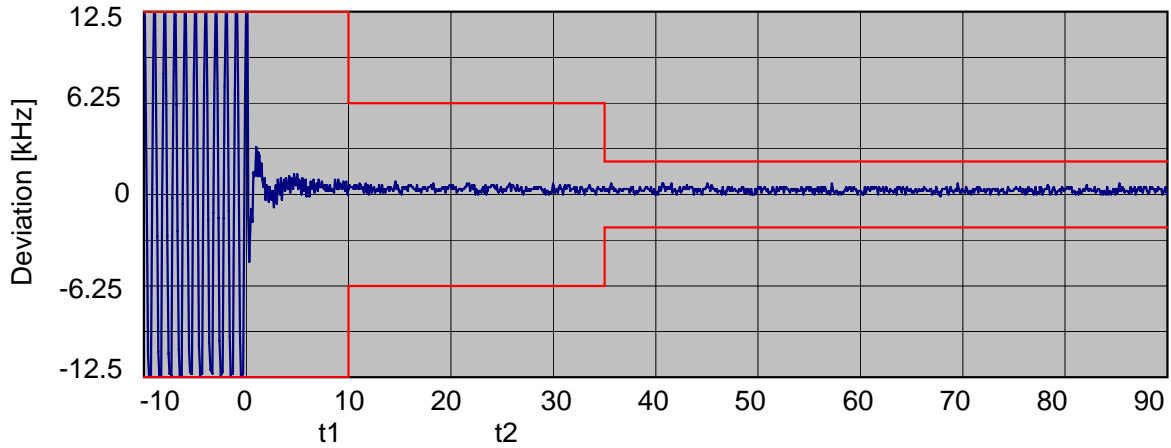

Model Name:	VX-2200-G7-25	Type:	Mobile/Portable
Serial Number:	7C000001	Trigger Direction:	Rise
Test Frequency:	481	Ref. Standard	EIA
Channel Spacing:	12.5		

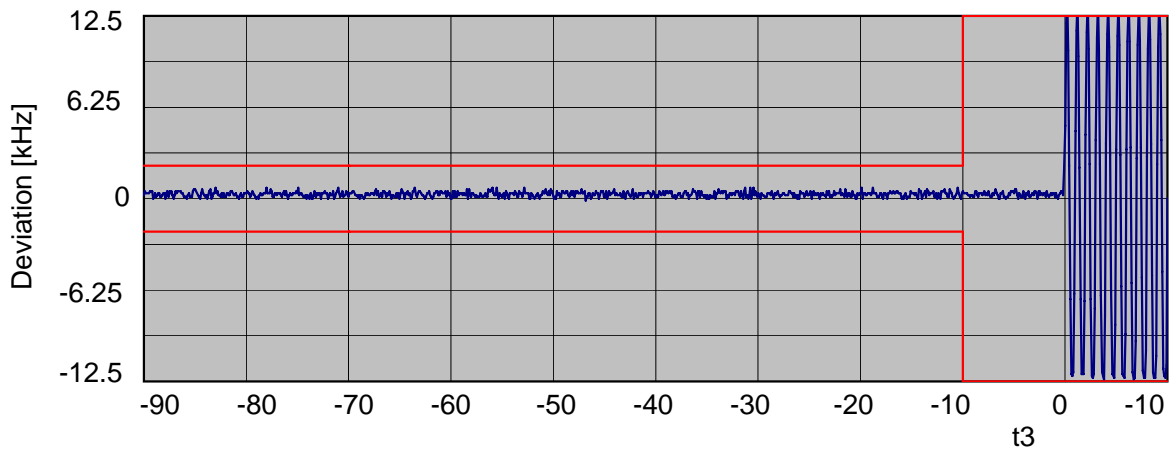

Model Name:	VX-2200-G7-25	Type:	Mobile/Portable
Serial Number:	7C000001	Trigger Direction:	Fall
Test Frequency:	481	Ref. Standard	EIA
Channel Spacing:	12.5		

NAME OF TEST: Transient Frequency Behaviour

STATE: 1 : High Power

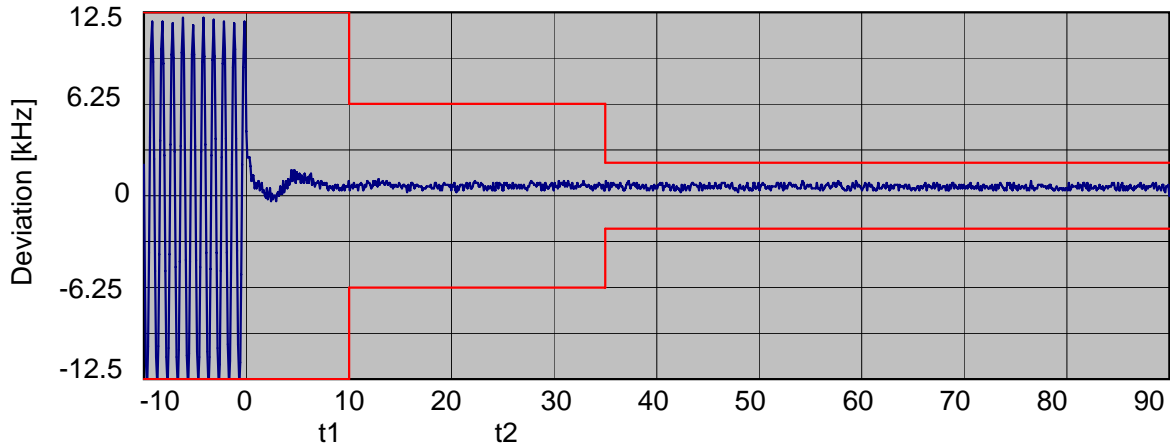

Model Name:	VX-2200-G7-25	Type:	Mobile/Portable
Serial Number:	7C000001	Trigger Direction:	Rise
Test Frequency:	512	Ref. Standard	EIA
Channel Spacing:	12.5		

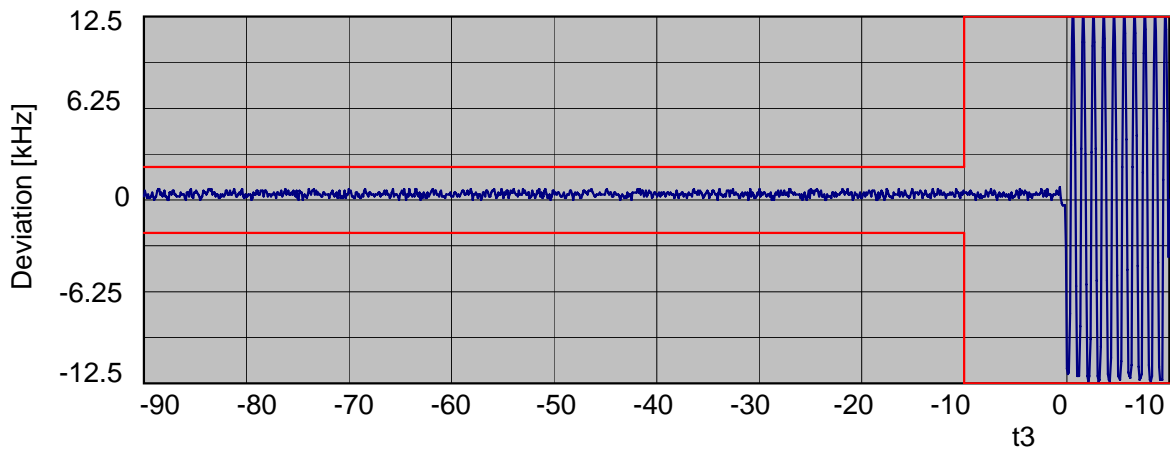

Model Name:	VX-2200-G7-25	Type:	Mobile/Portable
Serial Number:	7C000001	Trigger Direction:	Fall
Test Frequency:	512	Ref. Standard	EIA
Channel Spacing:	12.5		

NAME OF TEST: Audio Low Pass Filter (Voice Input)
SPECIFICATION: 47 CFR 2.1047 (a)
GUIDE: ANSI/TIA/EIA-603, Paragraph 2.2.15
TEST EQUIPMENT: As per attached page

MEASUREMENT PROCEDURE

1. The EUT and test equipment were set up such that the audio input was connected at the input of the modulation limiter, and the modulated stage.
2. The audio output was connected at the output to the modulated stage.
3. MEASUREMENT RESULTS: ATTACHED

TRANSMITTER TEST SET-UP

TEST A: MODULATION CAPABILITY / DISTORTION
 TEST B: AUDIO FREQUENCY RESPONSE
 TEST C: HUM AND NOISE LEVEL
 TEST D: RESPONSE OF LOW PASS FILTER
 TEST E: MODULATION KIMITING

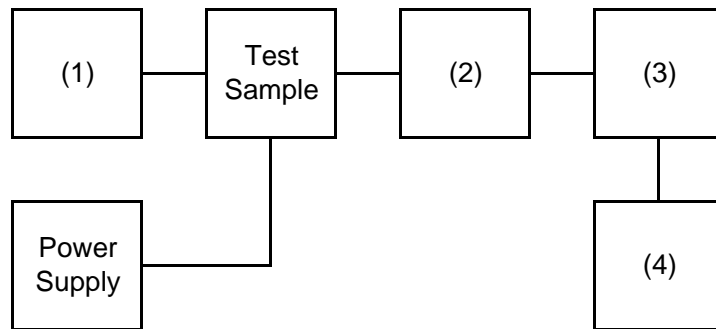

Instruments	Description	Serial Number
(1) AUDIO GENERATOR	Agilent 8903B	***
(2) COAXIAL ATTENUATOR	Agilent 8498A	***
(3) MODULATION ANALYZER	Agilent 8901B	***
(4) AUDIO ANALYZER	Agilent 8903B	***

NAME OF TEST: Audio Low Pass Filter (Voice Input)

STATE: 0 : General

Wide

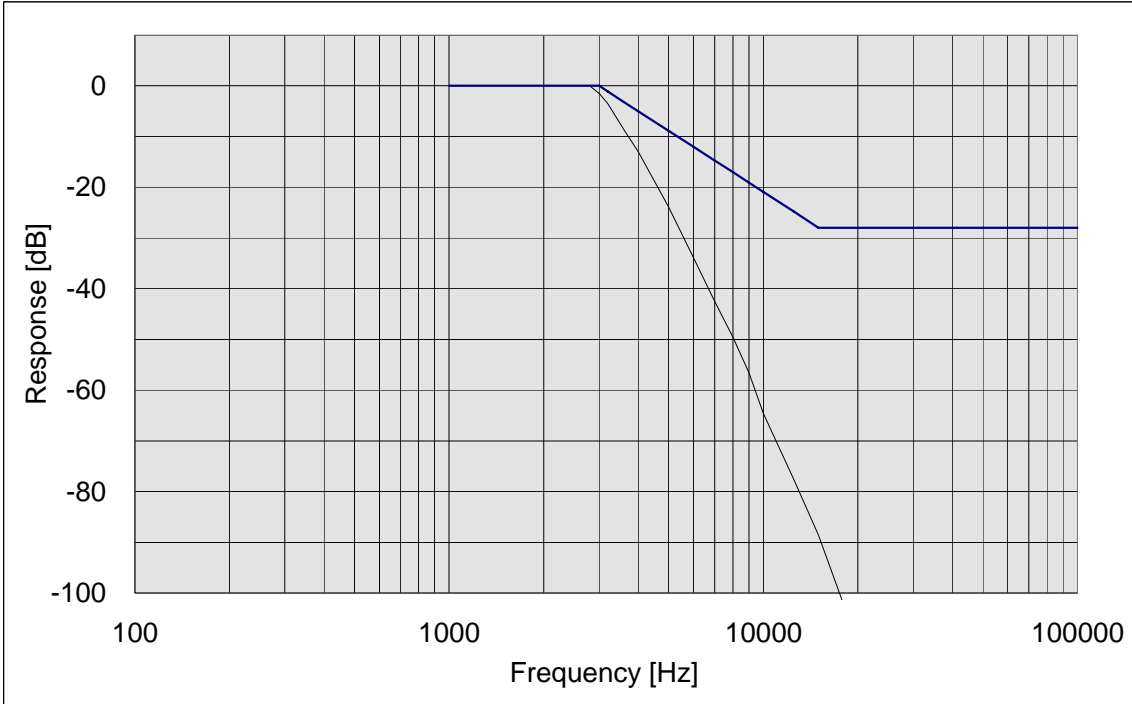

Narrow

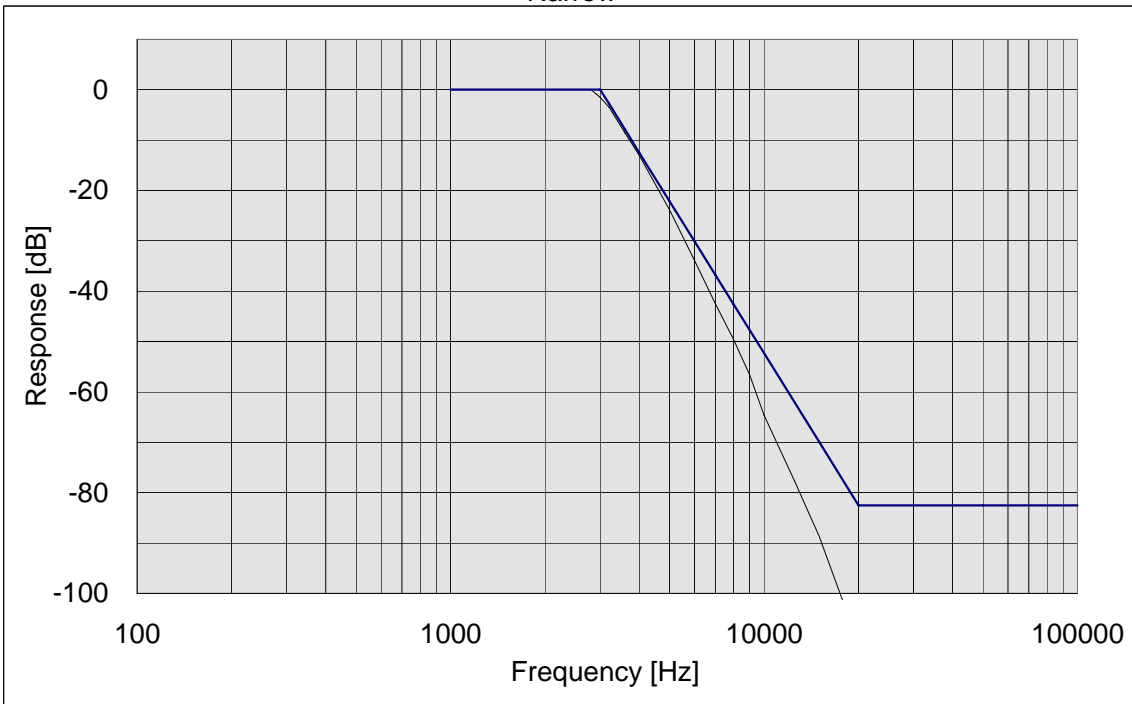

NAME OF TEST: Audio Frequency Response
SPECIFICATION: 47 CFR 2.1047 (a)
GUIDE: ANSI/TIA/EIA-603, Paragraph 2.2.6
TEST EQUIPMENT: As per previous page

MEASUREMENT PROCEDURE

1. The EUT and test equipment were set up as shown on the following page
2. The audio signal generator was connected to the audio input circuit/microphone of the EUT.
3. The audio signal input was adjusted to obtain 20% modulation at 1kHz, and this point was taken as the 0dB reference level.
4. Which input levels hold constant and below limiting at all frequencies, the audio signal generator was varied from 100Hz to 5kHz.
5. The response in dB relative to 1kHz was then measured, using the Agilent 8901B modulation analyzer.
6. MEASUREMENT RESULTS: ATTACHED

NAME OF TEST: Audio Frequency Response

STATE: 0 : General

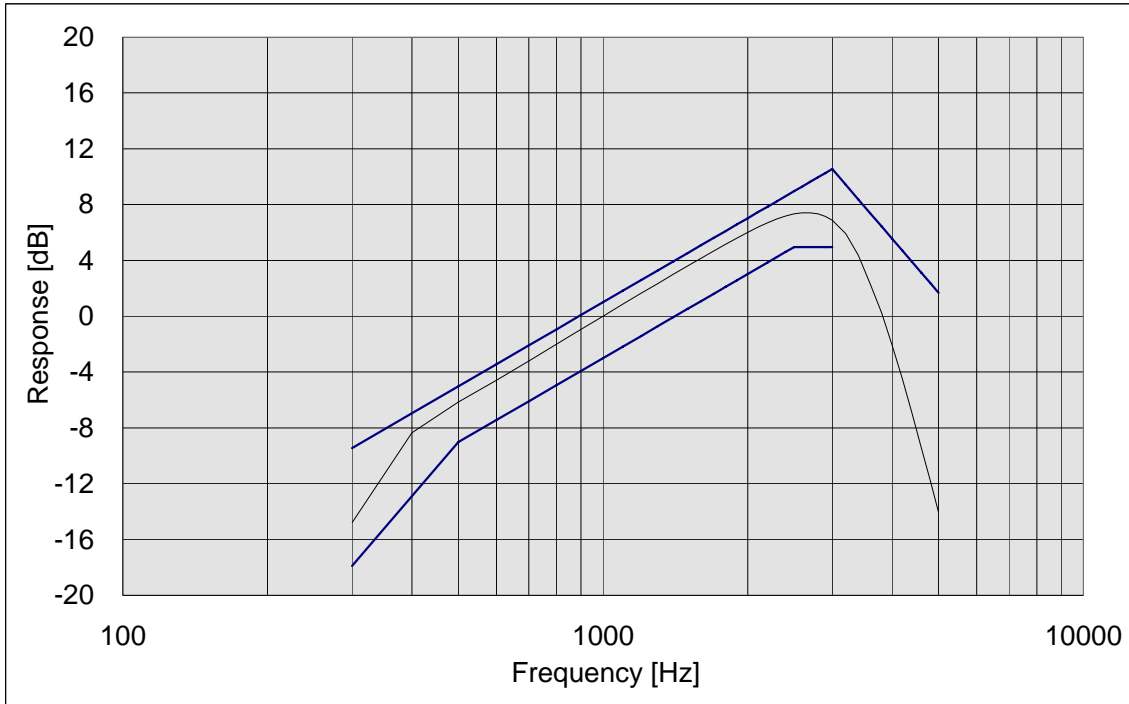

PEAK AUDIO FREQUENCY : 2700 [Hz]

NAME OF TEST: Modulation Limiting
SPECIFICATION: 47 CFR 2.1047 (b)
GUIDE: ANSI/TIA/EIA-603, Paragraph 2.2.3
TEST EQUIPMENT: As per previous page

MEASUREMENT PROCEDURE

1. The signal generator was connected to the input of the EUT as for "Frequency Response of the Modulating Circuit".
2. The modulation response was measured for each of three frequencies (one of which was the frequency of maximum response), and the input voltage was varied and was observed on an Agilent 8901B modulation analyzer
3. The input level was varied from 30% modulation ($\pm 1.5\text{kHz}$ deviation) to at least 20dB higher than the saturation point.
4. Measurements were performed for both negative and positive modulation and the respective results were recorded.
5. MEASUREMENT RESULTS: ATTACHED

NAME OF TEST: Modulation Limiting

STATE: 0 : General
Positive Peak Wide

0 dB = 6.32 [mV]

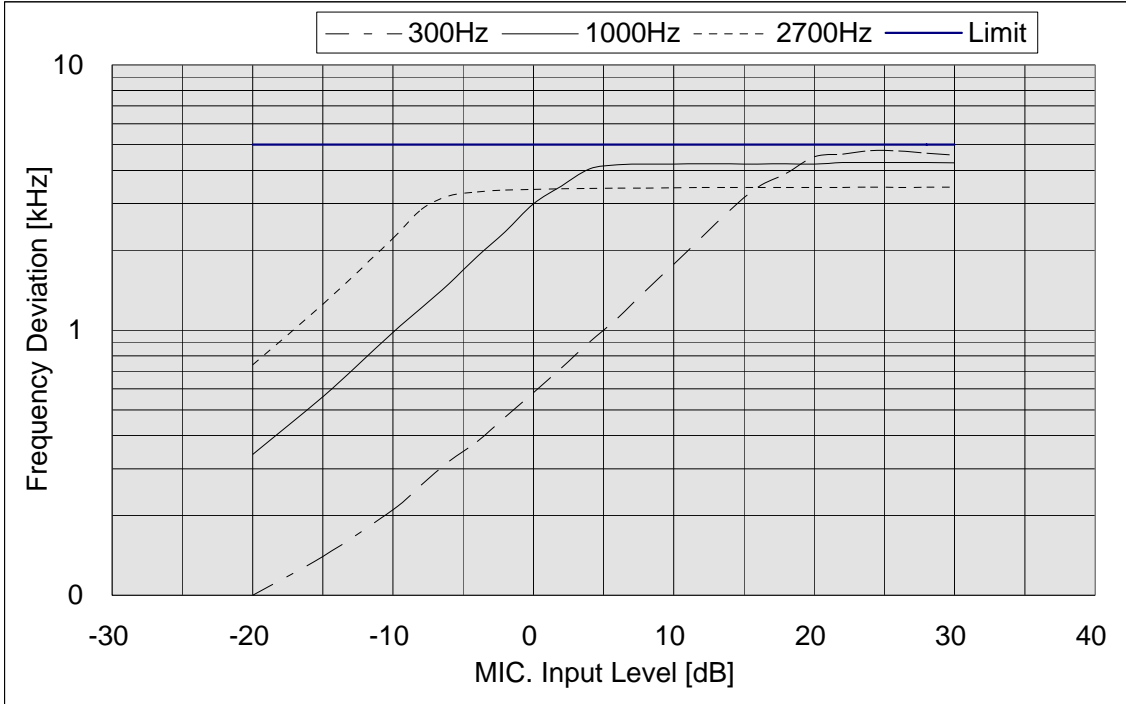

Negative Peak Wide

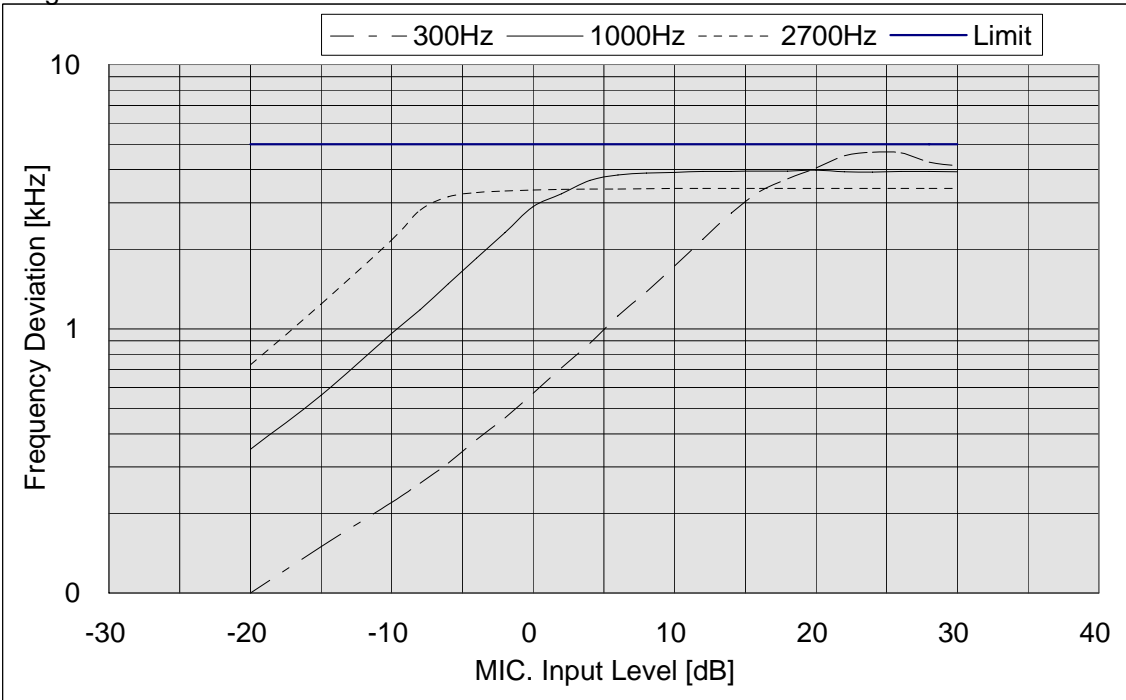

NAME OF TEST: Modulation Limiting

STATE: 0 : General
Positive Peak Narrow

0 dB = 6.32 [mV]

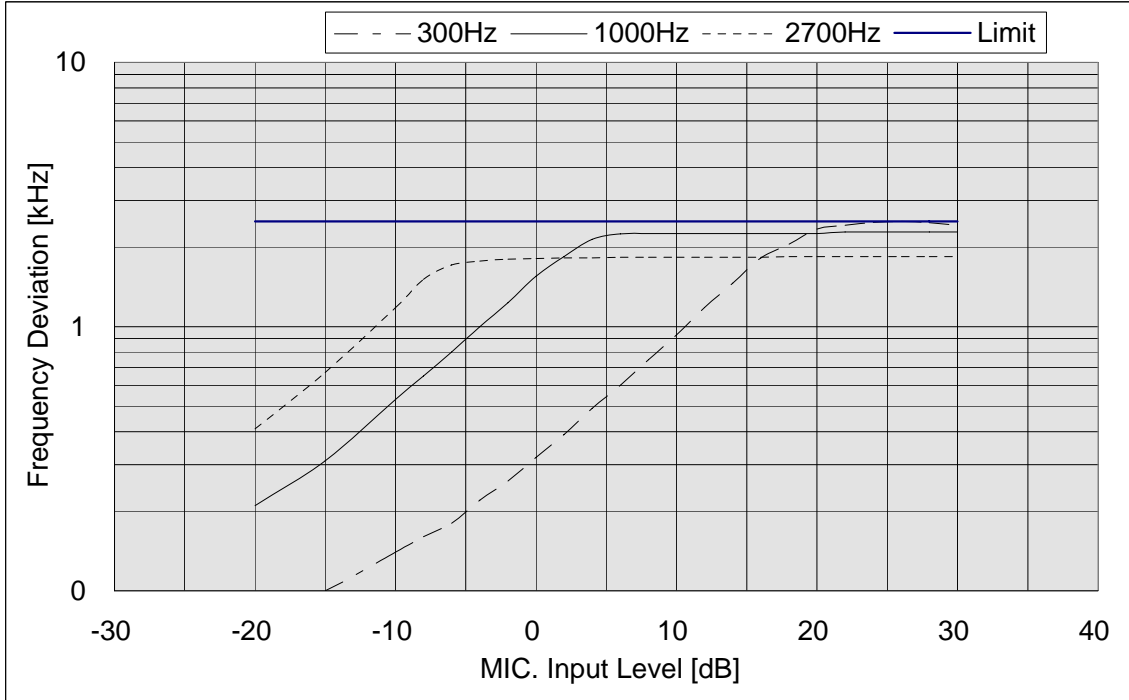

Negative Peak Narrow

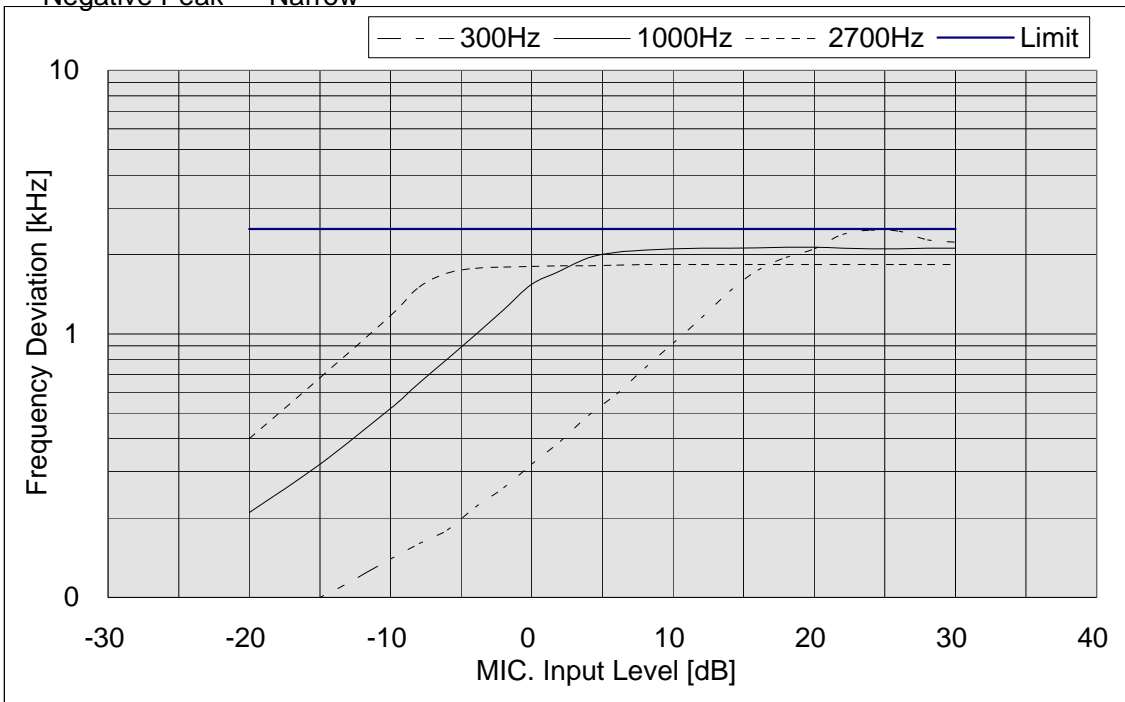

NAME OF TEST: Frequency Stability (Temperature Variation)
SPECIFICATION: 47 CFR 2.1055 (a) (1)
GUIDE: ANSI/TIA/EIA-603, Paragraph 2.2.2
TEST CONDITIONS: As indicated
TEST EQUIPMENT: As per previous page

MEASUREMENT PROCEDURE

1. The EUT and test equipment were set up as shown on the following page
2. With all power removed, the temperature was decreased to -30°C and permitted to stabilize for three hours. Power was applied and the maximum change in frequency was noted within one minute.
3. With power OFF, the temperature was raised in 10°C steps. The sample was permitted to stabilize at each step for at least one-half hour. Power was applied and the maximum frequency change was noted within one minute.
4. The temperature tests were performed for the worst case.
5. MEASUREMENT RESULTS: ATTACHED

TRANSMITTER TEST SET-UP

- TEST A: OPERATIONAL STABILITY
- TEST B: CARRIER FREQUENCY STABILITY
- TEST C: OPERATIONAL PERFORMANCE STABILITY
- TEST D: HUMIDITY
- TEST E: VIBRATION
- TEST F: ENVIRONMENTAL TEMPERATURE
- TEST G: FREQUENCY STABILITY, TEMPERATURE VARIATION
- TEST H: FREQUENCY STABILITY, VOLTAGE VARIATION

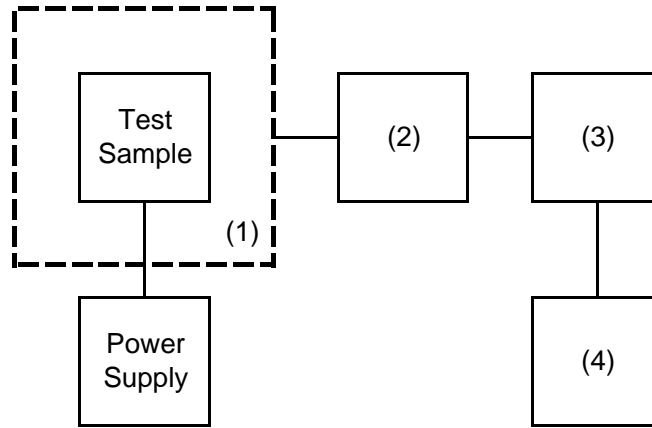

Instruments	Description	Serial Number
(1) TEMPERATURE CHAMBER	ETAC FX4100	***
(2) COAXIAL ATTENUATOR	Weinschel 53-30-33	***
(3) POWER METER	Agilent 436A	***
(4) FREQUENCY COUNTER	Agilent 8901B FREQUENCY MODI	***

NAME OF TEST: Frequency Stability (Temperature Variation)

STATE: 0 : General

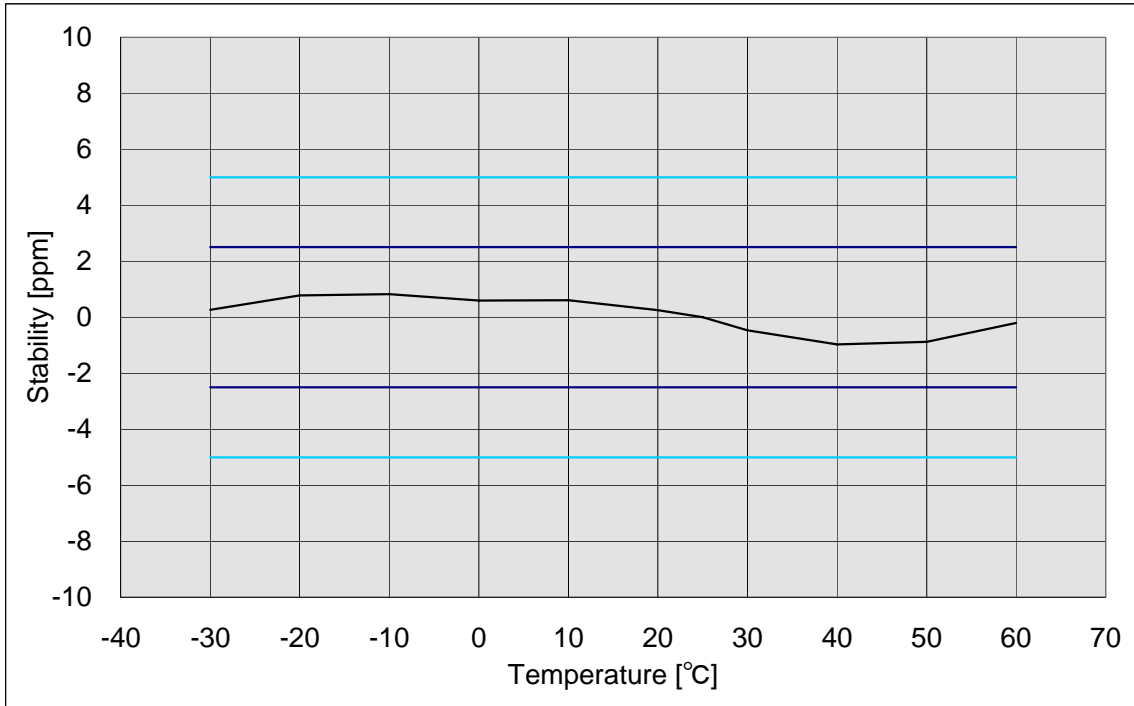

NAME OF TEST: Frequency Stability (Voltage Variation)
SPECIFICATION: 47 CFR 2.1055 (b)
GUIDE: ANSI/TIA/EIA-603, Paragraph 2.2.2
TEST EQUIPMENT: As per previous page

MEASUREMENT PROCEDURE

1. The EUT was placed in a temperature chamber at 25±5°C and connected as for "Frequency Stability - Temperature Variation" test.
2. The power supply voltage to the EUT was varied from 85% to 115% of the nominal value measured at the input to the EUT.
3. The variation in frequency was measured for the worst case.

RESULTS: Frequency Stability (Voltage Variation)

STATE: 0 : General

LIMIT', ppm = 2.5
 LIMIT', Hz = 1203

% of STV	Voltage	Frequency, MHz	Change, Hz	Change, ppm
85	11.56	480.999860	-140	-0.29
100	13.60	480.999840	-160	-0.33
115	15.64	480.999850	-150	-0.31

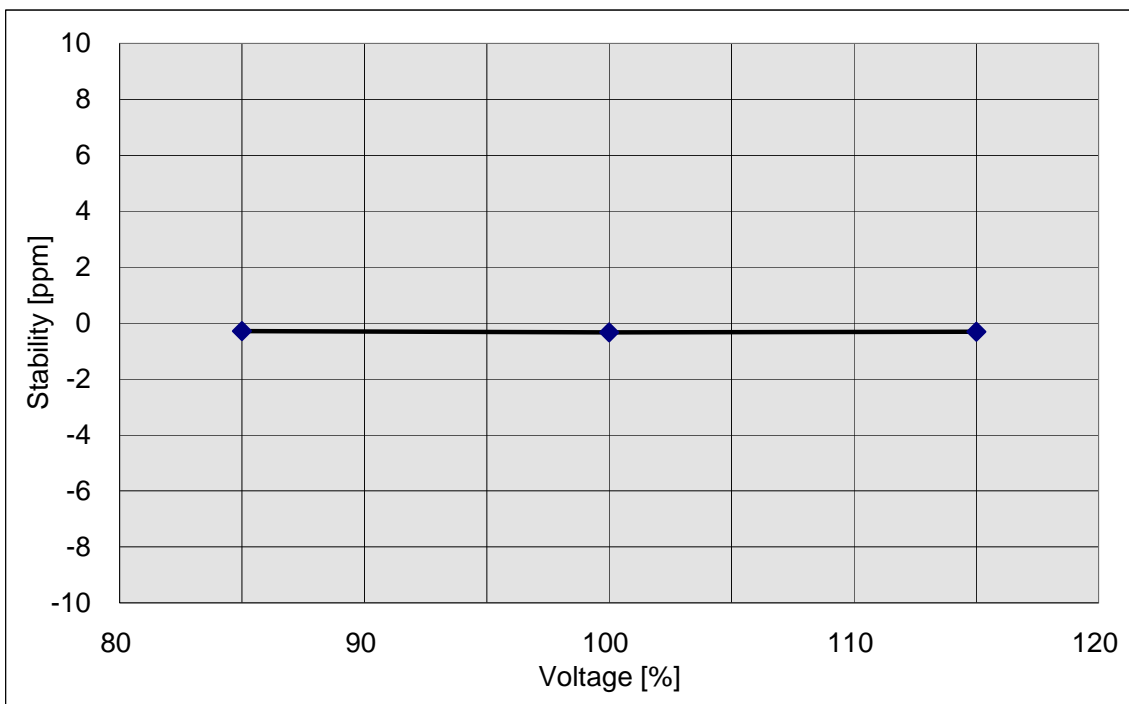

NAME OF TEST: Necessary Bandwidth and Emission Bandwidth
SPECIFICATION: 47 CFR 2.202 (g)

MODULATION = 16K0F3E

NECESSARY BANDWIDTH CALCULATION:

MAXIMUM MODULATION (M), kHz = 3
MAXIMUM DEVIATION (D), kHz = 5
CONSTANT FACTOR (K) = 1
NECESSARY BANDWIDTH (BN), kHz = $(2 \times M) + (2 \times D \times K)$
= 16

MODULATION = 11K0F3E

NECESSARY BANDWIDTH CALCULATION:

MAXIMUM MODULATION (M), kHz = 3
MAXIMUM DEVIATION (D), kHz = 3
CONSTANT FACTOR (K) = 1
NECESSARY BANDWIDTH (BN), kHz = $(2 \times M) + (2 \times D \times K)$
= 11

NAME OF TEST: Receiver Spurious Emissions (Conducted)

STATE: 0 : General

All other emissions in the required measurement range were more than 20dB below the required limits.

MEASUREMENT RESULTS

FREQUENCY TUNED, MHz	FREQUENCY EMISSION, MHz	LEVEL, dBm	LEVEL, nW
450.000	382.350	-70.3	0.0933
481.000	413.350	-70.7	0.0851
512.000	444.350	-73.4	0.0457
450.000	764.700	-74.0	0.0398
481.000	1653.400	-76.7	0.0214
512.000	1777.400	-73.8	0.0417
481.000	2066.750	-74.3	0.0372
512.000	2221.750	-74.9	0.0324
512.000	2666.100	-74.6	0.0347
481.000	2893.450	-70.3	0.0933
512.000	3999.150	-77.0	0.0200
481.000	4133.500	-75.7	0.0269

NAME OF TEST: Receiver Spurious Emissions (Radiated)

STATE: 0 : General

All other emissions in the required measurement range were more than 20dB below the required limits.

MEASUREMENT RESULTS

FREQUENCY TUNED, MHz	FREQUENCY EMISSION, MHz	LEVEL, dBuV	@m	CF, dB	uV/m
450.000	382.350	29.1	3	-4.4	33.5
481.000	413.350	25.6	3	-3.7	29.3
512.000	444.350	31.3	3	-3.9	35.2
450.000	764.700	37.2	3	-1.2	38.4
512.000	1333.050	36.4	3	-8.7	45.1
512.000	2221.750	42.8	3	-2.0	44.8
512.000	2666.100	45.5	3	1.0	44.5