

DECLARATION OF COMPLIANCE SAR RF EXPOSURE EVALUATION

<p><u>Test Lab</u></p> <p>CELLTECH LABS INC. Testing and Engineering Services 1955 Moss Court Kelowna, B.C. Canada V1Y 9L3 Phone: 250-448-7047 Fax: 250-448-7046 e-mail: info@celltechlabs.com web site: www.celltechlabs.com</p>	<p><u>Applicant Information</u></p> <p>VERTEX STANDARD CO., LTD. 4-8-8 Nakameguro, Meguro-Ku Tokyo 153-8644 Japan</p>
<p>FCC IDENTIFIER: K6610584720 IC IDENTIFIER: 511B-10584720 Model(s): VX-821-G7-5, VX-824-G7-5, VX-829-G7-5, VX-871-G7-5, VX-874-G7-5, VX-879-G7-5</p>	
<p>Rule Part(s): FCC 47 CFR §2.1093; IC RSS-102 Issue 1 (Provisional) Test Procedure(s): FCC OET Bulletin 65, Supplement C (Edition 01-01) Device Classification: Licensed Non-Broadcast Transmitter Held to Face (TNF) Device Description: Portable FM UHF PTT Radio Transceiver Modulation Type: FM (UHF)</p>	
<p>Tx Frequency Range: 450 - 512 MHz Max. RF Output Power Measured: 37.10 dBm Conducted (450 MHz) 36.67 dBm Conducted (481 MHz) 37.03 dBm Conducted (512 MHz)</p> <p>Antenna Type(s) Tested: Whip - 450-481 MHz (P/N: ATU-6D) Whip - 512 MHz (ATU-6F)</p> <p>Battery Type(s) Tested: Li-ion 7.4 V 1150 mAh (P/N: FNB-V86LI) Li-ion 7.4 V 2000 mAh (P/N: FNB-V87LI)</p>	
<p>Body-Worn Accessories Tested: Speaker-Microphone (P/N: MH-65A7A) Plastic Belt-Clip with Metal Spring (P/N: CLIP-820)</p>	
<p>Max. SAR Levels Evaluated: Face-held: 3.07 W/kg (50% Duty Cycle) Body-worn: 5.01 W/kg (50% Duty Cycle)</p>	

Celltech Labs Inc. declares under its sole responsibility that this wireless portable device has demonstrated compliance with the Specific Absorption Rate (SAR) RF exposure requirements specified in FCC 47 CFR §2.1093 and Health Canada's Safety Code 6. The device was tested in accordance with the measurement standards and procedures specified in FCC OET Bulletin 65, Supplement C (Edition 01-01) and Industry Canada RSS-102 Issue 1 (Provisional) for the Occupational / Controlled Exposure environment. All measurements were performed in accordance with the SAR system manufacturer recommendations.

I attest to the accuracy of data. All measurements were performed by me or were made under my supervision and are correct to the best of my knowledge and belief. I assume full responsibility for the completeness of these measurements and vouch for the qualifications of all persons taking them.

This test report shall not be reproduced partially, or in full, without the prior written approval of Celltech Labs Inc. The results and statements contained in this report pertain only to the device(s) evaluated.

Performed By:



Spencer Watson
Compliance Technologist
Celltech Labs Inc.

Reviewed By:



Russell W. Pipe
Senior Compliance Technologist
Celltech Labs Inc.



TABLE OF CONTENTS		
1.0	INTRODUCTION.....	3
2.0	DESCRIPTION OF DUT.....	3
3.0	SAR MEASUREMENT SYSTEM.....	4
4.0	MEASUREMENT SUMMARY.....	5
5.0	DETAILS OF SAR EVALUATION.....	6
6.0	EVALUATION PROCEDURES.....	6
7.0	SYSTEM PERFORMANCE CHECK.....	7
8.0	SIMULATED EQUIVALENT TISSUES.....	8
9.0	SAR SAFETY LIMITS.....	8
10.0	ROBOT SYSTEM SPECIFICATIONS.....	9
11.0	PROBE SPECIFICATION.....	10
12.0	PLANAR PHANTOM.....	10
13.0	VALIDATION PHANTOM.....	10
14.0	DEVICE HOLDER.....	10
15.0	TEST EQUIPMENT LIST.....	11
16.0	MEASUREMENT UNCERTAINTIES.....	12-13
17.0	REFERENCES.....	14
	APPENDIX A - SAR MEASUREMENT DATA.....	15
	APPENDIX B - SYSTEM PERFORMANCE CHECK DATA.....	16
	APPENDIX C - SYSTEM VALIDATION PROCEDURES.....	17
	APPENDIX D - PROBE CALIBRATION.....	18
	APPENDIX E - MEASURED FLUID DIELECTRIC PARAMETERS.....	19
	APPENDIX F - SAR TEST SETUP & DUT PHOTOGRAPHS.....	20

1.0 INTRODUCTION

This measurement report demonstrates compliance of the Vertex Standard Co., Ltd. Model(s): VX-821-G7-5, VX-824-G7-5, VX-829-G7-5, VX-871-G7-5, VX-874-G7-5, & VX-879-G7-5 Portable FM UHF PTT Radio Transceiver FCC ID: K6610584720 with the SAR (Specific Absorption Rate) RF exposure requirements specified in FCC 47 CFR §2.1093 (see reference [1]), and Health Canada's Safety Code 6 (see reference [2]) for the Occupational / Controlled Exposure environment. The measurement procedures described in FCC OET Bulletin 65, Supplement C (Edition 01-01) (see reference [3]) and IC RSS-102 Issue 1 (Provisional) (see reference [4]), were employed. A description of the product, operating configuration, detailed summary of the test results, methodology and procedures used in the evaluation, equipment used, and the various provisions of the rules are included within this test report.

2.0 DESCRIPTION OF DEVICE UNDER TEST (DUT)

FCC Rule Part(s)	47 CFR §2.1093		
IC Rule Part(s)	RSS-102 Issue 1 (Provisional)		
Test Procedure(s)	FCC OET Bulletin 65, Supplement C (Edition 01-01)		
Device Classification	Licensed Non-Broadcast Transmitter Held to Face (TNF)		
Device Description	Portable FM UHF PTT Radio Transceiver		
FCC IDENTIFIER	K6610584720		
IC IDENTIFER	511B-10584720		
Model(s)	VX-821-G7-5	VX-824-G7-5	VX-829-G7-5
	VX-871-G7-5	VX-874-G7-5	VX-879-G7-5
Serial No.	4M000012	Identical Prototype	
Modulation Type	FM (UHF)		
Tx Frequency Range	450 - 512 MHz		
Max. RF Output Power Measured	37.10 dBm	Conducted	450 MHz
	36.67 dBm	Conducted	481 MHz
	37.03 dBm	Conducted	512 MHz
Antenna Type(s) Tested	Whip	450 - 481 MHz	P/N: ATU-6D Length: 154 mm
	Whip	512 MHz	P/N: ATU-6F Length: 142 mm
Battery Type(s) Tested	Li-ion	7.4 V, 1150 mAh	P/N: FNB-V86LI
	Li-ion	7.4 V, 2000 mAh	P/N: FNB-V87LI
Body-Worn Accessories Tested	Speaker-Microphone		P/N: MH-65A7A
	Plastic Belt-Clip with Metal Spring		P/N: CLIP-820

3.0 SAR MEASUREMENT SYSTEM

Celltech Labs Inc. SAR measurement facility utilizes the Dosimetric Assessment System (DASY™) manufactured by Schmid & Partner Engineering AG (SPEAG™) of Zurich, Switzerland. The DASY4 measurement system is comprised of the measurement server, robot controller, computer, near-field probe, probe alignment sensor, specific anthropomorphic mannequin (SAM) phantom, and various planar phantoms for brain and/or body SAR evaluations. The robot is a six-axis industrial robot performing precise movements to position the probe to the location (points) of maximum electromagnetic field (EMF). A cell controller system contains the power supply, robot controller, teach pendant (Joystick), and remote control, is used to drive the robot motors. The Staubli robot is connected to the cell controller to allow software manipulation of the robot. A data acquisition electronic (DAE) circuit performs the signal amplification, signal multiplexing, AD-conversion, offset measurements, mechanical surface detection, collision detection, etc. is connected to the Electro-optical coupler (EOC). The EOC performs the conversion from the optical into digital electric signal of the DAE and transfers data to the DASY4 measurement server. The DAE4 utilizes a highly sensitive electrometer-grade preamplifier with auto-zeroing, a channel and gain-switching multiplexer, a fast 16-bit AD-converter and a command decoder and control logic unit. Transmission to the DASY4 measurement server is accomplished through an optical downlink for data and status information and an optical uplink for commands and clock lines. The mechanical probe-mounting device includes two different sensor systems for frontal and sidewise probe contacts. The sensor systems are also used for mechanical surface detection and probe collision detection. The robot uses its own controller with a built in VME-bus computer.



DASY4 SAR Measurement System with validation phantom



DASY4 SAR Measurement System with Plexiglas planar phantom

Applicant:	Vertex Standard Co., Ltd.	FCC ID:	K6610584720	IC ID:	511B-10584720	450 - 512 MHz
Model(s):	VX-821-G7-5, VX-824-G7-5, VX-829-G7-5, VX-871-G7-5, VX-874-G7-5, VX-879-G7-5			Portable FM UHF PTT Radio Transceiver		
2004 Celltech Labs Inc. This document is not to be reproduced in whole or in part without the written permission of Celltech Labs Inc.						4 of 20

4.0 MEASUREMENT SUMMARY

SAR EVALUATION RESULTS

Test Type	Freq. (MHz)	Chan.	Test Mode	Antenna		Battery Type	Body-worn Accessories	Separation Distance to Planar Phantom (cm)	Cond. Power Before Test (dBm)	Measured SAR 1g (W/kg)		SAR Drift During Test (dB)	Scaled SAR 1g (W/kg)			
				Type	Freq.					Duty Cycle			Duty Cycle			
										100%	50%		100%	50%		
Face	481	Mid	CW	Whip	450-481	Li-ion 1150 mAh	-	2.5	36.64	P	5.45	2.73	-0.434	P	6.02	3.01
										S	5.11	2.56	-0.640	S	5.92	2.96
Face	481	Mid	CW	Whip	450-481	Li-ion 2000 mAh	-	2.5	36.61	5.63	2.82	-0.375	6.14	3.07		
Face	512	High	CW	Whip	512	Li-ion 2000 mAh	-	2.5	37.02	4.94	2.47	1.12	4.94	2.47		
Body	481	Mid	CW	Whip	450-481	Li-ion 1150 mAh	Speaker-Mic and Belt-Clip	1.2	36.67	8.26	4.13	-0.357	8.97	4.48		
Body	481	Mid	CW	Whip	450-481	Li-ion 2000 mAh	Speaker-Mic and Belt-Clip	0.8	36.62	8.78	4.39	-0.366	9.55	4.78		
Body	450	Low	CW	Whip	450-481	Li-ion 2000 mAh	Speaker-Mic and Belt-Clip	0.8	37.10	9.23	4.62	-0.340	9.98	4.99		
Body	512	High	CW	Whip	512	Li-ion 2000 mAh	Speaker-Mic and Belt-Clip	0.8	37.03	9.56	4.78	-0.200	10.0	5.01		

ANSI / IEEE C95.1 1999 - SAFETY LIMIT
BRAIN / BODY: 8.0 W/kg (averaged over 1 gram)
Spatial Peak - Controlled Exposure / Occupational

Test Date(s)	December 14, 2004		December 14, 2004		Measured Fluid Type	Brain	Body	Unit	
Dielectric Constant ϵ_r	450 MHz Brain		450 MHz Body		Relative Humidity	30	30	%	
	IEEE Target	Measured	IEEE Target	Measured	Atmospheric Pressure	102.6	103.0	kPa	
	43.5	$\pm 5\%$	43.1	56.7	$\pm 5\%$	56.9	Ambient Temperature	22.7	23.9
Conductivity σ (mho/m)	450 MHz Brain		450 MHz Body		Fluid Temperature	22.0	21.7	$^{\circ}\text{C}$	
	IEEE Target	Measured	IEEE Target	Measured	Fluid Depth	≥ 15	≥ 15	cm	
	0.87	$\pm 5\%$	0.86	0.94	$\pm 5\%$	0.91	ρ (Kg/m ³)	1000	

Note(s):

- The measurement results were obtained with the DUT tested in the conditions described in this report. Detailed measurement data and plots showing the maximum SAR location of the DUT are reported in Appendix A.
- If the scaled SAR levels evaluated at the mid channel (50% duty cycle) were ≥ 3 dB below the SAR limit, SAR evaluation for the low and high channels was optional per FCC OET Bulletin 65, Supplement C, Edition 01-01 (see reference [3]).
- The power drifts measured by the DASY4 system for the duration of the SAR evaluations were added to the measured SAR levels to report scaled SAR results as shown in the above test data table.
- Secondary peak SAR levels measured within 2 dB of the primary were reported (P = Primary, S = Secondary).
- A SAR-versus-Time power drift evaluation was performed in the test configuration that reported the maximum-scaled SAR level (body-worn, high channel, whip antenna P/N: ATU-6F, 2000 mAh Li-ion battery). See Appendix A (SAR Test Plots) for SAR-versus-Time power drift evaluation plot.
- The ambient and fluid temperatures were measured prior to, and during, the fluid dielectric parameter check and the SAR evaluation. The temperatures reported were consistent for all measurement periods.
- The dielectric parameters of the simulated tissue mixtures were measured prior to the evaluation using an HP 85070C Dielectric Probe Kit and an HP 8753E Network Analyzer (see Appendix E for printout of measured fluid dielectric parameters).
- The SAR evaluations were performed within 24 hours of the system performance check.

Applicant:	Vertex Standard Co., Ltd.	FCC ID:	K6610584720	IC ID:	511B-10584720	450 - 512 MHz
Model(s):	VX-821-G7-5, VX-824-G7-5, VX-829-G7-5, VX-871-G7-5, VX-874-G7-5, VX-879-G7-5			Portable FM UHF PTT Radio Transceiver		
2004 Celltech Labs Inc. This document is not to be reproduced in whole or in part without the written permission of Celltech Labs Inc.						5 of 20

5.0 DETAILS OF SAR EVALUATION

The Vertex Standard Co., Ltd. Model(s): VX-821-G7-5, VX-824-G7-5, VX-829-G7-5, VX-871-G7-5, VX-874-G7-5, & VX-879-G7-5 Portable FM UHF PTT Radio Transceiver FCC ID: K6610584720 was compliant for localized Specific Absorption Rate (Occupational / Controlled Exposure) based on the test provisions and conditions described below. The detailed test setup photographs are shown in Appendix F.

1. The DUT was evaluated in a face-held configuration with the front of the radio placed parallel to the outer surface of the planar phantom. A 2.5 cm separation distance was maintained between the front side of the DUT and the outer surface of the planar phantom.
2. The DUT was evaluated in a body-worn configuration with the back of the radio placed parallel to the outer surface of the planar phantom. The attached belt-clip accessory was touching the planar phantom. With the Li-ion 1150 mAh battery the belt-clip accessory provided a 1.2 cm separation distance between the back of the DUT and the outer surface of the planar phantom. With the Li-ion 2000 mAh battery the belt-clip accessory provided a 0.8 cm separation distance between the back of the DUT and the outer surface of the planar phantom. The DUT was evaluated for body-worn SAR with the speaker-microphone accessory connected to the audio port.
3. The conducted power levels were measured prior to each test using a Gigatronics 8652A Universal Power Meter according to the procedures described in FCC 47 CFR §2.1046.
4. The power drifts measured by the DASY4 system during the SAR evaluations were added to the measured SAR levels to report scaled SAR results as shown in the test data table (page 5).
5. A SAR-versus-Time power drift evaluation was performed in the test configuration that reported the maximum scaled SAR level. See Appendix A (SAR Test Plots) for the SAR-versus-Time power drift evaluation data.
6. The area scan evaluation was performed with a fully charged battery. After the area scan was completed the DUT was cooled down to room temperature and the battery was replaced with a fully charged battery prior to the zoom scan evaluation.
7. The DUT was tested in unmodulated continuous transmit operation (Continuous Wave mode at 100% duty cycle) with the transmit key constantly depressed. For a push-to-talk device the 50% duty cycle compensation reported assumes a transmit/receive cycle of equal time base.
8. The SAR evaluations were performed using a Plexiglas planar phantom.

6.0 EVALUATION PROCEDURES

- (i) The evaluation was performed in the applicable area of the phantom depending on the type of device being tested. For devices held to the ear during normal operation, both the left and right ear positions were evaluated using the SAM phantom.
- (ii) For face-held and body-worn devices a planar phantom was used.
- b. The SAR was determined by a pre-defined procedure within the DASY4 software. Upon completion of a reference and optical surface check, the exposed region of the phantom was scanned near the inner surface with a grid spacing of 15mm x 15mm.

An area scan was determined as follows:

- c. Based on the defined area scan grid, a more detailed grid is created to increase the points by a factor of 10. The interpolation function then evaluates all field values between corresponding measurement points.
- d. A linear search is applied to find all the candidate maxima. Subsequently, all maxima are removed that are >2 dB from the global maximum. The remaining maxima are then used to position the cube scans.

A 1g and 10g spatial peak SAR was determined as follows:

- e. Extrapolation is used to find the points between the dipole center of the probe and the surface of the phantom. This data cannot be measured, since the center of the dipoles is 2.7 mm away from the tip of the probe and the distance between the surface and the lowest measuring point is 1.4 mm (see probe calibration document in Appendix D). The extrapolation was based on trivariate quadratics computed from the previously calculated 3D interpolated points nearest the phantom surface.
- f. Interpolated data is used to calculate the average SAR over 1g and 10g cubes by spatially discretizing the entire measured cube. The volume used to determine the averaged SAR is a 1mm grid (42875 interpolated points).
- g. A zoom scan volume of 32 mm x 32 mm x 30 mm (5 x 5 x 7 points) centered at the peak SAR location determined from the area scan is used for all zoom scans for devices with a transmit frequency < 800 MHz. Zoom scans for frequencies ≥ 800 MHz are determined with a scan volume of 30 mm x 30 mm x 30 mm (7 x 7 x 7) to ensure complete capture of the peak spatial-average SAR.

Applicant:	Vertex Standard Co., Ltd.	FCC ID:	K6610584720	IC ID:	511B-10584720	450 - 512 MHz
Model(s):	VX-821-G7-5, VX-824-G7-5, VX-829-G7-5, VX-871-G7-5, VX-874-G7-5, VX-879-G7-5		Portable FM UHF PTT Radio Transceiver			
2004 Celltech Labs Inc. This document is not to be reproduced in whole or in part without the written permission of Celltech Labs Inc.						6 of 20

7.0 SYSTEM PERFORMANCE CHECK

Prior to the SAR evaluation a system check was performed using a planar phantom with a 450MHz dipole (see Appendix C for system validation procedure). The dielectric parameters of the simulated tissue mixture were measured prior to the system performance check using an HP 85070C Dielectric Probe Kit and an HP 8753E Network Analyzer (see Appendix E for printout of measured fluid dielectric parameters). A forward power of 250mW was applied to the dipole and the system was verified to a tolerance of $\pm 10\%$ (see Appendix B for system performance check test plot).

SYSTEM PERFORMANCE CHECK													
Test Date	450MHz Equiv. Tissue	SAR 1g (W/kg)		Dielectric Constant ϵ_r		Conductivity σ (mho/m)		ρ (Kg/m ³)	Amb. Temp. (°C)	Fluid Temp. (°C)	Fluid Depth (cm)	Humid. (%)	Barom. Press. (kPa)
		IEEE Target	Measured	IEEE Target	Measured	IEEE Target	Measured						
12/14/04	Brain	1.23 ($\pm 10\%$)	1.30 (+5.7%)	43.5 $\pm 5\%$	43.1	0.87 $\pm 5\%$	0.86	1000	22.7	22.0	≥ 15	30	102.6

Note(s):
 1. The ambient and fluid temperatures were measured prior to, and during, the fluid dielectric parameter check and the system performance check. The temperatures reported in the table above were consistent for all measurement periods.

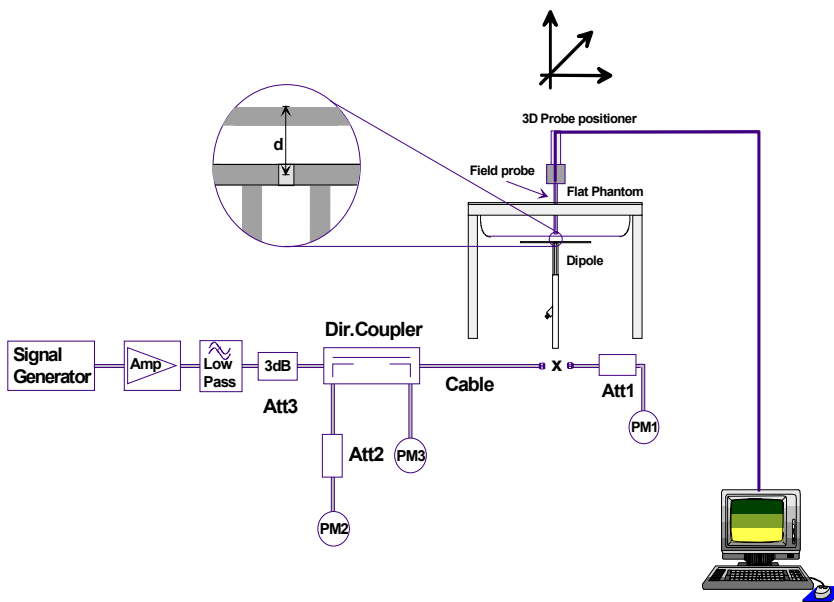

Figure 1. System Performance Check Setup Diagram



450MHz Dipole Setup

Applicant:	Vertex Standard Co., Ltd.	FCC ID:	K6610584720	IC ID:	511B-10584720	450 - 512 MHz
Model(s):	VX-821-G7-5, VX-824-G7-5, VX-829-G7-5, VX-871-G7-5, VX-874-G7-5, VX-879-G7-5		Portable FM UHF PTT Radio Transceiver			
2004 Celltech Labs Inc. This document is not to be reproduced in whole or in part without the written permission of Celltech Labs Inc.						7 of 20

8.0 SIMULATED EQUIVALENT TISSUES

The 450MHz simulated tissue mixtures consist of a viscous gel using hydroxethylcellulose (HEC) gelling agent and saline solution. Preservation with a bactericide is added and visual inspection is made to ensure air bubbles are not trapped during the mixing process. The fluid was prepared and measured for dielectric parameters (permittivity and conductivity) according to standardized procedures.

SIMULATED TISSUE MIXTURES		
INGREDIENT	450 MHz Brain	450 MHz Body
	System Check & DUT Evaluation	DUT Evaluation
Water	38.56 %	52.00 %
Sugar	56.32 %	45.65 %
Salt	3.95 %	1.75 %
HEC	0.98 %	0.50 %
Bactericide	0.19 %	0.10 %

9.0 SAR SAFETY LIMITS

EXPOSURE LIMITS	SAR (W/kg)	
	(General Population / Uncontrolled Exposure Environment)	(Occupational / Controlled Exposure Environment)
Spatial Average (averaged over the whole body)	0.08	0.4
Spatial Peak (averaged over any 1g of tissue)	1.60	8.0
Spatial Peak (hands/wrists/feet/ankles averaged over 10g)	4.0	20.0

Notes:

1. Uncontrolled environments are defined as locations where there is potential exposure of individuals who have no knowledge or control of their potential exposure.
2. Controlled environments are defined as locations where there is potential exposure of individuals who have knowledge of their potential exposure and can exercise control over their exposure.

10.0 ROBOT SYSTEM SPECIFICATIONS

Specifications

POSITIONER: Stäubli Unimation Corp. Robot Model: RX60L
Repeatability: 0.02 mm
No. of axis: 6

Data Acquisition Electronic (DAE) System

Cell Controller

Processor: AMD Athlon XP 2400+
Clock Speed: 2.0 GHz
Operating System: Windows XP Professional

Data Converter

Features: Signal Amplifier, multiplexer, A/D converter, and control logic
Software: DASY4 software
Connecting Lines: Optical downlink for data and status info.
 Optical uplink for commands and clock

DASY4 Measurement Server

Function: Real-time data evaluation for field measurements and surface detection
Hardware: PC/104 166MHz Pentium CPU; 32 MB chipdisk; 64 MB RAM
Connections: COM1, COM2, DAE, Robot, Ethernet, Service Interface

E-Field Probe

Model: ET3DV6
Serial No.: 1387
Construction: Triangular core fiber optic detection system
Frequency: 10 MHz to 6 GHz
Linearity: ± 0.2 dB (30 MHz to 3 GHz)

Phantom(s)

Evaluation Phantom

Type: Planar Phantom
Shell Material: Plexiglas
Bottom Thickness: 2.0 mm \pm 0.1 mm
Outer Dimensions: 75.0 cm (L) x 22.5 cm (W) x 20.5 cm (H); Back Plane: 25.7 cm (H)

Validation Phantom (≤ 450 MHz)

Type: Planar Phantom
Shell Material: Plexiglas
Bottom Thickness: 6.2 mm \pm 0.1 mm
Outer Dimensions: 86.0 cm (L) x 39.5 cm (W) x 21.8 cm (H)

11.0 PROBE SPECIFICATION (ET3DV6)

Construction: Symmetrical design with triangular core
 Built-in shielding against static charges
 PEEK enclosure material (resistant to organic solvents, e.g. glycol)

Calibration: In air from 10 MHz to 2.5 GHz
 In brain simulating tissue at frequencies of 900 MHz and 1.8 GHz (accuracy $\pm 8\%$)

Frequency: 10 MHz to > 6 GHz; Linearity: ± 0.2 dB (30 MHz to 3 GHz)

Directivity: ± 0.2 dB in brain tissue (rotation around probe axis)
 ± 0.4 dB in brain tissue (rotation normal to probe axis)

Dynamic Range: $5 \mu\text{W/g}$ to > 100 mW/g; Linearity: ± 0.2 dB

Surface Detection: ± 0.2 mm repeatability in air and clear liquids over diffuse reflecting surfaces

Dimensions: Overall length: 330 mm
 Tip length: 16 mm
 Body diameter: 12 mm
 Tip diameter: 6.8 mm
 Distance from probe tip to dipole centers: 2.7 mm

Application: General dosimetry up to 3 GHz
 Compliance tests of mobile phone



ET3DV6 E-Field Probe

12.0 PLANAR PHANTOM

The planar phantom is constructed of Plexiglas material with a 2.0 mm shell thickness for face-held and body-worn SAR evaluations of handheld and body-worn radio transceivers. The planar phantom is mounted on the side of the DASY4 compact system table.



Planar Phantom

13.0 VALIDATION PLANAR PHANTOM

The validation planar phantom is constructed of Plexiglas material with a 6.0 mm shell thickness for system validations at 450MHz and below. The validation planar phantom is mounted in the table of the DASY4 compact system.



Validation Planar Phantom

14.0 DEVICE HOLDER

The DASY4 device holder has two scales for device rotation (with respect to the body axis) and the device inclination (with respect to the line between the ear openings). The plane between the ear openings and the mouth tip has a rotation angle of 65° . The bottom plate contains three pair of bolts for locking the device holder. The device holder positions are adjusted to the standard measurement positions in the three sections.



Device Holder

Applicant:	Vertex Standard Co., Ltd.	FCC ID:	K6610584720	IC ID:	511B-10584720	450 - 512 MHz
Model(s):	VX-821-G7-5, VX-824-G7-5, VX-829-G7-5, VX-871-G7-5, VX-874-G7-5, VX-879-G7-5			Portable FM UHF PTT Radio Transceiver		
2004 Celltech Labs Inc. This document is not to be reproduced in whole or in part without the written permission of Celltech Labs Inc.						10 of 20

15.0 TEST EQUIPMENT LIST

TEST EQUIPMENT	SERIAL NO.	CALIBRATION DATE
Schmid & Partner DASY4 System	-	-
-DASY4 Measurement Server	1078	N/A
-Robot	599396-01	N/A
-DAE3	370	May 2004
-DAE3	353	July 2004
-ET3DV6 E-Field Probe	1387	Mar 2004
-ET3DV6 E-Field Probe	1590	May 2004
-300MHz Validation Dipole	135	Oct 2004
-450MHz Validation Dipole	136	Nov 2004
-835MHz Validation Dipole	411	Mar 2004
-900MHz Validation Dipole	054	June 2004
-1800MHz Validation Dipole	247	June 2004
-1900MHz Validation Dipole	151	June 2004
-2450MHz Validation Dipole	150	Sept 2004
-SAM Phantom V4.0C	1033	N/A
-Barski Planar Phantom	03-01	N/A
-Plexiglas Planar Phantom	161	N/A
-Validation Planar Phantom	137	N/A
HP 85070C Dielectric Probe Kit	N/A	N/A
Gigatronics 8651A Power Meter	8650137	April 2004
Gigatronics 8652A Power Meter	1835267	April 2004
Gigatronics 80701A Power Sensor	1833535	April 2004
Gigatronics 80701A Power Sensor	1833542	April 2004
Gigatronics 80701A Power Sensor	1834350	April 2004
HP 8594E Spectrum Analyzer	3543A02721	April 2004
HP 8753E Network Analyzer	US38433013	April 2004
HP 8648D Signal Generator	3847A00611	April 2004
Amplifier Research 5S1G4 Power Amplifier	26235	N/A

16.0 MEASUREMENT UNCERTAINTIES

UNCERTAINTY BUDGET FOR DEVICE EVALUATION						
Error Description	Uncertainty Value ±%	Probability Distribution	Divisor	C_i 1g	Standard Uncertainty ±% (1g)	V_i OR V_{eff}
Measurement System						
Probe calibration	± 4.0	Normal	1	1	± 4.0	∞
Axial isotropy of the probe	± 4.7	Rectangular	√3	(1- C_p)	± 1.9	∞
Spherical isotropy of the probe	± 9.6	Rectangular	√3	(C_p)	± 3.9	∞
Spatial resolution	± 0.0	Rectangular	√3	1	± 0.0	∞
Boundary effects	± 5.5	Rectangular	√3	1	± 3.2	∞
Probe linearity	± 4.7	Rectangular	√3	1	± 2.7	∞
Detection limit	± 1.0	Rectangular	√3	1	± 0.6	∞
Readout electronics	± 1.0	Normal	1	1	± 1.0	∞
Response time	± 0.8	Rectangular	√3	1	± 0.5	∞
Integration time	± 1.4	Rectangular	√3	1	± 0.8	∞
RF ambient conditions	± 3.0	Rectangular	√3	1	± 1.7	∞
Mech. constraints of robot	± 0.4	Rectangular	√3	1	± 0.2	∞
Probe positioning	± 2.9	Rectangular	√3	1	± 1.7	∞
Extrapolation & integration	± 3.9	Rectangular	√3	1	± 2.3	∞
Test Sample Related						
Device positioning	± 6.0	Normal	√3	1	± 6.7	12
Device holder uncertainty	± 5.0	Normal	√3	1	± 5.9	8
Power drift	± 5.0	Rectangular	√3		± 2.9	∞
Phantom and Setup						
Phantom uncertainty	± 4.0	Rectangular	√3	1	± 2.3	∞
Liquid conductivity (target)	± 5.0	Rectangular	√3	0.6	± 1.7	∞
Liquid conductivity (measured)	± 5.0	Rectangular	√3	0.6	± 1.7	∞
Liquid permittivity (target)	± 5.0	Rectangular	√3	0.6	± 1.7	∞
Liquid permittivity (measured)	± 5.0	Rectangular	√3	0.6	± 1.7	∞
Combined Standard Uncertainty					± 13.03	
Expanded Uncertainty (k=2)					± 26.07	

Measurement Uncertainty Table in accordance with IEEE Standard 1528-2003 (see reference [5])

Applicant:	Vertex Standard Co., Ltd.	FCC ID:	K6610584720	IC ID:	511B-10584720	450 - 512 MHz
Model(s):	VX-821-G7-5, VX-824-G7-5, VX-829-G7-5, VX-871-G7-5, VX-874-G7-5, VX-879-G7-5			Portable FM UHF PTT Radio Transceiver		
2004 Celltech Labs Inc. This document is not to be reproduced in whole or in part without the written permission of Celltech Labs Inc.						12 of 20

MEASUREMENT UNCERTAINTIES (Cont.)

UNCERTAINTY BUDGET FOR SYSTEM VALIDATION						
Error Description	Uncertainty Value ±%	Probability Distribution	Divisor	C _i 1g	Standard Uncertainty ±% (1g)	V _i OR V _{eff}
Measurement System						
Probe calibration	± 4.0	Normal	1	1	± 4.0	∞
Axial isotropy of the probe	± 4.7	Rectangular	√3	(1-c _p)	± 1.9	∞
Spherical isotropy of the probe	± 9.6	Rectangular	√3	(c _p)	± 3.9	∞
Spatial resolution	± 0.0	Rectangular	√3	1	± 0.0	∞
Boundary effects	± 5.5	Rectangular	√3	1	± 3.2	∞
Probe linearity	± 4.7	Rectangular	√3	1	± 2.7	∞
Detection limit	± 1.0	Rectangular	√3	1	± 0.6	∞
Readout electronics	± 1.0	Normal	1	1	± 1.0	∞
Response time	± 0.8	Rectangular	√3	1	± 0.5	∞
Integration time	± 1.4	Rectangular	√3	1	± 0.8	∞
RF ambient conditions	± 3.0	Rectangular	√3	1	± 1.7	∞
Mech. constraints of robot	± 0.4	Rectangular	√3	1	± 0.2	∞
Probe positioning	± 2.9	Rectangular	√3	1	± 1.7	∞
Extrapolation & integration	± 3.9	Rectangular	√3	1	± 2.3	∞
Dipole						
Dipole Axis to Liquid Distance	± 2.0	Rectangular	√3	1	± 1.2	∞
Input Power	± 4.7	Rectangular	√3	1	± 2.7	∞
Phantom and Setup						
Phantom uncertainty	± 4.0	Rectangular	√3	1	± 2.3	∞
Liquid conductivity (target)	± 5.0	Rectangular	√3	0.6	± 1.7	∞
Liquid conductivity (measured)	± 5.0	Rectangular	√3	0.6	± 1.7	∞
Liquid permittivity (target)	± 5.0	Rectangular	√3	0.6	± 1.7	∞
Liquid permittivity (measured)	± 5.0	Rectangular	√3	0.6	± 1.7	∞
Combined Standard Uncertainty					± 9.58	
Expanded Uncertainty (k=2)					± 19.16	

Measurement Uncertainty Table in accordance with IEEE Standard 1528-2003 (see reference [5])

Applicant:	Vertex Standard Co., Ltd.	FCC ID:	K6610584720	IC ID:	511B-10584720	450 - 512 MHz
Model(s):	VX-821-G7-5, VX-824-G7-5, VX-829-G7-5, VX-871-G7-5, VX-874-G7-5, VX-879-G7-5			Portable FM UHF PTT Radio Transceiver		
2004 Celltech Labs Inc. This document is not to be reproduced in whole or in part without the written permission of Celltech Labs Inc.						13 of 20

Test Report S/N:	121004K66-T602-S90U
Test Date(s):	December 14, 2004
Test Type:	FCC/IC SAR Evaluation

17.0 REFERENCES

- [1] Federal Communications Commission, "Radiofrequency radiation exposure evaluation: portable devices", Rule Part 47 CFR §2.1093: 1999.
- [2] Health Canada, "Limits of Human Exposure to Radiofrequency Electromagnetic Fields in the Frequency Range from 3 kHz to 300 GHz", Safety Code 6.
- [3] Federal Communications Commission, "Evaluating Compliance with FCC Guidelines for Human Exposure to Radio frequency Electromagnetic Fields", OET Bulletin 65, Supplement C (Edition 01-01), FCC, Washington, D.C.: June 2001.
- [4] Industry Canada, "Evaluation Procedure for Mobile and Portable Radio Transmitters with respect to Health Canada's Safety Code 6 for Exposure of Humans to Radio Frequency Fields", Radio Standards Specification RSS-102 Issue 1 (Provisional): September 1999.
- [5] IEEE Std 1528-2003, "Recommended Practice for Determining the Peak Spatial-Average Specific Absorption Rate (SAR) in the Human Head from Wireless Communications Devices: Measurement Techniques": June 2003.

Applicant:	Vertex Standard Co., Ltd.	FCC ID:	K6610584720	IC ID:	511B-10584720	450 - 512 MHz
Model(s):	VX-821-G7-5, VX-824-G7-5, VX-829-G7-5, VX-871-G7-5, VX-874-G7-5, VX-879-G7-5		Portable FM UHF PTT Radio Transceiver			
2004 Celltech Labs Inc. This document is not to be reproduced in whole or in part without the written permission of Celltech Labs Inc. 14 of 20						

Test Report S/N:	121004K66-T602-S90U
Test Date(s):	December 14, 2004
Test Type:	FCC/IC SAR Evaluation

APPENDIX A - SAR MEASUREMENT DATA

Applicant:	Vertex Standard Co., Ltd.	FCC ID:	K6610584720	IC ID:	511B-10584720	450 - 512 MHz
Model(s):	VX-821-G7-5, VX-824-G7-5, VX-829-G7-5, VX-871-G7-5, VX-874-G7-5, VX-879-G7-5		Portable FM UHF PTT Radio Transceiver			
2004 Celltech Labs Inc.		This document is not to be reproduced in whole or in part without the written permission of Celltech Labs Inc.				15 of 20

Date Tested: 12/14/04

Face-Held SAR - Li-ion Battery (1150 mAh) - Whip Antenna (450-481 MHz)

DUT: Vertex Model: VX-829-G7-5; Type: Portable FM UHF PTT Radio Transceiver; Serial: 4M000012

Ambient Temp: 22.7 °C; Fluid Temp: 22.0 °C; Barometric Pressure: 102.6 kPa; Humidity: 30%

Communication System: FM UHF
 Antenna Type: Whip (P/N: ATU-6D)
 Frequency: 481 MHz; Duty Cycle: 1:1
 RF Output Power: 36.64 dBm (Conducted)
 7.4V 1150mAh Li-Ion Battery Pack (P/N: FNB-V86LI)
 Medium: HSL450 ($\sigma = 0.86 \text{ mho/m}$; $\epsilon_r = 43.1$; $\rho = 1000 \text{ kg/m}^3$)

- Probe: ET3DV6 - SN1387; ConvF(7.5, 7.5, 7.5); Calibrated: 18/03/2004
- Sensor-Surface: 4mm (Mechanical Surface Detection)
- Electronics: DAE3 Sn353; Calibrated: 06/07/2004
- Phantom: Planar; Type: Plexiglas; Serial: 161
- Measurement SW: DASY4, V4.3 Build 22; Postprocessing SW: SEMCAD, V1.8 Build 127

Face-Held - 2.5 cm Separation Distance - Mid Channel/Area Scan (8x19x1):

Measurement grid: dx=15mm, dy=15mm

Face-Held - 2.5 cm Separation Distance - Mid Channel/Zoom Scan (5x5x7)/Cube 0:

Measurement grid: dx=7.5mm, dy=7.5mm, dz=5mm
 Reference Value = 77.8 V/m; Power Drift = -0.434 dB
 Peak SAR (extrapolated) = 8.48 W/kg
SAR(1 g) = 5.45 mW/g; SAR(10 g) = 3.86 mW/g

Face-Held - 2.5 cm Separation Distance - Mid Channel/Zoom Scan 2 (7x7x7)/Cube 0:

Measurement grid: dx=5mm, dy=5mm, dz=5mm
 Reference Value = 76.9 V/m; Power Drift = -0.640 dB
 Peak SAR (extrapolated) = 8.53 W/kg
SAR(1 g) = 5.11 mW/g; SAR(10 g) = 3.34 mW/g

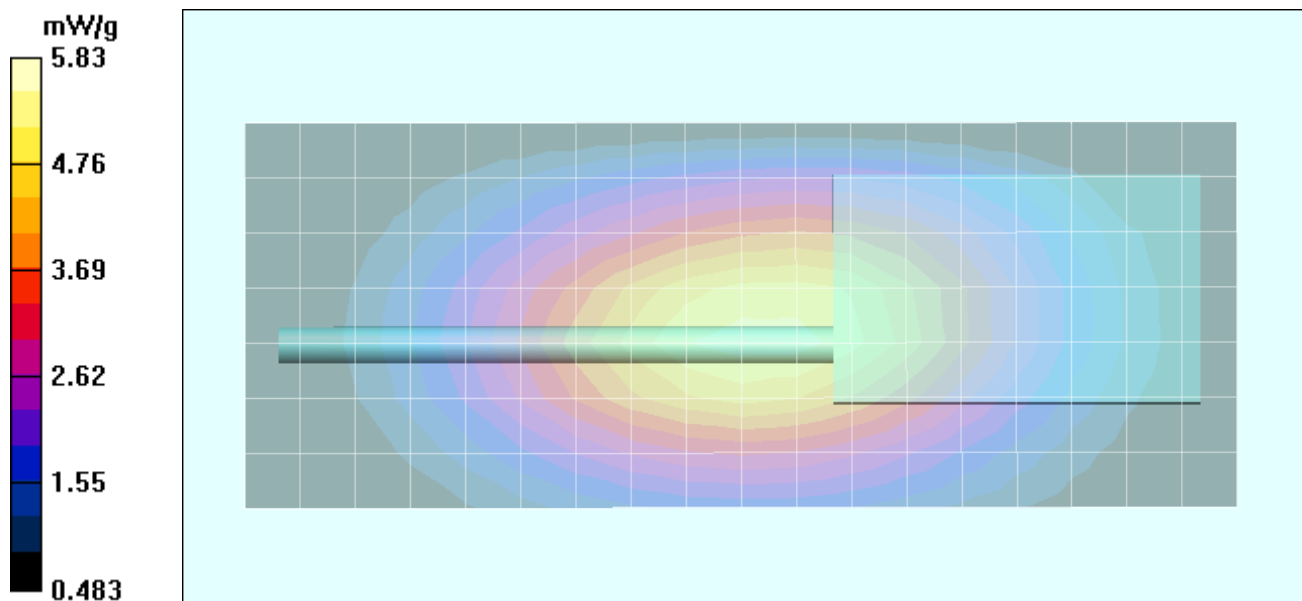

Applicant:	Vertex Standard Co., Ltd.	FCC ID:	K6610584720	IC ID:	511B-10584720	450 - 512 MHz	
Model(s):	VX-821-G7-5, VX-824-G7-5, VX-829-G7-5, VX-871-G7-5, VX-874-G7-5, VX-879-G7-5	Portable FM UHF PTT Radio Transceiver					
2004 Celltech Labs Inc.		This document is not to be reproduced in whole or in part without the written permission of Celltech Labs Inc.					

Date Tested: 12/14/04

Face-Held SAR - Li-ion Battery (2000 mAh) - Whip Antenna (450-481 MHz)

DUT: Vertex Model: VX-829-G7-5; Type: Portable FM UHF PTT Radio Transceiver; Serial: 4M000012

Ambient Temp: 22.7 °C; Fluid Temp: 22.0 °C; Barometric Pressure: 102.6 kPa; Humidity: 30%

Communication System: FM UHF
 Antenna Type: Whip (P/N: ATU-6D)
 Frequency: 481 MHz; Duty Cycle: 1:1
 RF Output Power: 36.61 dBm (Conducted)
 7.4V 2000mAh Li-Ion Battery Pack (P/N: FNB-V87LI)
 Medium: HSL450 ($\sigma = 0.86 \text{ mho/m}$; $\epsilon_r = 43.1$; $\rho = 1000 \text{ kg/m}^3$)

- Probe: ET3DV6 - SN1387; ConvF(7.5, 7.5, 7.5); Calibrated: 18/03/2004
- Sensor-Surface: 4mm (Mechanical Surface Detection)
- Electronics: DAE3 Sn353; Calibrated: 06/07/2004
- Phantom: Planar; Type: Plexiglas; Serial: 161
- Measurement SW: DASY4, V4.3 Build 22; Postprocessing SW: SEMCAD, V1.8 Build 127

Face-Held - 2.5 cm Separation Distance - Mid Channel/Area Scan (8x19x1):

Measurement grid: dx=15mm, dy=15mm

Face-Held - 2.5 cm Separation Distance - Mid Channel/Zoom Scan (5x5x7)/Cube 0:

Measurement grid: dx=7.5mm, dy=7.5mm, dz=5mm
 Reference Value = 79.8 V/m; Power Drift = -0.375 dB
 Peak SAR (extrapolated) = 8.8 W/kg
SAR(1 g) = 5.63 mW/g; SAR(10 g) = 3.99 mW/g

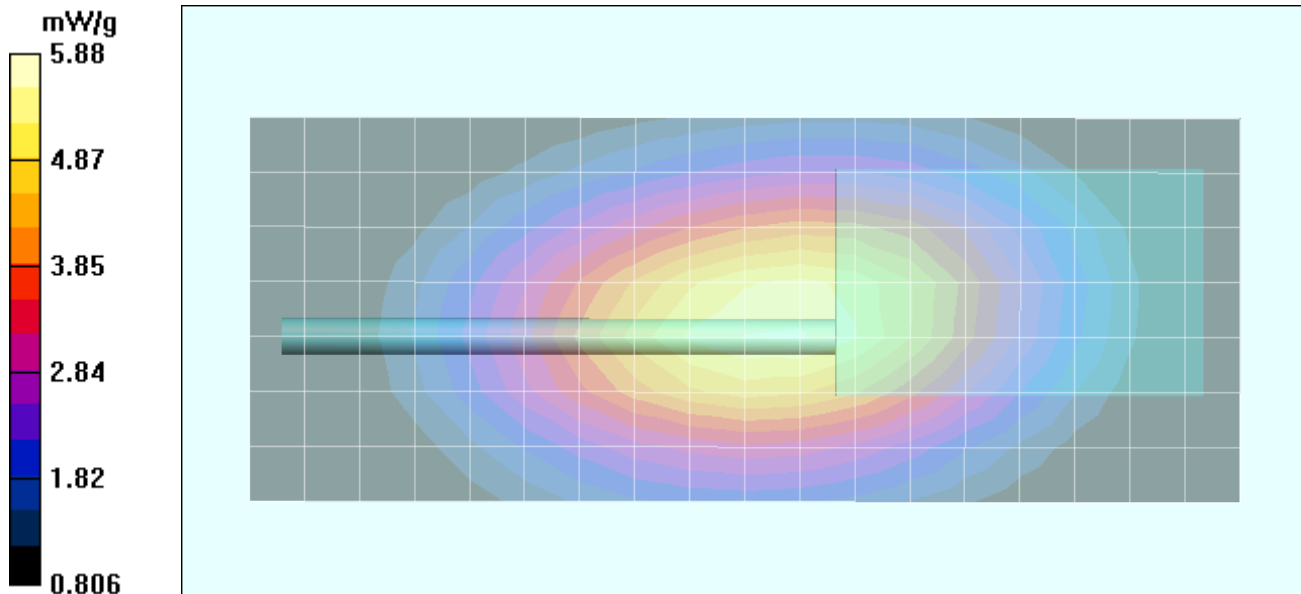

Applicant:	Vertex Standard Co., Ltd.	FCC ID:	K6610584720	IC ID:	511B-10584720	450 - 512 MHz	
Model(s):	VX-821-G7-5, VX-824-G7-5, VX-829-G7-5, VX-871-G7-5, VX-874-G7-5, VX-879-G7-5	Portable FM UHF PTT Radio Transceiver					
2004 Celltech Labs Inc.		This document is not to be reproduced in whole or in part without the written permission of Celltech Labs Inc.					

Z-Axis Scan

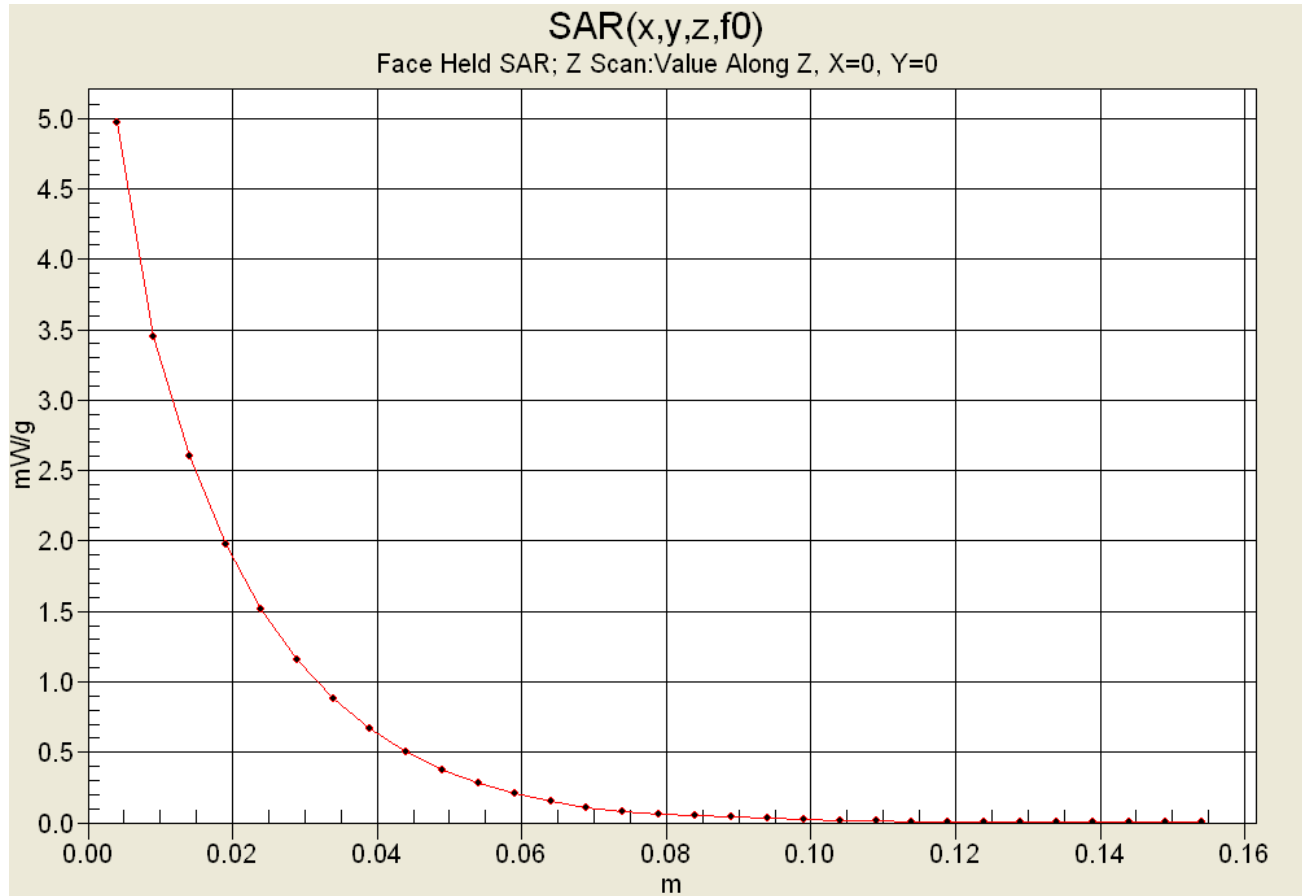

Applicant:	Vertex Standard Co., Ltd.	FCC ID:	K6610584720	IC ID:	511B-10584720	450 - 512 MHz	
Model(s):	VX-821-G7-5, VX-824-G7-5, VX-829-G7-5, VX-871-G7-5, VX-874-G7-5, VX-879-G7-5	Portable FM UHF PTT Radio Transceiver					
2004 Celltech Labs Inc.		This document is not to be reproduced in whole or in part without the written permission of Celltech Labs Inc.					

Date Tested: 12/14/04

Face-Held SAR - Li-ion Battery (2000 mAh) - Whip Antenna (512 MHz)

DUT: Vertex Model: VX-829-G7-5; Type: Portable FM UHF PTT Radio Transceiver; Serial: 4M000012

Ambient Temp: 22.7 °C; Fluid Temp: 22.0 °C; Barometric Pressure: 102.6 kPa; Humidity: 30%

Communication System: FM UHF
 Antenna Type: Whip (P/N: ATU-6F)
 Frequency: 512 MHz; Duty Cycle: 1:1
 RF Output Power: 37.02 dBm (Conducted)
 7.4V 2000mAh Li-Ion Battery Pack (P/N: FNB-V87LI)
 Medium: HSL450 ($\sigma = 0.86 \text{ mho/m}$; $\epsilon_r = 43.1$; $\rho = 1000 \text{ kg/m}^3$)

- Probe: ET3DV6 - SN1387; ConvF(7.5, 7.5, 7.5); Calibrated: 18/03/2004
- Sensor-Surface: 4mm (Mechanical Surface Detection)
- Electronics: DAE3 Sn353; Calibrated: 06/07/2004
- Phantom: Planar; Type: Plexiglas; Serial: 161
- Measurement SW: DASY4, V4.3 Build 22; Postprocessing SW: SEMCAD, V1.8 Build 127

Face-Held - 2.5 cm Separation Distance - High Channel/Area Scan (8x18x1):

Measurement grid: dx=15mm, dy=15mm

Face-Held - 2.5 cm Separation Distance - High Channel/Zoom Scan (5x5x7)/Cube 0:

Measurement grid: dx=7.5mm, dy=7.5mm, dz=5mm
 Reference Value = 68.9 V/m; Power Drift = 1.12 dB
 Peak SAR (extrapolated) = 8.09 W/kg
SAR(1 g) = 4.94 mW/g; SAR(10 g) = 3.18 mW/g

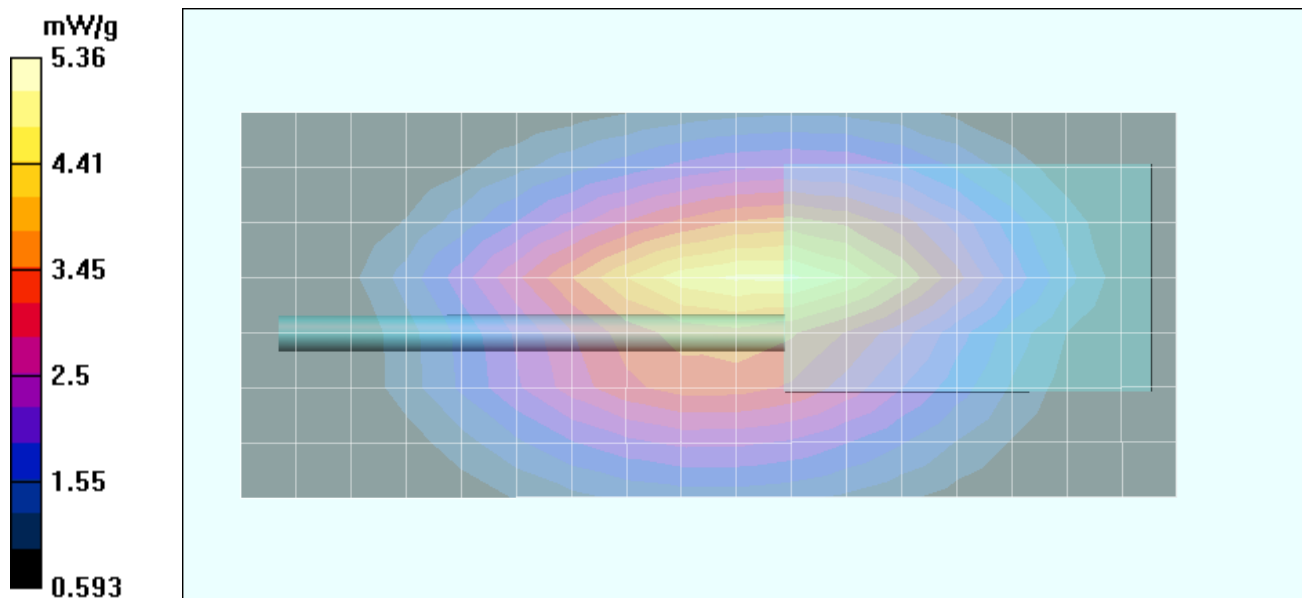

Applicant:	Vertex Standard Co., Ltd.	FCC ID:	K6610584720	IC ID:	511B-10584720	450 - 512 MHz
Model(s):	VX-821-G7-5, VX-824-G7-5, VX-829-G7-5, VX-871-G7-5, VX-874-G7-5, VX-879-G7-5		Portable FM UHF PTT Radio Transceiver			
2004 Celltech Labs Inc.		This document is not to be reproduced in whole or in part without the written permission of Celltech Labs Inc.				

Date Tested: 12/14/04

Body-Worn SAR - Li-ion Battery (1150 mAh) - Whip Antenna (450-481 MHz)

DUT: Vertex Model: VX-829-G7-5; Type: Portable FM UHF PTT Radio Transceiver; Serial: 4M000012

Body-Worn Accessories: Speaker-Microphone (P/N: MH-65A7A), Belt-Clip (P/N: CLIP-820)

Ambient Temp: 23.9 °C; Fluid Temp: 21.7 °C; Barometric Pressure: 103.0 kPa; Humidity: 30%

Communication System: FM UHF
 Antenna Type: Whip (P/N: ATU-6D)
 Frequency: 481 MHz; Duty Cycle: 1:1
 RF Output Power: 36.67 dBm (Conducted)
 7.4V 1150mAh Li-Ion Battery Pack (P/N: FNB-V86LI)
 Medium: M450 ($\sigma = 0.91$ mho/m; $\epsilon_r = 56.9$; $\rho = 1000$ kg/m³)

- Probe: ET3DV6 - SN1387; ConvF(7.6, 7.6, 7.6); Calibrated: 18/03/2004
- Sensor-Surface: 4mm (Mechanical Surface Detection)
- Electronics: DAE3 Sn353; Calibrated: 06/07/2004
- Phantom: Planar; Type: Plexiglas; Serial: 161
- Measurement SW: DASY4, V4.3 Build 22; Postprocessing SW: SEMCAD, V1.8 Build 127

Body-Worn - 1.2 cm Belt-Clip Separation Distance - Mid Channel/Area Scan (8x19x1):

Measurement grid: dx=15mm, dy=15mm

Body-Worn - 1.2 cm Belt-Clip Separation Distance - Mid Channel/Zoom Scan (5x5x7)/Cube 0:

Measurement grid: dx=7.5mm, dy=7.5mm, dz=5mm
 Reference Value = 95.8 V/m; Power Drift = -0.357 dB
 Peak SAR (extrapolated) = 12.9 W/kg
SAR(1 g) = 8.26 mW/g; SAR(10 g) = 5.87 mW/g

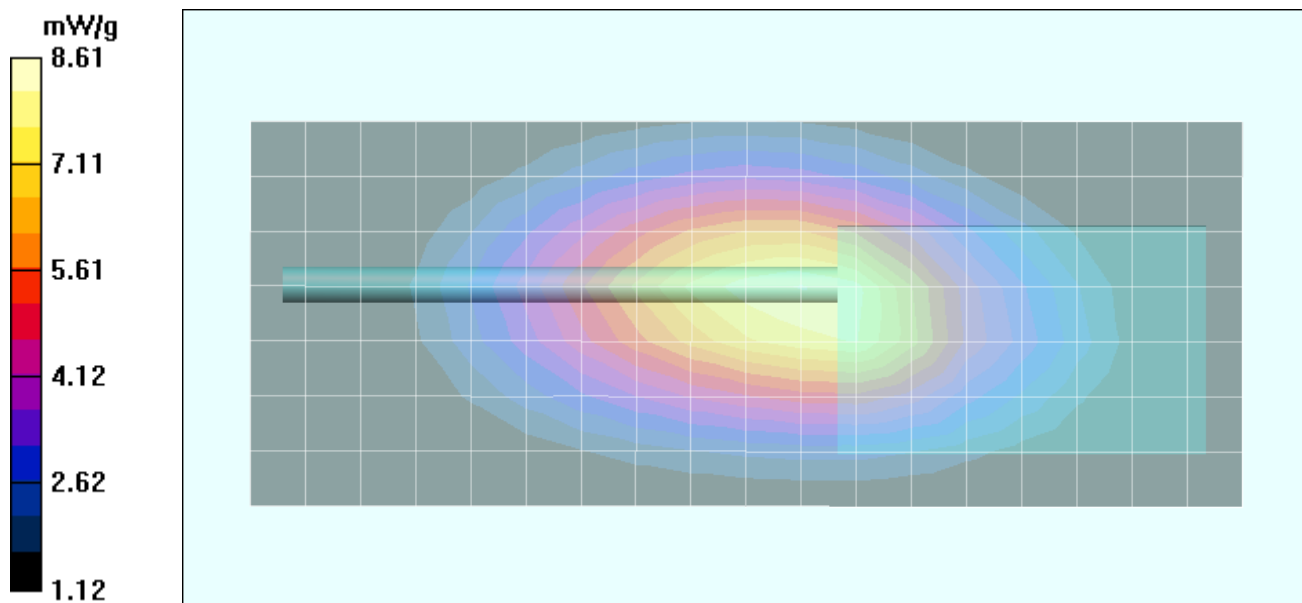

Applicant:	Vertex Standard Co., Ltd.	FCC ID:	K6610584720	IC ID:	511B-10584720	450 - 512 MHz
Model(s):	VX-821-G7-5, VX-824-G7-5, VX-829-G7-5, VX-871-G7-5, VX-874-G7-5, VX-879-G7-5		Portable FM UHF PTT Radio Transceiver			
2004 Celltech Labs Inc.		This document is not to be reproduced in whole or in part without the written permission of Celltech Labs Inc.				

Date Tested: 12/14/04

Body-Worn SAR - Li-ion Battery (2000 mAh) - Whip Antenna (450-481 MHz)

DUT: Vertex Model: VX-829-G7-5; Type: Portable FM UHF PTT Radio Transceiver; Serial: 4M000012

Body-Worn Accessories: Speaker-Microphone (P/N: MH-65A7A), Belt-Clip (P/N: CLIP-820)

Ambient Temp: 23.9 °C; Fluid Temp: 21.7 °C; Barometric Pressure: 103.0 kPa; Humidity: 30%

Communication System: FM UHF
 Antenna Type: Whip (P/N: ATU-6D)
 Frequency: 481 MHz; Duty Cycle: 1:1
 RF Output Power: 36.62 dBm (Conducted)
 7.4V 2000mAh Li-Ion Battery Pack (P/N: FNB-V87LI)
 Medium: M450 ($\sigma = 0.91$ mho/m; $\epsilon_r = 56.9$; $\rho = 1000$ kg/m³)

- Probe: ET3DV6 - SN1387; ConvF(7.6, 7.6, 7.6); Calibrated: 18/03/2004
- Sensor-Surface: 4mm (Mechanical Surface Detection)
- Electronics: DAE3 Sn353; Calibrated: 06/07/2004
- Phantom: Planar; Type: Plexiglas; Serial: 161
- Measurement SW: DASy4, V4.3 Build 22; Postprocessing SW: SEMCAD, V1.8 Build 127

Body-Worn - 0.8 cm Belt-Clip Separation Distance - Mid Channel/Area Scan (8x19x1):

Measurement grid: dx=15mm, dy=15mm

Body-Worn - 0.8 cm Belt-Clip Separation Distance - Mid Channel/Zoom Scan (5x5x7)/Cube 0:

Measurement grid: dx=7.5mm, dy=7.5mm, dz=5mm
 Reference Value = 99.4 V/m; Power Drift = -0.366 dB
 Peak SAR (extrapolated) = 13.7 W/kg
SAR(1 g) = 8.78 mW/g; SAR(10 g) = 6.23 mW/g

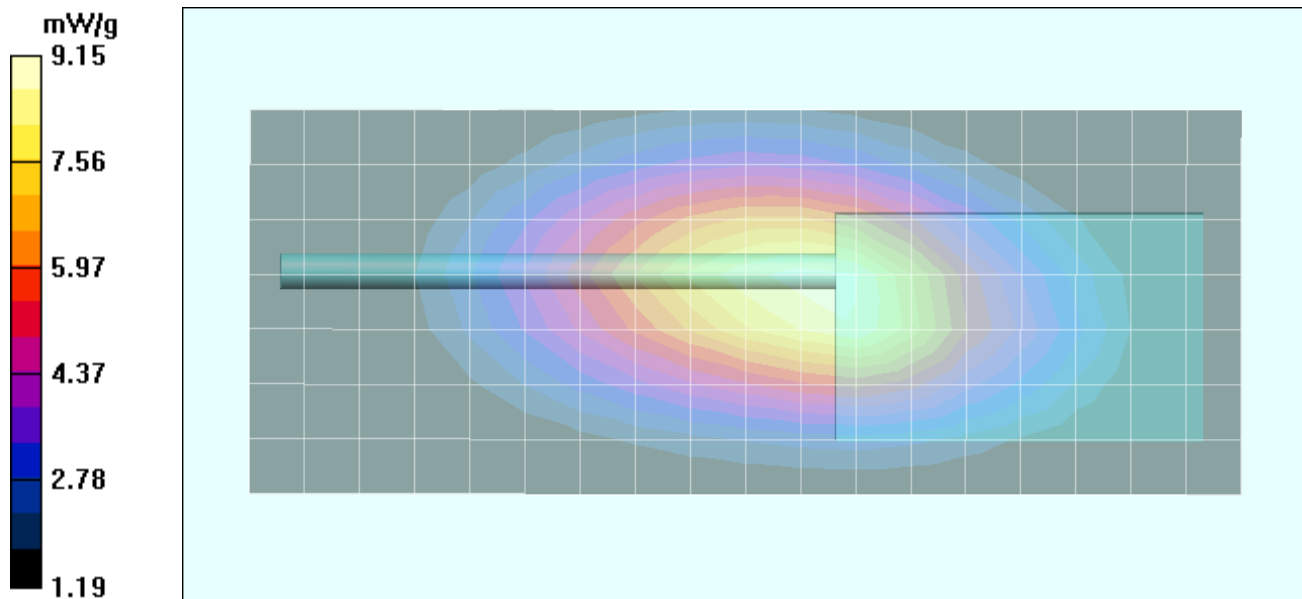

Applicant:	Vertex Standard Co., Ltd.	FCC ID:	K6610584720	IC ID:	511B-10584720	450 - 512 MHz
Model(s):	VX-821-G7-5, VX-824-G7-5, VX-829-G7-5, VX-871-G7-5, VX-874-G7-5, VX-879-G7-5		Portable FM UHF PTT Radio Transceiver			
2004 Celltech Labs Inc.		This document is not to be reproduced in whole or in part without the written permission of Celltech Labs Inc.				

Date Tested: 12/14/04

Body-Worn SAR - Li-ion Battery (2000 mAh) - Whip Antenna (450-481 MHz)

DUT: Vertex Model: VX-829-G7-5; Type: Portable FM UHF PTT Radio Transceiver; Serial: 4M000012

Body-Worn Accessories: Speaker-Microphone (P/N: MH-65A7A), Belt-Clip (P/N: CLIP-820)

Ambient Temp: 23.9 °C; Fluid Temp: 21.7 °C; Barometric Pressure: 103.0 kPa; Humidity: 30%

Communication System: FM UHF
 Antenna Type: Whip (P/N: ATU-6D)
 Frequency: 450 MHz; Duty Cycle: 1:1
 RF Output Power: 37.10 dBm (Conducted)
 7.4V 2000mAh Li-Ion Battery Pack (P/N: FNB-V87LI)
 Medium: M450 ($\sigma = 0.91$ mho/m; $\epsilon_r = 56.9$; $\rho = 1000$ kg/m³)

- Probe: ET3DV6 - SN1387; ConvF(7.6, 7.6, 7.6); Calibrated: 18/03/2004
- Sensor-Surface: 4mm (Mechanical Surface Detection)
- Electronics: DAE3 Sn353; Calibrated: 06/07/2004
- Phantom: Planar; Type: Plexiglas; Serial: 161
- Measurement SW: DASY4, V4.3 Build 22; Postprocessing SW: SEMCAD, V1.8 Build 127

Body-Worn - 0.8 cm Belt-Clip Separation Distance - Low Channel/Area Scan (8x19x1):

Measurement grid: dx=15mm, dy=15mm

Body-Worn - 0.8 cm Belt-Clip Separation Distance - Low Channel/Zoom Scan (5x5x7)/Cube 0:

Measurement grid: dx=7.5mm, dy=7.5mm, dz=5mm
 Reference Value = 100.9 V/m; Power Drift = -0.340 dB
 Peak SAR (extrapolated) = 14.4 W/kg
SAR(1 g) = 9.23 mW/g; SAR(10 g) = 6.55 mW/g

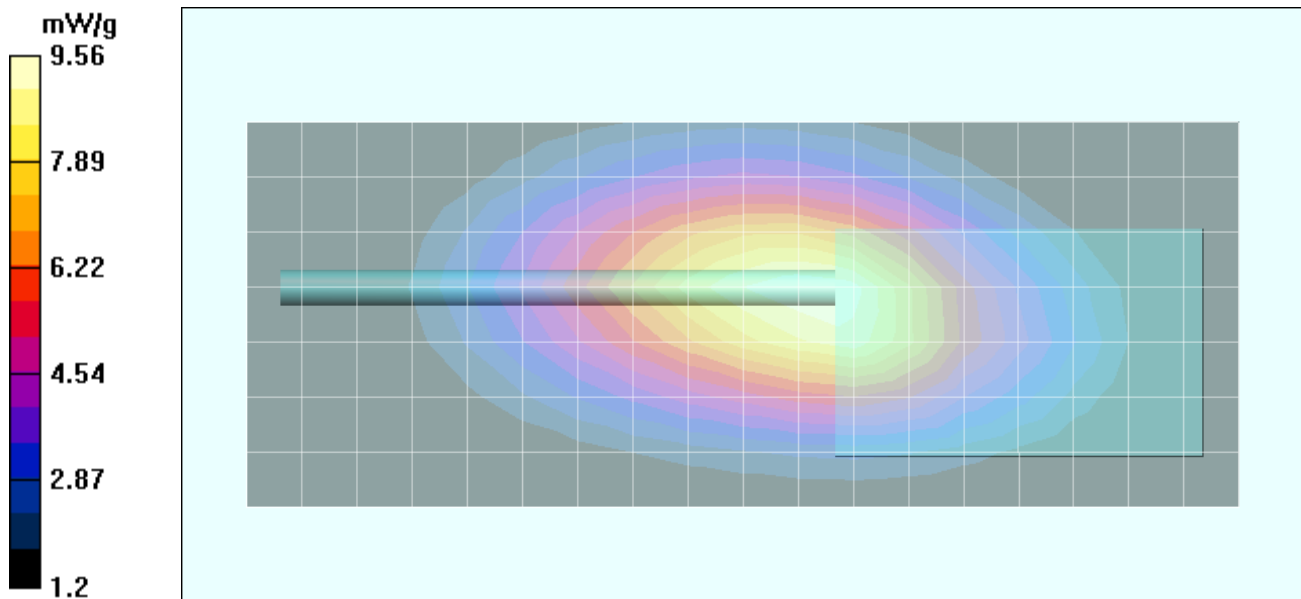

Applicant:	Vertex Standard Co., Ltd.	FCC ID:	K6610584720	IC ID:	511B-10584720	450 - 512 MHz
Model(s):	VX-821-G7-5, VX-824-G7-5, VX-829-G7-5, VX-871-G7-5, VX-874-G7-5, VX-879-G7-5		Portable FM UHF PTT Radio Transceiver			
2004 Celltech Labs Inc.		This document is not to be reproduced in whole or in part without the written permission of Celltech Labs Inc.				

Date Tested: 12/14/04

Body-Worn SAR - Li-ion Battery (2000 mAh) - Whip Antenna (512 MHz)

DUT: Vertex Model: VX-829-G7-5; Type: Portable FM UHF PTT Radio Transceiver; Serial: 4M000012

Body-Worn Accessories: Speaker-Microphone (P/N: MH-65A7A), Belt-Clip (P/N: CLIP-820)

Ambient Temp: 23.9 °C; Fluid Temp: 21.7 °C; Barometric Pressure: 103.0 kPa; Humidity: 30%

Communication System: FM UHF
 Antenna Type: Whip (P/N: ATU-6F)
 Frequency: 512 MHz; Duty Cycle: 1:1
 RF Output Power: 37.03 dBm (Conducted)
 7.4V 2000mAh Li-Ion Battery Pack (P/N: FNB-V87LI)
 Medium: M450 ($\sigma = 0.91$ mho/m; $\epsilon_r = 56.9$; $\rho = 1000$ kg/m³)

- Probe: ET3DV6 - SN1387; ConvF(7.6, 7.6, 7.6); Calibrated: 18/03/2004
- Sensor-Surface: 4mm (Mechanical Surface Detection)
- Electronics: DAE3 Sn353; Calibrated: 06/07/2004
- Phantom: Planar; Type: Plexiglas; Serial: 161
- Measurement SW: DASY4, V4.3 Build 22; Postprocessing SW: SEMCAD, V1.8 Build 127

Body-Worn - 0.8 cm Belt-Clip Separation Distance - High Channel/Area Scan (8x19x1):

Measurement grid: dx=15mm, dy=15mm

Body-Worn - 0.8 cm Belt-Clip Separation Distance - High Channel/Zoom Scan (5x5x7)/Cube 0:

Measurement grid: dx=7.5mm, dy=7.5mm, dz=5mm
 Reference Value = 105.9 V/m; Power Drift = -0.200 dB
 Peak SAR (extrapolated) = 15 W/kg
SAR(1 g) = 9.56 mW/g; SAR(10 g) = 6.73 mW/g

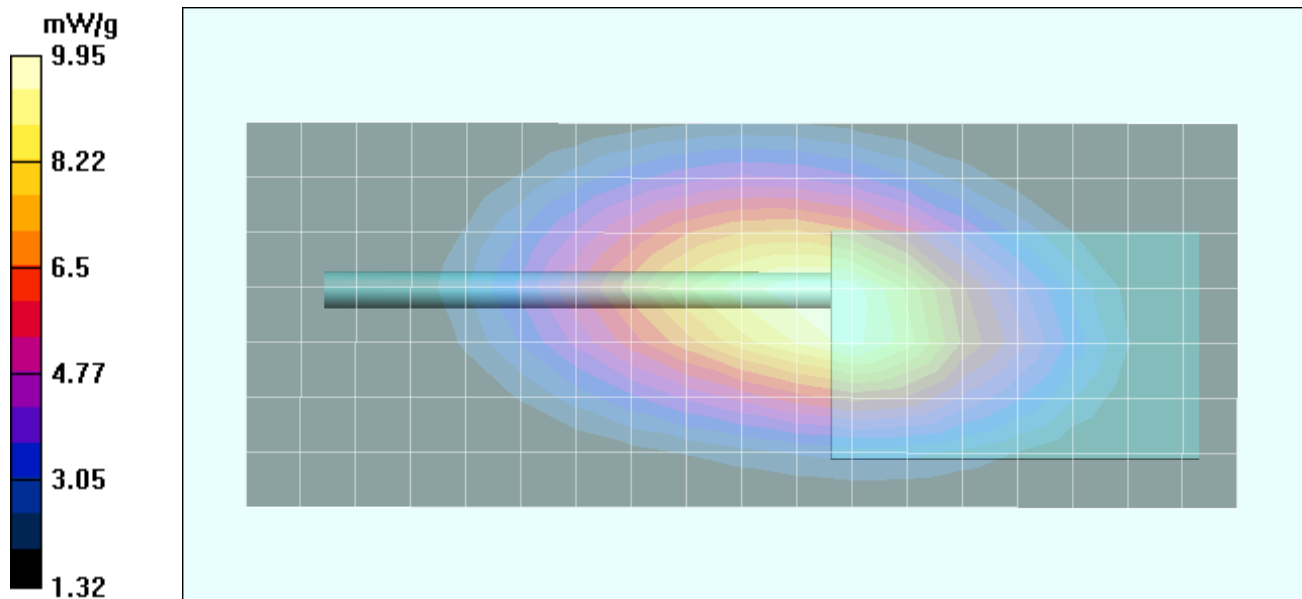

Applicant:	Vertex Standard Co., Ltd.	FCC ID:	K6610584720	IC ID:	511B-10584720	450 - 512 MHz	
Model(s):	VX-821-G7-5, VX-824-G7-5, VX-829-G7-5, VX-871-G7-5, VX-874-G7-5, VX-879-G7-5	Portable FM UHF PTT Radio Transceiver					
2004 Celltech Labs Inc.		This document is not to be reproduced in whole or in part without the written permission of Celltech Labs Inc.					

Z-Axis Scan

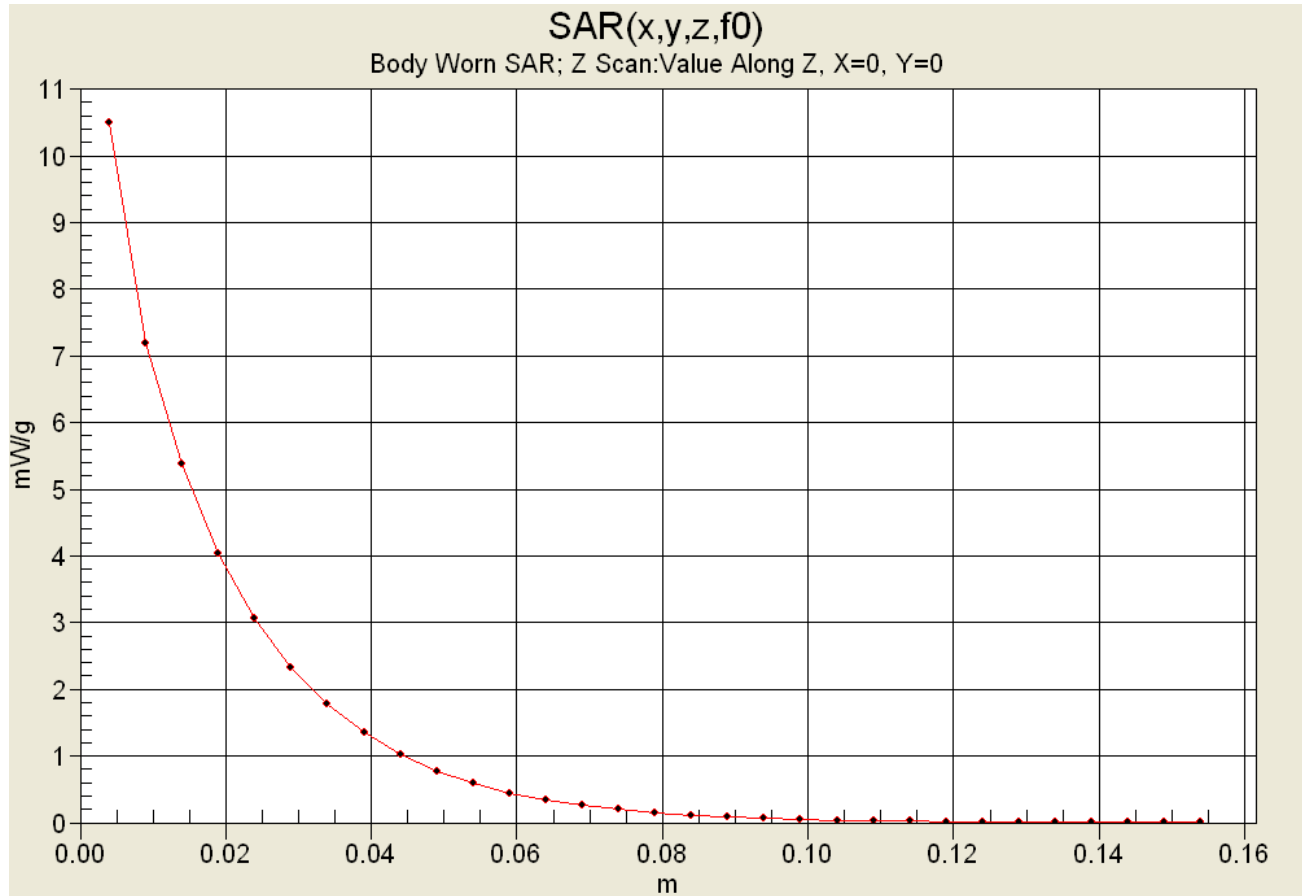

Applicant:	Vertex Standard Co., Ltd.	FCC ID:	K6610584720	IC ID:	511B-10584720	450 - 512 MHz
Model(s):	VX-821-G7-5, VX-824-G7-5, VX-829-G7-5, VX-871-G7-5, VX-874-G7-5, VX-879-G7-5		Portable FM UHF PTT Radio Transceiver			
2004 Celltech Labs Inc.		This document is not to be reproduced in whole or in part without the written permission of Celltech Labs Inc.				

SAR-versus-Time Power Drift Evaluation

Body-Worn with Belt-Clip and Speaker-Microphone
 2000 mAh Li-Ion Battery Pack (P/N: FNB-V87LI)
 Whip Antenna (512 MHz)
 High Channel (512 MHz)

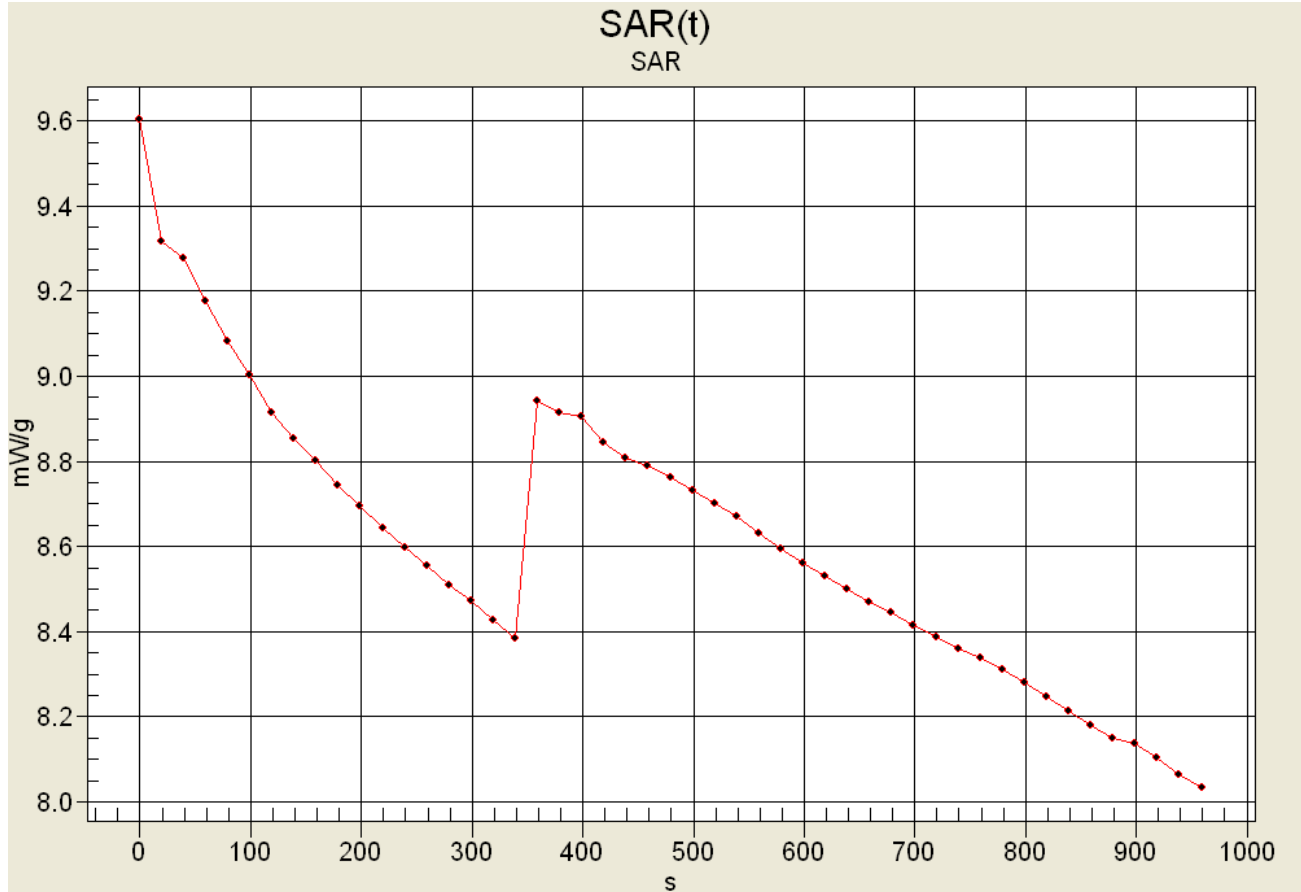

High SAR: 9.60279 mW/g
 Low SAR: 8.03438 mW/g (-0.7744 dB)
 SAR after 340s: 8.38521 MW/g (-0.5888 dB)
 (340s = Zoom Scan Duration)
 (960s = Area Scan Duration)

Applicant:	Vertex Standard Co., Ltd.	FCC ID:	K6610584720	IC ID:	511B-10584720	450 - 512 MHz
Model(s):	VX-821-G7-5, VX-824-G7-5, VX-829-G7-5, VX-871-G7-5, VX-874-G7-5, VX-879-G7-5		Portable FM UHF PTT Radio Transceiver			
2004 Celltech Labs Inc.		This document is not to be reproduced in whole or in part without the written permission of Celltech Labs Inc.				

Test Report S/N:	121004K66-T602-S90U
Test Date(s):	December 14, 2004
Test Type:	FCC/IC SAR Evaluation

APPENDIX B - SYSTEM PERFORMANCE CHECK DATA

Applicant:	Vertex Standard Co., Ltd.	FCC ID:	K6610584720	IC ID:	511B-10584720	450 - 512 MHz	
Model(s):	VX-821-G7-5, VX-824-G7-5, VX-829-G7-5, VX-871-G7-5, VX-874-G7-5, VX-879-G7-5	Portable FM UHF PTT Radio Transceiver					
2004 Celltech Labs Inc. This document is not to be reproduced in whole or in part without the written permission of Celltech Labs Inc. 16 of 20							

Date Tested: 12/14/04

System Performance Check - 450 MHz Dipole

DUT: Dipole 450 MHz; Model: D450V2; Type: System Performance Check; Serial: 136; Calibrated: 11/04/2004

Ambient Temp: 22.7 °C; Fluid Temp: 22.0 °C; Barometric Pressure: 102.6 kPa; Humidity: 30%

Communication System: CW
 Forward Conducted Power: 250 mW
 Frequency: 450 MHz; Duty Cycle: 1:1
 Medium: HSL450 ($\sigma = 0.86 \text{ mho/m}$; $\epsilon_r = 43.1$; $\rho = 1000 \text{ kg/m}^3$)

- Probe: ET3DV6 - SN1387; ConvF(7.5, 7.5, 7.5); Calibrated: 18/03/2004
- Sensor-Surface: 4mm (Mechanical Surface Detection)
- Electronics: DAE3 Sn353; Calibrated: 06/07/2004
- Phantom: Validation Planar; Type: Plexiglas; Serial: 137
- Measurement SW: DASY4, V4.3 Build 22; Postprocessing SW: SEMCAD, V1.8 Build 127

450 MHz Dipole - System Performance Check/Area Scan (6x11x1):

Measurement grid: dx=15mm, dy=15mm

450 MHz Dipole - System Performance Check/Zoom Scan (7x7x7)/Cube 0:

Measurement grid: dx=5mm, dy=5mm, dz=5mm
 Reference Value = 40 V/m; Power Drift = -0.0 dB
 Peak SAR (extrapolated) = 2.28 W/kg
SAR(1 g) = 1.30 mW/g; SAR(10 g) = 0.832 mW/g

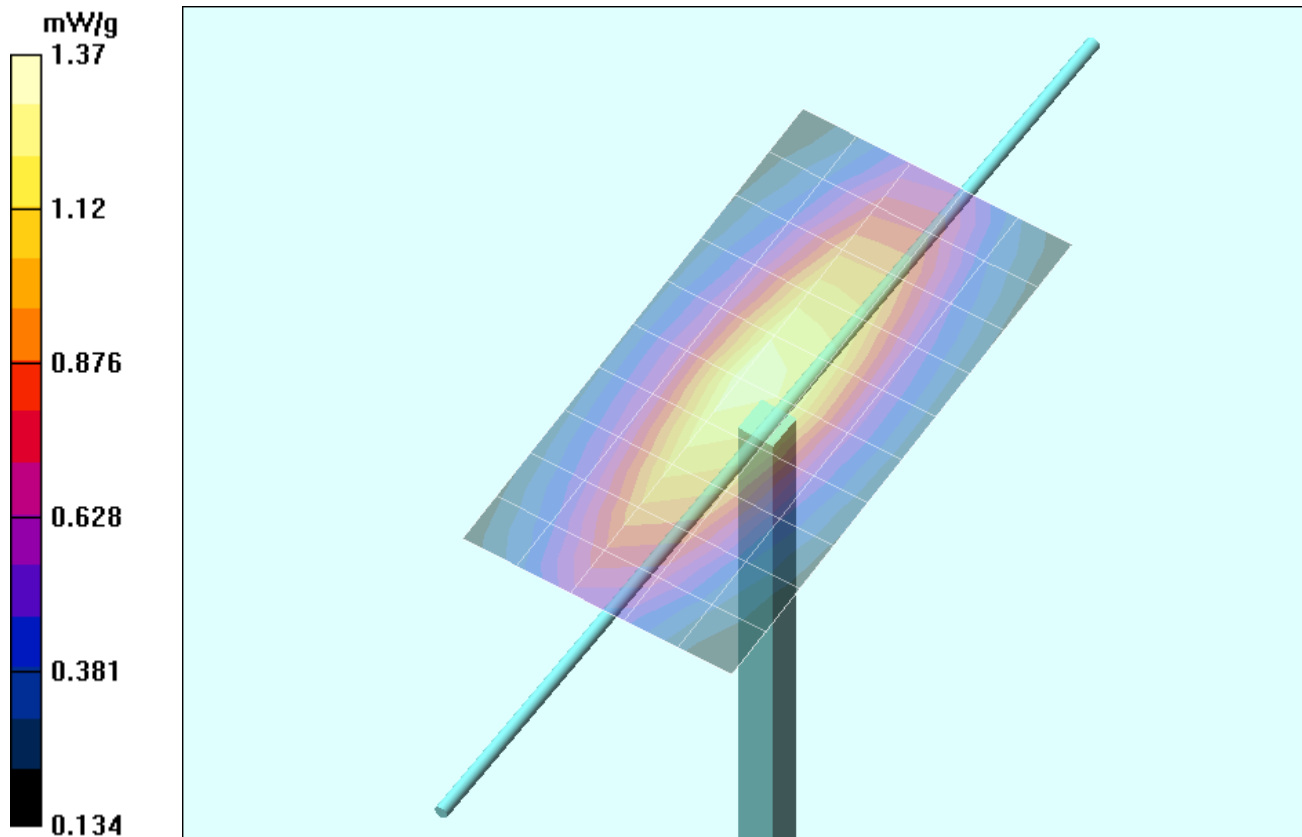

Applicant:	Vertex Standard Co., Ltd.	FCC ID:	K6610334720	IC ID:	511B-10334720	450 - 512 MHz
Model(s):	VX-921-G7-5, VX-924-G7-5, VX-929-G7-5, VX-971-G7-5, VX-974-G7-5, VX-979-G7-5		Portable FM UHF PTT Radio Transceiver			
2004 Celltech Labs Inc.		This document is not to be reproduced in whole or in part without the written permission of Celltech Labs Inc.				

Z-Axis Scan

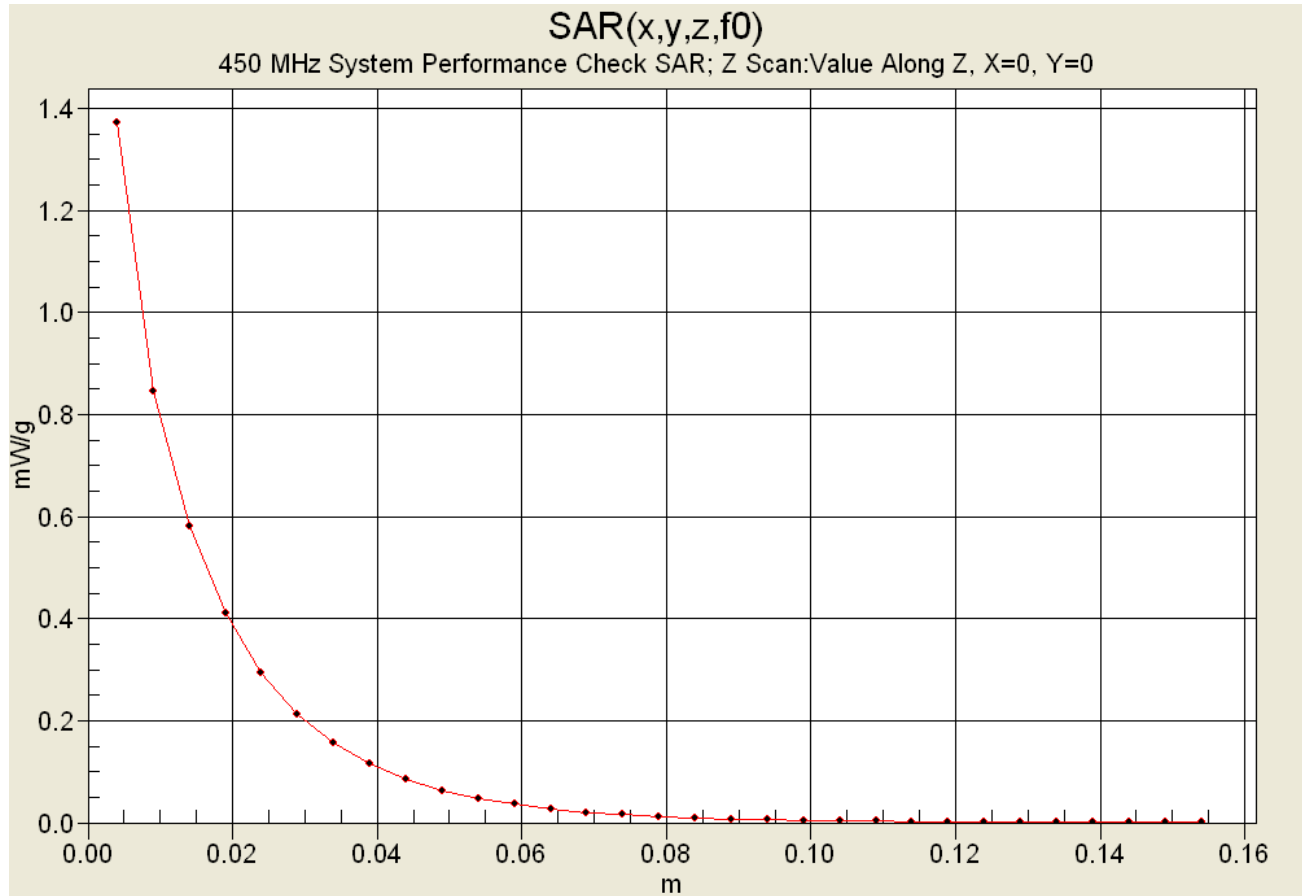

Applicant:	Vertex Standard Co., Ltd.	FCC ID:	K6610334720	IC ID:	511B-10334720	450 - 512 MHz
Model(s):	VX-921-G7-5, VX-924-G7-5, VX-929-G7-5, VX-971-G7-5, VX-974-G7-5, VX-979-G7-5		Portable FM UHF PTT Radio Transceiver			
2004 Celltech Labs Inc.		This document is not to be reproduced in whole or in part without the written permission of Celltech Labs Inc.				

Test Report S/N:	121004K66-T602-S90U
Test Date(s):	December 14, 2004
Test Type:	FCC/IC SAR Evaluation

APPENDIX C - SYSTEM VALIDATION

Applicant:	Vertex Standard Co., Ltd.	FCC ID:	K6610584720	IC ID:	511B-10584720	450 - 512 MHz
Model(s):	VX-821-G7-5, VX-824-G7-5, VX-829-G7-5, VX-871-G7-5, VX-874-G7-5, VX-879-G7-5	Portable FM UHF PTT Radio Transceiver				
2004 Celltech Labs Inc. This document is not to be reproduced in whole or in part without the written permission of Celltech Labs Inc. 17 of 20						

450 MHz SYSTEM VALIDATION DIPOLE

Type:

450 MHz Validation Dipole

Serial Number:

136

Place of Calibration:

Celltech Labs Inc.

Date of Calibration:

November 4, 2004

Celltech Labs Inc. hereby certifies that this device has been calibrated on the date indicated above.

Calibrated by:

Spencer Watson

Approved by:

Russell W. Pope

1. Dipole Construction & Electrical Characteristics

The validation dipole was constructed in accordance with the IEEE Std “Recommended Practice for Determining the Spatial-Peak Specific Absorption Rate (SAR) in the Human Body Due to Wireless Communications Devices: Experimental Techniques”. The electrical properties were measured using an HP 8753E Network Analyzer. The network analyzer was calibrated to the validation dipole N-type connector feed point using an HP85032E Type N calibration kit. The dipole was placed parallel to a planar phantom at a separation distance of 15.0mm from the simulating fluid using a loss-less dielectric spacer. The measured input impedance is:

Feed point impedance at 450MHz	$\text{Re}\{Z\} = 54.041\Omega$
	$\text{Im}\{Z\} = 5.5258\Omega$
Return Loss at 450MHz	-23.744dB

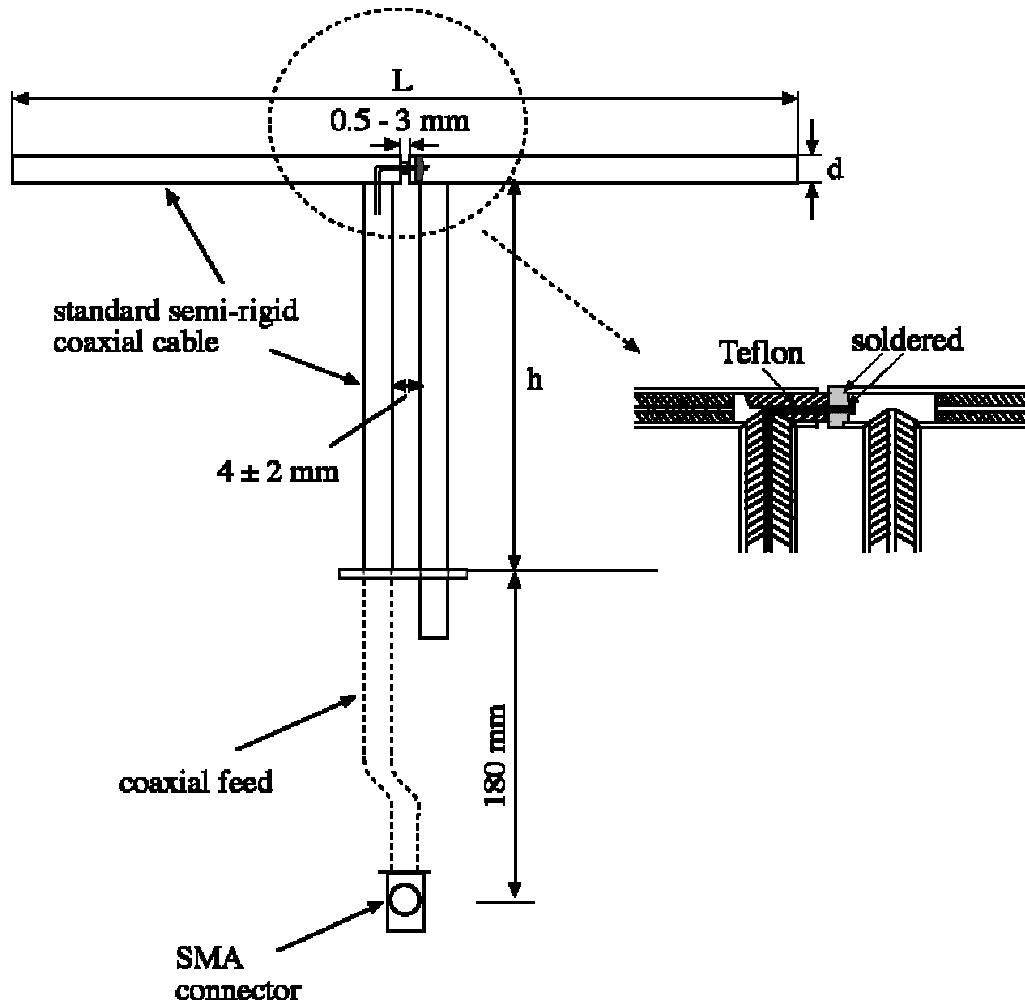

4 Nov 2004 09:03:54

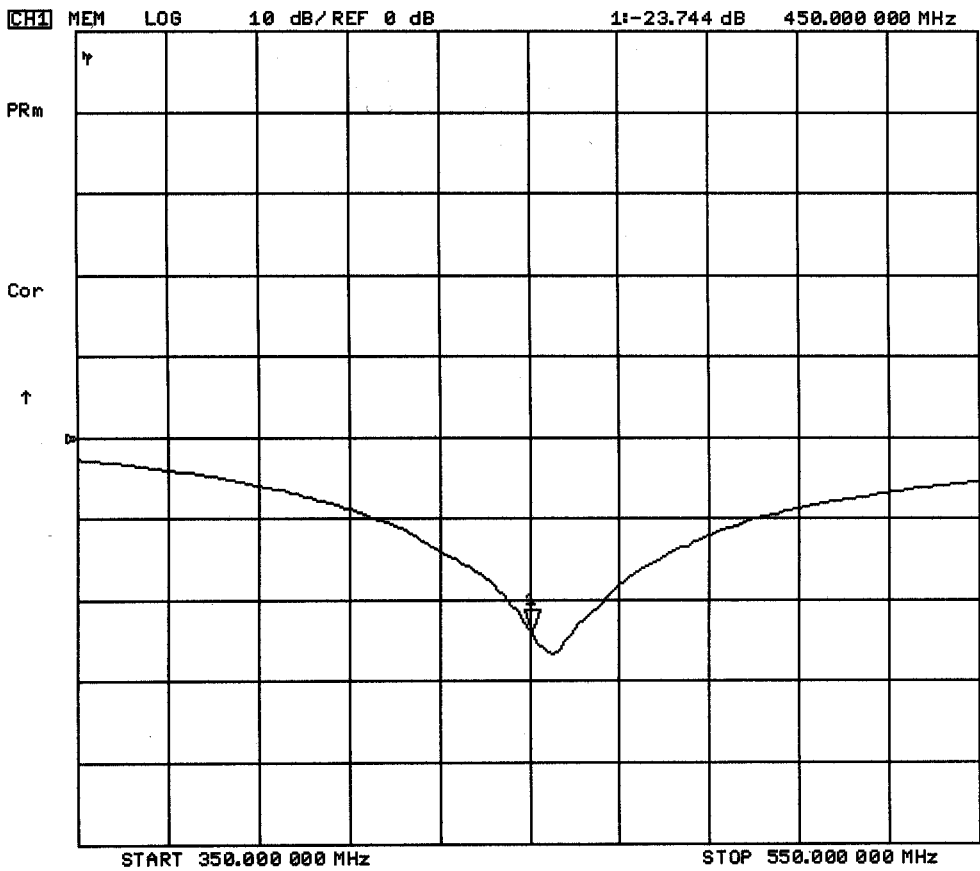

CH1 MEM 1 U FS

1: 54.041 Ω 5.4258 Ω 1.9190 nH

4 Nov 2004 09:05:08

450.000 000 MHz

PRn

Cor

↑

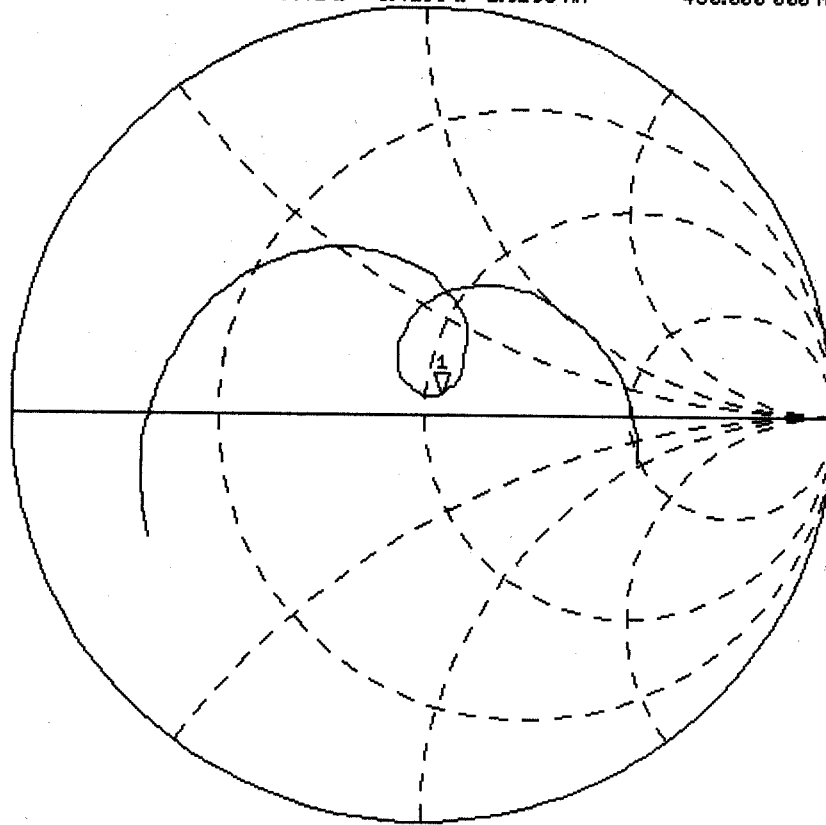

START 350.000 000 MHz

STOP 550.000 000 MHz

2. Validation Dipole Dimensions

Frequency (MHz)	L (mm)	h (mm)	d (mm)
300	420.0	250.0	6.2
450	288.0	167.0	6.2
835	161.0	89.8	3.6
900	149.0	83.3	3.6
1450	89.1	51.7	3.6
1800	72.0	41.7	3.6
1900	68.0	39.5	3.6
2000	64.5	37.5	3.6
2450	51.8	30.6	3.6
3000	41.5	25.0	3.6

3. Validation Phantom

The validation phantom was constructed using relatively low-loss tangent Plexiglas material. The inner dimensions of the phantom are as follows:

Length: 83.5 cm
 Width: 36.9 cm
 Height: 21.8 cm

The bottom section of the validation phantom is constructed of 6.2 ± 0.1 mm Plexiglas.

4. Dimensions of Plexiglas Planar Phantom

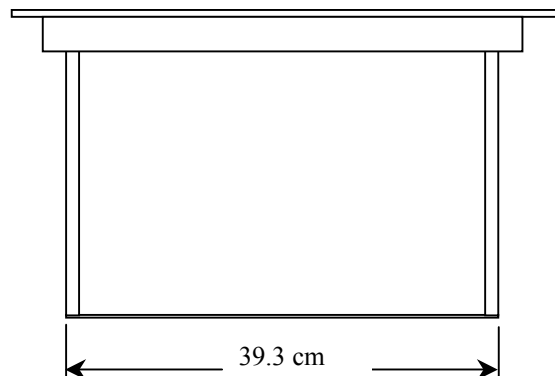
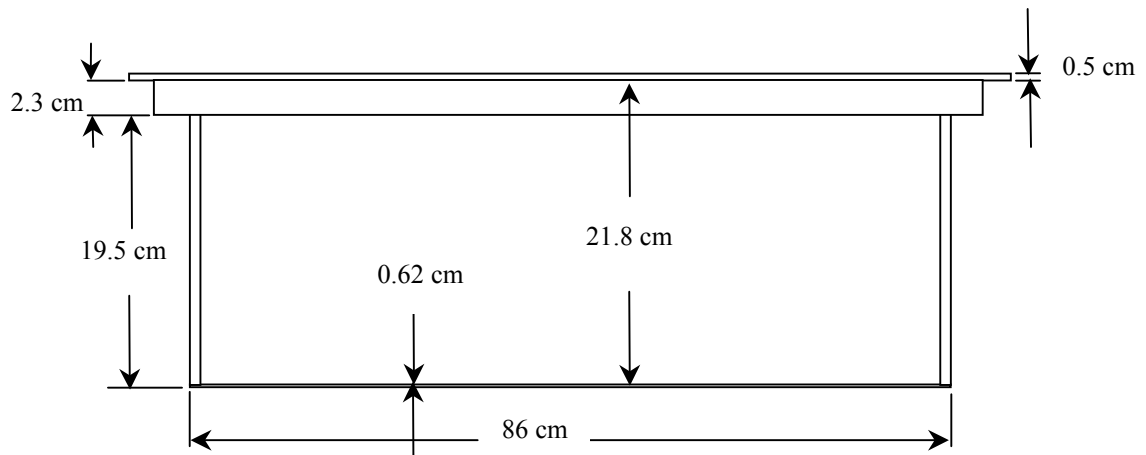
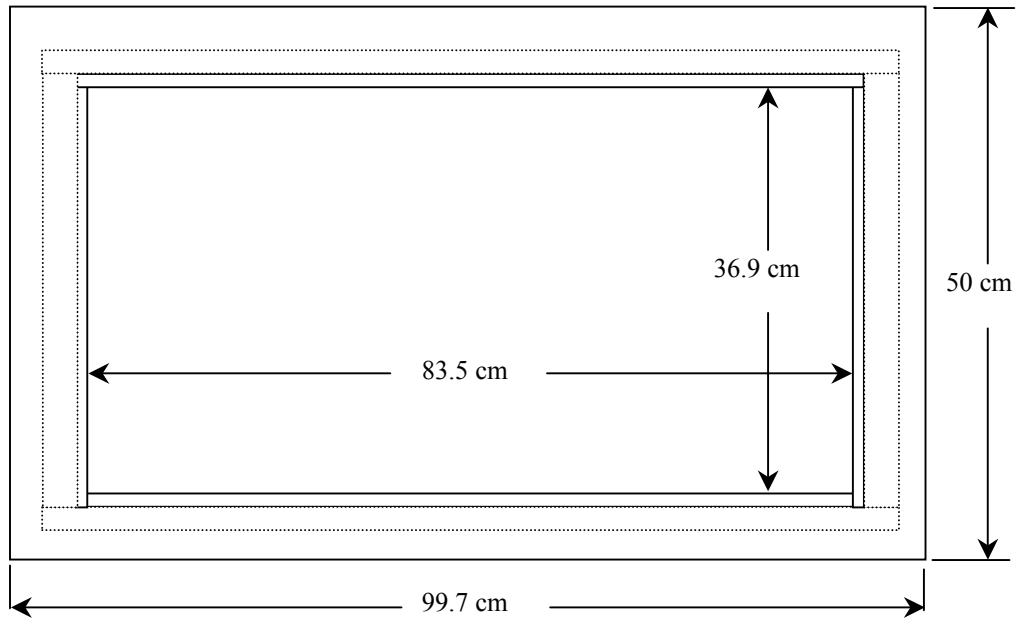

5. 450 MHz System Validation Setup



450 MHz Validation Dipole Setup



6. Measurement Conditions

The planar phantom was filled with brain simulating tissue having the following parameters at 450 MHz:

Relative Permittivity:	42.9
Conductivity:	0.85 mho/m
Fluid Temperature:	21.9 °C
Fluid Depth:	≥ 15.0 cm

Environmental Conditions:

Ambient Temperature:	22.4 °C
Humidity:	31 %
Barometric Pressure:	103.2 kPa

The 450 MHz simulated brain tissue mixture consists of the following ingredients:

Ingredient	Percentage by weight
Water	38.56%
Sugar	56.32%
Salt	3.95%
HEC	0.98%
Dowicil 75	0.19%
450 MHz Target Dielectric Parameters at 22 °C	$\epsilon_r = 43.5$ $\sigma = 0.87 \text{ S/m}$

7. SAR Measurement

The SAR measurement was performed with the E-field probe in mechanical detection mode only. The setup and determination of the forward power into the dipole was performed using the following procedures.

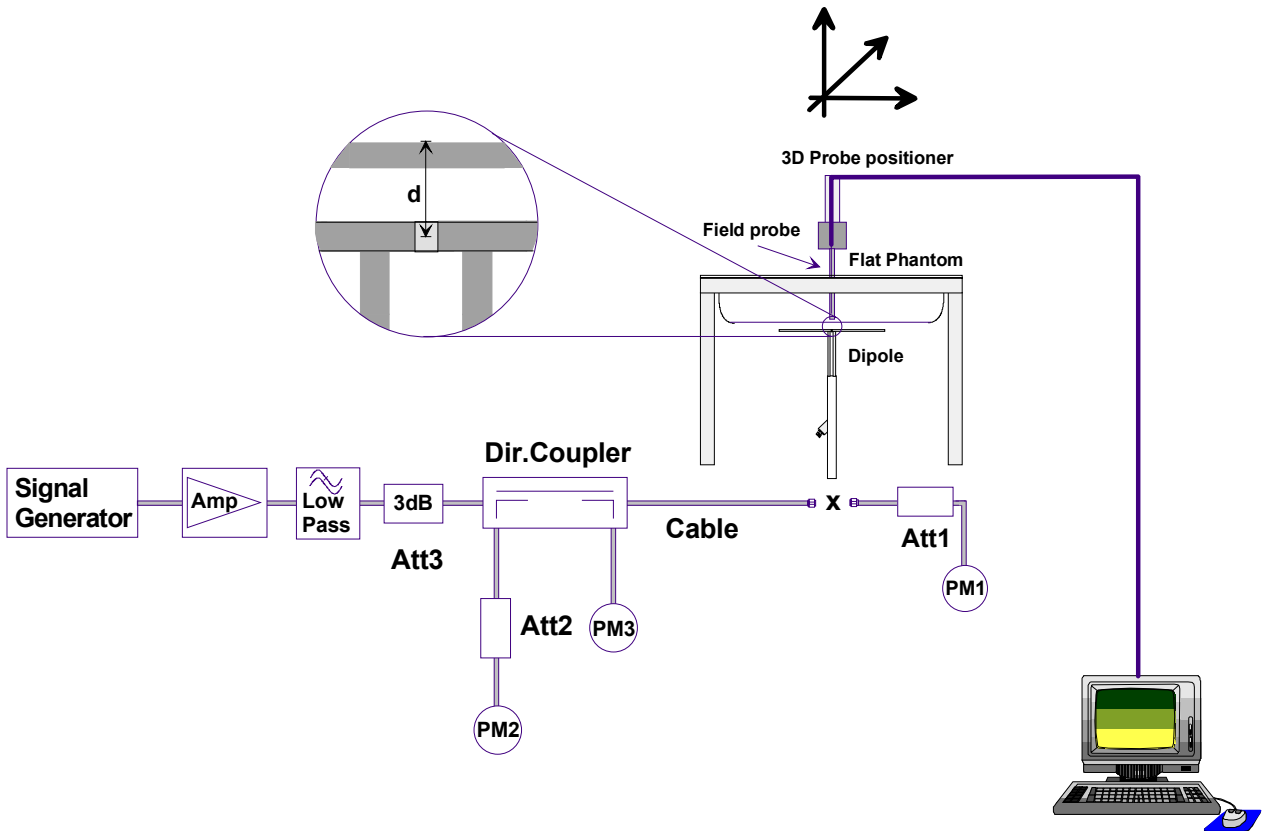

First the power meter PM1 (including attenuator Att1) is connected to the cable to measure the forward power at the location of the dipole connector (X). The signal generator is adjusted for the desired forward power at the dipole connector (taking into account the attenuation of Att1) as read by power meter PM2. After connecting the cable to the dipole, the signal generator is readjusted for the same reading at power meter PM2. If the signal generator does not allow adjustment in 0.01dB steps, the remaining difference at PM2 must be taken into consideration. PM3 records the reflected power from the dipole to ensure that the value is not changed from the previous value. The reflected power should be 20dB below the forward power.

8. Validation Dipole SAR Test Results

Ten SAR measurements were performed in order to achieve repeatability and to establish an average target value.

Validation Measurement	SAR @ 0.25W Input averaged over 1g	SAR @ 1W Input averaged over 1g	SAR @ 0.25W Input averaged over 10g	SAR @ 1W Input averaged over 10g	Peak SAR @ 0.25W Input
Test 1	1.22	4.88	0.782	3.128	1.29
Test 2	1.23	4.92	0.791	3.164	1.30
Test 3	1.23	4.92	0.789	3.156	1.30
Test 4	1.23	4.92	0.790	3.160	1.31
Test 5	1.24	4.96	0.793	3.172	1.31
Test 6	1.24	4.96	0.792	3.168	1.31
Test 7	1.23	4.92	0.791	3.164	1.31
Test 8	1.23	4.92	0.789	3.156	1.30
Test 9	1.24	4.96	0.791	3.164	1.31
Test 10	1.23	4.92	0.789	3.156	1.31
Average Value	1.23	4.93	0.790	3.16	1.31

The results have been normalized to 1W (forward power) into the dipole.

IEEE Target over 1cm³ (1g) of tissue: 4.9 mW/g (+/- 10%)

Averaged over 1cm (1g) of tissue: 4.93 mW/g (deviation +0.6%)

IEEE Target over 10cm³ (10g) of tissue: 3.3 mW/g (+/- 10%)

Averaged over 10cm (10g) of tissue: 3.16 mW/g (deviation -4.2%)

450 MHz System Validation - November 4, 2004

DUT: Dipole 450 MHz; Model: D450V2; Serial: 136; Calibrated: 11/04/2004

Ambient Temp: 22.4 °C; Fluid Temp: 21.9 °C; Barometric Pressure: 103.2 kPa; Humidity: 31%

Communication System: CW

Frequency: 450 MHz; Duty Cycle: 1:1

Medium: HSL450 ($\sigma = 0.85$ mho/m; $\epsilon_r = 42.9$; $\rho = 1000$ kg/m³)

- Probe: ET3DV6 - SN1387; ConvF(7.5, 7.5, 7.5); Calibrated: 18/03/2004

- Sensor-Surface: 4mm (Mechanical Surface Detection)

- Electronics: DAE3 Sn370; Calibrated: 14/05/2004

- Phantom: Validation Planar; Type: Plexiglas; Serial: 137

- Measurement SW: DASY4, V4.3 Build 22; Postprocessing SW: SEMCAD, V1.8 Build 127

450 MHz System Validation/Area Scan (6x11x1): Measurement grid: dx=15mm, dy=15mm

450 MHz System Validation/Zoom Scan (7x7x7)/Cube 0: Measurement grid: dx=5mm, dy=5mm, dz=5mm

Reference Value = 39.3 V/m; Power Drift = -0.1 dB

Peak SAR (extrapolated) = 2.15 W/kg

SAR(1 g) = 1.22 mW/g; SAR(10 g) = 0.782 mW/g

450 MHz System Validation/Zoom Scan 2 (7x7x7)/Cube 0: Measurement grid: dx=5mm, dy=5mm, dz=5mm

Reference Value = 39.2 V/m; Power Drift = -0.0 dB

Peak SAR (extrapolated) = 2.16 W/kg

SAR(1 g) = 1.23 mW/g; SAR(10 g) = 0.791 mW/g

450 MHz System Validation/Zoom Scan 3 (7x7x7)/Cube 0: Measurement grid: dx=5mm, dy=5mm, dz=5mm

Reference Value = 39.1 V/m; Power Drift = -0.004 dB

Peak SAR (extrapolated) = 2.16 W/kg

SAR(1 g) = 1.23 mW/g; SAR(10 g) = 0.789 mW/g

450 MHz System Validation/Zoom Scan 4 (7x7x7)/Cube 0: Measurement grid: dx=5mm, dy=5mm, dz=5mm

Reference Value = 39.2 V/m; Power Drift = -0.0 dB

Peak SAR (extrapolated) = 2.18 W/kg

SAR(1 g) = 1.23 mW/g; SAR(10 g) = 0.790 mW/g

450 MHz System Validation/Zoom Scan 5 (7x7x7)/Cube 0: Measurement grid: dx=5mm, dy=5mm, dz=5mm

Reference Value = 39.2 V/m; Power Drift = 0.009 dB

Peak SAR (extrapolated) = 2.18 W/kg

SAR(1 g) = 1.24 mW/g; SAR(10 g) = 0.793 mW/g

450 MHz System Validation/Zoom Scan 6 (7x7x7)/Cube 0: Measurement grid: dx=5mm, dy=5mm, dz=5mm

Reference Value = 39.1 V/m; Power Drift = 0.007 dB

Peak SAR (extrapolated) = 2.18 W/kg

SAR(1 g) = 1.24 mW/g; SAR(10 g) = 0.792 mW/g

450 MHz System Validation/Zoom Scan 7 (7x7x7)/Cube 0: Measurement grid: dx=5mm, dy=5mm, dz=5mm

Reference Value = 39.2 V/m; Power Drift = 0.004 dB

Peak SAR (extrapolated) = 2.18 W/kg

SAR(1 g) = 1.23 mW/g; SAR(10 g) = 0.791 mW/g

450 MHz System Validation/Zoom Scan 8 (7x7x7)/Cube 0: Measurement grid: dx=5mm, dy=5mm, dz=5mm

Reference Value = 39.2 V/m; Power Drift = 0.0 dB

Peak SAR (extrapolated) = 2.16 W/kg

SAR(1 g) = 1.23 mW/g; SAR(10 g) = 0.789 mW/g

450 MHz System Validation/Zoom Scan 9 (7x7x7)/Cube 0: Measurement grid: dx=5mm, dy=5mm, dz=5mm

Reference Value = 39.4 V/m; Power Drift = 0.0 dB

Peak SAR (extrapolated) = 2.19 W/kg

SAR(1 g) = 1.24 mW/g; SAR(10 g) = 0.791 mW/g

450 MHz System Validation/Zoom Scan 10 (7x7x7)/Cube 0: Measurement grid: dx=5mm, dy=5mm, dz=5mm

Reference Value = 39.1 V/m; Power Drift = 0.007 dB

Peak SAR (extrapolated) = 2.16 W/kg

SAR(1 g) = 1.23 mW/g; SAR(10 g) = 0.789 mW/g

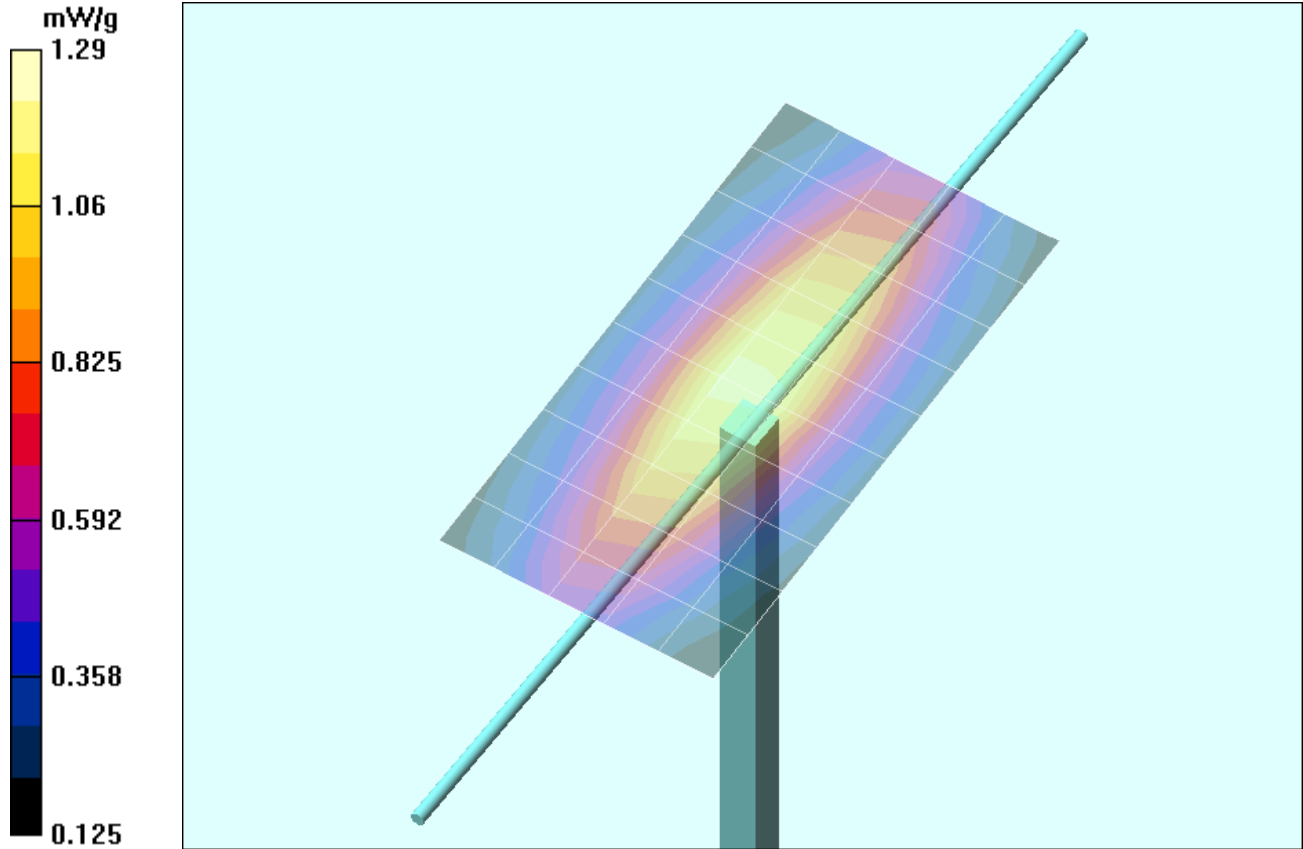

1 g average of 10 measurements: 1.23 mW/g
10 g average of 10 measurements: 0.790 mW/g

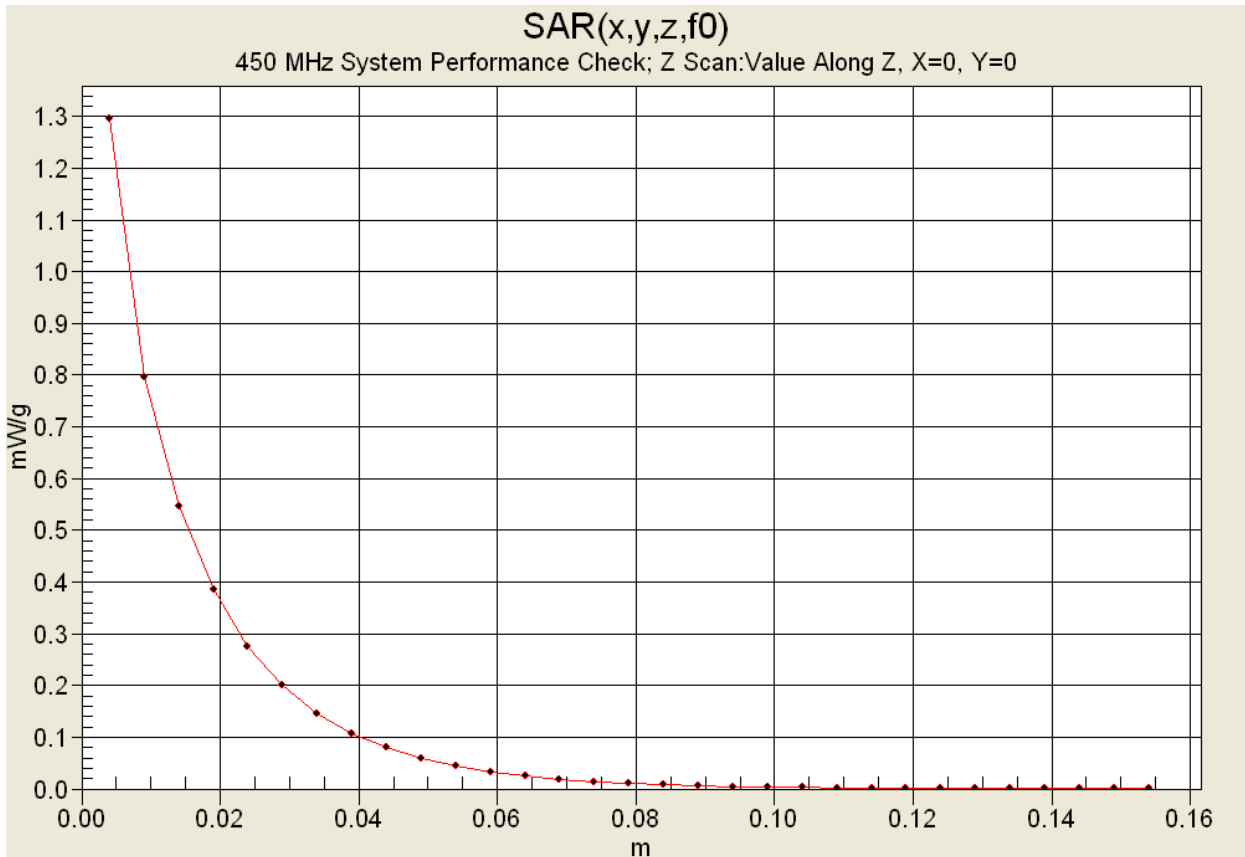

450MHz System Validation

Measured Fluid Dielectric Parameters (Brain)

November 04, 2004

Frequency	ϵ'	ϵ''
350.000000 MHz	45.3974	39.4988
360.000000 MHz	45.0834	38.7858
370.000000 MHz	44.8651	38.1777
380.000000 MHz	44.6622	37.6103
390.000000 MHz	44.3761	37.1472
400.000000 MHz	44.1745	36.5919
410.000000 MHz	43.8392	36.0417
420.000000 MHz	43.6277	35.5608
430.000000 MHz	43.3443	34.9958
440.000000 MHz	43.1200	34.5629
450.000000 MHz	42.8999	34.1583
460.000000 MHz	42.7154	33.7478
470.000000 MHz	42.4773	33.4083
480.000000 MHz	42.2998	33.0563
490.000000 MHz	42.0302	32.7340
500.000000 MHz	41.8641	32.3576
510.000000 MHz	41.6518	31.9703
520.000000 MHz	41.4863	31.6232
530.000000 MHz	41.2685	31.3144
540.000000 MHz	41.1027	30.8977
550.000000 MHz	40.9455	30.6347

Test Report S/N:	121004K66-T602-S90U
Test Date(s):	December 14, 2004
Test Type:	FCC/IC SAR Evaluation

APPENDIX D - PROBE CALIBRATION

Applicant:	Vertex Standard Co., Ltd.	FCC ID:	K6610584720	IC ID:	511B-10584720	450 - 512 MHz
Model(s):	VX-821-G7-5, VX-824-G7-5, VX-829-G7-5, VX-871-G7-5, VX-874-G7-5, VX-879-G7-5		Portable FM UHF PTT Radio Transceiver			
2004 Celltech Labs Inc. This document is not to be reproduced in whole or in part without the written permission of Celltech Labs Inc. 18 of 20						

Client **Celltech**

CALIBRATION CERTIFICATE

Object(s) **ET3DV6 - SN:1387**

Calibration procedure(s) **QA CAL-01.v2
Calibration procedure for dosimetric E-field probes**

Calibration date: **March 18, 2004**



Condition of the calibrated item **In Tolerance (according to the specific calibration document)**

This calibration certificate documents the traceability to national standards, which realize the physical units of measurements (SI). The measurements and the uncertainties with confidence probability are given on the following pages and are part of the certificate.

All calibrations have been conducted in the closed laboratory facility: environment temperature 22 +/- 2 degrees Celsius and humidity < 75%.

Calibration Equipment used (M&TE critical for calibration)

Model Type	ID #	Cal Date (Calibrated by, Certificate No.)	Scheduled Calibration
Power meter EPM E4419B	GB41293874	2-Apr-03 (METAS, No 252-0250)	Apr-04
Power sensor E4412A	MY41495277	2-Apr-03 (METAS, No 252-0250)	Apr-04
Reference 20 dB Attenuator	SN: 5086 (20b)	3-Apr-03 (METAS, No. 251-0340)	Apr-04
Fluke Process Calibrator Type 702	SN: 6295803	8-Sep-03 (Sintrel SCS No. E-030020)	Sep-04
Power sensor HP 8481A	MY41092180	18-Sep-02 (SPEAG, in house check Oct-03)	In house check: Oct 05
RF generator HP 8684C	US3642U01700	4-Aug-99 (SPEAG, in house check Aug-02)	In house check: Aug-05
Network Analyzer HP 8753E	US37390585	18-Oct-01 (SPEAG, in house check Oct-03)	In house check: Oct 05

	Name	Function	Signature
Calibrated by:	Nico Vetterli	Technician	
Approved by:	Katja Pokovic	Laboratory Director	

Date issued: March 18, 2004

This calibration certificate is issued as an intermediate solution until the accreditation process (based on ISO/IEC 17025 International Standard) for Calibration Laboratory of Schmid & Partner Engineering AG is completed.

Probe ET3DV6

SN:1387

Manufactured:	September 21, 1999
Last calibrated:	February 26, 2003
Recalibrated:	March 18, 2004

Calibrated for DASYS Systems

(Note: non-compatible with DASYS2 system!)

DASY - Parameters of Probe: ET3DV6 SN:1387

Sensitivity in Free Space

NormX	1.62 $\mu\text{V}/(\text{V}/\text{m})^2$
NormY	1.71 $\mu\text{V}/(\text{V}/\text{m})^2$
NormZ	1.71 $\mu\text{V}/(\text{V}/\text{m})^2$

Diode Compression^A

DCP X	92	mV
DCP Y	92	mV
DCP Z	92	mV

Sensitivity in Tissue Simulating Liquid (Conversion Factors)

Please see Page 7.

Boundary Effect

Head 900 MHz Typical SAR gradient: 5 % per mm

Sensor Cener to Phantom Surface Distance		3.7 mm	4.7 mm
SAR _{be} [%]	Without Correction Algorithm	9.3	4.4
SAR _{be} [%]	With Correction Algorithm	0.0	0.1

Head 1800 MHz Typical SAR gradient: 10 % per mm

Sensor to Surface Distance		3.7 mm	4.7 mm
SAR _{be} [%]	Without Correction Algorithm	14.8	10.0
SAR _{be} [%]	With Correction Algorithm	0.2	0.0

Sensor Offset

Probe Tip to Sensor Center	2.7 mm
Optical Surface Detection	in tolerance

The reported uncertainty of measurement is stated as the standard uncertainty of measurement multiplied by the coverage factor k=2, which for a normal distribution corresponds to a coverage probability of approximately 95%.

^A numerical linearization parameter: uncertainty not required

Frequency Response of E-Field

(TEM-Cell:ifi110, Waveguide R22)

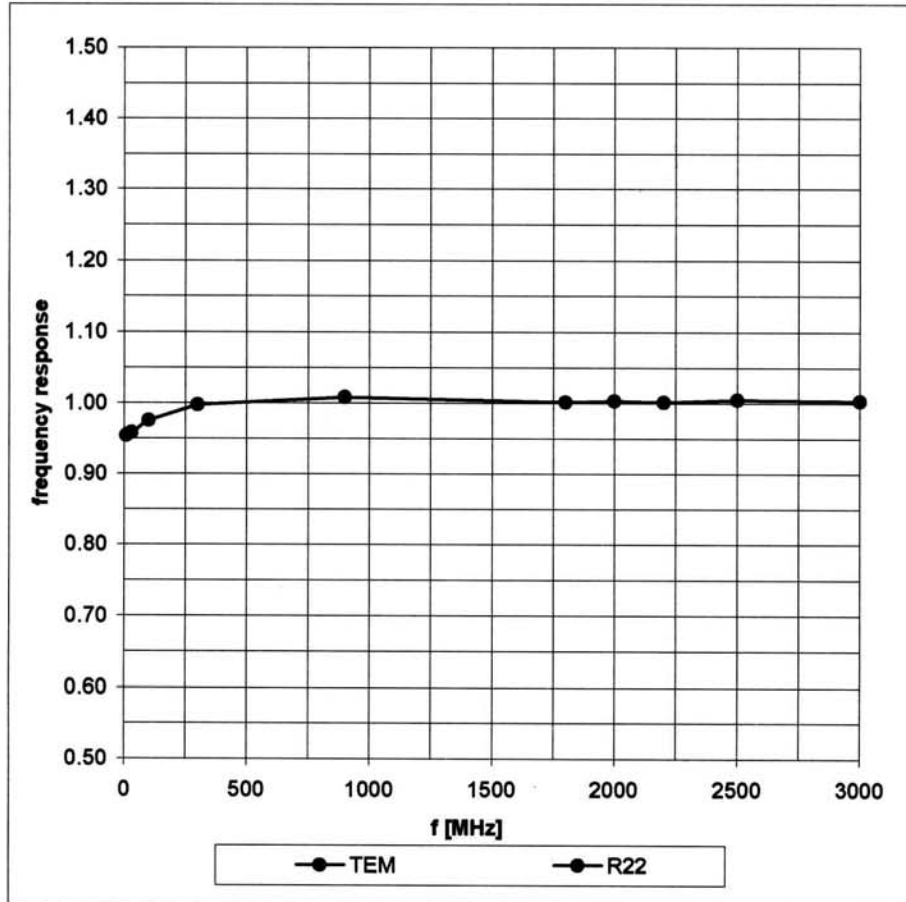

Receiving Pattern (ϕ) , $\theta = 0^\circ$

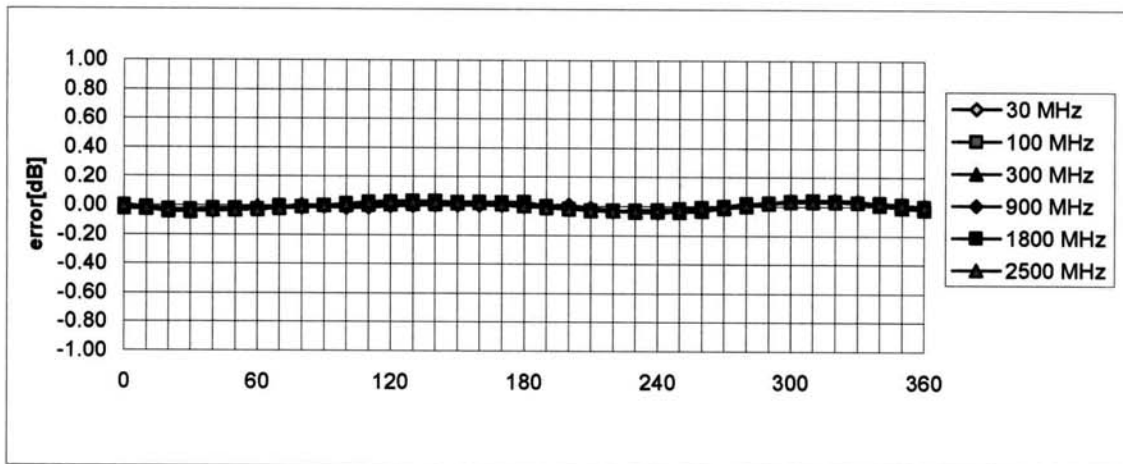
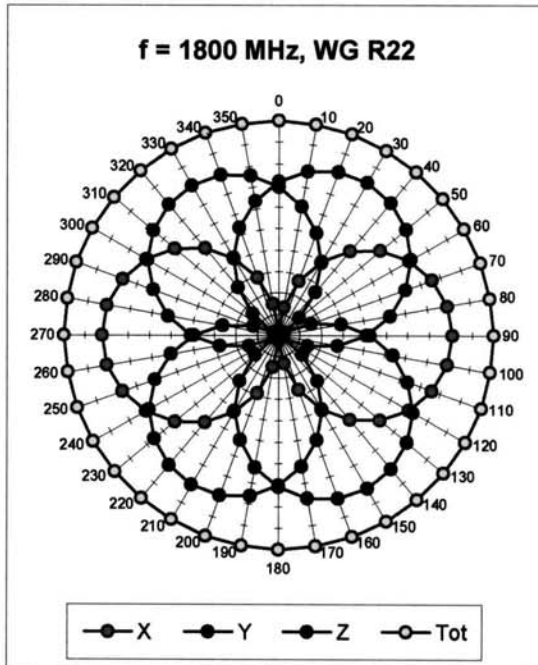
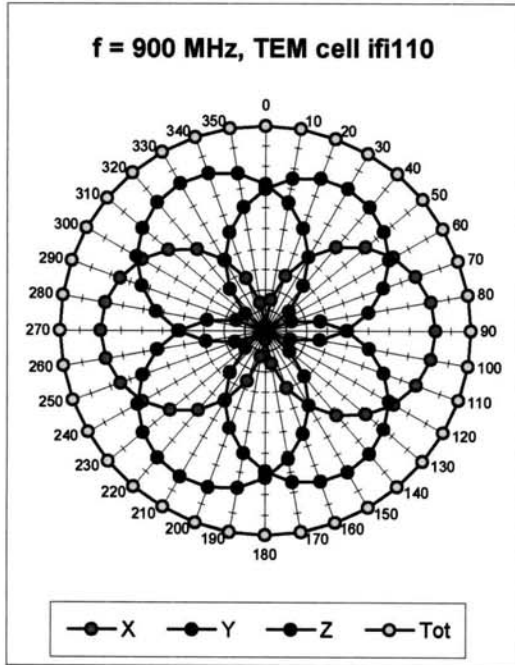

Axial Isotropy Error $\lt; \pm 0.2 \text{ dB}$

Dynamic Range f(SAR_{head}) (Waveguide R22)

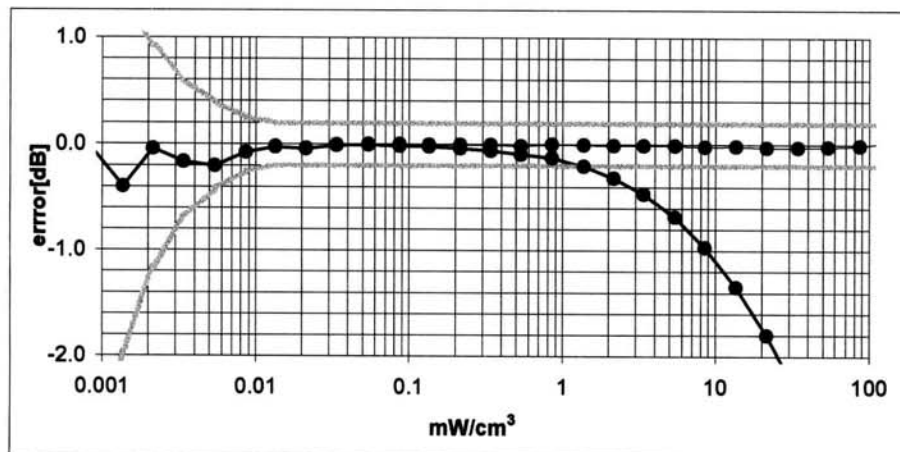
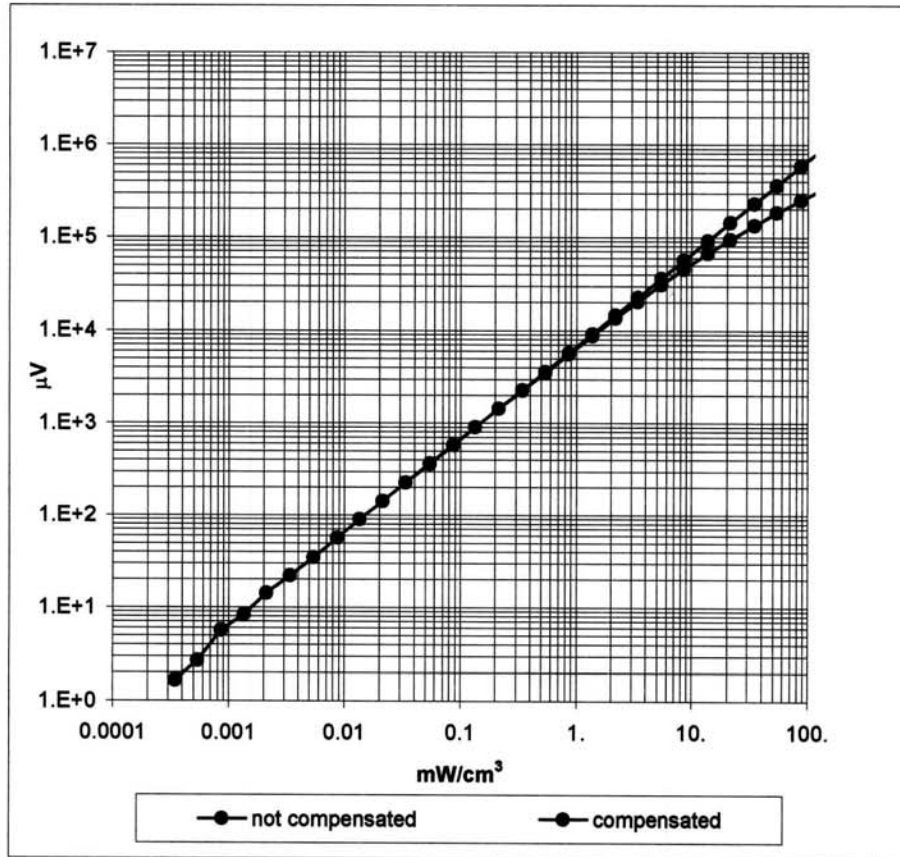

Probe Linearity < ± 0.2 dB

Conversion Factor Assessment

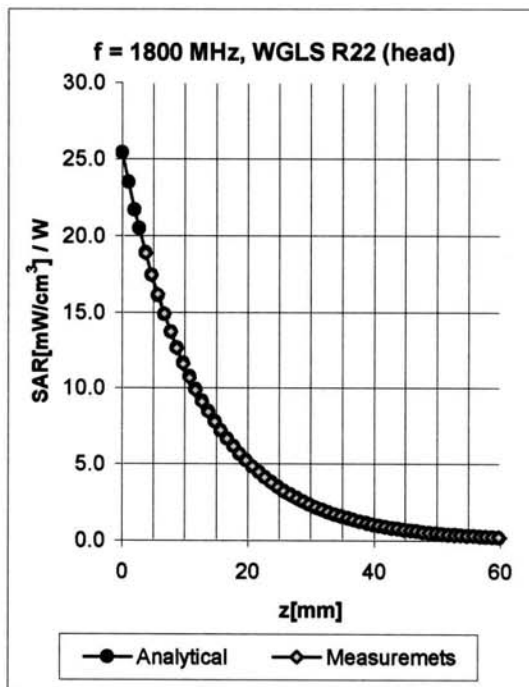
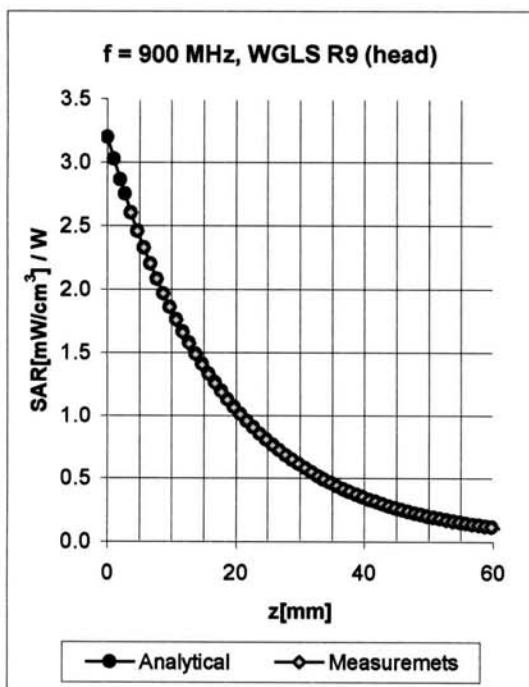

f [MHz]	Validity [MHz] ^B	Tissue	Permittivity	Conductivity	Alpha	Depth	ConvF	Uncertainty
835	750-950	Head	41.5 ± 5%	0.90 ± 5%	0.72	1.78	6.71 ± 11.9%	(k=2)
1750	1700-1800	Head	40.0 ± 5%	1.40 ± 5%	0.51	2.67	5.38 ± 9.7%	(k=2)
1900	1850-1950	Head	40.0 ± 5%	1.40 ± 5%	0.55	2.66	5.25 ± 9.7%	(k=2)
2450	2400-2500	Head	39.2 ± 5%	1.80 ± 5%	0.99	1.89	4.77 ± 9.7%	(k=2)
835	750-950	Body	55.2 ± 5%	0.97 ± 5%	0.56	2.04	6.24 ± 11.9%	(k=2)
1750	1700-1800	Body	53.3 ± 5%	1.52 ± 5%	0.58	2.82	4.68 ± 9.7%	(k=2)
1900	1850-1950	Body	53.3 ± 5%	1.52 ± 5%	0.62	2.77	4.57 ± 9.7%	(k=2)
2450	2400-2500	Body	52.7 ± 5%	1.95 ± 5%	1.75	1.28	4.50 ± 9.7%	(k=2)

^B The total standard uncertainty is calculated as root-sum-square of standard uncertainty of the Conversion Factor at calibration frequency and the standard uncertainty for the indicated frequency band.

Deviation from Isotropy in HSL

Error (θ, ϕ), $f = 900$ MHz

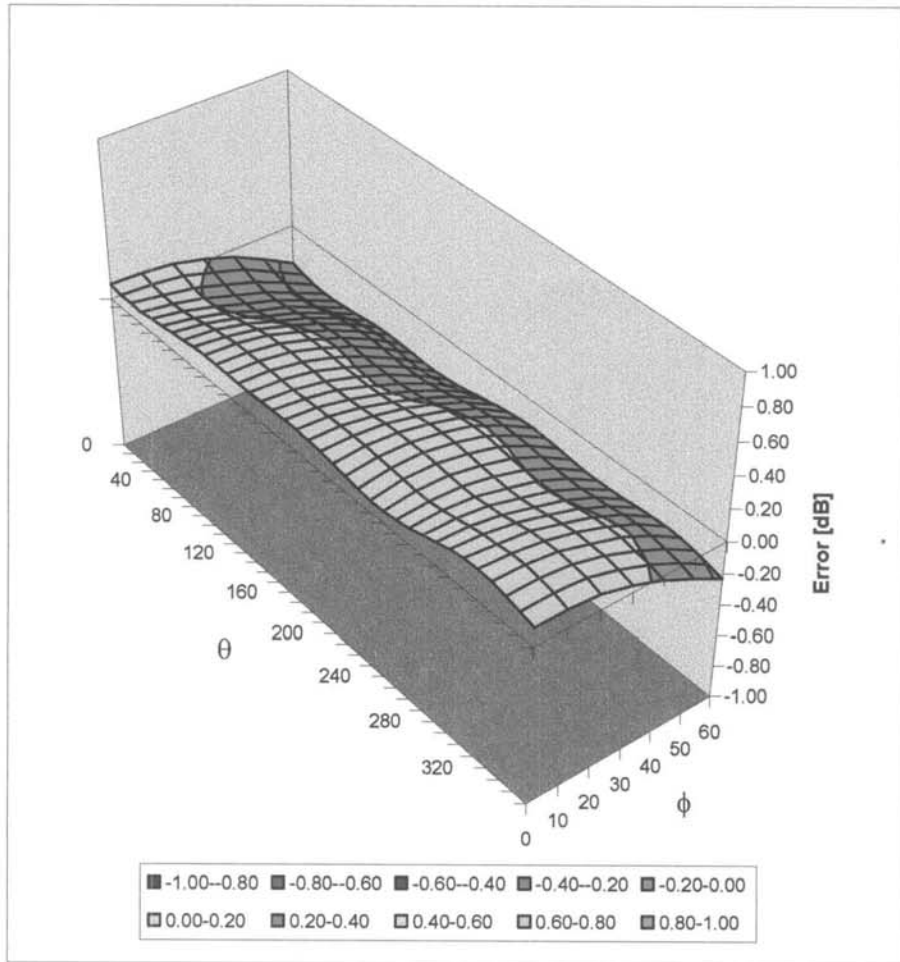

Spherical Isotropy Error <math>\lt; \pm 0.4 dB

Additional Conversion Factors

for Dosimetric E-Field Probe

Type:

ET3DV6

Serial Number:

1387

Place of Assessment:

Zurich

Date of Assessment:

March 22, 2004

Probe Calibration Date:

March 18, 2004

Schmid & Partner Engineering AG hereby certifies that conversion factor(s) of this probe have been evaluated on the date indicated above. The assessment was performed using the FDTD numerical code SEMCAD of Schmid & Partner Engineering AG. Since the evaluation is coupled with measured conversion factors, it has to be recalculated yearly, i.e., following the re-calibration schedule of the probe. The uncertainty of the numerical assessment is based on the extrapolation from measured value at 900 MHz or at 1800 MHz.

Assessed by:

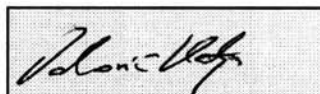

Dosimetric E-Field Probe ET3DV6 SN:1387

Conversion factor (\pm standard deviation)

150 MHz	ConvF	9.1 \pm 8%	$\epsilon_r = 52.3 \pm 5\%$ $\sigma = 0.76 \pm 5\%$ mho/m (head tissue)
300 MHz	ConvF	7.8 \pm 8%	$\epsilon_r = 45.3 \pm 5\%$ $\sigma = 0.87 \pm 5\%$ mho/m (head tissue)
450 MHz	ConvF	7.5 \pm 8%	$\epsilon_r = 43.5 \pm 5\%$ $\sigma = 0.87 \pm 5\%$ mho/m (head tissue)
150 MHz	ConvF	8.7 \pm 8%	$\epsilon_r = 61.9 \pm 5\%$ $\sigma = 0.80 \pm 5\%$ mho/m (body tissue)
450 MHz	ConvF	7.6 \pm 8%	$\epsilon_r = 56.7 \pm 5\%$ $\sigma = 0.94 \pm 5\%$ mho/m (body tissue)

Important Note:

For numerically assessed probe conversion factors, parameters Alpha and Delta in the DASY software must have the following entries: Alpha = 0 and Delta = 1.

Please see also Section 4.7 of the DASY4 Manual.

Test Report S/N:	121004K66-T602-S90U
Test Date(s):	December 14, 2004
Test Type:	FCC/IC SAR Evaluation

APPENDIX E - MEASURED FLUID DIELECTRIC PARAMETERS

Applicant:	Vertex Standard Co., Ltd.	FCC ID:	K6610584720	IC ID:	511B-10584720	450 - 512 MHz	
Model(s):	VX-821-G7-5, VX-824-G7-5, VX-829-G7-5, VX-871-G7-5, VX-874-G7-5, VX-879-G7-5	Portable FM UHF PTT Radio Transceiver					
2004 Celltech Labs Inc. This document is not to be reproduced in whole or in part without the written permission of Celltech Labs Inc. 19 of 20							

450 MHz System Performance Check & DUT Evaluation (Face)

Measured Fluid Dielectric Parameters (Brain)

December 14, 2004

Frequency	ϵ'	ϵ''
350.000000 MHz	45.6476	39.4197
360.000000 MHz	45.4209	38.8111
370.000000 MHz	45.2418	38.3074
380.000000 MHz	45.0720	37.8834
390.000000 MHz	44.7855	37.4758
400.000000 MHz	44.4520	36.9290
410.000000 MHz	44.0565	36.2760
420.000000 MHz	43.8403	35.6495
430.000000 MHz	43.6111	35.0830
440.000000 MHz	43.3678	34.6210
450.000000 MHz	43.1455	34.2329
460.000000 MHz	42.9674	33.8919
470.000000 MHz	42.7271	33.6206
480.000000 MHz	42.5136	33.2867
490.000000 MHz	42.2602	32.9736
500.000000 MHz	42.0379	32.5839
510.000000 MHz	41.8741	32.0998
520.000000 MHz	41.7263	31.7789
530.000000 MHz	41.5931	31.4191
540.000000 MHz	41.3988	31.0038
550.000000 MHz	41.1300	30.6640

450 MHz DUT Evaluation (Body)

Measured Fluid Dielectric Parameters (Muscle)

December 14, 2004

Frequency	ϵ'	ϵ''
350.000000 MHz	58.6366	42.6376
360.000000 MHz	58.4227	41.8732
370.000000 MHz	58.2871	41.1801
380.000000 MHz	58.1460	40.4877
390.000000 MHz	57.9573	39.8037
400.000000 MHz	57.7923	39.2110
410.000000 MHz	57.6074	38.5864
420.000000 MHz	57.4458	37.9952
430.000000 MHz	57.2524	37.4156
440.000000 MHz	57.0816	36.9148
450.000000 MHz	56.9269	36.4600
460.000000 MHz	56.8198	36.0228
470.000000 MHz	56.6295	35.5185
480.000000 MHz	56.4592	35.1199
490.000000 MHz	56.3118	34.7138
500.000000 MHz	56.1803	34.3538
510.000000 MHz	56.0419	33.9397
520.000000 MHz	55.8829	33.5616
530.000000 MHz	55.7311	33.2612
540.000000 MHz	55.6542	32.8395
550.000000 MHz	55.4904	32.5799

Test Report S/N:	121004K66-T602-S90U
Test Date(s):	December 14, 2004
Test Type:	FCC/IC SAR Evaluation

APPENDIX F - SAR TEST SETUP & DUT PHOTOGRAPHS

Applicant:	Vertex Standard Co., Ltd.	FCC ID:	K6610584720	IC ID:	511B-10584720	450 - 512 MHz
Model(s):	VX-821-G7-5, VX-824-G7-5, VX-829-G7-5, VX-871-G7-5, VX-874-G7-5, VX-879-G7-5		Portable FM UHF PTT Radio Transceiver			
2004 Celltech Labs Inc. This document is not to be reproduced in whole or in part without the written permission of Celltech Labs Inc. 20 of 20						

FACE-HELD SAR TEST SETUP PHOTOGRAPHS
2.5 cm Separation Distance from Front of Radio to Planar Phantom
with Whip Antenna (450-481 MHz) & Li-ion Battery (1150 mAh)

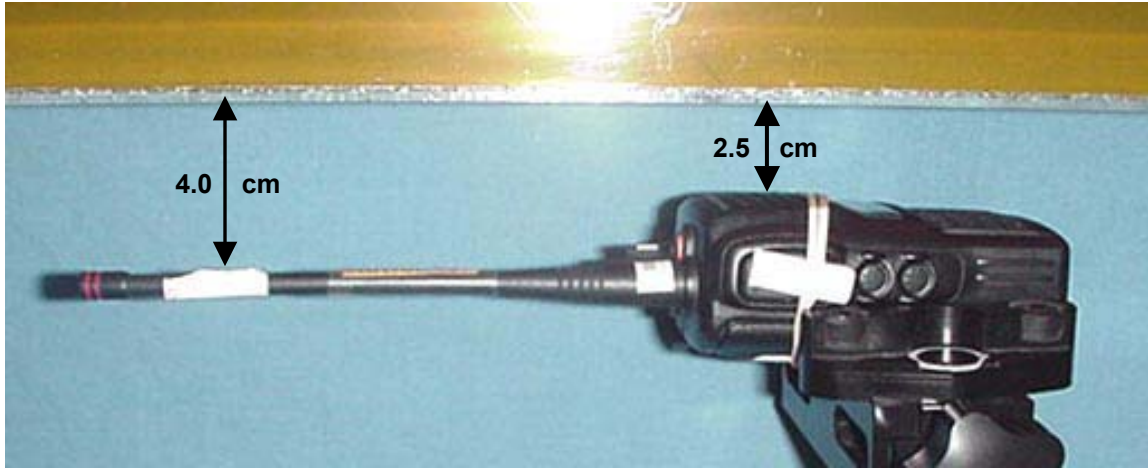

Applicant:	Vertex Standard Co., Ltd.	FCC ID:	K6610584720	IC ID:	511B-10584720	450 - 512 MHz
Model(s):	VX-821-G7-5, VX-824-G7-5, VX-829-G7-5, VX-871-G7-5, VX-874-G7-5, VX-879-G7-5		Portable FM UHF PTT Radio Transceiver			
2004 Celltech Labs Inc. This document is not to be reproduced in whole or in part without the written permission of Celltech Labs Inc.						

FACE-HELD SAR TEST SETUP PHOTOGRAPHS
2.5 cm Separation Distance from Front of Radio to Planar Phantom
with Whip Antenna (450-481 MHz) & Li-ion Battery (2000 mAh)

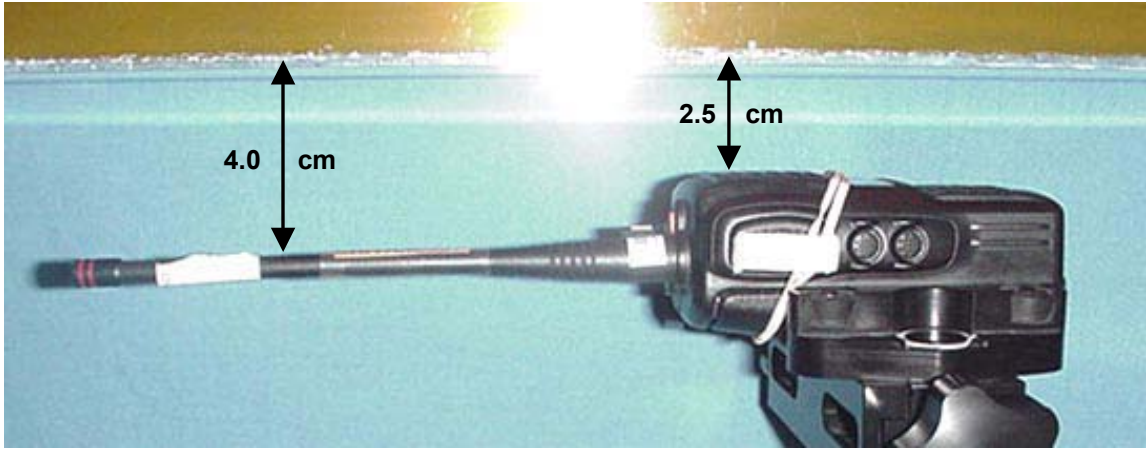

Applicant:	Vertex Standard Co., Ltd.	FCC ID:	K6610584720	IC ID:	511B-10584720	450 - 512 MHz
Model(s):	VX-821-G7-5, VX-824-G7-5, VX-829-G7-5, VX-871-G7-5, VX-874-G7-5, VX-879-G7-5		Portable FM UHF PTT Radio Transceiver			
2004 Celltech Labs Inc.		This document is not to be reproduced in whole or in part without the written permission of Celltech Labs Inc.				

FACE-HELD SAR TEST SETUP PHOTOGRAPHS
2.5 cm Separation Distance from Front of Radio to Planar Phantom
with Whip Antenna (512 MHz) & Li-ion Battery (2000 mAh)

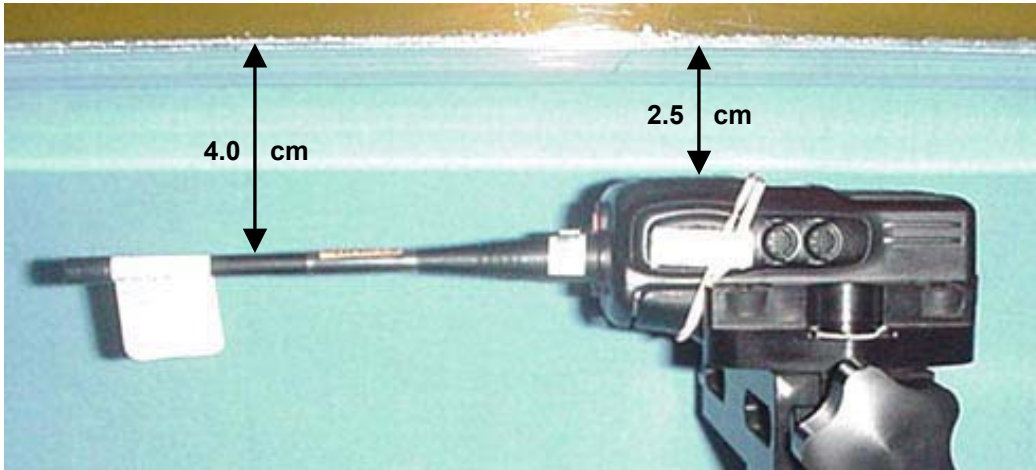

Applicant:	Vertex Standard Co., Ltd.	FCC ID:	K6610584720	IC ID:	511B-10584720	450 - 512 MHz
Model(s):	VX-821-G7-5, VX-824-G7-5, VX-829-G7-5, VX-871-G7-5, VX-874-G7-5, VX-879-G7-5		Portable FM UHF PTT Radio Transceiver			
2004 Celltech Labs Inc. This document is not to be reproduced in whole or in part without the written permission of Celltech Labs Inc.						

BODY-WORN SAR TEST SETUP PHOTOGRAPHS
1.2 cm Belt-Clip Separation Distance to Planar Phantom
with Whip Antenna (450-481 MHz), Speaker-Microphone (P/N: MH-65A7A), & Li-ion Battery (1150 mAh)

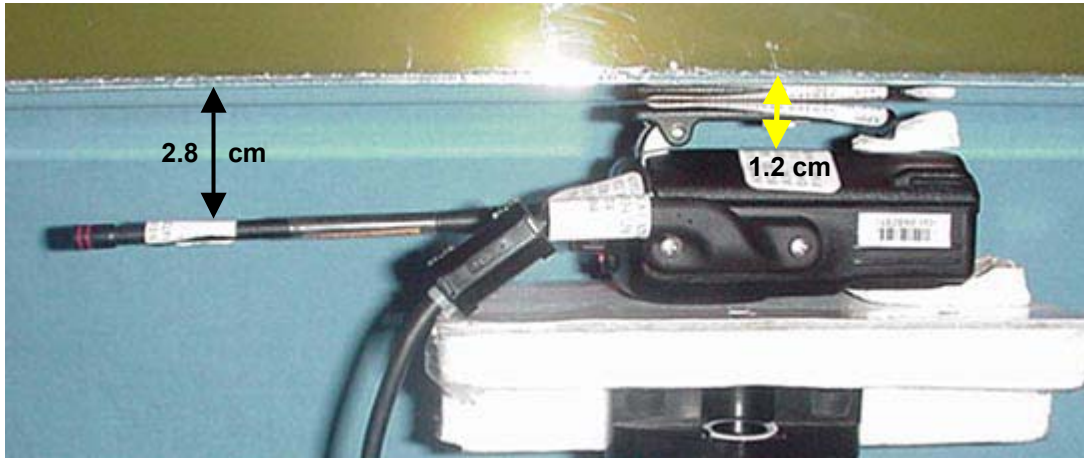

Applicant:	Vertex Standard Co., Ltd.	FCC ID:	K6610584720	IC ID:	511B-10584720	450 - 512 MHz
Model(s):	VX-821-G7-5, VX-824-G7-5, VX-829-G7-5, VX-871-G7-5, VX-874-G7-5, VX-879-G7-5		Portable FM UHF PTT Radio Transceiver			
2004 Celltech Labs Inc.		This document is not to be reproduced in whole or in part without the written permission of Celltech Labs Inc.				

BODY-WORN SAR TEST SETUP PHOTOGRAPHS
0.8 cm Belt-Clip Separation Distance to Planar Phantom
with Whip Antenna (450-481 MHz), Speaker-Microphone (P/N: MH-65A7A), & Li-ion Battery (2000 mAh)

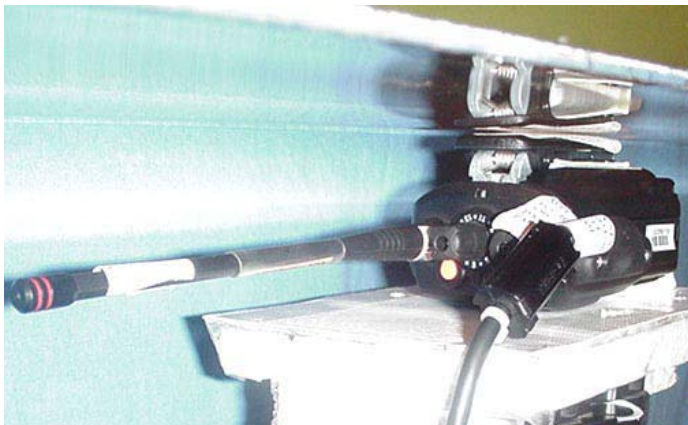
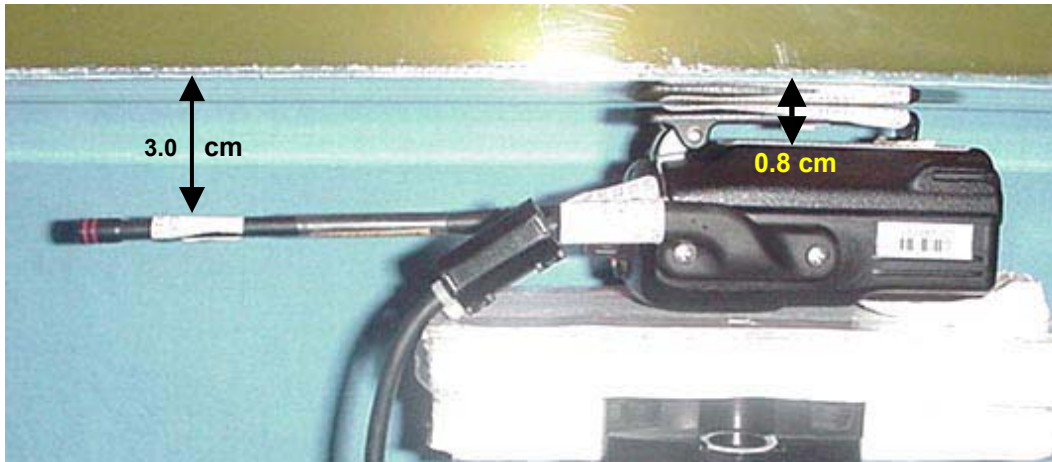

Applicant:	Vertex Standard Co., Ltd.	FCC ID:	K6610584720	IC ID:	511B-10584720	450 - 512 MHz
Model(s):	VX-821-G7-5, VX-824-G7-5, VX-829-G7-5, VX-871-G7-5, VX-874-G7-5, VX-879-G7-5		Portable FM UHF PTT Radio Transceiver			
2004 Celltech Labs Inc. This document is not to be reproduced in whole or in part without the written permission of Celltech Labs Inc.						

BODY-WORN SAR TEST SETUP PHOTOGRAPHS
0.8 cm Belt-Clip Separation Distance to Planar Phantom
with Whip Antenna (512 MHz), Speaker-Microphone (P/N: MH-65A7A), & Li-ion Battery (2000 mAh)



Applicant:	Vertex Standard Co., Ltd.	FCC ID:	K6610584720	IC ID:	511B-10584720	450 - 512 MHz
Model(s):	VX-821-G7-5, VX-824-G7-5, VX-829-G7-5, VX-871-G7-5, VX-874-G7-5, VX-879-G7-5		Portable FM UHF PTT Radio Transceiver			
2004 Celltech Labs Inc.		This document is not to be reproduced in whole or in part without the written permission of Celltech Labs Inc.				

SAR TEST SETUP PHOTOGRAPHS



Face-Held Configuration



Body-Worn Configuration

Applicant:	Vertex Standard Co., Ltd.	FCC ID:	K6610584720	IC ID:	511B-10584720	450 - 512 MHz
Model(s):	VX-821-G7-5, VX-824-G7-5, VX-829-G7-5, VX-871-G7-5, VX-874-G7-5, VX-879-G7-5		Portable FM UHF PTT Radio Transceiver			
2004 Celltech Labs Inc.		This document is not to be reproduced in whole or in part without the written permission of Celltech Labs Inc.				

DUT PHOTOGRAPHS



Front of DUT
with Whip Antenna (450-481 MHz)



Front of DUT
with Whip Antenna (512 MHz)

Applicant:	Vertex Standard Co., Ltd.	FCC ID:	K6610584720	IC ID:	511B-10584720	450 - 512 MHz	
Model(s):	VX-821-G7-5, VX-824-G7-5, VX-829-G7-5, VX-871-G7-5, VX-874-G7-5, VX-879-G7-5	Portable FM UHF PTT Radio Transceiver					
2004 Celltech Labs Inc. This document is not to be reproduced in whole or in part without the written permission of Celltech Labs Inc.							

Test Report S/N:	121004K66-T602-S90U
Test Date(s):	December 14, 2004
Test Type:	FCC/IC SAR Evaluation

DUT PHOTOGRAPHS



Back of DUT with 1150 mAh Li-ion Battery



Back of DUT with 2000 mAh Li-ion Battery



Back of DUT with Belt-Clip

Applicant:	Vertex Standard Co., Ltd.	FCC ID:	K6610584720	IC ID:	511B-10584720	450 - 512 MHz
Model(s):	VX-821-G7-5, VX-824-G7-5, VX-829-G7-5, VX-871-G7-5, VX-874-G7-5, VX-879-G7-5		Portable FM UHF PTT Radio Transceiver			
2004 Celltech Labs Inc. This document is not to be reproduced in whole or in part without the written permission of Celltech Labs Inc.						

DUT PHOTOGRAPHS



Bottom of DUT with 1150 mAh Li-ion Battery



Bottom of DUT with 2000 mAh Li-ion Battery



Top of DUT

Applicant:	Vertex Standard Co., Ltd.	FCC ID:	K6610584720	IC ID:	511B-10584720	450 - 512 MHz
Model(s):	VX-821-G7-5, VX-824-G7-5, VX-829-G7-5, VX-871-G7-5, VX-874-G7-5, VX-879-G7-5		Portable FM UHF PTT Radio Transceiver			
2004 Celltech Labs Inc.		This document is not to be reproduced in whole or in part without the written permission of Celltech Labs Inc.				

DUT PHOTOGRAPHS



Left Side of DUT with 1150 mAh Li-ion Battery & Belt-Clip



Right Side of DUT with 1150 mAh Li-ion Battery & Belt-Clip



Belt-Clip P/N: CLIP-820 (Plastic with metal spring) with 1150 mAh Li-ion Battery

Applicant:	Vertex Standard Co., Ltd.	FCC ID:	K6610584720	IC ID:	511B-10584720	450 - 512 MHz
Model(s):	VX-821-G7-5, VX-824-G7-5, VX-829-G7-5, VX-871-G7-5, VX-874-G7-5, VX-879-G7-5		Portable FM UHF PTT Radio Transceiver			
2004 Celltech Labs Inc.		This document is not to be reproduced in whole or in part without the written permission of Celltech Labs Inc.				

DUT PHOTOGRAPHS



Left Side of DUT with 2000 mAh Li-ion Battery & Belt-Clip



Right Side of DUT with 2000 mAh Li-ion Battery & Belt-Clip



Belt-Clip P/N: CLIP-820 (Plastic with metal spring) with 2000 mAh Li-ion Battery

Applicant:	Vertex Standard Co., Ltd.	FCC ID:	K6610584720	IC ID:	511B-10584720	450 - 512 MHz
Model(s):	VX-821-G7-5, VX-824-G7-5, VX-829-G7-5, VX-871-G7-5, VX-874-G7-5, VX-879-G7-5		Portable FM UHF PTT Radio Transceiver			
2004 Celltech Labs Inc. This document is not to be reproduced in whole or in part without the written permission of Celltech Labs Inc.						

DUT PHOTOGRAPHS



DUT Battery Compartment

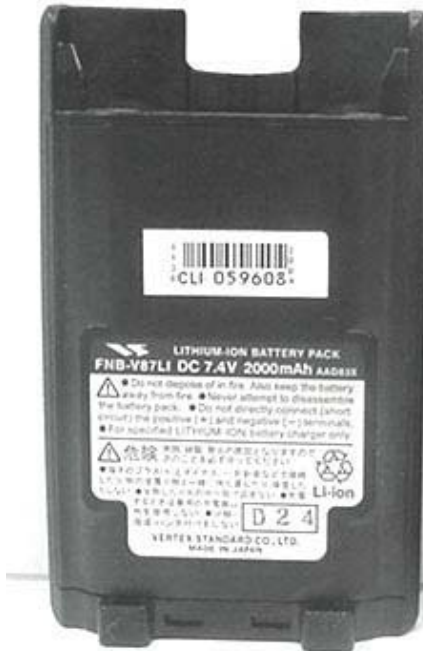

**Li-ion Battery 1150 mAh
(P/N: FNB-V86LI)**



**Li-ion Battery 2000 mAh
(P/N: FNB-V87LI)**



**Li-ion Battery 1150 mAh
(P/N: FNB-V86LI)**

**Li-ion Battery 2000 mAh
(P/N: FNB-V87LI)**

Applicant:	Vertex Standard Co., Ltd.	FCC ID:	K6610584720	IC ID:	511B-10584720	450 - 512 MHz
Model(s):	VX-821-G7-5, VX-824-G7-5, VX-829-G7-5, VX-871-G7-5, VX-874-G7-5, VX-879-G7-5			Portable FM UHF PTT Radio Transceiver		
2004 Celltech Labs Inc. This document is not to be reproduced in whole or in part without the written permission of Celltech Labs Inc.						

DUT PHOTOGRAPHS



450-481 MHz Whip Antenna (P/N: ATU-6D)



512 MHz Whip Antenna (P/N: ATU-6F)

Applicant:	Vertex Standard Co., Ltd.	FCC ID:	K6610584720	IC ID:	511B-10584720	450 - 512 MHz
Model(s):	VX-821-G7-5, VX-824-G7-5, VX-829-G7-5, VX-871-G7-5, VX-874-G7-5, VX-879-G7-5		Portable FM UHF PTT Radio Transceiver			
2004 Celltech Labs Inc. This document is not to be reproduced in whole or in part without the written permission of Celltech Labs Inc.						

Test Report S/N:	121004K66-T602-S90U
Test Date(s):	December 14, 2004
Test Type:	FCC/IC SAR Evaluation

DUT PHOTOGRAPHS



DUT with Speaker-Microphone Accessory (P/N: MH-65A7A)

Applicant:	Vertex Standard Co., Ltd.	FCC ID:	K6610584720	IC ID:	511B-10584720	450 - 512 MHz
Model(s):	VX-821-G7-5, VX-824-G7-5, VX-829-G7-5, VX-871-G7-5, VX-874-G7-5, VX-879-G7-5		Portable FM UHF PTT Radio Transceiver			
2004 Celltech Labs Inc.		This document is not to be reproduced in whole or in part without the written permission of Celltech Labs Inc.				