

## DECLARATION OF COMPLIANCE SAR RF EXPOSURE EVALUATION

### Test Lab

**CELLTECH LABS INC.**  
Testing and Engineering Services  
1955 Moss Court  
Kelowna, B.C.  
Canada V1Y 9L3  
Phone: 250-448-7047  
Fax: 250-448-7046  
e-mail: info@celltechlabs.com  
web site: www.celltechlabs.com

### Applicant Information

**VERTEX STANDARD CO., LTD.**  
4-8-8, Nakameguro, Meguro-Ku  
Tokyo 153-8644  
Japan

<b>Rule Part(s):</b>	FCC 47 CFR §2.1093; IC RSS-102 Issue 1 (Provisional)
<b>Test Procedure(s):</b>	FCC OET Bulletin 65, Supplement C (Edition 01-01)
<b>Device Classification:</b>	Licensed Non-Broadcast Transmitter Held to Face (TNF)
<b>Device Type:</b>	Portable FM UHF PTT Radio Transceiver
<b>FCC ID:</b>	K6610504420
<b>Model(s):</b>	VX-417-4-5 / VX-427-4-5
<b>Modulation:</b>	FM (UHF)
<b>TX Frequency Range:</b>	450.00 - 490.00 MHz
<b>Max. RF Output Power Tested:</b>	5.19 Watts Conducted (450.00 MHz) 5.37 Watts Conducted (470.00 MHz) 5.21 Watts Conducted (490.00 MHz)
<b>Antenna Type(s):</b>	Whip
<b>Battery Type(s):</b>	Nickel-Cadmium (7.2V, 1100mAh)
<b>Body-Worn Accessories:</b>	1. Belt-Clip (P/N: BA0102700112KA) 2. Speaker-Microphone (P/N: MH-45)
<b>Max. SAR Measured:</b>	3.92 W/kg - Face-held (50% Duty Cycle) 7.55 W/kg - Body-worn (50% Duty Cycle)

Celltech Labs Inc. declares under its sole responsibility that this wireless portable device has demonstrated compliance with the Specific Absorption Rate (SAR) RF exposure requirements specified in FCC 47 CFR §2.1093 and Health Canada's Safety Code 6. The device was tested in accordance with the measurement standards and procedures specified in FCC OET Bulletin 65, Supplement C (Edition 01-01) and Industry Canada RSS-102 Issue 1 (Provisional) for the Occupational / Controlled Exposure environment. All measurements were performed in accordance with the SAR system manufacturer recommendations.

I attest to the accuracy of data. All measurements were performed by me or were made under my supervision and are correct to the best of my knowledge and belief. I assume full responsibility for the completeness of these measurements and vouch for the qualifications of all persons taking them.

This test report shall not be reproduced partially, or in full, without the prior written approval of Celltech Labs Inc. The results and statements contained in this report pertain only to the device(s) evaluated.



**Russell W. Pipe**  
Senior Compliance Technologist  
Celltech Labs Inc.



<b>TABLE OF CONTENTS</b>		
<b>1.0</b>	<b>INTRODUCTION.....</b>	<b>3</b>
<b>2.0</b>	<b>DESCRIPTION OF DUT.....</b>	<b>3</b>
<b>3.0</b>	<b>SAR MEASUREMENT SYSTEM.....</b>	<b>4</b>
<b>4.0</b>	<b>MEASUREMENT SUMMARY.....</b>	<b>5</b>
<b>5.0</b>	<b>DETAILS OF SAR EVALUATION.....</b>	<b>6</b>
<b>6.0</b>	<b>EVALUATION PROCEDURES.....</b>	<b>6</b>
<b>7.0</b>	<b>SYSTEM PERFORMANCE CHECK.....</b>	<b>7</b>
<b>8.0</b>	<b>SIMULATED EQUIVALENT TISSUES.....</b>	<b>8</b>
<b>9.0</b>	<b>SAR SAFETY LIMITS.....</b>	<b>8</b>
<b>10.0</b>	<b>ROBOT SYSTEM SPECIFICATIONS.....</b>	<b>9</b>
<b>11.0</b>	<b>PROBE SPECIFICATION.....</b>	<b>10</b>
<b>12.0</b>	<b>PLANAR PHANTOM.....</b>	<b>10</b>
<b>13.0</b>	<b>VALIDATION PHANTOM.....</b>	<b>10</b>
<b>14.0</b>	<b>DEVICE HOLDER.....</b>	<b>10</b>
<b>15.0</b>	<b>TEST EQUIPMENT LIST.....</b>	<b>11</b>
<b>16.0</b>	<b>MEASUREMENT UNCERTAINTIES.....</b>	<b>12-13</b>
<b>17.0</b>	<b>REFERENCES.....</b>	<b>14</b>
	<b>APPENDIX A - SAR MEASUREMENT DATA.....</b>	<b>15</b>
	<b>APPENDIX B - SYSTEM PERFORMANCE CHECK DATA.....</b>	<b>16</b>
	<b>APPENDIX C - SYSTEM VALIDATION PROCEDURES.....</b>	<b>17</b>
	<b>APPENDIX D - PROBE CALIBRATION.....</b>	<b>18</b>
	<b>APPENDIX E - MEASURED FLUID DIELECTRIC PARAMETERS.....</b>	<b>19</b>
	<b>APPENDIX F - SAR TEST SETUP &amp; DUT PHOTOGRAPHS.....</b>	<b>20</b>

## 1.0 INTRODUCTION

This measurement report demonstrates compliance of the Vertex Standard Co., Ltd. Models: VX-417-4-5 / VX-427-4-5 Portable FM UHF PTT Radio Transceiver FCC ID: K6610504420 with the SAR (Specific Absorption Rate) RF exposure requirements specified in FCC 47 CFR §2.1093 (see reference [1]), and Health Canada's Safety Code 6 (see reference [2]) for the Occupational / Controlled Exposure environment. The measurement procedures described in FCC OET Bulletin 65, Supplement C (Edition 01-01) (see reference [3]) and IC RSS-102 Issue 1 (Provisional) (see reference [4]), were employed. A description of the product, operating configuration, detailed summary of the test results, methodology and procedures used in the evaluation, equipment used, and the various provisions of the rules are included within this test report.

## 2.0 DESCRIPTION OF DEVICE UNDER TEST (DUT)

<b>FCC Rule Part(s)</b>	47 CFR §2.1093
<b>IC Rule Part(s)</b>	RSS-102 Issue 1 (Provisional)
<b>Test Procedure(s)</b>	FCC OET Bulletin 65, Supplement C (01-01)
<b>Device Type</b>	Portable FM UHF PTT Radio Transceiver
<b>FCC ID</b>	K6610504420
<b>Model(s)</b>	VX-417-4-5 / VX-427-4-5
<b>Serial No.</b>	3M000012 (Identical Prototype)
<b>Modulation</b>	FM
<b>Tx Frequency Range</b>	450.00 - 490.00 MHz
<b>Max. RF Output Power Tested</b>	5.19 Watts Conducted (450.00 MHz) 5.37 Watts Conducted (470.00 MHz) 5.21 Watts Conducted (490.00 MHz)
<b>Antenna Type(s)</b>	Whip (Length: 151 mm)
<b>Battery Type(s)</b>	Nickel-Cadmium (7.2V, 1100mAh)
<b>Body-Worn Accessories Tested</b>	1. Belt-Clip (P/N: BA0102700112KA) 2. Speaker-Microphone (P/N: MH-45)

### 3.0 SAR MEASUREMENT SYSTEM

Celltech Labs Inc. SAR measurement facility utilizes the Dosimetric Assessment System (DASY™) manufactured by Schmid & Partner Engineering AG (SPEAG™) of Zurich, Switzerland. The DASY4 measurement system is comprised of the measurement server, robot controller, computer, near-field probe, probe alignment sensor, specific anthropomorphic mannequin (SAM) phantom, and various planar phantoms for brain and/or body SAR evaluations. The robot is a six-axis industrial robot performing precise movements to position the probe to the location (points) of maximum electromagnetic field (EMF). A cell controller system contains the power supply, robot controller, teach pendant (Joystick), and remote control, is used to drive the robot motors. The Staubli robot is connected to the cell controller to allow software manipulation of the robot. A data acquisition electronic (DAE) circuit performs the signal amplification, signal multiplexing, AD-conversion, offset measurements, mechanical surface detection, collision detection, etc. is connected to the Electro-optical coupler (EOC). The EOC performs the conversion from the optical into digital electric signal of the DAE and transfers data to the DASY4 measurement server. The DAE4 utilizes a highly sensitive electrometer-grade preamplifier with auto-zeroing, a channel and gain-switching multiplexer, a fast 16-bit AD-converter and a command decoder and control logic unit. Transmission to the DASY4 measurement server is accomplished through an optical downlink for data and status information and an optical uplink for commands and clock lines. The mechanical probe-mounting device includes two different sensor systems for frontal and sidewise probe contacts. The sensor systems are also used for mechanical surface detection and probe collision detection. The robot uses its own controller with a built in VME-bus computer.



DASY4 SAR Measurement System with validation phantom



DASY4 SAR Measurement System with Plexiglas planar phantom

## 4.0 MEASUREMENT SUMMARY

SAR EVALUATION RESULTS														
Test Type	Freq. (MHz)	Chan.	Test Mode	Measured Conducted RF Output Power			Battery Type	Accessory Type	Separation Distance to Planar Phantom (cm)	Measured SAR (W/kg)		Max. Cond. Power Drift (dB)	Scaled SAR (W/kg)	
				Before (W)	After (W)	Drift (dB)				Duty Cycle			Duty Cycle	
										100%	50%		100%	50%
Face	470.0	Mid	CW	5.35	4.90	-0.38	NiCd	-	2.5	7.16	3.58	-0.39	7.83	3.92
Body	470.0	Mid	CW	5.37	4.91	-0.39	NiCd	Belt-Clip Speaker-Mic	1.3	11.3	5.65	-0.39	12.4	6.20
Body	450.0	Low	CW	5.19	4.79	-0.35	NiCd	Belt-Clip Speaker-Mic	1.3	13.8	6.90	-0.39	15.1	7.55
Body	490.0	High	CW	5.21	4.76	-0.39	NiCd	Belt-Clip Speaker-Mic	1.3	12.2	6.10	-0.39	13.3	6.65
<b>ANSI / IEEE C95.1 1992 - SAFETY LIMIT</b> Spatial Peak - Controlled Exposure / Occupational <b>BRAIN / BODY: 8.0 W/kg (averaged over 1 gram)</b>														
Dielectric Constant $\epsilon_r$		Brain 450 MHz			Body 450 MHz			Atmospheric Pressure			102.2 kPa			
		IEEE Target		Measured	IEEE Target		Measured	Relative Humidity			66 %			
		43.5 (+/-5%)		41.5	56.7 (+/-5%)		57.5	Ambient Temperature			23.9 °C			
Conductivity $\sigma$ (mho/m)		Brain 450 MHz			Body 450 MHz			Fluid Temperature			Brain: 21.8 °C		Body: 21.7 °C	
		IEEE Target		Measured	IEEE Target		Measured	Fluid Depth			≥ 15 cm			
		0.87 (+/-5%)		0.83	0.94 (+/-5%)		0.95	$\rho$ (Kg/m <sup>3</sup> )			1000			

Note(s):

- The measurement results were obtained with the DUT tested in the conditions described in this report. Detailed measurement data and plots showing the maximum SAR location of the DUT are reported in Appendix A.
- If the SAR measurements performed at the mid channel were  $\geq 3$ dB below the SAR limit, SAR evaluation for the low and high channels was optional (per FCC OET Bulletin 65, Supplement C, Edition 01-01 (see reference [3])).
- The conducted power levels measured after the SAR evaluations were  $> 5\%$  from the measured start power. The maximum power drift measured was added to the measured SAR levels to show scaled SAR results as listed in the above table.
- The ambient and fluid temperatures were measured prior to, and during, the fluid dielectric parameter check and the SAR evaluation. The temperatures listed were consistent for all measurement periods.
- The dielectric parameters of the simulated tissue mixture were measured prior to the evaluation using an 85070C Dielectric Probe Kit and an 8753E Network Analyzer (see Appendix E for printout of measured fluid dielectric parameters).

## 5.0 DETAILS OF SAR EVALUATION

The Vertex Standard Co., Ltd. Models: VX-417-4-5 / VX-427-4-5 Portable FM UHF PTT Radio Transceiver FCC ID: K6610504420 was found to be compliant for localized Specific Absorption Rate (Occupational/Controlled Exposure) based on the test provisions and conditions described below. The detailed test setup photographs are shown in Appendix F.

1. The DUT was evaluated in a face-held configuration with the front of the radio placed parallel to the outer surface of the planar phantom. A 2.5 cm separation distance was maintained between the front side of the DUT and the outer surface of the planar phantom for the duration of the tests.
2. The DUT was evaluated in a body-worn configuration with the back of the radio placed parallel to the outer surface of the planar phantom. The attached belt-clip was touching the planar phantom and provided a 1.3 cm separation distance between the back of the DUT and the outer surface of the planar phantom. The DUT was tested for body-worn SAR with the speaker-microphone accessory connected.
3. The conducted power levels were measured before and after each test according to the procedures described in FCC 47 CFR §2.1046.
4. The conducted power levels measured after the SAR evaluations were > 5% from the measured start power. The maximum power drift measured was added to the measured SAR levels to show scaled SAR results as shown in the test data table (page 5).
5. The DUT was tested in unmodulated continuous transmit operation (Continuous Wave mode at 100% duty cycle) with the transmit key constantly depressed. For a push-to-talk device the 50% duty cycle compensation reported assumes a transmit/receive cycle of equal time base.
6. The DUT was tested with a fully charged NiCd battery.
7. The ambient and fluid temperatures were measured prior to, and during, the fluid dielectric parameter check and the SAR evaluation. The temperatures reported were consistent for all measurement periods.
8. The SAR evaluations were performed using a Plexiglas planar phantom.
9. A stack of low-density, low-loss dielectric foamed polystyrene was used in place of the device holder.

## 6.0 EVALUATION PROCEDURES

- a. (i) The evaluation was performed in the applicable area of the phantom depending on the type of device being tested. For devices held to the ear during normal operation, both the left and right ear positions were evaluated using the SAM phantom.  
(ii) For body-worn and face-held devices a planar phantom was used.
- b. The SAR was determined by a pre-defined procedure within the DASY4 software. Upon completion of a reference and optical surface check, the exposed region of the phantom was scanned near the inner surface with a grid spacing of 15mm x 15mm.

An area scan was determined as follows:

- c. Based on the defined area scan grid, a more detailed grid is created to increase the points by a factor of 10. The interpolation function then evaluates all field values between corresponding measurement points.
- d. A linear search is applied to find all the candidate maxima. Subsequently, all maxima are removed that are >2 dB from the global maximum. The remaining maxima are then used to position the cube scans.

A 1g and 10g spatial peak SAR was determined as follows:

1. Extrapolation is used to find the points between the dipole center of the probe and the surface of the phantom. This data cannot be measured, since the center of the dipoles is 2.7 mm away from the tip of the probe and the distance between the surface and the lowest measuring point is 1.4 mm (see probe calibration document in Appendix D). The extrapolation was based on trivariate quadratics computed from the previously calculated 3D interpolated points nearest the phantom surface.
2. Interpolated data is used to calculate the average SAR over 1g and 10g cubes by spatially discretizing the entire measured cube. The volume used to determine the averaged SAR is a 1mm grid (42875 interpolated points).

## 7.0 SYSTEM PERFORMANCE CHECK

Prior to the SAR evaluation a system check was performed using a Plexiglas planar phantom with a 450MHz dipole (see Appendix C for system validation procedure). The dielectric parameters of the simulated tissue mixture were measured prior to the system performance check using an 85070C Dielectric Probe Kit and an 8753E Network Analyzer (see Appendix E for printout of measured fluid dielectric parameters). A forward power of 250mW was applied to the dipole and the system was verified to a tolerance of  $\pm 10\%$  (see Appendix B for system check test plot).

SYSTEM PERFORMANCE CHECK													
Test Date	450MHz Equiv. Tissue	SAR 1g (W/kg)		Dielectric Constant $\epsilon_r$		Conductivity $\sigma$ (mho/m)		$\rho$ (Kg/m <sup>3</sup> )	Amb. Temp. (°C)	Fluid Temp. (°C)	Fluid Depth (cm)	Humid. (%)	Barom. Press. (kPa)
		IEEE Target	Measured	IEEE Target	Measured	IEEE Target	Measured						
12/08/03	Brain	1.23 ( $\pm 10\%$ )	1.29 (+4.9%)	43.5 $\pm 5\%$	41.5	0.87 $\pm 5\%$	0.83	1000	23.9	21.8	$\geq 15$	66	102.2

Note(s):  
 1. The ambient and fluid temperatures were measured prior to, and during, the fluid dielectric parameter check and the system performance check. The temperatures listed in the table above were consistent for all measurement periods.

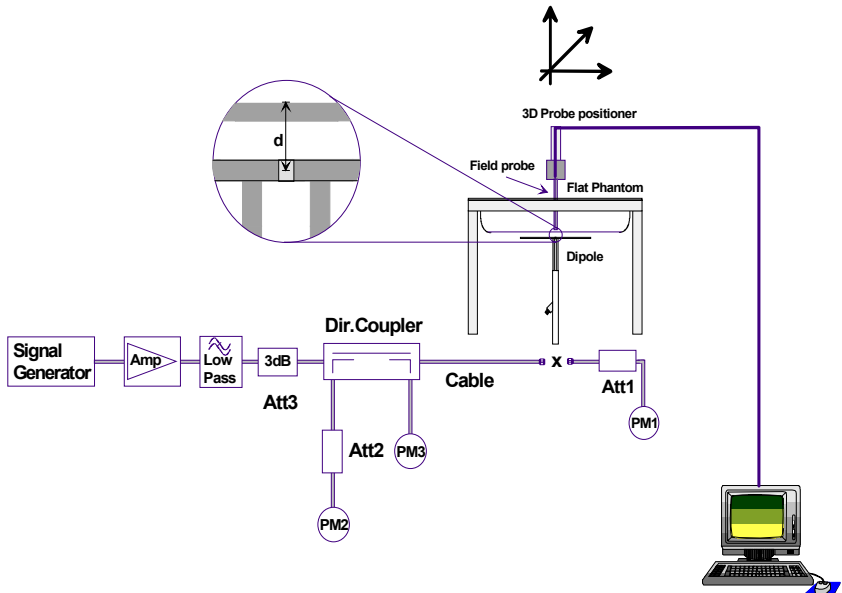

Figure 1. System Performance Check Setup Diagram



450MHz Dipole Setup

## 8.0 SIMULATED EQUIVALENT TISSUES

The 450MHz brain and body simulated tissue mixtures consist of a viscous gel using hydroxyethylcellulose (HEC) gelling agent and saline solution. Preservation with a bactericide is added and visual inspection is made to ensure air bubbles are not trapped during the mixing process. The fluid was prepared according to standardized procedures, and measured for dielectric parameters (permittivity and conductivity).

SIMULATED TISSUE MIXTURES		
INGREDIENT	450MHz Brain (System Check & DUT Evaluation)	450MHz Body (DUT Evaluation)
Water	38.56 %	52.00 %
Sugar	56.32 %	45.65 %
Salt	3.95 %	1.75 %
HEC	0.98 %	0.50 %
Bactericide	0.19 %	0.10 %

## 9.0 SAR SAFETY LIMITS

EXPOSURE LIMITS	SAR (W/kg)	
	(General Population / Uncontrolled Exposure Environment)	(Occupational / Controlled Exposure Environment)
Spatial Average (averaged over the whole body)	0.08	0.4
Spatial Peak (averaged over any 1g of tissue)	1.60	8.0
Spatial Peak (hands/wrists/feet/ankles averaged over 10g)	4.0	20.0

Notes:

1. Uncontrolled environments are defined as locations where there is potential exposure of individuals who have no knowledge or control of their potential exposure.
2. Controlled environments are defined as locations where there is potential exposure of individuals who have knowledge of their potential exposure and can exercise control over their exposure.



## 10.0 ROBOT SYSTEM SPECIFICATIONS

### Specifications

**POSITIONER:** Stäubli Unimation Corp. Robot Model: RX60L  
**Repeatability:** 0.02 mm  
**No. of axis:** 6

### Data Acquisition Electronic (DAE) System

#### Cell Controller

**Processor:** AMD Athlon XP 2400+  
**Clock Speed:** 2.0 GHz  
**Operating System:** Windows XP Professional

#### Data Converter

**Features:** Signal Amplifier, multiplexer, A/D converter, and control logic  
**Software:** DASY4 software  
**Connecting Lines:** Optical downlink for data and status info.  
 Optical uplink for commands and clock

### DASY4 Measurement Server

**Function:** Real-time data evaluation for field measurements and surface detection  
**Hardware:** PC/104 166MHz Pentium CPU; 32 MB chipdisk; 64 MB RAM  
**Connections:** COM1, COM2, DAE, Robot, Ethernet, Service Interface

### E-Field Probe

**Model:** ET3DV6  
**Serial No.:** 1387  
**Construction:** Triangular core fiber optic detection system  
**Frequency:** 10 MHz to 6 GHz  
**Linearity:**  $\pm 0.2$  dB (30 MHz to 3 GHz)

### Phantom(s)

#### Evaluation Phantom

**Type:** Planar Phantom  
**Shell Material:** Plexiglas  
**Bottom Thickness:** 2.0 mm  $\pm$  0.1 mm  
**Outer Dimensions:** 75.0 cm (L) x 22.5 cm (W) x 20.5 cm (H); Back Plane: 25.7 cm (H)

#### Validation Phantom ( $\leq 450$ MHz)

**Type:** Planar Phantom  
**Shell Material:** Plexiglas  
**Bottom Thickness:** 6.2 mm  $\pm$  0.1 mm  
**Outer Dimensions:** 86.0 cm (L) x 39.5 cm (W) x 21.8 cm (H)

## 11.0 PROBE SPECIFICATION (ET3DV6)

Construction:	Symmetrical design with triangular core Built-in shielding against static charges PEEK enclosure material (resistant to organic solvents, e.g. glycol)
Calibration:	In air from 10 MHz to 2.5 GHz In brain simulating tissue at frequencies of 900 MHz and 1.8 GHz (accuracy $\pm 8\%$ )
Frequency:	10 MHz to $> 6$ GHz; Linearity: $\pm 0.2$ dB (30 MHz to 3 GHz)
Directivity:	$\pm 0.2$ dB in brain tissue (rotation around probe axis) $\pm 0.4$ dB in brain tissue (rotation normal to probe axis)
Dynamic Range:	$5 \mu\text{W/g}$ to $> 100 \text{ mW/g}$ ; Linearity: $\pm 0.2$ dB
Surface Detection:	$\pm 0.2$ mm repeatability in air and clear liquids over diffuse reflecting surfaces
Dimensions:	Overall length: 330 mm Tip length: 16 mm Body diameter: 12 mm Tip diameter: 6.8 mm Distance from probe tip to dipole centers: 2.7 mm
Application:	General dosimetry up to 3 GHz Compliance tests of mobile phone



ET3DV6 E-Field Probe

## 12.0 PLANAR PHANTOM

The planar phantom is constructed of Plexiglas material with a 2.0 mm shell thickness for face-held and body-worn SAR evaluations of handheld radio transceivers. The planar phantom is mounted on the side of the DASY4 system.



Plexiglas Planar Phantom

## 13.0 VALIDATION PLANAR PHANTOM

The validation planar phantom is constructed of Plexiglas material with a 6.0 mm shell thickness for system validations at 450MHz and below. The validation planar phantom is mounted in the DASY4 system.



Validation Planar Phantom

## 14.0 DEVICE HOLDER

The DASY4 device holder has two scales for device rotation (with respect to the body axis) and the device inclination (with respect to the line between the ear openings). The plane between the ear openings and the mouth tip has a rotation angle of  $65^\circ$ . The bottom plate contains three pair of bolts for locking the device holder. The device holder positions are adjusted to the standard measurement positions in the three sections.



Device Holder

## 15.0 TEST EQUIPMENT LIST

TEST EQUIPMENT	SERIAL NO.	CALIBRATION DATE
Schmid & Partner DASY4 System	-	-
DASY4 Measurement Server	1078	N/A
-Robot	599396-01	N/A
-ET3DV6 E-Field Probe	1387	Feb 2003
-300MHz Validation Dipole	135	Oct 2003
-450MHz Validation Dipole	136	Nov 2003
-900MHz Validation Dipole	054	June 2003
-1800MHz Validation Dipole	247	June 2003
-2450MHz Validation Dipole	150	Sept 2003
-Planar Phantom	161	N/A
-Validation Planar Phantom	137	N/A
HP 85070C Dielectric Probe Kit	N/A	N/A
Gigatronics 8651A Power Meter	8650137	April 2003
Gigatronics 8652A Power Meter	1835267	April 2003
Power Sensor 80701A	1833542	Feb 2003
Power Sensor 80701A	1833699	April 2003
HP E4408B Spectrum Analyzer	US39240170	Dec 2003
HP 8594E Spectrum Analyzer	3543A02721	April 2003
HP 8753E Network Analyzer	US38433013	May 2003
HP 8648D Signal Generator	3847A00611	May 2003
Amplifier Research 5S1G4 Power Amplifier	26235	N/A

## 16.0 MEASUREMENT UNCERTAINTIES

UNCERTAINTY BUDGET FOR DEVICE EVALUATION						
Error Description	Uncertainty Value ±%	Probability Distribution	Divisor	$C_i$ 1g	Standard Uncertainty ±% (1g)	$V_i$ OR $V_{eff}$
<b>Measurement System</b>						
Probe calibration	± 4.8	Normal	1	1	± 4.8	∞
Axial isotropy of the probe	± 4.7	Rectangular	√3	(1- $C_p$ )	± 1.9	∞
Spherical isotropy of the probe	± 9.6	Rectangular	√3	( $C_p$ )	± 3.9	∞
Spatial resolution	± 0.0	Rectangular	√3	1	± 0.0	∞
Boundary effects	± 5.5	Rectangular	√3	1	± 3.2	∞
Probe linearity	± 4.7	Rectangular	√3	1	± 2.7	∞
Detection limit	± 1.0	Rectangular	√3	1	± 0.6	∞
Readout electronics	± 1.0	Normal	1	1	± 1.0	∞
Response time	± 0.8	Rectangular	√3	1	± 0.5	∞
Integration time	± 1.4	Rectangular	√3	1	± 0.8	∞
RF ambient conditions	± 3.0	Rectangular	√3	1	± 1.7	∞
Mech. constraints of robot	± 0.4	Rectangular	√3	1	± 0.2	∞
Probe positioning	± 2.9	Rectangular	√3	1	± 1.7	∞
Extrapolation & integration	± 3.9	Rectangular	√3	1	± 2.3	∞
<b>Test Sample Related</b>						
Device positioning	± 6.0	Normal	√3	1	± 6.7	12
Device holder uncertainty	± 5.0	Normal	√3	1	± 5.9	8
Power drift	± 5.0	Rectangular	√3		± 2.9	∞
<b>Phantom and Setup</b>						
Phantom uncertainty	± 4.0	Rectangular	√3	1	± 2.3	∞
Liquid conductivity (target)	± 5.0	Rectangular	√3	0.6	± 1.7	∞
Liquid conductivity (measured)	± 5.0	Rectangular	√3	0.6	± 1.7	∞
Liquid permittivity (target)	± 5.0	Rectangular	√3	0.6	± 1.7	∞
Liquid permittivity (measured)	± 5.0	Rectangular	√3	0.6	± 1.7	∞
<b>Combined Standard Uncertainty</b>					<b>± 13.3</b>	
<b>Expanded Uncertainty (k=2)</b>					<b>± 26.6</b>	

Measurement Uncertainty Table in accordance with IEEE Standard 1528-200X (Draft - see reference [5])

## MEASUREMENT UNCERTAINTIES (Cont.)

UNCERTAINTY BUDGET FOR SYSTEM VALIDATION						
Error Description	Uncertainty Value ±%	Probability Distribution	Divisor	$C_i$ 1g	Standard Uncertainty ±% (1g)	$V_i$ OR $V_{eff}$
<b>Measurement System</b>						
Probe calibration	± 4.8	Normal	1	1	± 4.8	∞
Axial isotropy of the probe	± 4.7	Rectangular	√3	(1- $C_p$ )	± 1.9	∞
Spherical isotropy of the probe	± 9.6	Rectangular	√3	( $C_p$ )	± 3.9	∞
Spatial resolution	± 0.0	Rectangular	√3	1	± 0.0	∞
Boundary effects	± 5.5	Rectangular	√3	1	± 3.2	∞
Probe linearity	± 4.7	Rectangular	√3	1	± 2.7	∞
Detection limit	± 1.0	Rectangular	√3	1	± 0.6	∞
Readout electronics	± 1.0	Normal	1	1	± 1.0	∞
Response time	± 0.8	Rectangular	√3	1	± 0.5	∞
Integration time	± 1.4	Rectangular	√3	1	± 0.8	∞
RF ambient conditions	± 3.0	Rectangular	√3	1	± 1.7	∞
Mech. constraints of robot	± 0.4	Rectangular	√3	1	± 0.2	∞
Probe positioning	± 2.9	Rectangular	√3	1	± 1.7	∞
Extrapolation & integration	± 3.9	Rectangular	√3	1	± 2.3	∞
<b>Dipole</b>						
Dipole Axis to Liquid Distance	± 2.0	Rectangular	√3	1	± 1.2	∞
Input Power	± 4.7	Rectangular	√3	1	± 2.7	∞
<b>Phantom and Setup</b>						
Phantom uncertainty	± 4.0	Rectangular	√3	1	± 2.3	∞
Liquid conductivity (target)	± 5.0	Rectangular	√3	0.6	± 1.7	∞
Liquid conductivity (measured)	± 5.0	Rectangular	√3	0.6	± 1.7	∞
Liquid permittivity (target)	± 5.0	Rectangular	√3	0.6	± 1.7	∞
Liquid permittivity (measured)	± 5.0	Rectangular	√3	0.6	± 1.7	∞
<b>Combined Standard Uncertainty</b>					<b>± 9.9</b>	
<b>Expanded Uncertainty (k=2)</b>					<b>± 19.8</b>	

Measurement Uncertainty Table in accordance with IEEE Standard 1528-200X (Draft - see reference [5])

## 17.0 REFERENCES

- [1] Federal Communications Commission, "Radiofrequency radiation exposure evaluation: portable devices", Rule Part 47 CFR §2.1093: 1999.
- [2] Health Canada, "Limits of Human Exposure to Radiofrequency Electromagnetic Fields in the Frequency Range from 3 kHz to 300 GHz", Safety Code 6.
- [3] Federal Communications Commission, "Evaluating Compliance with FCC Guidelines for Human Exposure to Radio frequency Electromagnetic Fields", OET Bulletin 65, Supplement C (Edition 01-01), FCC, Washington, D.C.: June 2001.
- [4] Industry Canada, "Evaluation Procedure for Mobile and Portable Radio Transmitters with respect to Health Canada's Safety Code 6 for Exposure of Humans to Radio Frequency Fields", Radio Standards Specification RSS-102 Issue 1 (Provisional): September 1999.
- [5] IEEE Standards Coordinating Committee 34, Std 1528-200X, "DRAFT Recommended Practice for Determining the Spatial-Peak Specific Absorption Rate (SAR) in the Human Body Due to Wireless Communications Devices: Experimental Techniques".

Test Report S/N:	102803-440K66
Test Date(s):	December 08, 2003
Test Type:	FCC/IC SAR Evaluation

## APPENDIX A - SAR MEASUREMENT DATA

Date Tested: 12/08/03

DUT: Vertex Standard Model: VX-427-4-5; Type: FM UHF PTT Radio Transceiver; Serial: 3M000012

Ambient Temp: 23.9 °C; Fluid Temp: 21.8 °C; Barometric Pressure: 102.2 kPa; Humidity: 66%

7.2 V NiCd Battery Pack

Communication System: FM UHF

Frequency: 470 MHz; Duty Cycle: 1:1

RF Output Power: 5.35 Watts (Conducted)

Medium: HSL450 ( $\sigma = 0.83$  mho/m,  $\epsilon_r = 41.5$ ,  $\rho = 1000$  kg/m<sup>3</sup>)

- Probe: ET3DV6 - SN1387; ConvF(7.5, 7.5, 7.5); Calibrated: 26/02/2003
- Sensor-Surface: 4mm (Mechanical Surface Detection)
- Electronics: DAE3 Sn370; Calibrated: 19/05/2003
- Phantom: Planar; Type: Plexiglas; Serial: 161
- Measurement SW: DASY4, V4.1 Build 47; Postprocessing SW: SEMCAD, V1.6 Build 116

**Face-Held - 2.5 cm Separation Distance - Mid Channel/Area Scan (7x19x1):**

Measurement grid: dx=15mm, dy=15mm

**Face-Held - 2.5 cm Separation Distance - Mid Channel/Zoom Scan (7x7x7)/Cube 0:**

Measurement grid: dx=5mm, dy=5mm, dz=5mm

Peak SAR (extrapolated) = 12.9 W/kg

**SAR(1 g) = 7.16 mW/g; SAR(10 g) = 4.96 mW/g**

Reference Value = 90.5 V/m

Power Drift = -0.38 dB

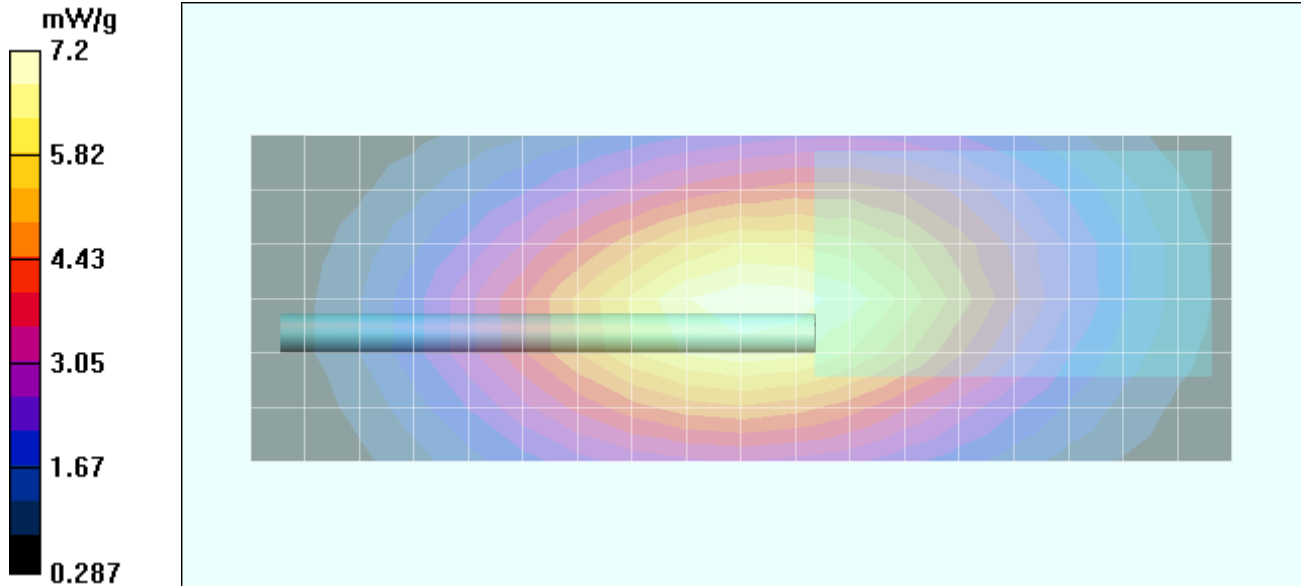



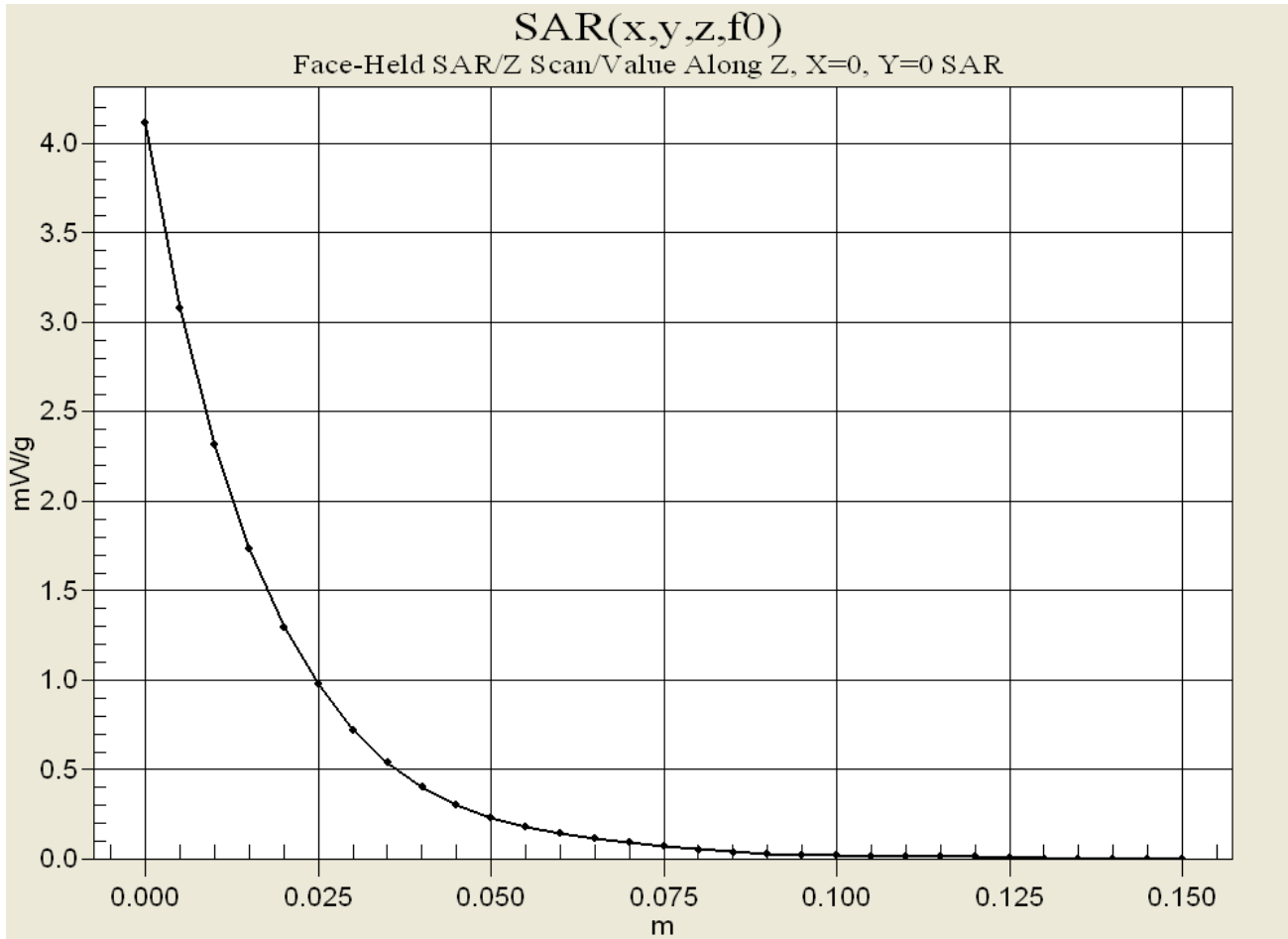

Date Tested: 12/08/03

DUT: Vertex Standard Model: VX-427-4-5; Type: FM UHF PTT Radio Transceiver; Serial: 3M000012

Body-worn Accessories: Belt-Clip, Speaker-Microphone

Ambient Temp: 23.9 °C; Fluid Temp: 21.7 °C; Barometric Pressure: 102.2 kPa; Humidity: 66%

7.2 V NiCd Battery Pack

Communication System: FM UHF

Frequency: 470 MHz; Duty Cycle: 1:1

RF Output Power: 5.37 Watts (Conducted)

Medium: M450 ( $\sigma = 0.95$  mho/m,  $\epsilon_r = 57.5$ ,  $\rho = 1000$  kg/m<sup>3</sup>)

- Probe: ET3DV6 - SN1387; ConvF(7.7, 7.7, 7.7); Calibrated: 26/02/2003
- Sensor-Surface: 4mm (Mechanical Surface Detection)
- Electronics: DAE3 Sn370; Calibrated: 19/05/2003
- Phantom: Planar; Type: Plexiglas; Serial: 161
- Measurement SW: DASY4, V4.1 Build 47; Postprocessing SW: SEMCAD, V1.6 Build 116

**Body-Worn - 1.3 cm Belt-Clip Separation Distance - Mid Channel/Area Scan (7x19x1):**

Measurement grid: dx=15mm, dy=15mm

**Body-Worn - 1.3 cm Belt-Clip Separation Distance - Mid Channel/Zoom Scan (7x7x7)/Cube 0:**

Measurement grid: dx=5mm, dy=5mm, dz=5mm

Peak SAR (extrapolated) = 17.9 W/kg

**SAR(1 g) = 11.3 mW/g; SAR(10 g) = 7.84 mW/g**

Reference Value = 105.7 V/m

Power Drift = -0.39 dB

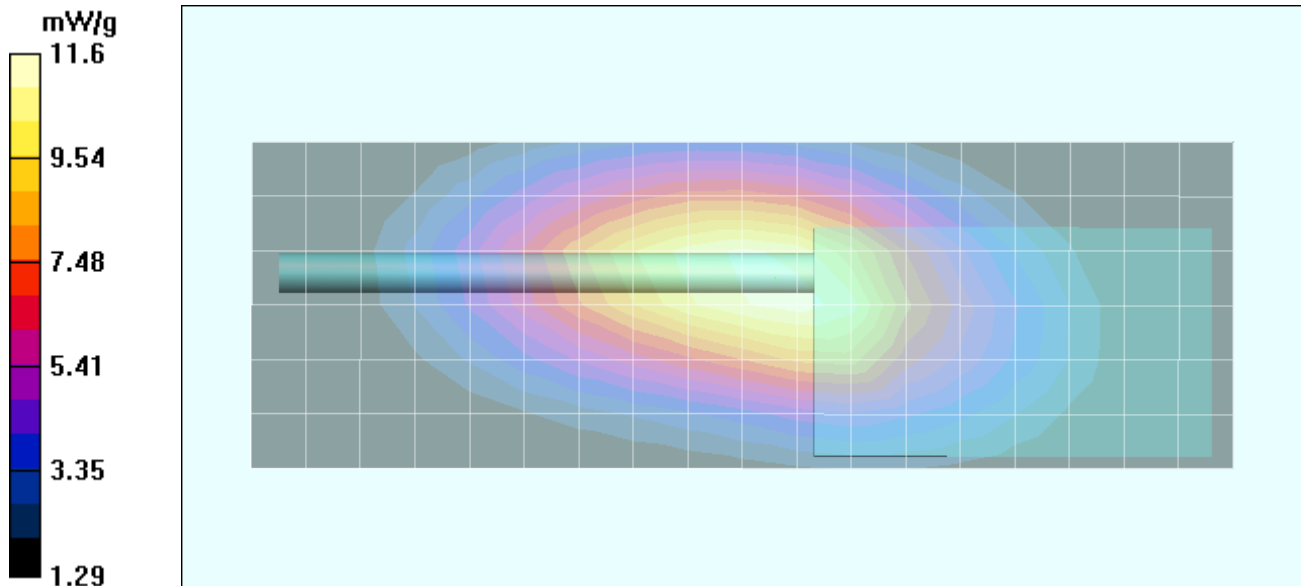

Date Tested: 12/08/03

DUT: Vertex Standard Model: VX-427-4-5; Type: FM UHF PTT Radio Transceiver; Serial: 3M000012

Body-worn Accessories: Belt-Clip, Speaker-Microphone

Ambient Temp: 23.9 °C; Fluid Temp: 21.7 °C; Barometric Pressure: 102.2 kPa; Humidity: 66%

7.2 V NiCd Battery Pack

Communication System: FM UHF

Frequency: 450 MHz; Duty Cycle: 1:1

RF Output Power: 5.19 Watts (Conducted)

Medium: M450 ( $\sigma = 0.95 \text{ mho/m}$ ,  $\epsilon_r = 57.5$ ,  $\rho = 1000 \text{ kg/m}^3$ )

- Probe: ET3DV6 - SN1387; ConvF(7.7, 7.7, 7.7); Calibrated: 26/02/2003
- Sensor-Surface: 4mm (Mechanical Surface Detection)
- Electronics: DAE3 Sn370; Calibrated: 19/05/2003
- Phantom: Planar; Type: Plexiglas; Serial: 161
- Measurement SW: DASy4, V4.1 Build 47; Postprocessing SW: SEMCAD, V1.6 Build 116

**Body-Worn - 1.3 cm Belt-Clip Separation Distance - Low Channel/Area Scan (7x19x1):**

Measurement grid: dx=15mm, dy=15mm

**Body-Worn - 1.3 cm Belt-Clip Separation Distance - Low Channel/Zoom Scan (7x7x7)/Cube 0:**

Measurement grid: dx=5mm, dy=5mm, dz=5mm

Peak SAR (extrapolated) = 23.4 W/kg

**SAR(1 g) = 13.8 mW/g; SAR(10 g) = 9.78 mW/g**

Reference Value = 119.8 V/m

Power Drift = -0.35 dB

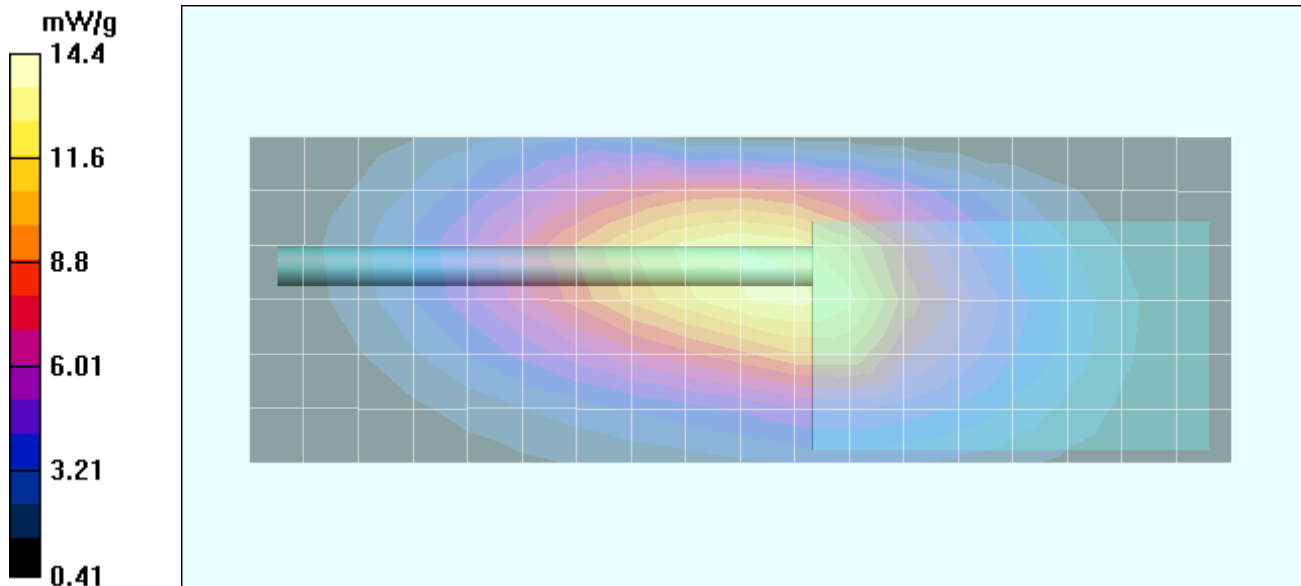

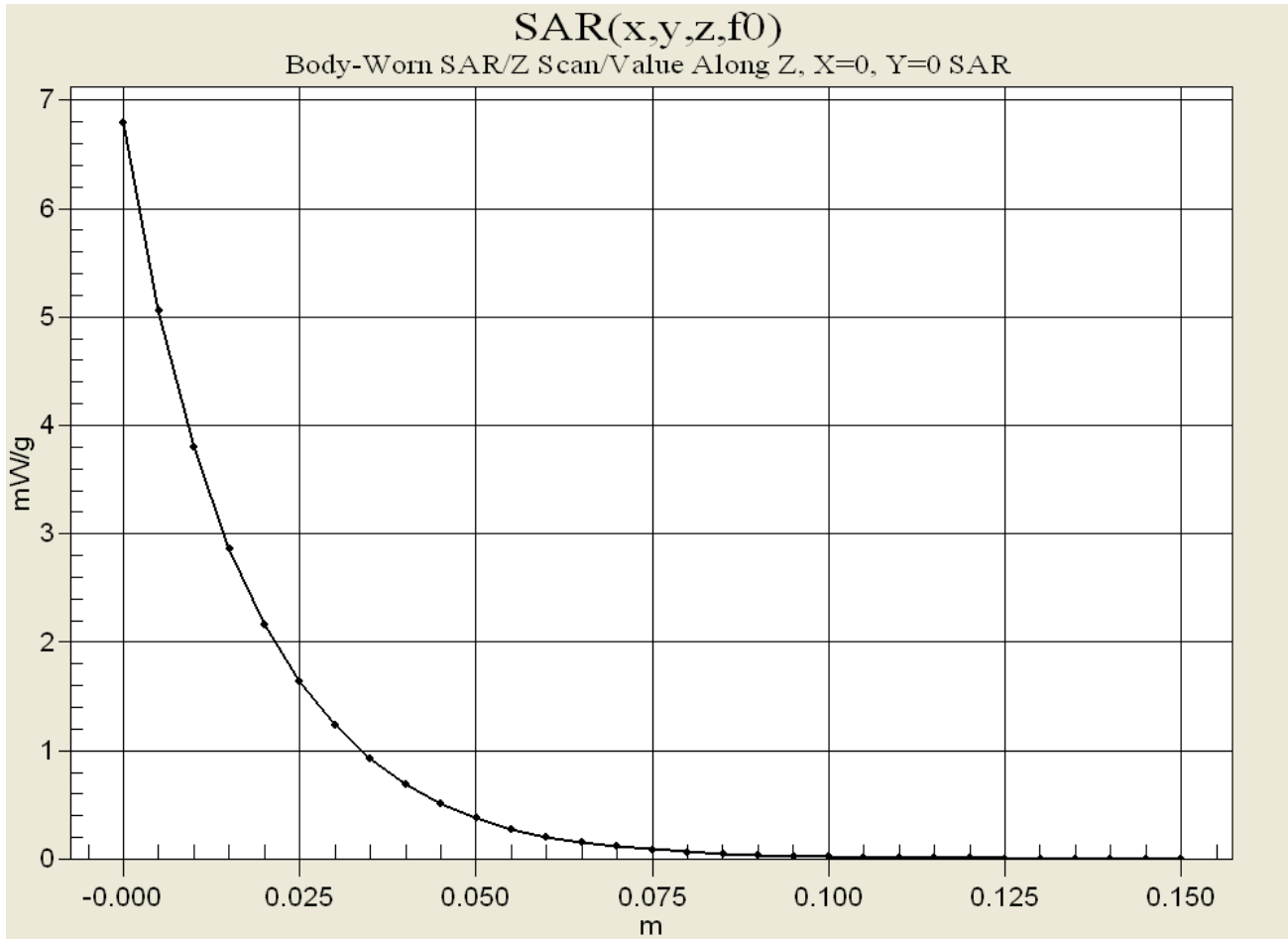

Date Tested: 12/08/03

DUT: Vertex Standard Model: VX-427-4-5; Type: FM UHF PTT Radio Transceiver; Serial: 3M000012

Body-worn Accessories: Belt-Clip, Speaker-Microphone

Ambient Temp: 23.9 °C; Fluid Temp: 21.7 °C; Barometric Pressure: 102.2 kPa; Humidity: 66%

7.2 V NiCd Battery Pack

Communication System: FM UHF

Frequency: 490 MHz; Duty Cycle: 1:1

RF Output Power: 5.21 Watts (Conducted)

Medium: M450 ( $\sigma = 0.95$  mho/m,  $\epsilon_r = 57.5$ ,  $\rho = 1000$  kg/m<sup>3</sup>)

- Probe: ET3DV6 - SN1387; ConvF(7.7, 7.7, 7.7); Calibrated: 26/02/2003

- Sensor-Surface: 4mm (Mechanical Surface Detection)

- Electronics: DAE3 Sn370; Calibrated: 19/05/2003

- Phantom: Planar; Type: Plexiglas; Serial: 161

- Measurement SW: DASY4, V4.1 Build 47; Postprocessing SW: SEMCAD, V1.6 Build 116

**Body Worn - 1.3 cm Belt-Clip Separation Distance - High Channel/Area Scan (7x19x1):**

Measurement grid: dx=15mm, dy=15mm

**Body-Worn - 1.3 cm Belt-Clip Separation Distance - High Channel/Zoom Scan (7x7x7)/Cube 0:**

Measurement grid: dx=5mm, dy=5mm, dz=5mm

Peak SAR (extrapolated) = 19.3 W/kg

**SAR(1 g) = 12.2 mW/g; SAR(10 g) = 8.49 mW/g**

Reference Value = 117.3 V/m

Power Drift = -0.39 dB

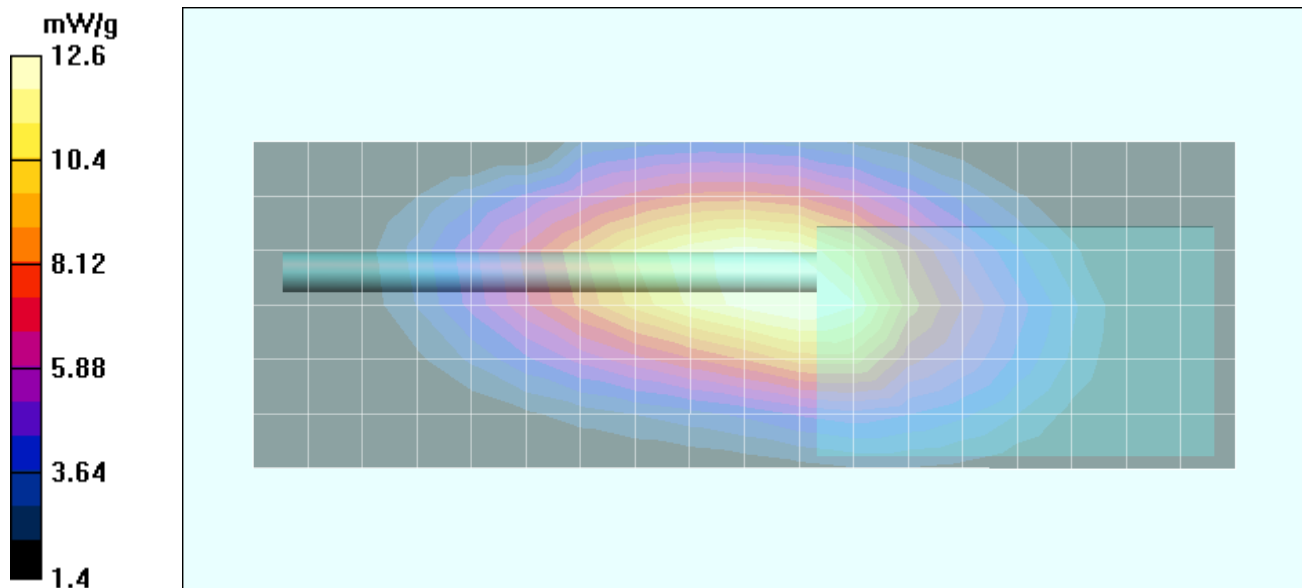

Test Report S/N:	102803-440K66
Test Date(s):	December 08, 2003
Test Type:	FCC/IC SAR Evaluation

## APPENDIX B - SYSTEM PERFORMANCE CHECK DATA

Date Tested: 12/08/03

DUT: Dipole 450 MHz; Model: D450V2; Type: System Performance Check; Serial: 136

Ambient Temp: 23.9 °C; Fluid Temp: 21.8 °C; Barometric Pressure: 102.2 kPa; Humidity: 66%

Communication System: CW  
 Forward Conducted Power: 250 mW  
 Frequency: 450 MHz; Duty Cycle: 1:1  
 Medium: HSL450 ( $\sigma = 0.83$  mho/m,  $\epsilon_r = 41.5$ ,  $\rho = 1000$  kg/m<sup>3</sup>)

- Probe: ET3DV6 - SN1387; ConvF(7.5, 7.5, 7.5); Calibrated: 26/02/2003
- Sensor-Surface: 4mm (Mechanical Surface Detection)
- Electronics: DAE3 Sn370; Calibrated: 19/05/2003
- Phantom: Validation Planar; Type: Plexiglas; Serial: 137
- Measurement SW: DASY4, V4.1 Build 47; Postprocessing SW: SEMCAD, V1.6 Build 116

**450 MHz System Validation/Area Scan (6x11x1):** Measurement grid: dx=15mm, dy=15mm

**450 MHz System Validation/Zoom Scan (7x7x7)/Cube 0:** Measurement grid: dx=5mm, dy=5mm, dz=5mm  
 Peak SAR (extrapolated) = 2.26 W/kg  
**SAR(1 g) = 1.29 mW/g; SAR(10 g) = 0.812 mW/g**  
 Reference Value = 37.3 V/m  
 Power Drift = -0.01 dB

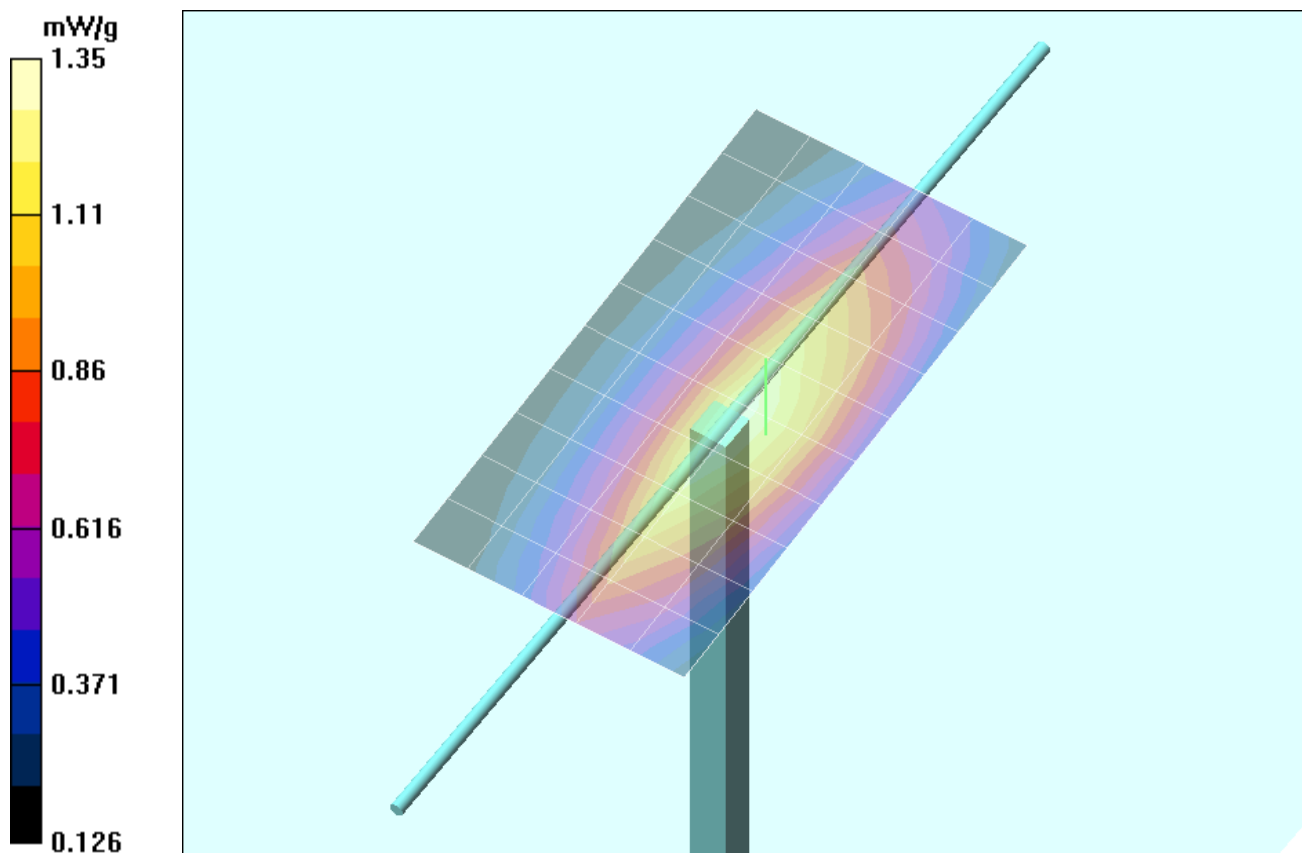

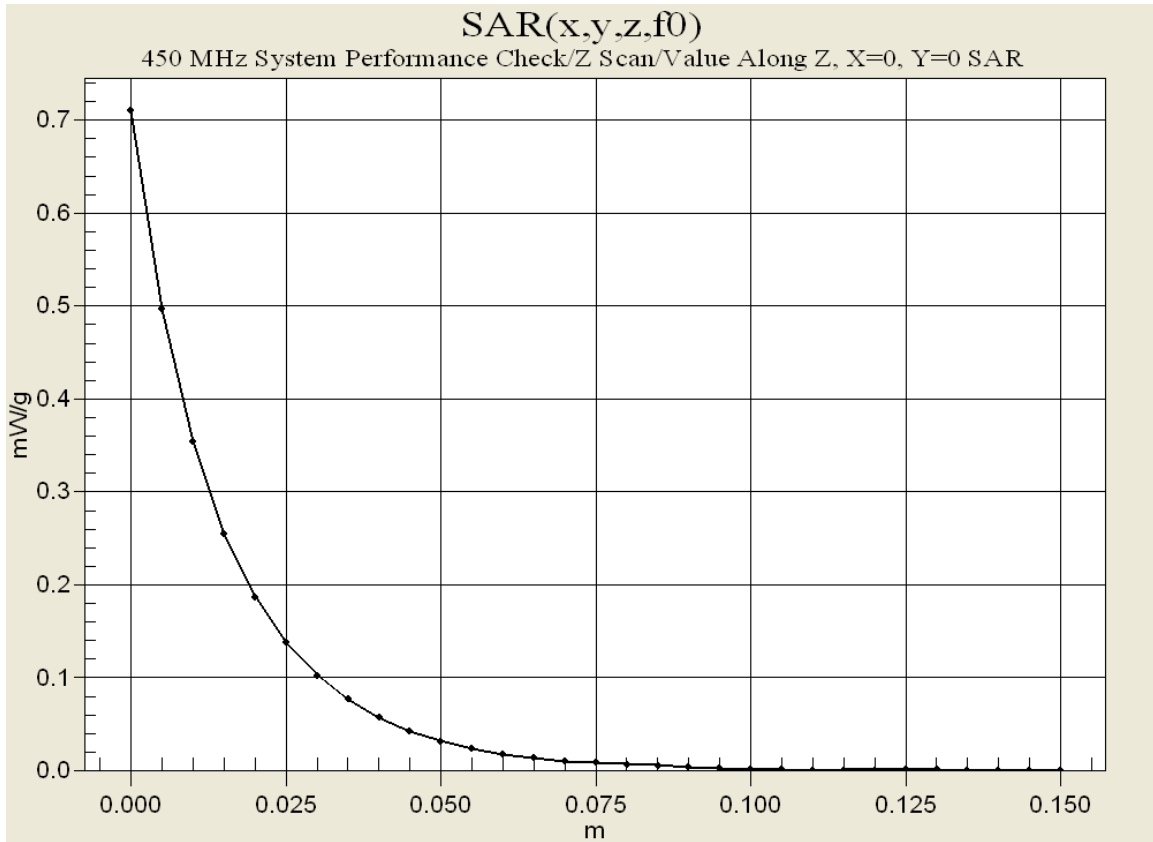



Test Report S/N:	102803-440K66
Test Date(s):	December 08, 2003
Test Type:	FCC/IC SAR Evaluation

## APPENDIX C - SYSTEM VALIDATION

## 450MHz SYSTEM VALIDATION DIPOLE

Type:

450MHz Validation Dipole

Serial Number:

136

Place of Calibration:

Celltech Labs Inc.

Date of Calibration:

November 4, 2003

Celltech Labs Inc. hereby certifies that this device has been calibrated on the date indicated above.

Calibrated by:

*Spencer Watson*

Approved by:

*Russell W. Pope*

## 1. Dipole Construction & Electrical Characteristics

The validation dipole was constructed in accordance with the IEEE Std “Recommended Practice for Determining the Spatial-Peak Specific Absorption Rate (SAR) in the Human Body Due to Wireless Communications Devices: Experimental Techniques”. The electrical properties were measured using an HP 8753E Network Analyzer. The network analyzer was calibrated to the validation dipole N-type connector feed point using an HP85032E Type N calibration kit. The dipole was placed parallel to a planar phantom at a separation distance of 15.0mm from the simulating fluid using a loss-less dielectric spacer. The measured input impedance is:

Feed point impedance at 450MHz	$\text{Re}\{Z\} = 49.982\Omega$
	$\text{Im}\{Z\} = 7.2324\Omega$
Return Loss at 450MHz	-22.597dB

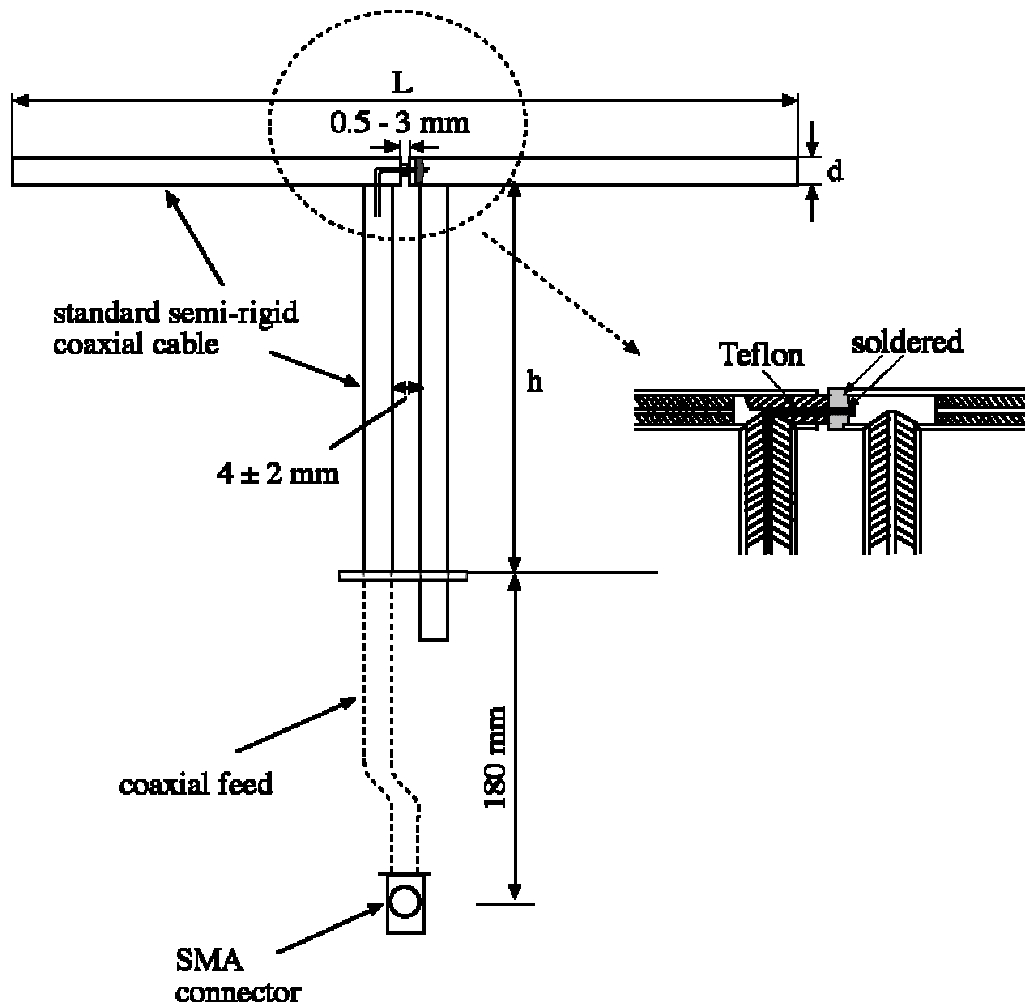

CH1 S11 1 U FS 1: 49.982  $\Omega$  7.2324  $\Omega$  2.5579 nH 4 Nov 2003 12:04:21 450.000 000 MHz

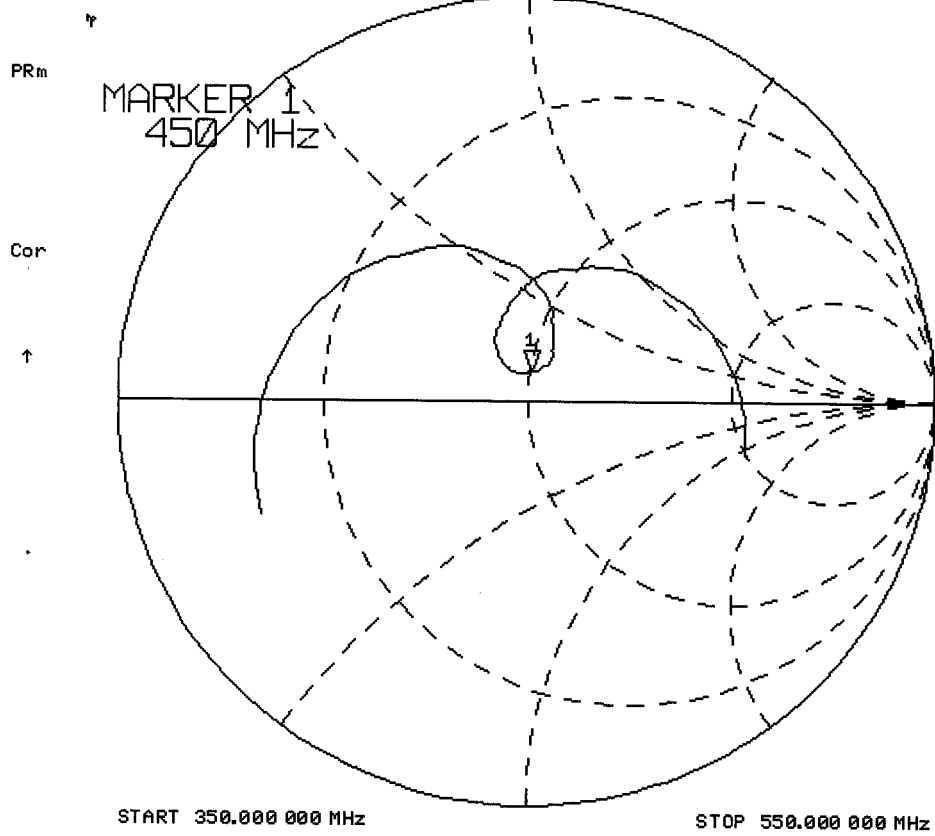

[CH1] S11 LOG 10 dB/REF 0 dB 4 Nov 2003 12:06:24  
1:-22.597 dB 450.000 000 MHz

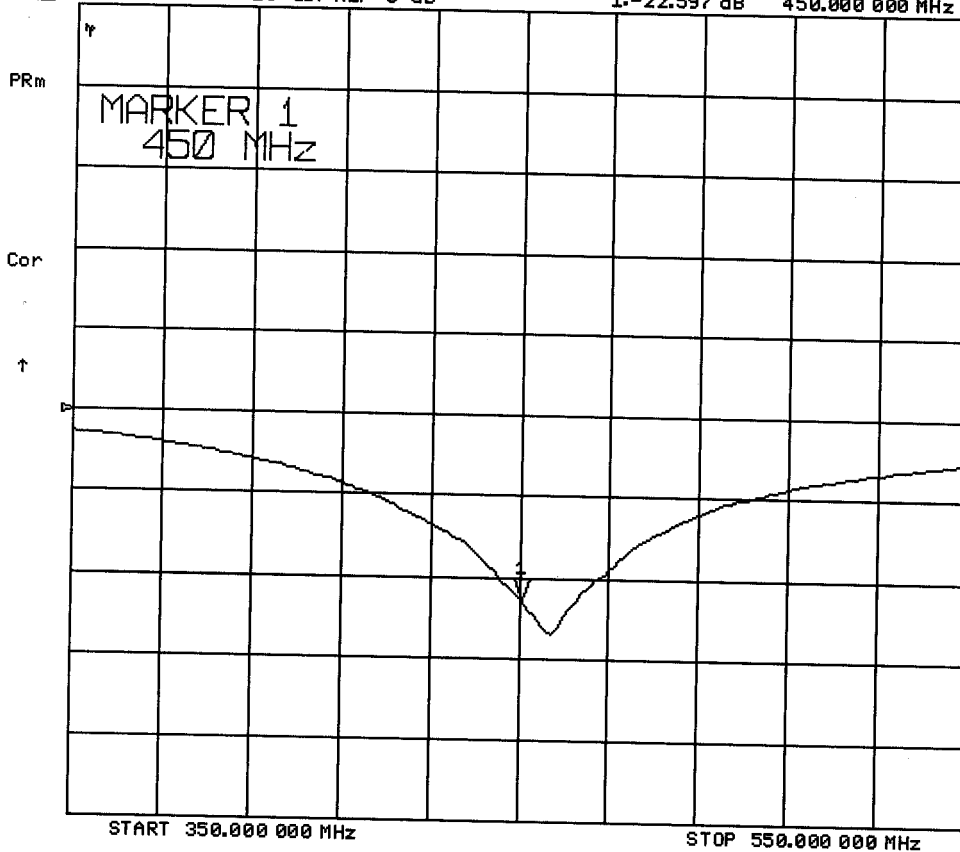

## 2. Validation Dipole Dimensions

Frequency (MHz)	L (mm)	h (mm)	d (mm)
300	420.0	250.0	6.2
450	288.0	167.0	6.2
835	161.0	89.8	3.6
900	149.0	83.3	3.6
1450	89.1	51.7	3.6
1800	72.0	41.7	3.6
1900	68.0	39.5	3.6
2000	64.5	37.5	3.6
2450	51.8	30.6	3.6
3000	41.5	25.0	3.6

## 3. Validation Phantom

The validation phantom was constructed using relatively low-loss tangent Plexiglas material. The inner dimensions of the phantom are as follows:

Length: 83.5 cm  
 Width: 36.9 cm  
 Height: 21.8 cm

The bottom section of the validation phantom is constructed of  $6.2 \pm 0.1$ mm Plexiglas.

#### 4. Dimensions of Plexiglas Planar Phantom

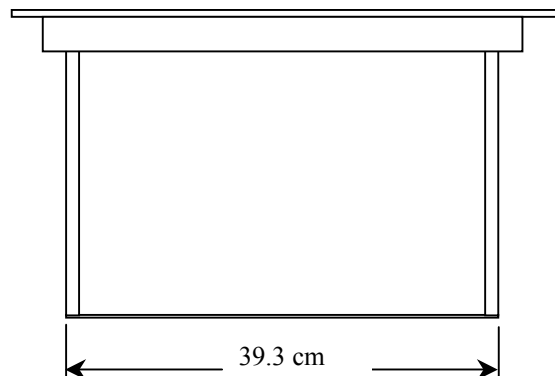
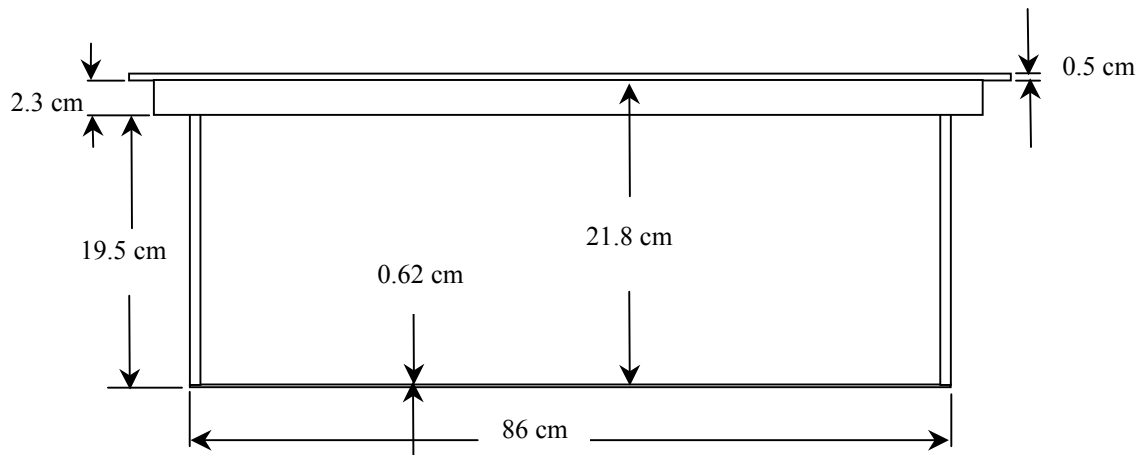
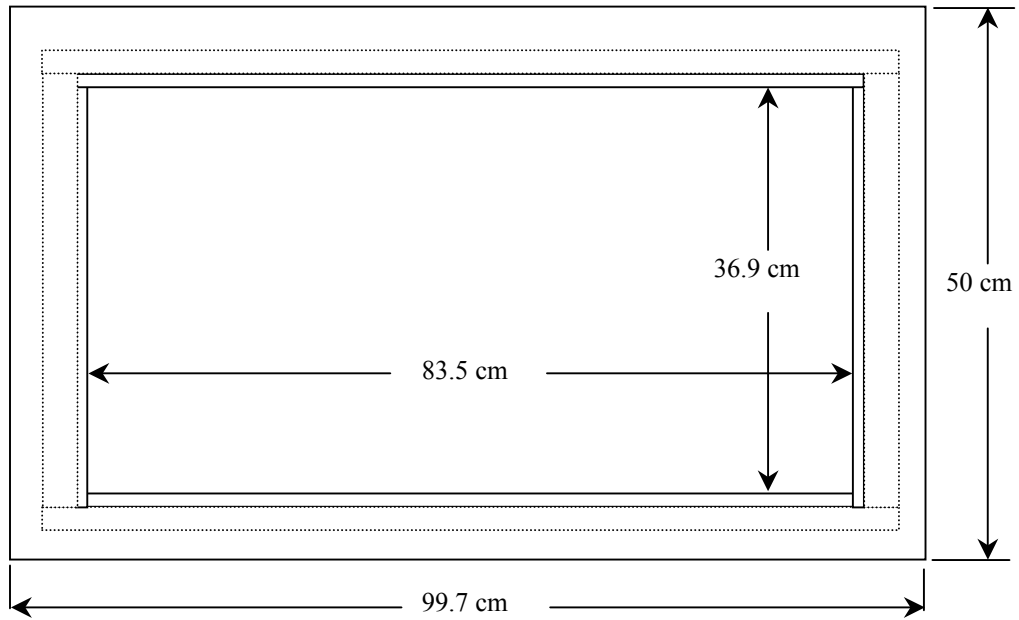

**5. 450MHz System Validation Setup**





**450MHz System Validation Setup**

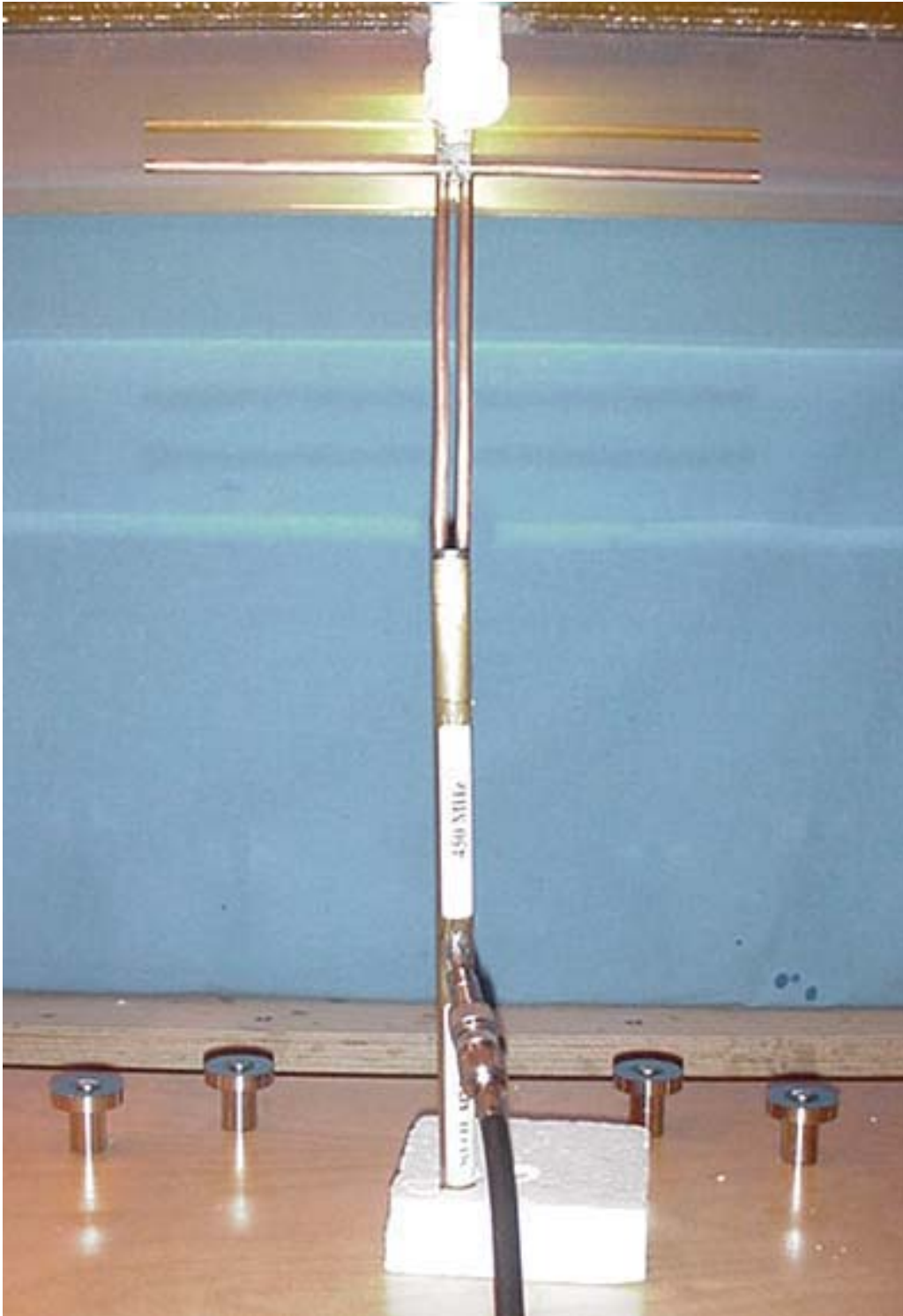

## 6. Measurement Conditions

The planar phantom was filled with brain simulating tissue having the following parameters at 450MHz:

Relative Permittivity:	43.7
Conductivity:	0.88 mho/m
Fluid Temperature:	22.0 °C
Fluid Depth:	≥ 15.0 cm

Environmental Conditions:

Ambient Temperature:	22.1 °C
Humidity:	49 %
Barometric Pressure:	102.8 kPa

The 450MHz simulated brain tissue mixture consists of the following ingredients:

<b>Ingredient</b>	<b>Percentage by weight</b>
Water	38.56%
Sugar	56.32%
Salt	3.95%
HEC	0.98%
Dowicil 75	0.19%
450MHz Target Dielectric Parameters at 22 °C	$\epsilon_r = 43.5$ $\sigma = 0.87 \text{ S/m}$

## 7. SAR Measurement

The SAR measurement was performed with the E-field probe in mechanical detection mode only. The setup and determination of the forward power into the dipole was performed using the following procedures.

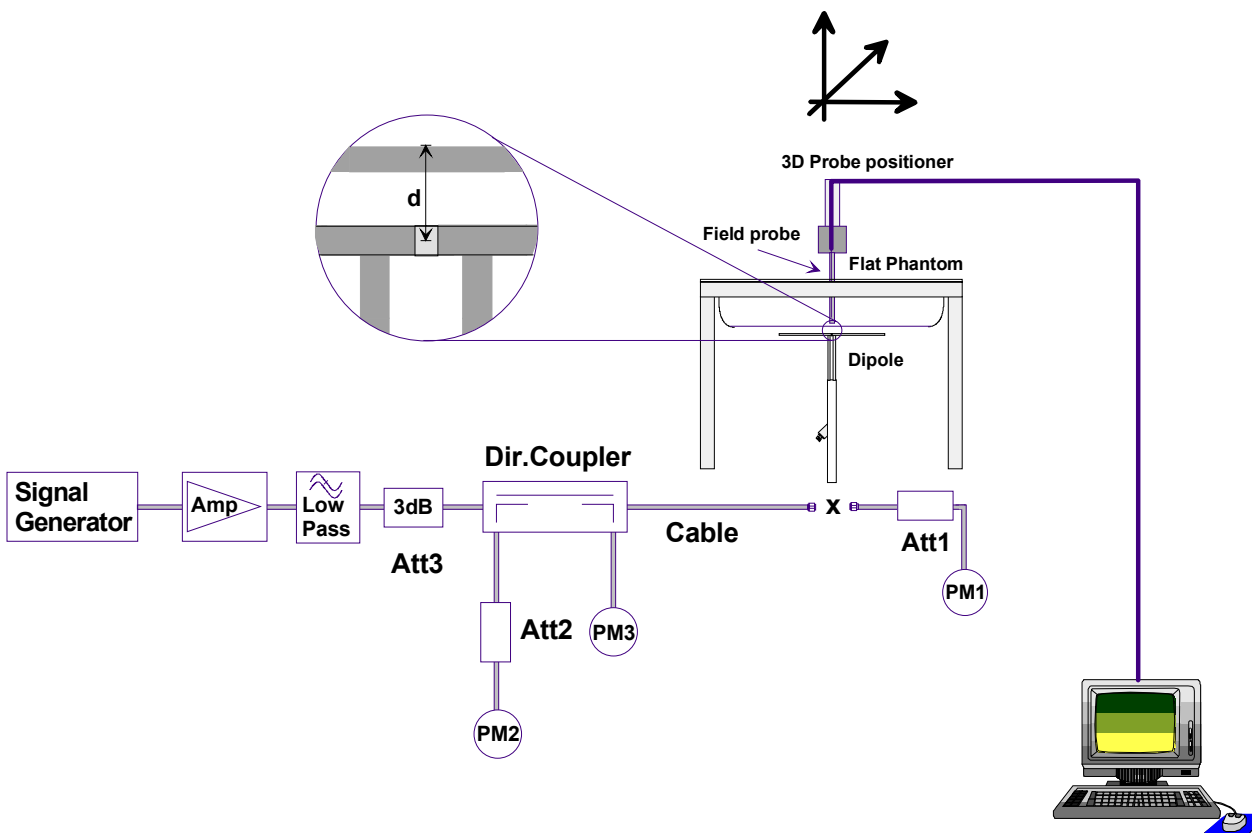

First the power meter PM1 (including attenuator Att1) is connected to the cable to measure the forward power at the location of the dipole connector (X). The signal generator is adjusted for the desired forward power at the dipole connector (taking into account the attenuation of Att1) as read by power meter PM2. After connecting the cable to the dipole, the signal generator is readjusted for the same reading at power meter PM2. If the signal generator does not allow adjustment in 0.01dB steps, the remaining difference at PM2 must be taken into consideration. PM3 records the reflected power from the dipole to ensure that the value is not changed from the previous value. The reflected power should be 20dB below the forward power.

## 8. Validation Dipole SAR Test Results

Ten SAR measurements were performed in order to achieve repeatability and to establish an average target value.

Validation Measurement	SAR @ 0.25W Input averaged over 1g	SAR @ 1W Input averaged over 1g	SAR @ 0.25W Input averaged over 10g	SAR @ 1W Input averaged over 10g	Peak SAR @ 0.25W Input
Test 1	1.29	5.16	0.810	3.24	2.28
Test 2	1.31	5.24	0.827	3.31	2.31
Test 3	1.30	5.20	0.823	3.29	2.29
Test 4	1.30	5.20	0.822	3.29	2.29
Test 5	1.29	5.16	0.819	3.28	2.28
Test 6	1.30	5.20	0.826	3.30	2.28
Test 7	1.31	5.24	0.826	3.30	2.30
Test 8	1.31	5.24	0.829	3.32	2.30
Test 9	1.30	5.20	0.822	3.29	2.28
Test 10	1.31	5.24	0.822	3.29	2.33
Average Value	1.30	5.21	0.823	3.29	2.29

The results have been normalized to 1W (forward power) into the dipole.

IEEE Target over 1cm<sup>3</sup> (1g) of tissue: 1.23 mW/g (+/- 10%)

Averaged over 1cm (1g) of tissue: 5.21 mW/g

Averaged over 10cm (10g) of tissue: 3.29 mW/g

Test Date: 11/04/03

DUT: Dipole 450MHz; Model: D450V2; Type: System Performance Check; Serial: 136

Ambient Temp: 22.1°C; Fluid Temp: 22.0°C; Barometric Pressure: 102.8 kPa; Humidity: 49%

Communication System: CW  
Forward Conducted Power: 250 mW  
Frequency: 450 MHz; Duty Cycle: 1:1  
Medium: HSL450 ( $\sigma = 0.88$  mho/m,  $\epsilon_r = 43.7$ ,  $\rho = 1000$  kg/m<sup>3</sup>)

- Probe: ET3DV6 - SN1387; ConvF(7.5, 7.5, 7.5); Calibrated: 26/02/2003
- Sensor-Surface: 4mm (Mechanical Surface Detection)
- Electronics: DAE3 Sn370; Calibrated: 19/05/2003
- Phantom: Validation Planar; Type: Plexiglas; Serial: 137
- Measurement SW: DASY4, V4.1 Build 47; Postprocessing SW: SEMCAD, V1.6 Build 116

**450 MHz Validation/Area Scan (6x11x1):** Measurement grid: dx=15mm, dy=15mm

Reference Value = 39 V/m

Power Drift = -0.08 dB

Maximum value of SAR = 1.3 mW/g

**450 MHz Validation/Zoom Scan 8 (7x7x7)/Cube 0:** Measurement grid: dx=5mm, dy=5mm, dz=5mm

Peak SAR (extrapolated) = 2.28 W/kg

**SAR(1 g) = 1.3 mW/g; SAR(10 g) = 0.822 mW/g**

Reference Value = 39 V/m

Power Drift = 0.08 dB

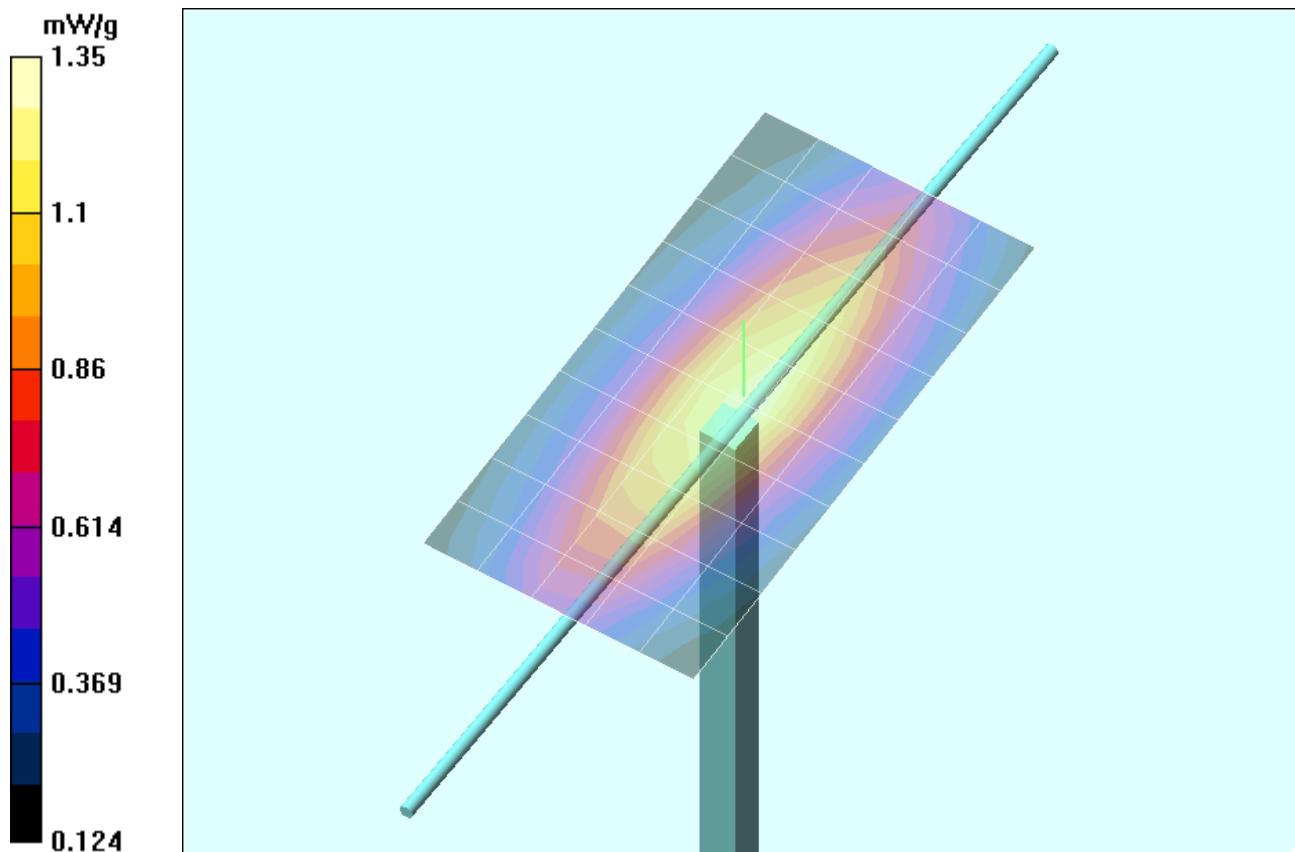

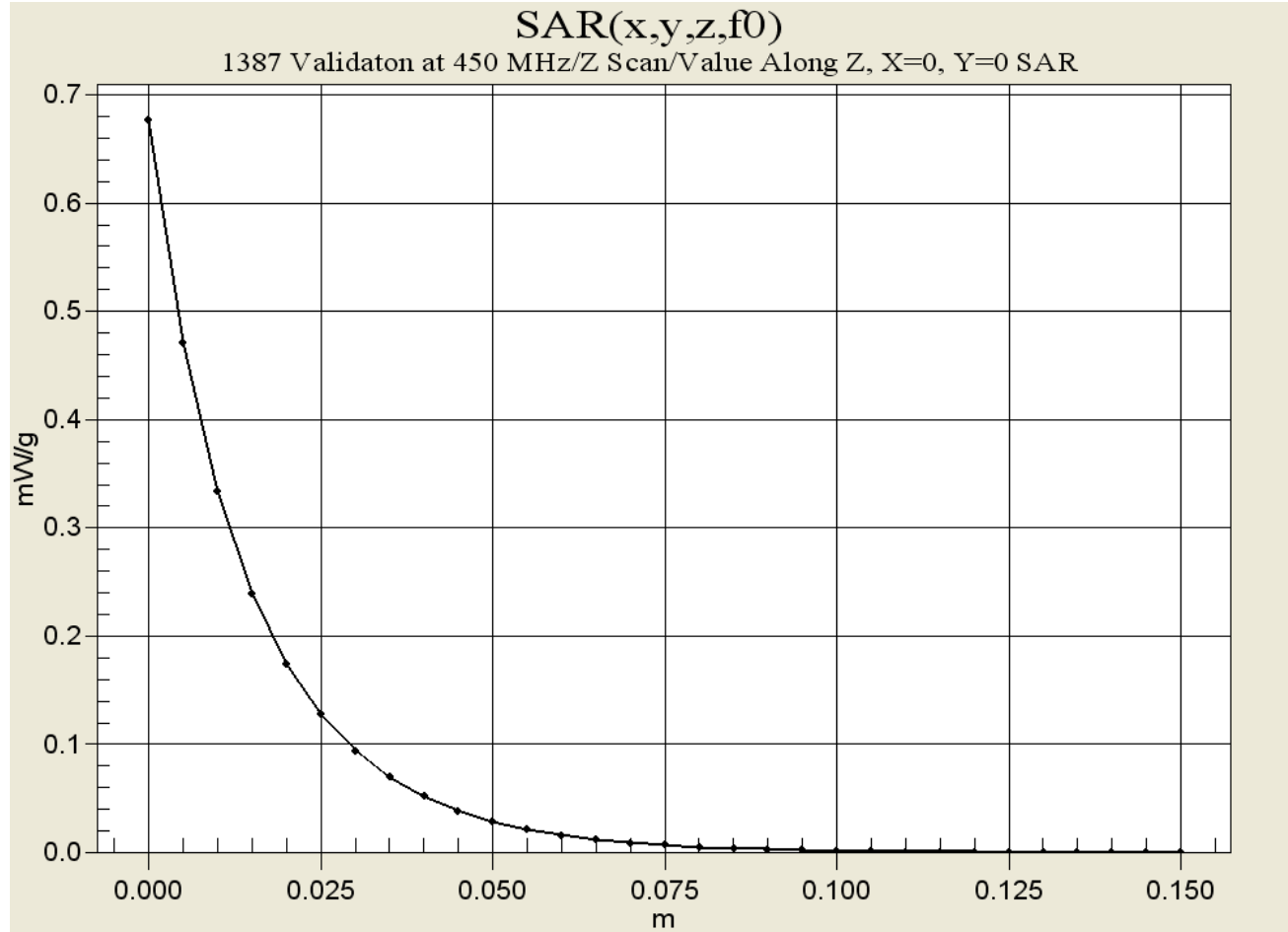

# 450MHz System Validation

## Measured Fluid Dielectric Parameters (Brain)

November 04, 2003

Frequency	$\epsilon'$	$\epsilon''$
350.000000 MHz	46.2660	40.8224
360.000000 MHz	45.9937	40.0986
370.000000 MHz	45.7556	39.4543
380.000000 MHz	45.5625	38.7387
390.000000 MHz	45.2820	38.1140
400.000000 MHz	45.0146	37.4981
410.000000 MHz	44.7508	36.9734
420.000000 MHz	44.5046	36.4917
430.000000 MHz	44.2494	35.9460
440.000000 MHz	43.9621	35.5647
450.000000 MHz	43.7384	35.2106
460.000000 MHz	43.5513	34.7930
470.000000 MHz	43.2846	34.3970
480.000000 MHz	43.0654	33.9576
490.000000 MHz	42.8566	33.6391
500.000000 MHz	42.6744	33.2270
510.000000 MHz	42.5036	32.8459
520.000000 MHz	42.3492	32.5261
530.000000 MHz	42.1783	32.1727
540.000000 MHz	41.9985	31.7385
550.000000 MHz	41.8097	31.4862

Test Report S/N:	102803-440K66
Test Date(s):	December 08, 2003
Test Type:	FCC/IC SAR Evaluation

## APPENDIX D - PROBE CALIBRATION



Client **Celltech Labs**

**CALIBRATION CERTIFICATE**

Object(s) **ET3DV6 - SN: 1387**

Calibration procedure(s) **QA CAL-01.v2  
 Calibration procedure for dosimetric E-field probes**

Calibration date: **February 26, 2003**



Condition of the calibrated item **In Tolerance (according to the specific calibration document)**

This calibration statement documents traceability of M&TE used in the calibration procedures and conformity of the procedures with the ISO/IEC 17025 international standard.

All calibrations have been conducted in the closed laboratory facility: environment temperature 22 +/- 2 degrees Celsius and humidity < 75%.

Calibration Equipment used (M&TE critical for calibration)

Model Type	ID #	Cal Date	Scheduled Calibration
RF generator HP 8684C	US3642U01700	4-Aug-99 (in house check Aug-02)	In house check: Aug-05
Power sensor E4412A	MY41495277	8-Mar-02	Mar-03
Power sensor HP 8481A	MY41092180	18-Sep-02	Sep-03
Power meter EPM E4419B	GB41293874	13-Sep-02	Sep-03
Network Analyzer HP 8753E	US38432426	3-May-00	In house check: May 03
Fluke Process Calibrator Type 702	SN: 6295803	3-Sep-01	Sep-03

	Name	Function	Signature
Calibrated by:	Nico Vetterli	Technician	
Approved by:	Katja Pokovic	Laboratory Director	

Date issued: February 26, 2003

This calibration certificate is issued as an intermediate solution until the accreditation process (based on ISO/IEC 17025 International Standard) for Calibration Laboratory of Schmid & Partner Engineering AG is completed.

# Probe ET3DV6

## SN:1387

Manufactured:	September 21, 1999
Last calibration:	February 22, 2002
Recalibrated:	February 26, 2003

**Calibrated for DASYS Systems**

(Note: non-compatible with DASYS2 system!)

## DASY - Parameters of Probe: ET3DV6 SN:1387

### Sensitivity in Free Space

NormX	<b>1.55</b> $\mu\text{V}/(\text{V}/\text{m})^2$
NormY	<b>1.65</b> $\mu\text{V}/(\text{V}/\text{m})^2$
NormZ	<b>1.64</b> $\mu\text{V}/(\text{V}/\text{m})^2$

### Diode Compression

DCP X	<b>92</b>	mV
DCP Y	<b>92</b>	mV
DCP Z	<b>92</b>	mV

### Sensitivity in Tissue Simulating Liquid

<b>Head</b>	<b>900 MHz</b>	$\epsilon_r = 41.5 \pm 5\%$	$\sigma = 0.97 \pm 5\% \text{ mho/m}$
<b>Head</b>	<b>835 MHz</b>	$\epsilon_r = 41.5 \pm 5\%$	$\sigma = 0.90 \pm 5\% \text{ mho/m}$
ConvF X	<b>6.6</b> $\pm 9.5\%$ (k=2)	Boundary effect:	
ConvF Y	<b>6.6</b> $\pm 9.5\%$ (k=2)	Alpha	<b>0.37</b>
ConvF Z	<b>6.6</b> $\pm 9.5\%$ (k=2)	Depth	<b>2.61</b>
<b>Head</b>	<b>1800 MHz</b>	$\epsilon_r = 40.0 \pm 5\%$	$\sigma = 1.40 \pm 5\% \text{ mho/m}$
<b>Head</b>	<b>1900 MHz</b>	$\epsilon_r = 40.0 \pm 5\%$	$\sigma = 1.40 \pm 5\% \text{ mho/m}$
ConvF X	<b>5.2</b> $\pm 9.5\%$ (k=2)	Boundary effect:	
ConvF Y	<b>5.2</b> $\pm 9.5\%$ (k=2)	Alpha	<b>0.50</b>
ConvF Z	<b>5.2</b> $\pm 9.5\%$ (k=2)	Depth	<b>2.73</b>

### Boundary Effect

<b>Head</b>	<b>900 MHz</b>	<b>Typical SAR gradient: 5 % per mm</b>	
Probe Tip to Boundary		<b>1 mm</b>	<b>2 mm</b>
SAR <sub>be</sub> [%]	Without Correction Algorithm	10.2	5.9
SAR <sub>be</sub> [%]	With Correction Algorithm	0.4	0.6
<b>Head</b>	<b>1800 MHz</b>	<b>Typical SAR gradient: 10 % per mm</b>	
Probe Tip to Boundary		<b>1 mm</b>	<b>2 mm</b>
SAR <sub>be</sub> [%]	Without Correction Algorithm	14.6	9.8
SAR <sub>be</sub> [%]	With Correction Algorithm	0.2	0.0

### Sensor Offset

Probe Tip to Sensor Center	<b>2.7</b>	mm
Optical Surface Detection	<b>1.4 <math>\pm</math> 0.2</b>	mm

### Receiving Pattern ( $\phi$ ), $\theta = 0^\circ$

**f = 30 MHz, TEM cell ifi110**

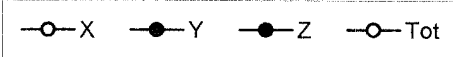
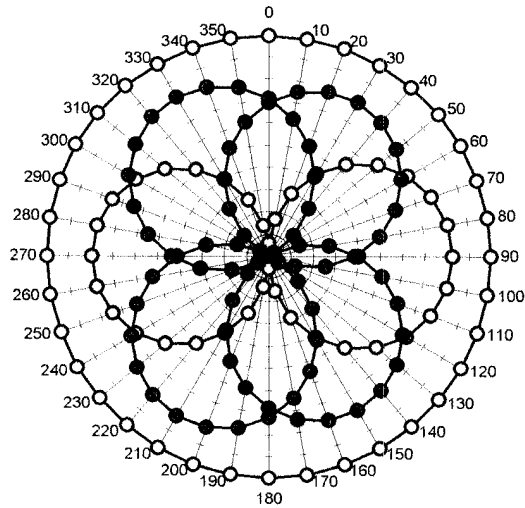

**f = 100 MHz, TEM cell ifi110**

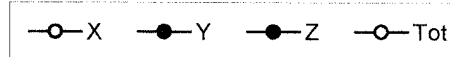
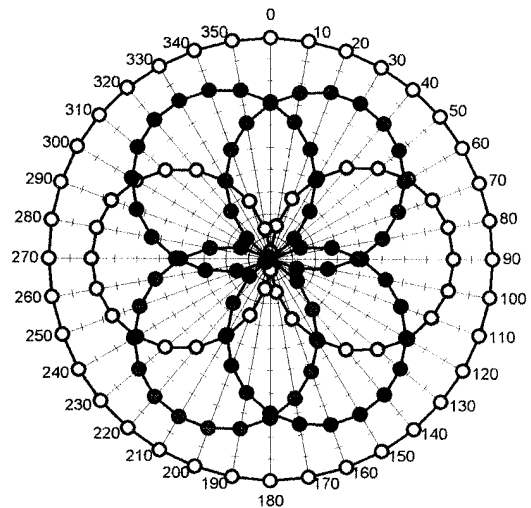

**f = 300 MHz, TEM cell ifi110**

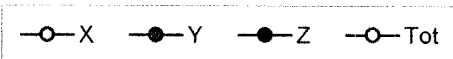
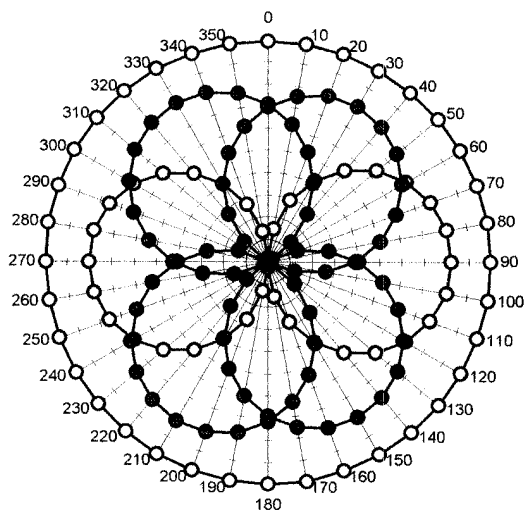

**f = 900 MHz, TEM cell ifi110**

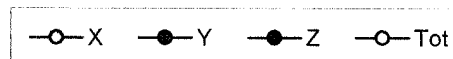
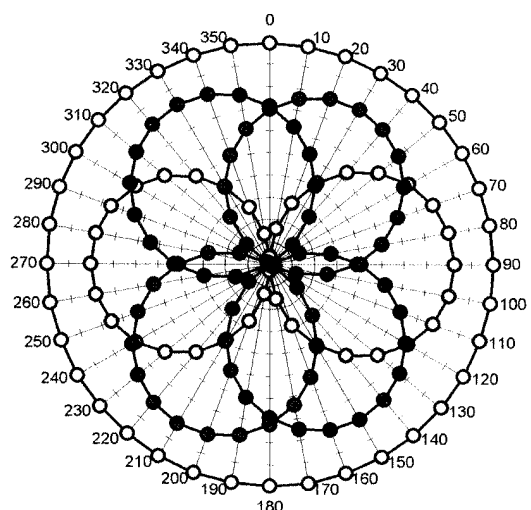

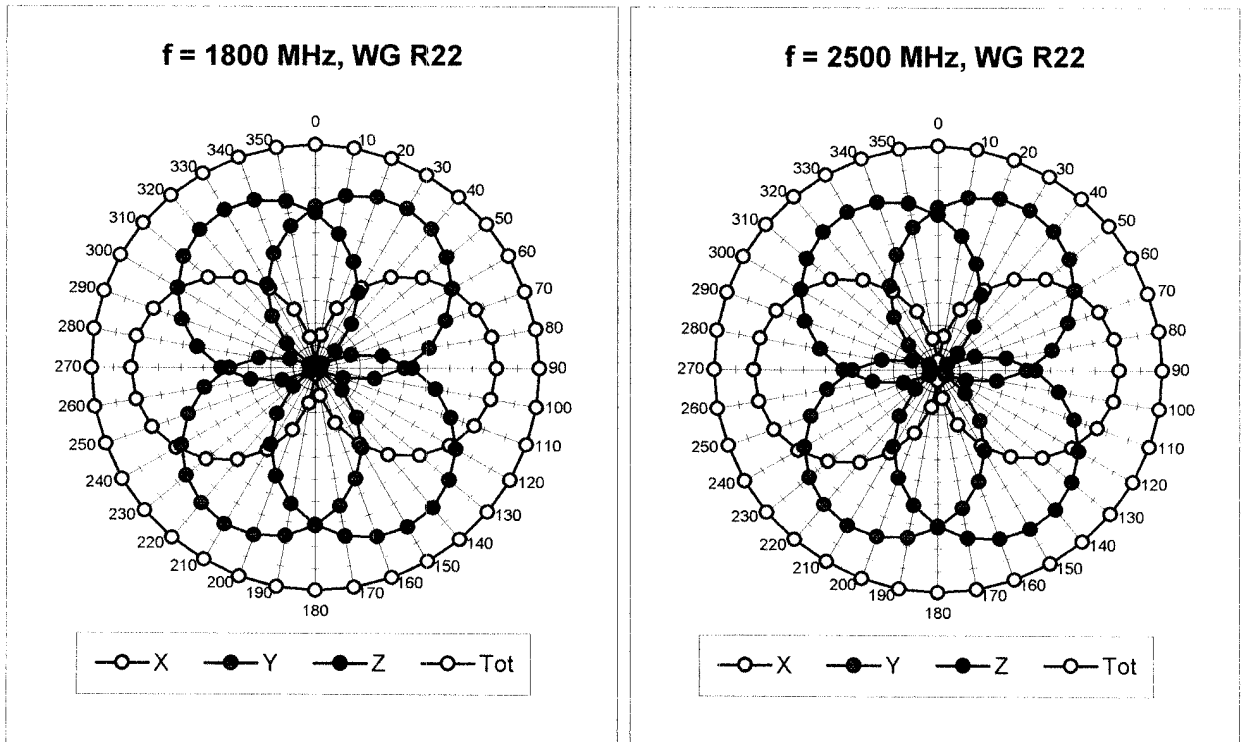

### Isotropy Error ( $\phi$ ), $\theta = 0^\circ$

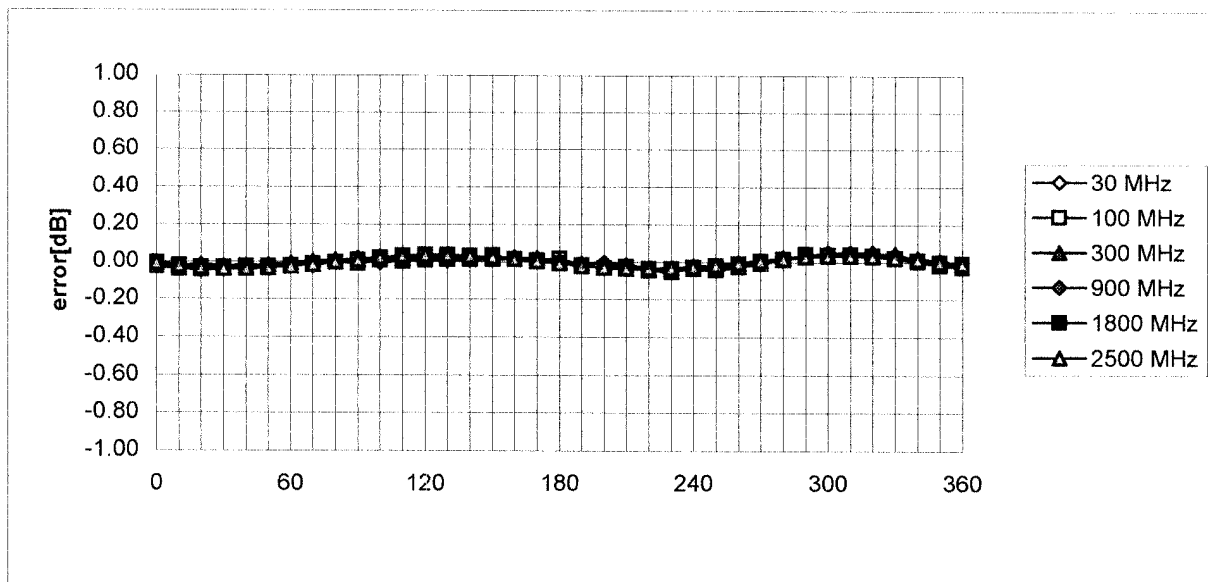

# Frequency Response of E-Field

( TEM-Cell:ifi110, Waveguide R22)

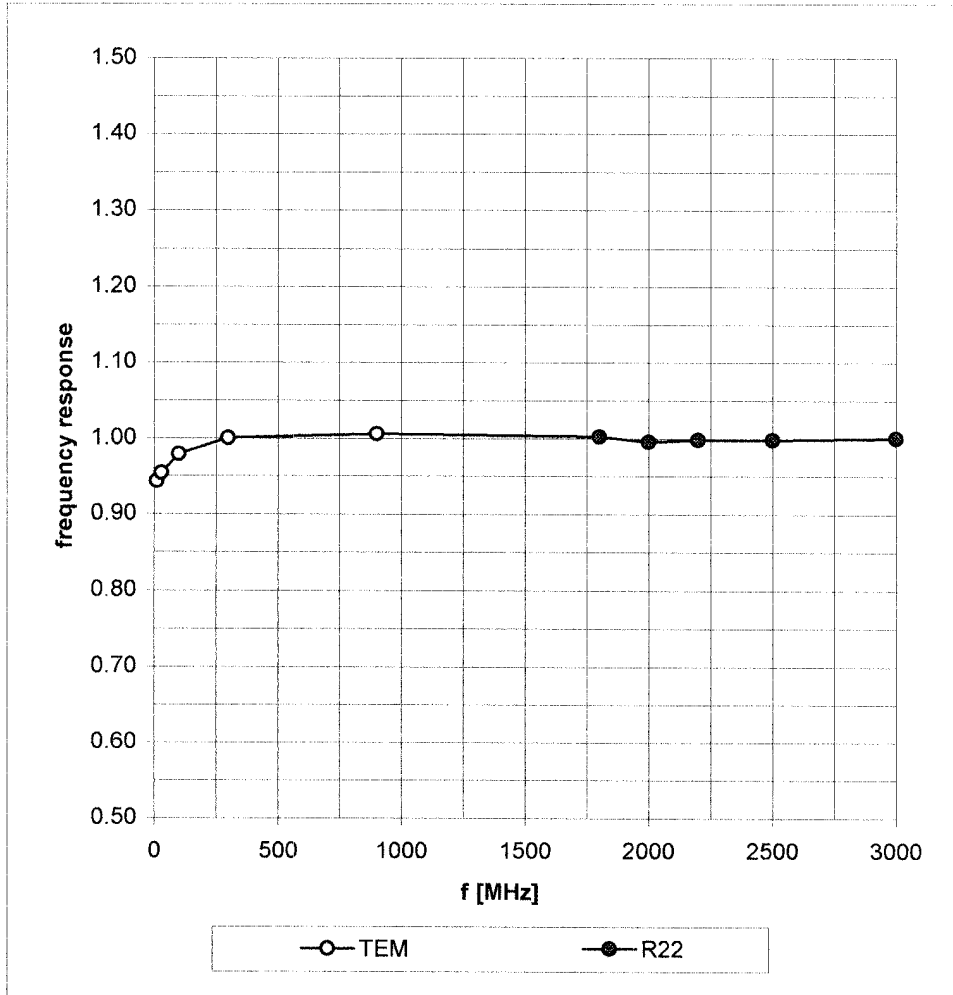

### Dynamic Range f(SAR<sub>brain</sub>) ( Waveguide R22 )

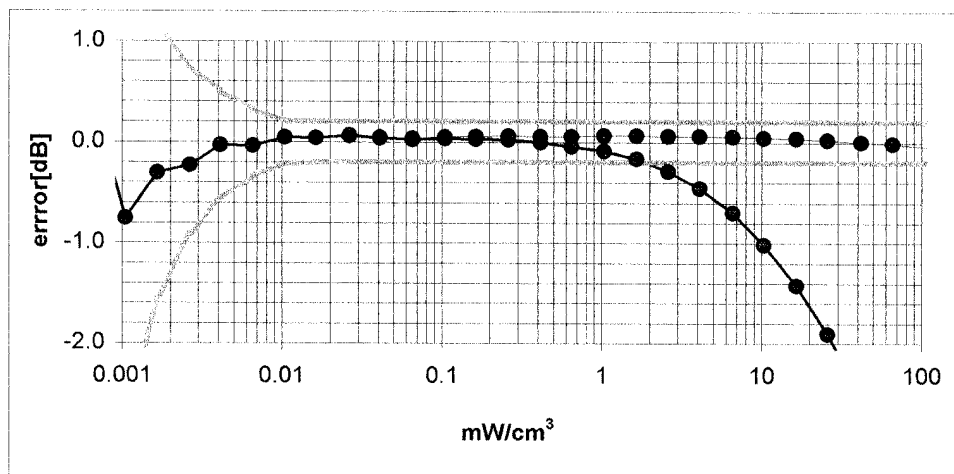
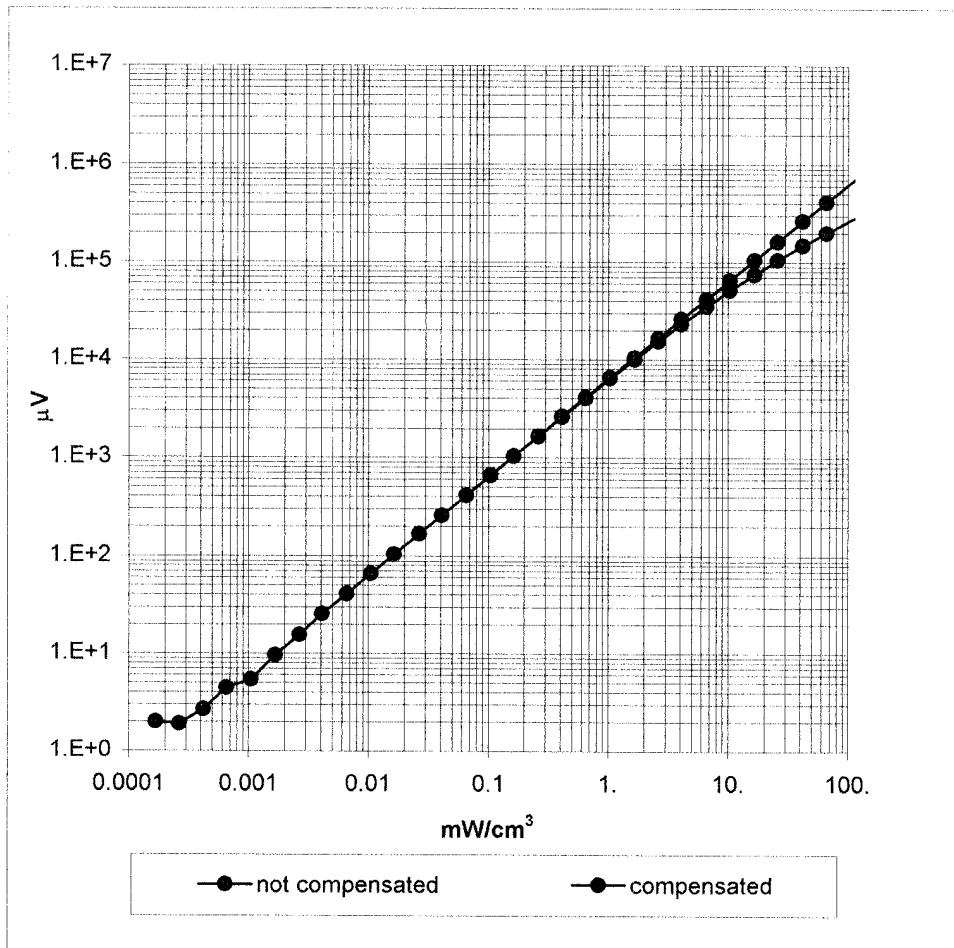

## Conversion Factor Assessment

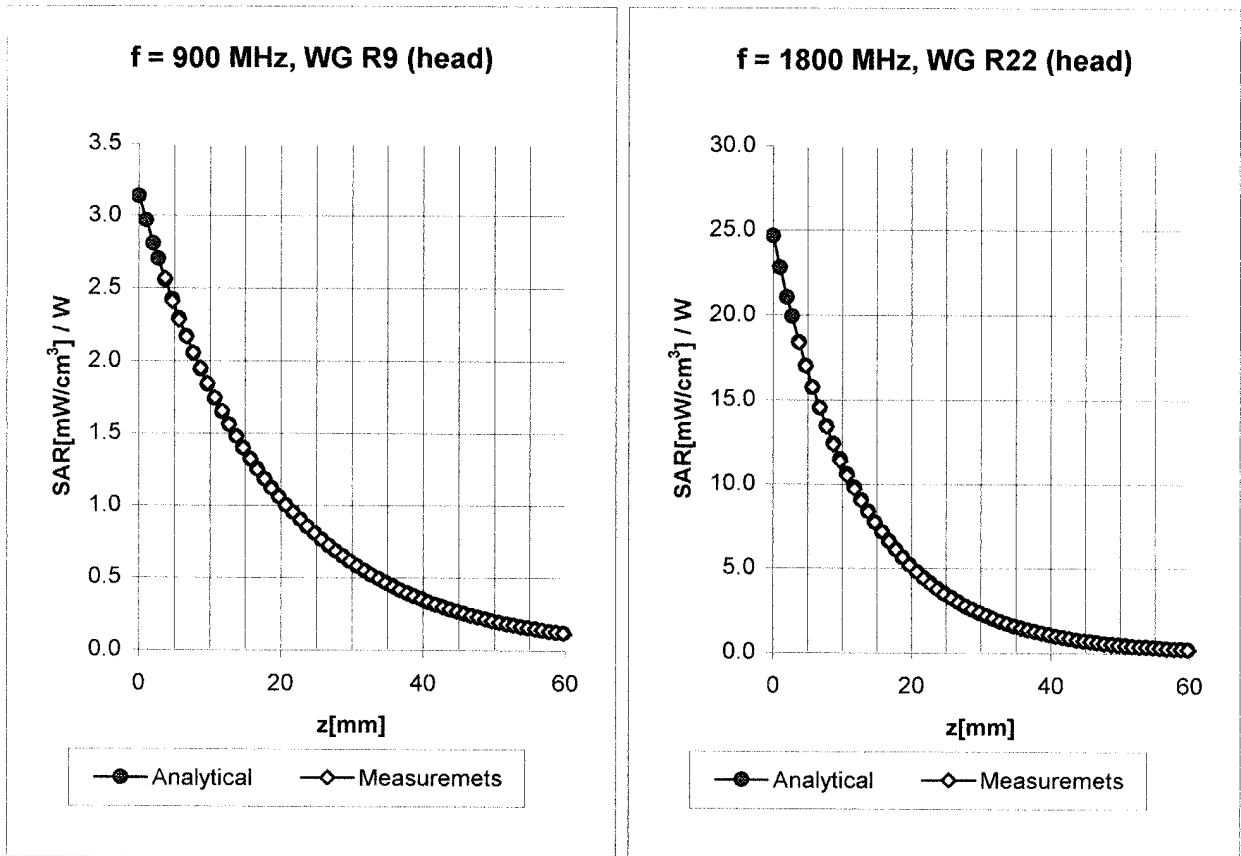

<b>Head</b>	<b>900 MHz</b>	$\epsilon_r = 41.5 \pm 5\%$	$\sigma = 0.97 \pm 5\% \text{ mho/m}$
<b>Head</b>	<b>835 MHz</b>	$\epsilon_r = 41.5 \pm 5\%$	$\sigma = 0.90 \pm 5\% \text{ mho/m}$
	ConvF X	<b>6.6</b> $\pm 9.5\%$ (k=2)	Boundary effect:
	ConvF Y	<b>6.6</b> $\pm 9.5\%$ (k=2)	Alpha <b>0.37</b>
	ConvF Z	<b>6.6</b> $\pm 9.5\%$ (k=2)	Depth <b>2.61</b>
<b>Head</b>	<b>1800 MHz</b>	$\epsilon_r = 40.0 \pm 5\%$	$\sigma = 1.40 \pm 5\% \text{ mho/m}$
<b>Head</b>	<b>1900 MHz</b>	$\epsilon_r = 40.0 \pm 5\%$	$\sigma = 1.40 \pm 5\% \text{ mho/m}$
	ConvF X	<b>5.2</b> $\pm 9.5\%$ (k=2)	Boundary effect:
	ConvF Y	<b>5.2</b> $\pm 9.5\%$ (k=2)	Alpha <b>0.50</b>
	ConvF Z	<b>5.2</b> $\pm 9.5\%$ (k=2)	Depth <b>2.73</b>



## Conversion Factor Assessment

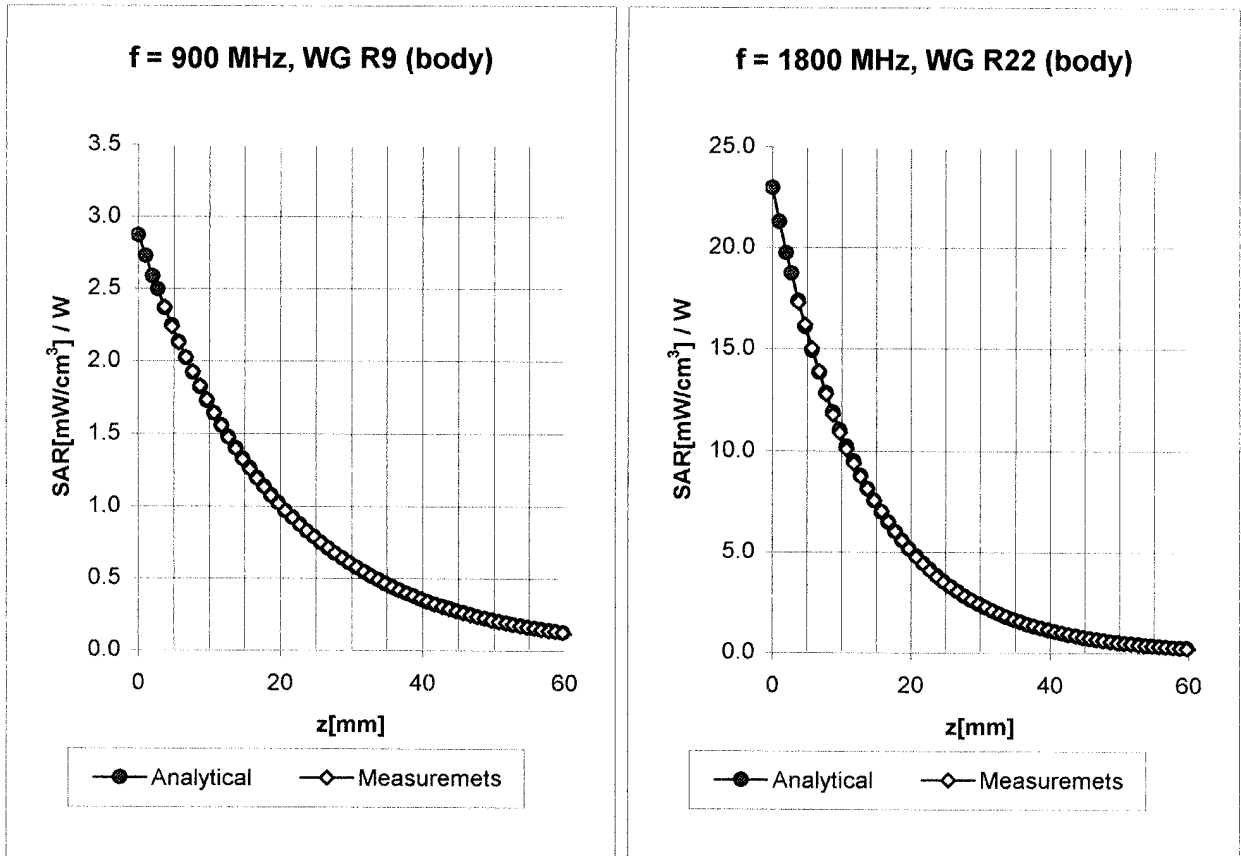

<b>Body</b>	<b>900 MHz</b>	$\epsilon_r = 55.0 \pm 5\%$	$\sigma = 1.05 \pm 5\% \text{ mho/m}$
<b>Body</b>	<b>835 MHz</b>	$\epsilon_r = 55.2 \pm 5\%$	$\sigma = 0.97 \pm 5\% \text{ mho/m}$
	ConvF X	<b>6.4</b> $\pm 9.5\%$ (k=2)	Boundary effect:
	ConvF Y	<b>6.4</b> $\pm 9.5\%$ (k=2)	Alpha <b>0.45</b>
	ConvF Z	<b>6.4</b> $\pm 9.5\%$ (k=2)	Depth <b>2.35</b>
<b>Body</b>	<b>1800 MHz</b>	$\epsilon_r = 53.3 \pm 5\%$	$\sigma = 1.52 \pm 5\% \text{ mho/m}$
<b>Body</b>	<b>1900 MHz</b>	$\epsilon_r = 53.3 \pm 5\%$	$\sigma = 1.52 \pm 5\% \text{ mho/m}$
	ConvF X	<b>4.9</b> $\pm 9.5\%$ (k=2)	Boundary effect:
	ConvF Y	<b>4.9</b> $\pm 9.5\%$ (k=2)	Alpha <b>0.60</b>
	ConvF Z	<b>4.9</b> $\pm 9.5\%$ (k=2)	Depth <b>2.59</b>

## Conversion Factor Assessment

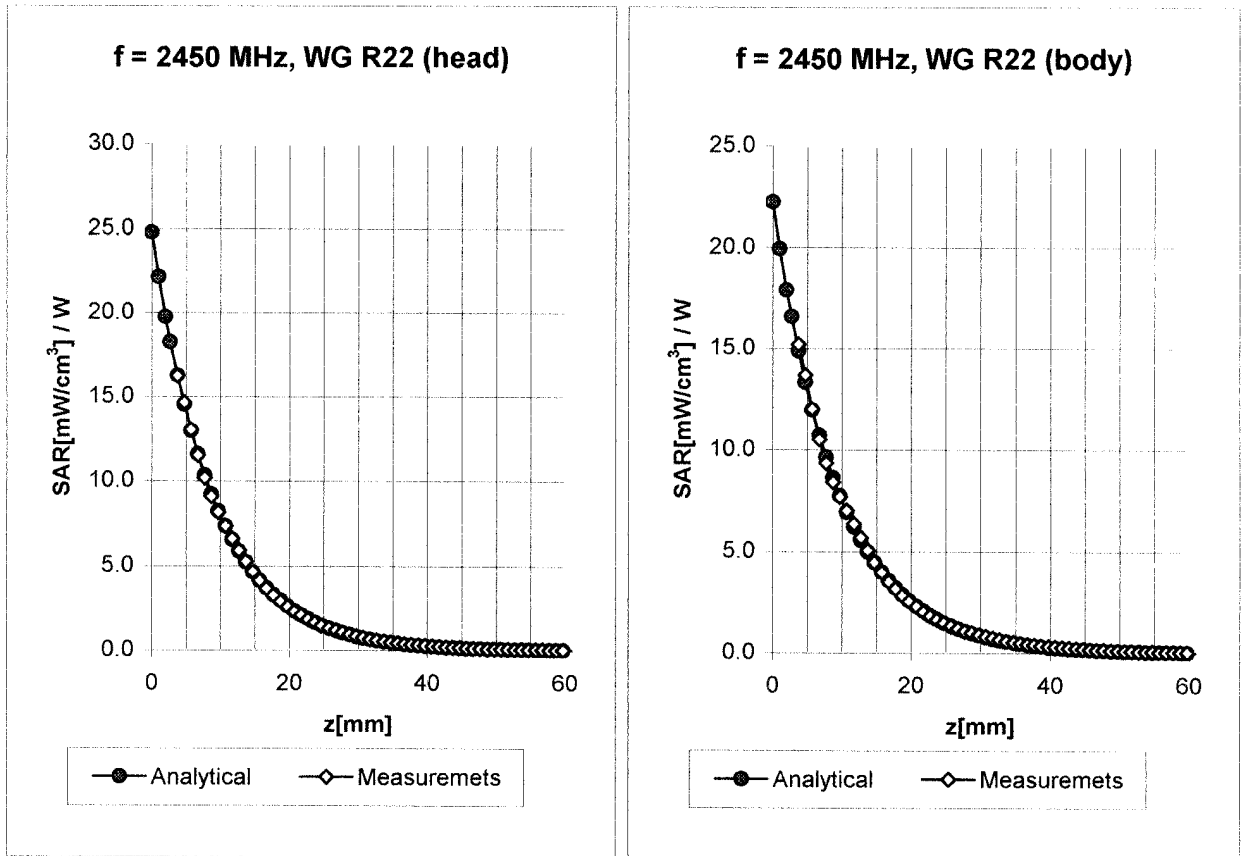

<b>Head</b>	<b>2450</b>	<b>MHz</b>	$\epsilon_r = 39.2 \pm 5\%$	$\sigma = 1.80 \pm 5\%$ mho/m
	ConvF X		<b>5.0</b> $\pm 8.9\%$ (k=2)	Boundary effect:
	ConvF Y		<b>5.0</b> $\pm 8.9\%$ (k=2)	Alpha <b>1.04</b>
	ConvF Z		<b>5.0</b> $\pm 8.9\%$ (k=2)	Depth <b>1.85</b>
<b>Body</b>	<b>2450</b>	<b>MHz</b>	$\epsilon_r = 52.7 \pm 5\%$	$\sigma = 1.95 \pm 5\%$ mho/m
	ConvF X		<b>4.6</b> $\pm 8.9\%$ (k=2)	Boundary effect:
	ConvF Y		<b>4.6</b> $\pm 8.9\%$ (k=2)	Alpha <b>1.20</b>
	ConvF Z		<b>4.6</b> $\pm 8.9\%$ (k=2)	Depth <b>1.60</b>

# Deviation from Isotropy in HSL

Error ( $\theta, \phi$ ),  $f = 900$  MHz

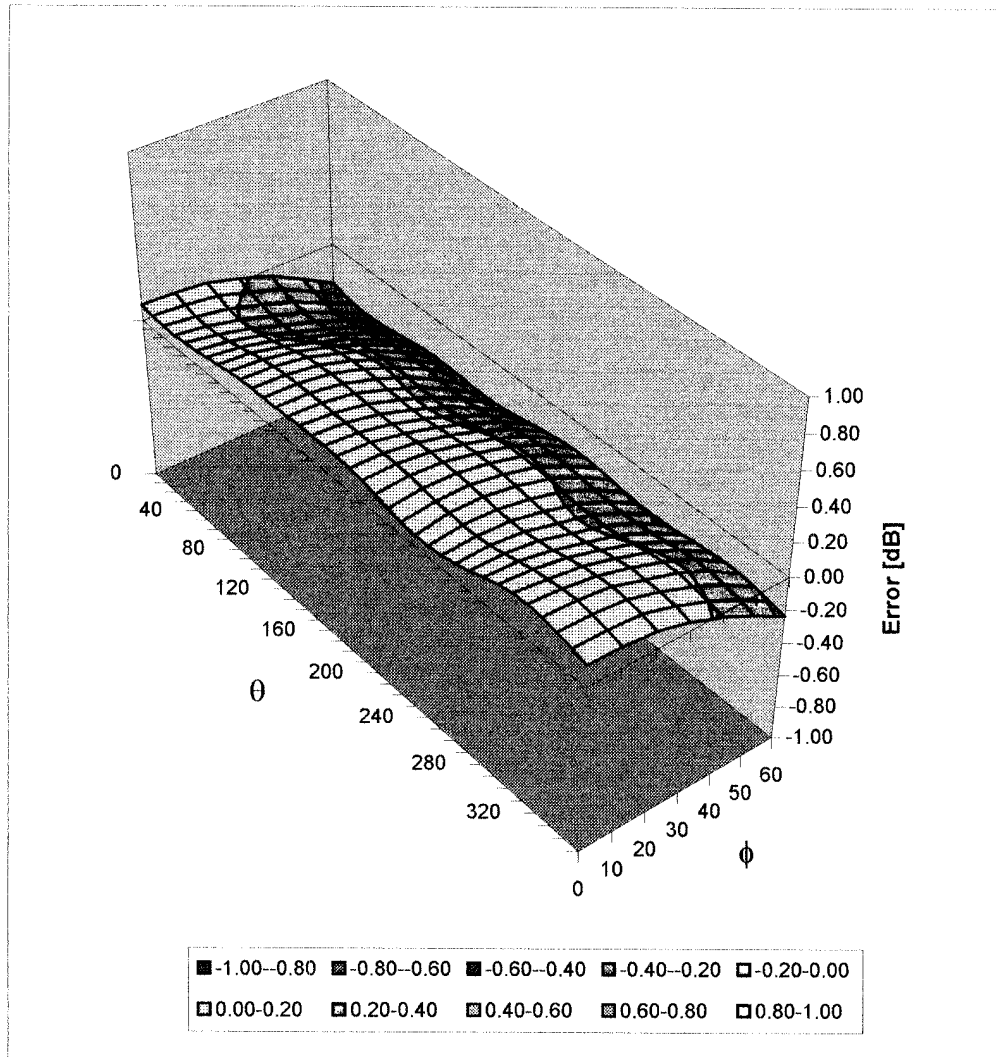

## Additional Conversion Factors for Dosimetric E-Field Probe

Type:	<b>ET3DV6</b>
Serial Number:	<b>1387</b>
Place of Assessment:	<b>Zurich</b>
Date of Assessment:	<b>February 28, 2003</b>
Probe Calibration Date:	<b>February 26, 2003</b>

Schmid & Partner Engineering AG hereby certifies that conversion factor(s) of this probe have been evaluated on the date indicated above. The assessment was performed using the FDTD numerical code SEMCAD of Schmid & Partner Engineering AG. Since the evaluation is coupled with measured conversion factors, it has to be recalculated yearly, i.e., following the re-calibration schedule of the probe. The uncertainty of the numerical assessment is based on the extrapolation from measured value at 900 MHz or at 1800 MHz.

Assessed by:

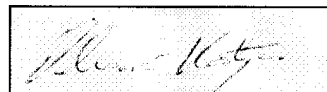

# Dosimetric E-Field Probe ET3DV6 SN:1387

Conversion factor ( $\pm$  standard deviation)

150 MHz	ConvF	9.1 $\pm$ 8%	$\epsilon_r = 52.3$ $\sigma = 0.76$ mho/m (head tissue)
300 MHz	ConvF	7.9 $\pm$ 8%	$\epsilon_r = 45.3$ $\sigma = 0.87$ mho/m (head tissue)
450 MHz	ConvF	7.5 $\pm$ 8%	$\epsilon_r = 43.5$ $\sigma = 0.87$ mho/m (head tissue)
150 MHz	ConvF	8.8 $\pm$ 8%	$\epsilon_r = 61.9$ $\sigma = 0.80$ mho/m (body tissue)
300 MHz	ConvF	8.0 $\pm$ 8%	$\epsilon_r = 58.2$ $\sigma = 0.92$ mho/m (body tissue)
450 MHz	ConvF	7.7 $\pm$ 8%	$\epsilon_r = 56.7$ $\sigma = 0.94$ mho/m (body tissue)

Test Report S/N:	102803-440K66
Test Date(s):	December 08, 2003
Test Type:	FCC/IC SAR Evaluation

## APPENDIX E - MEASURED FLUID DIELECTRIC PARAMETERS

# 450 MHz System Performance Check & DUT Evaluation (Face)

## Measured Fluid Dielectric Parameters (Brain)

December 08, 2003

Frequency	$\epsilon'$	$\epsilon''$
350.000000 MHz	44.4609	38.1521
360.000000 MHz	44.2108	37.4490
370.000000 MHz	43.9666	36.7940
380.000000 MHz	43.6638	36.1920
390.000000 MHz	43.3366	35.6248
400.000000 MHz	43.0331	35.1253
410.000000 MHz	42.7237	34.6316
420.000000 MHz	42.4056	34.2631
430.000000 MHz	42.0892	33.7381
440.000000 MHz	41.8051	33.4141
450.000000 MHz	41.4924	33.0634
460.000000 MHz	41.3227	32.7263
470.000000 MHz	41.0970	32.3853
480.000000 MHz	40.9528	32.0026
490.000000 MHz	40.7940	31.6031
500.000000 MHz	40.6647	31.2484
510.000000 MHz	40.5206	30.8765
520.000000 MHz	40.4177	30.5280
530.000000 MHz	40.2759	30.2147
540.000000 MHz	40.1403	29.8172
550.000000 MHz	39.9763	29.5473

# 450 MHz DUT Evaluation (Body)

## Measured Fluid Dielectric Parameters (Muscle)

December 08, 2003

Frequency	$\epsilon'$	$\epsilon''$
350.000000 MHz	59.5694	44.4255
360.000000 MHz	59.3891	43.5664
370.000000 MHz	59.2070	42.7278
380.000000 MHz	59.0403	42.0060
390.000000 MHz	58.7989	41.2008
400.000000 MHz	58.5950	40.5552
410.000000 MHz	58.3525	39.8841
420.000000 MHz	58.1000	39.3273
430.000000 MHz	57.8644	38.7024
440.000000 MHz	57.6987	38.2868
450.000000 MHz	57.4683	37.8442
460.000000 MHz	57.4026	37.3765
470.000000 MHz	57.2300	36.9579
480.000000 MHz	57.1053	36.5181
490.000000 MHz	57.0357	36.0643
500.000000 MHz	56.9420	35.6489
510.000000 MHz	56.8762	35.1896
520.000000 MHz	56.8226	34.7760
530.000000 MHz	56.6754	34.3810
540.000000 MHz	56.5619	33.8686
550.000000 MHz	56.4322	33.5777



Test Report S/N:	102803-440K66
Test Date(s):	December 08, 2003
Test Type:	FCC/IC SAR Evaluation

## APPENDIX F - SAR TEST SETUP & DUT PHOTOGRAPHS

**FACE-HELD SAR TEST SETUP PHOTOGRAPHS**  
2.5 cm Separation Distance from Front of Radio to Planar Phantom

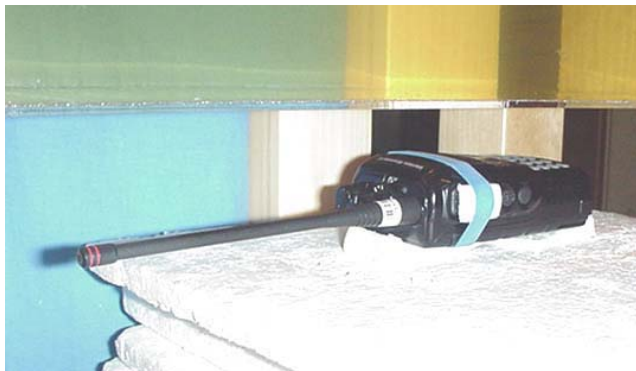
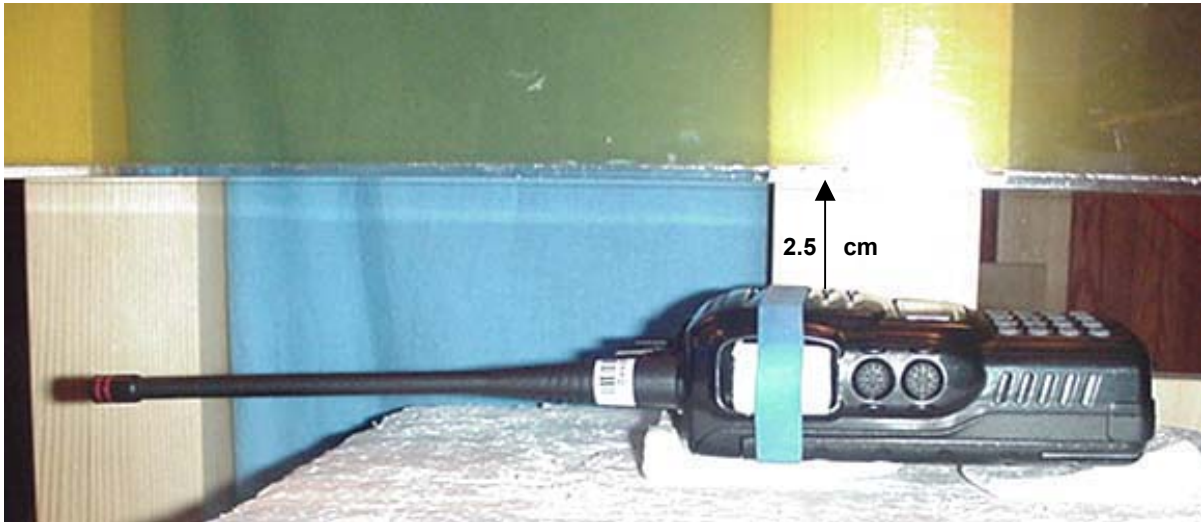

**BODY-WORN SAR TEST SETUP PHOTOGRAPHS**  
1.3 cm Belt-Clip Separation Distance to Planar Phantom  
with Speaker-Microphone Accessory

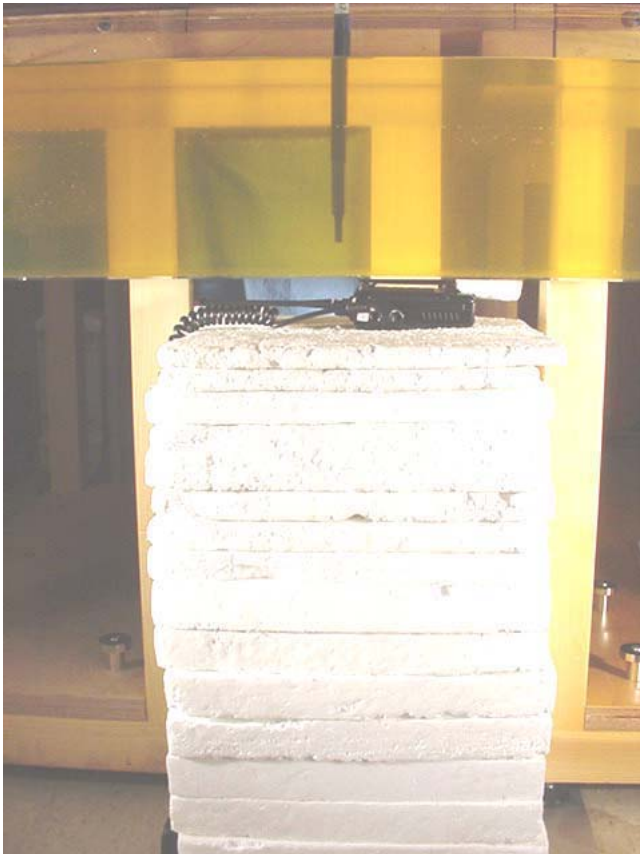
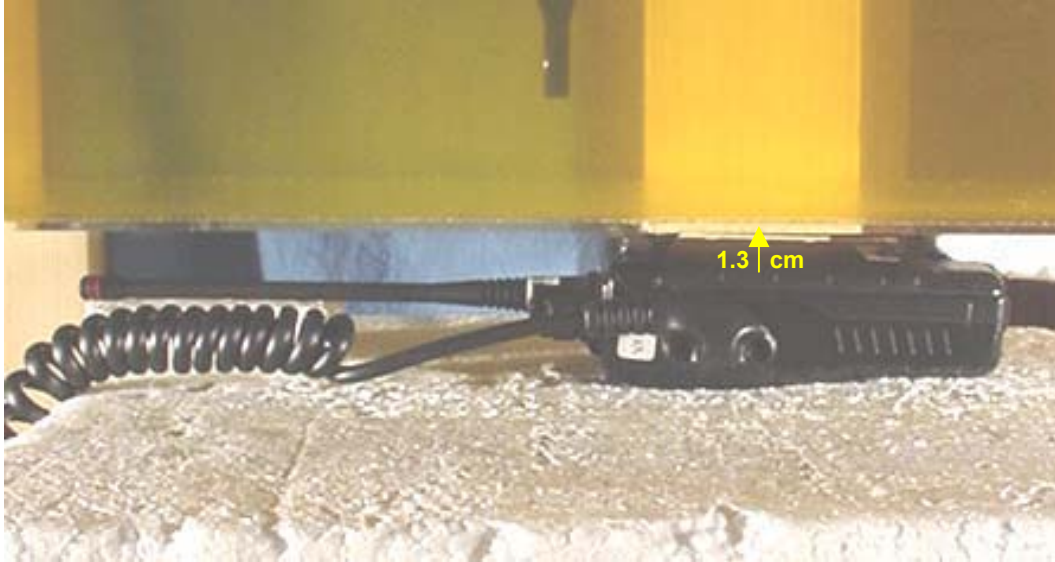

**DUT PHOTOGRAPHS**



**DUT PHOTOGRAPHS**



**with Speaker-Microphone**



**with Belt-Clip**



**with Belt-Clip**

**DUT PHOTOGRAPHS**



**Battery Compartment**



**NiCd Battery Pack**



**NiCd Battery Pack**

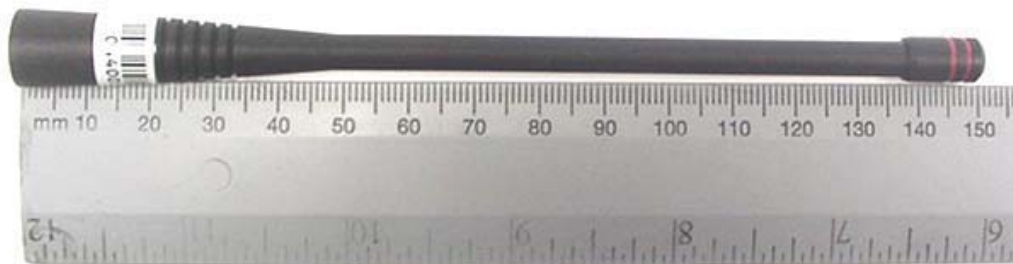

**Whip Antenna**

**DUT PHOTOGRAPHS**



**Speaker-Microphone**



**Speaker-Microphone**



**Speaker-Microphone**



**Speaker-Microphone**