

# TIMCO ENGINEERING INC.

849 NW State Road 45  
Newberry, Florida 32669  
<http://www.timcoengr.com>  
888.472.2424 F 352.472.2030 email: [tei@timcoengr.com](mailto:tei@timcoengr.com)



## Test Report

Product Name: LAND MOBILE RADIO

FCC ID: K6610344140

Applicant:

**VERTEX STANDARD CO., LTD.  
4-8-8 NAKAMEGURO, MEGURO-KU  
TOKYO, JAPAN 153-8644**

**Date Receipt: AUGUST 5, 2004**

**Date Tested: AUGUST 17, 2004**

**APPLICANT: VERTEX STANDARD CO., LTD.**

**FCC ID: K6610344140**

**REPORT #: V\VERTEX USA\_\1249AUT4\1249AUT4TestReport.doc**

**COVER PAGE**

# TIMCO ENGINEERING INC.

849 NW State Road 45  
Newberry, Florida 32669  
<http://www.timcoengr.com>  
888.472.2424 F 352.472.2030 email: [tei@timcoengr.com](mailto:tei@timcoengr.com)

**APPLICANT:** VERTEX STANDARD CO., LTD.

**FCC ID:** K6610344140

## TABLE OF CONTENTS LIST

### TEST REPORT:

PAGE 1.....	GENERAL INFORMATION & TECHNICAL DESCRIPTION
PAGE 2.....	TECHNICAL DESCRIPTION CONTINUED RF POWER OUTPUT
PAGE 3.....	MODULATION CHARACTERISTICS AUDIO FREQUENCY RESPONSE
PAGE 4.....	MODULATION LIMITING PLOT
PAGE 5.....	AUDIO LOW PASS FILTER
PAGE 6.....	OCCUPIED BANDWIDTH
PAGE 7-8.....	OCCUPIED BANDWIDTH PLOT
PAGE 9.....	SPURIOUS EMISSIONS AT ANTENNA TERMINALS
PAGE 10.....	METHOD OF MEASURING SPURIOUS EMISSIONS AT ANTENNA TERMINALS
PAGE 11-13.....	FIELD STRENGTH OF SPURIOUS EMISSIONS
PAGE 14.....	METHOD OF MEASURING RADIATED SPURIOUS EMISSIONS
PAGE 15.....	FREQUENCY STABILITY
PAGE 16-17.....	TRANSIENT FREQUENCY STABILITY
PAGE 18-21.....	TRANSIENT FREQUENCY RESPONSE PLOTS
PAGE 22-25.....	EQUIPMENT LIST

### EXHIBITS CONTAINING:

ATTESTATION LETTER  
CONFIDENTIALITY LETTER  
BLOCK DIAGRAM  
SCHEMATIC  
PARTS LIST  
USERS MANUAL  
LABEL SAMPLE  
LABEL LOCATION  
EXTERNAL PHOTOGRAPHS  
INTERNAL PHOTOGRAPHS  
TUNING PROCEDURE  
OPERATIONAL DESCRIPTION  
TEST SET UP PHOTOGRAPH

**APPLICANT:** VERTEX STANDARD CO., LTD.

**FCC ID:** K6610344140

**REPORT #:** V\VERTEX USA\_\1249AUT4\1249AUT4TestReport.doc

**TABLE OF CONTENTS**

# TIMCO ENGINEERING INC.

849 NW State Road 45  
Newberry, Florida 32669  
<http://www.timcoengr.com>  
888.472.2424 F 352.472.2030 email: [tei@timcoengr.com](mailto:tei@timcoengr.com)

## GENERAL INFORMATION REQUIRED FOR TYPE ACCEPTANCE

2.1033(c)(1)(2) VERTEX STANDARD CO., LTD. will manufacture the  
FCCID: K6610344140 VHF TRANSCEIVER in quantity,  
for use under FCC RULES PART 90.

VERTEX STANDARD CO., LTD.  
4-8-8 NAKAMEGURO, MEGURO-KU  
TOKYO, JAPAN 153-8644

## 2.1033(c) TECHNICAL DESCRIPTION

2.1033(c)(3) Instruction book. A draft copy of the instruction  
manual is included in the exhibits.

2.1033(c)(4) Type of Emission: 11K0F3E  
90.209  
 $B_n = 2M + 2DK$   
 $M = 3000$   
 $D = 2400$   
 $B_n = 2(3000) + 2(2400) = 10.8k$

90.217 (b) Authorized Bandwidth 12.5 kHz

2.1033(c)(4) Type of Emission: 16K0F3E  
90.209  
 $B_n = 2M + 2DK$   
 $M = 3000$   
 $D = 4900$   
 $B_n = 2(3000) + 2(4900) = 15.8k$

90.217 (b) Authorized Bandwidth 25 kHz

2.1033(c)(5) Frequency Range: 400 - 430 MHz  
90.209

2.1033(c)(6)(7) Power Output shall not exceed 59 Watts into a 50 ohm  
90.205 resistive load. There are no user power controls.

2.1033(c)(8) DC Voltages and Current into Final Amplifier:  
POWER INPUT:

### FINAL AMPLIFIER ONLY

HIGH: (13.8V)(9.14A) = 126.132 Watts  
LOW: (13.8V)(4.33A) = 59.754 Watts

2.1033(c)(9) Tune-up procedure. The tune-up procedure is included  
in the exhibits.

**APPLICANT:** VERTEX STANDARD CO., LTD.

**FCC ID:** K6610344140

**REPORT #:** V\VERTEX USA\_\1249AUT4\1249AUT4TestReport.doc

# TIMCO ENGINEERING INC.

849 NW State Road 45  
Newberry, Florida 32669  
<http://www.timcoengr.com>  
888.472.2424 F 352.472.2030 email: [tei@timcoengr.com](mailto:tei@timcoengr.com)

- 2.1033(c)(10) Complete Circuit Diagrams: The circuit diagram and block diagram are included in the exhibits.
- (11) Function of each electron tube or semiconductor device or other active circuit device are in the exhibits.
- (12) Description of all circuitry and devices provided for determining and stabilizing frequency is included in the circuit description in the instruction manual.
- 2.1033(c)(13) A photograph or drawing of the equipment identification label is shown in the exhibits.
- 2.1033(c)(14) Photographs of the equipment of sufficient clarity to reveal equipment construction and layout and label location are shown in the exhibits.
- 2.1033(c)(15) For equipment employing digital modulation, a detail description of the modulation technique. This UUT uses FSK to modulate the transmitter.
- 2.1033(c)(16) The data required for 2.1046 through 2.1057 is submitted below.
- 2.1046(a) **RF POWER OUTPUT**  
RF power is measured by connecting a 50-ohm, resistive wattmeter to the RF output connector. With a nominal battery voltage of 13.8 VDC, and the transmitter properly adjusted the RF output measures:
- OUTPUT POWER:       HIGH - 45 Watts  
                          LOW - 10 Watts

**APPLICANT:** VERTEX STANDARD CO., LTD.

**FCC ID:** K6610344140

**REPORT #:** V\VERTEX USA\_\1249AUT4\1249AUT4TestReport.doc

# TIMCO ENGINEERING INC.

849 NW State Road 45  
Newberry, Florida 32669  
<http://www.timcoengr.com>  
888.472.2424 F 352.472.2030 email: [tei@timcoengr.com](mailto:tei@timcoengr.com)

## 2.1047(a)(b) Modulation characteristics:

### AUDIO FREQUENCY RESPONSE

The audio frequency response was measured in accordance with TIA/EIA Specification 603. The audio frequency response curve is shown below. The audio signal was fed into a dummy microphone circuit and into the microphone connector. The input required to produce 30 percent modulation level was measured.

## Audio Frequency Response

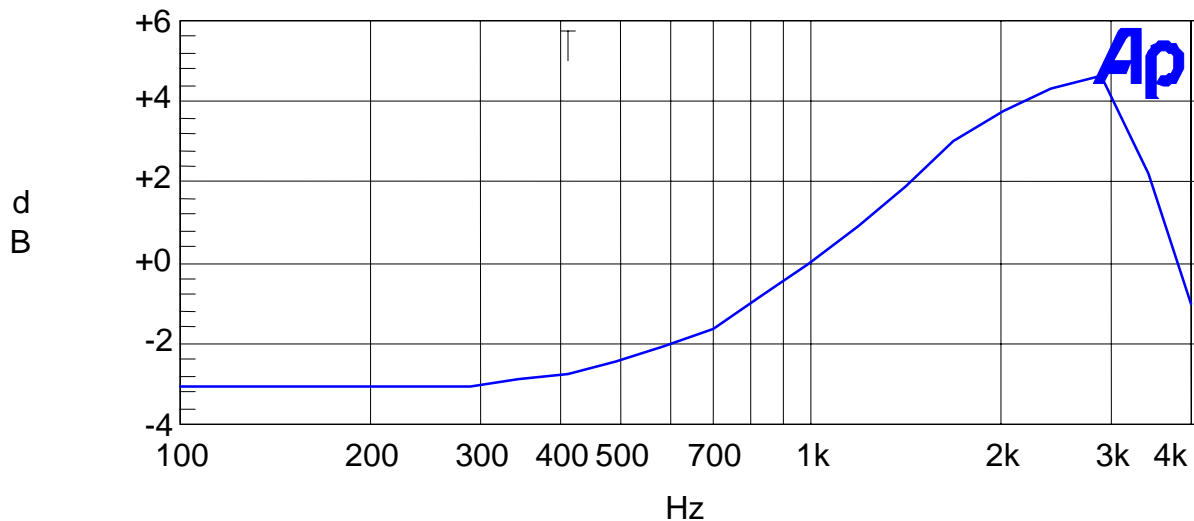

APPLICANT: VERTEX STANDARD CO., LTD.

FCC ID: K6610344140

REPORT #: V\VERTEX USA\_\1249AUT4\1249AUT4TestReport.doc

# TIMCO ENGINEERING INC.

849 NW State Road 45  
Newberry, Florida 32669  
<http://www.timcoengr.com>  
888.472.2424 F 352.472.2030 email: [tei@timcoengr.com](mailto:tei@timcoengr.com)

2.1047(b)

## Audio input versus modulation

The audio input level needed for a particular percentage of modulation was measured in accordance with TIA/EIA Specification 603. The audio input curves versus modulation are shown below. Curves are provided for audio input frequencies of 300, 1000, and 2500 Hz.

### Modulation Limiting Plots:

2.5 KHz (Green), 1.0 KHz (Blue), and 300 Hz (Yellow)

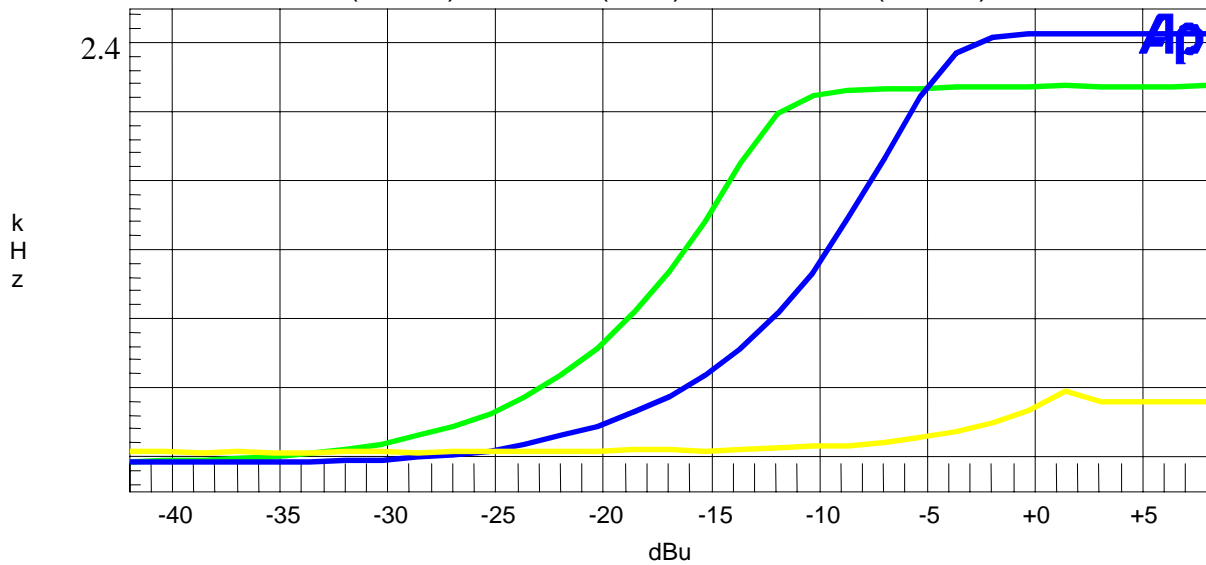

### Modulation Limiting Plots:

2.5 KHz (Green), 1.0 KHz (Blue), and 300 Hz (Yellow)

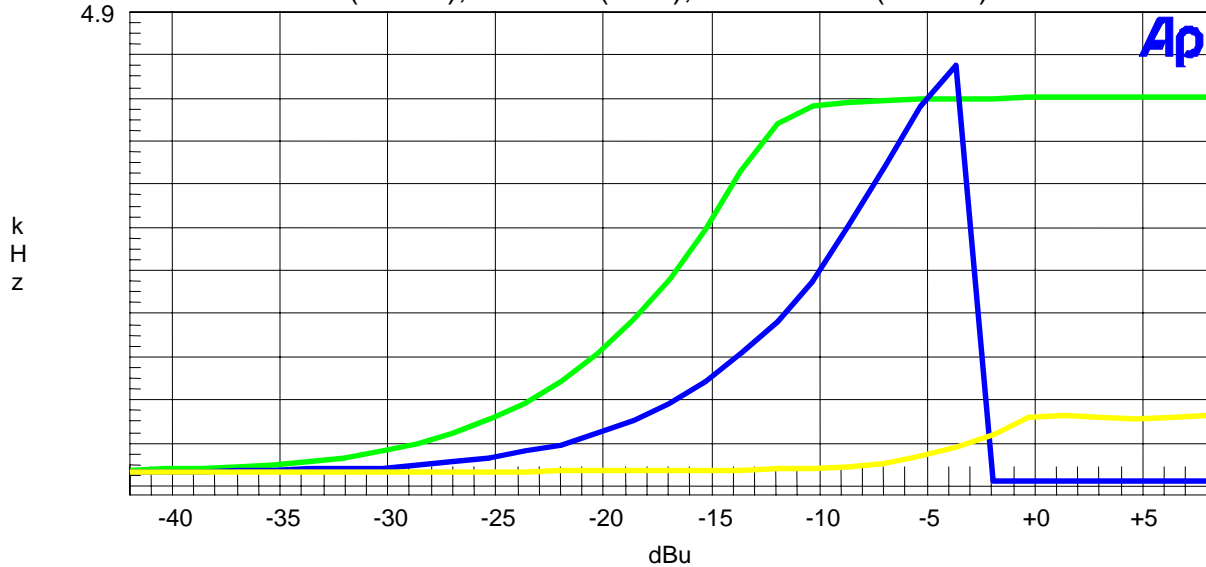

APPLICANT: VERTEX STANDARD CO., LTD.

FCC ID: K6610344140

REPORT #: V\VERTEX USA\_\1249AUT4\1249AUT4TestReport.doc

# TIMCO ENGINEERING INC.

849 NW State Road 45  
Newberry, Florida 32669  
<http://www.timcoengr.com>  
888.472.2424 F 352.472.2030 email: [tei@timcoengr.com](mailto:tei@timcoengr.com)

## Post Limiter Filter

The filter must be between the modulation limiter and the modulated stage. At any frequency between 3 & 20 kHz the filter must have an attenuation of  $60\log(f/3)$  greater than the attenuation at 1kHz. See the plot below.

## Audio Low Pass Filter

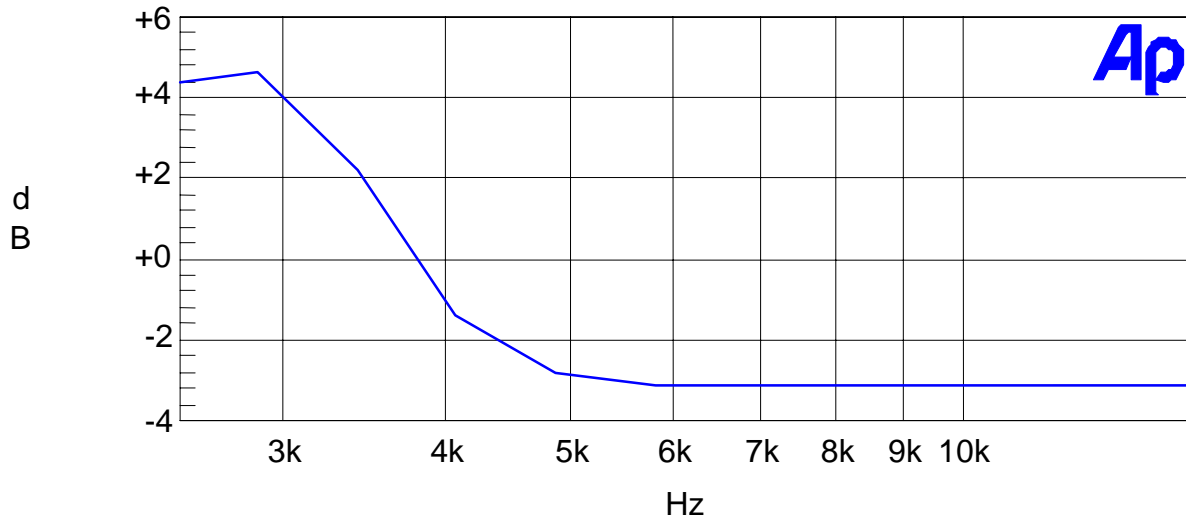

**APPLICANT:** VERTEX STANDARD CO., LTD.

**FCC ID:** K6610344140

**REPORT #:** V\VERTEX USA\_\1249AUT4\1249AUT4TestReport.doc

# TIMCO ENGINEERING INC.

849 NW State Road 45  
Newberry, Florida 32669  
<http://www.timcoengr.com>  
888.472.2424 F 352.472.2030 email: [tei@timcoengr.com](mailto:tei@timcoengr.com)

2.1049(c)  
90.210(b)

## EMISSION BANDWIDTH - 25 kHz:

Data in the plots shows that the sidebands from greater than 50% to 100% of the authorized bandwidth must be attenuated by at least 25 dB and from 100 to 250% the sidebands must be attenuated by at least 35 dB. Beyond 250% the sidebands must be attenuated by at least  $43 + \log_{10}(TP)$ . The transmitter was modulated with 2500 Hz, adjusted for 50% modulation plus 16 dB. The spectrum analyzer was set with the un-modulated carrier at the top of the screen. The test procedure diagram follows. See the occupied bandwidth plot on the next page.

2.1049(c)  
90.210(d)

## EMISSION BANDWIDTH - 12.5 kHz:

Any emission must be attenuated below the power (P) of the highest emission contained within the authorized bandwidth as follows:

- (1) On any frequency from the center of the authorized bandwidth  $f_0$  to 5.625 kHz removed from  $f_0$ : Zero dB.
- (2) On any frequency removed from the center of the authorized bandwidth by a displacement frequency ( $f_d$  in kHz) of more than 5.625 kHz but no more than 12.5 kHz: At least  $7.27(f_d - 2.88 \text{ kHz})$  dB.
- (3) On any frequency removed from the center of the authorized bandwidth by a displacement frequency ( $f_d$  in kHz) of more than 12.5 kHz: At least  $50 + 10 \log(P)$  dB or 70 dB, whichever is the lesser attenuation.

### **Radiotelephone transmitter with modulation limiter:**

#### Test procedure diagram

Occupied BW Test Equipment Setup

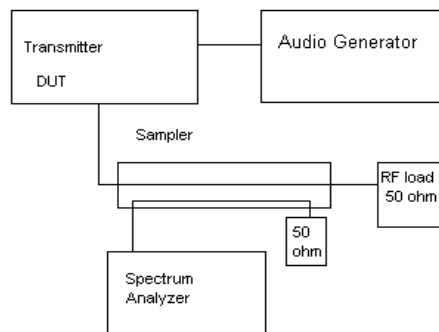

**APPLICANT:** VERTEX STANDARD CO., LTD.

**FCC ID:** K6610344140

**REPORT #:** V\VERTEX USA\_\1249AUT4\1249AUT4TestReport.doc



# TIMCO ENGINEERING INC.

849 NW State Road 45  
Newberry, Florida 32669  
<http://www.timcoengr.com>  
888.472.2424 F 352.472.2030 email: [tei@timcoengr.com](mailto:tei@timcoengr.com)

## OCCUPIED BANDWIDTH NARROW BAND

### NOTES:

VERTEX STANDARD USA, INC. - FCC ID: K6610344140  
OCCUPIED BANDWIDTH PLOT - NARROW BAND

### FCC 90.210 Mask D

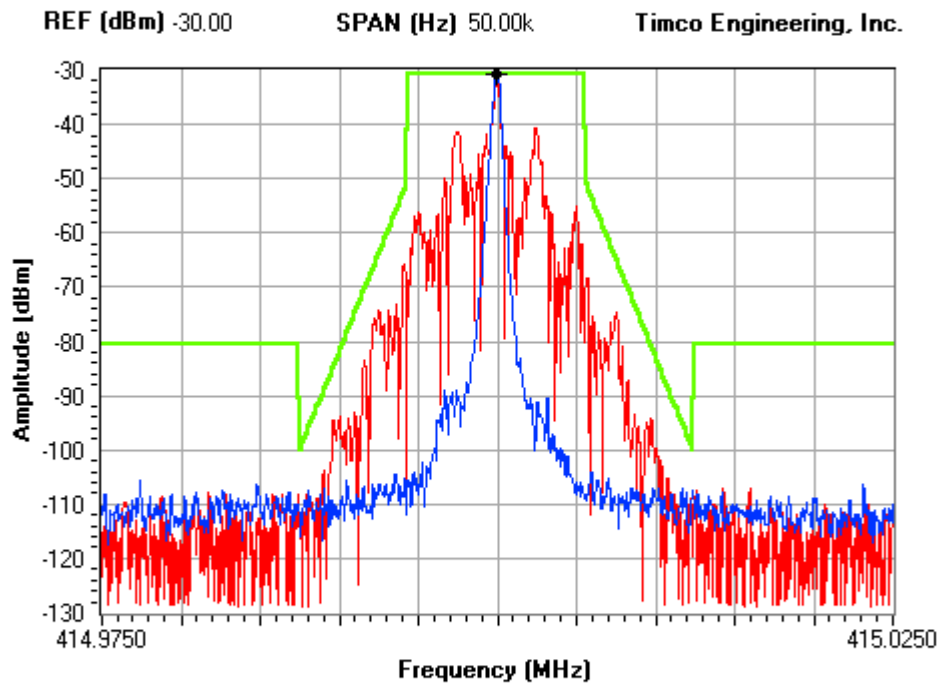

**RBW** 300 Hz      **VBW** 100 kHz      **ST [sec]** 1

**Center Frequency (Hz)** 415.000M

**Marker Delta (Hz)** 0.00

Peak	415.000	-30.60	<input checked="" type="checkbox"/>	<input checked="" type="checkbox"/>	<input checked="" type="checkbox"/>
MKR2	0.000	0.00	<input type="checkbox"/>	<input type="checkbox"/>	<input type="checkbox"/>
MKR3	0.000	0.00	<input type="checkbox"/>	<input type="checkbox"/>	<input type="checkbox"/>
HWMK	23.076	6.27	<input type="checkbox"/>	<input type="checkbox"/>	<input type="checkbox"/>

**APPLICANT:** VERTEX STANDARD CO., LTD.

**FCC ID:** K6610344140

**REPORT #:** V\VERTEX USA\_\1249AUT4\1249AUT4TestReport.doc

# TIMCO ENGINEERING INC.

849 NW State Road 45  
Newberry, Florida 32669  
<http://www.timcoengr.com>  
888.472.2424 F 352.472.2030 email: [tei@timcoengr.com](mailto:tei@timcoengr.com)

## OCCUPIED BANDWIDTH WIDE BAND

### NOTES:

VERTEX STANDARD CO., LTD. - FCC ID: K6610344140  
OCCUPIED BANDWIDTH PLOT - WIDE BAND

### FCC 90.210 Mask B

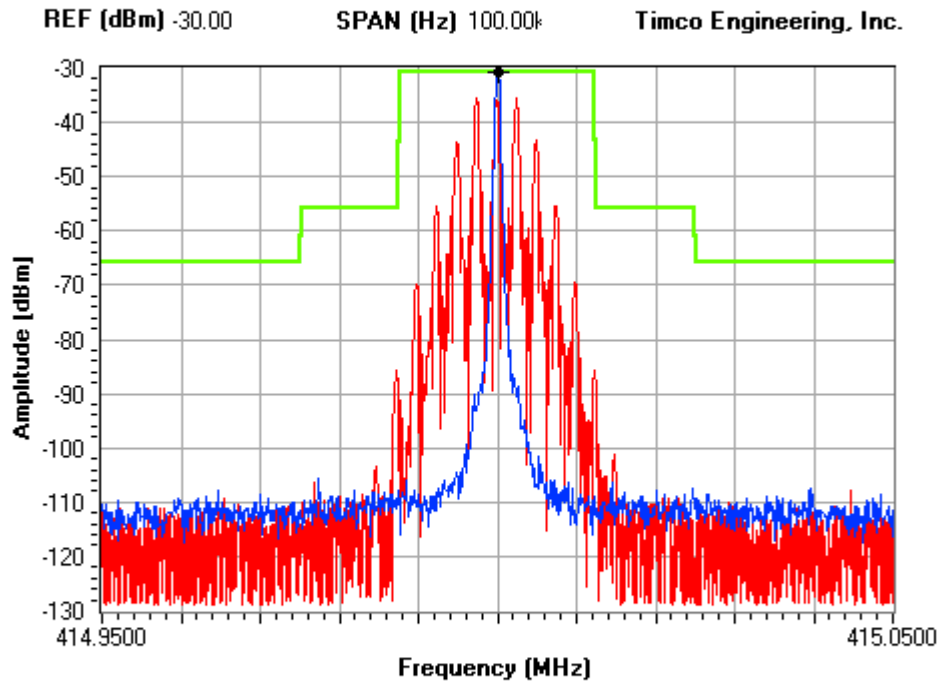

**RBW** 300 Hz      **VBW** 100 kHz      **ST [sec]** 2

**Center Frequency (Hz)** 415.000M

**Marker Delta (Hz)** 0.00

Peak	415.000	-30.70	<input checked="" type="checkbox"/>	<input type="checkbox"/>	<input type="checkbox"/>
MKR2	0.000	0.00	<input type="checkbox"/>	<input type="checkbox"/>	<input type="checkbox"/>
MKR3	0.000	0.00	<input type="checkbox"/>	<input type="checkbox"/>	<input type="checkbox"/>
HWMK	23.076	6.27	<input type="checkbox"/>	<input type="checkbox"/>	<input type="checkbox"/>

**APPLICANT:** VERTEX STANDARD CO., LTD.

**FCC ID:** K6610344140

**REPORT #:** V\VERTEX USA\_\1249AUT4\1249AUT4TestReport.doc

# TIMCO ENGINEERING INC.

849 NW State Road 45  
 Newberry, Florida 32669  
<http://www.timcoengr.com>  
 888.472.2424 F 352.472.2030 email: [tei@timcoengr.com](mailto:tei@timcoengr.com)

2.1051

**Spurious emissions at antenna terminals (conducted):**

Data below shows the level of conducted spurious responses. The carrier was modulated 100% using a 2500 Hz tone. The spectrum was scanned from 0.4 to at least the 10th harmonic of the fundamental. The measurements were made in accordance with standard TIA/EIA-603.

**REQUIREMENTS:**

Emissions must be 50 + 10log(Po) dB below the mean power output of the transmitter.

**HIGH: 50 + 10log(45) = 66.53**

**LOW: 50 + 10log(10) = 60**

TF LOW POWER	EF	dB below carrier	TF HIGH POWER	EF	dB below carrier
400	400	0.0	400	400	0.0
	800	90.3		800	95.4
	1200	85.7		1200	75.9
	1600	114.6		1600	109.3
	2000	108.2		2000	80.3
	2400	103.6		2400	94.5
	2800	107.4		2800	89.1
	3200	104.1		3200	91.2
	3600	111.8		3600	98.4
	4000	115.4		4000	108.6

TF LOW POWER	EF	dB below carrier	TF HIGH POWER	EF	dB below carrier
415	415	0.0	415	415	0.0
	830	82.2		830	90.4
	1245	86.1		1245	76.8
	1660	105.6		1660	106.4
	2075	101.7		2075	79.1
	2490	96.2		2490	95.7
	2905	111.9		2905	85.5
	3320	115.5		3320	95.6
	3735	114.7		3735	90.1
	4150	116.8		4150	106.5

TF LOW POWER	EF	dB below carrier	TF HIGH POWER	EF	dB below carrier
430	430	0.0	430	430	0.0
	860	87.6		860	93.4
	1290	93.6		1290	73.3
	1720	113.1		1720	106.7
	2150	99.2		2150	81.0
	2580	104.8		2580	96.7
	3010	111.0		3010	88.9
	3440	145.3		3440	107.5
	3870	114.6		3870	95.1
	4300	115.2		4300	108.1

**APPLICANT:** VERTEX STANDARD CO., LTD.

**FCC ID:** K6610344140

**REPORT #:** V\VERTEX USA\_\1249AUT4\1249AUT4TestReport.doc

# TIMCO ENGINEERING INC.

849 NW State Road 45  
Newberry, Florida 32669  
<http://www.timcoengr.com>  
888.472.2424 F 352.472.2030 email: [tei@timcoengr.com](mailto:tei@timcoengr.com)

## Method of Measuring Conducted Spurious Emissions

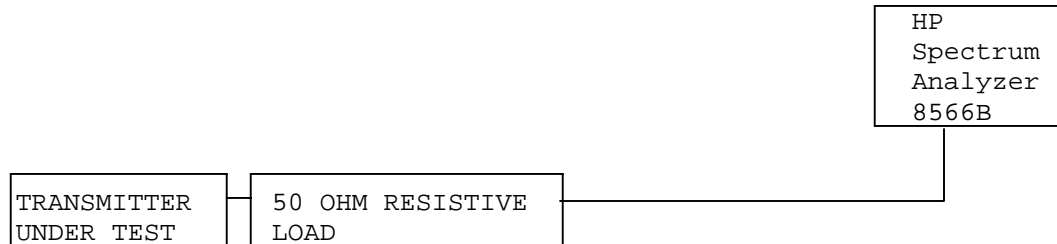

**METHOD OF MEASUREMENT:** The procedure used was TIA/EIA-603 STANDARD without any exceptions. An audio generator was connected to the UUT through a dummy microphone circuit and the output of the transmitter connected to a standard load and from the standard load through a pre-selector filter of the spectrum analyzer. The spectrum was scanned from 400 kHz to at least the tenth harmonic of the fundamental using a HP model 8566B spectrum analyzer. The measurements were made using the shielded room located at TIMCO ENGINEERING INC. 849 N.W. State Road 45, Newberry, Florida 32669.

**APPLICANT:** VERTEX STANDARD CO., LTD.

**FCC ID:** K6610344140

**REPORT #:** V\VERTEX USA\_\1249AUT4\1249AUT4TestReport.doc

# TIMCO ENGINEERING INC.

849 NW State Road 45  
Newberry, Florida 32669  
<http://www.timcoengr.com>  
888.472.2424 F 352.472.2030 email: [tei@timcoengr.com](mailto:tei@timcoengr.com)

**2.1053**                      **Field strength of spurious emissions:**

**NAME OF TEST:**            **RADIATED SPURIOUS EMISSIONS (400 MHz)**

**REQUIREMENTS:**        Emissions must be  $50 + 10\log(P_o)$  dB below the mean power output of the transmitter.

**LOW:**  $50 + 10\log(10) = 60$  dB

**HIGH:**  $50 + 10\log(45) = 66.53$  dB

**TEST DATA (LOW):**

Emission Frequency MHz	Ant. Polarity	Corrected EUT Signal Reading	Coax Loss (dB)	Substitution Antenna (dBd)	dB Below Carrier (dBc)
400.00	0	38.35	0	-0.35	0
800.00	H	-30.60	0	-1.35	69.95
1200.00	H	-43.90	1.04	3.75	79.19
1600.00	H	-41.00	1.12	5.01	75.11
2000.00	H	-42.00	1.2	5.25	75.95
2400.00	V	-34.20	1.28	6.53	66.95
2800.00	H	-54.00	1.33	7.09	86.24
3200.00	V	-51.60	1.37	7.43	83.54
3600.00	V	-54.70	1.41	7.55	86.56
4000.00	V	-48.20	1.45	7.55	80.10

**TEST DATA (HIGH):**

Emission Frequency MHz	Ant. Polarity	Corrected EUT Signal Reading	Coax Loss (dB)	Substitution Antenna (dBd)	dB Below Carrier (dBc)
400.00	0	46.88	0	-0.35	0
800.00	H	-32.90	0	-1.35	80.78
1200.00	H	-36.40	1.04	3.75	80.22
1600.00	H	-41.50	1.12	5.01	84.14
2000.00	H	-37.40	1.2	5.25	79.88
2400.00	V	-34.50	1.28	6.53	75.78
2800.00	V	-48.40	1.33	7.09	89.17
3200.00	V	-31.10	1.37	7.43	71.57
3600.00	V	-39.20	1.41	7.55	79.59
4000.00	V	-35.70	1.45	7.55	76.13

**APPLICANT:** VERTEX STANDARD CO., LTD.

**FCC ID:** K6610344140

**REPORT #:** V\VERTEX USA\_\1249AUT4\1249AUT4TestReport.doc

# TIMCO ENGINEERING INC.

849 NW State Road 45  
Newberry, Florida 32669  
<http://www.timcoengr.com>  
888.472.2424 F 352.472.2030 email: [tei@timcoengr.com](mailto:tei@timcoengr.com)

**2.1053**                      **Field strength of spurious emissions:**

**NAME OF TEST:**            **RADIATED SPURIOUS EMISSIONS (415 MHz)**

**REQUIREMENTS:**        Emissions must be  $50 + 10\log(P_o)$  dB below the mean power output of the transmitter.

**LOW:**  $50 + 10\log(10) = 60$  dB

**HIGH:**  $50 + 10\log(45) = 66.53$  dB

**TEST DATA (LOW):**

Emission Frequency MHz	Ant. Polarity	Corrected EUT Signal Reading	Coax Loss (dB)	Substitution Antenna (dBd)	dB Below Carrier (dBc)
415.00	0	38.41	0	-0.41	0
830.00	H	-35.20	0	-1.11	74.31
1245.00	H	-50.10	1.05	3.93	85.22
1660.00	H	-44.80	1.13	5.05	78.88
2075.00	H	-32.90	1.22	5.49	66.63
2490.00	V	-39.20	1.3	6.82	71.68
2905.00	H	-52.40	1.35	7.17	84.58
3320.00	V	-47.40	1.38	7.44	79.34
3735.00	V	-44.70	1.42	7.55	76.57
4150.00	V	-59.30	1.47	7.79	90.98

**TEST DATA (HIGH):**

Emission Frequency MHz	Ant. Polarity	Corrected EUT Signal Reading	Coax Loss (dB)	Substitution Antenna (dBd)	dB Below Carrier (dBc)
415.00	0	46.94	0	-0.41	0
830.00	H	-40.00	0	-1.11	87.64
1245.00	H	-46.40	1.05	3.93	90.05
1660.00	H	-40.60	1.13	5.05	83.21
2075.00	H	-32.20	1.22	5.49	74.46
2490.00	V	-38.60	1.3	6.82	79.61
2905.00	V	-49.30	1.35	7.17	90.01
3320.00	V	-27.40	1.38	7.44	67.87
3735.00	V	-29.20	1.42	7.55	69.6
4150.00	V	-40.30	1.47	7.79	80.51

**APPLICANT:** VERTEX STANDARD CO., LTD.

**FCC ID:** K6610344140

**REPORT #:** V\VERTEX USA\_\1249AUT4\1249AUT4TestReport.doc

# TIMCO ENGINEERING INC.

849 NW State Road 45  
Newberry, Florida 32669  
http://www.timcoengr.com  
888.472.2424 F 352.472.2030 email: [tei@timcoengr.com](mailto:tei@timcoengr.com)

**2.1053** Field strength of spurious emissions:

**NAME OF TEST:** RADIATED SPURIOUS EMISSIONS (430 MHz)

**REQUIREMENTS:** Emissions must be  $50 + 10\log(P_o)$  dB below the mean power output of the transmitter.

LOW:  $50 + 10\log(10) = 60$  dB

HIGH:  $50 + 10\log(45) = 66.53$  dB

**TEST DATA (LOW):**

Emission Frequency MHz	Ant. Polarity	Corrected EUT Signal Reading	Coax Loss (dB)	Substitution Antenna (dBd)	dB Below Carrier (dBc)
430.00	0	38.45	0	-0.45	0
860.00	H	-36.10	0	-0.87	74.97
1290.00	V	-57.10	1.06	4.11	92.05
1720.00	H	-42.80	1.14	5.08	76.86
2150.00	H	-40.40	1.23	5.73	73.90
2580.00	V	-42.60	1.31	6.91	75.00
3010.00	V	-55.80	1.35	7.26	87.89
3440.00	V	-43.20	1.39	7.51	75.08
3870.00	V	-46.00	1.44	7.55	77.89
4300.00	V	-58.60	1.48	8.03	90.05

**TEST DATA (HIGH):**

Emission Frequency MHz	Ant. Polarity	Corrected EUT Signal Reading	Coax Loss (dB)	Substitution Antenna (dBd)	dB Below Carrier (dBc)
430.00	0	46.98	0	-0.45	0
860.00	H	-39.00	0	-0.87	86.40
1290.00	H	-52.70	1.06	4.11	96.18
1720.00	H	-42.70	1.14	5.08	85.29
2150.00	H	-39.10	1.23	5.73	81.13
2580.00	V	-35.40	1.31	6.91	76.33
3010.00	V	-38.20	1.35	7.26	78.82
3440.00	V	-27.20	1.39	7.51	67.61
3870.00	V	-26.90	1.44	7.55	67.32
4300.00	V	-43.60	1.48	8.03	83.58

**APPLICANT:** VERTEX STANDARD CO., LTD.

**FCC ID:** K6610344140

**REPORT #:** V\VERTEX USA\_\1249AUT4\1249AUT4TestReport.doc

# TIMCO ENGINEERING INC.

849 NW State Road 45  
Newberry, Florida 32669  
<http://www.timcoengr.com>  
888.472.2424 F 352.472.2030 email: [tei@timcoengr.com](mailto:tei@timcoengr.com)

## Method of Measuring Radiated Spurious Emissions

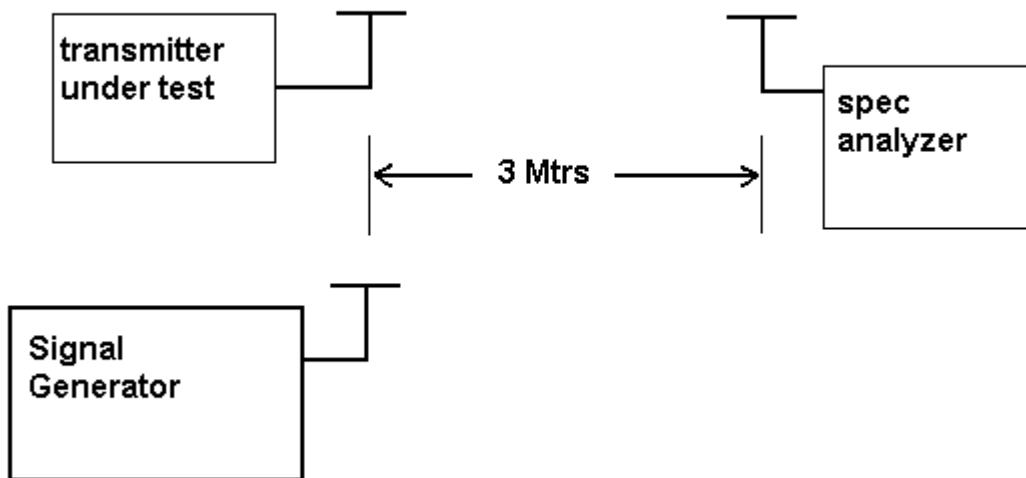

**METHOD OF MEASUREMENTS:** The tabulated data shows the results of the radiated field strength emissions test. The spectrum was scanned from 30 MHz to at least the tenth harmonic of the fundamental. This test was conducted per TIA/EIA STANDARD 603 using the substitution method. Measurements were made at the open field test site of TIMCO ENGINEERING, INC. located at 849 NW State Road 45, Newberry, FL 32669.

**APPLICANT:** VERTEX STANDARD CO., LTD.

**FCC ID:** K6610344140

**REPORT #:** V\VERTEX USA\_\1249AUT4\1249AUT4TestReport.doc



# TIMCO ENGINEERING INC.

849 NW State Road 45  
Newberry, Florida 32669  
<http://www.timcoengr.com>  
888.472.2424 F 352.472.2030 email: [tei@timcoengr.com](mailto:tei@timcoengr.com)

## 2.1055 Frequency stability: 90.213(a)(1)

Temperature and voltage tests were performed to verify that the frequency remains within the 2.5 ppm specification limit. The EUT was placed in the temperature chamber at 25° C and allowed to stabilize for one hour. The transmitter was keyed ON for one minute during which four frequency readings were recorded at 15-second intervals. The worse case number was taken for temperature plotting. The assigned channel frequency was considered to be the reference frequency. The temperature was then reduced to -30° C after which the transmitter was again allowed to stabilize for one hour. The transmitter was keyed ON for one minute, and again frequency readings were noted at 15-second intervals. The worst-case number was recorded for temperature plotting. This procedure was repeated in 10 degree increments up to + 50° C.

Readings were also taken at minus 15% of the battery voltage of 13.8 VDC, which we estimate to be the battery endpoint.

### MEASUREMENT DATA:

Assigned Frequency (Ref. Frequency): 415.000 177 MHz

<u>TEMPERATURE °C</u>	<u>FREQUENCY MHz</u>	<u>PPM</u>
REFERENCE	415.000 177	00.00
-30	415.000 014	- 0.39
-20	415.000 083	- 0.23
-10	415.000 056	- 0.29
0	415.000 134	- 0.10
+10	415.000 178	0.00
+20	415.000 177	0.00
+30	415.000 132	- 0.11
+40	415.000 083	- 0.23
+50	415.000 063	- 0.27

<u>BATT</u>	<u>%BATT. DATA</u>	<u>VOLTS</u>	<u>BATT. PPM</u>
-15%	415.000 177	11.73	0.00

**RESULTS OF MEASUREMENTS:** The test results indicates that the EUT meets the requirements.

**APPLICANT:** VERTEX STANDARD CO., LTD.

**FCC ID:** K6610344140

**REPORT #:** V\VERTEX USA\_\1249AUT4\1249AUT4TestReport.doc

# TIMCO ENGINEERING INC.

849 NW State Road 45  
Newberry, Florida 32669  
<http://www.timcoengr.com>  
888.472.2424 F 352.472.2030 email: [tei@timcoengr.com](mailto:tei@timcoengr.com)

2.1055(a)(1) Frequency stability:  
90.214 Transient Frequency Behavior

**REQUIREMENTS:** Transmitters designed to operate in the 150-174 MHz and 421-512 MHz frequency bands must maintain transient frequencies within the maximum transient frequencies within the maximum frequency difference limits during the time intervals indicated:

Time Intervals	Maximum frequency difference	All Equipment	
		150-174 MHz	421-512 MHz

#### Transient Frequency Behavior for Equipment Designed to Operate on 25 kHz Channels

$t_1^4$	$\pm 25.0$ kHz	5.0 mS	10.0 mS
$t_2$	$\pm 12.5$ kHz	20.0 mS	25.0 mS
$t_3^4$	$\pm 25.0$ kHz	5.0 mS	10.0 mS

#### Transient Frequency Behavior for Equipment Designed to Operate on 12.5 kHz Channels

$t_1^4$	$\pm 12.5$ kHz	5.0 mS	10.0 mS
$t_2$	$\pm 6.25$ kHz	20.0 mS	25.0 mS
$t_3^4$	$\pm 12.5$ kHz	5.0 mS	10.0 mS

#### Transient Frequency Behavior for Equipment Designed to Operate on 6.25 kHz Channels

$t_1^4$	$\pm 6.25$ kHz	5.0 mS	10.0 mS
$t_2$	$\pm 3.125$ kHz	20.0 mS	25.0 mS
$t_3^4$	$\pm 6.25$ kHz	5.0 mS	10.0 mS

**APPLICANT:** VERTEX STANDARD CO., LTD.

**FCC ID:** K6610344140

**REPORT #:** V\VERTEX USA\_\1249AUT4\1249AUT4TestReport.doc

# TIMCO ENGINEERING INC.

849 NW State Road 45  
Newberry, Florida 32669  
<http://www.timcoengr.com>  
888.472.2424 F 352.472.2030 email: [tei@timcoengr.com](mailto:tei@timcoengr.com)

**TEST PROCEEDURE:** TIA/EIA TS603 PARA 2.2.19, the levels were set as follows;

1. Using the variable attenuator the transmitter level was set to 40 dB below the test receivers maximum input level, then the transmitter was turned off.
2. With the transmitter off the signal generator was set 20dB below the level of the transmitter in the above step, this level will be maintained with the signal generator through-out the test.
3. Reduce the attenuation between the transmitter and the RF detector by 30 dB.
4. With the levels set as above the transient frequency behavior was observed & recorded.

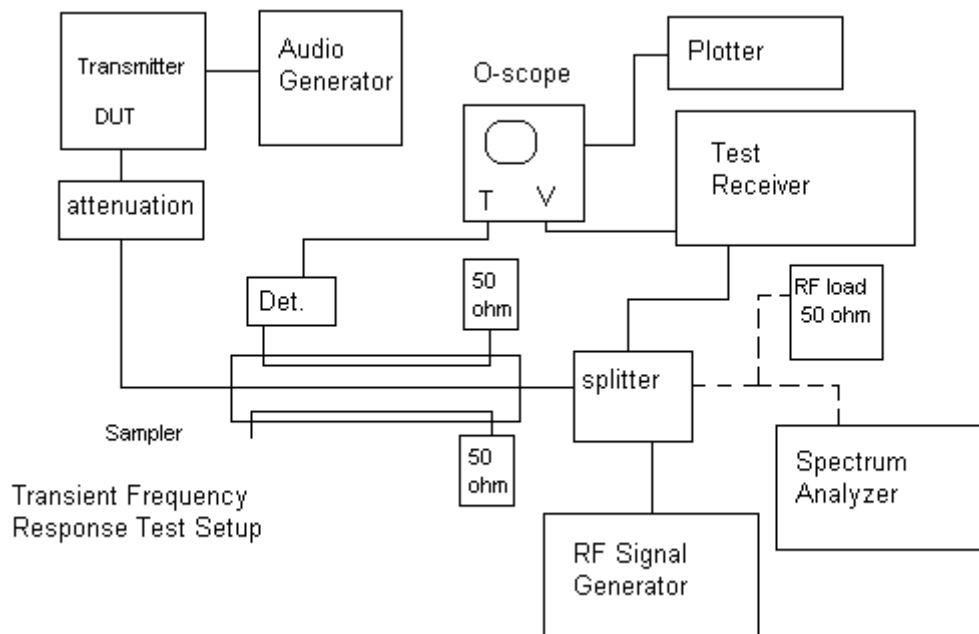

**APPLICANT:** VERTEX STANDARD CO., LTD.

**FCC ID:** K6610344140

**REPORT #:** V\VERTEX USA\_\1249AUT4\1249AUT4TestReport.doc

# TIMCO ENGINEERING INC.

849 NW State Road 45  
Newberry, Florida 32669  
<http://www.timcoengr.com>  
888.472.2424 F 352.472.2030 email: [tei@timcoengr.com](mailto:tei@timcoengr.com)

## TRANSIENT FREQUENCY RESPONSE 12.5 kHz - LOW

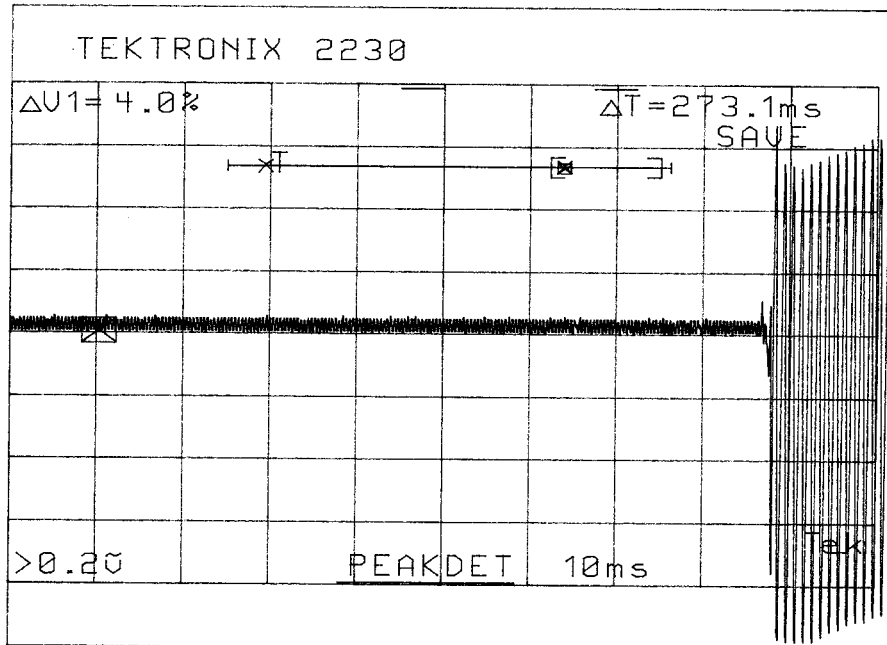
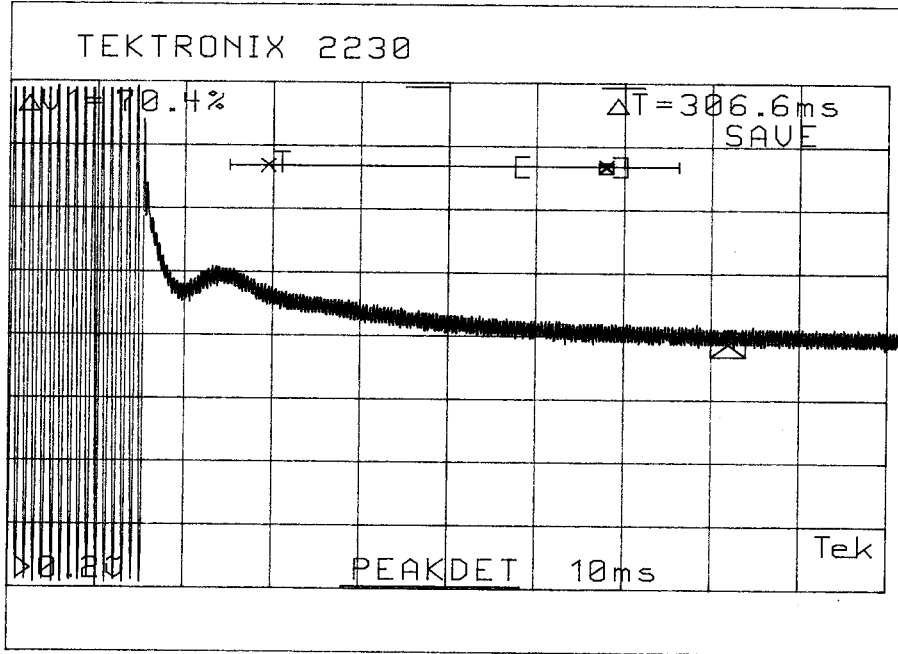

APPLICANT: VERTEX STANDARD CO., LTD.

FCC ID: K6610344140

REPORT #: V\VERTEX USA\_\1249AUT4\1249AUT4TestReport.doc

# TIMCO ENGINEERING INC.

849 NW State Road 45  
Newberry, Florida 32669  
<http://www.timcoengr.com>  
888.472.2424 F 352.472.2030 email: [tei@timcoengr.com](mailto:tei@timcoengr.com)

## TRANSIENT FREQUENCY RESPONSE 12.5 kHz - HIGH

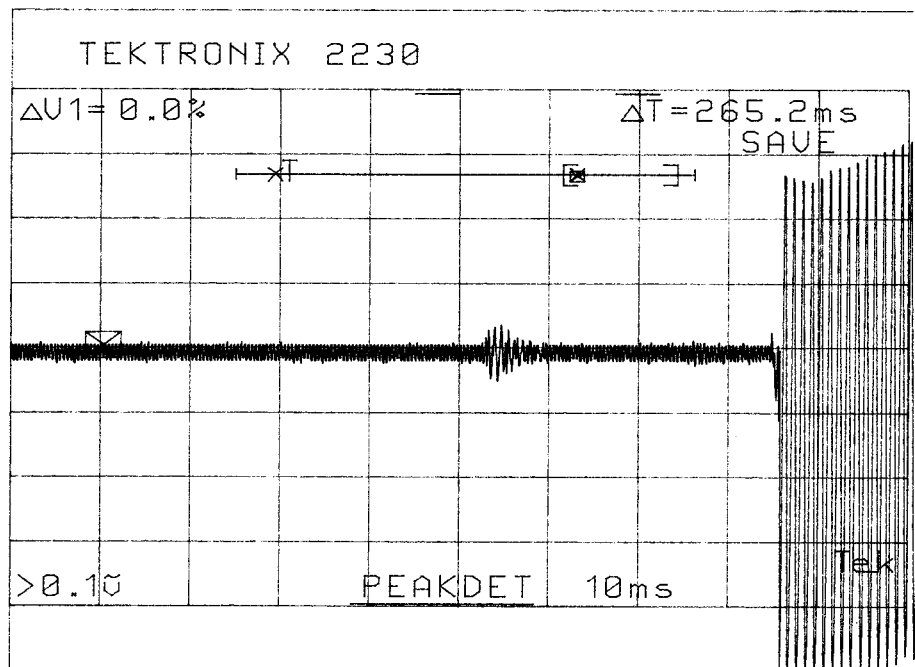
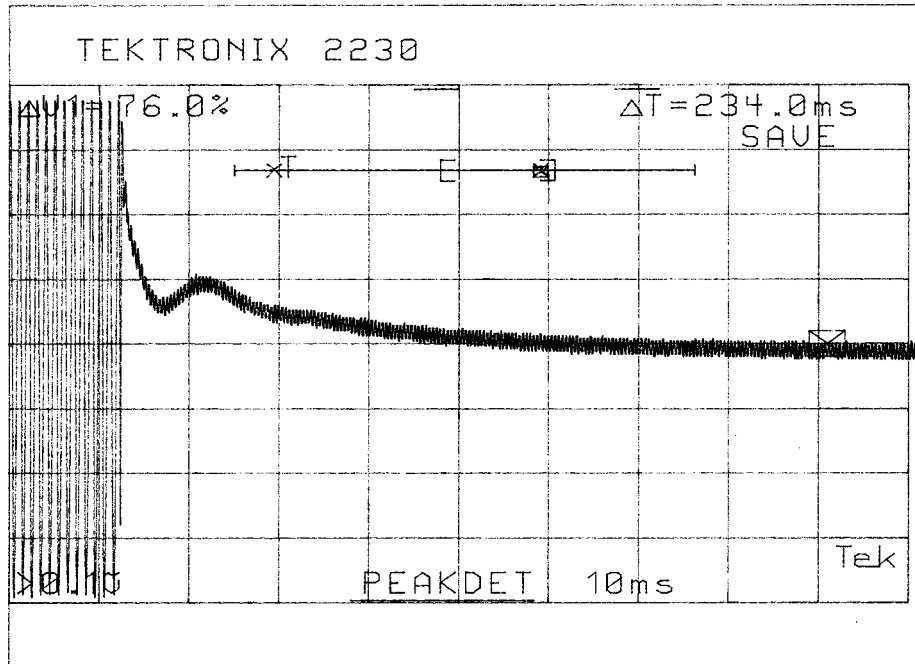

APPLICANT: VERTEX STANDARD CO., LTD.

FCC ID: K6610344140

REPORT #: V\VERTEX USA\_\1249AUT4\1249AUT4TestReport.doc

# TIMCO ENGINEERING INC.

849 NW State Road 45  
Newberry, Florida 32669  
<http://www.timcoengr.com>  
888.472.2424 F 352.472.2030 email: [tei@timcoengr.com](mailto:tei@timcoengr.com)

## TRANSIENT FREQUENCY RESPONSE 25 kHz - LOW

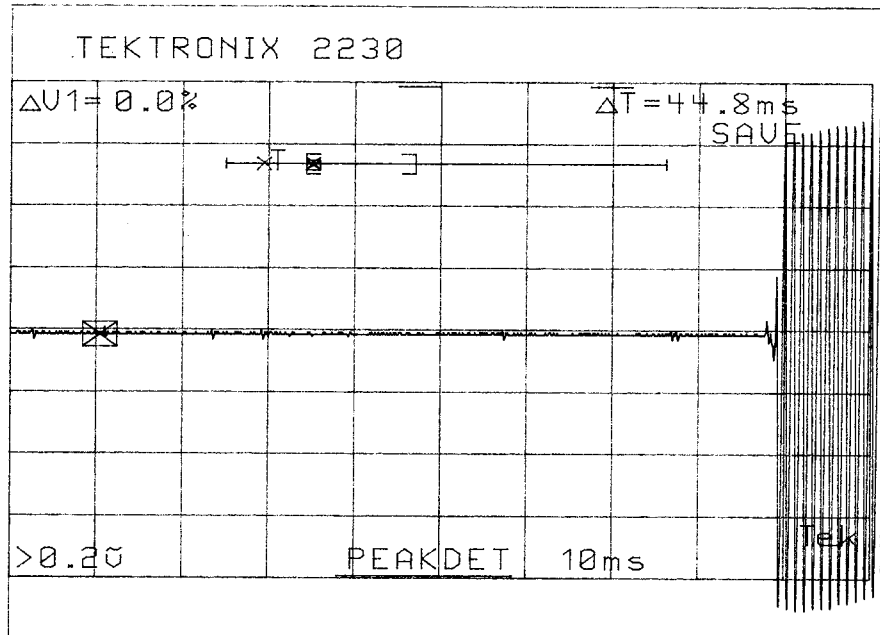
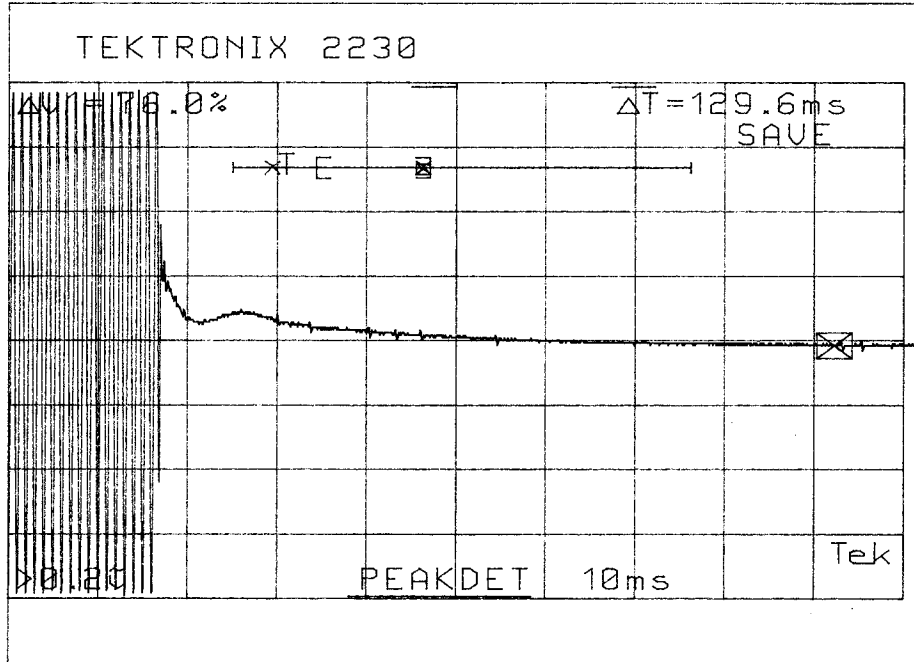

APPLICANT: VERTEX STANDARD CO., LTD.

FCC ID: K6610344140

REPORT #: V\VERTEX USA\_\1249AUT4\1249AUT4TestReport.doc

# TIMCO ENGINEERING INC.

849 NW State Road 45  
Newberry, Florida 32669  
<http://www.timcoengr.com>  
888.472.2424 F 352.472.2030 email: [tei@timcoengr.com](mailto:tei@timcoengr.com)

## TRANSIENT FREQUENCY RESPONSE 25 kHz - HIGH

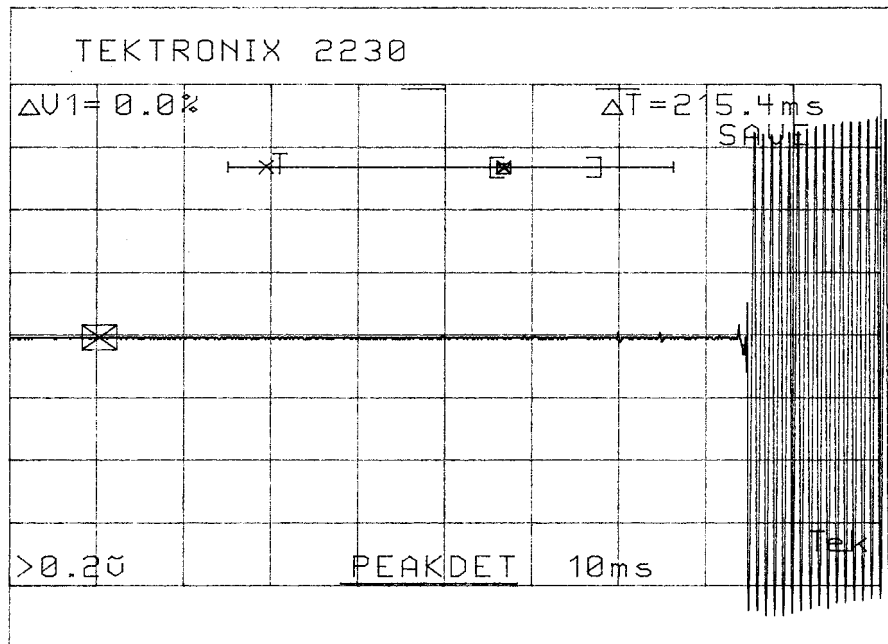
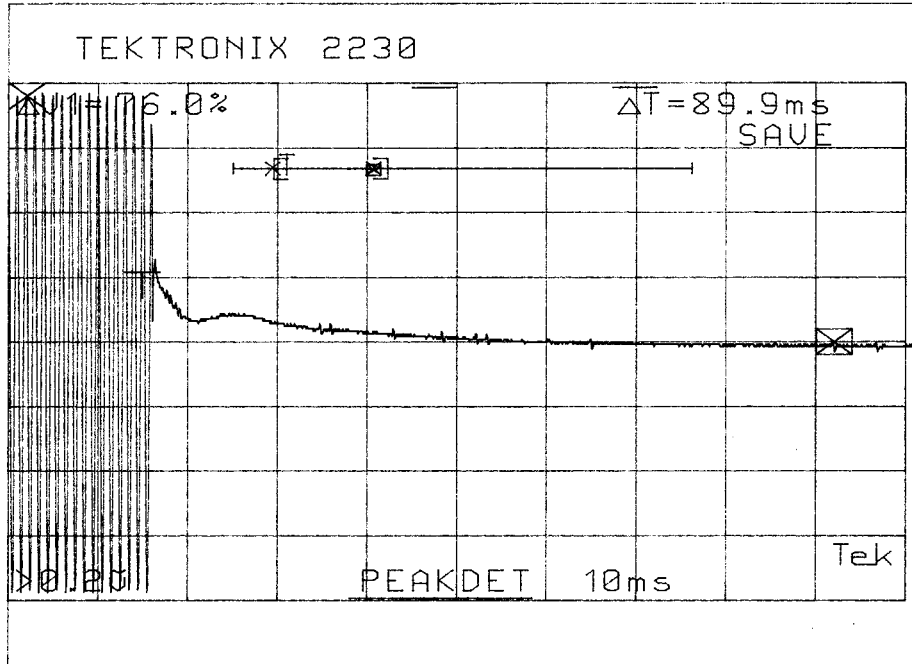

APPLICANT: VERTEX STANDARD CO., LTD.

FCC ID: K6610344140

REPORT #: V\VERTEX USA\_\1249AUT4\1249AUT4TestReport.doc

# TIMCO ENGINEERING INC.

849 NW State Road 45  
 Newberry, Florida 32669  
<http://www.timcoengr.com>  
 888.472.2424 F 352.472.2030 email: [tei@timcoengr.com](mailto:tei@timcoengr.com)

## EMC Equipment List

	DEVICE	MFGR	MODEL	SERNO	CAL/CHAR DATE	DUE DATE or STATUS
X	3-Meter OATS	TEI	N/A	N/A	Listed 1/13/03	1/13/06
	3/10-Meter OATS	TEI	N/A	N/A	Listed 3/26/01	3/26/04
	Receiver, Beige Tower Spectrum Analyzer	HP	8566B Opt 462	3138A07786 3144A20661	CAL 8/31/01	8/31/03
	RF Preselector	HP	85685A	3221A01400	CAL 8/31/01	8/31/03
	Quasi-Peak Adapter	HP	85650A	3303A01690	CAL 8/31/01	8/31/03
X	Receiver, Blue Tower Spectrum Analyzer	HP	8568B	2928A04729 2848A18049	CAL 4/15/03	4/15/05
X	RF Preselector	HP	85685A	2926A00983	CAL 4/15/03	4/15/05
X	Quasi-Peak Adapter	HP	85650A	2811A01279	CAL 4/15/03	4/15/05
	Receiver, Silver/Grey Tower Spectrum Analyzer	HP	8566B Opt 462	3552A22064 3638A08608	CAL 10/14/02	10/14/04
	RF Preselector	HP	85685A	2620A00294	CAL 10/14/02	10/14/04
	Quasi-Peak Adapter	HP	85650A	3303A01844	CAL 10/14/02	10/14/04
	Preamplifier	HP	8449B	3008A01075	CHAR 1/28/02	1/28/04
X	Biconnical Antenna	Electro-Metrics	BIA-25	1171	CAL 4/26/01	4/26/03
	Biconnical Antenna	Eaton	94455-1	1096	CAL 10/1/01	10/1/03
	Biconnical Antenna	Eaton	94455-1	1057	CAL 3/18/03	3/18/05
	BiconiLog Antenna	EMCO	3143	9409-1043		
X	Log-Periodic Antenna	Electro-Metrics	LPA-25	1122	CAL 10/2/01	10/2/03
	Log-Periodic Antenna	Electro-Metrics	EM-6950	632	CHAR 10/15/01	10/15/03
	Log-Periodic Antenna	Electro-Metrics	LPA-30	409	CAL 3/4/03	3/4/05

APPLICANT: VERTEX STANDARD CO., LTD.

FCC ID: K6610344140

REPORT #: V\VERTEX USA\_\1249AUT4\1249AUT4TestReport.doc



# TIMCO ENGINEERING INC.

849 NW State Road 45  
 Newberry, Florida 32669  
<http://www.timcoengr.com>  
 888.472.2424 F 352.472.2030 email: [tei@timcoengr.com](mailto:tei@timcoengr.com)

DEVICE	MFGR	MODEL	SERNO	CAL/CHAR DATE	DUE DATE or STATUS
Dipole Antenna Kit	Electro-Metrics	TDA-30/1-4	152	CAL 3/21/01	3/21/04
Dipole Antenna Kit	Electro-Metrics	TDA-30/1-4	153	CAL 9/26/02	9/26/05
Double-Ridged Horn Antenna	Electro-Metrics	RGA-180	2319	CAL 2/17/03	2/17/05
Horn Antenna	Electro-Metrics	EM-6961	6246	CAL 3/31/03	3/31/05
Horn Antenna	ATM	19-443-6R	None	No Cal Required	
Passive Loop Antenna	EMC Test Systems	EMCO 6512	9706-1211	CHAR 7/10/01	7/10/03
Line Impedance Stabilization . . .	Electro-Metrics	ANS-25/2	2604	CAL 10/9/01	10/9/03
Line Impedance Stabilization . . .	Electro-Metrics	EM-7820	2682	CAL 3/12/03	3/12/05
Termaline Wattmeter	Bird Electronic Corporation	611	16405	CAL 5/25/99	5/25/01
Termaline Wattmeter	Bird Electronic Corporation	6104	1926	CHAR 12/12/01	12/12/03
Oscilloscope	Tektronix	2230	300572	CHAR 2/1/01	2/1/03
System One	Audio Precision	System One	SYS1-45868	CHAR 4/25/02	4/25/04
Temperature Chamber	Tenney Engineering	TTRC	11717-7	CHAR 1/22/02	1/22/04
AC Voltmeter	HP	400FL	2213A14499	CAL 10/9/01	10/9/03
AC Voltmeter	HP	400FL	2213A14261	CHAR 10/15/01	10/15/03
AC Voltmeter	HP	400FL	2213A14728	CHAR 10/15/01	10/15/03
X Digital Multimeter	Fluke	77	35053830	CHAR 1/8/02	1/8/04
Digital Multimeter	Fluke	77	43850817	CHAR 1/8/02	1/8/04
Digital Multimeter	HP	E2377A	2927J05849	CHAR 1/8/02	1/8/04
Multimeter	Fluke	FLUKE-77-3	79510405	CHAR 9/26/01	9/26/03
Peak Power Meter	HP	8900C	2131A00545	CHAR 1/26/01	1/26/03
Power Meter	HP	432A	1141A07655	CAL 4/15/03	4/15/05

APPLICANT: VERTEX STANDARD CO., LTD.

FCC ID: K6610344140

REPORT #: V\VERTEX USA\_\1249AUT4\1249AUT4TestReport.doc

# TIMCO ENGINEERING INC.

849 NW State Road 45  
 Newberry, Florida 32669  
<http://www.timcoengr.com>  
 888.472.2424 F 352.472.2030 email: [tei@timcoengr.com](mailto:tei@timcoengr.com)

	DEVICE	MFGR	MODEL	SERNO	CAL/CHAR DATE	DUE DATE or STATUS
	Power Meter And Sensor	Bird	4421-107 4022	0166 0218	CAL 4/16/03	4/16/05
	Power Sensor	HP	478A	72129	CAL 4/15/03	4/15/05
	Digital Thermometer	Fluke	2166A	42032	CAL 1/16/02	1/16/04
	Thermometer	Traulsen	SK-128		CHAR 1/22/02	1/22/04
	Thermometer	Extech	4028	14871-2	CAL 3/7/03	3/7/05
X	Hygro-Thermometer	Extech	445703	0602	CAL 10/4/02	10/4/04
	Frequency Counter	HP	5352B	2632A00165	CAL 11/28/01	11/28/03
	Frequency Counter	HP	5385A	2730A03025	CAL 3/7/03	3/7/05
	Power Sensor	Agilent Technologies	84811A	2551A02705	CHAR 1/26/01	1/26/03
	Service Monitor	IFR	FM/AM 500A	5182	CAL 11/22/00	11/22/02
	Comm. Serv. Monitor	IFR	FM/AM 1200S	6593	CAL 5/12/02	5/12/04
	Signal Generator	HP	8640B	2308A21464	CAL 2/15/02	2/15/04
	Sweep Generator	Wiltron	6648	101009	CAL 4/15/03	4/15/05
	Sweep Generator	Wiltron	6669M	007005	CAL 3/3/03	3/3/05
	Modulation Analyzer	HP	8901A	3435A06868	CAL 9/5/01	9/5/03
	Modulation Meter	Boonton	8220	10901AB	CAL 4/15/03	4/15/05
	Near Field Probe	HP	HP11940A	2650A02748	CHAR 2/1/01	2/1/03
	BandReject Filter	Lorch Microwave	5BR4-2400/ 60-N	Z1	CHAR 3/2/01	3/2/03
	BandReject Filter	Lorch Microwave	6BR6-2442/ 300-N	Z1	CHAR 3/2/01	3/2/03
	BandReject Filter	Lorch Microwave	5BR4-10525/ 900-S	Z1	CHAR 3/2/01	3/2/03
	High Pass Filter	Microlab	HA-10N		CHAR 10/4/01	10/4/03
	High Pass Filter	Microlab	HA-20N		CHAR 2/7/03	2/7/05

APPLICANT: VERTEX STANDARD CO., LTD.

FCC ID: K6610344140

REPORT #: V\VERTEX USA\_\1249AUT4\1249AUT4TestReport.doc

# TIMCO ENGINEERING INC.

849 NW State Road 45  
 Newberry, Florida 32669  
<http://www.timcoengr.com>  
 888.472.2424 F 352.472.2030 email: [tei@timcoengr.com](mailto:tei@timcoengr.com)

DEVICE	MFGR	MODEL	SERNO	CAL/CHAR DATE	DUE DATE or STATUS
Audio Oscillator	HP	653A	832-00260	CHAR 3/1/01	3/1/03
Frequency Counter	HP	5382A	1620A03535	CHAR 3/2/01	3/2/03
Frequency Counter	HP	5385A	3242A07460	CAL 3/7/03	3/7/05
Preamplifier	HP	8449B-H02	3008A00372	CHAR 3/4/01	3/4/03
Amplifier	HP	11975A	2738A01969	CHAR 3/1/01	3/1/03
Egg Timer	Unk			CHAR 8/31/01	8/31/03
Measuring Tape, 20M	Kraftixx	0631-20		CHAR 2/1/02	2/1/04
Measuring Tape, 7.5M	Kraftixx	7.5M PROF1		2/1/02	2/1/04
Coaxial Cable #51	Insulated Wire Inc.	NPS 2251-2880	Timco #51	CHAR 1/23/02	1/23/04
Coaxial Cable #64	Semflex Inc.	60637	Timco #64	CHAR 1/24/02	1/24/04
Coaxial Cable #65	General Cable Co.	E9917 RG233/U	Timco #65	CHAR 1/23/02	1/23/04
Coaxial Cable #106	Unknown	Unknown	Timco #106	CHAR 1/23/02	1/23/04

**APPLICANT:** VERTEX STANDARD CO., LTD.

**FCC ID:** K6610344140

**REPORT #:** V\VERTEX USA\_\1249AUT4\1249AUT4TestReport.doc