

VX-P920/P970 (UHF) series Alignment

Introduction

The VX-P920/P970 (UHF) series is carefully aligned at the factory for the specified performance across the frequency range specified for each version. Realignment should therefore not be necessary except in the event of a component failure, or altering version type. All component replacement and service should be performed only by an authorized **Vertex Standard** representative, or the warranty policy may be void.

The following procedures cover the sometimes critical and tedious adjustments that are not normally required once the transceiver has left the factory. However, if damage occurs and some parts subsequently are placed, realignment may be required. If a sudden problem occurs during normal operation, it is likely due to component failure; realignment should not be done until after the faulty component has been replaced.

We recommend that servicing be performed only by authorized **Vertex Standard** service technicians who are experienced with the circuitry and fully equipped for repair and alignment. Therefore, if a fault is suspected, contact the dealer from whom the transceiver was purchased for instructions regarding repair. Authorized **Vertex Standard** service technicians realign all circuits and make complete performance checks to ensure compliance with factory specifications after replacing any faulty components.

Those who do undertake any of the following alignments are cautioned to proceed at their own risk. Problems caused by unauthorized attempts at realignment are not covered by the warranty policy. Also, **Vertex Standard** reserves the right to change circuits and alignment procedures in the interest of improved performance, without notifying owners.

Under no circumstances should any alignment be attempted unless the normal function and operation of the transceiver are clearly understood, the cause of the malfunction has been clearly pinpointed and any faulty components replaced, and realignment determined to be absolutely necessary.

The following test equipment (and thorough familiarity with its correct use) is necessary for complete realignment. Correction of problems caused by misalignment resulting from use of improper test equipment is not covered under the warranty policy. While most steps do not require all of the equipment listed, the interactions of some adjustments may require that more complex adjustments be performed afterwards.

Do not attempt to perform only a single step unless it is clearly isolated electrically from all other steps. Have all test equipment ready before beginning, and follow all of the steps in a section in the order presented.

Required Test Equipment

- RF Signal Generator with calibrated output level at 1 GHz
- Deviation Meter (linear detector)
- In-line Wattmeter with 5 % accuracy at 500 MHz
- 50 Ω RF Dummy Load with power rating 10 W at 500 MHz
- 16 Ω AF Dummy Load (**Attention** : Audio output is BTL output)
- Regulated DC Power Supply (standard 7.5 V DC, 3 A)
- Frequency Counter with 0.2 ppm accuracy at 500 MHz
- Audio Generator
- AC Voltmeter
- DC Voltmeter
- VHF Sampling Coupler
- IBM PC / compatible Computer with Microsoft DOS v3.0 or later operating system
- Vertex Standard** VPL-1 Connection Cable & Alignment program

Alignment Preparation & Precautions

A 50- Ω RF Dummy Load and in-line wattmeter must be connected to the main antenna jack in all procedures that call for transmission, except where specified otherwise. Correct alignment is not possible with an antenna.

After completing one step, read the following step to determine whether the same test equipment will be required. If not, remove the test equipment (except dummy load and wattmeter, in connected) before proceeding.

Correct alignment requires that the ambient temperature be the same as that of the transceiver and test equipment, and that this temperature be held constant between 20 and 30 $^{\circ}$ C (68 ~ 86 $^{\circ}$ F). When the transceiver is brought into the shop from hot or cold air, it should be allowed time to come to room temperature before alignment.

Whenever possible, alignments should be made with oscillator shields and circuit boards firmly affixed in place.

Also, the test equipment must be thoroughly warmed up before beginning.

Note: Signal levels in dB referred to in the alignment procedure are based on
 $0 \text{ dB}_{\mu} \text{ EMF} = 1 \mu\text{V}$.

Setup the test equipment as shown for transceiver alignment, apply 7.4 V DC power to the transceiver. Refer to the drawings above for Alignment Points.

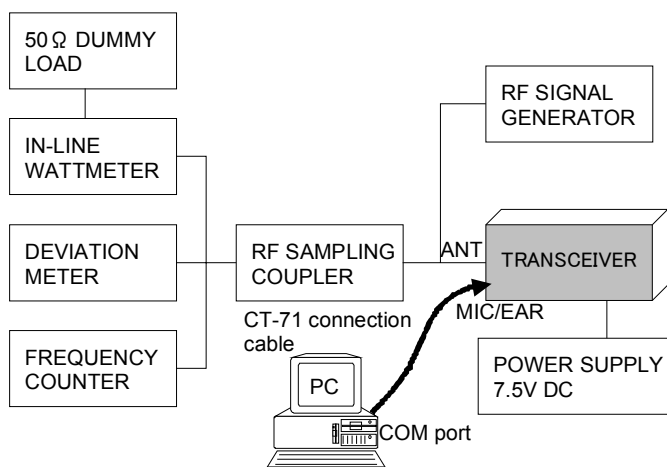

The transceiver must be programmed for use in the intended system before alignment is attempted. The RF parameters are loaded from the file during the alignment process.

In order to facilitate alignment over the complete switching range of the equipment it is recommended that the channel data in the transceiver is preset as the chart below.

Channels	Frequency
BAND-LOW	380.000 MHz
BAND-MID	415.000 MHz
BAND-HIGH	450.000 MHz

The alignment mode is accessed by "Alignment mode" command from the computer whilst switching on. And the alignment tool operates it automatically.

During the alignment mode, normal operation is suspended. Use the alignment tool program running on PC.

The alignment tool outline

Installation the tool

This alignment tool consists, MS-DOS based, only one execute file " vx-xxxadj.exe ". You make a directly as you think fit, and copy this file. That is all of the installation process.

Boot the tool

Change directly and input in command line, " vx-xxxadj [enter] ", and boot the alignment tool.

Enter to the alignment mode

To enter the alignment mode, you have to power on the transceiver, and press [F10]. If entry succeed, the transceiver generated a beep " pi-ro-ro".

Action of the switches

When the transceiver is in alignment mode, the action of accessory key is ignored. All of the action is remote controlled by PC.

Basic sequence

The data displayed in screen of this tool is temporary data, and there is fear that the consistence of the displayed data and the data in the transceiver is failure when you do not keep the sequence, which is specified below.

Basic sequence

1. Enter the alignment mode
2. Data upload
3. Align data
4. Data download

When finish the alignment one parameter, the tool ask you " Update this data? ". If you select "Y", the temporary data is updated.

Next it ask you " Download this result to transceiver? ". If you select "Y", the tool downloaded data to the transceiver.

Menu of the tool

BASIC Adjustment

In this section, the parameters are in common with all the channels. Each parameter changed up/down by [UP]/[DOWN], and fixed by input [R] at appropriate value.

"TX High Power", "Maximum Deviation." and "Sub-Audio Deviation." can be trimmed at each channel on CHANNEL FINE Adjustment.

Set up the test equipment as shown above for transmitter alignment. Hold the supply voltage constant 7.4 V for all steps.

[F] PLL Reference Frequency

This parameter is used to adjust the PLL reference frequency.

Select the MID frequency channel in alignment range.

Press the [S] key on the keyboard to activate the transmitter.

Press the [UP]/[DOWN] key, as need, so the counter frequency is within ± 50 Hz of the channel center frequency for the MID channel.

When the frequency is attained, press [R] to lock in the new data.

Now verify that the HIGH and LOW channels are also within tolerance.

[T] TX Power

- [0] High

This parameter is used to align TX High power (5 W).

Select the MID frequency channel in alignment range.

Press the [0] key on the keyboard to activate the transmitter.

Press the [UP]/[DOWN] key, as need, to set the power output to 5 Watts, as indicated on the external wattmeter.

When the 5 Watts level is attained, press [R] to lock in the new data.

- [1] L1

This parameter is used to align TX L1 power (250 mW).

Select the MID frequency channel in alignment range.

Press the [1] key on the keyboard to activate the transmitter.

Press the [UP]/[DOWN] key, as need, to set the power output to 250 mWatts, as indicated on the external wattmeter.

When the 250 mWatts level is attained, press [R] to lock in the new data.

- [2] L2

This parameter is used to align TX L2 power (1 W).

Select the MID frequency channel in alignment range.

Press the [2] key on the keyboard to activate the transmitter.

Press the [UP]/[DOWN] key, as need, to set the power output to 1 Watts, as indicated on the external wattmeter.

When the 1 Watts level is attained, press [R] to lock in the new data.

- [3] L3

This parameter is used to align TX L3 power (2.5 W).

Select the MID frequency channel in alignment range.

Press the [3] key on the keyboard to activate the transmitter.

Press the [UP]/[DOWN] key, as need, to set the power output to 2.5 Watts, as indicated on the external wattmeter.

When the 2.5 Watts level is attained, press [R] to lock in the new data.

[D] Maximum Deviation

This parameter is used to align the Maximum Deviation.

[S] Max Deviation

This parameter is used to align the Maximum Deviation.

It adjusts this alignment Deviation Balance (ALL) after ending.

Select the MID frequency channel in alignment range.

Press the [S] key on the keyboard to activate the transmitter, and injects a 1 kHz test tone.

Press the [UP]/[DOWN] key, as need, to set the maximum deviation.

When the desired deviation level is attained, press [R] to lock in the new data.

[V] Deviation Balance (CH)

This parameter is used to align Deviation Balance that VCO Deviation and REF Deviation.

Set up Flat AF palmate, and input 40 Hz, 50 mVrms AF to Ext MIC

Select align frequency channel.

Press the [Space] bar on the keyboard to activate the transmitter.

Check the deviation meter at 40 Hz.

Press the [Space] bar and input 3kHz, 50 mVrms AF to Ext MIC.

Press the [UP]/[DOWN] key to set the same deviation at 40 Hz AF.

When the desired deviation level is attained, press [R] to lock in the new data.

[L] Deviation Balance (ALL)

This parameter is used to align Deviation Balance that VCO Deviation and REF Deviation.

Set the Flat AF palmate, and obey the message. The channels must be set to LOW, MID and HIGH each other before execute this alignment.

[C] Sub-Audio Deviation.

This parameter is used to align the sub-audio (CTCSS/DCS) deviation.

Select the MID frequency channel in alignment range.

Press the [S] key on the keyboard to activate the transmitter, and injects a sub-audio test tone.

Press the [UP]/[DOWN] key, as need, to set the deviation.

When the desired deviation level is attained, press [R] to lock in the new data.

[U] RX Auto Tuning

This parameter is used to tune all channels. The tune of the VX-920/970 (UHF) series RF circuit is depend on its firmware, and execute this alignment, all channels are tuned appropriately.

Set the SG output level to +20 dB μ EMF, and obey the message. The channels must be set to LOW, MID and HIGH each other before execute this alignment.

[N] NSQL

This data is sampled noise level for Noise Squelch.

It adjusts this alignment RX Auto Tuning after ending.

- [Z] Tight

This parameter is used to align the noise level in squelch level 11 (channel parameter).

Set the SG output level to 0 dB μ EMF, and obey the message.

- [X] Threshold

This parameter is used to align the noise level in squelch level 1.
Set the SG output level to -10 dB μ EMF, and obey the message.

[I] RSSI

- [Z] RSSI SQL

This parameter is the RSSI level for RSSI squelch.
Set the SG output level to +3 dB μ EMF, and obey the message.

- [X] TX save

This parameter is the RSSI level for TX save activity.
Set the SG output level to +15 dB μ EMF, and obey the message.

[V] BAT Warning Level

This parameter is Battery Level for “Li-ion battery warning (6.5 V)” and “Alkaline battery warning (5.5 V)”.

[G] MIC Gain

This parameter is used to align the MIC Gain Level.
Press the [S] key on the keyboard to activate the transmitter.
Press the [UP]/[DOWN] key, as need, to set the deviation.
When the desired deviation is attained, press [R] to lock in the new data.

[B] BEEP

This parameter is used to align the BEEP Level.

CHANNEL FINE Adjustment

The following parameters are set every channel.

[T] TX Power

This parameter is used to trim TX High/Low power in displayed channel.

[X] Maximum Deviation

This parameter is used to trim Maximum Deviation in displayed channel.

[C] Sub-Audio Deviation

This parameter is used to trim Sub-Audio Deviation in displayed channel.

[U] RX Manual Tuning

This parameter sets RX Tune of the display channel.

[S] Squelch Level Set

This parameter sets the Squelch Level. This is equal to the Squelch Volume of the popular transceiver.

[F] Frequency Set

This parameter sets the TX/RX Frequency.

[A] Reset

This parameter resets and restarts the transceiver.

[L] Deviation Balance

This parameter is used to trim Deviation Balance in displayed channel.

[V] PLL Set

This parameter is set up PLL parameter.