

Test Report Serial No.:	082605K66-T665-S90U	Test Dates:	Sept. 01-02, 2005
Date of Report Issue:	September 15, 2005	Rev. No.:	Revision 0
Description of Test:	RF Exposure SAR	FCC 2:1093	IC RSS-102

RF EXPOSURE EVALUATION
SPECIFIC ABSORPTION RATE

SAR TEST REPORT

FOR THE

VERTEX PORTABLE FM UHF PTT RADIO TRANSCEIVER

**MODEL(S): VX-P921-G7-5, VX-P924-G7-5, VX-P929-G7-5,
VX-P971-G7-5, VX-P974-G7-5, VX-P979-G7-5**

FCC ID: K6610334721

IC: 511B-10334721

Test Report Serial Number

**082605K66-T665-S90U
Issue 1.0**

Test Report Issue Date

September 15, 2005

Test Lab

**Celltech Compliance Testing & Engineering Lab
(Celltech Labs Inc.)
1955 Moss Court
Kelowna, BC
Canada
V1Y 9L3**

<p>Test Report Prepared By:</p> <p align="center"><i>Cheri Frangiadakis</i></p> <hr/> <p align="center">Cheri Frangiadakis Test Report Writer Celltech Labs Inc.</p>	<p>Test Report Approved By:</p> <p align="center"></p> <hr/> <p align="center">Jonathan Hughes General Manager Celltech Labs Inc.</p>
--	---

Applicant:	Vertex Standard Co., Ltd.	FCC ID:	K6610334721	IC ID:	511B-10334721	Freq.:	450 - 512 MHz
Model(s):	VX-P921-G7-5, VX-P924-G7-5, VX-P929-G7-5, VX-P971-G7-5, VX-P974-G7-5, VX-P979-G7-5		Portable FM UHF PTT Radio Transceiver				
2005 Celltech Labs Inc.	This document is not to be reproduced in whole or in part without the prior written permission of Celltech Labs Inc.						1 of 64

Test Report Serial No.:	082605K66-T665-S90U	Test Dates:	Sept. 01-02, 2005
Date of Report Issue:	September 15, 2005	Rev. No.:	Revision 0
Description of Test:	RF Exposure SAR	FCC 2:1093	IC RSS-102

DECLARATION OF COMPLIANCE SAR RF EXPOSURE EVALUATION

Test Lab		Applicant Information	
CELLTECH LABS INC. Testing and Engineering Services 1955 Moss Court Kelowna, B.C. Canada V1Y 9L3 Phone: 250-448-7047 Fax: 250-448-7046 e-mail: info@celltechlabs.com web site: www.celltechlabs.com		VERTEX STANDARD CO., LTD. 4-8-8 Nakameguro, Meguro-Ku Tokyo 153-8644 Japan	
FCC IDENTIFIER:	K6610334721	IC IDENTIFIER:	511B-10334721
Model(s):	VX-P921-G7-5, VX-P924-G7-5, VX-P929-G7-5, VX-P971-G7-5, VX-P974-G7-5, VX-P979-G7-5		
Rule Part(s):	FCC 47 CFR §2.1093; IC RSS-102 Issue 1 (Provisional)		
Test Procedure(s):	FCC OET Bulletin 65, Supplement C (Edition 01-01)		
Device Classification:	Licensed Non-Broadcast Transmitter Held to Face (TNF)		
Device Description:	Portable FM UHF PTT Radio Transceiver		
Modulation Type:	FM (UHF)		
Tx Frequency Range:	450 - 512 MHz		
Max. RF Output Power Measured:	36.43 dBm (4.40 Watts) Conducted (450 MHz) 36.78 dBm (4.76 Watts) Conducted (480 MHz) 36.45 dBm (4.42 Watts) Conducted (512 MHz)		
Antenna Type(s) Tested:	Whip 450-485 MHz (P/N: ATU-6D) Whip 485-520 MHz (P/N: ATU-6F)		
Battery Type(s) Tested:	Li-ion 7.4 V 1150 mAh (P/N: FNB-V86LI) Li-ion 7.4 V 2000 mAh (P/N: FNB-V87LI) Alkaline 1.5 V 2850 mAh (Duracell Procell AA x6) Alkaline Battery Case (P/N: FBA-34)		
Body-Worn Accessories Tested:	Plastic Belt-Clip with Metal Spring (P/N: CLIP-920) Leather Case with Swivel Belt-Loop (P/N: LCC-920S)		
Audio Accessories Tested:	Leather Case with Belt-Loop (P/N: LCC-920) Speaker-Microphone (P/N: MH-65B7A)		
Max. SAR Levels Evaluated:	Face-held: 1.58 W/kg (50% Duty Cycle) Body-worn: 3.42 W/kg (50% Duty Cycle)		

Celltech Labs Inc. declares under its sole responsibility that this wireless portable device has demonstrated compliance with the Specific Absorption Rate (SAR) RF exposure requirements specified in FCC 47 CFR §2.1093 and Health Canada's Safety Code 6. The device was tested in accordance with the measurement standards and procedures specified in FCC OET Bulletin 65, Supplement C (Edition 01-01) and Industry Canada RSS-102 Issue 1 (Provisional) for the Occupational / Controlled Exposure environment. All measurements were performed in accordance with the SAR system manufacturer's recommendations.

I attest to the accuracy of data. All measurements were performed by me or were made under my supervision and are correct to the best of my knowledge and belief. I assume full responsibility for the completeness of these measurements and vouch for the qualifications of all persons taking them.

This test report shall not be reproduced partially, or in full, without the prior written approval of Celltech Labs Inc. The results and statements contained in this report pertain only to the device(s) evaluated.

Tested By:



Sean Johnston
Compliance Technologist
Celltech Labs Inc.

Reviewed By:



Spencer Watson
Senior Compliance Technologist
Celltech Labs Inc.



Applicant:	Vertex Standard Co., Ltd.	FCC ID:	K6610334721	IC ID:	511B-10334721	Freq.:	450 - 512 MHz
Model(s):	VX-P921-G7-5, VX-P924-G7-5, VX-P929-G7-5, VX-P971-G7-5, VX-P974-G7-5, VX-P979-G7-5		Portable FM UHF PTT Radio Transceiver				
2005 Celltech Labs Inc.	This document is not to be reproduced in whole or in part without the prior written permission of Celltech Labs Inc.						2 of 64

Test Report Serial No.:	082605K66-T665-S90U	Test Dates:	Sept. 01-02, 2005
Date of Report Issue:	September 15, 2005	Rev. No.:	Revision 0
Description of Test:	RF Exposure	SAR	FCC 2:1093
			IC RSS-102

TABLE OF CONTENTS	
1.0 INTRODUCTION	4
2.0 DESCRIPTION OF DEVICE UNDER TEST (DUT)	4
3.0 SAR MEASUREMENT SYSTEM	5
4.0 MEASUREMENT SUMMARY	6
5.0 DETAILS OF SAR EVALUATION	8
6.0 EVALUATION PROCEDURES	9
7.0 SYSTEM PERFORMANCE CHECK	10
8.0 SIMULATED EQUIVALENT TISSUES	11
9.0 SAR SAFETY LIMITS	11
10.0 ROBOT SYSTEM SPECIFICATIONS	12
11.0 PROBE SPECIFICATION (ET3DV6)	13
12.0 PLANAR PHANTOM	13
13.0 VALIDATION PLANAR PHANTOM	13
14.0 DEVICE HOLDER	13
15.0 TEST EQUIPMENT LIST	14
16.0 MEASUREMENT UNCERTAINTIES	15
17.0 REFERENCES	17
APPENDIX A - SAR MEASUREMENT DATA	18
APPENDIX B - SYSTEM PERFORMANCE CHECK DATA	32
APPENDIX C - MEASURED FLUID DIELECTRIC PARAMETERS	35
APPENDIX D - SAR TEST SETUP & DUT PHOTOGRAPHS	38
APPENDIX E - SYSTEM VALIDATION	63
APPENDIX F - PROBE CALIBRATION	64

Applicant:	Vertex Standard Co., Ltd.	FCC ID:	K6610334721	IC ID:	511B-10334721	Freq.:	450 - 512 MHz	
Model(s):	VX-P921-G7-5, VX-P924-G7-5, VX-P929-G7-5, VX-P971-G7-5, VX-P974-G7-5, VX-P979-G7-5			Portable FM UHF PTT Radio Transceiver				
2005 Celltech Labs Inc.		This document is not to be reproduced in whole or in part without the prior written permission of Celltech Labs Inc.					3 of 64	

Test Report Serial No.:	082605K66-T665-S90U	Test Dates:	Sept. 01-02, 2005
Date of Report Issue:	September 15, 2005	Rev. No.:	Revision 0
Description of Test:	RF Exposure	SAR	FCC 2:1093
			IC RSS-102

1.0 INTRODUCTION

This measurement report demonstrates compliance of the Vertex Standard Co., Ltd. Models: VX-P921-G7-5, VX-P924-G7-5, VX-P929-G7-5, VX-P971-G7-5, VX-P974-G7-5, VX-P979-G7-5 Portable FM UHF PTT Radio Transceiver FCC ID: K6610334721 with the SAR (Specific Absorption Rate) RF exposure requirements specified in FCC 47 CFR §2.1093 (see reference [1]), and Health Canada Safety Code 6 (see reference [2]) for the Occupational / Controlled Exposure environment. The test procedures described in FCC OET Bulletin 65, Supplement C (Edition 01-01) (see reference [3]) and IC RSS-102 Issue 1 (Provisional) (see reference [4]), were employed. A description of the product and operating configuration, detailed summary of the test results, methodology and procedures used in the evaluation, equipment used, and the various provisions of the rules are included within this test report.

2.0 DESCRIPTION OF DEVICE UNDER TEST (DUT)

FCC Rule Part(s)	47 CFR §2.1093			
IC Rule Part(s)	RSS-102 Issue 1 (Provisional)			
Test Procedure(s)	FCC OET Bulletin 65, Supplement C (Edition 01-01)			
FCC Device Classification	Licensed Non-Broadcast Transmitter Held to Face (TNF)			
IC Device Classification	Land Mobile Radio Transmitter (RSS-119)			
Device Description	Portable FM UHF PTT Radio Transceiver			
FCC IDENTIFIER	K6610334721			
IC IDENTIFER	511B-10334721			
Model(s)	VX-P921-G7-5	VX-P924-G7-5	VX-P929-G7-5	
	VX-P971-G7-5	VX-P974-G7-5	VX-P979-G7-5	
Serial No. of Test Sample	5J000003		Production Unit	
Modulation Type	FM (UHF)			
Tx Frequency Range	450 - 512 MHz			
Max. RF Output Power Measured	36.43 dBm	4.40 Watts	450 MHz	Conducted
	36.77 dBm	4.76 Watts	480 MHz	Conducted
	36.45 dBm	4.42 Watts	512 MHz	Conducted
Battery Type(s) Tested	Lithium-ion	7.4 V	1150 mAh	P/N: FNB-V86LI
	Lithium-ion	7.4 V	2000 mAh	P/N: FNB-V87LI
	Alkaline Batteries (6x AA)	9 V	2850 mAh	P/N: FBA-34 (Case)
Antenna Type(s) Tested	Whip	450-485 MHz	Length: 149 mm	P/N: ATU-6D
	Whip	485-520 MHz	Length: 141 mm	P/N: ATU-6F
Body-Worn Accessories Tested	Belt-Clip (Plastic with Metal Spring)			P/N: CLIP-920
	Leather Case with Detachable Swivel Belt-Loop			P/N: LCC-920S
	Leather Case with Belt-Loop			P/N: LCC-920
Audio Accessories Tested	Speaker-Microphone			P/N: MH-65B7A

Applicant:	Vertex Standard Co., Ltd.	FCC ID:	K6610334721	IC ID:	511B-10334721	Freq.:	450 - 512 MHz	
Model(s):	VX-P921-G7-5, VX-P924-G7-5, VX-P929-G7-5, VX-P971-G7-5, VX-P974-G7-5, VX-P979-G7-5		Portable FM UHF PTT Radio Transceiver					
2005 Celltech Labs Inc.		This document is not to be reproduced in whole or in part without the prior written permission of Celltech Labs Inc.					4 of 64	

Test Report Serial No.:	082605K66-T665-S90U	Test Dates:	Sept. 01-02, 2005
Date of Report Issue:	September 15, 2005	Rev. No.:	Revision 0
Description of Test:	RF Exposure	SAR	FCC 2:1093
			IC RSS-102

3.0 SAR MEASUREMENT SYSTEM

Celltech Labs Inc. SAR measurement facility utilizes the Dosimetric Assessment System (DASY™) manufactured by Schmid & Partner Engineering AG (SPEAG™) of Zurich, Switzerland. The DASY4 measurement system is comprised of the measurement server, robot controller, computer, near-field probe, probe alignment sensor, specific anthropomorphic mannequin (SAM) phantom, and various planar phantoms for brain and/or body SAR evaluations. The robot is a six-axis industrial robot performing precise movements to position the probe to the location (points) of maximum electromagnetic field (EMF). A cell controller system contains the power supply, robot controller, teach pendant (Joystick), and remote control, is used to drive the robot motors. The Staubli robot is connected to the cell controller to allow software manipulation of the robot. A data acquisition electronic (DAE) circuit performs the signal amplification, signal multiplexing, AD-conversion, offset measurements, mechanical surface detection, collision detection, etc. is connected to the Electro-optical coupler (EOC). The EOC performs the conversion from the optical into digital electric signal of the DAE and transfers data to the DASY4 measurement server. The DAE4 utilizes a highly sensitive electrometer-grade preamplifier with auto-zeroing, a channel and gain-switching multiplexer, a fast 16-bit AD-converter and a command decoder and control logic unit. Transmission to the DASY4 measurement server is accomplished through an optical downlink for data and status information and an optical uplink for commands and clock lines. The mechanical probe-mounting device includes two different sensor systems for frontal and sidewise probe contacts. The sensor systems are also used for mechanical surface detection and probe collision detection. The robot uses its own controller with a built in VME-bus computer.



DASY4 SAR Measurement System with validation phantom



DASY4 SAR Measurement System with Plexiglas planar phantom

Applicant:	Vertex Standard Co., Ltd.	FCC ID:	K6610334721	IC ID:	511B-10334721	Freq.:	450 - 512 MHz
Model(s):	VX-P921-G7-5, VX-P924-G7-5, VX-P929-G7-5, VX-P971-G7-5, VX-P974-G7-5, VX-P979-G7-5		Portable FM UHF PTT Radio Transceiver				
2005 Celltech Labs Inc.	This document is not to be reproduced in whole or in part without the prior written permission of Celltech Labs Inc.						5 of 64

Test Report Serial No.:	082605K66-T665-S90U	Test Dates:	Sept. 01-02, 2005
Date of Report Issue:	September 15, 2005	Rev. No.:	Revision 0
Description of Test:	RF Exposure	SAR	FCC 2:1093 IC RSS-102

4.0 MEASUREMENT SUMMARY

FACE-HELD SAR EVALUATION RESULTS													
Freq. (MHz)	Chan.	Test Mode	Antenna Tested		Battery Tested		Separation Distance to Planar Phantom (cm)	Cond. Power Before Test (dBm)	Measured SAR 1g (W/kg)		SAR Drift During Test (dB)	Scaled SAR with droop 1g (W/kg)	
			Type	Part No.	Type	mAh			Duty Cycle			Duty Cycle	
									100%	50%		100%	50%
480	Mid	CW	Whip	ATU-6D	Li-ion	1150	2.5	36.68	2.76	1.38	-0.367	3.00	1.50
480	Mid	CW	Whip	ATU-6D	Li-ion	2000	2.5	36.70	2.92	1.46	-0.330	3.15	1.58
480	Mid	CW	Whip	ATU-6D	Alkaline	2850	2.5	36.66	2.41	1.21	-1.13	3.13	1.56
512	High	CW	Whip	ATU-6F	Li-ion	2000	2.5	36.45	2.60	1.30	-0.376	2.84	1.42
ANSI / IEEE C95.1 1999 - SAFETY LIMIT					BRAIN: 8.0 W/kg (averaged over 1 gram)				Spatial Peak Controlled Exposure / Occupational				
Test Date		September 01, 2005					Relative Humidity		34		%		
Measured Fluid Type		450 MHz Brain					Atmospheric Pressure		101.7		Kpa		
Dielectric Constant ϵ_r		IEEE Target		Measured	Deviation	Ambient Temperature		24.5		°C			
		43.5	$\pm 5\%$	43.4	-0.2%	Fluid Temperature		23.1		°C			
Conductivity σ (mho/m)		IEEE Target		Measured	Deviation	Fluid Depth		≥ 15		Cm			
		0.87	$\pm 5\%$	0.86	-1.1%	ρ (Kg/m³)		1000					

Note(s):

- The measurement results were obtained with the DUT tested in the conditions described in this report. Detailed measurement data and plots showing the maximum SAR location of the DUT are reported in Appendix A.
- If the scaled SAR levels evaluated at the mid channel (50% duty cycle) were ≥ 3 dB below the SAR limit, SAR evaluation for the low and high channels was optional per FCC OET Bulletin 65, Supplement C, Edition 01-01 (see reference [3]).
- The high channel (512 MHz) was evaluated with the worst-case battery evaluated at the mid channel (Li-ion, 2000 mAh).
- The power droops measured by the DASY4 system for the duration of the SAR evaluations were added to the measured SAR levels to report scaled SAR results as shown in the above test data table.
- The ambient and fluid temperatures were measured prior to, and during, the fluid dielectric parameter check and the SAR evaluations. The temperatures reported were consistent for all measurement periods.
- The dielectric parameters of the simulated tissue mixture were measured prior to the SAR evaluations using an ALS-PR-DIEL Dielectric Probe Kit and an HP 8753ET Network Analyzer (see Appendix C for measured fluid dielectric parameters).
- The SAR evaluations were performed within 24 hours of the system performance check.

Applicant:	Vertex Standard Co., Ltd.	FCC ID:	K6610334721	IC ID:	511B-10334721	Freq.:	450 - 512 MHz
Model(s):	VX-P921-G7-5, VX-P924-G7-5, VX-P929-G7-5, VX-P971-G7-5, VX-P974-G7-5, VX-P979-G7-5			Portable FM UHF PTT Radio Transceiver			
2005 Celltech Labs Inc.	This document is not to be reproduced in whole or in part without the prior written permission of Celltech Labs Inc.						6 of 64

Test Report Serial No.:	082605K66-T665-S90U	Test Dates:	Sept. 01-02, 2005
Date of Report Issue:	September 15, 2005	Rev. No.:	Revision 0
Description of Test:	RF Exposure	SAR	FCC 2:1093 IC RSS-102

MEASUREMENT SUMMARY (CONT.)

BODY-WORN SAR EVALUATION RESULTS

Freq. (MHz)	Chan.	Test Mode	Antenna Tested		Battery Tested		Accessories Tested		Separ. Distance to Planar Phantom (cm)	Cond. Power Before Test (dBm)	Measured SAR 1g (W/kg)		SAR Drift During Test (dB)	Scaled SAR with droop 1g (W/kg)			
			Type	Part No.	Type	mAh	Body-worn	Audio			Duty Cycle			Duty Cycle			
											100%	50%		100%	50%		
480	Mid	CW	Whip	ATU-6D	Li-ion	1150	Belt-Clip	Speaker-Mic	1.2	36.74	6.19	3.10	-0.428	6.83	3.42		
480	Mid	CW	Whip	ATU-6D	Li-ion	2000	Belt-Clip	Speaker-Mic	1.0	36.60	6.02	3.01	-0.363	6.54	3.27		
480	Mid	CW	Whip	ATU-6D	Alkaline	2850	Belt-Clip	Speaker-Mic	0.6	36.47	4.99	2.50	-1.07	6.38	3.19		
512	High	CW	Whip	ATU-6F	Li-ion	1150	Belt-Clip	Speaker-Mic	1.2	36.27	5.04	2.52	-0.407	5.54	2.77		
480	Mid	CW	Whip	ATU-6D	Li-ion	1150	Leather Case 1	Speaker-Mic	4.7	36.64	1.25	0.625	-0.367	1.36	0.680		
480	Mid	CW	Whip	ATU-6D	Li-ion	1150	Leather Case 2	Speaker-Mic	2.5	36.78	P	3.95	1.98	-0.434	P	4.37	2.18
											S	3.75	1.88	-0.464	S	4.17	2.09
ANSI / IEEE C95.1 1999 - SAFETY LIMIT					BODY: 8.0 W/kg (averaged over 1 gram)					Spatial Peak Controlled Exposure / Occupational							
Test Date		September 02, 2005				Relative Humidity			42				%				
Measured Fluid Type		450 MHz Body				Atmospheric Pressure			101.5				kPa				
Dielectric Constant ϵ_r		IEEE Target		Measured	Deviation	Ambient Temperature			24.2				°C				
		56.7	± 5%	56.8	+0.2%	Fluid Temperature			22.6				°C				
Conductivity σ (mho/m)		IEEE Target		Measured	Deviation	Fluid Depth			≥ 15				cm				
		0.94	± 5%	0.96	+2.1%	ρ (Kg/m³)			1000								

Note(s):

- The measurement results were obtained with the DUT tested in the conditions described in this report. Detailed measurement data and plots showing the maximum SAR location of the DUT are reported in Appendix A.
- If the scaled SAR levels evaluated at the mid channel (50% duty cycle) were ≥ 3 dB below the SAR limit, SAR evaluation for the low and high channels was optional per FCC OET Bulletin 65, Supplement C, Edition 01-01 (see reference [3]).
- The high channel (512 MHz) was evaluated with the worst-case body-worn accessory (belt-clip) and battery type (Li-ion, 1150 mAh) evaluated at the mid channel.
- The two leather case accessories were evaluated using the worst-case battery type evaluated with the belt-clip accessory. All body-worn accessories contain metallic components and the belt-clip provides the minimum separation distance between radio and planar phantom.
- A SAR-versus-Time power drift evaluation was performed in the test configuration that reported the worst-case power droop (belt-clip accessory, mid channel, alkaline batteries). See Appendix A (SAR Test Plots) for SAR-versus-Time power droop evaluation plot.
- Secondary peak SAR levels measured within 2 dB of the primary were reported (P = Primary, S = Secondary).
- The power droops measured by the DASY4 system for the duration of the SAR evaluations were added to the measured SAR levels to report scaled SAR results as shown in the above test data table.
- The ambient and fluid temperatures were measured prior to, and during, the fluid dielectric parameter check and the SAR evaluations. The temperatures reported were consistent for all measurement periods.
- The dielectric parameters of the simulated tissue mixture were measured prior to the SAR evaluations using an ALS-PR-DIEL Dielectric Probe Kit and an HP 8753ET Network Analyzer (see Appendix C for measured fluid dielectric parameters).
- The SAR evaluations were performed within 24 hours of the system performance check.

**Abbreviations: Leather Case 1: Leather Case with detachable swivel belt-loop (P/N: LCC-920S)
Leather Case 2: Leather Case with belt-loop (P/N: LCC-920)**

Applicant:	Vertex Standard Co., Ltd.	FCC ID:	K6610334721	IC ID:	511B-10334721	Freq.:	450 - 512 MHz
Model(s):	VX-P921-G7-5, VX-P924-G7-5, VX-P929-G7-5, VX-P971-G7-5, VX-P974-G7-5, VX-P979-G7-5			Portable FM UHF PTT Radio Transceiver			
2005 Celltech Labs Inc.	This document is not to be reproduced in whole or in part without the prior written permission of Celltech Labs Inc.						7 of 64

Test Report Serial No.:	082605K66-T665-S90U	Test Dates:	Sept. 01-02, 2005
Date of Report Issue:	September 15, 2005	Rev. No.:	Revision 0
Description of Test:	RF Exposure	SAR	FCC 2:1093
			IC RSS-102

5.0 DETAILS OF SAR EVALUATION

The Vertex Standard Co., Ltd. Models: VX-P921-G7-5, VX-P924-G7-5, VX-P929-G7-5, VX-P971-G7-5, VX-P974-G7-5, VX-P979-G7-5 FM UHF PTT Radio Transceiver FCC ID: K6610334721 was compliant for localized Specific Absorption Rate (Occupational / Controlled Exposure) based on the test provisions and conditions described below. The detailed test setup photographs are shown in Appendix D.

1. The DUT was evaluated in a face-held configuration with the front of the radio placed parallel to the outer surface of the planar phantom. A 2.5 cm separation distance was maintained between the front side of the DUT and the outer surface of the planar phantom.
2. The DUT was evaluated in a body-worn configuration with the back of the radio placed parallel to the outer surface of the planar phantom. The attached belt-clip accessory (P/N: CLIP-920) was touching the planar phantom. With the Li-ion 1150 mAh battery the belt-clip accessory provided a 1.2 cm separation distance between the back of the DUT and the outer surface of the planar phantom. With the Li-ion 2000 mAh battery the belt-clip accessory provided a 1.0 cm separation distance between the back of the DUT and the outer surface of the planar phantom. With the Alkaline Battery Case the belt-clip accessory provided a 0.6 cm separation distance between the back of the DUT and the outer surface of the planar phantom. The DUT was evaluated for body-worn SAR with the speaker-microphone accessory connected to the audio port.
3. The DUT was tested in a body-worn configuration with the radio placed inside the Leather Case with Detachable Swivel Belt-Loop accessory (P/N: LCC-920S) and the back of the radio facing parallel to the outer surface of the planar phantom. The back of the Belt-Loop accessory was touching the outer surface of the planar phantom and provided a 4.7 cm separation distance between the back of the DUT and the outer surface of the planar phantom. The DUT was evaluated for body-worn SAR with the speaker-microphone accessory connected to the audio port.
4. The DUT was tested in a body-worn configuration with the radio placed inside the Leather Case with Belt-Loop accessory (P/N: LCC-920) and the back of the radio facing parallel to the outer surface of the planar phantom. The back of the Leather Case with Belt-Loop was touching the outer surface of the planar phantom and provided a 2.5 cm separation distance between the back of the DUT and the outer surface of the planar phantom. The DUT was evaluated for body-worn SAR with the speaker-microphone accessory connected to the audio port.
5. The conducted power levels were measured prior to each test using a Gigatronics 8652A Universal Power Meter according to the procedures described in FCC 47 CFR §2.1046.
6. The power droops measured by the DASY4 system during the SAR evaluations were added to the measured SAR levels to report scaled SAR results as shown in the test data tables (pages 6-7).
7. A SAR-versus-Time power drift evaluation was performed in the test configuration that reported the maximum power droop in the worst-case configuration (Body-Worn, Alkaline Battery Pack). See Appendix A (SAR Test Plots) for SAR-versus-Time power drift evaluation plot.
8. The area scan evaluation was performed with a fully charged battery. After the area scan was completed the radio was cooled down to room temperature and the battery was replaced with a fully charged battery prior to the zoom scan evaluation.
9. The DUT was tested in unmodulated continuous transmit operation (Continuous Wave mode at 100% duty cycle) with the transmit key constantly depressed. For a push-to-talk device the 50% duty cycle compensation reported assumes a transmit/receive cycle of equal time base.
10. The SAR evaluations were performed using a Plexiglas planar phantom.
11. The ambient and fluid temperatures were measured prior to, and during, the fluid dielectric parameter checks and the SAR evaluations. The temperatures reported were consistent for all measurement periods.
12. The dielectric parameters of the simulated tissue mixtures were measured prior to the SAR evaluations using an ALS-PR-DIEL Dielectric Probe Kit and an HP 8753ET Network Analyzer (see Appendix C for measured fluid dielectric parameters).
13. The SAR evaluations were performed within 24 hours of the system performance check.

Applicant:	Vertex Standard Co., Ltd.	FCC ID:	K6610334721	IC ID:	511B-10334721	Freq.:	450 - 512 MHz
Model(s):	VX-P921-G7-5, VX-P924-G7-5, VX-P929-G7-5, VX-P971-G7-5, VX-P974-G7-5, VX-P979-G7-5			Portable FM UHF PTT Radio Transceiver			
2005 Celltech Labs Inc.	This document is not to be reproduced in whole or in part without the prior written permission of Celltech Labs Inc.						8 of 64

6.0 EVALUATION PROCEDURES

- a. (i) The evaluation was performed in the applicable area of the phantom depending on the type of device being tested. For devices held to the ear during normal operation, both the left and right ear positions were evaluated using the SAM phantom.
(ii) For body-worn and face-held devices a planar phantom was used.
- b. The SAR was determined by a pre-defined procedure within the DASY4 software. Upon completion of a reference and optical surface check, the exposed region of the phantom was scanned near the inner surface with a grid spacing of 15mm x 15mm.

An area scan was determined as follows:

- c. Based on the defined area scan grid, a more detailed grid is created to increase the points by a factor of 10. The interpolation function then evaluates all field values between corresponding measurement points.
- d. A linear search is applied to find all the candidate maxima. Subsequently, all maxima are removed that are >2 dB from the global maximum. The remaining maxima are then used to position the cube scans.

A 1g and 10g spatial peak SAR was determined as follows:

- e. Extrapolation is used to find the points between the dipole center of the probe and the surface of the phantom. This data cannot be measured, since the center of the dipoles is 2.7 mm away from the tip of the probe and the distance between the surface and the lowest measuring point is 1.4 mm (see probe calibration document in Appendix F). The extrapolation was based on trivariate quadratics computed from the previously calculated 3D interpolated points nearest the phantom surface.
- f. Interpolated data is used to calculate the average SAR over 1g and 10g cubes by spatially discretizing the entire measured cube. The volume used to determine the averaged SAR is a 1mm grid (42875 interpolated points).
- g. A zoom scan volume of 32 mm x 32 mm x 30 mm (5 x 5 x 7 points) centered at the peak SAR location determined from the area scan is used for all zoom scans for devices with a transmit frequency < 800 MHz. Zoom scans for frequencies ≥ 800 MHz are determined with a scan volume of 30 mm x 30 mm x 30 mm (7 x 7 x 7) to ensure complete capture of the peak spatial-average SAR.



Face-Held Test Setup Configuration



Body-Worn Test Setup Configuration

Applicant:	Vertex Standard Co., Ltd.	FCC ID:	K6610334721	IC ID:	511B-10334721	Freq.:	450 - 512 MHz
Model(s):	VX-P921-G7-5, VX-P924-G7-5, VX-P929-G7-5, VX-P971-G7-5, VX-P974-G7-5, VX-P979-G7-5			Portable FM UHF PTT Radio Transceiver			
2005 Celltech Labs Inc.	This document is not to be reproduced in whole or in part without the prior written permission of Celltech Labs Inc.						9 of 64

7.0 SYSTEM PERFORMANCE CHECK

Prior to the SAR evaluation a system check was performed using a planar phantom with a 450 MHz dipole (see Appendix E for system validation procedures). The dielectric parameters of the simulated tissue mixture were measured prior to the system performance check using an ALS-PR-DIEL Dielectric Probe Kit and an HP 8753ET Network Analyzer (see Appendix C for measured fluid dielectric parameters). A forward power of 250 mW was applied to the dipole and the system was verified to a tolerance of $\pm 10\%$ (see Appendix B for system performance check test plot).

SYSTEM PERFORMANCE CHECK EVALUATION

Test Date	450MHz Equiv. Tissue	SAR 1g (W/kg)			Dielectric Constant ϵ_r			Conductivity σ (mho/m)			ρ (Kg/m ³)	Amb. Temp. (°C)	Fluid Temp. (°C)	Fluid Depth (cm)	Humid. (%)	Barom. Press. (kPa)
		IEEE Target	Meas.	Dev.	IEEE Target	Meas.	Dev.	IEEE Target	Meas.	Dev.						
9/1/05	Brain	1.23 $\pm 10\%$	1.26	+2.4%	43.5 $\pm 5\%$	43.4	-0.2%	0.87 $\pm 5\%$	0.86	-1.1%	1000	23.7	23.0	≥ 15	35	101.8

Note(s):

1. The ambient and fluid temperatures were measured prior to, and during, the fluid dielectric parameter check and the system performance check. The temperatures listed in the table above were consistent for all measurement periods.

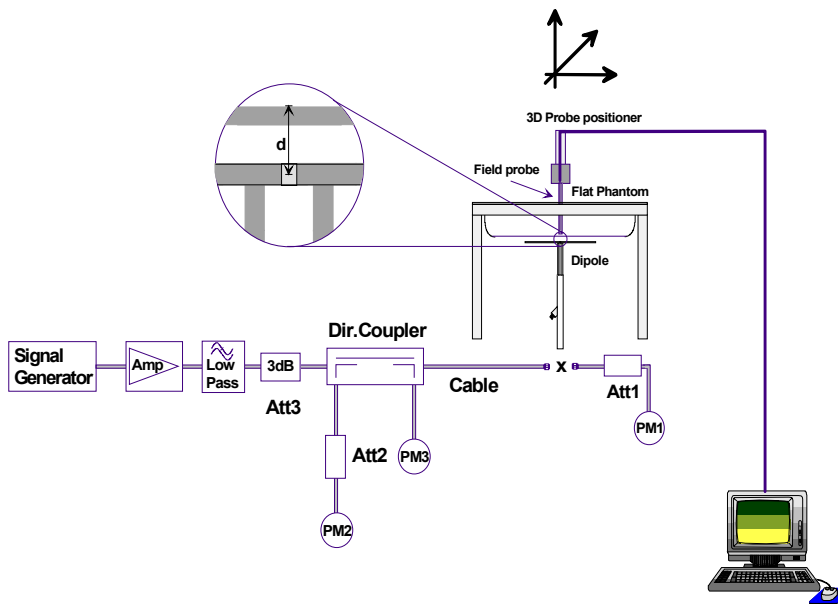

Figure 1. System Performance Check Setup Diagram



450 MHz Dipole Setup

8.0 SIMULATED EQUIVALENT TISSUES

The 450MHz brain and body simulated tissue mixtures consist of a viscous gel using hydroxethylcellulose (HEC) gelling agent and saline solution. Preservation with a bactericide is added and visual inspection is made to ensure air bubbles are not trapped during the mixing process. The fluid was prepared according to standardized procedures, and measured for dielectric parameters (permittivity and conductivity).

SIMULATED TISSUE MIXTURES		
INGREDIENT	450 MHz Brain	450 MHz Body
	System Check & DUT Evaluation	DUT Evaluation
Water	38.56 %	52.00 %
Sugar	56.32 %	45.65 %
Salt	3.95 %	1.75 %
HEC	0.98 %	0.50 %
Bactericide	0.19 %	0.10 %

9.0 SAR SAFETY LIMITS

EXPOSURE LIMITS	SAR (W/kg)	
	(General Population / Uncontrolled Exposure Environment)	(Occupational / Controlled Exposure Environment)
Spatial Average (averaged over the whole body)	0.08	0.4
Spatial Peak (averaged over any 1g of tissue)	1.60	8.0
Spatial Peak (hands/wrists/feet/ankles averaged over 10g)	4.0	20.0

Notes:

1. Uncontrolled environments are defined as locations where there is potential exposure of individuals who have no knowledge or control of their potential exposure.
2. Controlled environments are defined as locations where there is potential exposure of individuals who have knowledge of their potential exposure and can exercise control over their exposure.

10.0 ROBOT SYSTEM SPECIFICATIONS

Specifications

POSITIONER: Stäubli Unimation Corp. Robot Model: RX60L
Repeatability: 0.02 mm
No. of axis: 6

Data Acquisition Electronic (DAE) System

Cell Controller

Processor: AMD Athlon XP 2400+
Clock Speed: 2.0 GHz
Operating System: Windows XP Professional

Data Converter

Features: Signal Amplifier, multiplexer, A/D converter, and control logic
Software: DASY4 software
Connecting Lines: Optical downlink for data and status info.
 Optical uplink for commands and clock

DASY4 Measurement Server

Function: Real-time data evaluation for field measurements and surface detection
Hardware: PC/104 166MHz Pentium CPU; 32 MB chipdisk; 64 MB RAM
Connections: COM1, COM2, DAE, Robot, Ethernet, Service Interface

E-Field Probe

Model: ET3DV6
Serial No.: 1387
Construction: Triangular core fiber optic detection system
Frequency: 10 MHz to 6 GHz
Linearity: ±0.2 dB (30 MHz to 3 GHz)

Phantom(s)

Evaluation Phantom

Type: Planar Phantom
Shell Material: Plexiglas
Bottom Thickness: 2.0 mm ± 0.1 mm
Outer Dimensions: 75.0 cm (L) x 22.5 cm (W) x 20.5 cm (H); Back Plane: 25.7 cm (H)

Validation Phantom (≤ 450MHz)

Type: Planar Phantom
Shell Material: Plexiglas
Bottom Thickness: 6.2 mm ± 0.1 mm
Outer Dimensions: 86.0 cm (L) x 39.5 cm (W) x 21.8 cm (H)

Test Report Serial No.:	082605K66-T665-S90U	Test Dates:	Sept. 01-02, 2005
Date of Report Issue:	September 15, 2005	Rev. No.:	Revision 0
Description of Test:	RF Exposure	SAR	FCC 2:1093
			IC RSS-102

11.0 PROBE SPECIFICATION (ET3DV6)

Construction:	Symmetrical design with triangular core Built-in shielding against static charges PEEK enclosure material (resistant to organic solvents, e.g. glycol)
Calibration:	In air from 10 MHz to 2.5 GHz In brain simulating tissue at frequencies of 900 MHz and 1.8 GHz (accuracy $\pm 8\%$)
Frequency:	10 MHz to > 6 GHz; Linearity: ± 0.2 dB (30 MHz to 3 GHz)
Directivity:	± 0.2 dB in brain tissue (rotation around probe axis) ± 0.4 dB in brain tissue (rotation normal to probe axis)
Dynamic Range:	5 μ W/g to > 100 mW/g; Linearity: ± 0.2 dB
Surface Detection:	± 0.2 mm repeatability in air and clear liquids over diffuse reflecting surfaces
Dimensions:	Overall length: 330 mm Tip length: 16 mm Body diameter: 12 mm Tip diameter: 6.8 mm Distance from probe tip to dipole centers: 2.7 mm
Application:	General dosimetry up to 3 GHz Compliance tests of mobile phone



ET3DV6 E-Field Probe

12.0 PLANAR PHANTOM

The planar phantom is constructed of Plexiglas material with a 2.0 mm shell thickness for face-held and body-worn SAR evaluations of portable radio transceivers. The planar phantom is mounted on the side of the DASY4 compact system table.



Plexiglas Planar Phantom

13.0 VALIDATION PLANAR PHANTOM

The validation planar phantom is constructed of Plexiglas material with a 6.0 mm shell thickness for system validations at 450MHz and below. The validation planar phantom is mounted to the table of the DASY4 compact system.



Validation Planar Phantom

14.0 DEVICE HOLDER

The DASY4 device holder has two scales for device rotation (with respect to the body axis) and the device inclination (with respect to the line between the ear openings). The plane between the ear openings and the mouth tip has a rotation angle of 65° . The bottom plate contains three pair of bolts for locking the device holder. The device holder positions are adjusted to the standard measurement positions in the three sections.



Device Holder

Applicant:	Vertex Standard Co., Ltd.	FCC ID:	K6610334721	IC ID:	511B-10334721	Freq.:	450 - 512 MHz
Model(s):	VX-P921-G7-5, VX-P924-G7-5, VX-P929-G7-5, VX-P971-G7-5, VX-P974-G7-5, VX-P979-G7-5			Portable FM UHF PTT Radio Transceiver			
2005 Celltech Labs Inc.	This document is not to be reproduced in whole or in part without the prior written permission of Celltech Labs Inc.						13 of 64

Test Report Serial No.:	082605K66-T665-S90U	Test Dates:	Sept. 01-02, 2005
Date of Report Issue:	September 15, 2005	Rev. No.:	Revision 0
Description of Test:	RF Exposure	SAR	FCC 2:1093
			IC RSS-102

15.0 TEST EQUIPMENT LIST

USED	TEST EQUIPMENT DESCRIPTION	ASSET NO.	SERIAL NO.	DATE CALIBRATED		CALIBRATION DUE DATE
x	Schmid & Partner DASY4 System	-	-	-	-	-
x	-DASY4 Measurement Server	00158	1078	N/A	N/A	N/A
x	-Robot	00046	599396-01	N/A	N/A	N/A
x	-DAE4	00019	353	15Jun05		15Jun06
	-DAE3	00018	370	25Jan05		25Jan06
x	-ET3DV6 E-Field Probe	00016	1387	18Mar05		18Mar06
	-ET3DV6 E-Field Probe	00017	1590	20May05		20May06
	-EX3DV4 E-Field Probe	00125	3547	21Jan05		21Jan06
	-300 MHz Validation Dipole	00023	135	Brain	26Oct04	26Oct05
x	-450 MHz Validation Dipole	00024	136	Brain	04Nov04	04Nov05
	-835 MHz Validation Dipole	00022	411	Brain	30Mar05	30Mar06
				Body	12Apr05	12Apr06
	-900 MHz Validation Dipole	00020	054	Brain	10Jun05	10Jun06
				Body	10Jun05	10Jun06
	-1800 MHz Validation Dipole	00021	247	Brain	14Jun05	14Jun06
				Body	14Jun05	14Jun06
	-1900 MHz Validation Dipole	00032	151	Brain	17Jun05	17Jun06
				Body	22Apr05	22Apr06
	-2450 MHz Validation Dipole	00025	150	Brain	30Sep04	30Sep05
				Body	22Apr05	22Apr06
	-5000 MHz Validation Dipole	00126	1031	Brain	11Jan05	11Jan06
				Body	11Jan05	11Jan06
	-SAM Phantom V4.0C	00154	1033	N/A		N/A
	-Barski Planar Phantom	00155	03-01	N/A		N/A
x	-Plexiglas Planar Phantom	00156	161	N/A		N/A
x	-Validation Planar Phantom	00157	137	N/A		N/A
	HP 85070C Dielectric Probe Kit	00033	N/A	N/A		N/A
x	ALS-PR-DIEL Dielectric Probe Kit	00160	260-00953	N/A		N/A
x	Gigatronics 8652A Power Meter	00110	1835801	16Apr05		16Apr06
	Gigatronics 8652A Power Meter	00008	1835267	29Apr05		29Apr06
	Gigatronics 8652A Power Meter	00007	1835272	18Oct04		18Oct05
	Gigatronics 80701A Power Sensor	00013	1833713	11Oct04		11Oct05
x	Gigatronics 80701A Power Sensor	00011	1833542	08Oct04		08Oct05
x	Gigatronics 80701A Power Sensor	00109	1834366	16Apr05		16Apr06
x	HP 8753ET Network Analyzer	00134	US39170292	04May05		04May06
x	HP 8648D Signal Generator	00005	3847A00611	29Apr05		29Apr06
	Rohde & Schwarz SMR40 Signal Generator	00006	100104	12Apr05		12Apr06
x	Amplifier Research 5S1G4 Power Amplifier	00106	26235	N/A		N/A

Applicant:	Vertex Standard Co., Ltd.	FCC ID:	K6610334721	IC ID:	511B-10334721	Freq.:	450 - 512 MHz
Model(s):	VX-P921-G7-5, VX-P924-G7-5, VX-P929-G7-5, VX-P971-G7-5, VX-P974-G7-5, VX-P979-G7-5			Portable FM UHF PTT Radio Transceiver			
2005 Celltech Labs Inc.	This document is not to be reproduced in whole or in part without the prior written permission of Celltech Labs Inc.						14 of 64

16.0 MEASUREMENT UNCERTAINTIES

UNCERTAINTY BUDGET FOR DEVICE EVALUATION						
Error Description	Uncertainty Value $\pm\%$	Probability Distribution	Divisor	c_i 1g	Uncertainty Value $\pm\%$ (1g)	V_i or V_{eff}
Measurement System						
Probe calibration	4.0	Normal	1	1	4.0	∞
Axial isotropy of the probe	4.7	Rectangular	1.732050808	0.7	1.9	∞
Spherical isotropy of the probe	9.6	Rectangular	1.732050808	0.7	3.9	∞
Spatial resolution	0	Rectangular	1.732050808	1	0.0	∞
Boundary effects	1	Rectangular	1.732050808	1	0.6	∞
Probe linearity	4.7	Rectangular	1.732050808	1	2.7	∞
Detection limit	1	Rectangular	1.732050808	1	0.6	∞
Readout electronics	0.3	Normal	1	1	0.3	∞
Response time	0.8	Rectangular	1.732050808	1	0.5	∞
Integration time	2.6	Rectangular	1.732050808	1	1.5	∞
RF ambient conditions	3	Rectangular	1.732050808	1	1.7	∞
Mech. constraints of robot	0.4	Rectangular	1.732050808	1	0.2	∞
Probe positioning	2.9	Rectangular	1.732050808	1	1.7	∞
Extrapolation & integration	1	Rectangular	1.732050808	1	0.6	∞
Test Sample Related						
Device positioning	2.9	Normal	1	1	2.9	12
Device holder uncertainty	3.6	Normal	1	1	3.6	8
Power drift	5	Rectangular	1.732050808	1	2.9	∞
Phantom and Setup						
Phantom uncertainty	4	Rectangular	1.732050808	1	2.3	∞
Liquid conductivity (target)	5	Rectangular	1.732050808	0.64	1.8	∞
Liquid conductivity (measured)	2.5	Normal	1	0.64	1.6	∞
Liquid permittivity (target)	5	Rectangular	1.732050808	0.6	1.7	∞
Liquid permittivity (measured)	2.5	Normal	1	0.6	1.5	∞
Combined Standard Uncertainty					9.88	
Expanded Uncertainty (k=2)					19.77	

Measurement Uncertainty Table in accordance with IEEE Standard 1528-2003 (see reference [5])

MEASUREMENT UNCERTAINTIES (CONT.)

UNCERTAINTY BUDGET FOR SYSTEM VALIDATION						
Error Description	Uncertainty Value ±%	Probability Distribution	Divisor	ci 1g	Uncertainty Value ±% (1g)	V _i or V _{eff}
Measurement System						
Probe calibration	4	Normal	1	1	4.0	∞
Axial isotropy of the probe	4.7	Rectangular	1.732050808	1	2.7	∞
Spherical isotropy of the probe	0	Rectangular	1.732050808	1	0.0	∞
Spatial resolution	0	Rectangular	1.732050808	1	0.0	∞
Boundary effects	1	Rectangular	1.732050808	1	0.6	∞
Probe linearity	4.7	Rectangular	1.732050808	1	2.7	∞
Detection limit	1	Rectangular	1.732050808	1	0.6	∞
Readout electronics	0.3	Normal	1	1	0.3	∞
Response time	0	Rectangular	1.732050808	1	0.0	∞
Integration time	0	Rectangular	1.732050808	1	0.0	∞
RF ambient conditions	3	Rectangular	1.732050808	1	1.7	∞
Mech. constraints of robot	0.4	Rectangular	1.732050808	1	0.2	∞
Probe positioning	2.9	Rectangular	1.732050808	1	1.7	∞
Extrapolation & integration	1	Rectangular	1.732050808	1	0.6	∞
Test Sample Related						
Dipole Positioning	2	Normal	1.732050808	1	1.2	∞
Power & Power Drift	4.7	Normal	1.732050808	1	2.7	∞
Phantom and Setup						
Phantom uncertainty	4	Rectangular	1.732050808	1	2.3	∞
Liquid conductivity (target)	5	Rectangular	1.732050808	0.64	1.8	∞
Liquid conductivity (measured)	2.5	Normal	1	0.64	1.6	∞
Liquid permittivity (target)	5	Rectangular	1.732050808	0.6	1.7	∞
Liquid permittivity (measured)	2.5	Normal	1	0.6	1.5	∞
Combined Standard Uncertainty					7.93	
Expanded Uncertainty (k=2)					15.87	

Measurement Uncertainty Table in accordance with IEEE Standard 1528-2003 (see reference [5])

Test Report Serial No.:	082605K66-T665-S90U	Test Dates:	Sept. 01-02, 2005
Date of Report Issue:	September 15, 2005	Rev. No.:	Revision 0
Description of Test:	RF Exposure	SAR	FCC 2:1093 IC RSS-102

17.0 REFERENCES

- [1] Federal Communications Commission, "Radiofrequency radiation exposure evaluation: portable devices", Rule Part 47 CFR §2.1093: 1999.
- [2] Health Canada, "Limits of Human Exposure to Radiofrequency Electromagnetic Fields in the Frequency Range from 3 kHz to 300 GHz", Safety Code 6: 1999.
- [3] Federal Communications Commission, "Evaluating Compliance with FCC Guidelines for Human Exposure to Radio frequency Electromagnetic Fields", OET Bulletin 65, Supplement C (Edition 01-01), FCC, Washington, D.C.: June 2001.
- [4] Industry Canada, "Evaluation Procedure for Mobile and Portable Radio Transmitters with respect to Health Canada's Safety Code 6 for Exposure of Humans to Radio Frequency Fields", Radio Standards Specification RSS-102 Issue 1 (Provisional): September 1999.
- [5] IEEE Std 1528-2003, "Recommended Practice for Determining the Peak Spatial-Average Specific Absorption Rate (SAR) in the Human Head from Wireless Communications Devices: Measurement Techniques": December 2003.

Applicant:	Vertex Standard Co., Ltd.	FCC ID:	K6610334721	IC ID:	511B-10334721	Freq.:	450 - 512 MHz
Model(s):	VX-P921-G7-5, VX-P924-G7-5, VX-P929-G7-5, VX-P971-G7-5, VX-P974-G7-5, VX-P979-G7-5		Portable FM UHF PTT Radio Transceiver				
2005 Celltech Labs Inc.	This document is not to be reproduced in whole or in part without the prior written permission of Celltech Labs Inc.						17 of 64

Test Report Serial No.:	082605K66-T665-S90U	Test Dates:	Sept. 01-02, 2005
Date of Report Issue:	September 15, 2005	Rev. No.:	Revision 0
Description of Test:	RF Exposure	SAR	FCC 2:1093 IC RSS-102

APPENDIX A - SAR MEASUREMENT DATA

Applicant:	Vertex Standard Co., Ltd.	FCC ID:	K6610334721	IC ID:	511B-10334721	Freq.:	450 - 512 MHz
Model(s):	VX-P921-G7-5, VX-P924-G7-5, VX-P929-G7-5, VX-P971-G7-5, VX-P974-G7-5, VX-P979-G7-5		Portable FM UHF PTT Radio Transceiver				
2005 Celltech Labs Inc.	This document is not to be reproduced in whole or in part without the prior written permission of Celltech Labs Inc.						18 of 64

Test Report Serial No.:	082605K66-T665-S90U	Test Dates:	Sept. 01-02, 2005
Date of Report Issue:	September 15, 2005	Rev. No.:	Revision 0
Description of Test:	RF Exposure	SAR	FCC 2:1093 IC RSS-102

Date Tested: 09/01/2005

Face-Held SAR - Li-ion Battery (1150mAh) - Whip Antenna (P/N: ATU-6D) - Mid Channel

DUT: Vertex Model: VX-924-G7-5; Type: Portable FM UHF PTT Radio Transceiver; Serial: 5J000003

Ambient Temp: 24.5 °C; Fluid Temp: 23.1 °C; Barometric Pressure: 101.7 kPa; Humidity: 34%

Communication System: FM UHF
 Frequency: 480 MHz; Duty Cycle: 1:1
 RF Output Power: 36.68 dBm (Conducted)
 7.4V 1150mAh Li-ion Battery Pack (P/N: FNB-V86LI)
 Medium: HSL450 ($\sigma = 0.86$ mho/m; $\epsilon_r = 43.4$; $\rho = 1000$ kg/m³)

- Probe: ET3DV6 - SN1387; ConvF(7.5, 7.5, 7.5); Calibrated: 18/03/2005
- Sensor-Surface: 4mm (Mechanical Surface Detection)
- Electronics: DAE4 Sn353; Calibrated: 15/06/2005
- Phantom: Planar; Type: Plexiglas; Serial: 161
- Measurement SW: DASY4, V4.5 Build 19; Postprocessing SW: SEMCAD, V1.8 Build 146

Face-Held - 2.5 cm Separation Distance - Mid Channel/Area Scan (8x21x1):

Measurement grid: dx=15mm, dy=15mm

Face-Held - 2.5 cm Separation Distance - Mid Channel/Zoom Scan (5x5x7)/Cube 0:

Measurement grid: dx=7.5mm, dy=7.5mm, dz=5mm
 Reference Value = 58.1 V/m; Power Drift = -0.367 dB
 Peak SAR (extrapolated) = 4.30 W/kg
SAR(1 g) = 2.76 mW/g; SAR(10 g) = 1.98 mW/g

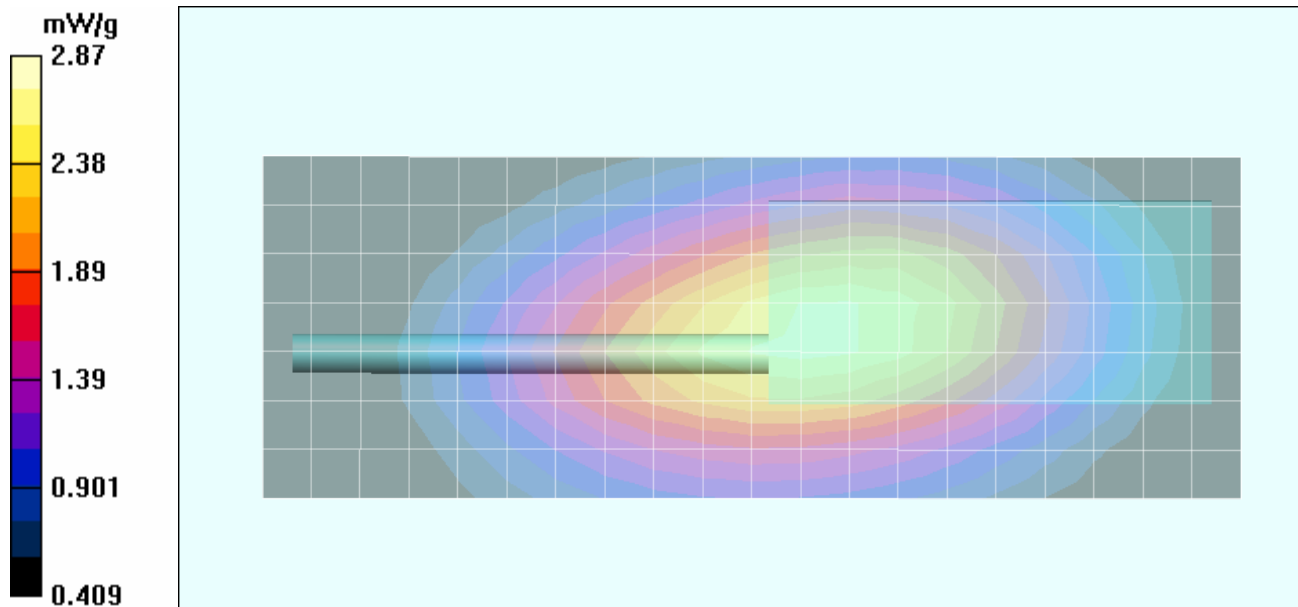

Applicant:	Vertex Standard Co., Ltd.	FCC ID:	K6610334721	IC ID:	511B-10334721	Freq.:	450 - 512 MHz
Model(s):	VX-P921-G7-5, VX-P924-G7-5, VX-P929-G7-5, VX-P971-G7-5, VX-P974-G7-5, VX-P979-G7-5			Portable FM UHF PTT Radio Transceiver			
2005 Celltech Labs Inc.	This document is not to be reproduced in whole or in part without the prior written permission of Celltech Labs Inc.						19 of 64

Test Report Serial No.:	082605K66-T665-S90U	Test Dates:	Sept. 01-02, 2005
Date of Report Issue:	September 15, 2005	Rev. No.:	Revision 0
Description of Test:	RF Exposure	SAR	FCC 2:1093 IC RSS-102

Date Tested: 09/01/2005

Face-Held SAR - Li-ion Battery (2000mAh) - Whip Antenna (P/N: ATU-6D) - Mid Channel

DUT: Vertex Model: VX-924-G7-5; Type: Portable FM UHF PTT Radio Transceiver; Serial: 5J000003

Ambient Temp: 24.5 °C; Fluid Temp: 23.1 °C; Barometric Pressure: 101.7 kPa; Humidity: 34%

Communication System: FM UHF
 Frequency: 480 MHz; Duty Cycle: 1:1
 RF Output Power: 36.70 dBm (Conducted)
 7.4V 2000mAh Li-ion Battery Pack (P/N: FNB-V87LI)
 Medium: HSL450 ($\sigma = 0.86$ mho/m; $\epsilon_r = 43.4$; $\rho = 1000$ kg/m³)

- Probe: ET3DV6 - SN1387; ConvF(7.5, 7.5, 7.5); Calibrated: 18/03/2005
- Sensor-Surface: 4mm (Mechanical Surface Detection)
- Electronics: DAE4 Sn353; Calibrated: 15/06/2005
- Phantom: Planar; Type: Plexiglas; Serial: 161
- Measurement SW: DASY4, V4.5 Build 19; Postprocessing SW: SEMCAD, V1.8 Build 146

Face-Held - 2.5 cm Separation Distance - Mid Channel/Area Scan (8x21x1):

Measurement grid: dx=15mm, dy=15mm

Face-Held - 2.5 cm Separation Distance - Mid Channel/Zoom Scan (5x5x7)/Cube 0:

Measurement grid: dx=7.5mm, dy=7.5mm, dz=5mm
 Reference Value = 59.2 V/m; Power Drift = -0.330 dB
 Peak SAR (extrapolated) = 4.56 W/kg
SAR(1 g) = 2.92 mW/g; SAR(10 g) = 2.09 mW/g

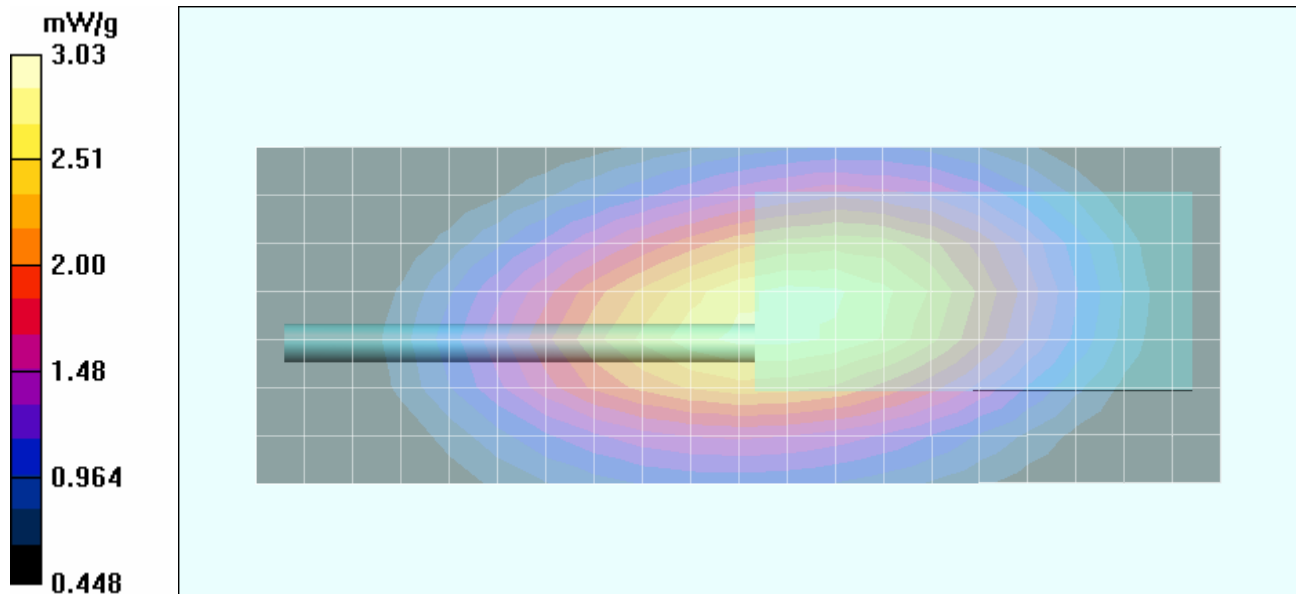

Applicant:	Vertex Standard Co., Ltd.	FCC ID:	K6610334721	IC ID:	511B-10334721	Freq.:	450 - 512 MHz
Model(s):	VX-P921-G7-5, VX-P924-G7-5, VX-P929-G7-5, VX-P971-G7-5, VX-P974-G7-5, VX-P979-G7-5		Portable FM UHF PTT Radio Transceiver				
2005 Celltech Labs Inc.	This document is not to be reproduced in whole or in part without the prior written permission of Celltech Labs Inc.					20 of 64	

Z-Axis Scan

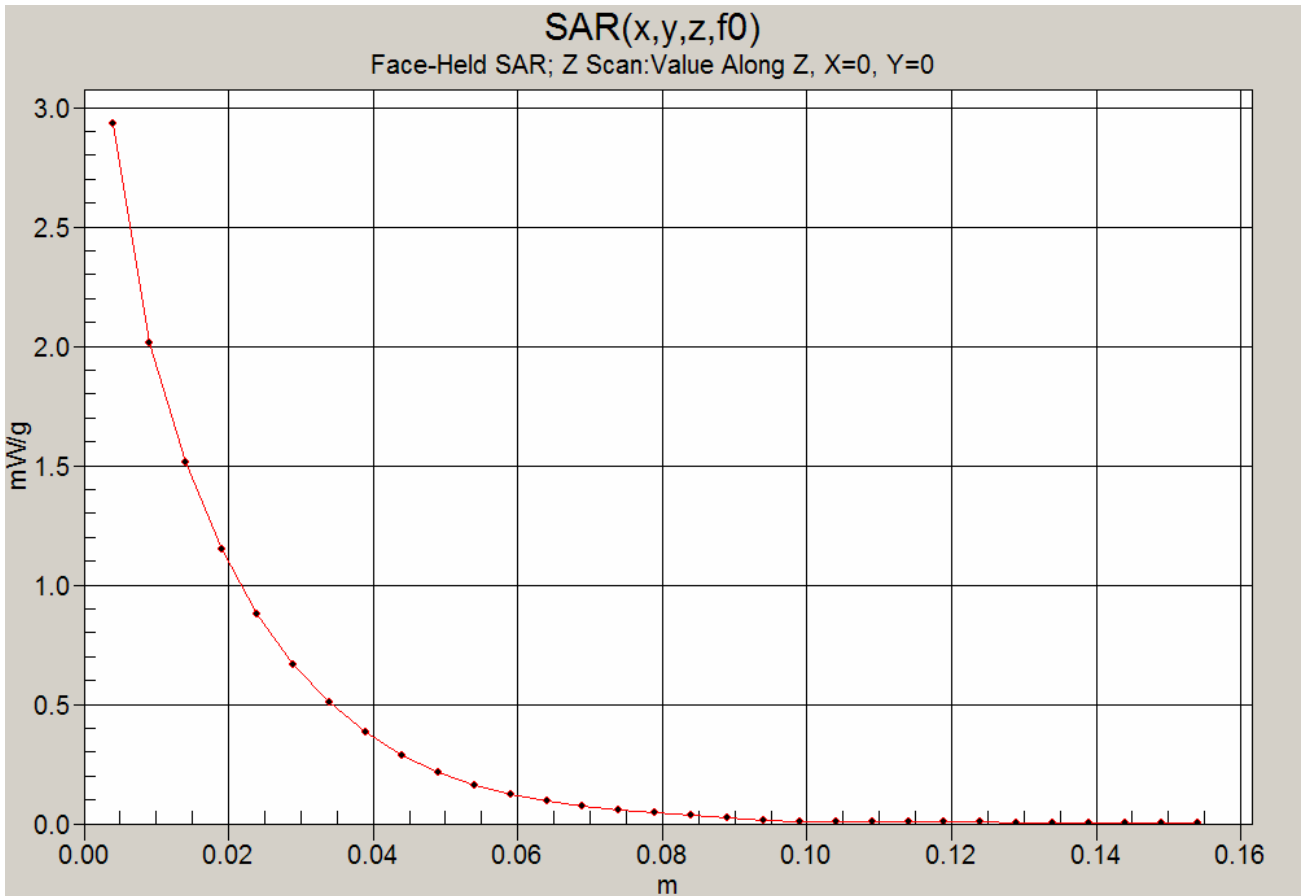

Test Report Serial No.:	082605K66-T665-S90U	Test Dates:	Sept. 01-02, 2005
Date of Report Issue:	September 15, 2005	Rev. No.:	Revision 0
Description of Test:	RF Exposure	SAR	FCC 2:1093 IC RSS-102

Date Tested: 09/01/2005

Face-Held SAR - Alkaline Battery Case (Duracell Procell) - Whip Antenna (P/N: ATU-6D) - Mid Channel

DUT: Vertex Model: VX-924-G7-5; Type: Portable FM UHF PTT Radio Transceiver; Serial: 5J000003

Ambient Temp: 24.5 °C; Fluid Temp: 23.1 °C; Barometric Pressure: 101.7 kPa; Humidity: 34%

Communication System: FM UHF
 Frequency: 480 MHz; Duty Cycle: 1:1
 RF Output Power: 36.66 dBm (Conducted)
 9V AA Duracell Procell Alkaline Battery Pack (P/N: FBA-34)
 Medium: HSL450 ($\sigma = 0.86 \text{ mho/m}$; $\epsilon_r = 43.4$; $\rho = 1000 \text{ kg/m}^3$)

- Probe: ET3DV6 - SN1387; ConvF(7.5, 7.5, 7.5); Calibrated: 18/03/2005
- Sensor-Surface: 4mm (Mechanical Surface Detection)
- Electronics: DAE4 Sn353; Calibrated: 15/06/2005
- Phantom: Planar; Type: Plexiglas; Serial: 161
- Measurement SW: DASy4, V4.5 Build 19; Postprocessing SW: SEMCAD, V1.8 Build 146

Face-Held - 2.5 cm Separation Distance - Mid Channel/Area Scan (8x21x1):

Measurement grid: dx=15mm, dy=15mm

Face-Held - 2.5 cm Separation Distance - Mid Channel/Zoom Scan (5x5x7)/Cube 0:

Measurement grid: dx=7.5mm, dy=7.5mm, dz=5mm
 Reference Value = 59.6 V/m; Power Drift = -1.13 dB
 Peak SAR (extrapolated) = 3.90 W/kg
SAR(1 g) = 2.41 mW/g; SAR(10 g) = 1.72 mW/g

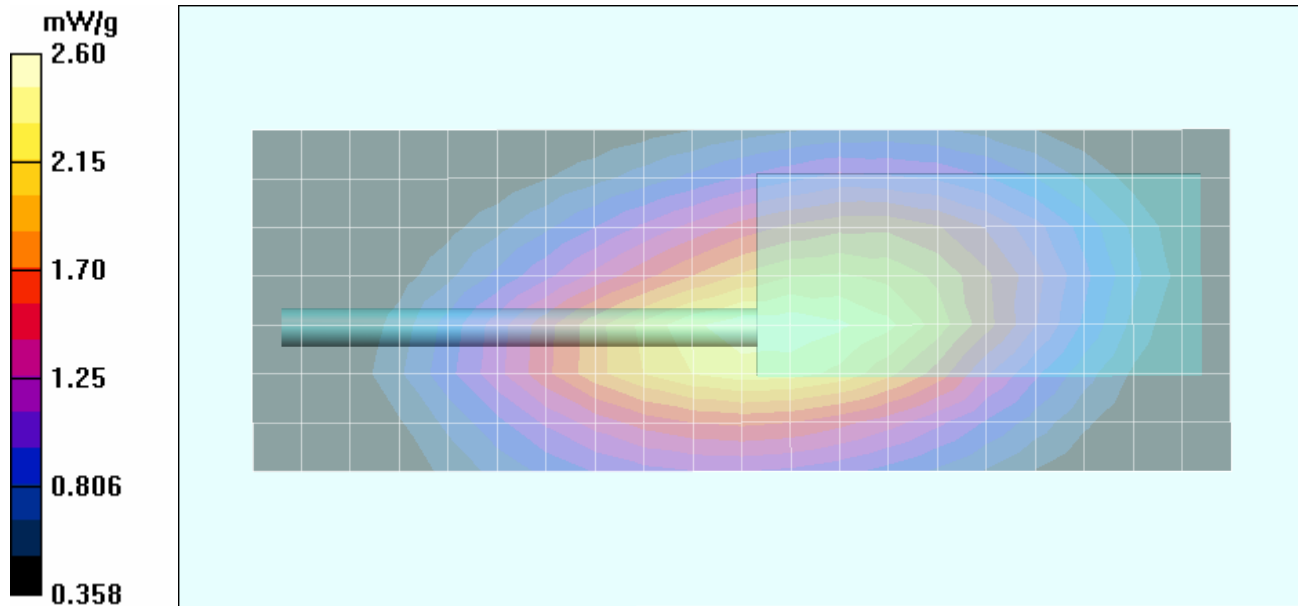

Applicant:	Vertex Standard Co., Ltd.	FCC ID:	K6610334721	IC ID:	511B-10334721	Freq.:	450 - 512 MHz
Model(s):	VX-P921-G7-5, VX-P924-G7-5, VX-P929-G7-5, VX-P971-G7-5, VX-P974-G7-5, VX-P979-G7-5		Portable FM UHF PTT Radio Transceiver				
2005 Celltech Labs Inc.	This document is not to be reproduced in whole or in part without the prior written permission of Celltech Labs Inc.						22 of 64

Test Report Serial No.:	082605K66-T665-S90U	Test Dates:	Sept. 01-02, 2005
Date of Report Issue:	September 15, 2005	Rev. No.:	Revision 0
Description of Test:	RF Exposure	SAR	FCC 2:1093 IC RSS-102

Date Tested: 09/01/2005

Face-Held SAR - Li-ion Battery (2000mAh) - Whip Antenna (P/N: ATU-6F) - High Channel

DUT: Vertex Model: VX-924-G7-5; Type: Portable FM UHF PTT Radio Transceiver; Serial: 5J000003

Ambient Temp: 24.5 °C; Fluid Temp: 23.1 °C; Barometric Pressure: 101.7 kPa; Humidity: 34%

Communication System: FM UHF
 Frequency: 512 MHz; Duty Cycle: 1:1
 RF Output Power: 36.45 dBm (Conducted)
 7.4V 2000mAh Li-ion Battery Pack (P/N: FNB-V87LI)
 Medium: HSL450 ($\sigma = 0.86$ mho/m; $\epsilon_r = 43.4$; $\rho = 1000$ kg/m³)

- Probe: ET3DV6 - SN1387; ConvF(7.5, 7.5, 7.5); Calibrated: 18/03/2005
- Sensor-Surface: 4mm (Mechanical Surface Detection)
- Electronics: DAE4 Sn353; Calibrated: 15/06/2005
- Phantom: Planar; Type: Plexiglas; Serial: 161
- Measurement SW: DASy4, V4.5 Build 19; Postprocessing SW: SEMCAD, V1.8 Build 146

Face-Held - 2.5 cm Separation Distance - High Channel/Area Scan (8x21x1):

Measurement grid: dx=15mm, dy=15mm

Face-Held - 2.5 cm Separation Distance - High Channel/Zoom Scan (5x5x7)/Cube 0:

Measurement grid: dx=7.5mm, dy=7.5mm, dz=5mm
 Reference Value = 54.6 V/m; Power Drift = -0.376 dB
 Peak SAR (extrapolated) = 4.04 W/kg
SAR(1 g) = 2.60 mW/g; SAR(10 g) = 1.86 mW/g

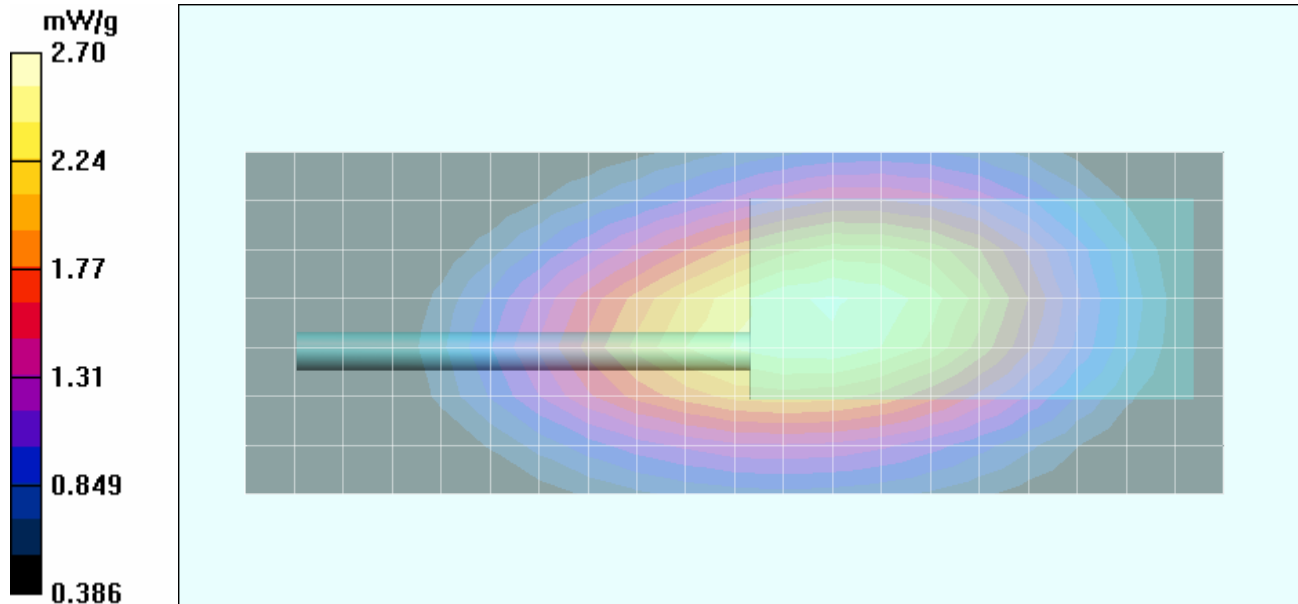

Applicant:	Vertex Standard Co., Ltd.	FCC ID:	K6610334721	IC ID:	511B-10334721	Freq.:	450 - 512 MHz
Model(s):	VX-P921-G7-5, VX-P924-G7-5, VX-P929-G7-5, VX-P971-G7-5, VX-P974-G7-5, VX-P979-G7-5		Portable FM UHF PTT Radio Transceiver				
2005 Celltech Labs Inc.	This document is not to be reproduced in whole or in part without the prior written permission of Celltech Labs Inc.						23 of 64

Test Report Serial No.:	082605K66-T665-S90U	Test Dates:	Sept. 01-02, 2005
Date of Report Issue:	September 15, 2005	Rev. No.:	Revision 0
Description of Test:	RF Exposure	SAR	FCC 2:1093
			IC RSS-102

Date Tested: 09/02/2005

Body-Worn SAR - Li-ion Battery (1150mAh) - Whip Antenna (P/N: ATU-6D) - Mid Channel

DUT: Vertex Model: VX-924-G7-5; Type: Portable FM UHF PTT Radio Transceiver; Serial: 5J000003

Body-Worn Accessory: Belt-Clip (P/N: CLIP-920); Audio Accessory: Speaker-Microphone (P/N: MH-65B7A)

Ambient Temp: 24.2 °C; Fluid Temp: 22.6 °C; Barometric Pressure: 101.5 kPa; Humidity: 42%

Communication System: FM UHF
 Frequency: 480 MHz; Duty Cycle: 1:1
 RF Output Power: 36.74 dBm (Conducted)
 7.4V 1150mAh Li-ion Battery Pack (P/N: FNB-V86LI)
 Medium: M450 ($\sigma = 0.96 \text{ mho/m}$; $\epsilon_r = 56.8$; $\rho = 1000 \text{ kg/m}^3$)

- Probe: ET3DV6 - SN1387; ConvF(7.5, 7.5, 7.5); Calibrated: 18/03/2005
- Sensor-Surface: 4mm (Mechanical Surface Detection)
- Electronics: DAE4 Sn353; Calibrated: 15/06/2005
- Phantom: Planar; Type: Plexiglas; Serial: 161
- Measurement SW: DASY4, V4.5 Build 19; Postprocessing SW: SEMCAD, V1.8 Build 146

Body-Worn - 1.2 cm Belt-Clip Separation Distance - Mid Channel/Area Scan (8x21x1):
 Measurement grid: dx=15mm, dy=15mm

Body-Worn - 1.2 cm Belt-Clip Separation Distance - Mid Channel/Zoom Scan (5x5x7)/Cube 0:
 Measurement grid: dx=7.5mm, dy=7.5mm, dz=5mm
 Reference Value = 82.2 V/m; Power Drift = -0.428 dB
 Peak SAR (extrapolated) = 9.92 W/kg
SAR(1 g) = 6.19 mW/g; SAR(10 g) = 4.27 mW/g

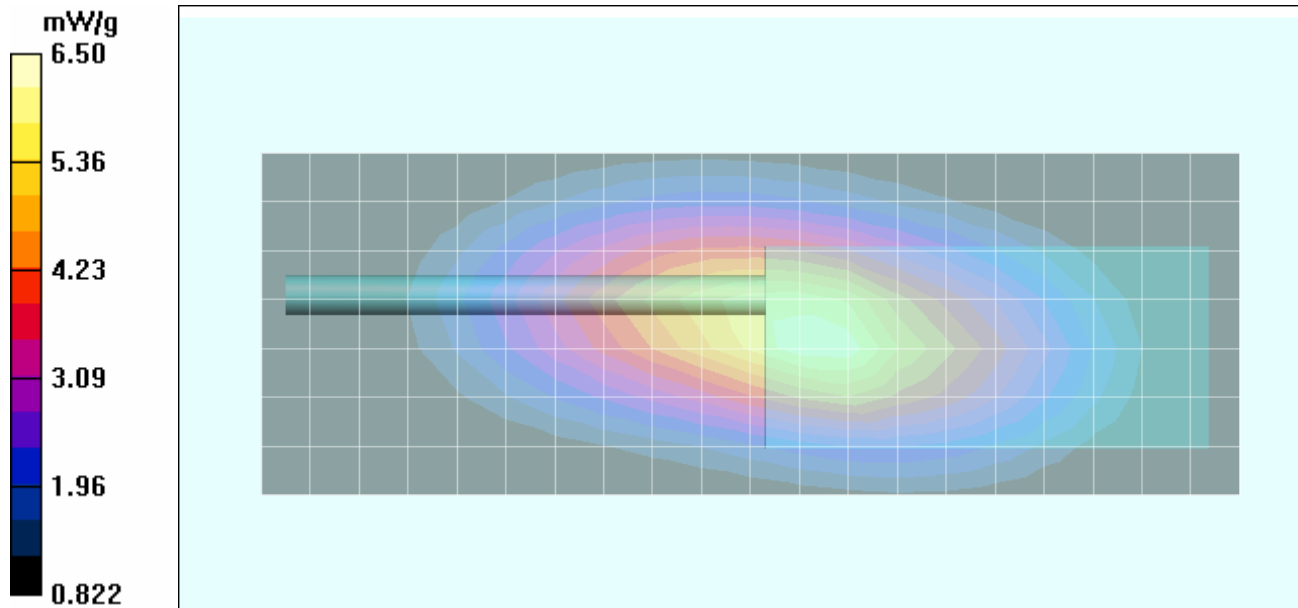

Applicant:	Vertex Standard Co., Ltd.	FCC ID:	K6610334721	IC ID:	511B-10334721	Freq.:	450 - 512 MHz
Model(s):	VX-P921-G7-5, VX-P924-G7-5, VX-P929-G7-5, VX-P971-G7-5, VX-P974-G7-5, VX-P979-G7-5		Portable FM UHF PTT Radio Transceiver				
2005 Celltech Labs Inc.	This document is not to be reproduced in whole or in part without the prior written permission of Celltech Labs Inc.						24 of 64

Z-Axis Scan

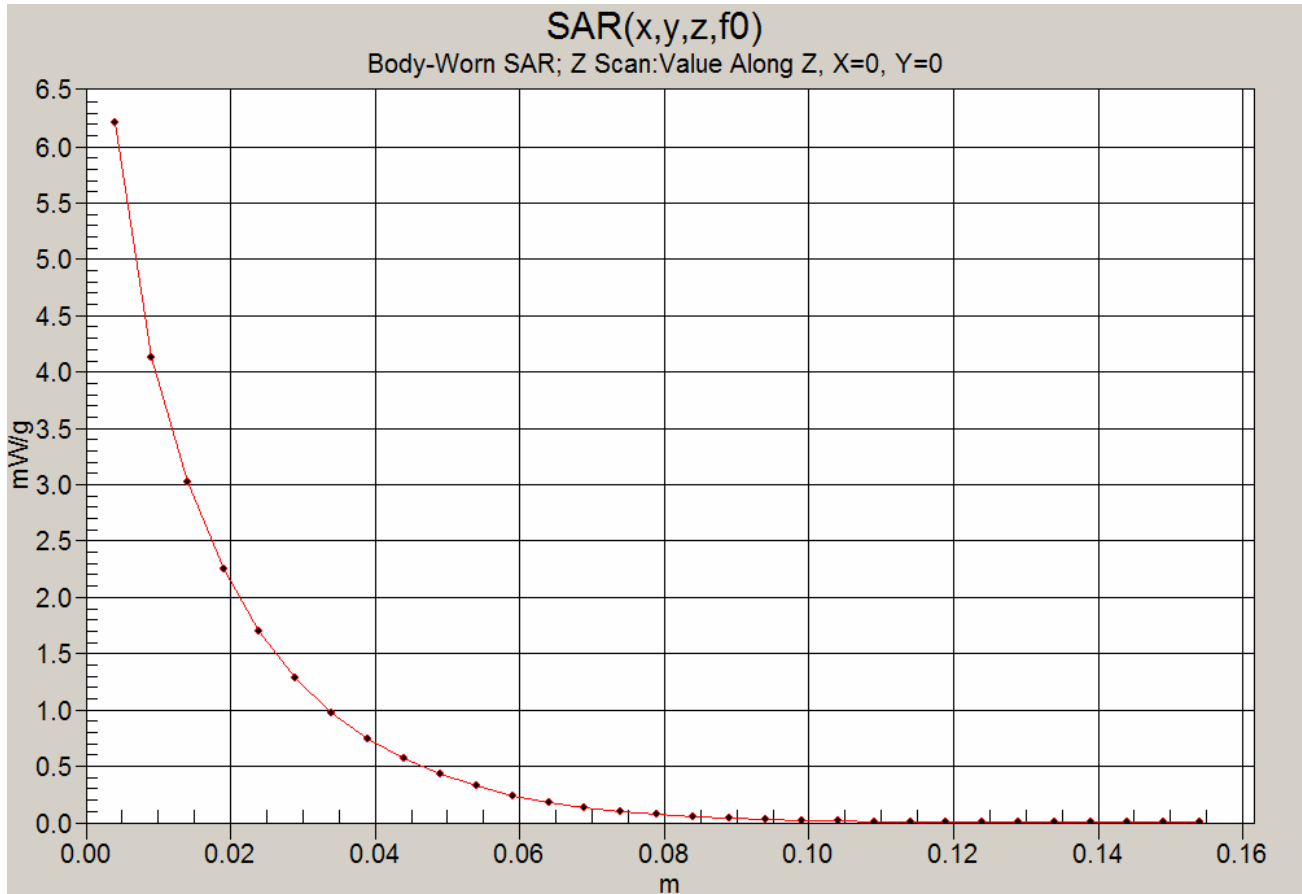

Test Report Serial No.:	082605K66-T665-S90U	Test Dates:	Sept. 01-02, 2005
Date of Report Issue:	September 15, 2005	Rev. No.:	Revision 0
Description of Test:	RF Exposure	SAR	FCC 2:1093 IC RSS-102

Date Tested: 09/02/2005

Body-Worn SAR - Li-ion Battery (2000mAh) - Whip Antenna (P/N: ATU-6D) - Mid Channel

DUT: Vertex Model: VX-924-G7-5; Type: Portable FM UHF PTT Radio Transceiver; Serial: 5J000003

Body-Worn Accessory: Belt-Clip (P/N: CLIP-920); Audio Accessory: Speaker-Microphone (P/N: MH-65B7A)

Ambient Temp: 24.2 °C; Fluid Temp: 22.6 °C; Barometric Pressure: 101.5 kPa; Humidity: 42%

Communication System: FM UHF
 Frequency: 480 MHz; Duty Cycle: 1:1
 RF Output Power: 36.60 dBm (Conducted)
 7.4V 2000mAh Li-ion Battery Pack (P/N: FNB-V87LI)
 Medium: M450 ($\sigma = 0.96 \text{ mho/m}$; $\epsilon_r = 56.8$; $\rho = 1000 \text{ kg/m}^3$)

- Probe: ET3DV6 - SN1387; ConvF(7.5, 7.5, 7.5); Calibrated: 18/03/2005
- Sensor-Surface: 4mm (Mechanical Surface Detection)
- Electronics: DAE4 Sn353; Calibrated: 15/06/2005
- Phantom: Planar; Type: Plexiglas; Serial: 161
- Measurement SW: DASY4, V4.5 Build 19; Postprocessing SW: SEMCAD, V1.8 Build 146

Body-Worn - 1.0 cm Belt-Clip Separation Distance - Mid Channel/Area Scan (8x21x1):
 Measurement grid: dx=15mm, dy=15mm

Body-Worn - 1.0 cm Belt-Clip Separation Distance - Mid Channel/Zoom Scan (5x5x7)/Cube 0:
 Measurement grid: dx=7.5mm, dy=7.5mm, dz=5mm
 Reference Value = 78.8 V/m; Power Drift = -0.363 dB
 Peak SAR (extrapolated) = 9.65 W/kg
SAR(1 g) = 6.02 mW/g; SAR(10 g) = 4.17 mW/g

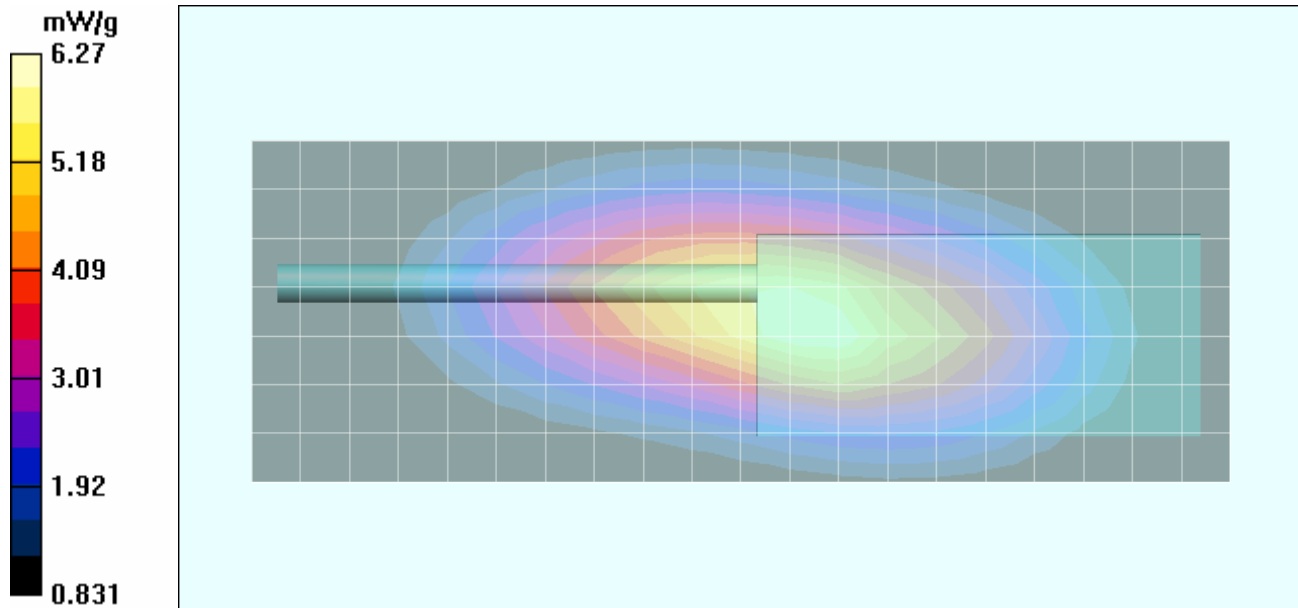

Applicant:	Vertex Standard Co., Ltd.	FCC ID:	K6610334721	IC ID:	511B-10334721	Freq.:	450 - 512 MHz
Model(s):	VX-P921-G7-5, VX-P924-G7-5, VX-P929-G7-5, VX-P971-G7-5, VX-P974-G7-5, VX-P979-G7-5		Portable FM UHF PTT Radio Transceiver				
2005 Celltech Labs Inc.	This document is not to be reproduced in whole or in part without the prior written permission of Celltech Labs Inc.						26 of 64

Test Report Serial No.:	082605K66-T665-S90U	Test Dates:	Sept. 01-02, 2005
Date of Report Issue:	September 15, 2005	Rev. No.:	Revision 0
Description of Test:	RF Exposure	SAR	FCC 2:1093 IC RSS-102

Date Tested: 09/02/2005

Body-Worn SAR - Alkaline Battery Pack (Duracell Procell) - Whip Antenna (P/N: ATU-6D) - Mid Channel

DUT: Vertex Model: VX-924-G7-5; Type: Portable FM UHF PTT Radio Transceiver; Serial: 5J000003

Body-Worn Accessory: Belt-Clip (P/N: CLIP-920); Audio Accessory: Speaker-Microphone (P/N: MH-65B7A)

Ambient Temp: 24.2 °C; Fluid Temp: 22.6 °C; Barometric Pressure: 101.5 kPa; Humidity: 42%

Communication System: FM UHF
 Frequency: 480 MHz; Duty Cycle: 1:1
 RF Output Power: 36.47 dBm (Conducted)
 9V AA Duracell Procell Alkaline Battery Pack (P/N: FBA-34)
 Medium: M450 ($\sigma = 0.96 \text{ mho/m}$; $\epsilon_r = 56.8$; $\rho = 1000 \text{ kg/m}^3$)

- Probe: ET3DV6 - SN1387; ConvF(7.5, 7.5, 7.5); Calibrated: 18/03/2005
- Sensor-Surface: 4mm (Mechanical Surface Detection)
- Electronics: DAE4 Sn353; Calibrated: 15/06/2005
- Phantom: Planar; Type: Plexiglas; Serial: 161
- Measurement SW: DASY4, V4.5 Build 19; Postprocessing SW: SEMCAD, V1.8 Build 146

Body-Worn - 0.6 cm Belt-Clip Separation Distance - Mid Channel/Area Scan (8x21x1):
 Measurement grid: dx=15mm, dy=15mm

Body-Worn - 0.6 cm Belt-Clip Separation Distance - Mid Channel/Zoom Scan (5x5x7)/Cube 0:
 Measurement grid: dx=7.5mm, dy=7.5mm, dz=5mm
 Reference Value = 77.1 V/m; Power Drift = -1.07 dB
 Peak SAR (extrapolated) = 8.12 W/kg
SAR(1 g) = 4.99 mW/g; SAR(10 g) = 3.42 mW/g

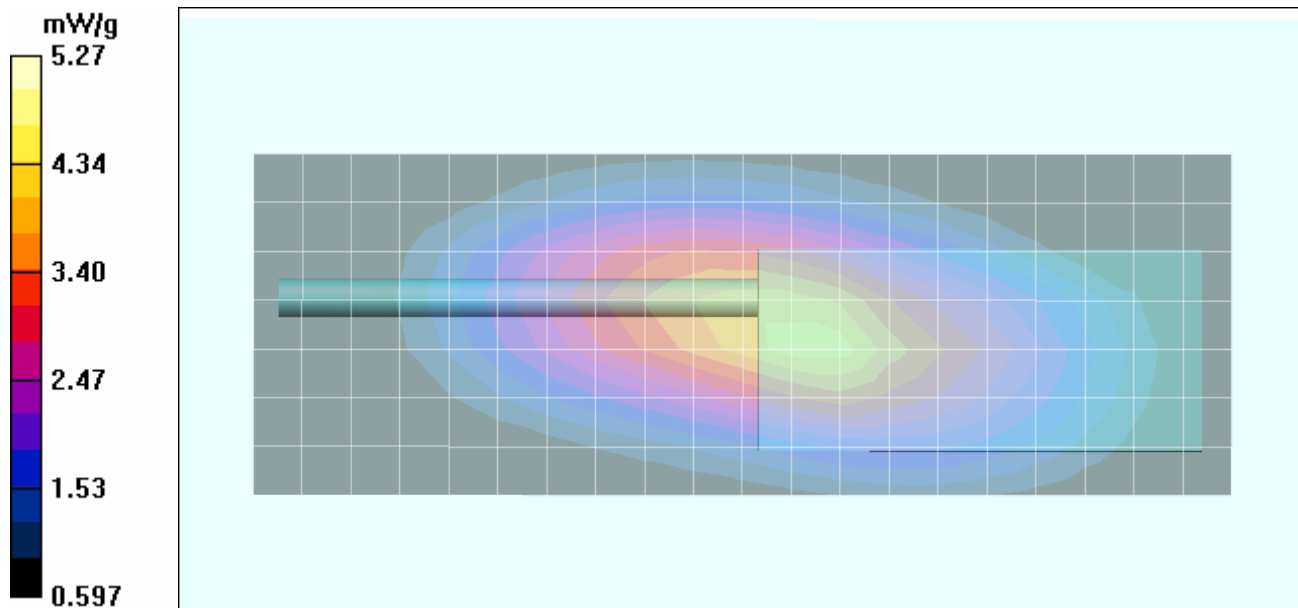

Applicant:	Vertex Standard Co., Ltd.	FCC ID:	K6610334721	IC ID:	511B-10334721	Freq.:	450 - 512 MHz
Model(s):	VX-P921-G7-5, VX-P924-G7-5, VX-P929-G7-5, VX-P971-G7-5, VX-P974-G7-5, VX-P979-G7-5		Portable FM UHF PTT Radio Transceiver				
2005 Celltech Labs Inc.	This document is not to be reproduced in whole or in part without the prior written permission of Celltech Labs Inc.						27 of 64

SAR-versus-Time Power Droop Evaluation

Body-Worn Configuration
 Alkaline Battery Pack (P/N: FBA-34)
 Whip Antenna (P/N: ATU-6D)
 Mid Channel - 480 MHz

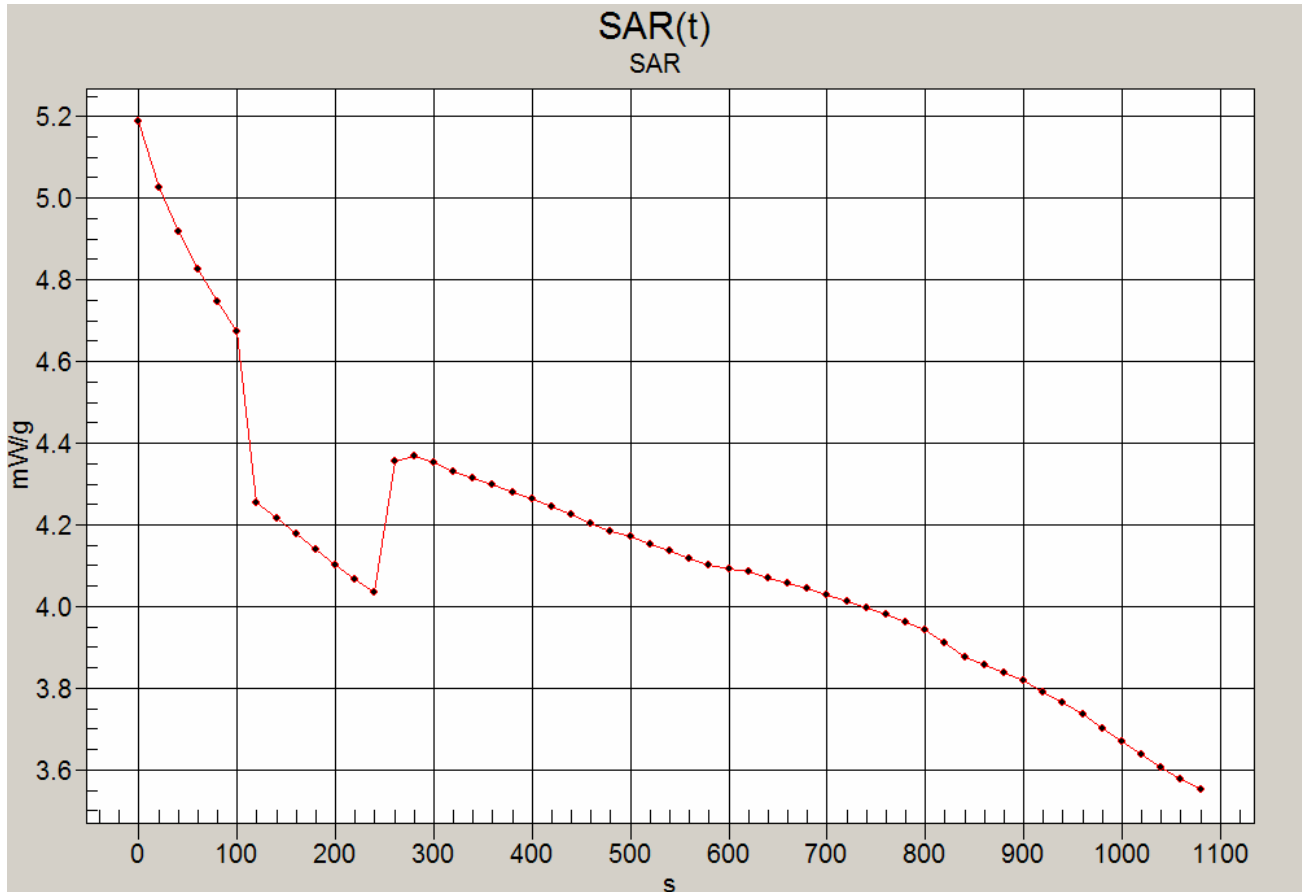

High SAR: 5.18739 mW/g
 Low SAR: 3.55269 mW/g (-1.6439 dB)
 SAR after 340s: 4.31516 mW/g (-0.7995 dB)
 SAR after 240s: 4.03368 mW/g (-1.0925 dB)
 (340s = Zoom Scan Duration)
 (1080s = Area Scan Duration)

Test Report Serial No.:	082605K66-T665-S90U	Test Dates:	Sept. 01-02, 2005
Date of Report Issue:	September 15, 2005	Rev. No.:	Revision 0
Description of Test:	RF Exposure	SAR	FCC 2:1093 IC RSS-102

Date Tested: 09/02/2005

Body-Worn SAR - Li-ion Battery (1150mAh) - Whip Antenna (P/N: ATU-6F) - High Channel

DUT: Vertex Model: VX-924-G7-5; Type: Portable FM UHF PTT Radio Transceiver; Serial: 5J000003

Body-Worn Accessory: Belt-Clip (P/N: CLIP-920); Audio Accessory: Speaker-Microphone (P/N: MH-65B7A)

Ambient Temp: 24.2 °C; Fluid Temp: 22.6 °C; Barometric Pressure: 101.5 kPa; Humidity: 42%

Communication System: FM UHF
 Frequency: 512 MHz; Duty Cycle: 1:1
 RF Output Power: 36.27 dBm (Conducted)
 7.4V 1150mAh Li-ion Battery Pack (P/N: FNB-V86LI)
 Medium: M450 ($\sigma = 0.96 \text{ mho/m}$; $\epsilon_r = 56.8$; $\rho = 1000 \text{ kg/m}^3$)

- Probe: ET3DV6 - SN1387; ConvF(7.5, 7.5, 7.5); Calibrated: 18/03/2005
- Sensor-Surface: 4mm (Mechanical Surface Detection)
- Electronics: DAE4 Sn353; Calibrated: 15/06/2005
- Phantom: Planar; Type: Plexiglas; Serial: 161
- Measurement SW: DASY4, V4.5 Build 19; Postprocessing SW: SEMCAD, V1.8 Build 146

Body-Worn - 1.2 cm Belt-Clip Separation Distance - High Channel/Area Scan (8x21x1):
 Measurement grid: dx=15mm, dy=15mm

Body-Worn - 1.2 cm Belt-Clip Separation Distance - High Channel/Zoom Scan (5x5x7)/Cube 0:
 Measurement grid: dx=7.5mm, dy=7.5mm, dz=5mm
 Reference Value = 72.1 V/m; Power Drift = -0.407 dB
 Peak SAR (extrapolated) = 8.16 W/kg
SAR(1 g) = 5.04 mW/g; SAR(10 g) = 3.46 mW/g

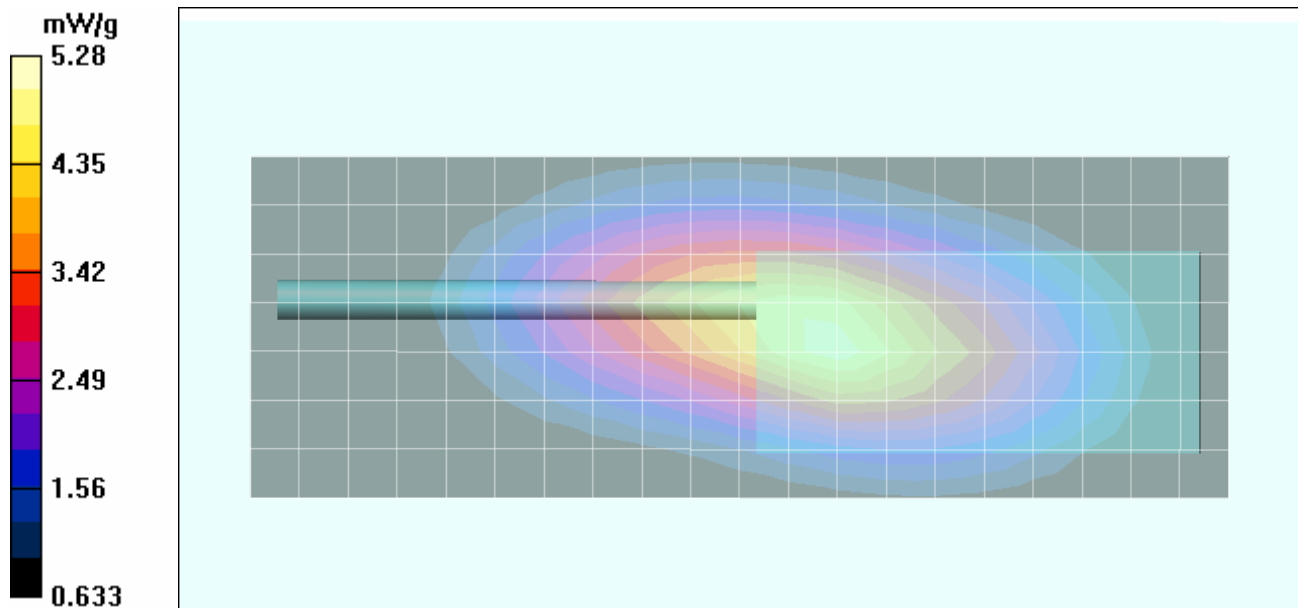

Applicant:	Vertex Standard Co., Ltd.	FCC ID:	K6610334721	IC ID:	511B-10334721	Freq.:	450 - 512 MHz
Model(s):	VX-P921-G7-5, VX-P924-G7-5, VX-P929-G7-5, VX-P971-G7-5, VX-P974-G7-5, VX-P979-G7-5		Portable FM UHF PTT Radio Transceiver				
2005 Celltech Labs Inc.	This document is not to be reproduced in whole or in part without the prior written permission of Celltech Labs Inc.						29 of 64

Test Report Serial No.:	082605K66-T665-S90U	Test Dates:	Sept. 01-02, 2005
Date of Report Issue:	September 15, 2005	Rev. No.:	Revision 0
Description of Test:	RF Exposure	SAR	FCC 2:1093 IC RSS-102

Date Tested: 09/02/2005

Body-Worn SAR - Li-ion Battery (1150mAh) - Whip Antenna (P/N: ATU-6D) - Mid Channel

DUT: Vertex Model: VX-924-G7-5; Type: Portable FM UHF PTT Radio Transceiver; Serial: 5J000003

Body-Worn Accessory: Leather Case with Detachable Swivel Belt-Loop (P/N: LCC-920S)
Audio Accessory: Speaker-Microphone (P/N: MH-65B7A)

Ambient Temp: 24.2 °C; Fluid Temp: 22.6 °C; Barometric Pressure: 101.5 kPa; Humidity: 42%

Communication System: FM UHF
Frequency: 480 MHz; Duty Cycle: 1:1
RF Output Power: 36.64 dBm (Conducted)
7.4V 1150mAh Li-ion Battery Pack (P/N: FNB-V86LI)
Medium: M450 ($\sigma = 0.96$ mho/m; $\epsilon_r = 56.8$; $\rho = 1000$ kg/m³)

- Probe: ET3DV6 - SN1387; ConvF(7.5, 7.5, 7.5); Calibrated: 18/03/2005
- Sensor-Surface: 4mm (Mechanical Surface Detection)
- Electronics: DAE4 Sn353; Calibrated: 15/06/2005
- Phantom: Planar; Type: Plexiglas; Serial: 161
- Measurement SW: DASY4, V4.5 Build 19; Postprocessing SW: SEMCAD, V1.8 Build 146

Body-Worn - 4.7 cm Leather Case & Swivel Belt-Loop Separation Distance - Mid Channel
Area Scan (8x21x1): Measurement grid: dx=15mm, dy=15mm

Body-Worn - 4.7 cm Leather Case & Swivel Belt-Loop Separation Distance - Mid Channel
Zoom Scan (5x5x7)/Cube 0: Measurement grid: dx=7.5mm, dy=7.5mm, dz=5mm
Reference Value = 35.4 V/m; Power Drift = -0.367 dB
Peak SAR (extrapolated) = 1.89 W/kg
SAR(1 g) = 1.25 mW/g; SAR(10 g) = 0.908 mW/g

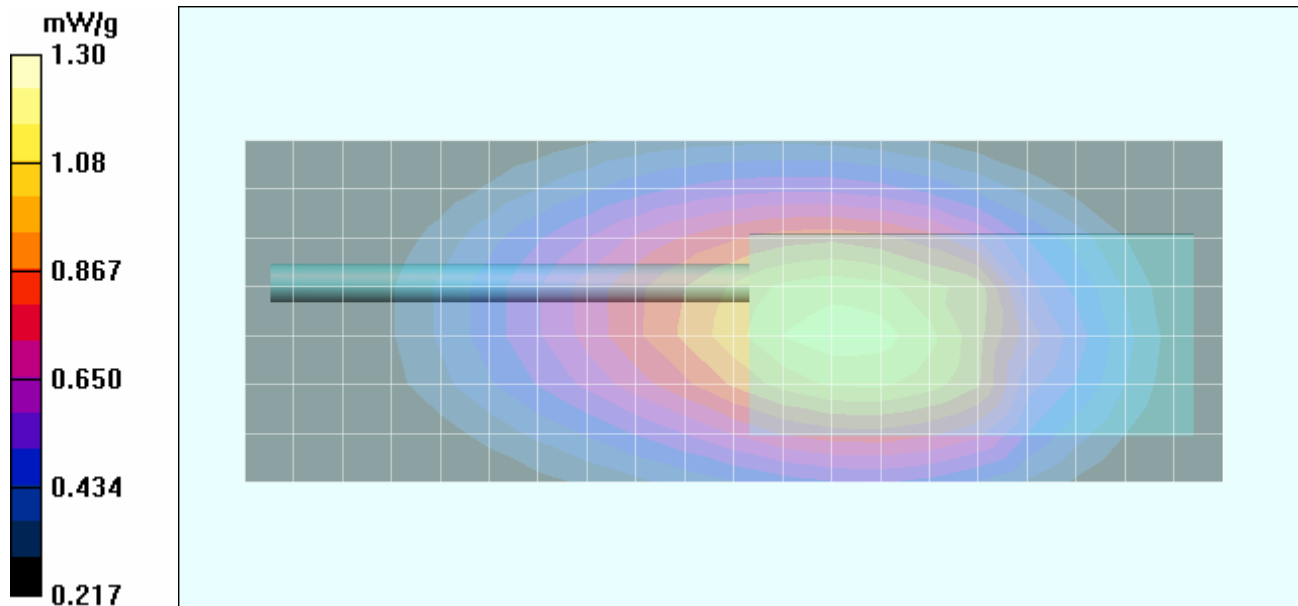

Applicant:	Vertex Standard Co., Ltd.	FCC ID:	K6610334721	IC ID:	511B-10334721	Freq.:	450 - 512 MHz	
Model(s):	VX-P921-G7-5, VX-P924-G7-5, VX-P929-G7-5, VX-P971-G7-5, VX-P974-G7-5, VX-P979-G7-5		Portable FM UHF PTT Radio Transceiver					
2005 Celltech Labs Inc.		This document is not to be reproduced in whole or in part without the prior written permission of Celltech Labs Inc.					30 of 64	

Test Report Serial No.:	082605K66-T665-S90U	Test Dates:	Sept. 01-02, 2005
Date of Report Issue:	September 15, 2005	Rev. No.:	Revision 0
Description of Test:	RF Exposure	SAR	FCC 2:1093 IC RSS-102

Date Tested: 09/02/2005

Body-Worn SAR - Li-ion Battery (1150mAh) - Whip Antenna (P/N: ATU-6D) - Mid Channel

DUT: Vertex Model: VX-924-G7-5; Type: Portable FM UHF PTT Radio Transceiver; Serial: 5J000003

Body-Worn Accessory: Leather Case with Belt-Loop (P/N: LCC-920)
Audio Accessory: Speaker-Microphone (P/N: MH-65B7A)

Ambient Temp: 24.2 °C; Fluid Temp: 22.6 °C; Barometric Pressure: 101.5 kPa; Humidity: 42%

Communication System: FM UHF
Frequency: 480 MHz; Duty Cycle: 1:1
RF Output Power: 36.78 dBm (Conducted)
7.4V 1150mAh Li-ion Battery Pack (P/N: FNB-V86LI)
Medium: M450 ($\sigma = 0.96$ mho/m; $\epsilon_r = 56.8$; $\rho = 1000$ kg/m³)

- Probe: ET3DV6 - SN1387; ConvF(7.5, 7.5, 7.5); Calibrated: 18/03/2005
- Sensor-Surface: 4mm (Mechanical Surface Detection)
- Electronics: DAE4 Sn353; Calibrated: 15/06/2005
- Phantom: Planar; Type: Plexiglas; Serial: 161
- Measurement SW: DASY4, V4.5 Build 19; Postprocessing SW: SEMCAD, V1.8 Build 146

Body-Worn - 2.5 cm Leather Case & Belt-Loop Separation Distance - Mid Channel/Area Scan (8x21x1):

Measurement grid: dx=15mm, dy=15mm

Body-Worn - 2.5 cm Leather Case & Belt-Loop Separation Distance - Mid Channel /Zoom Scan (5x5x7)/Cube 0:

Measurement grid: dx=7.5mm, dy=7.5mm, dz=5mm
Reference Value = 63.7 V/m; Power Drift = -0.434 dB
Peak SAR (extrapolated) = 6.07 W/kg

SAR(1 g) = 3.95 mW/g; SAR(10 g) = 2.83 mW/g

Body-Worn - 2.5 cm Leather Case & Belt-Loop Separation Distance - Mid Channel/Zoom Scan 2 (5x5x7)/Cube 0:

Measurement grid: dx=7.5mm, dy=7.5mm, dz=5mm
Reference Value = 62.1 V/m; Power Drift = -0.464 dB
Peak SAR (extrapolated) = 5.82 W/kg

SAR(1 g) = 3.75 mW/g; SAR(10 g) = 2.68 mW/g

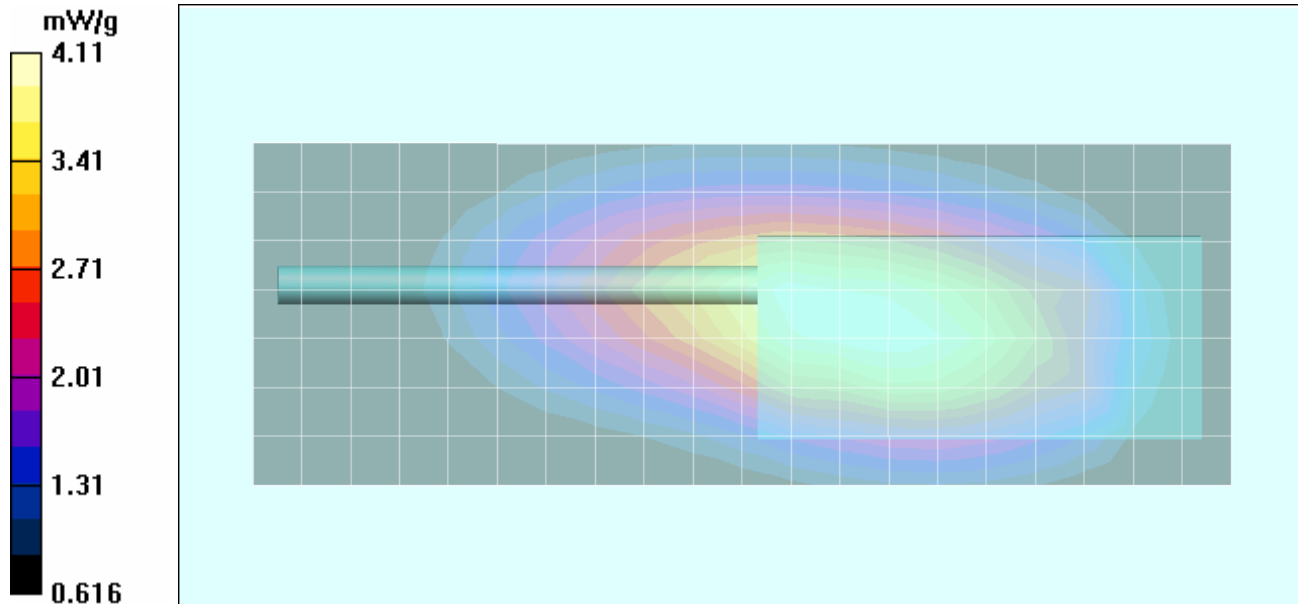

Applicant:	Vertex Standard Co., Ltd.	FCC ID:	K6610334721	IC ID:	511B-10334721	Freq.:	450 - 512 MHz
Model(s):	VX-P921-G7-5, VX-P924-G7-5, VX-P929-G7-5, VX-P971-G7-5, VX-P974-G7-5, VX-P979-G7-5		Portable FM UHF PTT Radio Transceiver				
2005 Celltech Labs Inc.	This document is not to be reproduced in whole or in part without the prior written permission of Celltech Labs Inc.					31 of 64	

Test Report Serial No.:	082605K66-T665-S90U	Test Dates:	Sept. 01-02, 2005
Date of Report Issue:	September 15, 2005	Rev. No.:	Revision 0
Description of Test:	RF Exposure	SAR	FCC 2:1093
			IC RSS-102

APPENDIX B - SYSTEM PERFORMANCE CHECK DATA

Applicant:	Vertex Standard Co., Ltd.	FCC ID:	K6610334721	IC ID:	511B-10334721	Freq.:	450 - 512 MHz
Model(s):	VX-P921-G7-5, VX-P924-G7-5, VX-P929-G7-5, VX-P971-G7-5, VX-P974-G7-5, VX-P979-G7-5		Portable FM UHF PTT Radio Transceiver				
2005 Celltech Labs Inc.	This document is not to be reproduced in whole or in part without the prior written permission of Celltech Labs Inc.						32 of 64

Test Report Serial No.:	082605K66-T665-S90U	Test Dates:	Sept. 01-02, 2005
Date of Report Issue:	September 15, 2005	Rev. No.:	Revision 0
Description of Test:	RF Exposure	SAR	FCC 2:1093 IC RSS-102

Date Tested: 09/01/2005

System Performance Check (Brain) - 450 MHz Dipole

DUT: Dipole 450 MHz; Model: D450V2; Type: System Performance Check; Serial: 136; Calibrated: 11/04/2004

Ambient Temp: 23.7 °C; Fluid Temp: 23.0 °C; Barometric Pressure: 101.8 kPa; Humidity: 35%

Communication System: CW

Forward Conducted Power: 250 mW

Frequency: 450 MHz; Duty Cycle: 1:1

Medium: HSL450 ($\sigma = 0.86$ mho/m; $\epsilon_r = 43.4$; $\rho = 1000$ kg/m³)

- Probe: ET3DV6 - SN1387; ConvF(7.5, 7.5, 7.5); Calibrated: 18/03/2005
- Sensor-Surface: 4mm (Mechanical Surface Detection)
- Electronics: DAE4 Sn353; Calibrated: 15/06/2005
- Phantom: Validation Planar; Type: Plexiglas; Serial: 137
- Measurement SW: DASy4, V4.5 Build 19; Postprocessing SW: SEMCAD, V1.8 Build 146

450 MHz Dipole - System Performance Check/Area Scan (6x11x1):

Measurement grid: dx=15mm, dy=15mm

450 MHz Dipole - System Performance Check /Zoom Scan (7x7x7)/Cube 0:

Measurement grid: dx=5mm, dy=5mm, dz=5mm

Reference Value = 39.6 V/m; Power Drift = -0.086 dB

Peak SAR (extrapolated) = 2.23 W/kg

SAR(1 g) = 1.26 mW/g; SAR(10 g) = 0.811 mW/g

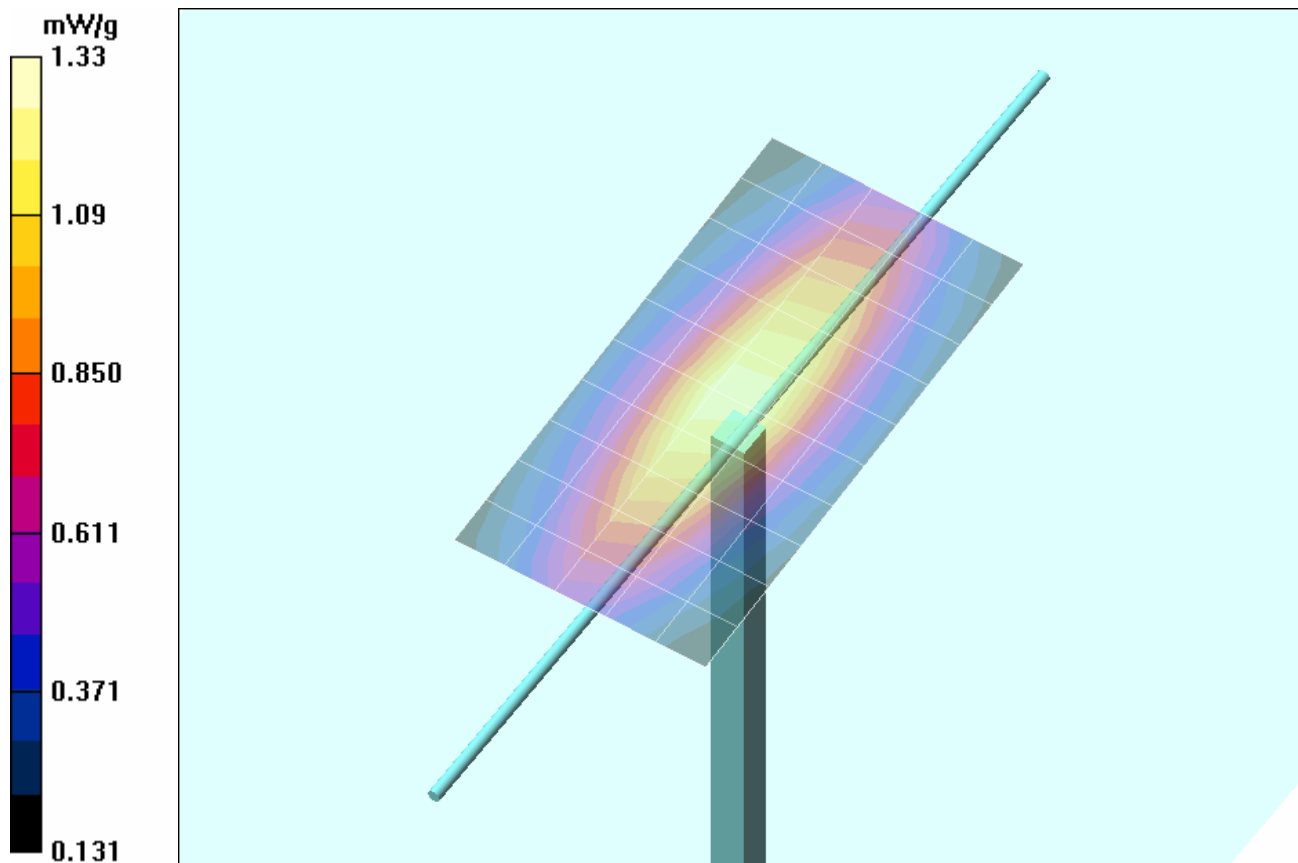

Applicant:	Vertex Standard Co., Ltd.	FCC ID:	K6610334721	IC ID:	511B-10334721	Freq.:	450 - 512 MHz
Model(s):	VX-P921-G7-5, VX-P924-G7-5, VX-P929-G7-5, VX-P971-G7-5, VX-P974-G7-5, VX-P979-G7-5		Portable FM UHF PTT Radio Transceiver				
2005 Celltech Labs Inc.	This document is not to be reproduced in whole or in part without the prior written permission of Celltech Labs Inc.					33 of 64	

Z-Axis Scan

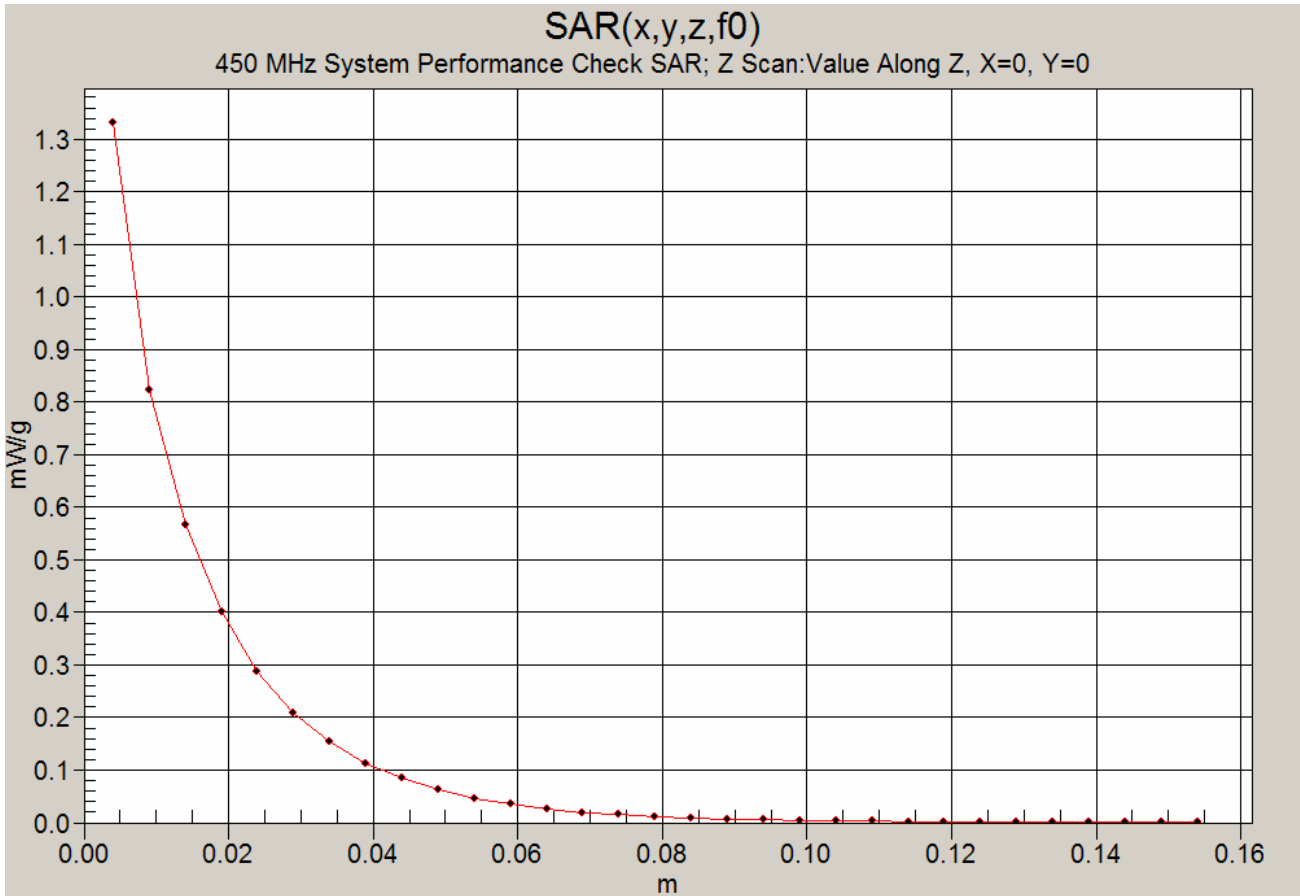

Test Report Serial No.:	082605K66-T665-S90U	Test Dates:	Sept. 01-02, 2005
Date of Report Issue:	September 15, 2005	Rev. No.:	Revision 0
Description of Test:	RF Exposure	SAR	FCC 2:1093
			IC RSS-102

APPENDIX C - MEASURED FLUID DIELECTRIC PARAMETERS

Applicant:	Vertex Standard Co., Ltd.	FCC ID:	K6610334721	IC ID:	511B-10334721	Freq.:	450 - 512 MHz
Model(s):	VX-P921-G7-5, VX-P924-G7-5, VX-P929-G7-5, VX-P971-G7-5, VX-P974-G7-5, VX-P979-G7-5		Portable FM UHF PTT Radio Transceiver				
2005 Celltech Labs Inc.	This document is not to be reproduced in whole or in part without the prior written permission of Celltech Labs Inc.						35 of 64

Test Report Serial No.:	082605K66-T665-S90U	Test Dates:	Sept. 01-02, 2005
Date of Report Issue:	September 15, 2005	Rev. No.:	Revision 0
Description of Test:	RF Exposure	SAR	FCC 2:1093 IC RSS-102

450 MHz System Performance Check & DUT Evaluation (Face)

Celltech Labs Inc.

Test Result for UIM Dielectric Parameter

Thu 01/Sep/2005

Frequency(GHz)

FCC_eHFCC OET 65 Supplement C (June 2001) Limits for Head Epsilon

FCC_sHFCC OET 65 Supplement C (June 2001) Limits for Head Sigma

Test_e Epsilon of UIM

Test_s Sigma of UIM

Freq	FCC_eHF	FCC_sHF	Test_e	Test_s
0.3500	44.70	0.87	46.08	0.76
0.3600	44.58	0.87	46.01	0.79
0.3700	44.46	0.87	45.70	0.78
0.3800	44.34	0.87	44.41	0.80
0.3900	44.22	0.87	44.31	0.82
0.4000	44.10	0.87	44.87	0.82
0.4100	43.98	0.87	43.74	0.82
0.4200	43.86	0.87	43.77	0.83
0.4300	43.74	0.87	44.28	0.83
0.4400	43.62	0.87	43.53	0.85
0.4500	43.50	0.87	43.43	0.86
0.4600	43.45	0.87	42.80	0.87
0.4700	43.40	0.87	42.86	0.87
0.4800	43.34	0.87	42.85	0.89
0.4900	43.29	0.87	42.15	0.90
0.5000	43.24	0.87	42.86	0.91
0.5100	43.19	0.87	42.12	0.91
0.5200	43.14	0.88	41.80	0.91
0.5300	43.08	0.88	42.36	0.93
0.5400	43.03	0.88	41.69	0.93
0.5500	42.98	0.88	41.19	0.93

Applicant:	Vertex Standard Co., Ltd.	FCC ID:	K6610334721	IC ID:	511B-10334721	Freq.:	450 - 512 MHz
Model(s):	VX-P921-G7-5, VX-P924-G7-5, VX-P929-G7-5, VX-P971-G7-5, VX-P974-G7-5, VX-P979-G7-5			Portable FM UHF PTT Radio Transceiver			
2005 Celltech Labs Inc.	This document is not to be reproduced in whole or in part without the prior written permission of Celltech Labs Inc.						36 of 64

Test Report Serial No.:	082605K66-T665-S90U	Test Dates:	Sept. 01-02, 2005
Date of Report Issue:	September 15, 2005	Rev. No.:	Revision 0
Description of Test:	RF Exposure	SAR	FCC 2:1093 IC RSS-102

450 MHz DUT Evaluation (Body)

Celltech Labs Inc.
 Test Result for UIM Dielectric Parameter
 Fri 02/Sep/2005
 Frequency(GHz)
 FCC_eHFCC Bulletin 65 Supplement C (June 2001) Limits for Head Epsilon
 FCC_sHFCC Bulletin 65 Supplement C (June 2001) Limits for Head Sigma
 FCC_eB FCC Limits for Body Epsilon
 FCC_sB FCC Limits for Body Sigma
 Test_e Epsilon of UIM
 Test_s Sigma of UIM

Freq	FCC_eB	FCC_sB	Test_e	Test_s
0.3500	57.70	0.93	59.17	0.90
0.3600	57.60	0.93	59.13	0.91
0.3700	57.50	0.93	58.32	0.91
0.3800	57.40	0.93	57.88	0.92
0.3900	57.30	0.93	57.95	0.93
0.4000	57.20	0.93	57.89	0.94
0.4100	57.10	0.93	57.45	0.95
0.4200	57.00	0.94	56.84	0.96
0.4300	56.90	0.94	57.54	0.94
0.4400	56.80	0.94	57.00	0.96
0.4500	56.70	0.94	56.79	0.96
0.4600	56.66	0.94	56.35	0.99
0.4700	56.62	0.94	56.88	0.99
0.4800	56.58	0.94	56.07	1.00
0.4900	56.54	0.94	55.95	1.01
0.5000	56.51	0.94	56.57	1.02
0.5100	56.47	0.94	55.93	1.04
0.5200	56.43	0.95	55.99	1.03
0.5300	56.39	0.95	56.41	1.05
0.5400	56.35	0.95	55.79	1.05
0.5500	56.31	0.95	55.38	1.04

Applicant:	Vertex Standard Co., Ltd.	FCC ID:	K6610334721	IC ID:	511B-10334721	Freq.:	450 - 512 MHz
Model(s):	VX-P921-G7-5, VX-P924-G7-5, VX-P929-G7-5, VX-P971-G7-5, VX-P974-G7-5, VX-P979-G7-5		Portable FM UHF PTT Radio Transceiver				
2005 Celltech Labs Inc.	This document is not to be reproduced in whole or in part without the prior written permission of Celltech Labs Inc.						37 of 64

Test Report Serial No.:	082605K66-T665-S90U	Test Dates:	Sept. 01-02, 2005
Date of Report Issue:	September 15, 2005	Rev. No.:	Revision 0
Description of Test:	RF Exposure	SAR	FCC 2:1093
			IC RSS-102

APPENDIX E - SYSTEM VALIDATION

Applicant:	Vertex Standard Co., Ltd.	FCC ID:	K6610334721	IC ID:	511B-10334721	Freq.:	450 - 512 MHz
Model(s):	VX-P921-G7-5, VX-P924-G7-5, VX-P929-G7-5, VX-P971-G7-5, VX-P974-G7-5, VX-P979-G7-5		Portable FM UHF PTT Radio Transceiver				
2005 Celltech Labs Inc.	This document is not to be reproduced in whole or in part without the prior written permission of Celltech Labs Inc.						63 of 64

450 MHz SYSTEM VALIDATION DIPOLE

Type:

450 MHz Validation Dipole

Serial Number:

136

Place of Calibration:

Celltech Labs Inc.

Date of Calibration:

November 4, 2004

Celltech Labs Inc. hereby certifies that this device has been calibrated on the date indicated above.

Calibrated by:

Spencer Watson

Approved by:

Russell W. Pope

1. Dipole Construction & Electrical Characteristics

The validation dipole was constructed in accordance with the IEEE Std “Recommended Practice for Determining the Spatial-Peak Specific Absorption Rate (SAR) in the Human Body Due to Wireless Communications Devices: Experimental Techniques”. The electrical properties were measured using an HP 8753E Network Analyzer. The network analyzer was calibrated to the validation dipole N-type connector feed point using an HP85032E Type N calibration kit. The dipole was placed parallel to a planar phantom at a separation distance of 15.0mm from the simulating fluid using a loss-less dielectric spacer. The measured input impedance is:

Feed point impedance at 450MHz	$\text{Re}\{Z\} = 54.041\Omega$
	$\text{Im}\{Z\} = 5.5258\Omega$
Return Loss at 450MHz	-23.744dB

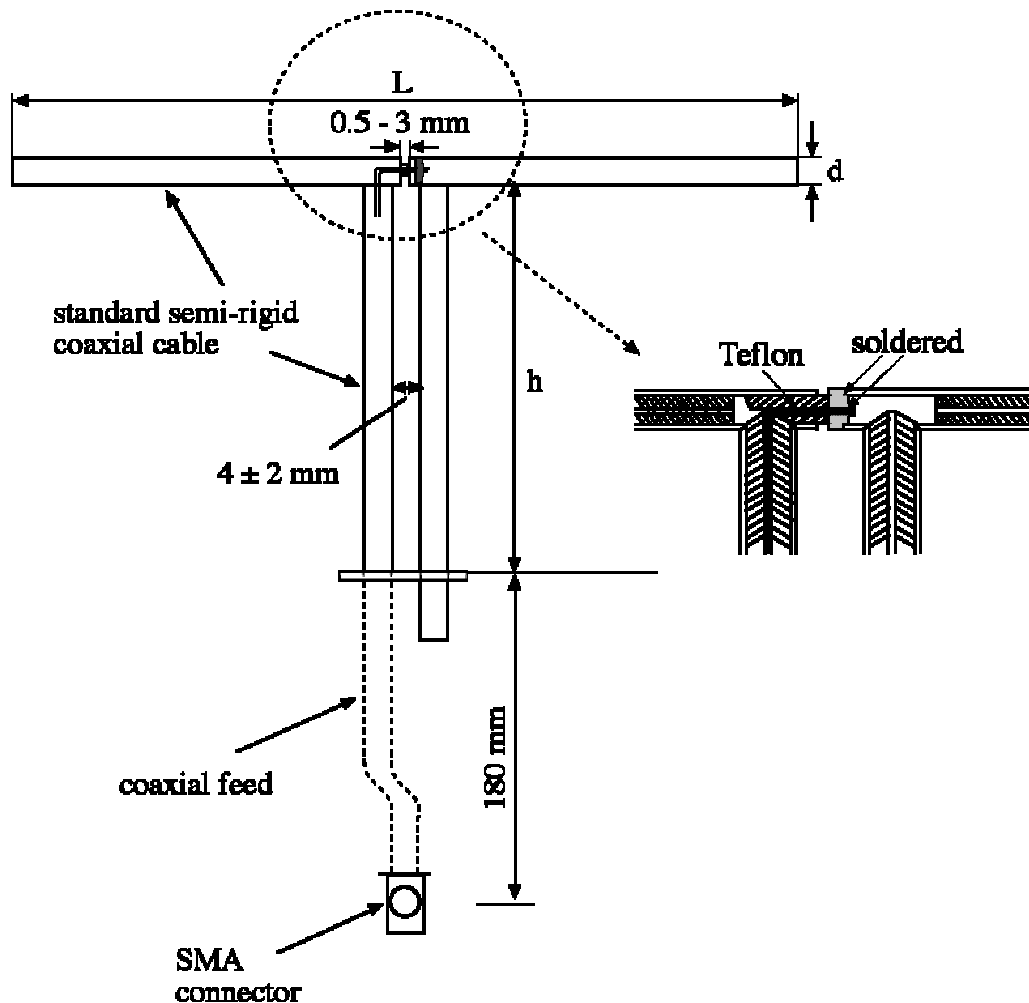

4 Nov 2004 09:03:54

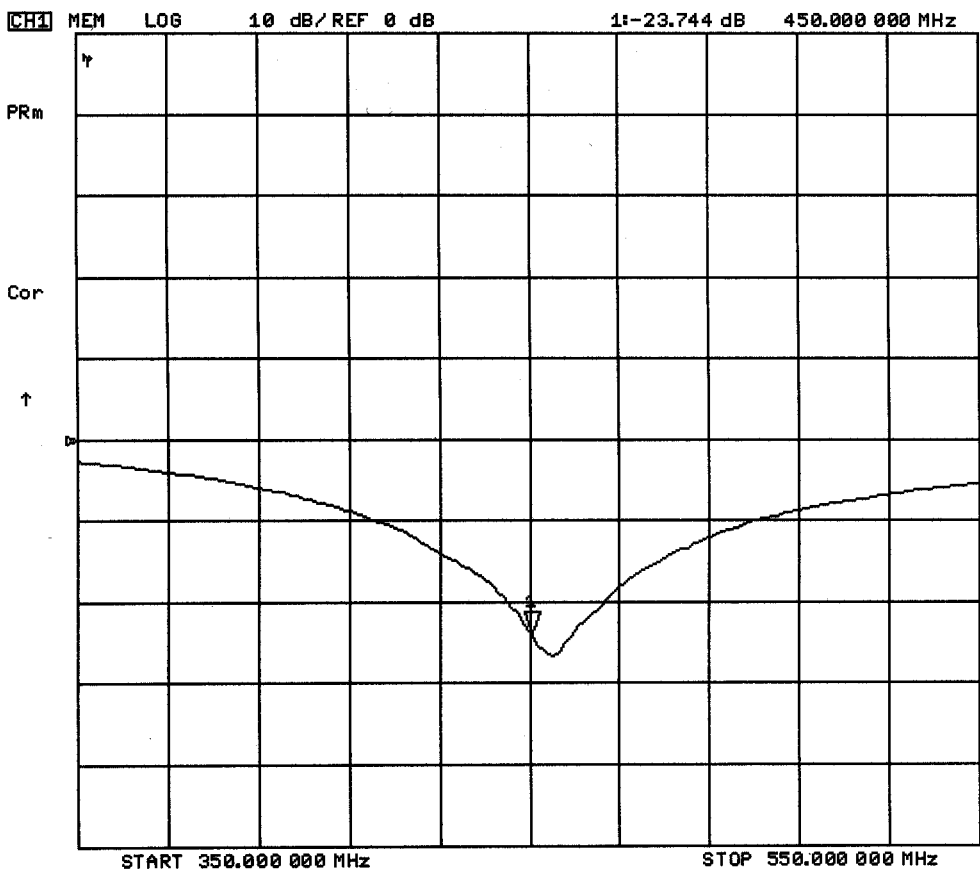

CH1 MEM 1 U FS

1: 54.041 Ω 5.4258 Ω 1.9190 nH

4 Nov 2004 09:05:08

450.000 000 MHz

PRn

Cor

↑

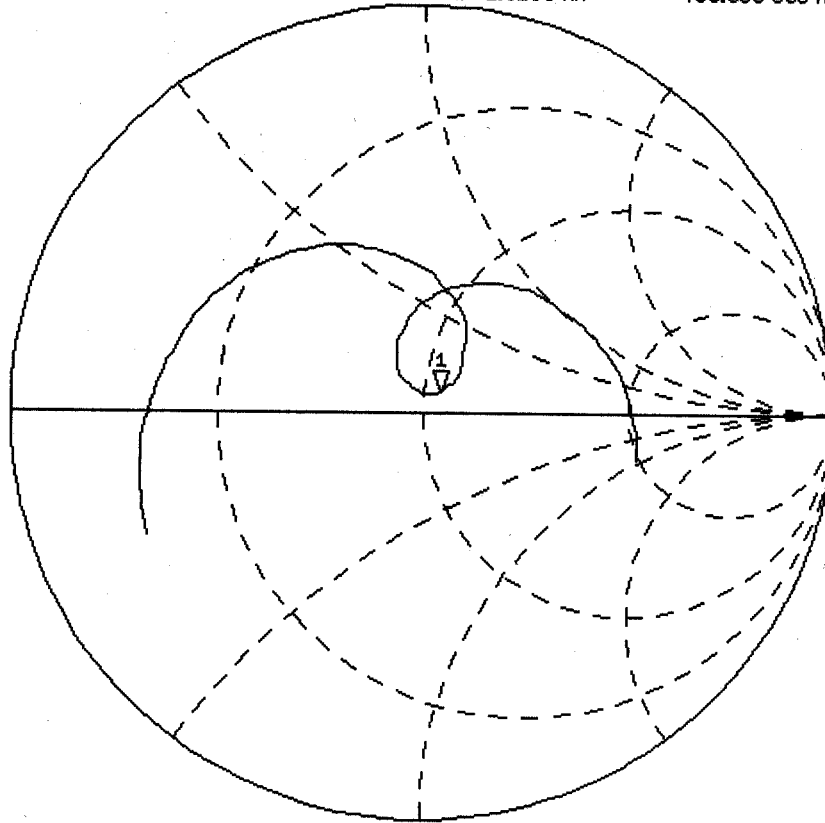

START 350.000 000 MHz

STOP 550.000 000 MHz

2. Validation Dipole Dimensions

Frequency (MHz)	L (mm)	h (mm)	d (mm)
300	420.0	250.0	6.2
450	288.0	167.0	6.2
835	161.0	89.8	3.6
900	149.0	83.3	3.6
1450	89.1	51.7	3.6
1800	72.0	41.7	3.6
1900	68.0	39.5	3.6
2000	64.5	37.5	3.6
2450	51.8	30.6	3.6
3000	41.5	25.0	3.6

3. Validation Phantom

The validation phantom was constructed using relatively low-loss tangent Plexiglas material. The inner dimensions of the phantom are as follows:

Length: 83.5 cm
 Width: 36.9 cm
 Height: 21.8 cm

The bottom section of the validation phantom is constructed of 6.2 ± 0.1 mm Plexiglas.

4. Dimensions of Plexiglas Planar Phantom

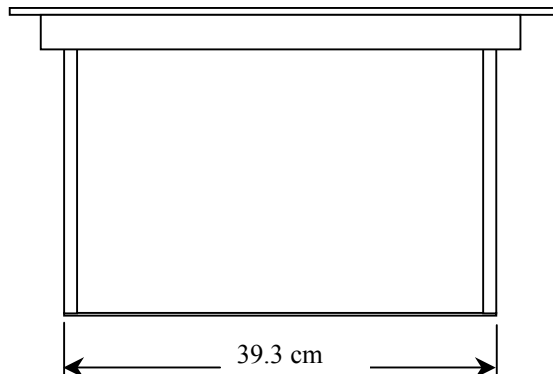
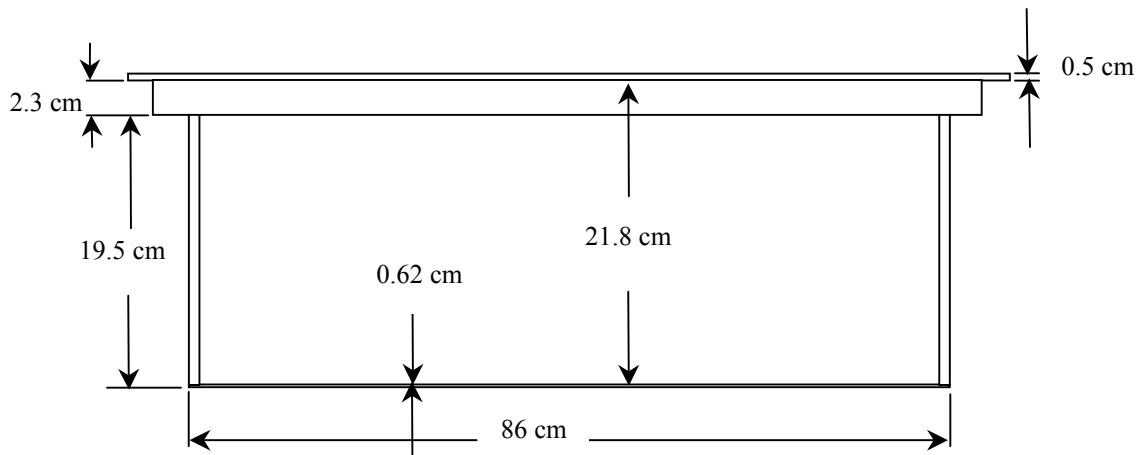
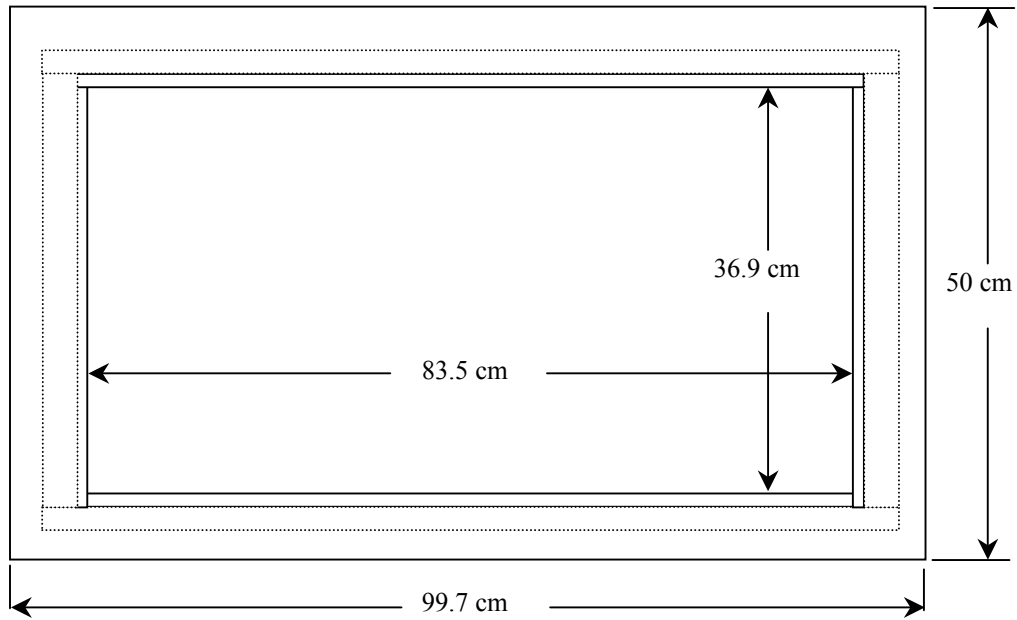

5. 450 MHz System Validation Setup



450 MHz Validation Dipole Setup



6. Measurement Conditions

The planar phantom was filled with brain simulating tissue having the following parameters at 450 MHz:

Relative Permittivity: 42.9
 Conductivity: 0.85 mho/m
 Fluid Temperature: 21.9 °C
 Fluid Depth: ≥ 15.0 cm

Environmental Conditions:

Ambient Temperature: 22.4 °C
 Humidity: 31 %
 Barometric Pressure: 103.2 kPa

The 450 MHz simulated brain tissue mixture consists of the following ingredients:

Ingredient	Percentage by weight
Water	38.56%
Sugar	56.32%
Salt	3.95%
HEC	0.98%
Dowicil 75	0.19%
450 MHz Target Dielectric Parameters at 22 °C	$\epsilon_r = 43.5$ $\sigma = 0.87 \text{ S/m}$

7. SAR Measurement

The SAR measurement was performed with the E-field probe in mechanical detection mode only. The setup and determination of the forward power into the dipole was performed using the following procedures.

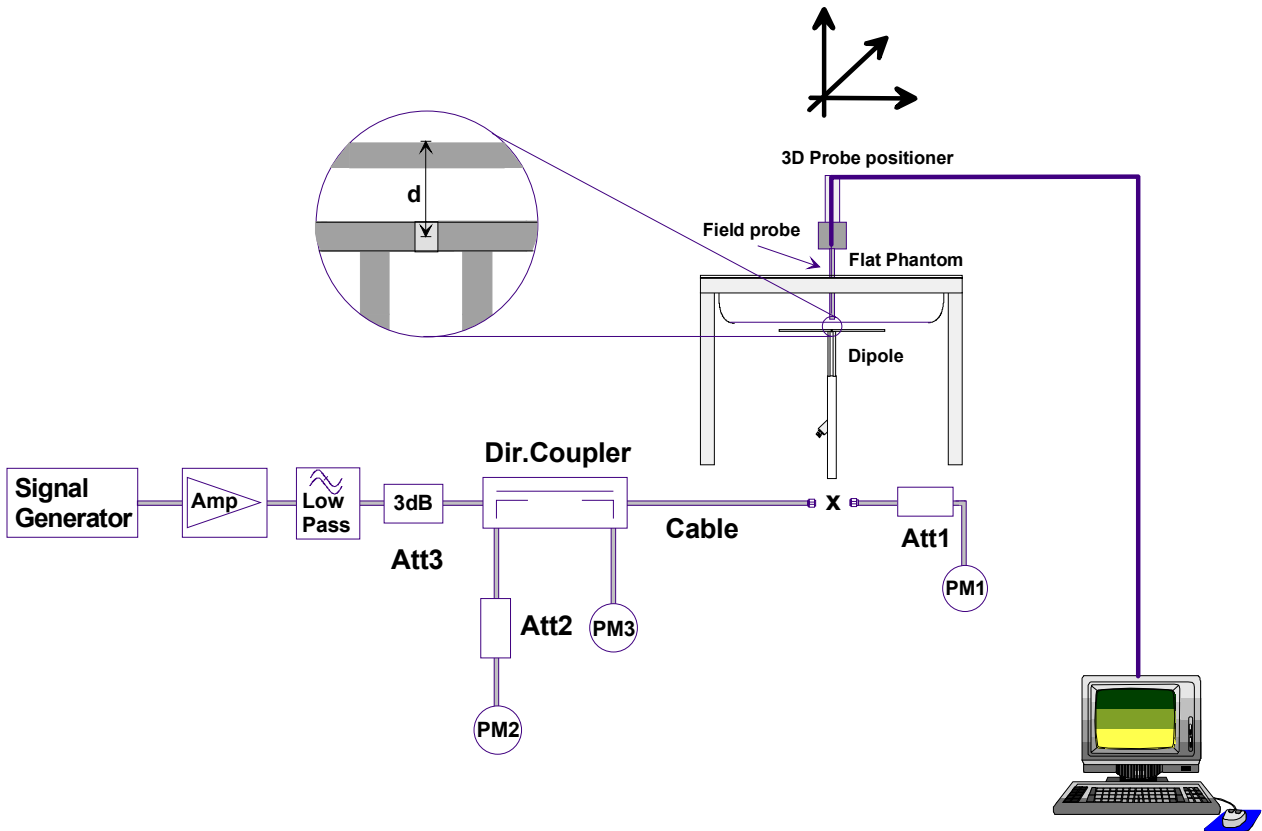

First the power meter PM1 (including attenuator Att1) is connected to the cable to measure the forward power at the location of the dipole connector (X). The signal generator is adjusted for the desired forward power at the dipole connector (taking into account the attenuation of Att1) as read by power meter PM2. After connecting the cable to the dipole, the signal generator is readjusted for the same reading at power meter PM2. If the signal generator does not allow adjustment in 0.01dB steps, the remaining difference at PM2 must be taken into consideration. PM3 records the reflected power from the dipole to ensure that the value is not changed from the previous value. The reflected power should be 20dB below the forward power.

8. Validation Dipole SAR Test Results

Ten SAR measurements were performed in order to achieve repeatability and to establish an average target value.

Validation Measurement	SAR @ 0.25W Input averaged over 1g	SAR @ 1W Input averaged over 1g	SAR @ 0.25W Input averaged over 10g	SAR @ 1W Input averaged over 10g	Peak SAR @ 0.25W Input
Test 1	1.22	4.88	0.782	3.128	1.29
Test 2	1.23	4.92	0.791	3.164	1.30
Test 3	1.23	4.92	0.789	3.156	1.30
Test 4	1.23	4.92	0.790	3.160	1.31
Test 5	1.24	4.96	0.793	3.172	1.31
Test 6	1.24	4.96	0.792	3.168	1.31
Test 7	1.23	4.92	0.791	3.164	1.31
Test 8	1.23	4.92	0.789	3.156	1.30
Test 9	1.24	4.96	0.791	3.164	1.31
Test 10	1.23	4.92	0.789	3.156	1.31
Average Value	1.23	4.93	0.790	3.16	1.31

The results have been normalized to 1W (forward power) into the dipole.

IEEE Target over 1cm³ (1g) of tissue: 4.9 mW/g (+/- 10%)

Averaged over 1cm (1g) of tissue: 4.93 mW/g (deviation +0.6%)

IEEE Target over 10cm³ (10g) of tissue: 3.3 mW/g (+/- 10%)

Averaged over 10cm (10g) of tissue: 3.16 mW/g (deviation -4.2%)

450 MHz System Validation - November 4, 2004

DUT: Dipole 450 MHz; Model: D450V2; Serial: 136; Calibrated: 11/04/2004

Ambient Temp: 22.4 °C; Fluid Temp: 21.9 °C; Barometric Pressure: 103.2 kPa; Humidity: 31%

Communication System: CW

Frequency: 450 MHz; Duty Cycle: 1:1

Medium: HSL450 ($\sigma = 0.85$ mho/m; $\epsilon_r = 42.9$; $\rho = 1000$ kg/m³)

- Probe: ET3DV6 - SN1387; ConvF(7.5, 7.5, 7.5); Calibrated: 18/03/2004

- Sensor-Surface: 4mm (Mechanical Surface Detection)

- Electronics: DAE3 Sn370; Calibrated: 14/05/2004

- Phantom: Validation Planar; Type: Plexiglas; Serial: 137

- Measurement SW: DASY4, V4.3 Build 22; Postprocessing SW: SEMCAD, V1.8 Build 127

450 MHz System Validation/Area Scan (6x11x1): Measurement grid: dx=15mm, dy=15mm

450 MHz System Validation/Zoom Scan (7x7x7)/Cube 0: Measurement grid: dx=5mm, dy=5mm, dz=5mm

Reference Value = 39.3 V/m; Power Drift = -0.1 dB

Peak SAR (extrapolated) = 2.15 W/kg

SAR(1 g) = 1.22 mW/g; SAR(10 g) = 0.782 mW/g

450 MHz System Validation/Zoom Scan 2 (7x7x7)/Cube 0: Measurement grid: dx=5mm, dy=5mm, dz=5mm

Reference Value = 39.2 V/m; Power Drift = -0.0 dB

Peak SAR (extrapolated) = 2.16 W/kg

SAR(1 g) = 1.23 mW/g; SAR(10 g) = 0.791 mW/g

450 MHz System Validation/Zoom Scan 3 (7x7x7)/Cube 0: Measurement grid: dx=5mm, dy=5mm, dz=5mm

Reference Value = 39.1 V/m; Power Drift = -0.004 dB

Peak SAR (extrapolated) = 2.16 W/kg

SAR(1 g) = 1.23 mW/g; SAR(10 g) = 0.789 mW/g

450 MHz System Validation/Zoom Scan 4 (7x7x7)/Cube 0: Measurement grid: dx=5mm, dy=5mm, dz=5mm

Reference Value = 39.2 V/m; Power Drift = -0.0 dB

Peak SAR (extrapolated) = 2.18 W/kg

SAR(1 g) = 1.23 mW/g; SAR(10 g) = 0.790 mW/g

450 MHz System Validation/Zoom Scan 5 (7x7x7)/Cube 0: Measurement grid: dx=5mm, dy=5mm, dz=5mm

Reference Value = 39.2 V/m; Power Drift = 0.009 dB

Peak SAR (extrapolated) = 2.18 W/kg

SAR(1 g) = 1.24 mW/g; SAR(10 g) = 0.793 mW/g

450 MHz System Validation/Zoom Scan 6 (7x7x7)/Cube 0: Measurement grid: dx=5mm, dy=5mm, dz=5mm

Reference Value = 39.1 V/m; Power Drift = 0.007 dB

Peak SAR (extrapolated) = 2.18 W/kg

SAR(1 g) = 1.24 mW/g; SAR(10 g) = 0.792 mW/g

450 MHz System Validation/Zoom Scan 7 (7x7x7)/Cube 0: Measurement grid: dx=5mm, dy=5mm, dz=5mm

Reference Value = 39.2 V/m; Power Drift = 0.004 dB

Peak SAR (extrapolated) = 2.18 W/kg

SAR(1 g) = 1.23 mW/g; SAR(10 g) = 0.791 mW/g

450 MHz System Validation/Zoom Scan 8 (7x7x7)/Cube 0: Measurement grid: dx=5mm, dy=5mm, dz=5mm

Reference Value = 39.2 V/m; Power Drift = 0.0 dB

Peak SAR (extrapolated) = 2.16 W/kg

SAR(1 g) = 1.23 mW/g; SAR(10 g) = 0.789 mW/g

450 MHz System Validation/Zoom Scan 9 (7x7x7)/Cube 0: Measurement grid: dx=5mm, dy=5mm, dz=5mm

Reference Value = 39.4 V/m; Power Drift = 0.0 dB

Peak SAR (extrapolated) = 2.19 W/kg

SAR(1 g) = 1.24 mW/g; SAR(10 g) = 0.791 mW/g

450 MHz System Validation/Zoom Scan 10 (7x7x7)/Cube 0: Measurement grid: dx=5mm, dy=5mm, dz=5mm

Reference Value = 39.1 V/m; Power Drift = 0.007 dB

Peak SAR (extrapolated) = 2.16 W/kg

SAR(1 g) = 1.23 mW/g; SAR(10 g) = 0.789 mW/g

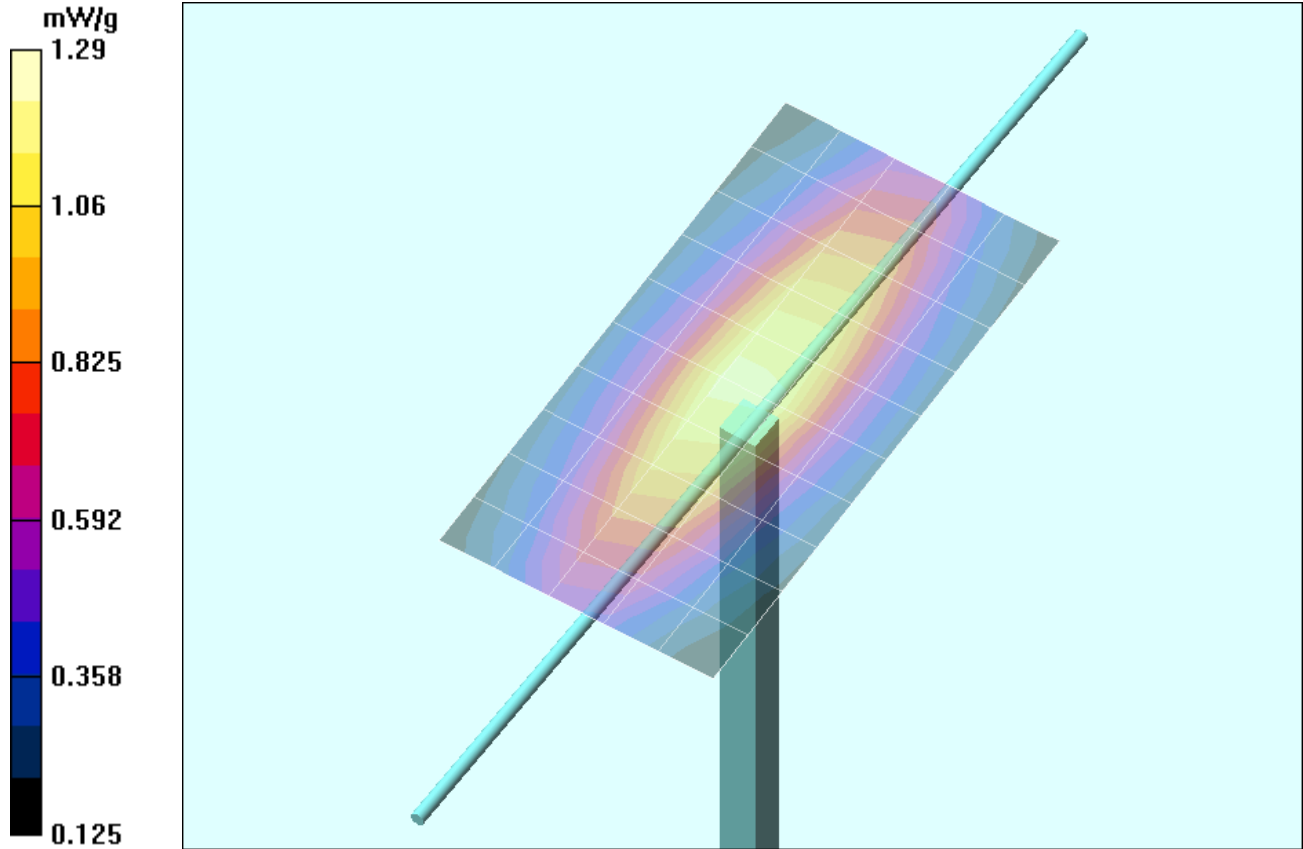

1 g average of 10 measurements: 1.23 mW/g
 10 g average of 10 measurements: 0.790 mW/g

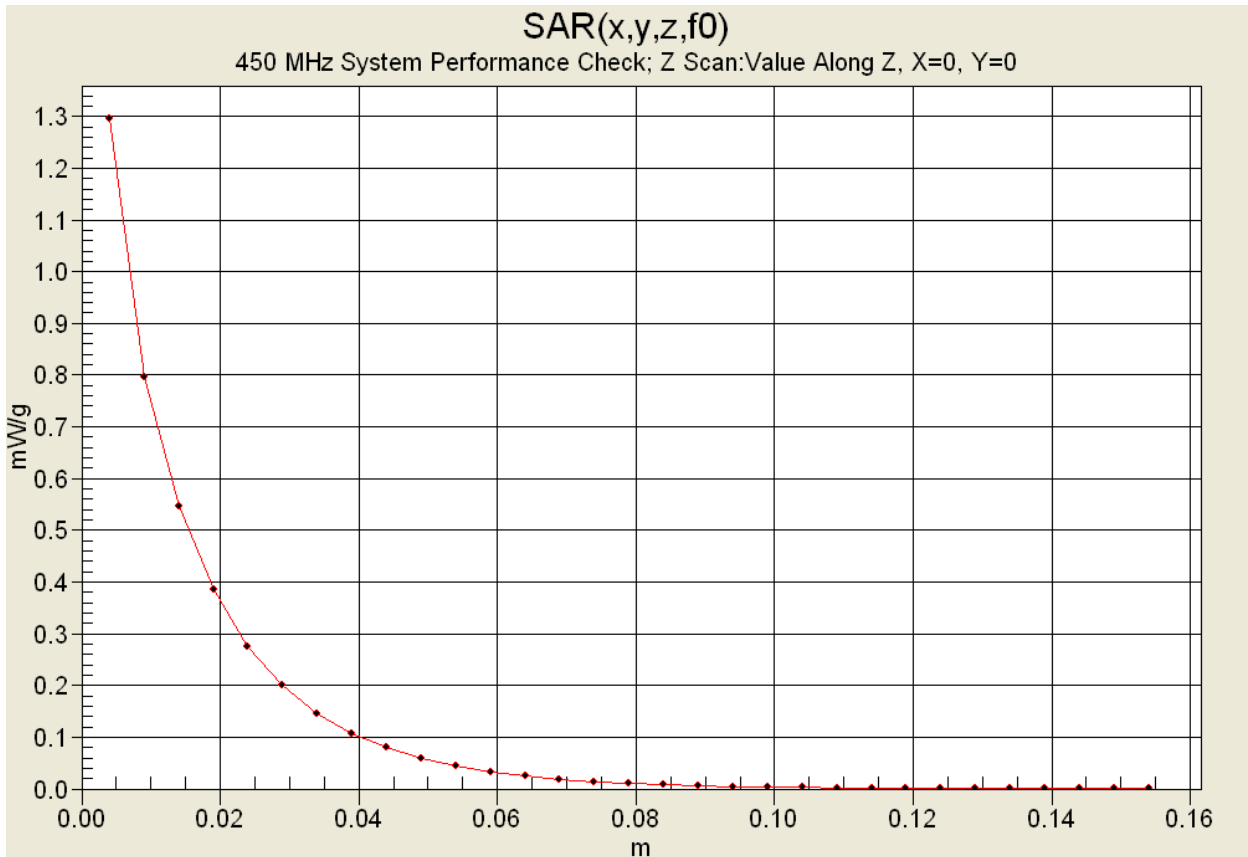

450MHz System Validation

Measured Fluid Dielectric Parameters (Brain)

November 04, 2004

Frequency	ϵ'	ϵ''
350.000000 MHz	45.3974	39.4988
360.000000 MHz	45.0834	38.7858
370.000000 MHz	44.8651	38.1777
380.000000 MHz	44.6622	37.6103
390.000000 MHz	44.3761	37.1472
400.000000 MHz	44.1745	36.5919
410.000000 MHz	43.8392	36.0417
420.000000 MHz	43.6277	35.5608
430.000000 MHz	43.3443	34.9958
440.000000 MHz	43.1200	34.5629
450.000000 MHz	42.8999	34.1583
460.000000 MHz	42.7154	33.7478
470.000000 MHz	42.4773	33.4083
480.000000 MHz	42.2998	33.0563
490.000000 MHz	42.0302	32.7340
500.000000 MHz	41.8641	32.3576
510.000000 MHz	41.6518	31.9703
520.000000 MHz	41.4863	31.6232
530.000000 MHz	41.2685	31.3144
540.000000 MHz	41.1027	30.8977
550.000000 MHz	40.9455	30.6347