REPORT ON
Radio testing of the VERTEX STANDARD VX-929-D0-5
In accordance with ANSI/TIA/EIA-603, RSS-119

Report number TA000174

November 2004

GENERAL INFORMATION

MODEL NAME:	VX-929-D0-5	
FCC ID:	K6610333020	
IC ID:	511B-10333020	
MANUFACTURER:	Vertex Standard Co., Ltd.	
TRADE NAME:	VERTEX STANDARD	
EUT DESCRIPTION:	VHF FM Transceiver	
SERIAL NUMBER:	4M000008	
VOLTAGE REQUIREMENTS:	7.4	[V]
	DC	
NUMBER OF CHANNELS:		
SPECIFICATION ARE REFERENCED	ANSI/TIA/EIA-603	
	RSS-119	

TRANSMITTERS

TYPE OF EMISSION:	16K0F3E , 11K0F3E	
FREQUENCY RANGE:	134 to 174	[MHz]
POWER OUTPUT RATING:	1 to 5	[W]
	<u> </u> Switchable	
	<u> x </u> Variable	
	<u> </u> N/A	
MAXIMUM POWER RATING:	300	[W]
INPUT IMPEDANCE (MIC):	600	[Ω]
OUTPUT IMPEDANCE (RF):	50	[Ω]
Collector Voltage:	7.4	[V]
Collector Current:	1.3	[A]

RECEIVERS

FREQUENCY RANGE:	134 to 174	[MHz]
INTERMEDIATE FREQUENCIES:	1st 50.85	[MHz]
	2nd 450	[kHz]
INPUT IMPEDANCE (RF):	50	[Ω]
OUTPUT IMPEDANCE (SP):	16	[Ω]
AUDIO OUTPUT POWER:	0.5	[W]

This report was prepared by Vertex Standard Co., Ltd.

Test performed by N.Tamakoshi

Date 17 / November /2004

VX-929-D0-5 Channel Settings

CH No.	Shown on LCD	Transmit Frequency [MHz]	Receive Frequency [MHz]	CH Spacing	Power	
					High	Low
1	134.0MHz Wid	134.000	134.000	25k	5W	
2	154.0MHz Wid	154.000	154.000	25k	5W	
3	174.0MHz Wid	174.000	174.000	25k	5W	
4	134.0MHz Nar	134.000	134.000	12.5k	5W	
5	154.0MHz Nar	154.000	154.000	12.5k	5W	
6	174.0MHz Nar	174.000	174.000	12.5k	5W	
7	134.0MHz W-L	134.000	134.000	25k		1W
8	154.0MHz W-L	154.000	154.000	25k		1W
9	174.0MHz W-L	174.000	174.000	25k		1W
10	134.0MHz N-L	134.000	134.000	12.5k		1W
11	154.0MHz N-L	154.000	154.000	12.5k		1W
12	174.0MHz N-L	174.000	174.000	12.5k		1W
13	Sub 450.1MHz	134.000	450.100	25k		1W
14	Sub 481.1MHz	154.000	481.100	25k		1W
15	Sub 512.1MHz	174.000	512.100	25k		1W
16						
17						
18						
19						
20						

NAME OF TEST: R.F. Power Output (Conducted)
SPECIFICATION: 47 CFR 2.1046 (a)
GUIDE: ANSI/TIA/EIA-603, Paragraph 2.2.1
TEST EQUIPMENT: As per attached page

MEASUREMENT PROCEDURE

1. The EUT was connected to a resistive coaxial attenuator of normal load impedance, and the modulated output power was measured by means of an R.F. power meter.
2. Measurement accuracy is $\pm 4\%$

MEASUREMENT RESULTS

NOMINAL, MHz	CHANNEL	R.F. POWER, WATTS	
		LOW	HIGH
134.000	1	1.210	4.550
154.000	2	1.080	4.810
174.000	3	1.210	5.150

NAME OF TEST: R.F. Power Output (Radiated)

High Power

FREQUENCY TUNED, MHz	LEVEL, dBm
134.0000	29.8
154.0000	29.2
174.0000	28.4

TRANSMITTER POWER CONDUCTED MEASUREMENTS

TEST 1: R.F. POWER OUTPUT
 TEST 2: FREQUENCY STABILITY

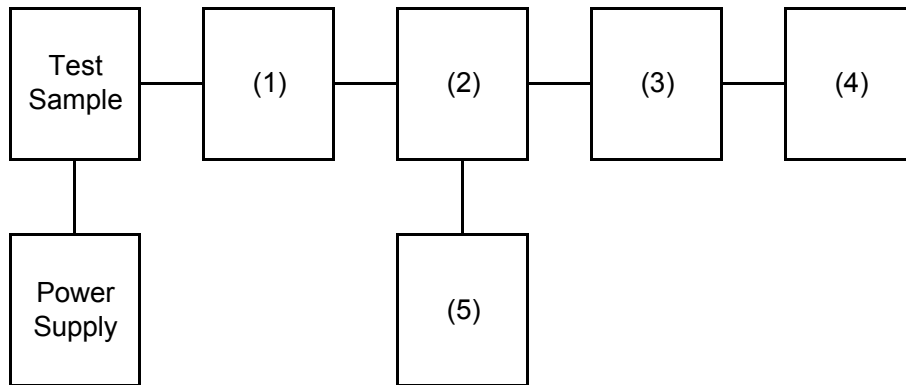

Instruments	Description	Serial Number
(1) COAXIAL ATTENUATOR	WEINSHELL 49-10-43	***
(2) RF COUPLER	ADVANTEST TR4153	***
(3) POWER SENSOR	Agilent 8482B	***
(4) POWER METER	Agilent 8901B POWER MODE	***
(5) FREQUENCY COUNTER	Agilent 8901B FREQUENCY MODI	***

NAME OF TEST: Unwanted Emissions (Conducted)
SPECIFICATION: 47 CFR 2.1051
GUIDE: ANSI/TIA/EIA-603, Paragraph 2.2.13
TEST EQUIPMENT: As per attached page

MEASUREMENT PROCEDURE

1. The emissions were measured for the worst case as follows:
 - (a): within a band of frequencies defined by the carrier frequency plus and minus one channel.
 - (b): from the lowest frequency generated in the EUT and to at least the 10th harmonic of the carrier frequency, or 40GHz, whichever is lower.
2. The magnitude of spurious emissions that are attenuated more than 20dB below the permissible value need not be specified.
3. MEASUREMENT RESULTS:

FREQUENCY OF CARRIER, MHz = 134 , 154 , 174

SPECTRUM SEARCHED, GHz = 0 to 10 x Fc

MAXIMUM RESPONSE, Hz = 2700

ALL OTHER EMISSIONS = \geq 20dB BELOW LIMIT

TRANSMITTER SPURIOUS EMISSION

TEST 1: OCCUPIED BANDWIDTH (IN-BAND SPURIOUS)

TEST 2: OUT-OF-BAND SPURIOUS

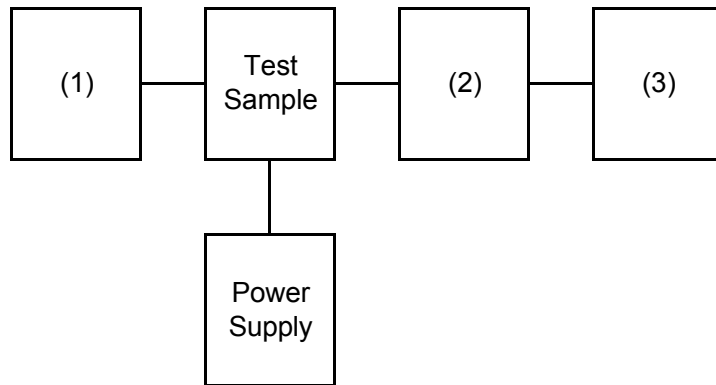

Instruments	Description	Serial Number
(1) AUDIO GENERATOR	Agilent 8903B	***
(2) COAXIAL ATTENUATOR	WEINSHELL 49-10-43	***
(2) COAXIAL ATTENUATOR	Agilent 8498A	***
(3) SPECTRUM ANALYZER	ADVANTEST TR4173	***

NAME OF TEST: Unwanted Emissions (Conducted)

LIMIT'S), dBc: $-(50+10 \times \text{LOG}(P)) = -57$ (5 Watts)

$-(50+10 \times \text{LOG}(P)) = -50$ (1 Watts)

High Power

FREQUENCY TUNED, MHz	FREQUENCY EMISSION, MHz	LEVEL, dBm	LEVEL, dBc	MARGIN, dB
134.0000	268.0000	-29.7	-66.7	9.7

NAME OF TEST: Unwanted Emissions (Conducted)

LIMIT'S), dBc: $-(50+10 \times \text{LOG}(P)) = -57$ (5 Watts)

$-(50+10 \times \text{LOG}(P)) = -50$ (1 Watts)

Low Power

FREQUENCY TUNED, MHz	FREQUENCY EMISSION, MHz	LEVEL, dBm	LEVEL, dBc	MARGIN, dB
134.0000	268.0000	-39.8	-69.8	19.8

NAME OF TEST: Field Strength of Spurious Radiation
SPECIFICATION: 47 CFR 2.1053 (a)
GUIDE: ANSI/TIA/EIA-603, Paragraph 1.2.12

MEASUREMENT PROCEDURE

1.2.12.1 Definition: Radiated spurious emissions are emissions from the equipment when transmitting load on a frequency or frequencies which are outside an occupied band sufficient to ensure transmission of information of required quality for the class of communications desired.

1.2.12.2 Method of measurement

- A) Connect the equipment as illustrated.
- B) Adjust the spectrum analyzer for the following settings:
- 1) Resolution Bandwidth $\leq 3\text{kHz}$
 - 2) Video Bandwidth $\geq 10\text{kHz}$
 - 3) Sweep Speed $\leq 2000\text{Hz/second}$
 - 4) Detector Mode = Positive Peak
- C) Place the transmitter to be tested on the turntable in the standard test site. The transmitter is transmitting into a non-radiating load which is placed on the turntable. The RF cable to this load should be of minimum length.

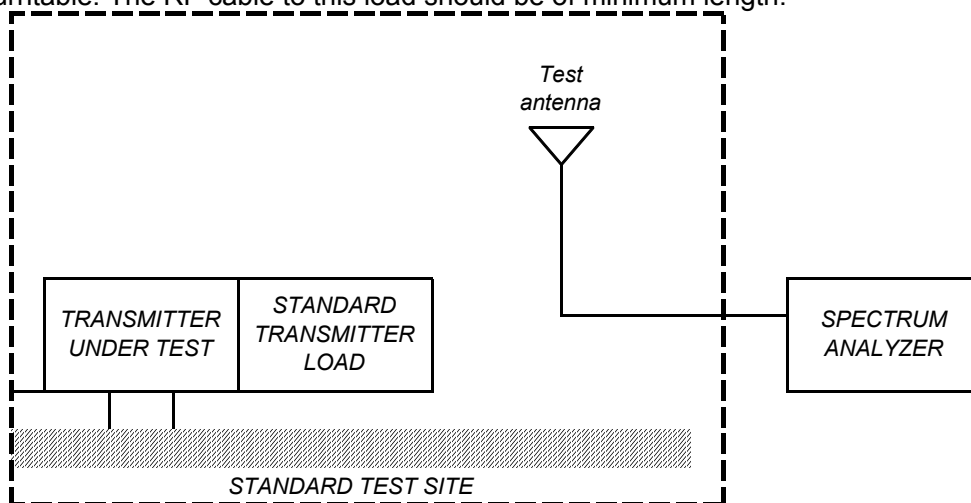

- D) For each spurious measurement the test antenna should be adjusted to the correct length for the frequency involved. This length may be determined from a calibration ruler supplied with the equipment. Measurements shall be made from the lowest radio frequency generated in the equipment to the tenth harmonic of the carrier, except for the region close to the carrier equal to \pm the test bandwidth (see section 1.3.4.4).
- E) For each spurious frequency, raise and lower the test antenna from 1 m to 4 m to obtain a maximum reading on the spectrum analyzer with the test antenna at horizontal polarity.

NAME OF TEST: Field Strength of Spurious Radiation

F) Repeat step E) for each spurious frequency with the test antenna polarized vertically

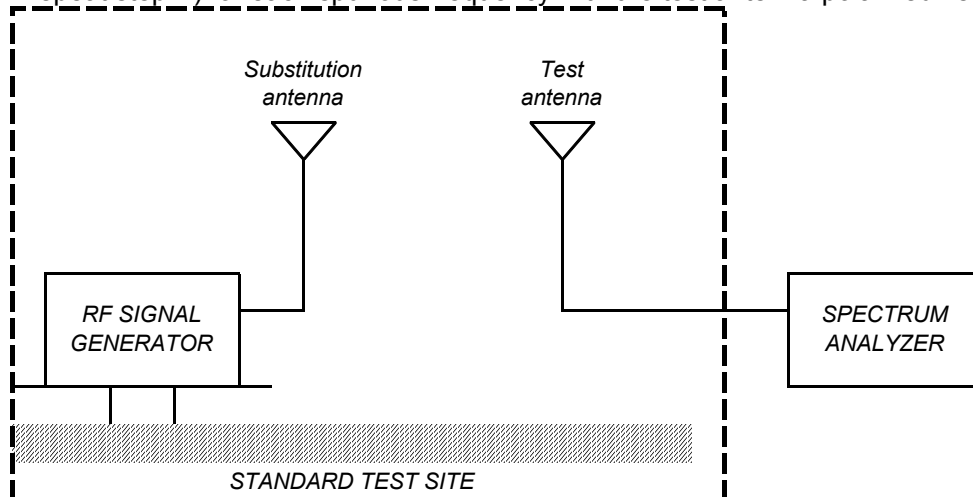

G) Reconnect the equipment as illustrated.

H) Keep the spectrum analyzer adjusted as in step B).

I) Remove the transmitter and replace it with a substitution antenna (the antenna should be half-wavelength for each frequency involved). The center of the substitution antenna should be approximately at the same location as the center of the transmitter. At lower frequencies, where the substitution antenna is very long, this will be impossible to achieve when the antenna is polarized vertically. In such case the lower end of the antenna should be 0.3m above the ground.

J) Feed the substitution antenna at the transmitter end with a signal generator connected to the antenna by means of a non-radiating cable. With the antennas at both ends horizontally polarized and with the signal generator tuned to a particular spurious frequency, raise and lower the test antenna to obtain a maximum reading at the spectrum analyzer. Adjust the level of the signal generator output until the previous recorded maximum reading for the set of conditions is obtained. This should be done carefully repeating the adjustment of the test antenna and generator output.

K) Repeat step J) with both antennas vertically polarized for each spurious frequency.

L) Calculate power in dBm into a reference ideal half-wave dipole antenna by reducing the readings obtained in step J) and K) by the power loss in the cable between the generator and the antenna and further corrected for the gain of the substitution antenna used relative to an ideal half-wave dipole antenna.

M) The levels recorded in step L) are absolute levels of radiated spurious emissions in dBm. The radiated spurious emissions in dB can be calculated by the following:

Radiated spurious emissions dB = $10\log(\text{TX power in watts}/0.001)$ - the levels in step L)

NAME OF TEST: Field Strength of Spurious Radiation

Note: It is permissible that other antennas provided can be referenced to a dipole.

Instruments	Description	Serial Number
TRANSDUCER	Schaffner-Chase CBL6143	***
TRANSDUCER	EMCO 3115	***
AMPLIFIER	Agilent 8447D	***
AMPLIFIER	Agilent 8449B	***
SPECTRUM ANALYZER	Agilent 8561B	***

NAME OF TEST: Field Strength of Spurious Radiation

LIMIT'S), dBc: $-(50+10 \times \text{LOG}(P)) = -57$ (5 Watts)
 $-(50+10 \times \text{LOG}(P)) = -50$ (1 Watts)

High Power

FREQUENCY TUNED, MHz	FREQUENCY EMISSION, MHz	METER, dBuV	C.F., dB	ERP, dBm	ERP, dBc
134.0000	268.0000	47.5	27.4	-32.1	-69.1
174.0000	348.0000	48.3	26.7	-32.0	-69.0

NAME OF TEST: Field Strength of Spurious Radiation

LIMIT'S), dBc: $-(50+10 \times \text{LOG}(P)) = -57$ (5 Watts)
 $-(50+10 \times \text{LOG}(P)) = -50$ (1 Watts)

Low Power

FREQUENCY TUNED, MHz	FREQUENCY EMISSION, MHz	METER, dBuV	C.F., dB	ERP, dBm	ERP, dBc
134.0000	268.0000	41.2	27.4	-38.4	-68.4



NAME OF TEST: Emission Masks (Occupied Bandwidth)
SPECIFICATION: 47 CFR 2.1049 (c) (1)
GUIDE: ANSI/TIA/EIA-603, Paragraph 2.2.11
TEST EQUIPMENT: As per previous page

MEASUREMENT PROCEDURE

1. The EUT and test equipment were set up as shown on the following page, with the spectrum analyzer connected.
2. For EUT's supporting audio modulation, the audio signal generator was adjusted to the frequency of maximum response and with output level set for $\pm 2.5/\pm 1.5$ kHz deviation (or 50% modulation). With level constant, the signal level was increased 16dB.
3. For EUT's supporting digital modulation, the digital modulation mode was operated to its maximum extent.
4. The occupied bandwidth was measured with the spectrum analyzer controls set as shown on the test results.
5. MEASUREMENT RESULTS: ATTACHED

NAME OF TEST: Emission Masks (Occupied Bandwidth)

STATE: 1 : High Power

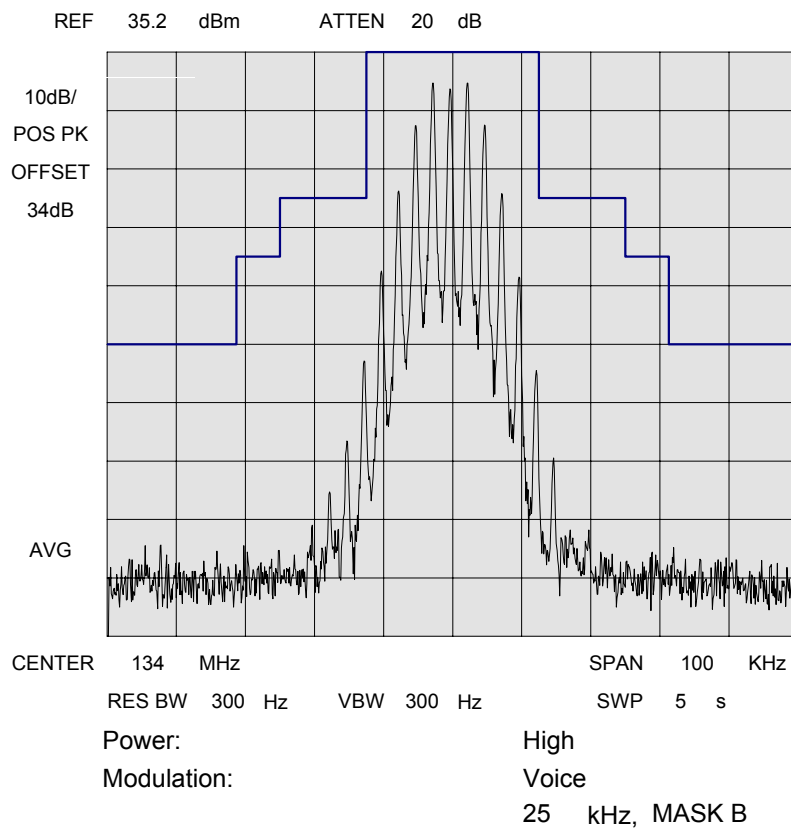
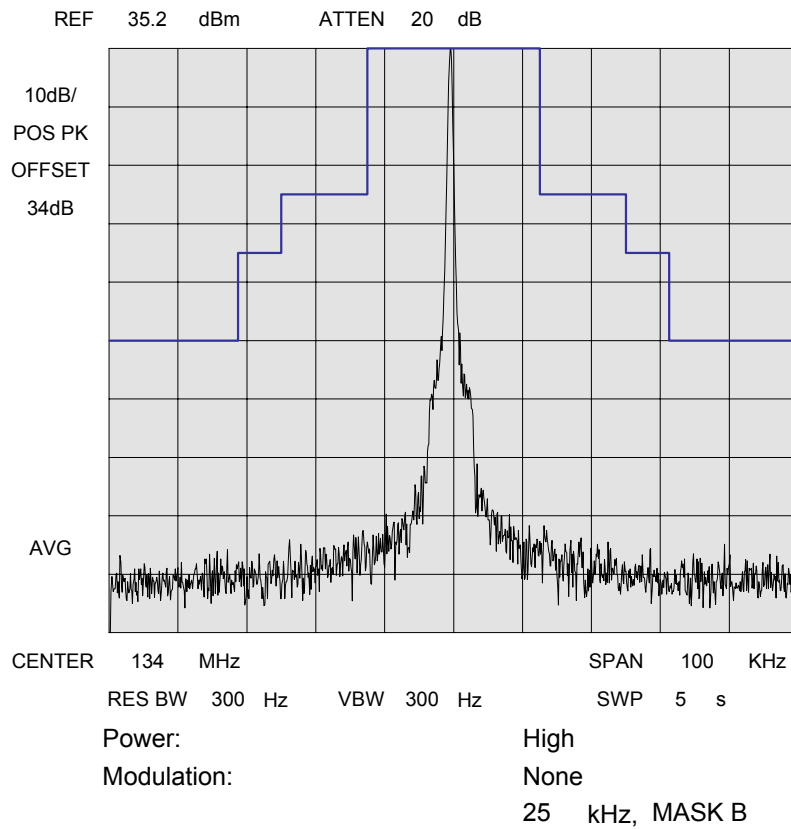

NAME OF TEST: Emission Masks (Occupied Bandwidth)

STATE: 1 : High Power

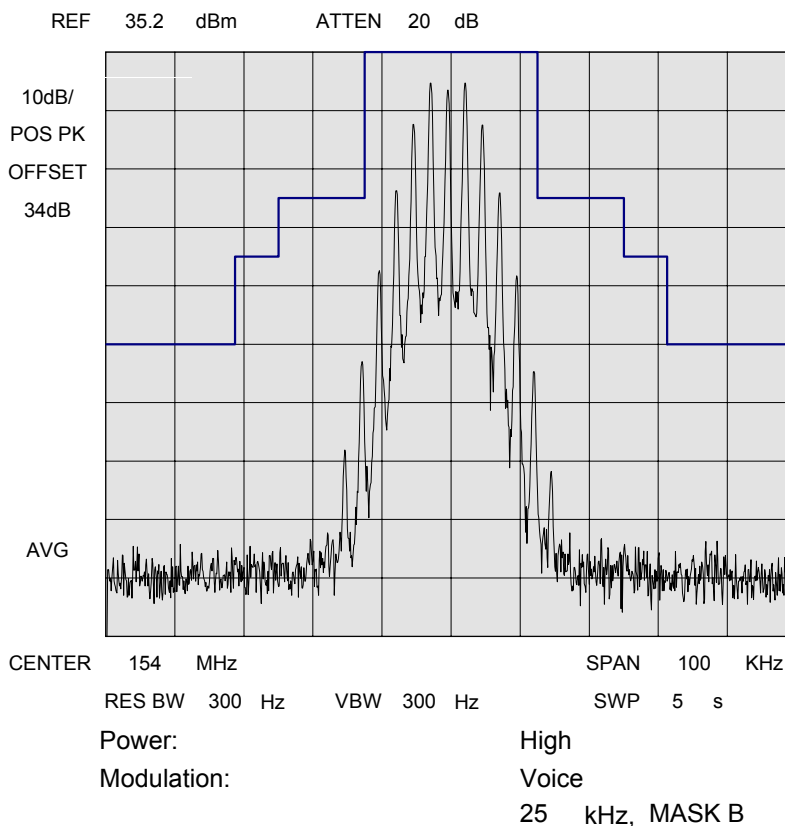
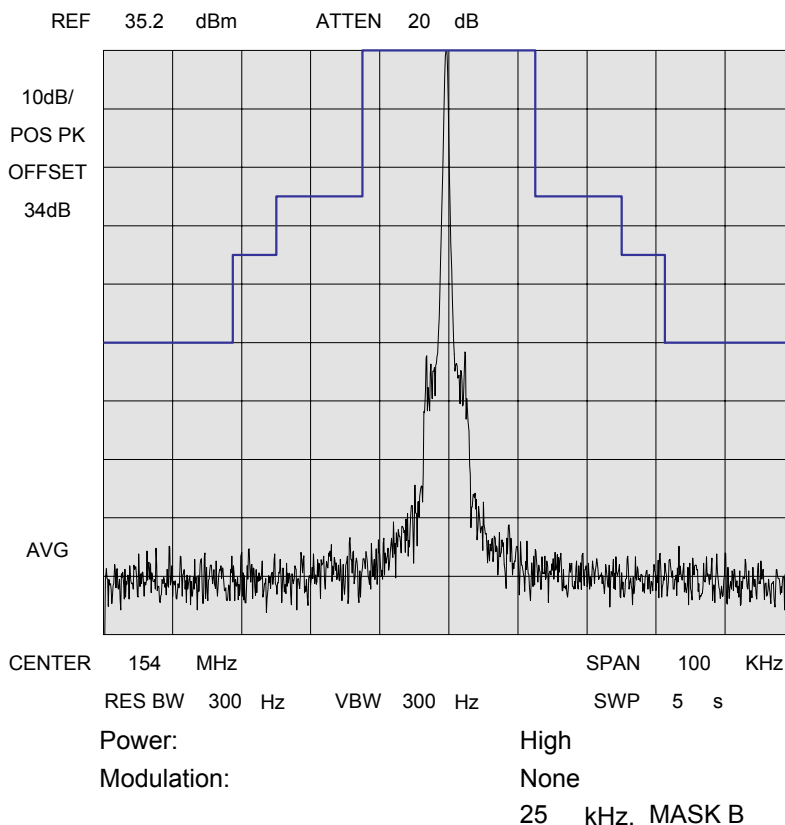

NAME OF TEST: Emission Masks (Occupied Bandwidth)

STATE: 1 : High Power

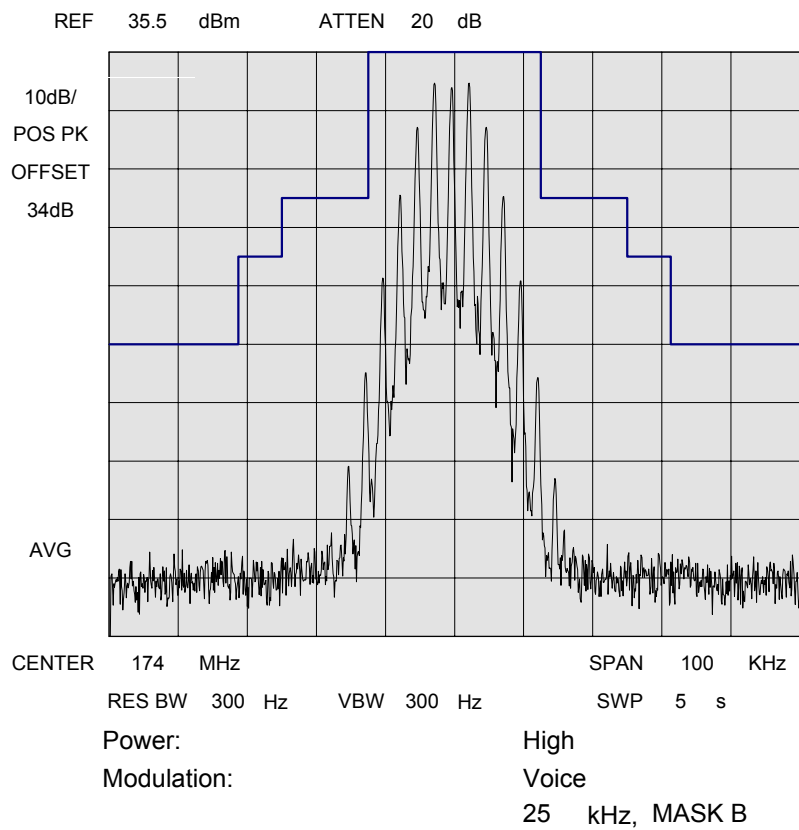
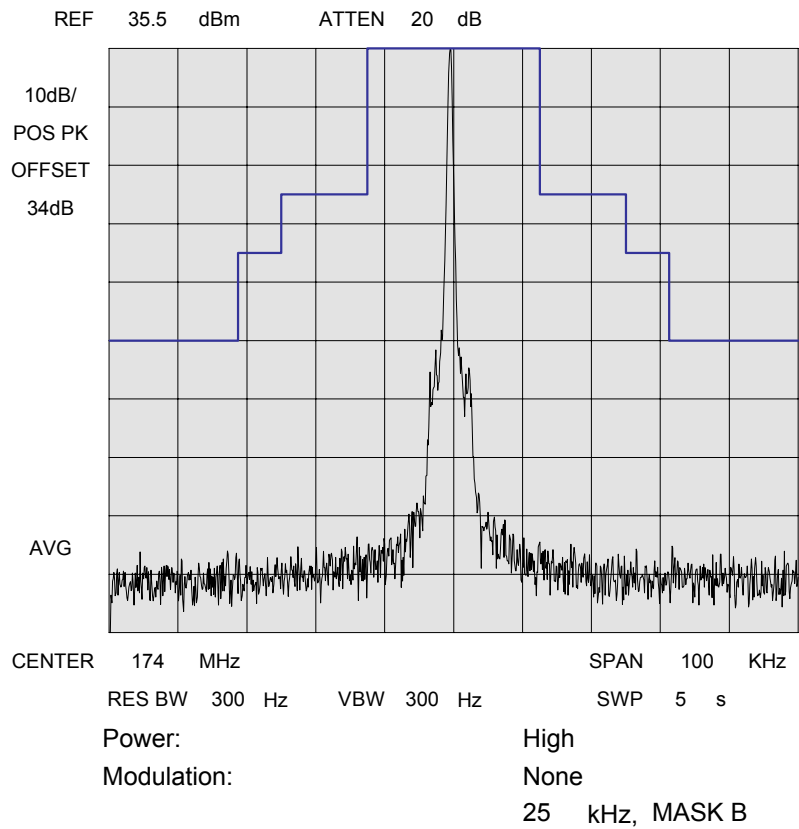

NAME OF TEST: Emission Masks (Occupied Bandwidth)

STATE: 2 : Low Power

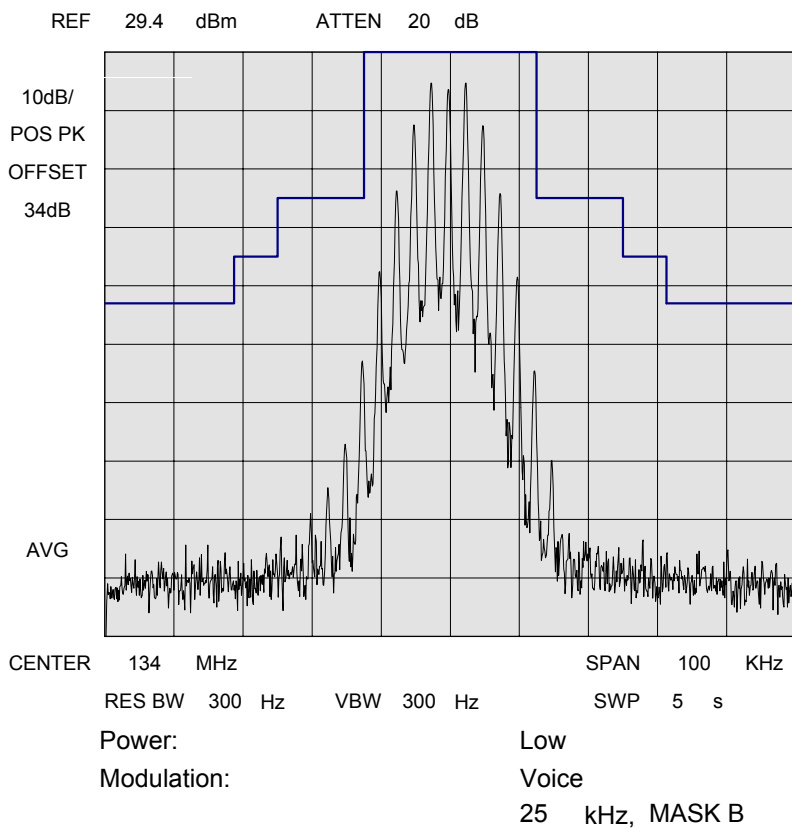
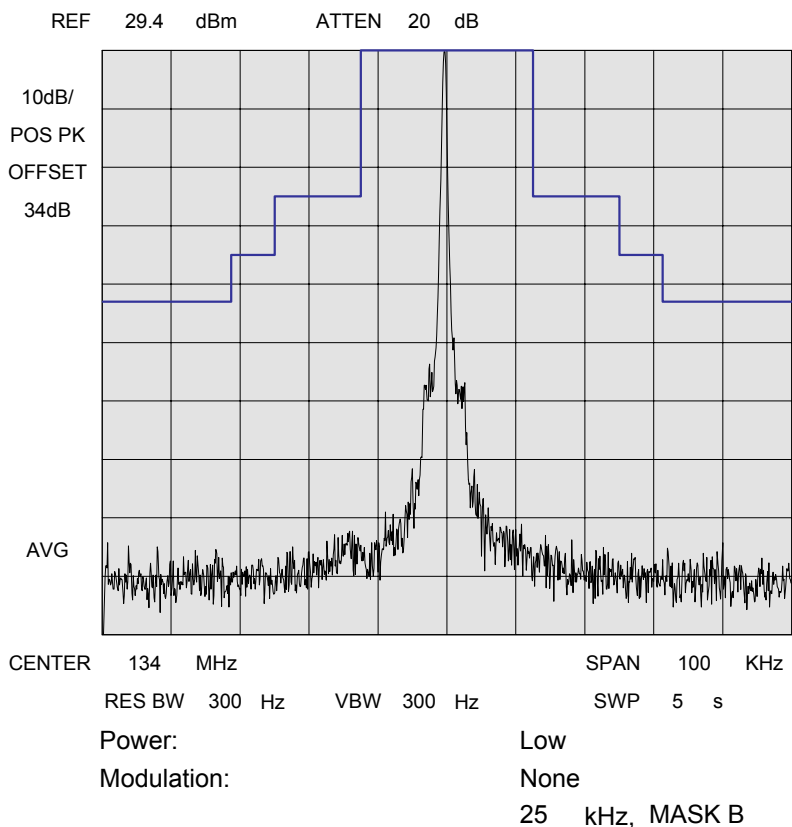

NAME OF TEST: Emission Masks (Occupied Bandwidth)

STATE: 2 : Low Power

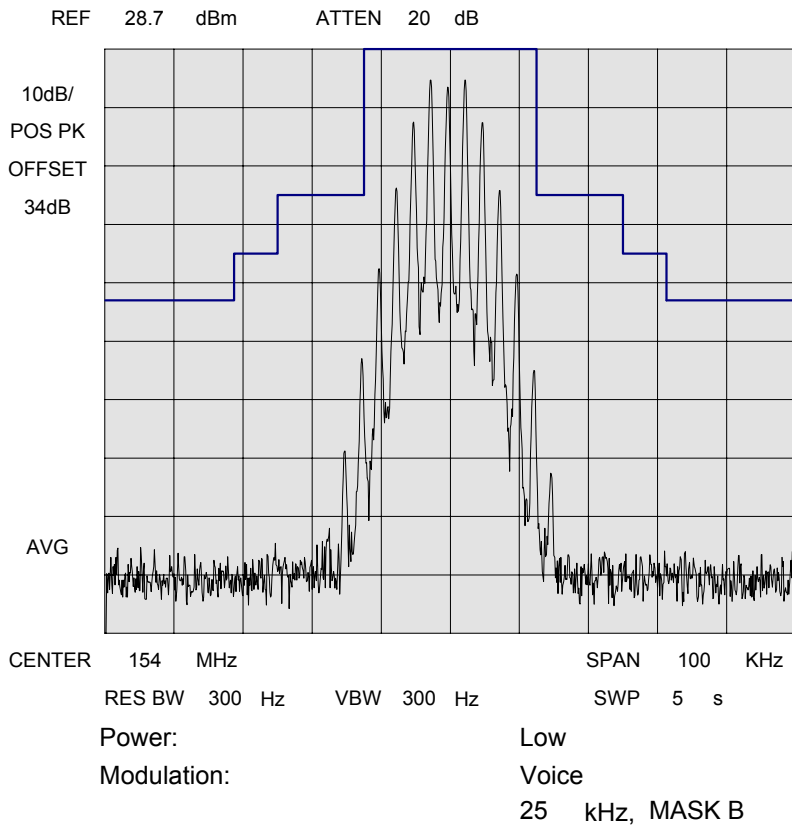
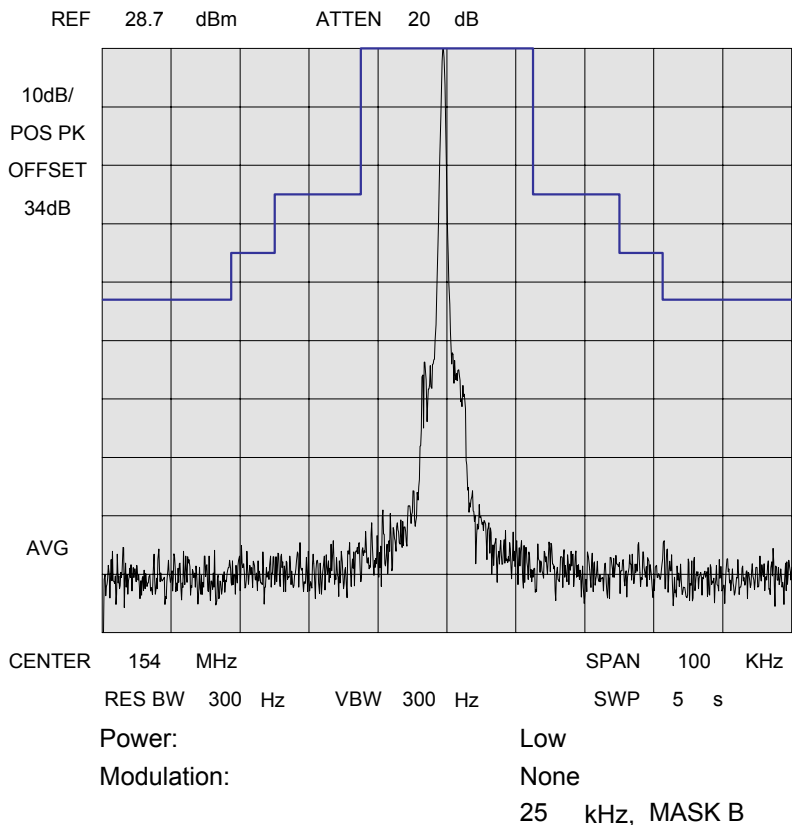

NAME OF TEST: Emission Masks (Occupied Bandwidth)

STATE: 2 : Low Power

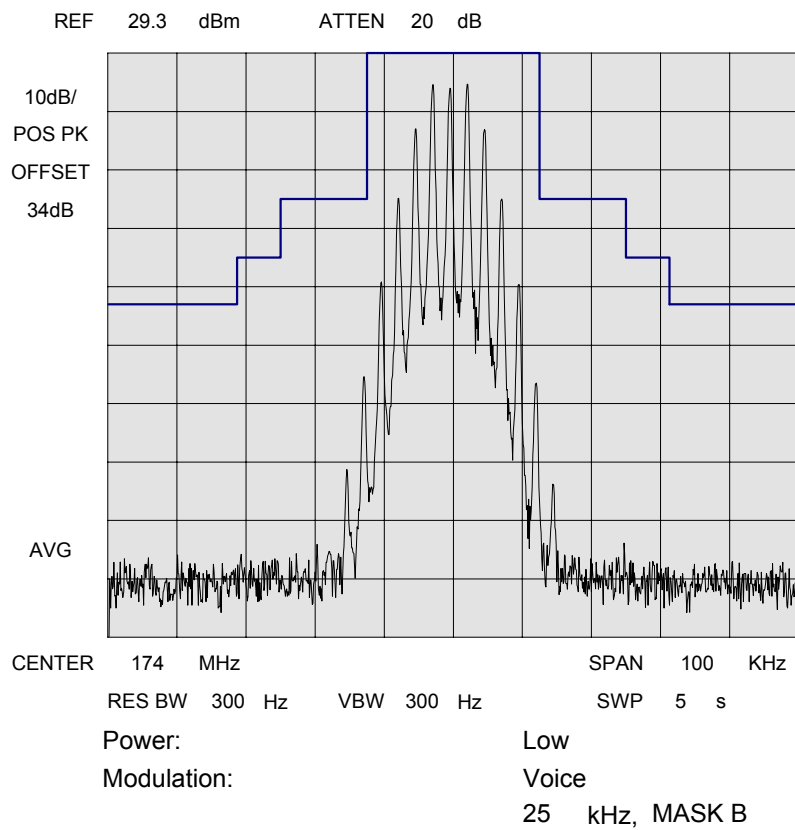
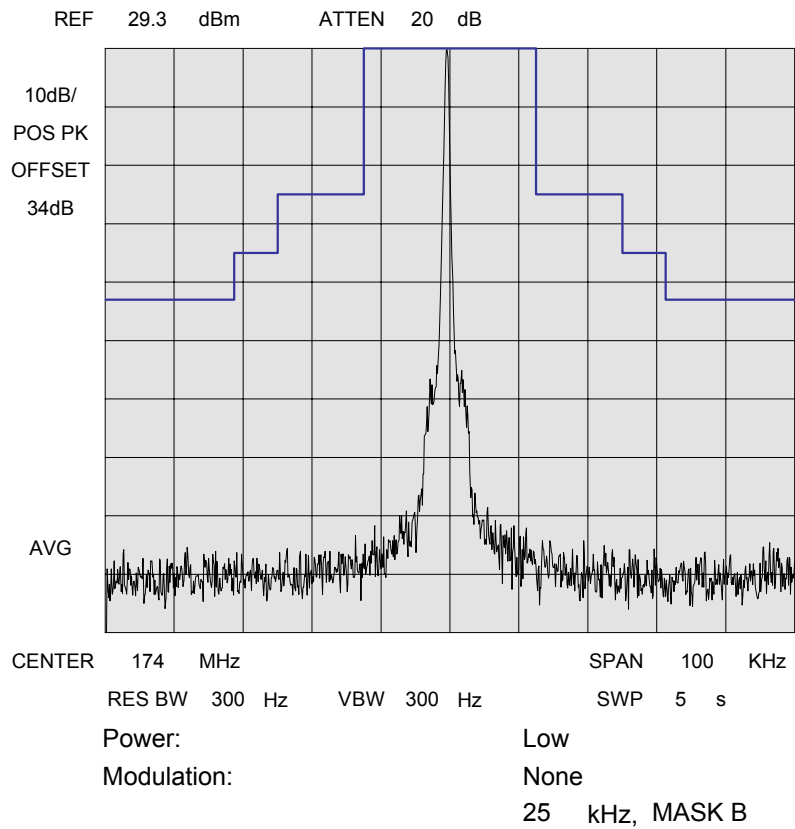

NAME OF TEST: Emission Masks (Occupied Bandwidth)

STATE: 1 : High Power

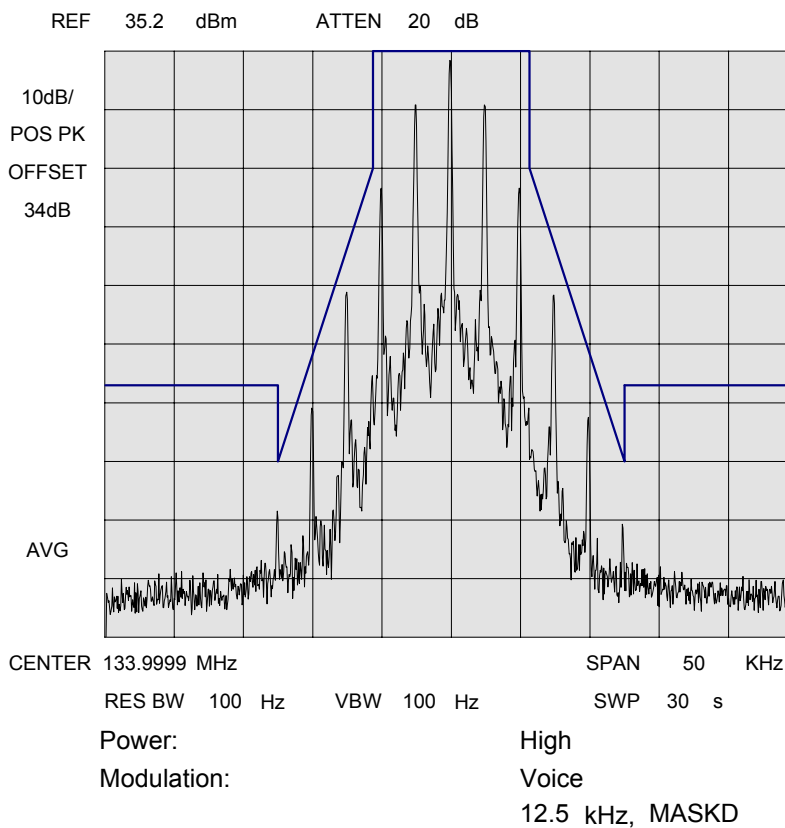
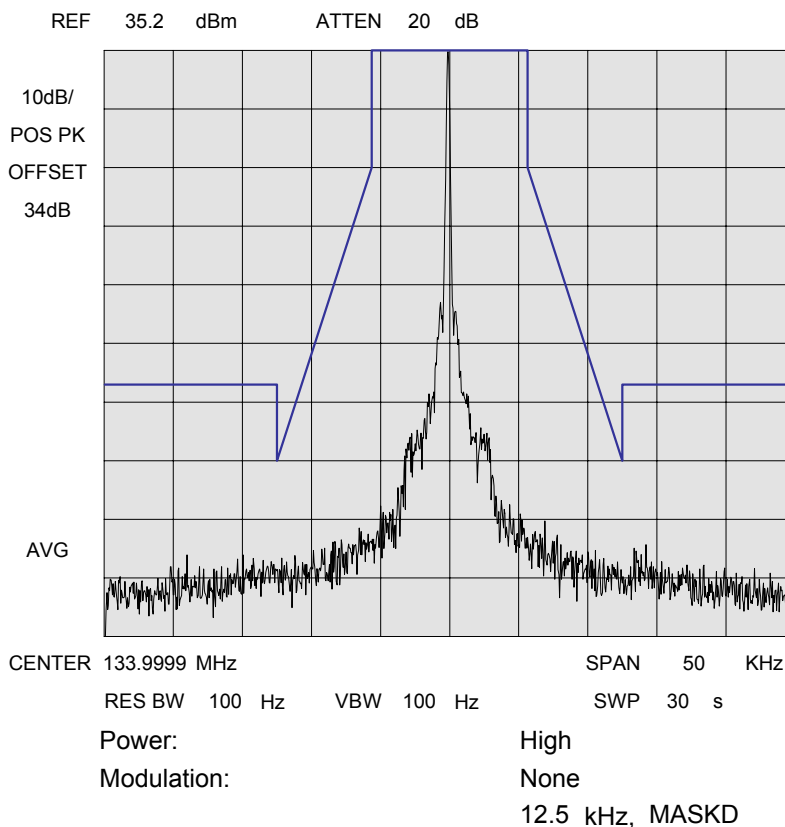

NAME OF TEST: Emission Masks (Occupied Bandwidth)

STATE: 1 : High Power

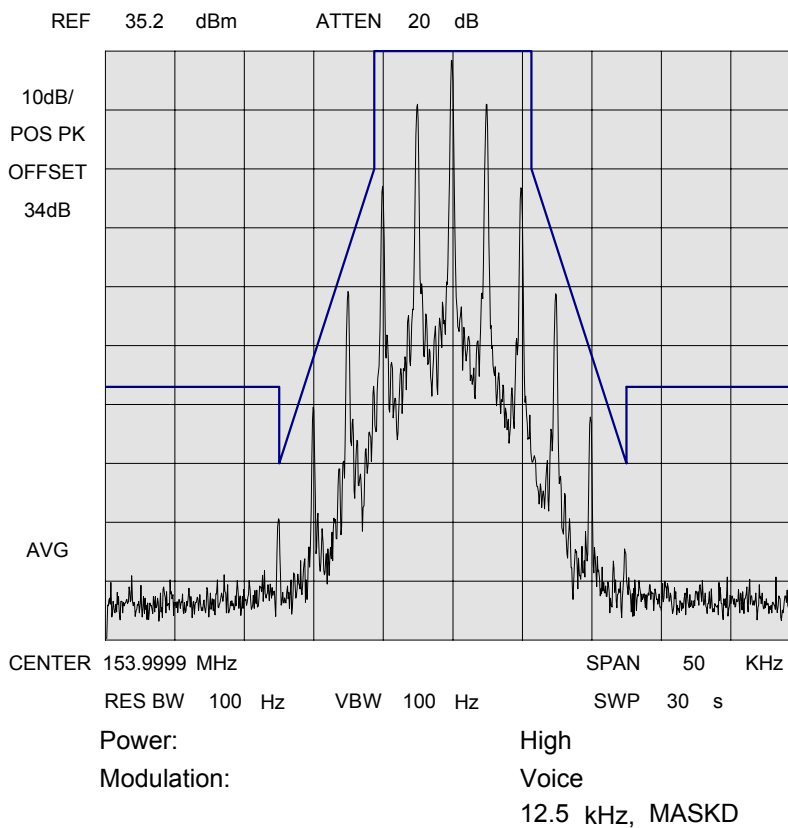
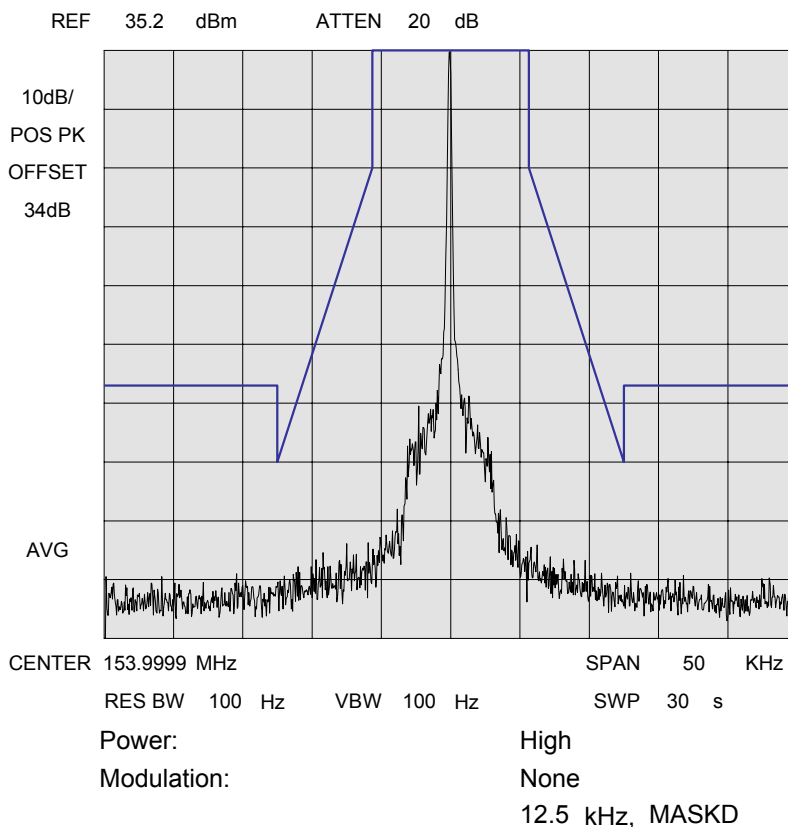

NAME OF TEST: Emission Masks (Occupied Bandwidth)

STATE: 1 : High Power

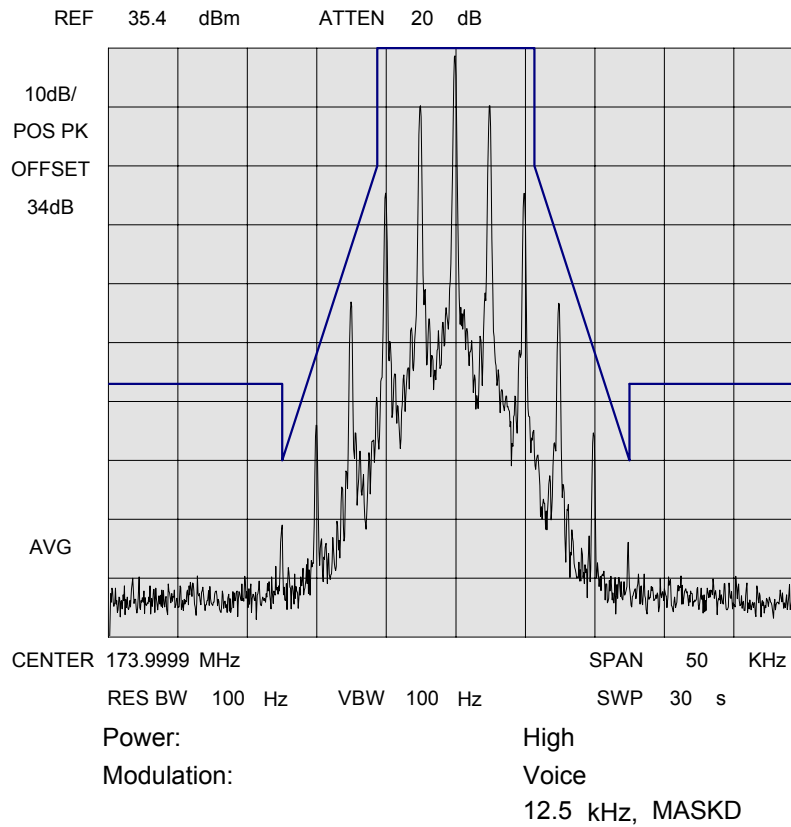
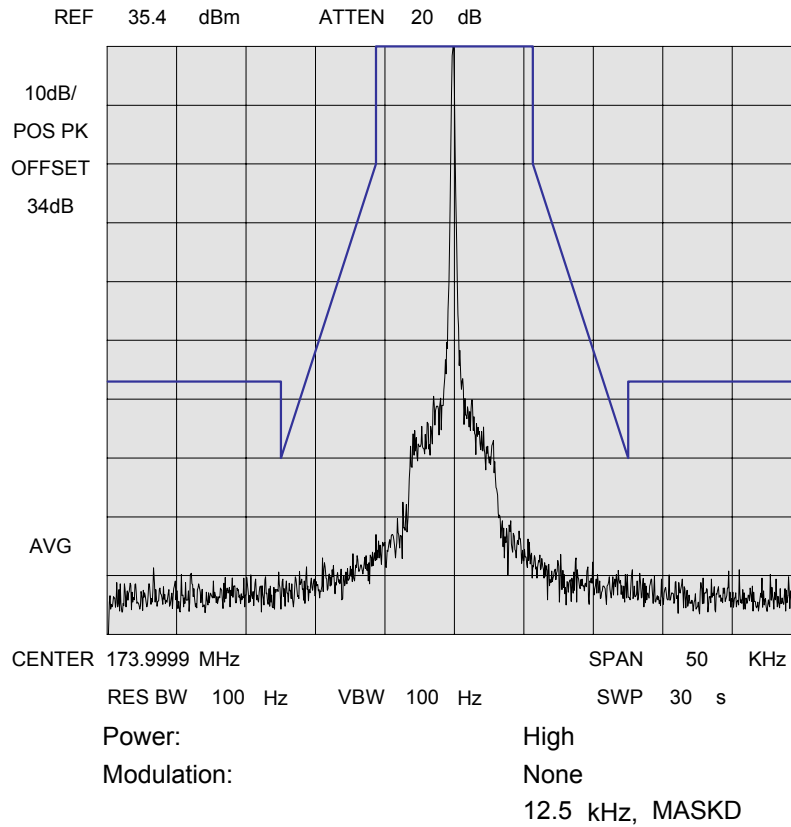

NAME OF TEST: Emission Masks (Occupied Bandwidth)

STATE: 2 : Low Power

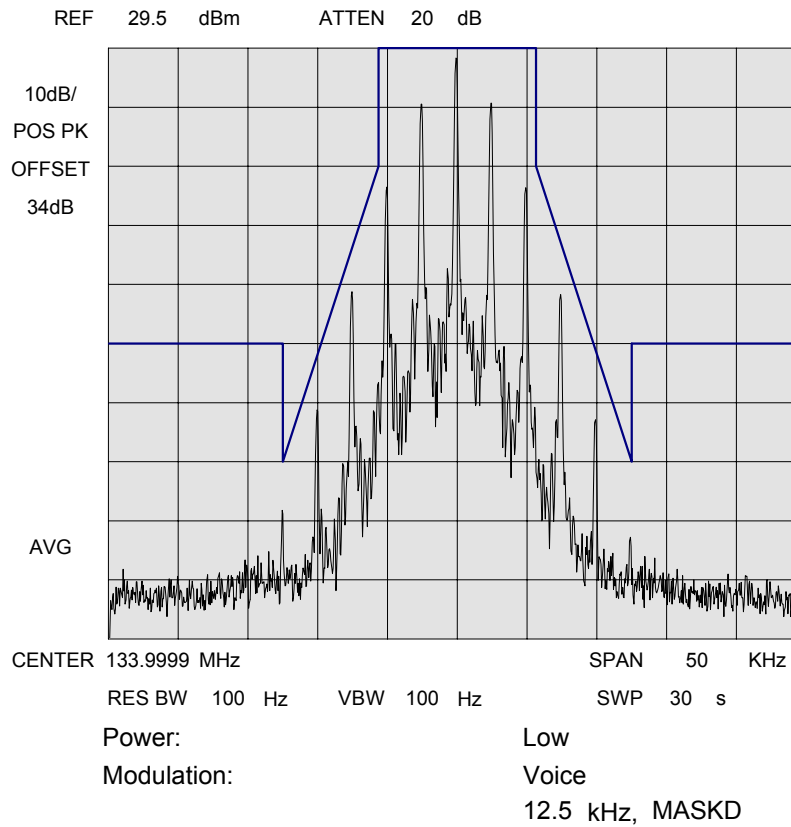
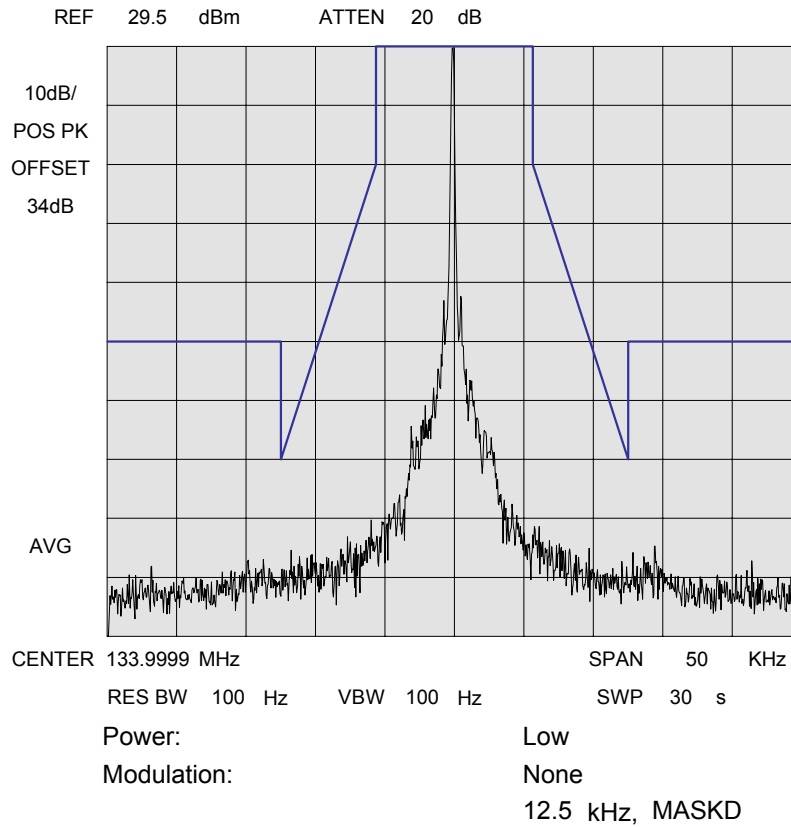

NAME OF TEST: Emission Masks (Occupied Bandwidth)

STATE: 2 : Low Power

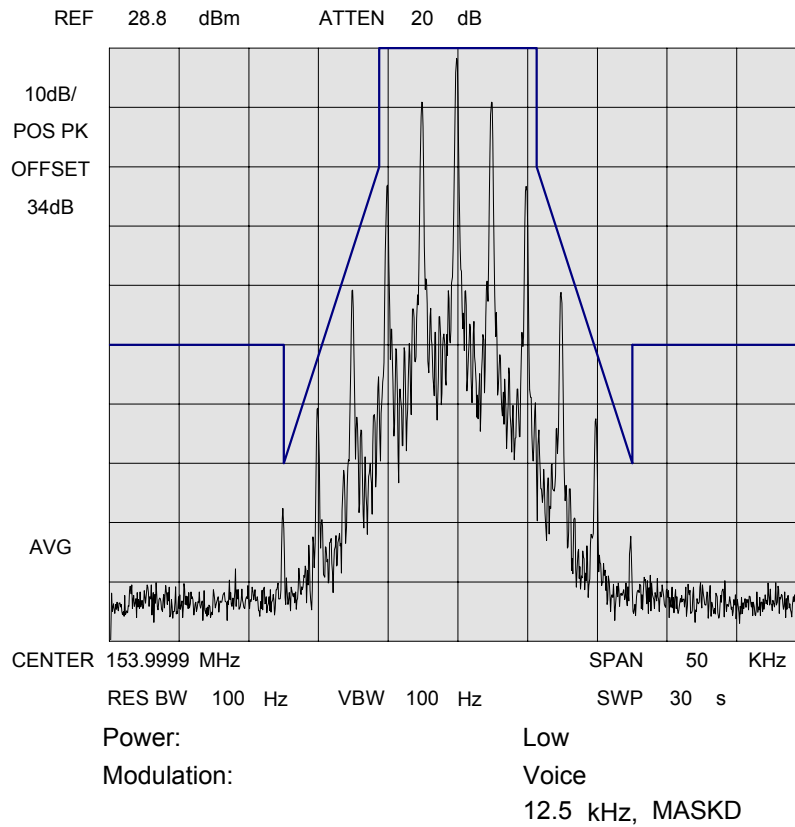
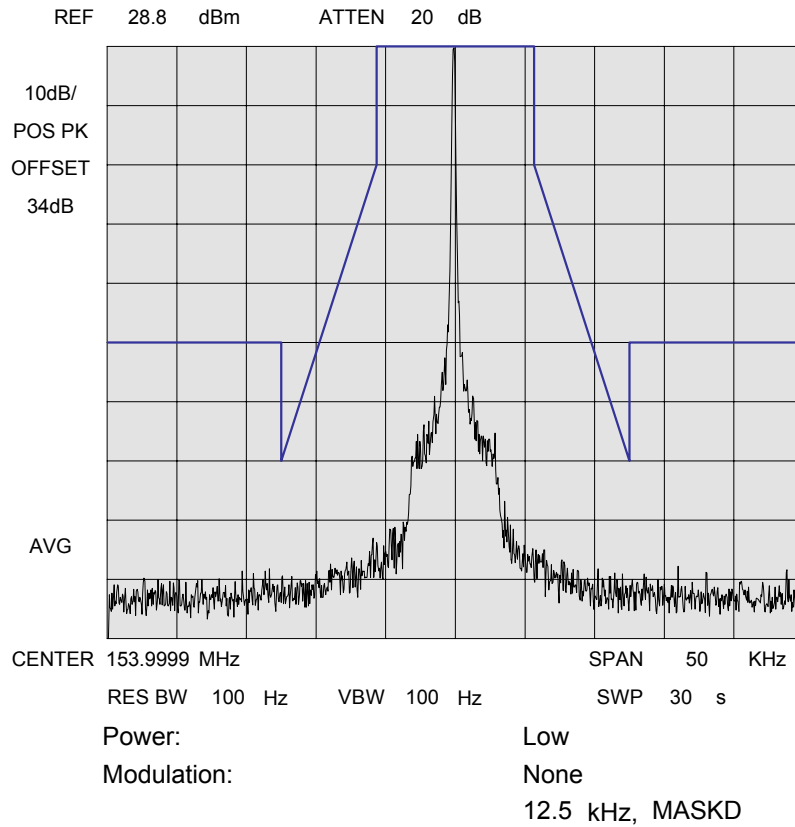

NAME OF TEST: Emission Masks (Occupied Bandwidth)

STATE: 2 : Low Power

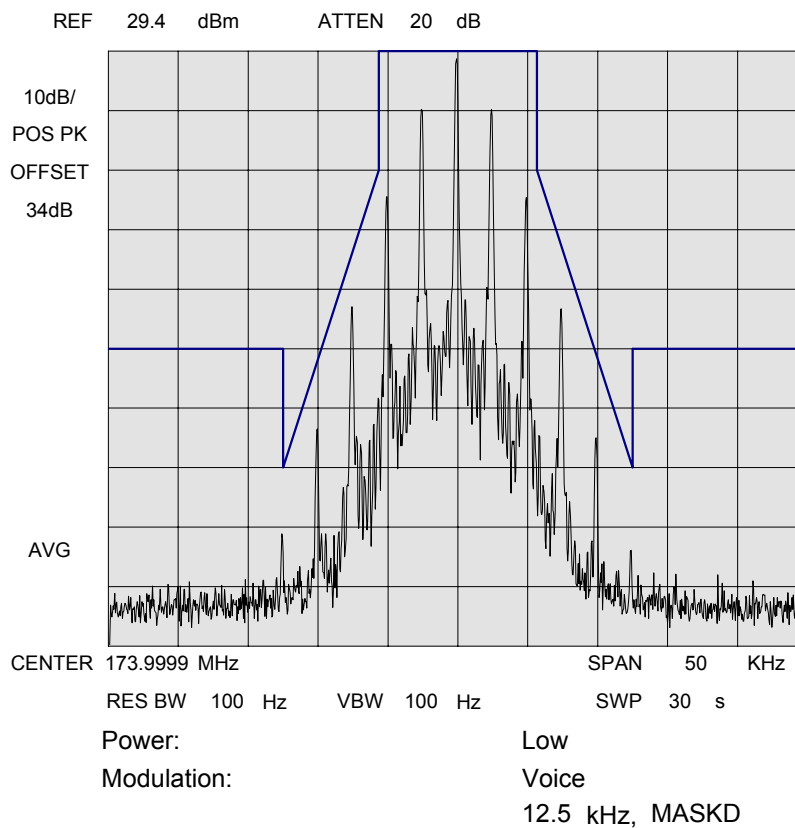
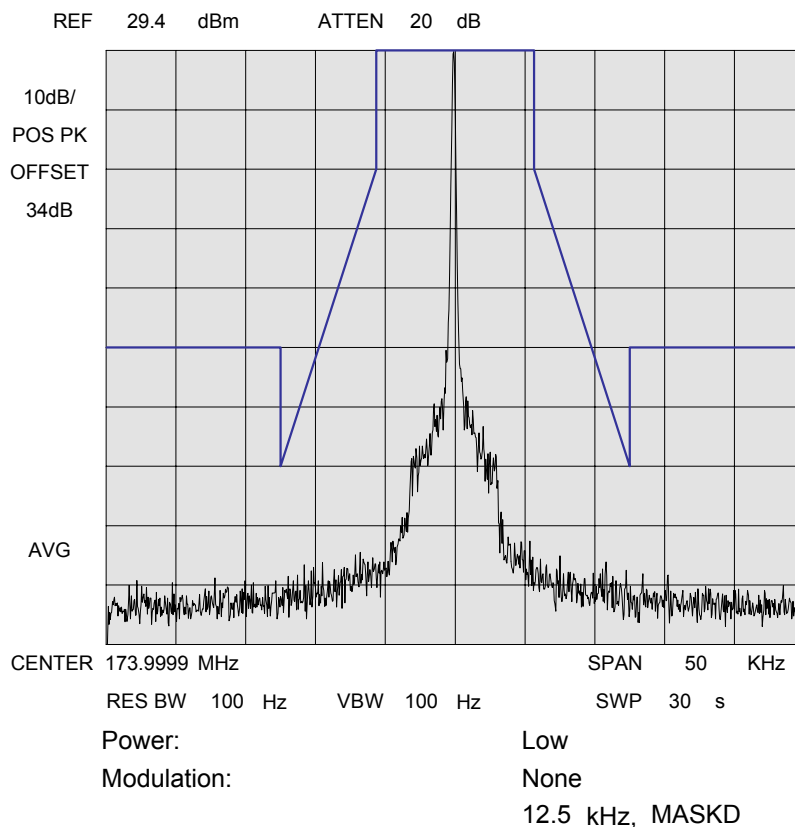

TRANSIENT FREQUENCY BEHAVIOR

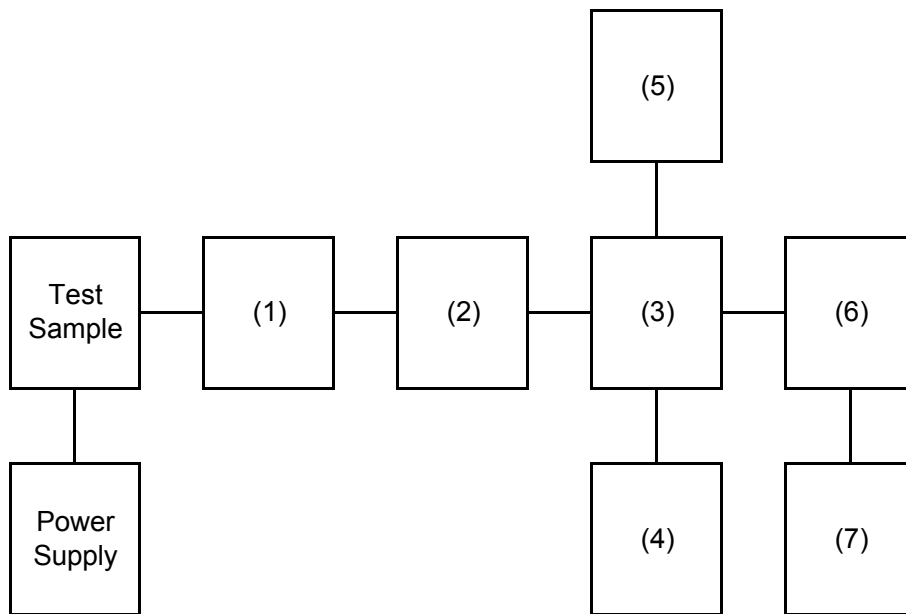

Instruments	Description	Serial Number
(1) COAXIAL ATTENUATOR	WEINSHELL 49-10-43	***
(2) COAXIAL ATTENUATOR	WEINSHELL 49-10-43	***
(3) COMBINER	IWATSU B-504D	***
(4) CRYSTAL DETECTOR	Agilent 8470B	***
(5) RF SIGNAL GENERATOR	Agilent 8642B	***
(5) MODULATION ANALYZER	Agilent 8901B	***
(5) SCOPE	Agilent 54504A	***

NAME OF TEST: Transient Frequency Behaviour

STATE: 1 : High Power

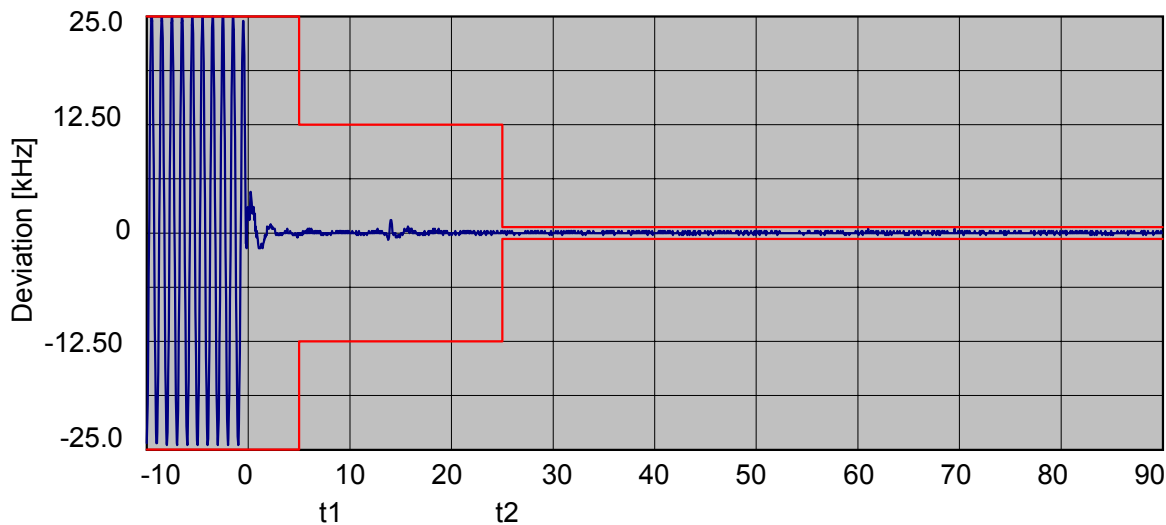

<u>Model Name:</u>	<u>VX-929-D0-5</u>	<u>Type:</u>	<u>Mobile/Portable</u>
<u>Serial Number:</u>	<u>4M000008</u>	<u>Trigger Direction:</u>	<u>Rise</u>
<u>Test Frequency:</u>	<u>134</u>		
<u>Channel Spacing:</u>	<u>25</u>	<u>Ref. Standard</u>	<u>EIA</u>

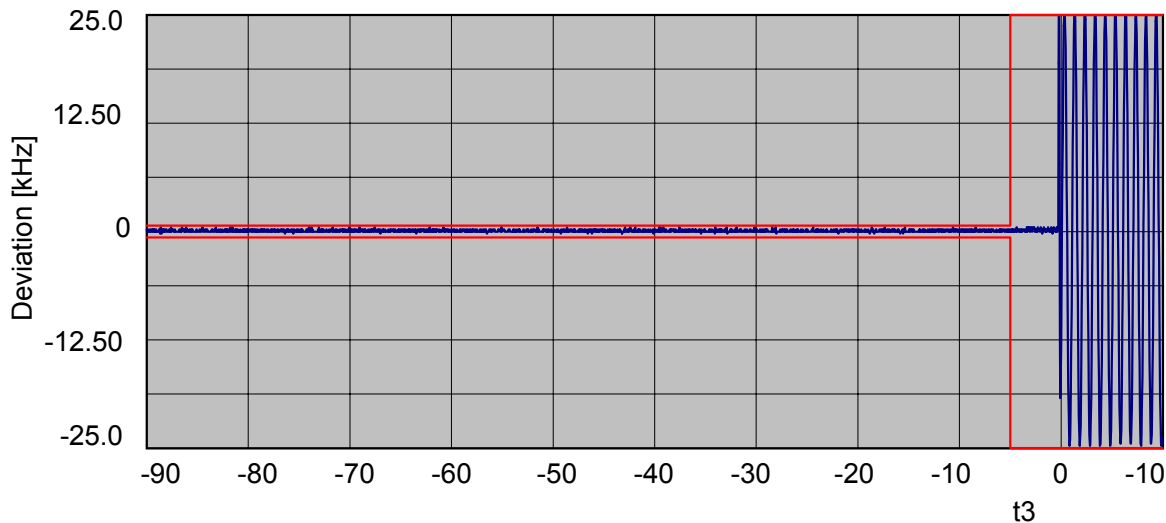

<u>Model Name:</u>	<u>VX-929-D0-5</u>	<u>Type:</u>	<u>Mobile/Portable</u>
<u>Serial Number:</u>	<u>4M000008</u>	<u>Trigger Direction:</u>	<u>Fall</u>
<u>Test Frequency:</u>	<u>134</u>		
<u>Channel Spacing:</u>	<u>25</u>	<u>Ref. Standard</u>	<u>EIA</u>

NAME OF TEST: Transient Frequency Behaviour

STATE: 1 : High Power

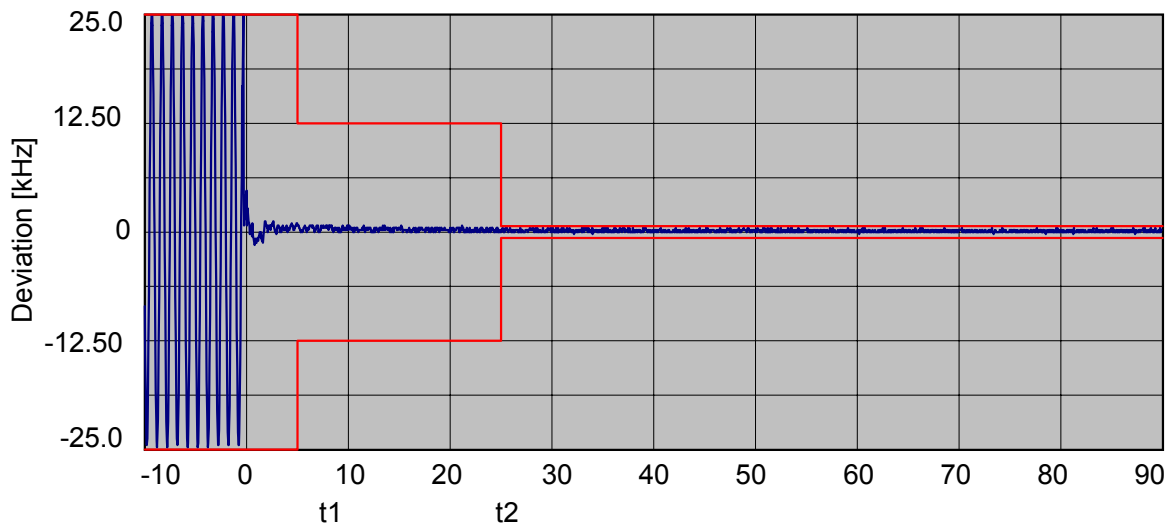

<u>Model Name:</u>	<u>VX-929-D0-5</u>	<u>Type:</u>	<u>Mobile/Portable</u>
<u>Serial Number:</u>	<u>4M000008</u>	<u>Trigger Direction:</u>	<u>Rise</u>
<u>Test Frequency:</u>	<u>154</u>		
<u>Channel Spacing:</u>	<u>25</u>	<u>Ref. Standard</u>	<u>EIA</u>

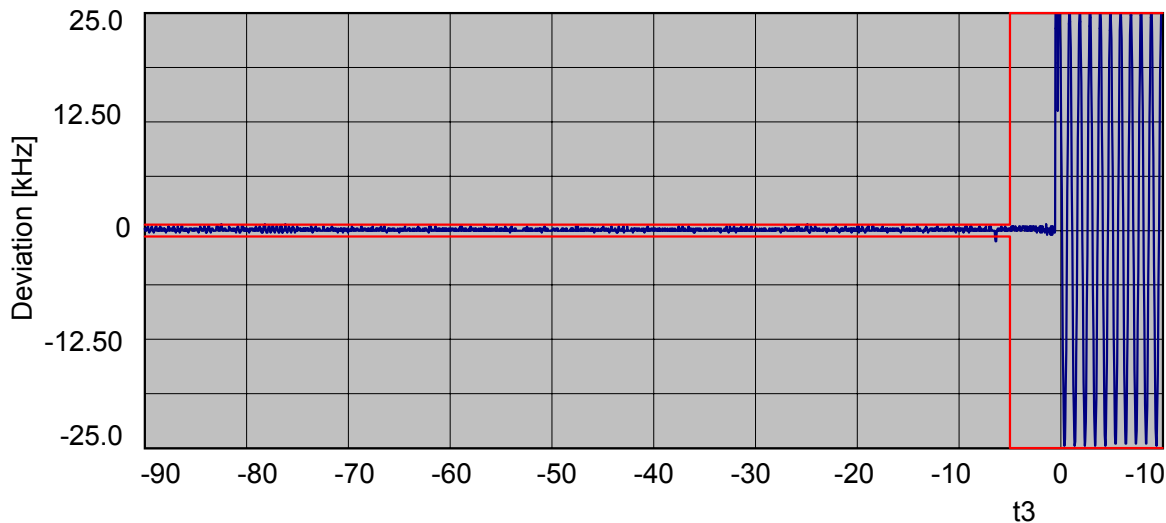

<u>Model Name:</u>	<u>VX-929-D0-5</u>	<u>Type:</u>	<u>Mobile/Portable</u>
<u>Serial Number:</u>	<u>4M000008</u>	<u>Trigger Direction:</u>	<u>Fall</u>
<u>Test Frequency:</u>	<u>154</u>		
<u>Channel Spacing:</u>	<u>25</u>	<u>Ref. Standard</u>	<u>EIA</u>

NAME OF TEST: Transient Frequency Behaviour

STATE: 1 : High Power

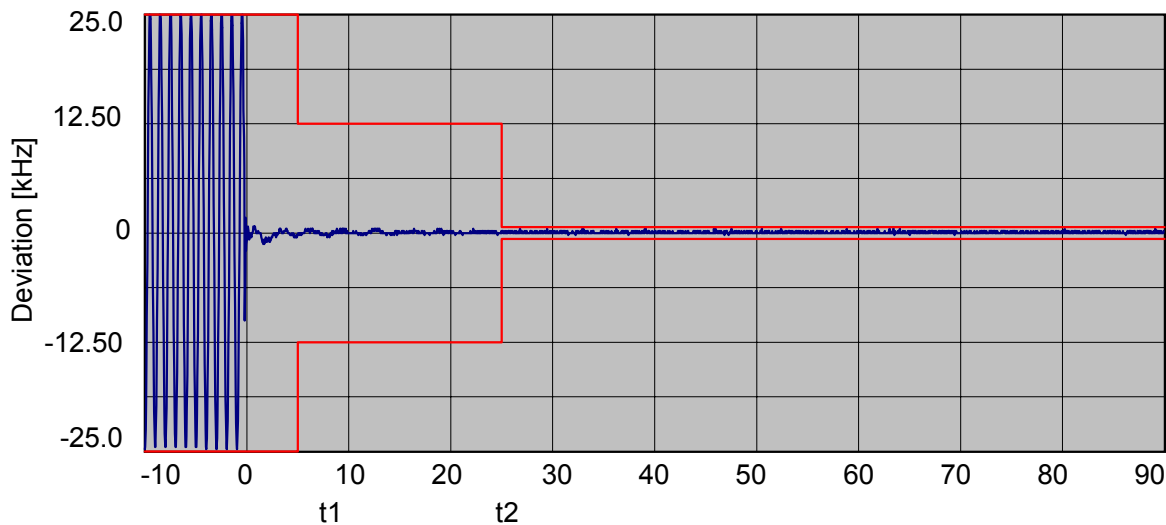

<u>Model Name:</u>	<u>VX-929-D0-5</u>	<u>Type:</u>	<u>Mobile/Portable</u>
<u>Serial Number:</u>	<u>4M000008</u>	<u>Trigger Direction:</u>	<u>Rise</u>
<u>Test Frequency:</u>	<u>174</u>		
<u>Channel Spacing:</u>	<u>25</u>	<u>Ref. Standard</u>	<u>EIA</u>

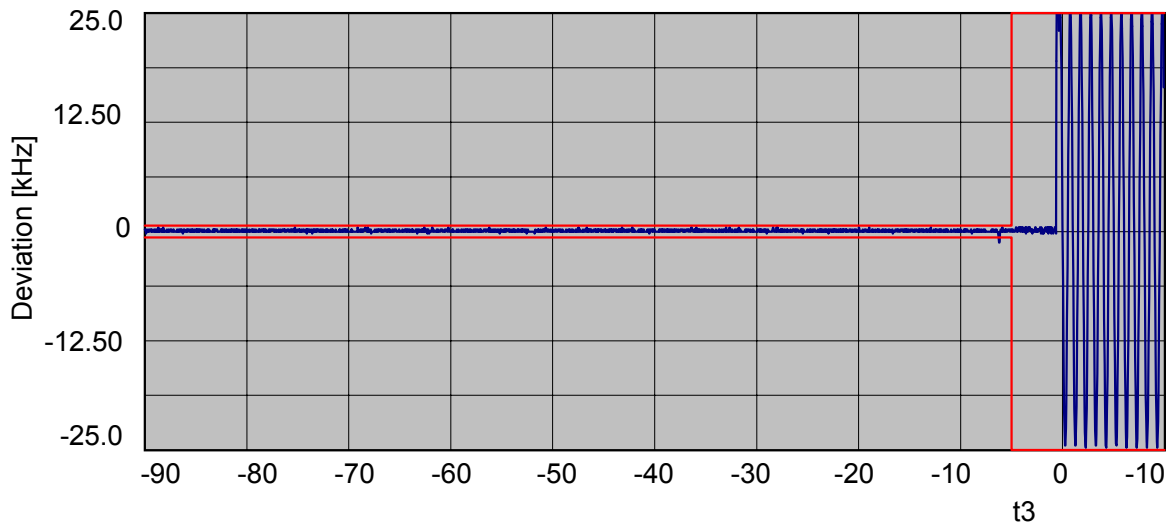

<u>Model Name:</u>	<u>VX-929-D0-5</u>	<u>Type:</u>	<u>Mobile/Portable</u>
<u>Serial Number:</u>	<u>4M000008</u>	<u>Trigger Direction:</u>	<u>Fall</u>
<u>Test Frequency:</u>	<u>174</u>		
<u>Channel Spacing:</u>	<u>25</u>	<u>Ref. Standard</u>	<u>EIA</u>

NAME OF TEST: Transient Frequency Behaviour

STATE: 1 : High Power

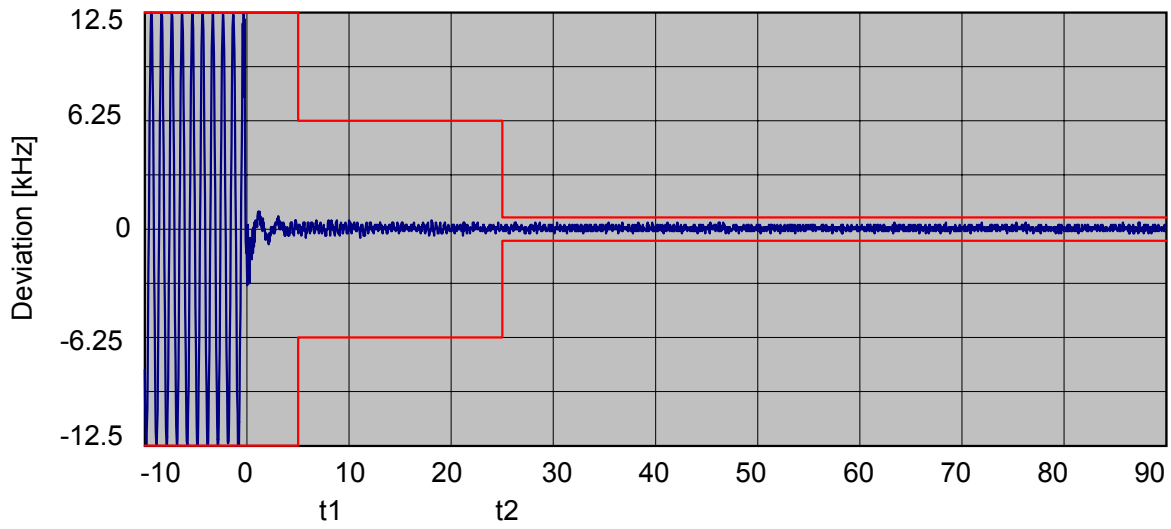

<u>Model Name:</u>	<u>VX-929-D0-5</u>	<u>Type:</u>	<u>Mobile/Portable</u>
<u>Serial Number:</u>	<u>4M000008</u>	<u>Trigger Direction:</u>	<u>Rise</u>
<u>Test Frequency:</u>	<u>134</u>		
<u>Channel Spacing:</u>	<u>12.5</u>	<u>Ref. Standard</u>	<u>EIA</u>

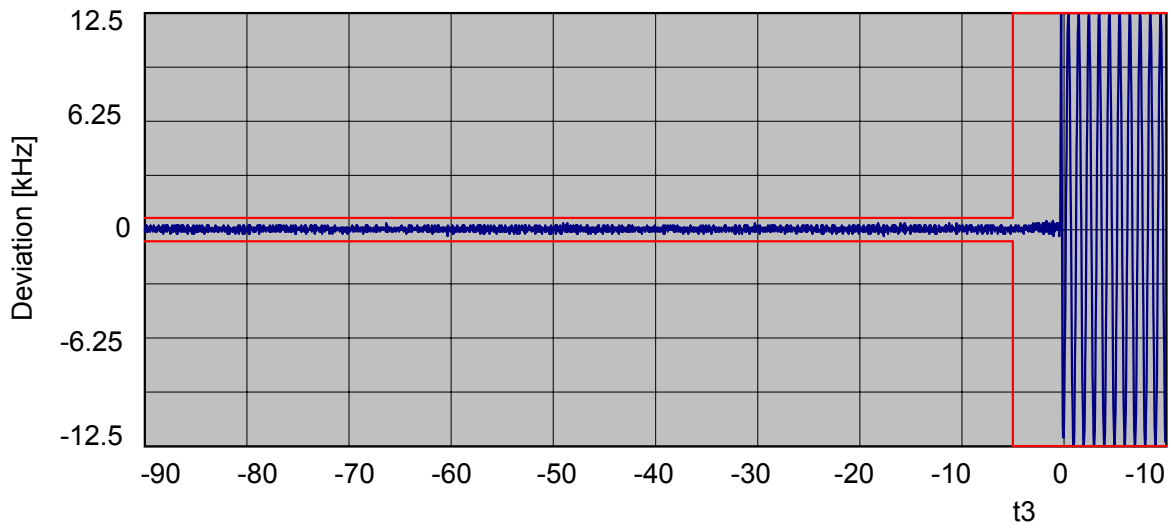

<u>Model Name:</u>	<u>VX-929-D0-5</u>	<u>Type:</u>	<u>Mobile/Portable</u>
<u>Serial Number:</u>	<u>4M000008</u>	<u>Trigger Direction:</u>	<u>Fall</u>
<u>Test Frequency:</u>	<u>134</u>		
<u>Channel Spacing:</u>	<u>12.5</u>	<u>Ref. Standard</u>	<u>EIA</u>

NAME OF TEST: Transient Frequency Behaviour

STATE: 1 : High Power

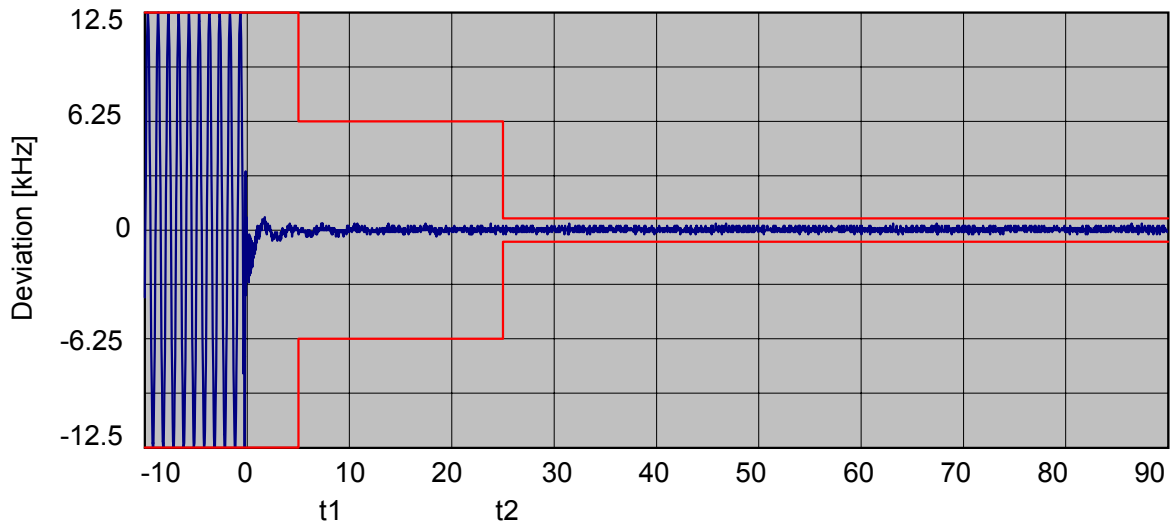

<u>Model Name:</u>	<u>VX-929-D0-5</u>	<u>Type:</u>	<u>Mobile/Portable</u>
<u>Serial Number:</u>	<u>4M000008</u>	<u>Trigger Direction:</u>	<u>Rise</u>
<u>Test Frequency:</u>	<u>154</u>		
<u>Channel Spacing:</u>	<u>12.5</u>	<u>Ref. Standard</u>	<u>EIA</u>

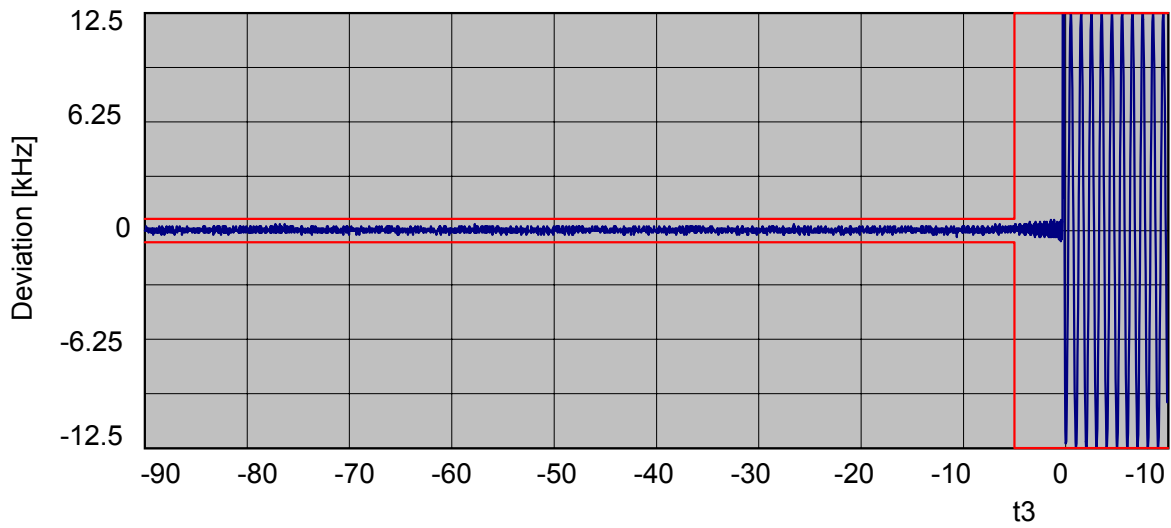

<u>Model Name:</u>	<u>VX-929-D0-5</u>	<u>Type:</u>	<u>Mobile/Portable</u>
<u>Serial Number:</u>	<u>4M000008</u>	<u>Trigger Direction:</u>	<u>Fall</u>
<u>Test Frequency:</u>	<u>154</u>		
<u>Channel Spacing:</u>	<u>12.5</u>	<u>Ref. Standard</u>	<u>EIA</u>

NAME OF TEST: Transient Frequency Behaviour

STATE: 1 : High Power

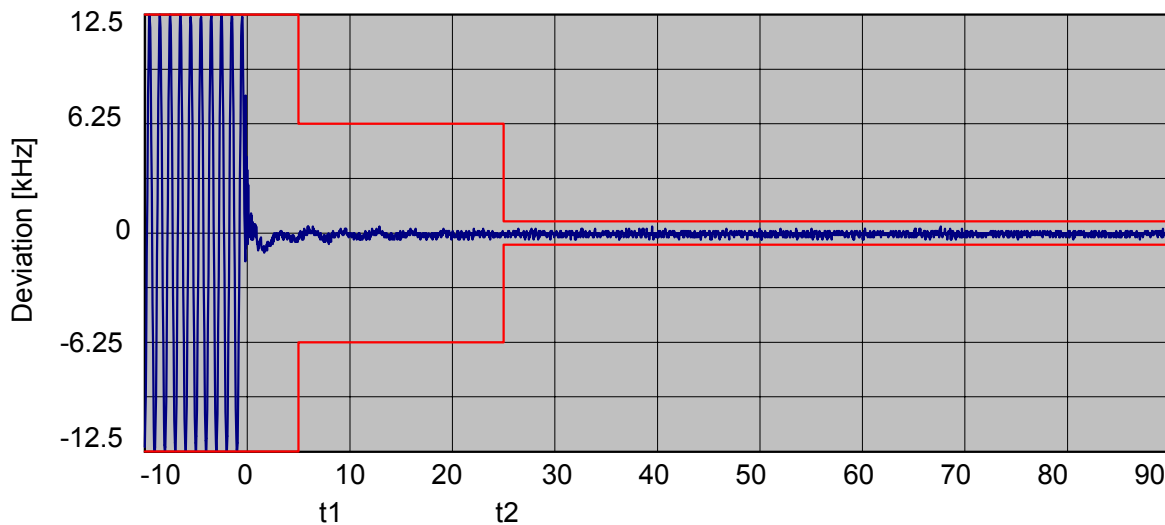

<u>Model Name:</u>	<u>VX-929-D0-5</u>	<u>Type:</u>	<u>Mobile/Portable</u>
<u>Serial Number:</u>	<u>4M000008</u>	<u>Trigger Direction:</u>	<u>Rise</u>
<u>Test Frequency:</u>	<u>174</u>		
<u>Channel Spacing:</u>	<u>12.5</u>	<u>Ref. Standard</u>	<u>EIA</u>

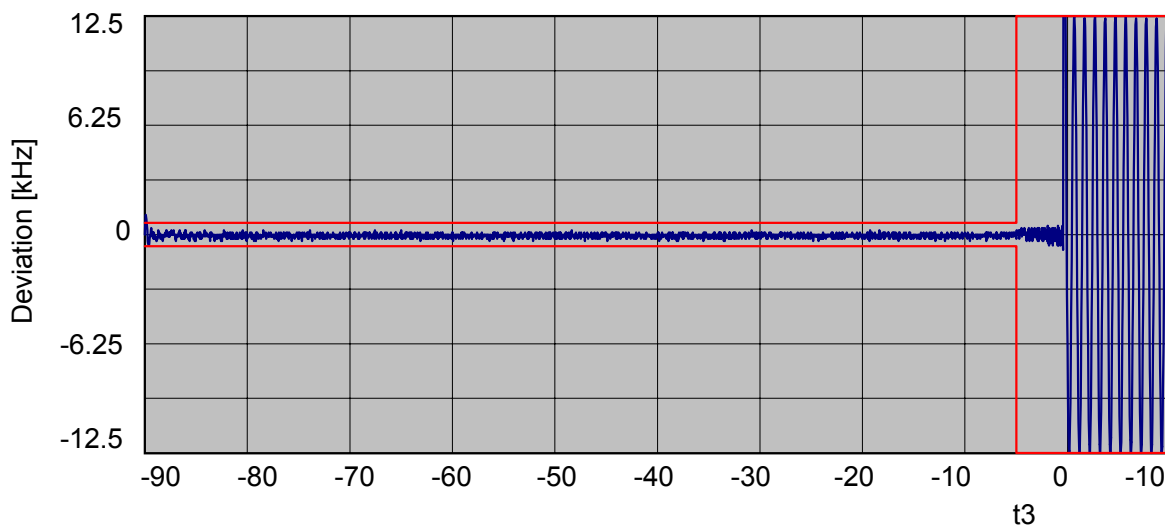

<u>Model Name:</u>	<u>VX-929-D0-5</u>	<u>Type:</u>	<u>Mobile/Portable</u>
<u>Serial Number:</u>	<u>4M000008</u>	<u>Trigger Direction:</u>	<u>Fall</u>
<u>Test Frequency:</u>	<u>174</u>		
<u>Channel Spacing:</u>	<u>12.5</u>	<u>Ref. Standard</u>	<u>EIA</u>

NAME OF TEST: Audio Low Pass Filter (Voice Input)
SPECIFICATION: 47 CFR 2.1047 (a)
GUIDE: ANSI/TIA/EIA-603, Paragraph 2.2.15
TEST EQUIPMENT: As per attached page

MEASUREMENT PROCEDURE

1. The EUT and test equipment were set up such that the audio input was connected at the input of the modulation limiter, and the modulated stage.
2. The audio output was connected at the output to the modulated stage.
3. MEASUREMENT RESULTS: ATTACHED

TRANSMITTER TEST SET-UP

TEST A: MODULATION CAPABILITY / DISTORTION
 TEST B: AUDIO FREQUENCY RESPONSE
 TEST C: HUM AND NOISE LEVEL
 TEST D: RESPONSE OF LOW PASS FILTER
 TEST E: MODULATION KIMITING

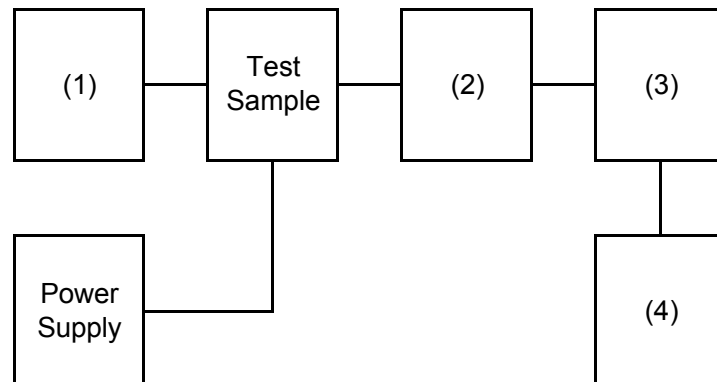

Instruments	Description	Serial Number
(1) AUDIO GENERATOR	Agilent 8903B	***
(2) COAXIAL ATTENUATOR	Agilent 8498A	***
(3) MODULATION ANALYZER	Agilent 8901B	***
(4) AUDIO ANALYZER	Agilent 8903B	***

NAME OF TEST: Audio Low Pass Filter (Voice Input)

STATE: 0 : General

Wide

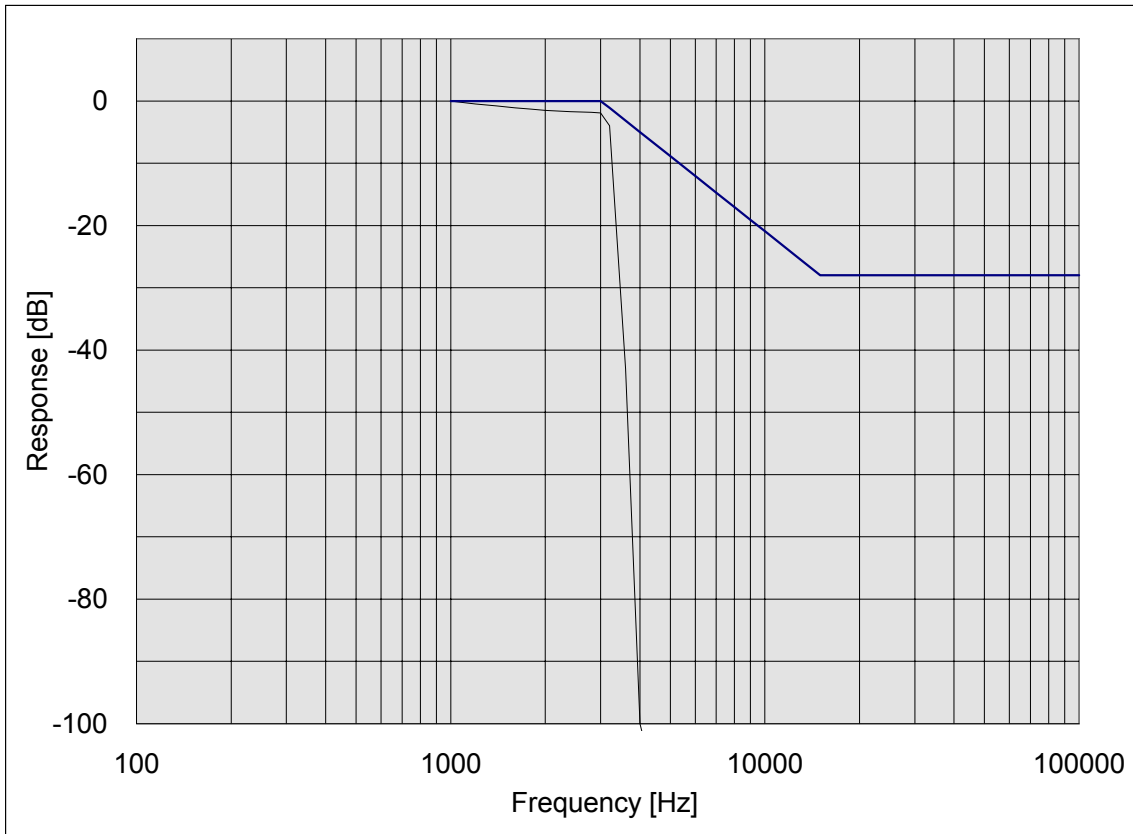

Narrow

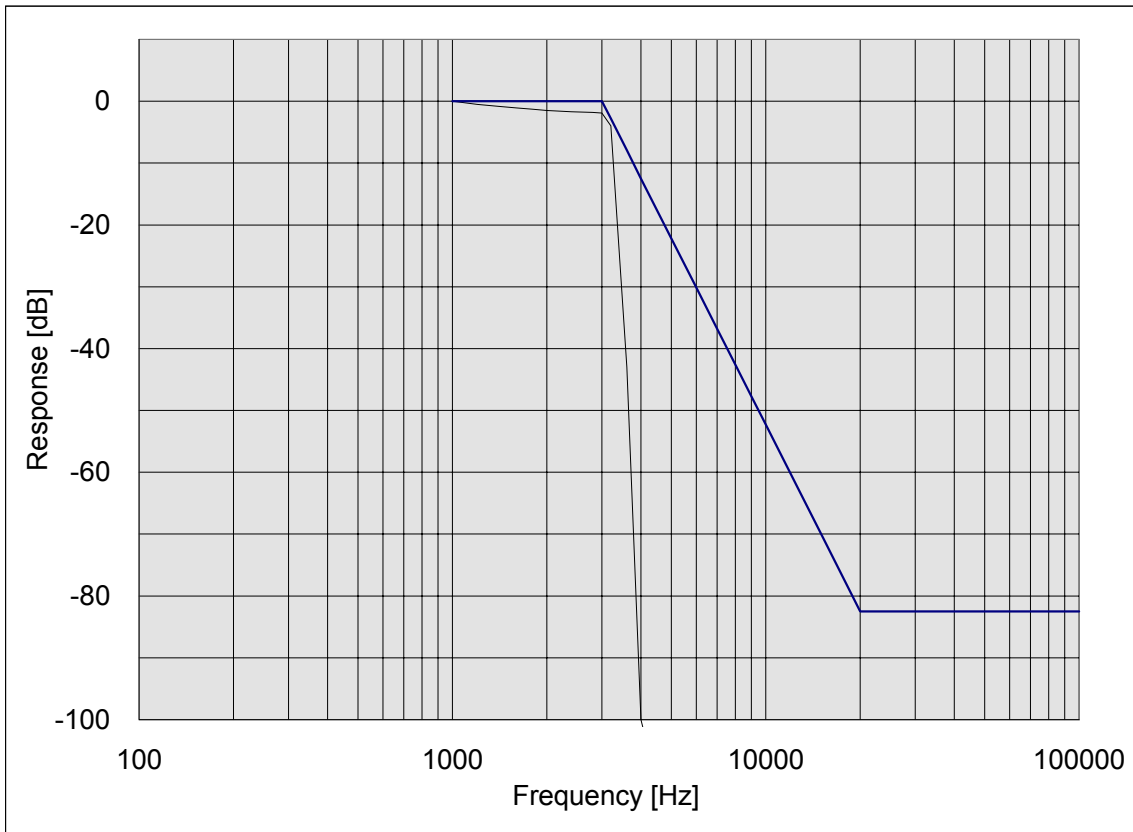

NAME OF TEST: Audio Frequency Response
SPECIFICATION: 47 CFR 2.1047 (a)
GUIDE: ANSI/TIA/EIA-603, Paragraph 2.2.6
TEST EQUIPMENT: As per previous page

MEASUREMENT PROCEDURE

1. The EUT and test equipment were set up as shown on the following page.
2. The audio signal generator was connected to the audio input circuit/microphone of the EUT.
3. The audio signal input was adjusted to obtain 20% modulation at 1kHz, and this point was taken as the 0dB reference level.
4. Which input levels hold constant and below limiting at all frequencies, the audio signal generator was varied from 100Hz to 5kHz.
5. The response in dB relative to 1kHz was then measured, using the Agilent 8901B modulation analyzer.
6. MEASUREMENT RESULTS: ATTACHED

NAME OF TEST: Audio Frequency Response

STATE: 0 : General

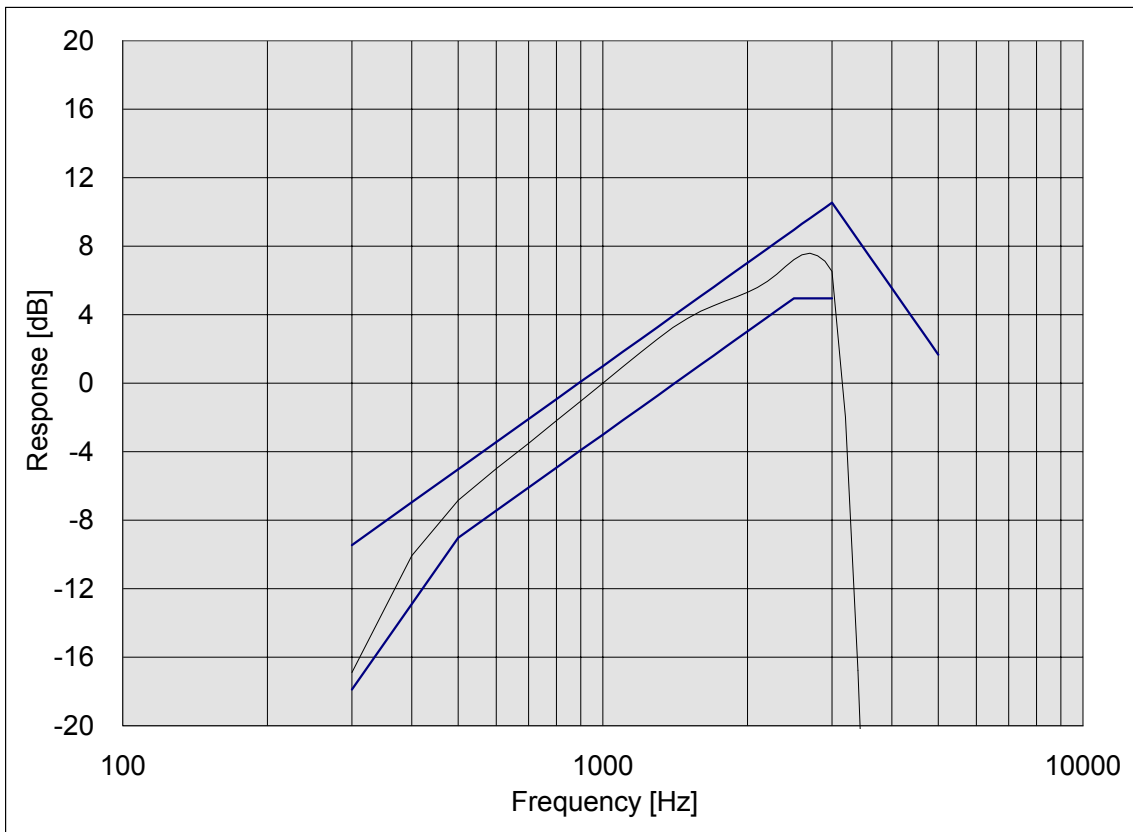

PEAK AUDIO FREQUENCY : 2700 [Hz]

NAME OF TEST: Modulation Limiting
SPECIFICATION: 47 CFR 2.1047 (b)
GUIDE: ANSI/TIA/EIA-603, Paragraph 2.2.3
TEST EQUIPMENT: As per previous page

MEASUREMENT PROCEDURE

1. The signal generator was connected to the input of the EUT as for "Frequency Response of the Modulating Circuit".
2. The modulation response was measured for each of three frequencies (one of which was the frequency of maximum response), and the input voltage was varied and was observed on an Agilent 8901B modulation analyzer.
3. The input level was varied from 30% modulation ($\pm 1.5\text{kHz}$ deviation) to at least 20dB higher than the saturation point.
4. Measurements were performed for both negative and positive modulation and the respective results were recorded.
5. MEASUREMENT RESULTS: ATTACHED

NAME OF TEST: Modulation Limiting

STATE: 0 : General

Positive Peak Wide

0 dB = 4.5 [mV]

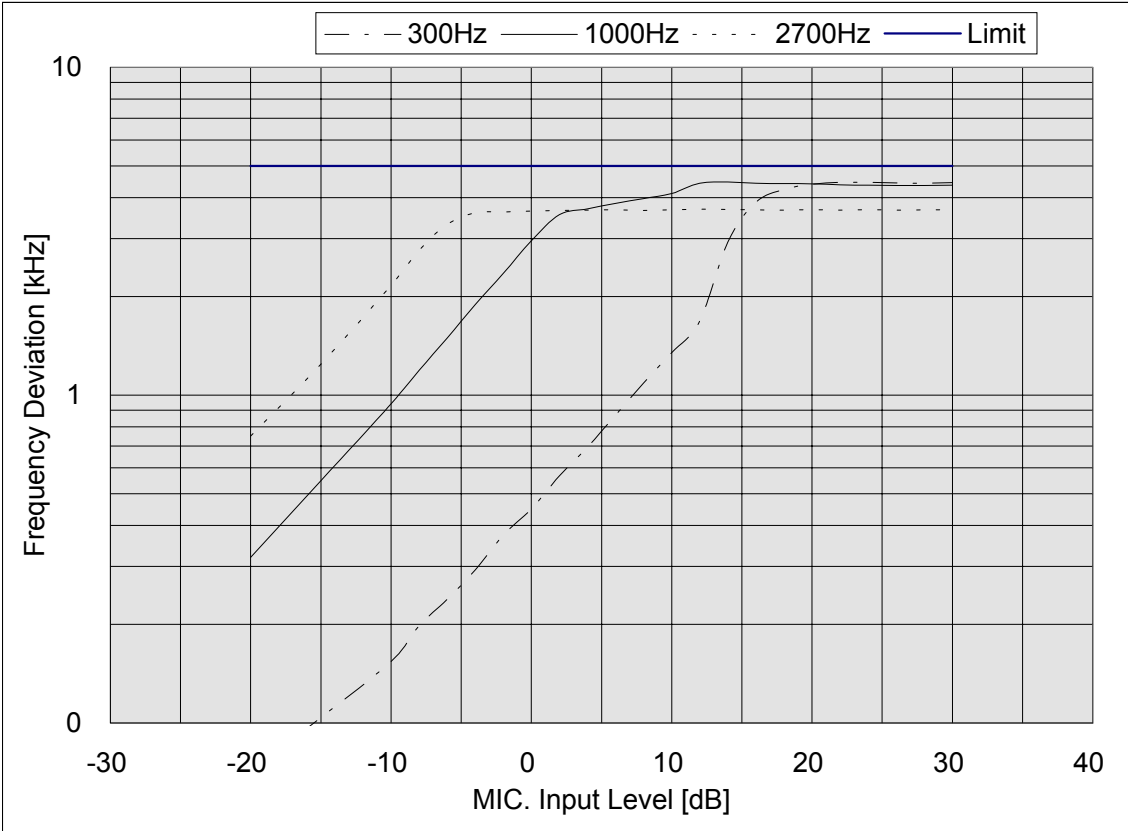

Negative Peak Wide

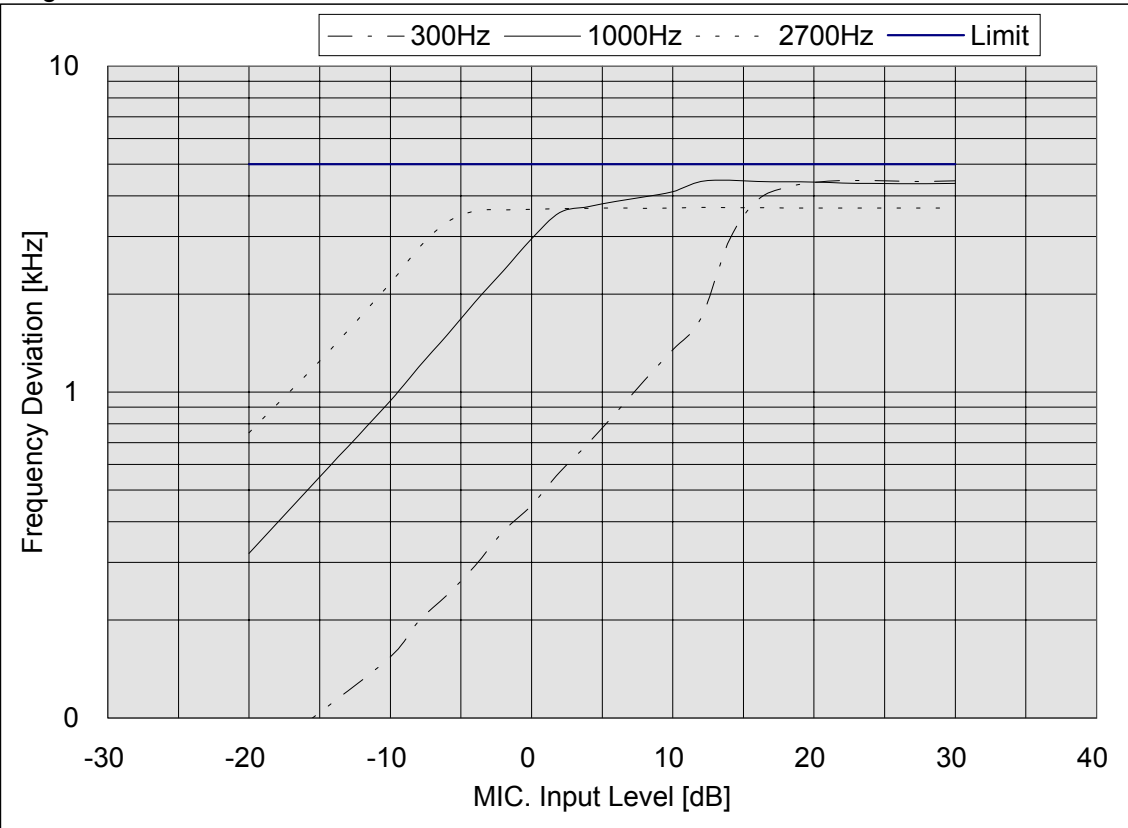

NAME OF TEST: Modulation Limiting

STATE: 0 : General

Positive Peak Narrow

0 dB = 4.5 [mV]

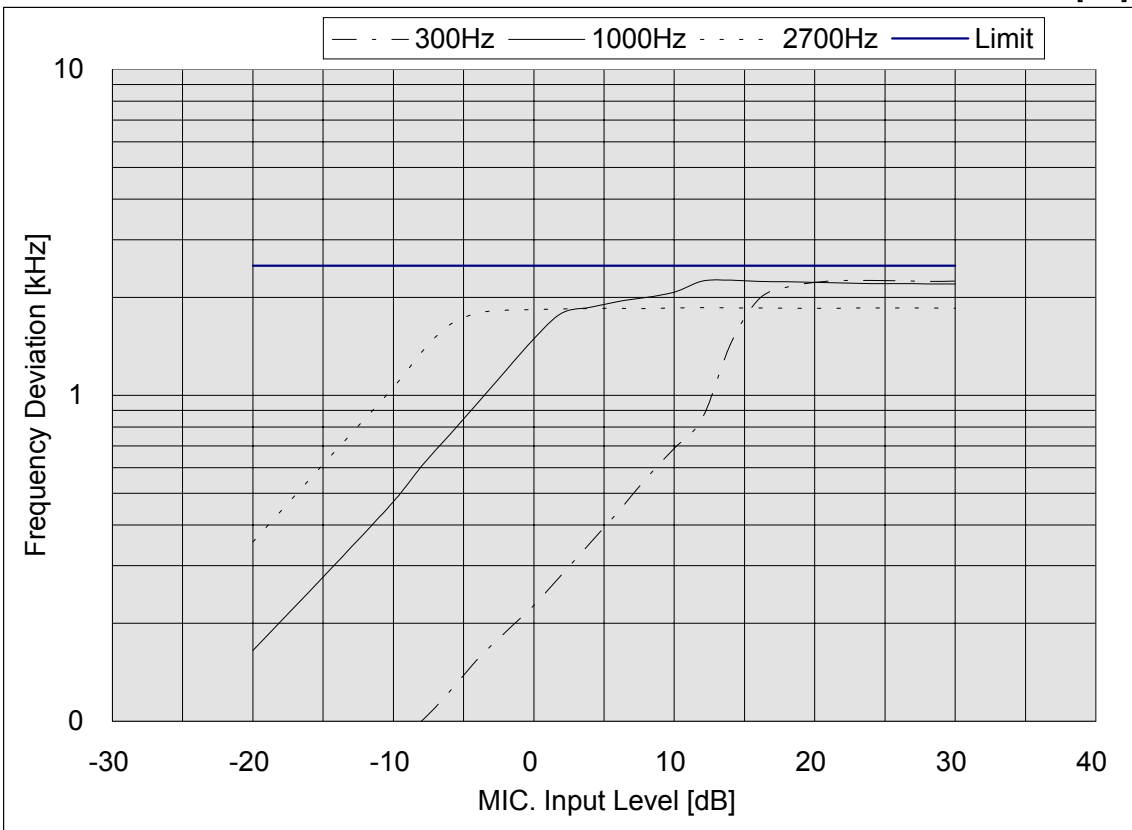

Negative Peak Narrow

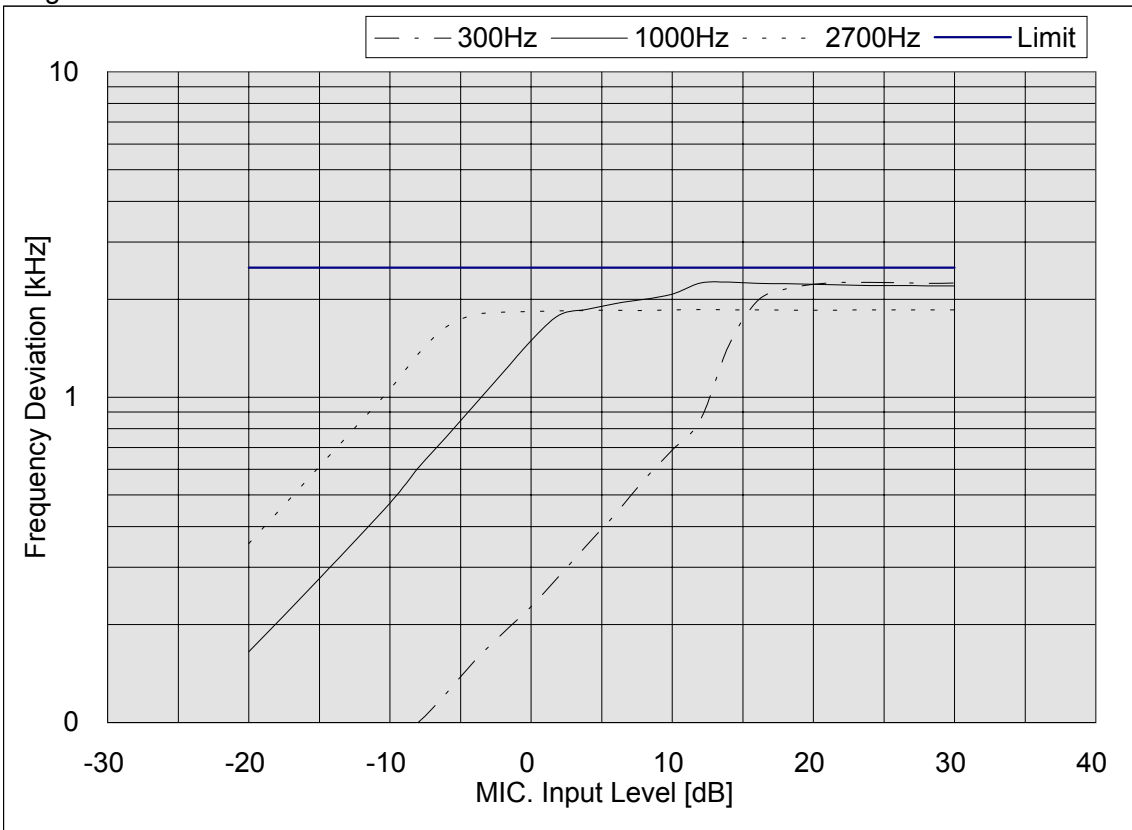

NAME OF TEST: Frequency Stability (Temperature Variation)
SPECIFICATION: 47 CFR 2.1055 (a) (1)
GUIDE: ANSI/TIA/EIA-603, Paragraph 2.2.2
TEST CONDITIONS: As indicated
TEST EQUIPMENT: As per previous page

MEASUREMENT PROCEDURE

1. The EUT and test equipment were set up as shown on the following page.
2. With all power removed, the temperature was decreased to -30°C and permitted to stabilize for three hours. Power was applied and the maximum change in frequency was noted within one minute.
3. With power OFF, the temperature was raised in 10°C steps. The sample was permitted to stabilize at each step for at least one-half hour. Power was applied and the maximum frequency change was noted within one minute.
4. The temperature tests were performed for the worst case.
5. MEASUREMENT RESULTS: ATTACHED

TRANSMITTER TEST SET-UP

- TEST A: OPERATIONAL STABILITY
- TEST B: CARRIER FREQUENCY STABILITY
- TEST C: OPERATIONAL PERFORMANCE STABILITY
- TEST D: HUMIDITY
- TEST E: VIBRATION
- TEST F: ENVIRONMENTAL TEMPERATURE
- TEST G: FREQUENCY STABILITY, TEMPERATURE VARIATION
- TEST H: FREQUENCY STABILITY, VOLTAGE VARIATION

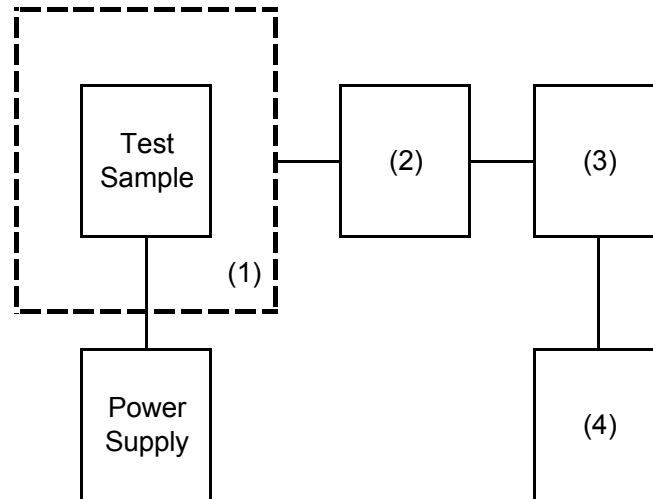

Instruments	Description	Serial Number
(1) TEMPERATURE CHAMBER	ETAC FX4100	***
(2) COAXIAL ATTENUATOR	Weinschel 53-30-33	***
(3) POWER METER	Agilent 436A	***
(4) FREQUENCY COUNTER	Agilent 8901B FREQUENCY MODI	***

NAME OF TEST: Frequency Stability (Temperature Variation)

STATE: 0 : General

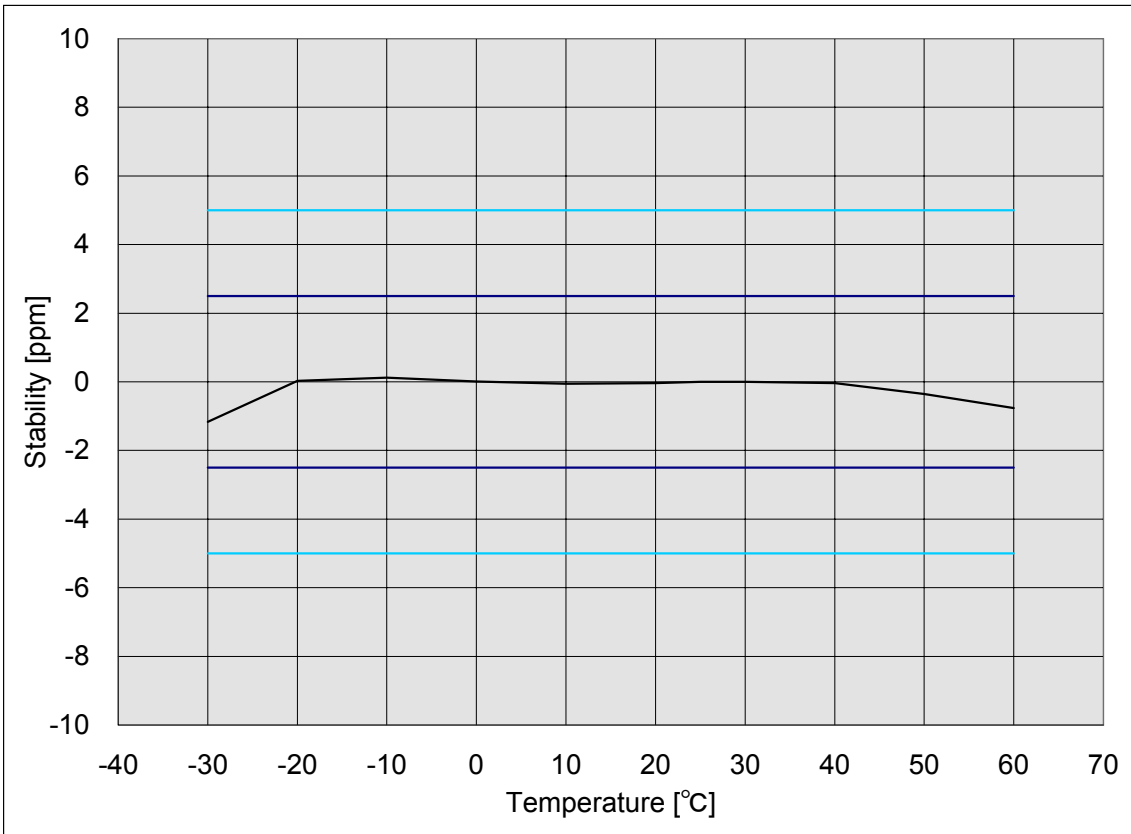

NAME OF TEST: Frequency Stability (Voltage Variation)
SPECIFICATION: 47 CFR 2.1055 (b)
GUIDE: ANSI/TIA/EIA-603, Paragraph 2.2.2
TEST EQUIPMENT: As per previous page

MEASUREMENT PROCEDURE

1. The EUT was placed in a temperature chamber at 25±5°C and connected as for "Frequency Stability - Temperature Variation" test.
2. The power supply voltage to the EUT was varied from 85% to 115% of the nominal value measured at the input to the EUT.
3. The variation in frequency was measured for the worst case.

RESULTS: Frequency Stability (Voltage Variation)

STATE: 0 : General

LIMIT', ppm = 2.5
 LIMIT', Hz = 385

% of STV	Voltage	Frequency, MHz	Change, Hz	Change, ppm
85	6.29	153.999940	-60	-0.39
100	7.40	153.999960	-40	-0.26
115	8.51	153.999960	-40	-0.26

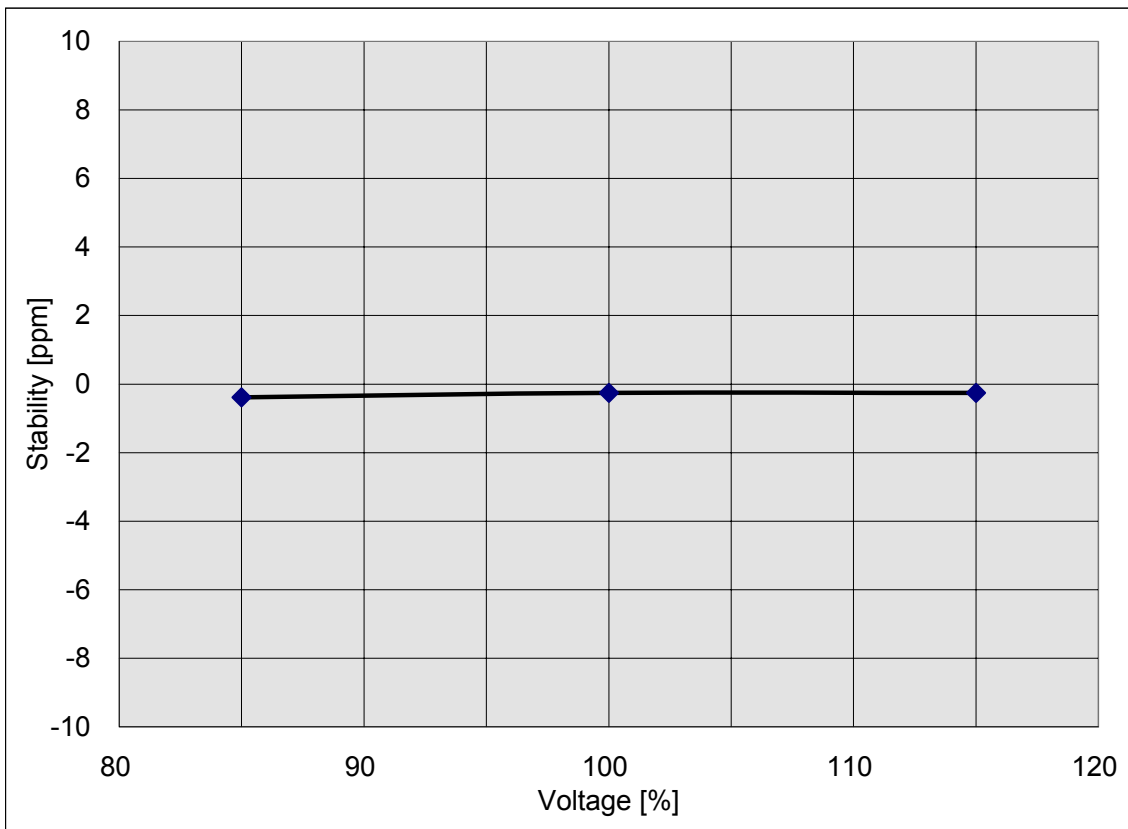

NAME OF TEST: Necessary Bandwidth and Emission Bandwidth
SPECIFICATION: 47 CFR 2.202 (g)

MODULATION = 16K0F3E

NECESSARY BANDWIDTH CALCULATION:

MAXIMUM MODULATION (M), kHz = 3
MAXIMUM DEVIATION (D), kHz = 5
CONSTANT FACTOR (K) = 1
NECESSARY BANDWIDTH (BN), kHz = $(2 \times M) + (2 \times D \times K)$
= 16

MODULATION = 11K0F3E

NECESSARY BANDWIDTH CALCULATION:

MAXIMUM MODULATION (M), kHz = 3
MAXIMUM DEVIATION (D), kHz = 3
CONSTANT FACTOR (K) = 1
NECESSARY BANDWIDTH (BN), kHz = $(2 \times M) + (2 \times D \times K)$
= 11

NAME OF TEST: Receiver Spurious Emissions (Conducted)

STATE: 0 : General

All other emissions in the required measurement range were more than 20dB below the required limits.

MEASUREMENT RESULTS

<u>FREQUENCY TUNED, MHz</u>	<u>FREQUENCY EMISSION, MHz</u>	<u>LEVEL, dBm</u>	<u>LEVEL, nW</u>
154.000	204.850	-74.6	0.0351
174.000	1798.800	-76.0	0.0251
154.000	1843.650	-75.9	0.0257
134.000	1848.500	-75.3	0.0295

NAME OF TEST: Receiver Spurious Emissions (Radiated)

STATE: 0 : General

All other emissions in the required measurement range were more than 20dB below the required limits.

MEASUREMENT RESULTS

<u>FREQUENCY TUNED, MHz</u>	<u>FREQUENCY EMISSION, MHz</u>	<u>LEVEL, dBuV</u>	<u>@m</u>	<u>CF, dB</u>	<u>uV/m</u>
450.000	46.650	26.7	3	-5.9	32.6
485.000	56.550	22.0	3	-7.5	29.5
520.000	339.170	31.2	3	-4.3	35.5
134.000	369.700	26.8	3	-4.4	31.2
450.000	370.000	29.9	3	-4.4	34.3
154.000	409.700	31.8	3	-4.3	36.1
485.000	427.170	29.9	3	-4.4	34.3
174.000	449.700	31.6	3	-3.9	35.5
520.000	458.670	32.7	3	-3.5	36.2