

## Bluetooth Antenna Information

### (RA6213000)

#### ■ Description

YAESU custom Bluetooth Antenna.

Model name : ANTENNA (BT) BA6213000

Part number : RA6213000

#### ■ Antenna Type

1/4λ Inverted-L Antenna

#### ■ Manufacturer's address

Yaesu Musen Co., Ltd.

Omori Bell port D building 3F, 6-26-3 Minamioi, Shinagawa-ku, Tokyo, 140-0013, Japan

#### ■ Actual antenna gain (peak)

-2.1dBi

#### ■ Dimension

See drawing No.BA6213000

## Antenna radiation pattern measurement

### ■ EUT Setting

EUT places in the box. And the antenna faces as shown below.

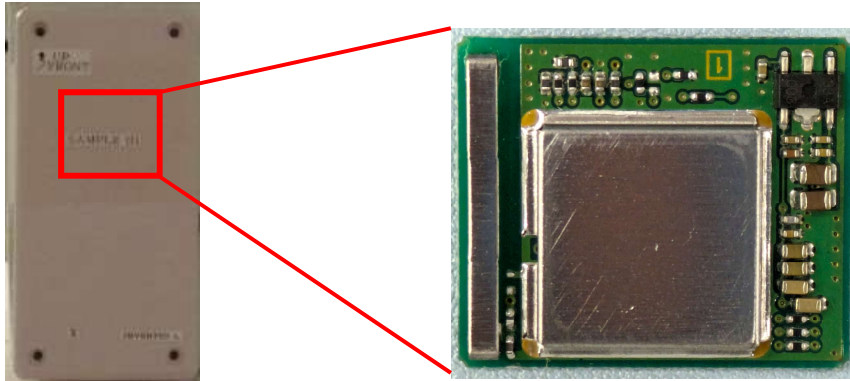

### ■ Measurement Setting

X-axis



Y-axis



Z-axis



■ Measurement results

2402MHz					
			MAX	MIN	AVE
H	X		-6.5	-34.8	-12.3
V			-9.7	-43.0	-16.2
H	Y		-12.9	-33.6	-17.7
V			-4.4	-18.9	-8.5
H	Z		-4.3	-24.8	-9.3
V			-9.4	-33.9	-13.7
2440MHz					
			MAX	MIN	AVE
H	X		-5.6	-36.8	-11.6
V				-11.4	-37.8
H	Y		-9.9	-42.9	-15.8
V				-2.9	-20.3
H	Z		-2.2	-23.2	-7.6
V				-8.0	-35.9
2480MHz					
			MAX	MIN	AVE
H	X		-5.1	-34.2	-12.1
V				-11.8	-47.6
H	Y		-10.5	-34.6	-16.2
V				-2.1	-18.3
H	Z		-2.6	-23.9	-7.7
V				-9.4	-35.1

2402MHz

X-axis

Unit: dBi

— Hor  
— Ver

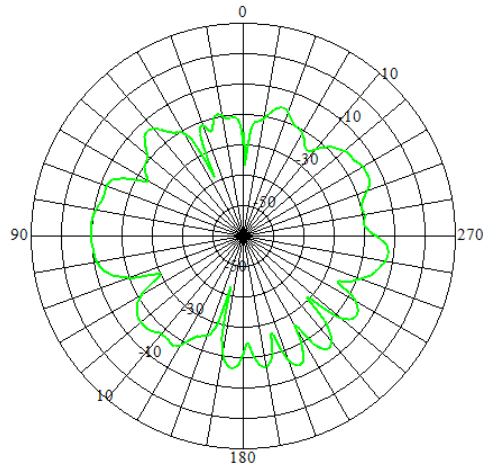
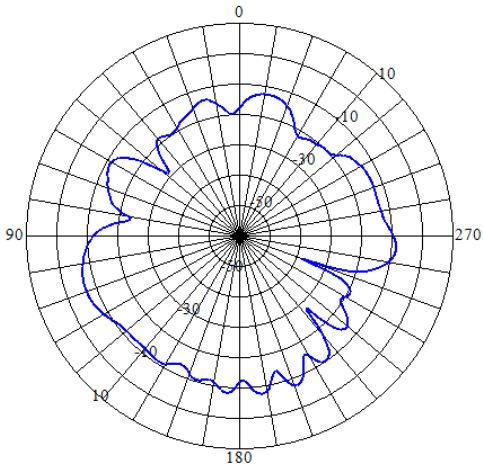

Y-axis

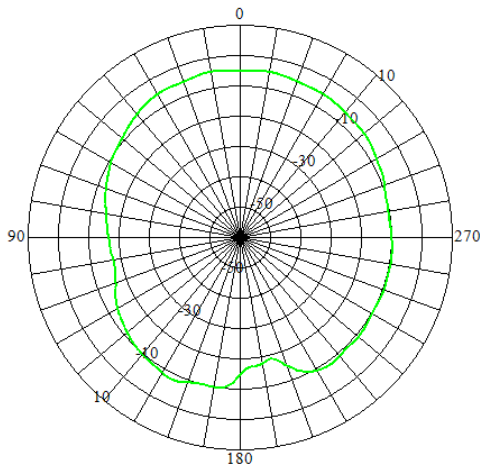
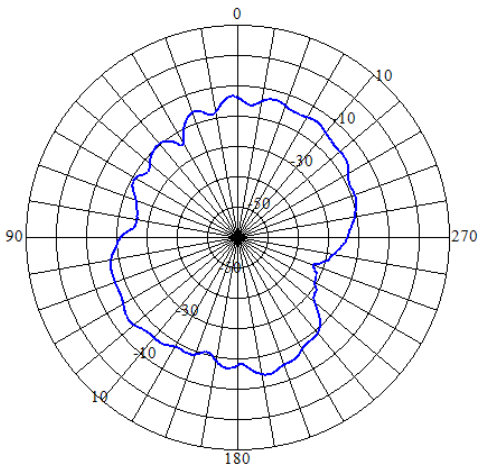

Z-axis

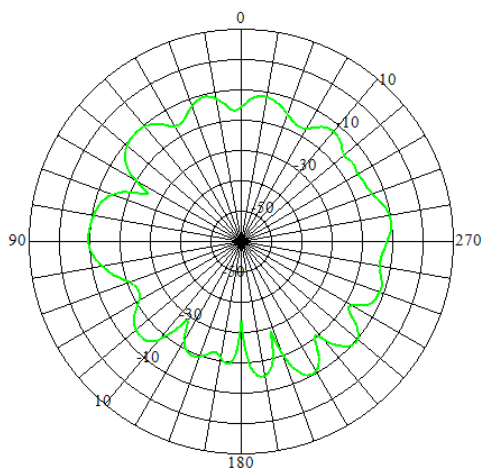
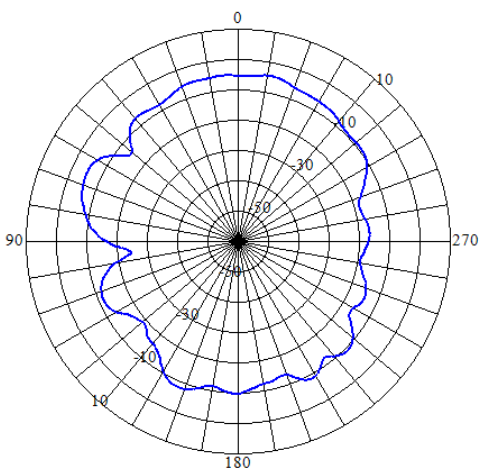

2440MHz

X-axis

Unit: dBi

— Hor  
— Ver

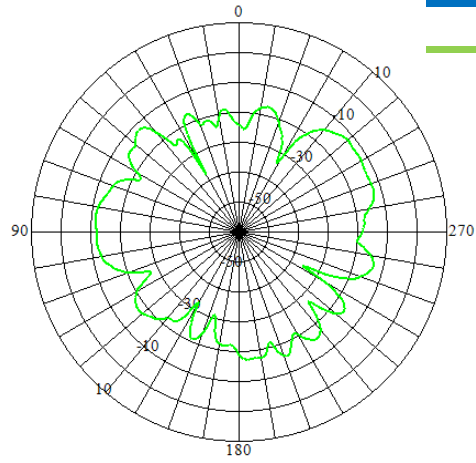
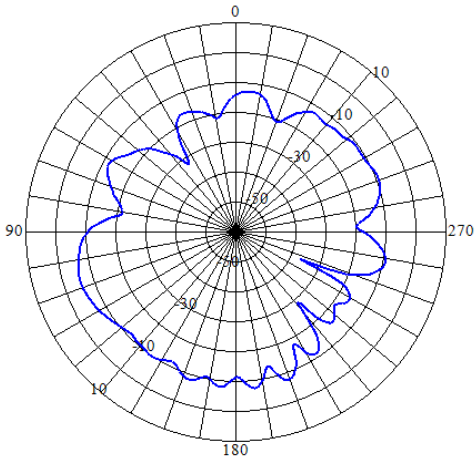

Y-axis

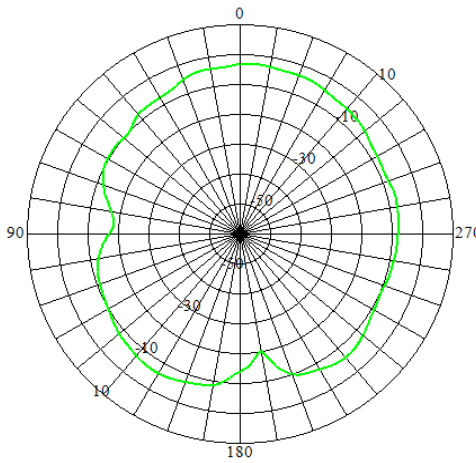
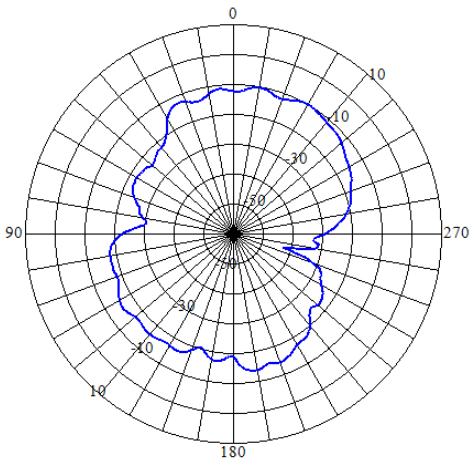

Z-axis

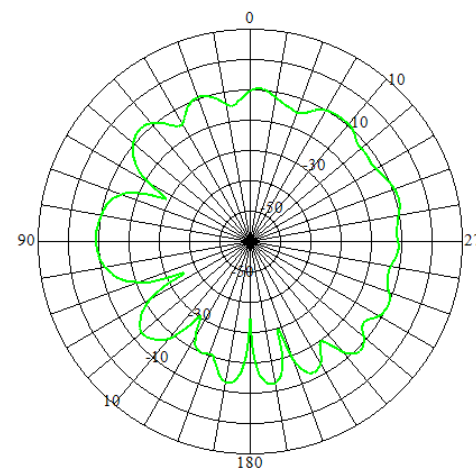
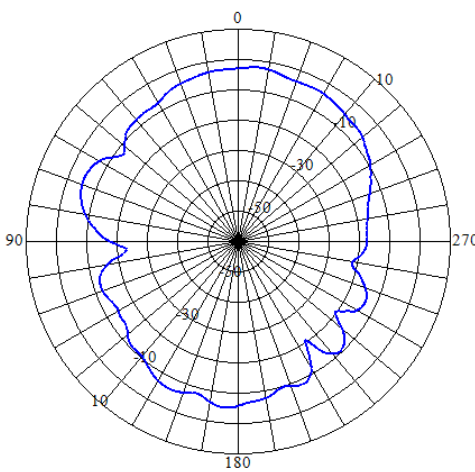

2480MHz

X-axis

— Hor  
— Ver

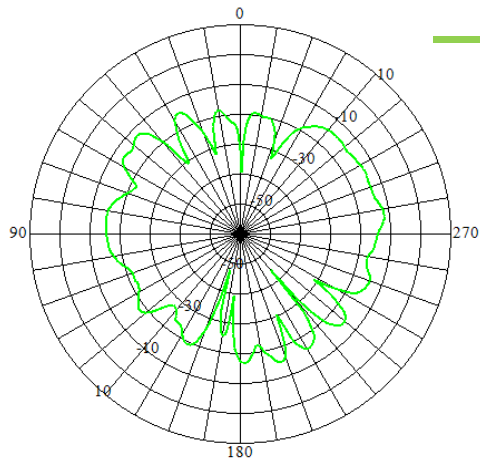
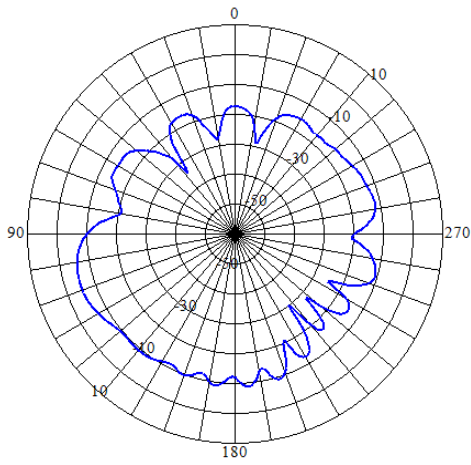

Y-axis

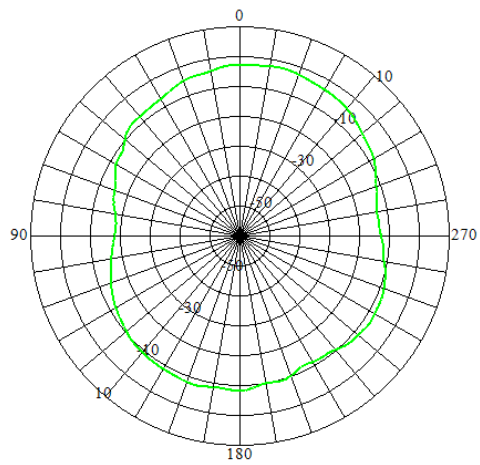
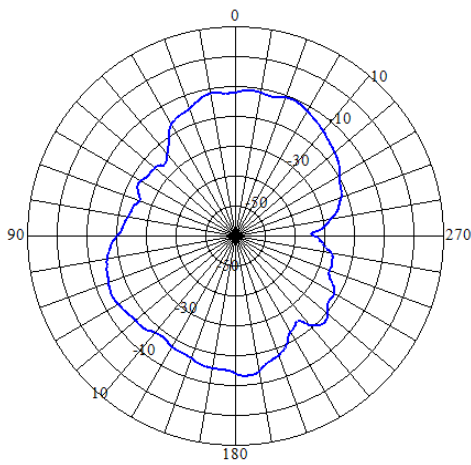

Z-axis

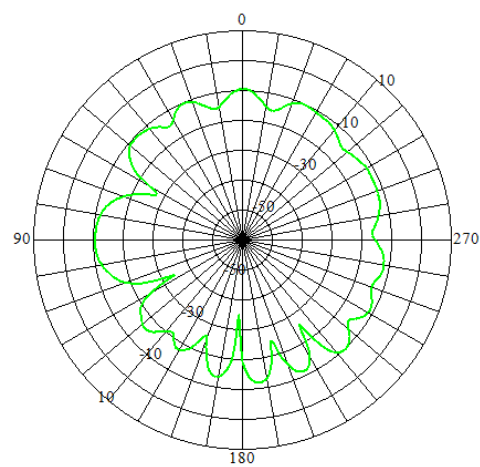
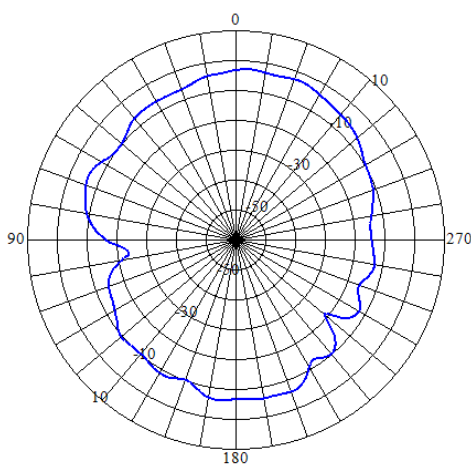

GENERAL TOLERANCE		± mm	
DIMENSION	TOLERANCE	DIMENSION	TOLERANCE
- 3	0.07	50 - 80	0.23
3 - 6	0.09	80 - 120	0.27
6 - 10	0.11	120 - 180	0.32
10 - 18	0.14	180 - 250	0.36
18 - 30	0.16	250 - 315	0.40
30 - 50	0.20	315 - 400	0.44

000000000	DO NOT SCALE
MARK/DATE	REVISIONS NAME
△ '18-06-11	T1 RELEASE FOR TOOLING 百瀬
△ '18-08-29	0 RELEASE FOR PRODUCTION 百瀬

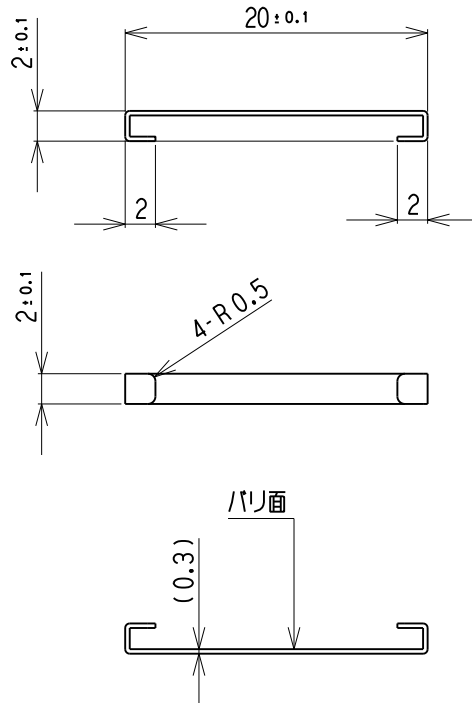

注記

1. 変形等のなきこと。
2. 詳細は、打ち合わせによる。



RoHS2(2011/65/EU)対応品とする

Do not include the harmful substance in environment  
(1.Cr(VI) 2.Cd 3.Pb 4.Hg 5.PBBs 6.PBDEs)

SURFACE TREATMENT : 脱脂処理				3D	
MATERIAL : SPTE t0.3					
NOTE :				PRODUCTION No. NO05U	
PROJ. ⊕ □	UNIT mm	ANGLE ± °	SCALE 2:1	TITLE ANTENNA(BT) アンテナ(BT)	
APPROVED 2018.08.29 山崎	CHECKED 2018.08.29 飯束	DESIGNED 2018.03.26 百瀬	DRAWING 2018.08.29 百瀬	DRAWING No. BA6213000	
YAESU MUSEN CO., LTD.					A4