

# ***FCC Part 15*** ***EMI TEST REPORT***

*of*

E.U.T. : Transmitter  
FCC ID : K4E919TP4F  
MODEL : SK-919TP4F-NUQ, SK-919TP4F-NQ,  
SK-919TP3F-NUQ, SK-919TP3F-NQ,  
SK-919TP2F-NUQ, SK-919TP2F-NQ,  
SK-919TP1F-BUQ, SK-919TP1F-BQ

Working Frequency: 315 MHz

*for*

APPLICANT : Superior Electronics Corporation  
ADDRESS : No.10, Lane 31, Chongde St., Sinyi District,  
Taipei City 110, Taiwan (R.O.C.)

Test Performed by

**ELECTRONICS TESTING CENTER, TAIWAN**  
NO. 34. LIN 5, DINGFU VIL., LINKOU DIST.,  
NEW TAIPEI CITY, TAIWAN, 24442, R.O.C.  
TEL : (02)26023052 Fax : (02)26010910  
<http://www.etc.org.tw> ; e-mail: [emc@etc.org.tw](mailto:emc@etc.org.tw)

Report Number : 17-07-RBF-016

## **TEST REPORT CERTIFICATION**

Applicant : Superior Electronics Corporation  
 No.10, Lane 31, Chongde St., Sinyi District, Taipei City 110,  
 Taiwan (R.O.C.)

Manufacturer : Superior Electronics Corporation  
 No.10, Lane 31, Chongde St., Sinyi District, Taipei City 110,  
 Taiwan (R.O.C.)

Description of EUT :

a) Type of EUT : Transmitter  
 b) Trade Name : ENFORCER  
 c) Model No. : SK-919TP4F-NUQ, SK-919TP4F-NQ, SK-919TP3F-NUQ,  
 SK-919TP3F-NQ, SK-919TP2F-NUQ, SK-919TP2F-NQ,  
 SK-919TP1F-BUQ, SK-919TP1F-BQ  
 d) FCC ID : K4E919TP4F  
 e) Working Frequency : 315 MHz  
 f) Power Supply : DC 3V

Regulation Applied : FCC Rules and Regulations Part 15 Subpart C

I HEREBY CERTIFY THAT; The data shown in this report were made in accordance with the procedures given in ANSI C63.10-2013 and the energy emitted by the device was founded to be within the limits applicable. I assume full responsibility for accuracy and completeness of these data.

Note : 1. The results of the testing report relate only to the items tested.  
 2. The testing report shall not be reproduced except in full, without the written approval of ETC.

### Summary of Tests

Test	Results
Radiated Emission	<b>Pass</b>
Bandwidth of Emission	<b>Pass</b>
Conducted Emission	<b>N/A</b>

Issued Date : Jul. 28, 2017

Test Engineer : Kazuma Ho  
( Kazuma Ho, Engineer )

Approve & Authorized Signer : S S Liou  
S. S. Liou, Section Manager  
EMC Dept. II of ELECTRONICS  
TESTING CENTER, TAIWAN



# Table of Contents

Page

<b>1. GENERAL INFORMATION .....</b>	<b>1</b>
1.1 PRODUCT DESCRIPTION .....	1
1.2 CHARACTERISTICS OF DEVICE .....	1
1.3 TEST METHODOLOGY .....	2
1.4 TEST FACILITY .....	2
<b>2. DEFINITION AND LIMITS .....</b>	<b>3</b>
2.1 DEFINITION .....	3
2.2 RESTRICTED BANDS OF OPERATION .....	3
2.3 LIMITATION.....	3
2.4 LABELING REQUIREMENT .....	5
2.5 USER INFORMATION .....	5
<b>3 SYSTEM TEST CONFIGURATION .....</b>	<b>6</b>
3.1 JUSTIFICATION .....	6
3.2 DEVICES FOR TESTED SYSTEM.....	6
<b>4. RADIATED EMISSION MEASUREMENT.....</b>	<b>7</b>
4.1 APPLICABLE STANDARD .....	7
4.2 MEASUREMENT PROCEDURE .....	7
4.3 TEST DATA .....	10
4.4 FIELD STRENGTH CALCULATION .....	14
4.5 ACTIVATE TIME .....	14
4.6 CALCULATION OF DUTY FACTOR .....	14
4.7 RADIATED TEST EQUIPMENT .....	18
4.8 MEASURING INSTRUMENT SETUP .....	18
4.9 RADIATED MEASUREMENT PHOTOS .....	19
<b>5. BANDWIDTH OF EMISSION.....</b>	<b>21</b>
5.1 APPLICABLE STANDARD PLOT GRAPHIC OF BANDWIDTH.....	21
5.2 BANDWIDTH TEST EQUIPMENT.....	21
5.3 PLOT GRAPHIC OF BANDWIDTH.....	21
<b>6. CONDUCTED EMISSION MEASUREMENT .....</b>	<b>22</b>
6.1 DESCRIPTION .....	22
<b>7 ANTENNA REQUIREMENT .....</b>	<b>23</b>
7.1 STANDARD APPLICABLE .....	23
7.2 ANTENNA CONSTRUCTION.....	23

## 1. GENERAL INFORMATION

### 1.1 Product Description

- a) Type of EUT : Transmitter  
b) Trade Name : ENFORCER  
c) Model No. : SK-919TP4F-NUQ, SK-919TP4F-NQ, SK-919TP3F-NUQ,  
SK-919TP3F-NQ, SK-919TP2F-NUQ, SK-919TP2F-NQ,  
SK-919TP1F-BUQ, SK-919TP1F-BQ  
d) FCC ID : K4E919TP4F  
e) Working Frequency : 315 MHz  
f) Power Supply : DC 3V  
g) Model Difference :
- SK-919TP4F-NUQ: 4 buttons transmitter without logo and RoHS.  
SK-919TP4F-NQ: 4 buttons transmitter with logo and RoHS.  
SK-919TP3F-NUQ: 3 buttons transmitter without logo and RoHS.  
SK-919TP3F-NQ: 3 buttons transmitter with logo and RoHS.  
SK-919TP2F-NUQ: 2 buttons transmitter without logo and RoHS.  
SK-919TP2F-NQ: 2 buttons transmitter with logo and RoHS.  
SK-919TP1F-BUQ: 1 buttons transmitter without logo and RoHS.  
SK-919TP1F-BQ: 1 buttons transmitter with logo and RoHS.  
All models share the same PC board.

### 1.2 Characteristics of Device:

This product is a 315MHz remote control with 1~4 button transmitter.

### 1.3 Test Methodology

Both conducted and radiated testing was performed according to the procedures in ANSI C63.10-2013.

The equipment under test was operated continuously in its normal operating mode for the purpose of the measurements. In order to secure the continuous operation of the device under test, rewiring in the circuit was done by the manufacturer so as to affect its intended operation.

The receiving antenna polarized horizontally was varied from 1 to 4 meters and the wooden turntable was rotated through 360 degrees to obtain the highest reading on the field strength meter or on the display of the spectrum analyzer. And also, each emission was to be maximized by changing the orientation of the equipment under test.

In order to determining the average value during one pulse train of the radiated power generated from the equipment under test, the encoded wave form in the time domain was used.

#### Measurement Software

Software	Version	Note
e3	Version 6.100618b	Radiated Emission Test
e3	Version 6.100421	Conducted Emission Test

### 1.4 Test Facility

Location of the Test site: No.34, Lin 5, Dingfu Vil., Linkou Dist., New Taipei City, Taiwan 24442, R.O.C.

Designation Number: TW2628.

## 2. DEFINITION AND LIMITS

### 2.1 Definition

Intentional radiator:

A device that intentionally generates and emits radio frequency energy by radiation or induction.

### 2.2 Restricted Bands of Operation

Only spurious emissions are permitted in any of the frequency bands listed below:

MHz	MHz	MHz	GHz
0.090 - 0.110	16.42-16.423	399.9-410	4.5-5.15
0.495 - 0.505 **	16.69475 - 16.69525	608-614	5.35-5.46
2.1735 - 2.1905	16.80425 - 16.80475	960-1240	7.25-7.75
4.125-4.128	25.5-25.67	1300-1427	8.025-8.5
4.17725-4.17775	37.5-38.25	1435-1626.5	9.0-9.2
4.20725-4.20775	73-74.6	1645.5-1646.5	9.3-9.5
6.215-6.218	74.8-75.2	1660-1710	10.6-12.7
6.26775-6.26825	108-121.94	1718.8-1722.2	13.25-13.4
6.31175-6.31225	123-138	2200-2300	14.47-14.5
8.291-8.294	149.9-150.05	2310-2390	15.35-16.2
8.362-8.366	156.52475 - 156.52525	2483.5-2500	17.7-21.4
8.37625-8.38675	156.7-156.9	2655-2900	22.01-23.12
8.41425-8.41475	162.0125-167.17	3260-3267	23.6-24.0
12.29-12.293	167.72-173.2	3332-3339	31.2-31.8
12.51975-12.52025	240-285	3345.8-3358	36.43-36.5
12.57675-12.57725	322-335.4	3360-4400	Above 38.6
13.36-13.41			

Remark “\*\*” : Until February 1, 1999, this restricted band shall be 0.490-0.510 MHz

### 2.3 Limitation

#### (1) Conducted Emission Limits:

Except as shown in paragraphs (b) and (c) of this section, for an intentional radiator that is designed to be connected to the public utility (AC) power line, the radio frequency voltage that is conducted back onto the AC power line on any frequency or frequencies within the band 150kHz to 30 MHz shall not exceed the limits in the following table, as measured using a 50 $\mu$ H/50 ohms line impedance stabilization network (LISN). Compliance with the provisions of this paragraph shall be based on the measurement of the radio frequency voltage between each power line and ground at the power terminal. The lower limit applies at the boundary between the frequency ranges.

Frequency MHz	Quasi Peak dB $\mu$ V	Average dB $\mu$ V
0.15 - 0.5	66-56*	56-46*
0.5 - 5.0	56	46
5.0 - 30.0	60	50

- Decreases with the logarithm of the frequency

**(2) Radiated Emission Limits :**

According to 15.231(a), Periodic operation in the band 40.66-40.70 MHz and above 70 MHz, except as shown in paragraph 15.231(e), the field strength of emissions from intentional radiators operated under this section shall not exceed the following:

Frequency Band (MHz)	Field strength of Fundamental (uV/m)	Field strength of Spurious (uV/m)
40.66-40.70	2250	225
70-130	1250	125
130-174	*1,250 to 3,750	*125 to 375
174-260	3750	375
260-470	*3,750 to 12,500	*375 to 1250
Above 470	12500	1250

\* Linear interpolations.

According to 15.231(e), Intentional radiators may operate at a periodic rate exceeding that specified in paragraph (a) and may be employed for any type of operation, including operation prohibited in paragraph (a), provided the intentional radiator complies with the provisions of paragraphs (b) through (d) of this Section, except the field strength table in paragraph (b) is replaced by the following:

Frequency Band (MHz)	Field strength of Fundamental (uV/m)	Field strength of Spurious (uV/m)
40.66-40.70	1,000	100
70-130	500	50
130-174	*500 to 1,500	*50 to 150
174-260	1,500	150
260-470	*1,500 to 5,000	*150 to 500
Above 470	5,000	500

\* Linear interpolations

Field strength limits are at the distance of 3 meters, emissions radiated outside of the specified bands, shall be according to the general radiated limits in 15.209, as following table:

Other Frequencies (MHz)	Field Strength of Fundamental	
	$\mu\text{V}/\text{meter}$	$\text{dB}\mu\text{V}/\text{meter}$
30 - 88	100	40.0
88 - 216	150	43.5
216 - 960	200	46.0
Above 960	500	54.0

As shown in 15.35(b), for frequencies above 1000MHz, the field strength limits are based on average detector, however, the peak field strength of any emission shall not exceed the maximum permitted average limits, specified above by more than 20 dB under any condition of modulation.



### **(3) Limit of transmission time**

According to 15.231(a),

- 1) A manually operated transmitter shall employ a switch that will automatically deactivate the transmitter within not more than 5 seconds of being released.
- 2) A transmitter activated automatically shall cease transmission within 5 seconds after activation.
- 3) Periodic transmissions at regular predetermined intervals are not permitted. However, polling or supervision transmissions, including data, to determine system integrity of transmitters used in security or safety applications are allowed if the total duration of transmissions does not exceed more than two seconds per hour for each transmitter. There is no limit on the number of individual transmissions, provided the total transmission time does not exceed two seconds per hour.
- 4) Intentional radiators which are employed for radio control purposes during emergencies involving fire, security, and safety of life, when activated to signal an alarm, may operate during the pendency of the alarm condition.
- 5) Transmission of set-up information for security systems may exceed the transmission duration limits in paragraphs (a)(1) and (a)(2) of this section, provided such transmissions are under the control of a professional installer and do not exceed ten seconds after a manually operated switch is released or a transmitter is activated automatically. Such set-up information may include data.

According to 15.231(e), devices operated under the provisions of this paragraph shall be provided with a means for automatically limiting operation so that the duration of each transmission shall not be greater than one second and the silent period between transmissions shall be at least 30 times the duration of the transmission but in no case less than 10 seconds.

## **2.4 Labeling Requirement**

The device shall bear the following statement in a conspicuous location on the device :

This device complies with part 15 of the FCC Rules. Operation is subject to the following two conditions: (1) This device may not cause harmful interference, and (2) this device must accept any interference received, including interference that may cause undesired operation.

## **2.5 User Information**

The users manual or instruction manual for an intentional or unintentional radiator shall caution the user that changes or modifications not expressly approved by the party responsible for compliance could void the user's authority to operate the equipment.

### 3 SYSTEM TEST CONFIGURATION

#### 3.1 Justification

All measurement were intentional to maximum the emissions from EUT by varying the connection cables(if applicable), therefore, the test result is sure to meet the applicable requirement.

For portable device, the EUT was pretested in three orthogonal plans: put on table horizontally, stands vertically and side up vertically. The worst case was chosen for final test.

#### 3.2 Devices for Tested System

Device	Manufacture	Model / FCC ID.	Description
Transmitter*	Superior Electronics Corporation	SK-919TP4F-NUQ/ K4E919TP4F	--

Remark “\*” means equipment under test.

## 4. RADIATED EMISSION MEASUREMENT

### 4.1 Applicable Standard

For periodic operation intentional radiator, the radiated emission shall comply with § 15.231(b).

### 4.2 Measurement Procedure

#### A. Preliminary Measurement For Portable Devices

For portable devices, the following procedure was performed to determine the maximum emission axis of EUT:

1. With the receiving antenna is H polarization, rotate the EUT in turns with three orthogonal axes to determine the axis of maximum emission.
2. With the receiving antenna is V polarization, rotate the EUT in turns with three orthogonal axes to determine the axis of maximum emission.
3. Compare the results derived from above two steps. So, the axis of maximum emission from EUT was determined and the configuration was used to perform the final measurement.

#### B. Final Measurement

1. Setup the configuration per figure 1 and 2 for frequencies measured below and above 1 GHz respectively. Turn on EUT and make sure that it is in normal function.
2. For emission frequencies measured below 1 GHz, a pre-scan is performed in a shielded chamber to determine the accurate frequencies of higher emissions will be checked on a open test site. As the same purpose, for emission frequencies measured above 1 GHz, a pre-scan also be performed with a 1 meter measuring distance before final test.
3. For emission frequencies measured below and above 1 GHz, set the spectrum analyzer on a 100 kHz and 1 MHz resolution bandwidth respectively for each frequency measured in step 2.
4. The search antenna is to be raised and lowered over a range from 1 to 4 meters in horizontally polarized orientation. Position the highness when the highest value is indicated on spectrum analyzer, then change the orientation of EUT on test table over a range from 0 ° to 360 ° with a speed as slow as possible, and keep the azimuth that highest emission is indicated on the spectrum analyzer. Vary the antenna position again and record the highest value as a final reading. A RF test receiver is also used to confirm emissions measured.

5. Repeat step 4 until all frequencies need to be measured were complete.
6. Repeat step 5 with search antenna in vertical polarized orientations.
7. Check the three frequencies of highest emission with varying the placement of cables (if any) associated with EUT to obtain the worse case and record the result.

Figure 1a : Frequencies measured below 1 GHz configuration(above 30MHz)

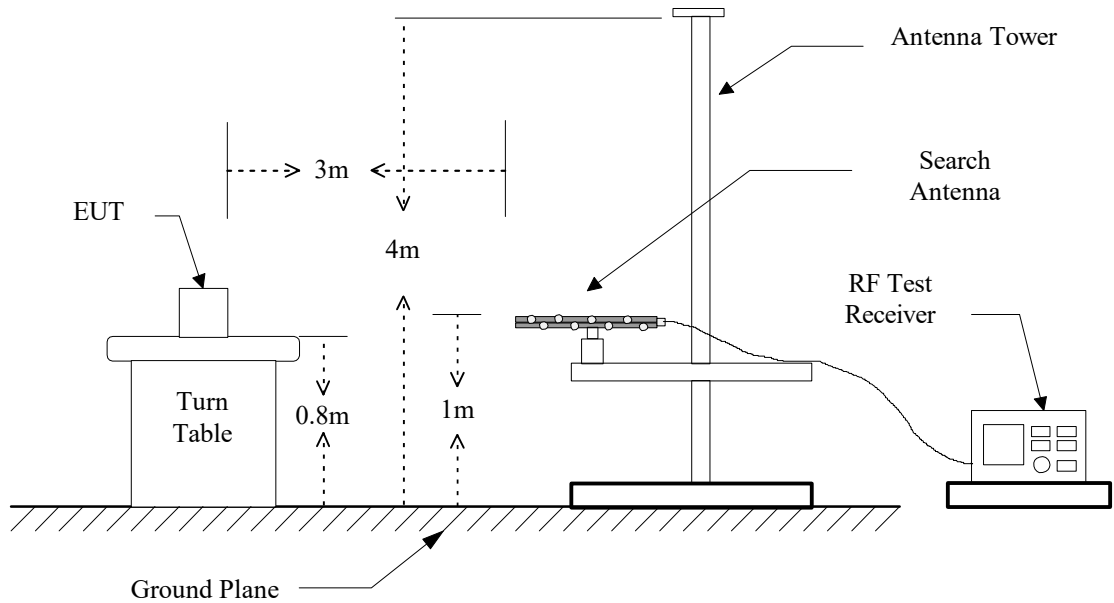

Figure 1b : Frequencies measured below 1 GHz configuration(below 30MHz)

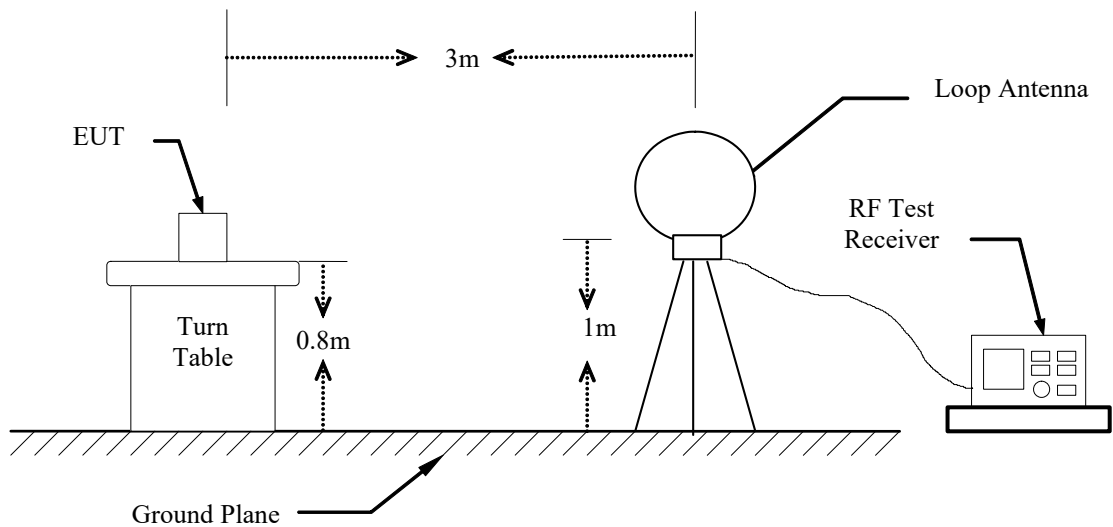
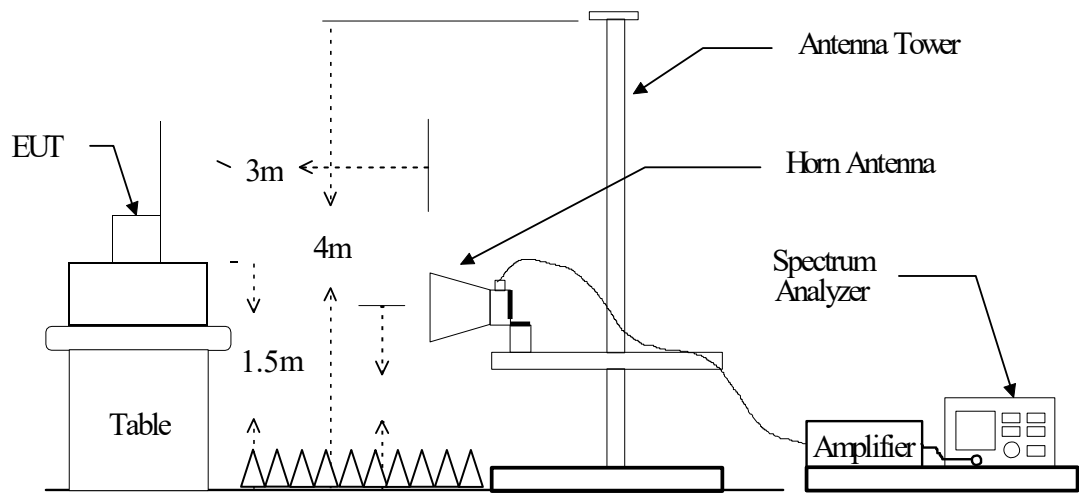
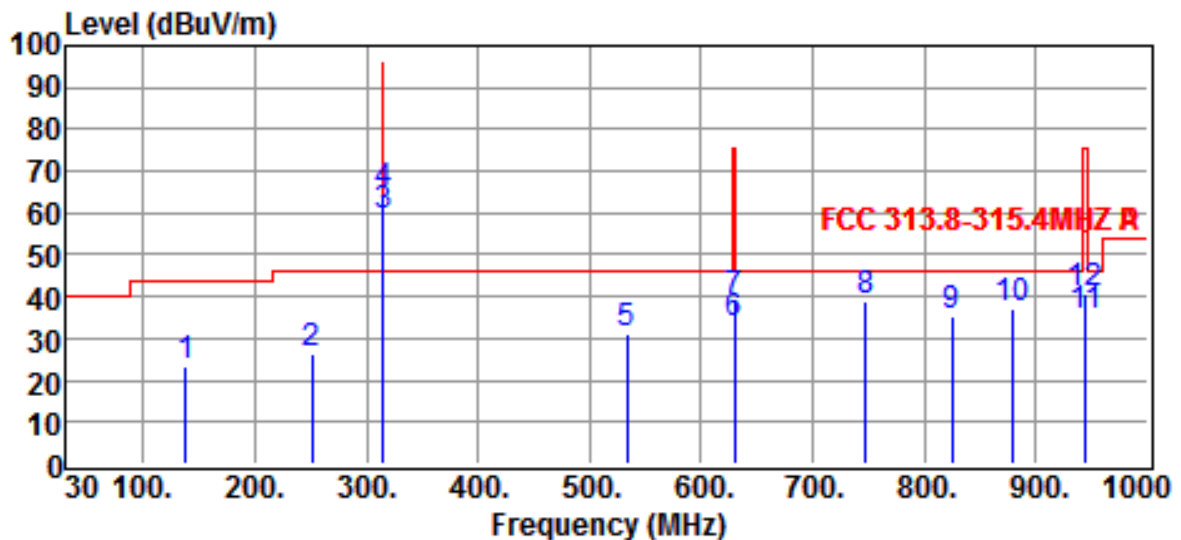

Figure 2 : Frequencies measured above 1 GHz configuration



### 4.3 Test Data

#### A. 30MHz ~ 1GHz



Site	:CHAMBER #2	Date	:2017-07-11
Limit	:FCC 313.8-315.4MHZ P	Ant. Pol.	:HORIZONTAL
EUT	:Transmitter	Model	:SK-919TP4F-NUQ
Power Rating	:DC3V Battery	Temp.	:22°C
Engineer	:Kazuma Ho	Humi.	:60 %
Test Mode	: EUT stands vertically (worst case)		

Freq MHz	Reading dBμV	Correction Factor dB	Result dBμV/m	Limits dBμV/m	Over limit dB	Detector
137.6700	30.25	-7.19	23.06	43.50	-20.44	QP
251.1600	31.43	-5.12	26.31	46.00	-19.69	QP
*315.0160	67.70	-3.14	64.56	95.60	-31.04	Peak
*315.0160	---	---	59.36	75.60	-16.24	Average
533.4300	31.05	0.26	31.31	46.00	-14.69	QP
630.0320	37.07	1.69	38.76	75.60	-36.84	Peak
630.0320	---	---	33.56	55.60	-22.04	Average
747.8000	35.48	3.19	38.67	46.00	-7.33	QP
824.4300	30.75	4.76	35.51	46.00	-10.49	QP
878.7500	31.30	5.77	37.07	46.00	-8.93	QP
945.0480	33.36	7.37	40.73	75.60	-34.87	Peak
945.0480	---	---	35.52	55.60	-20.08	Average

Note :

1. Result = Reading + Corrected Factor
2. Average Result = Peak Result + Duty Factor (-5.2 dB)
3. Corrected Factor = Antenna Factor + Cable Loss
4. The margin value=Limit - Result
5. The transmitter fundamental frequency was marked with "\*".

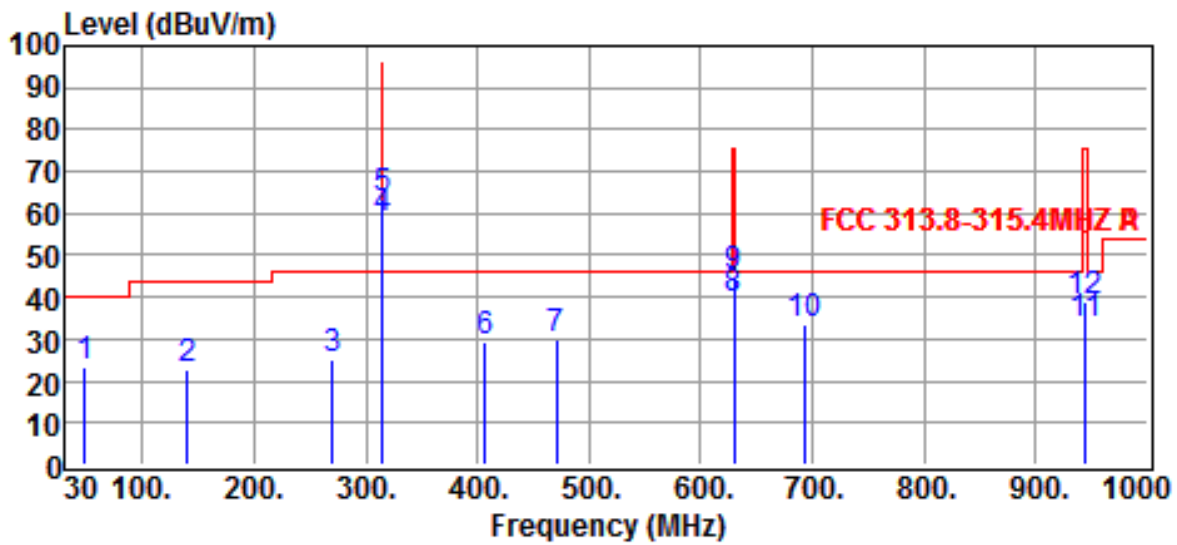

Site	:CHAMBER #2	Date	:2017-07-11
Limit	:FCC 313.8-315.4MHZ P	Ant. Pol.	:VERTICAL
EUT	:Transmitter	Model	:SK-919TP4F-NUQ
Power Rating	:DC 3V Battery	Temp.	:22°C
Engineer	:Kazuma Ho	Humi.	:60 %
Test Mode	: EUT stands vertically (worst case)		

Freq MHz	Reading dBμV	Correction Factor dB	Result dBμV/m	Limits dBμV/m	Over limit dB	Detector
48.4300	33.05	-9.75	23.30	40.00	-16.70	QP
140.5800	29.78	-7.12	22.66	43.50	-20.84	QP
270.5600	29.55	-4.67	24.88	46.00	-21.12	QP
*315.0160	66.87	-3.14	63.73	95.60	-31.87	Peak
*315.0160	---	---	58.53	75.60	-17.07	Average
406.3600	30.99	-1.39	29.60	46.00	-16.40	QP
470.3800	30.81	-0.69	30.12	46.00	-15.88	QP
630.0320	43.25	1.69	44.94	75.60	-30.66	Peak
630.0320	---	---	39.74	55.60	-15.86	Average
693.4800	30.70	2.80	33.50	46.00	-12.50	QP
945.0480	31.66	7.37	39.03	75.60	-36.57	Peak
945.0480	---	---	33.83	55.60	-21.77	Average

Note :

1. Result = Reading + Corrected Factor
2. Average Result = Peak Result + Duty Factor (-5.2 dB)
3. Corrected Factor = Antenna Factor + Cable Loss - Amplifier Gain (if any)
4. The margin value=Limit - Result
5. The transmitter fundamental frequency was marked with "\*".

**B. Above 1GHz**

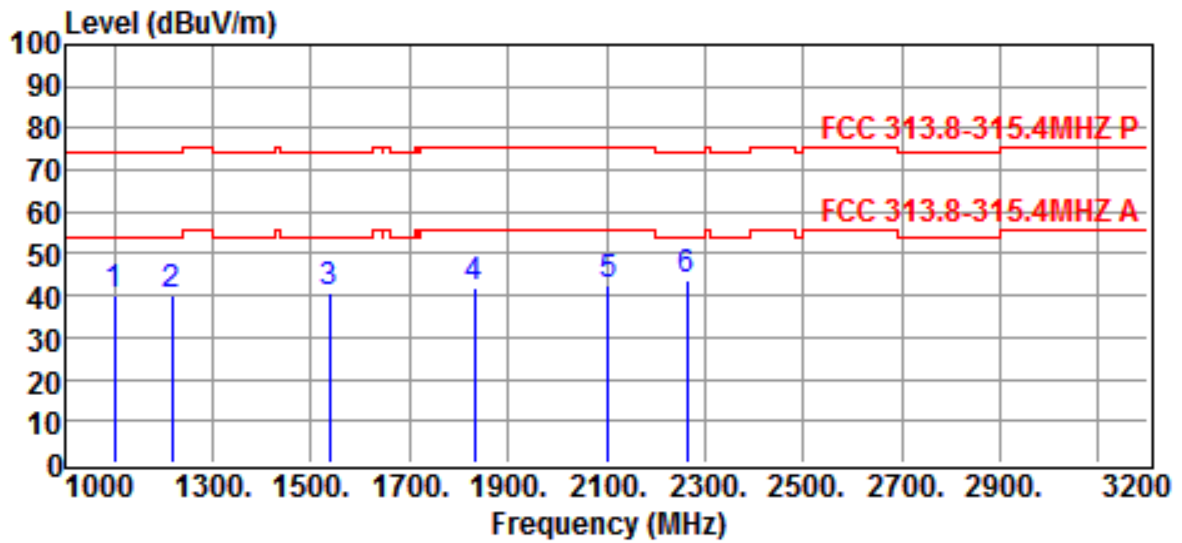

Site	:CHAMBER #2	Date	:2017-07-11
Limit	:FCC 313.8-315.4MHZ P	Ant. Pol.	:HORIZONTAL
EUT	:Transmitter	Model	:SK-919TP4F-NUQ
Power Rating	:DC 3V Battery	Temp.	:22°C
Engineer	:Kazuma Ho	Humi.	:60 %
Test Mode	: EUT stands vertically (worst case)		

Freq MHz	Reading dBμV	Correction Factor dB	Result dBμV/m	Limits (AVG) dBμV/m	Over limit dB	Detector
1101.2000	51.34	-10.94	40.40	54.00	-13.60	Peak
1217.8000	50.69	-10.59	40.10	54.00	-13.90	Peak
1536.8000	50.40	-9.48	40.92	54.00	-13.08	Peak
1831.6000	49.63	-7.59	42.04	55.60	-13.56	Peak
2104.4000	48.92	-6.26	42.66	55.60	-12.94	Peak
2265.0000	49.74	-5.92	43.82	54.00	-10.18	Peak

Note :

1. Result = Reading + Corrected Factor
2. Corrected Factor = Antenna Factor + Cable Loss - Amplifier Gain (if any)
3. The margin value=Limit – Result
4. Peak measurements are compared to the average limit - as peak measurements are below the average limit, they also comply with the peak limit.



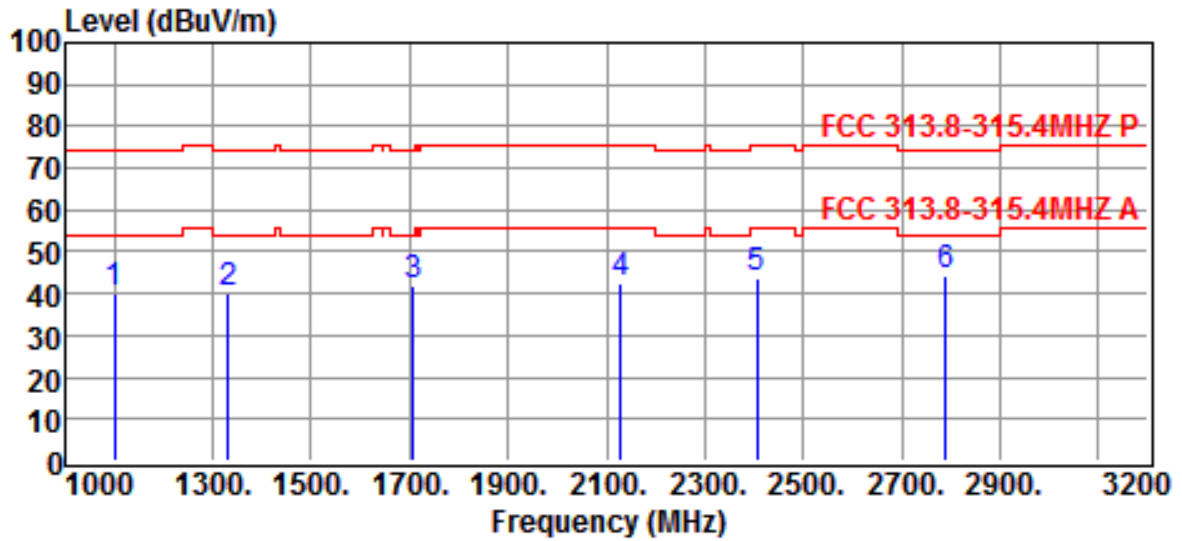

Site	:CHAMBER #2	Date	:2017-07-11
Limit	:FCC 313.8-315.4MHz P	Ant. Pol.	:VERTICAL
EUT	:Transmitter	Model	:SK-919TP4F-NUQ
Power Rating	:DC 3V Battery	Temp.	:22°C
Engineer	:Kazuma Ho	Humi.	:60 %
Test Mode	: EUT stands vertically (worst case)		

Freq MHz	Reading dBμV	Correction Factor dB	Result dBμV/m	Limits (AVG) dBμV/m	Over limit dB	Detector
1101.2000	51.34	-10.94	40.40	54.00	-13.60	Peak
1332.2000	50.45	-10.29	40.16	54.00	-13.84	Peak
1708.4000	50.17	-8.38	41.79	54.00	-12.21	Peak
2128.6000	49.02	-6.24	42.78	55.60	-12.82	Peak
2405.8000	48.99	-5.56	43.43	55.60	-12.17	Peak
2790.8000	48.89	-4.31	44.58	54.00	-9.42	Peak

Note :

1. Result = Reading + Corrected Factor
2. Corrected Factor = Antenna Factor + Cable Loss - Amplifier Gain (if any)
3. The margin value=Limit – Result
4. Peak measurements are compared to the average limit - as peak measurements are below the average limit, they also comply with the peak limit.

### C. Emission frequencies below 30MHz (9kHz - 30MHz)

According to exploratory test no any obvious emission were detected from 9kHz to 30MHz. All emissions were greater than 20 dB below the limit. Although these tests were performed other than open area test site, adequate comparison measurements were confirmed against 30 m open are test site. Therefore sufficient tests were made to demonstrate that the alternative site produces results that correlate with the ones of tests made in an open field based on KDB 414788.

#### 4.4 Field Strength Calculation

The field strength is calculated by adding the Antenna Factor and Cable Factor, and subtracting the Amplifier Gain (if any) from the measured reading. For the limit is employed average value, therefore the peak value can be transferred to average value by subtracting the duty factor. The basic equation with a sample calculation is as follows:

$$\text{Peak} = \text{Reading} + \text{Corrected Factor}$$

where

Corr. Factor = Antenna Factor + Cable Factor - Amplifier Gain (if any)

And the average value is

$$\text{Average} = \text{Peak Value} + \text{Duty Factor}$$

*Note : If the measured frequencies are fall in the restricted frequency band, the limit employed must be quasi peak value when frequencies are below or equal to 1 GHz. And the measuring instrument is set to quasi peak detector function.*

#### 4.5 Activate Time

This EUT is operated by manually, and Activate Time is less than 5 second after being released.

#### 4.6 Calculation of Duty Factor

The duty factor is calculated with following formula :

$$20 \log \frac{\text{Total Duty}}{\text{Period of Pulse Train}}$$

$$\text{Duty Factor} = 20 \log \frac{(0.600\text{ms} * 21) + (0.800\text{ms} * 20) \text{ ms}}{52.2 \text{ ms}} = -5.2 \text{ dB}$$

### Period of Pulse Train



Ref -20 dBm      Att 10 dB      RBW 1 MHz      Delta 1 [T1 ]  
VBW 3 MHz      -2.01 dB  
SWT 100 ms      52.200000 ms

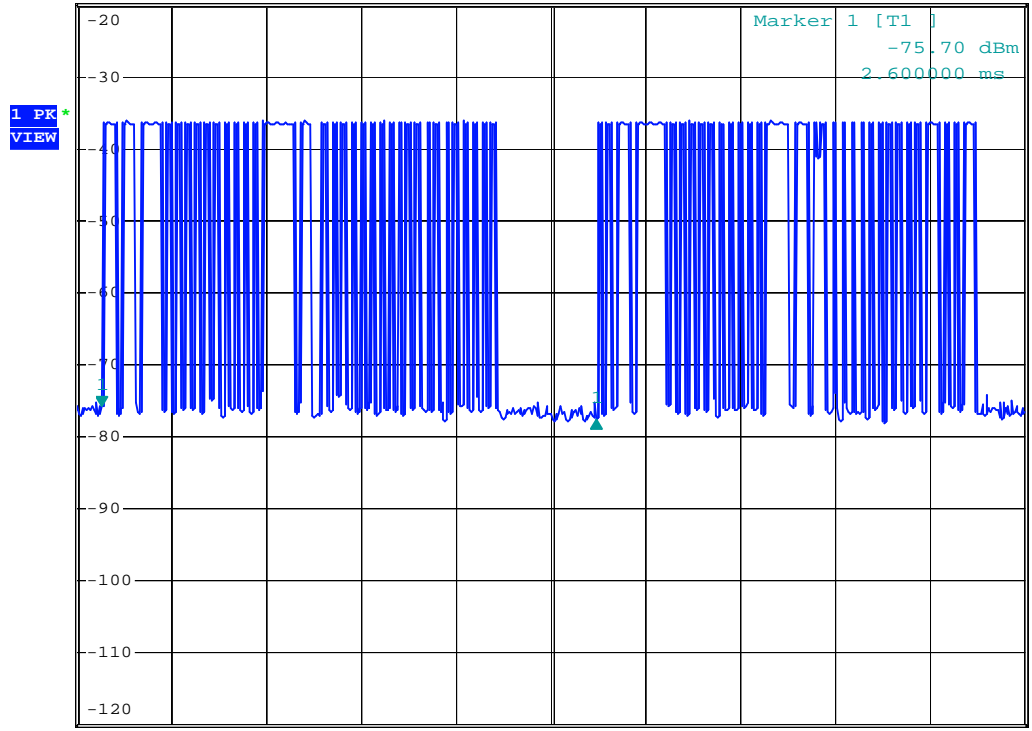

### Detail of a single pulse train

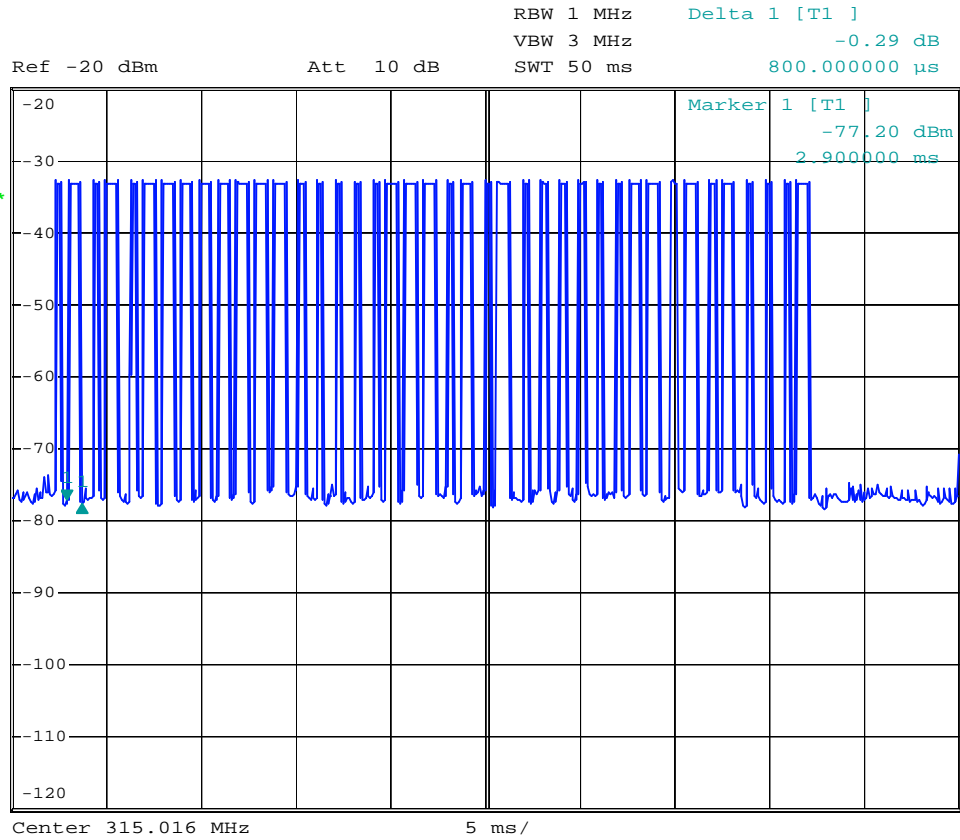
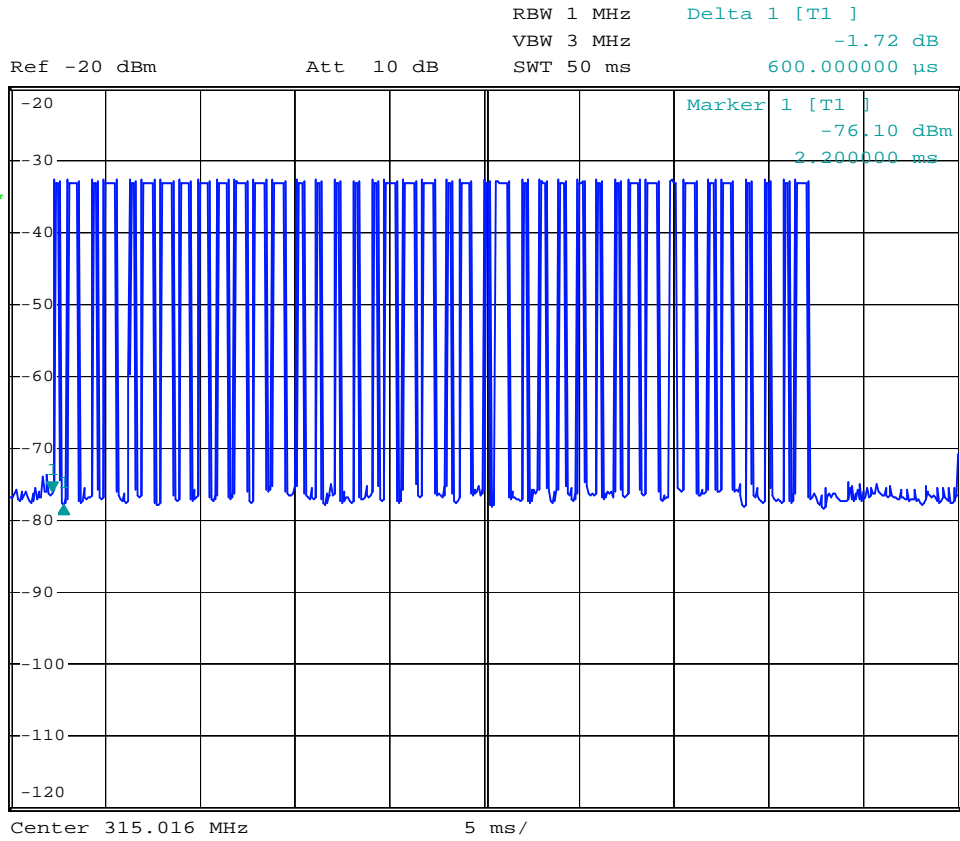

### Activate Time



RBW 1 MHz    Delta 1 [T1 ]  
VBW 3 MHz    -1.58 dB  
SWT 5 s      470.000000 ms

Ref -20 dBm    Att 10 dB

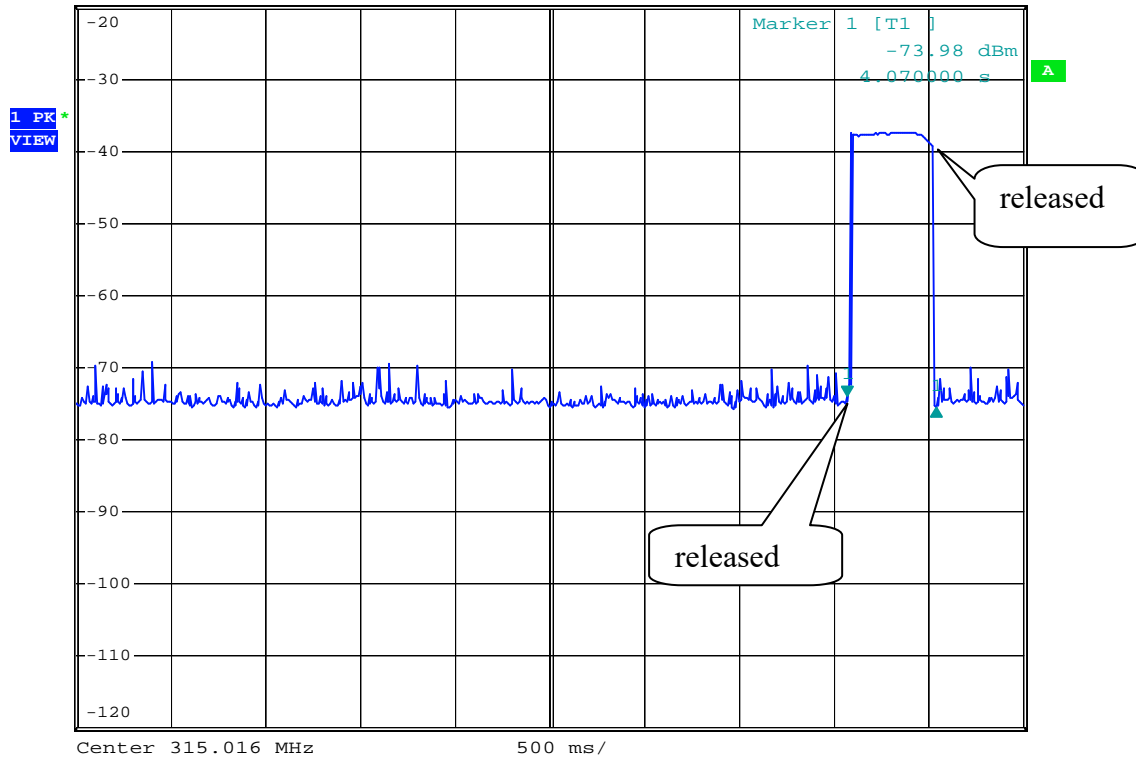

**4.7 Radiated Test Equipment**

Equipment	Manufacturer	Model No.	Calibration Date	Next Cal. Date
Test Receiver	Rohde & Schwarz	ESCI	2016/09/07	2017/09/06
Bi-Log Antenna	ETC	MCTD 2786	2016/07/15	2017/07/14
Log-periodic Antenna	EMCO	3146	2017/07/05	2018/07/04
Biconical Antenna	EMCO	3110	2017/07/05	2018/07/04
Double Ridged Antenna	EMCO	3115	2016/10/05	2017/10/04
Amplifier	HP	8449B	2016/10/14	2017/10/13
Amplifier	HP	83051A	2016/07/18	2017/07/17
Amplifier	HP	8447D	2016/09/26	2017/09/25
EMI Test Receiver	Rohde & Schwarz	ESU 40	2016/11/10	2017/11/09
LOOP Antenna	EMCO	6512	2016/10/12	2017/10/11

**4.8 Measuring Instrument Setup**

Explanation of measuring instrument setup in frequency band measured is as following :

Frequency Band (MHz)	Instrument	Function	Resolution bandwidth	Video Bandwidth
30 to 1000	RF Test Receiver	Quasi-Peak	120 kHz	N/A
	Spectrum Analyzer	Peak	100 kHz	100 kHz
Above 1000	Spectrum Analyzer	Peak	1 MHz	1 MHz
	Spectrum Analyzer	Average	1 MHz	10 Hz

#### 4.9 Radiated Measurement Photos

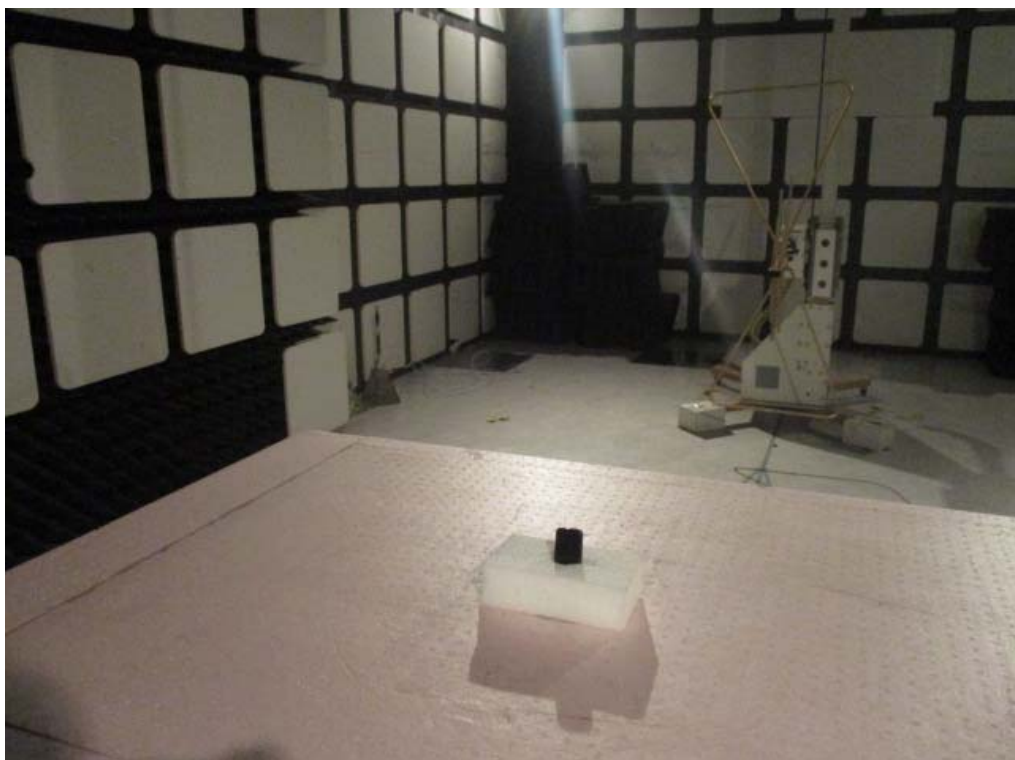





## 5. BANDWIDTH OF EMISSION

### 5.1 Applicable Standard Plot Graphic of Bandwidth

Per FCC rule §15.231(c), the permitted emission bandwidth is no wider than 0.25% of the center frequency for devices operating above 70 MHz and below 900 MHz.

### 5.2 Bandwidth Test Equipment

Equipment	Manufacturer	Model No.	Calibration Date	Next Cal. Date
EMI Test Receiver	Rohde & Schwarz	ESU 40	2016/11/10	2017/11/09

### 5.3 Plot Graphic of Bandwidth

The emission bandwidth limit is:

$$315.016 \text{ MHz} \times 0.25\% = 787.54 \text{ kHz}$$

$$20 \text{ dB bandwidth} = 10 \text{ KHz}$$

**Test Result: 10 kHz < 787.54 kHz.**

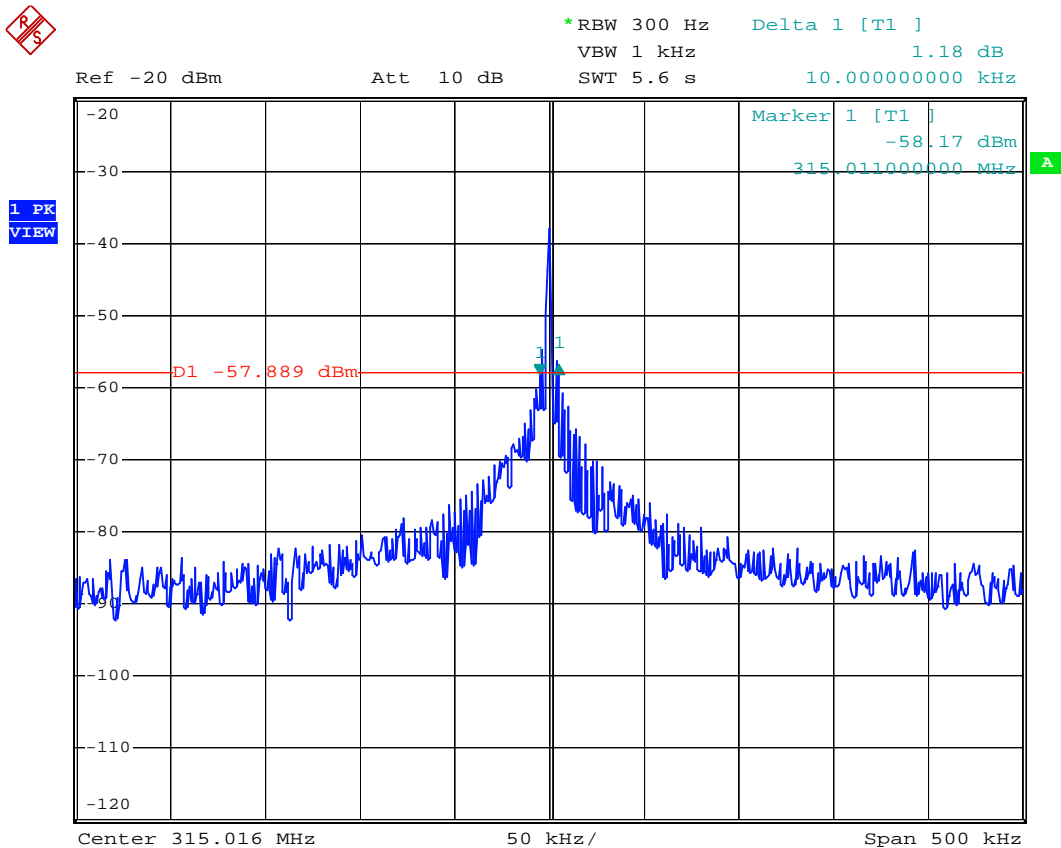

## **6. CONDUCTED EMISSION MEASUREMENT**

### **6.1 Description**

This EUT is excused from investigation of conducted emission, for it is powered by DC battery only. According to §15.207 (d), measurements to demonstrate compliance with the conducted limits are not required for devices which only employ battery power for operation and which do not operate from the AC power lines or contain provisions for operation while connected to the AC power lines.

## **7 ANTENNA REQUIREMENT**

### **7.1 Standard Applicable**

According to §15.203, an intentional radiator shall be designed to ensure that no antenna other than that furnished by the responsible party shall be used with the device.

### **7.2 Antenna Construction**

The antenna is permanently integrated on RF Board, no consideration of replacement. Please see photos submitted in Exhibit B.