

State : High Power / Authorized Bandwidth 6 kHz (4K00F2D)

No.	Tuned Frequency (MHz)	Band	Spurious Frequency (MHz)	Correct Level (dBm)	Emission Level (dBc)	Mask E Limit (dBc)	Margin (dB)
1	406.15 (FCC/RSS)	Low	812.30	-37.43	<b>-83.97</b>	-65.0	19.0
2	429.95 (FCC/RSS)	Middle	859.90	-37.42	<b>-83.96</b>	-65.0	19.0
3	469.95 (FCC/RSS)	High	939.90	-38.24	<b>-84.77</b>	-65.0	19.8

There is the margin of 20dB over except for the above points.

Mask E Limit (dBc) = whichever is the lesser attenuation ;  $-(55+10\log(P))$  or -65

Correct Level (dBm) = Substitute SG Level (dBm)

Emission Level (dBc) = Correct Level (dBm) -  $10\log(P*1000)$

P = Carrier Level (W)

" - " = Measurement Limit

State : Low Power / Authorized Bandwidth 6 kHz (4K00F2D)

No.	Tuned Frequency (MHz)	Band	Spurious Frequency (MHz)	Correct Level (dBm)	Emission Level (dBc)	Mask E Limit (dBc)	Margin (dB)
1	406.15 (FCC/RSS)	Low	812.30	-42.82	<b>-79.81</b>	-62.0	17.8
2	429.95 (FCC/RSS)	Middle	859.90	-42.32	<b>-79.31</b>	-62.0	17.3
3	469.95 (FCC/RSS)	High	939.90	-42.57	<b>-79.56</b>	-62.0	17.6

There is the margin of 20dB over except for the above points.

Mask E Limit (dBc) = whichever is the lesser attenuation ;  $-(55+10\log(P))$  or -65

Correct Level (dBm) = Substitute SG Level (dBm)

Emission Level (dBc) = Correct Level (dBm) -  $10\log(P*1000)$

P = Carrier Level (W)

" - " = Measurement Limit

4K00F2D  
9 KHz to Fc

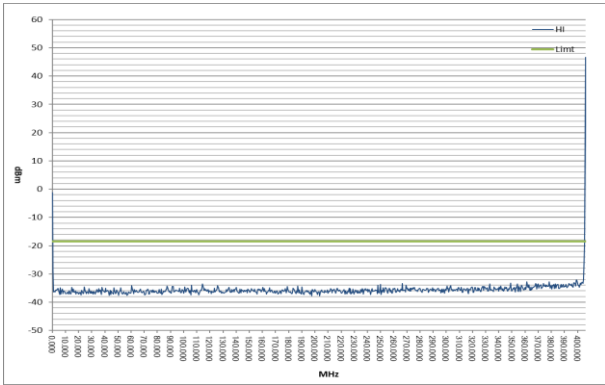

Hi Power

Fc to 2Fc

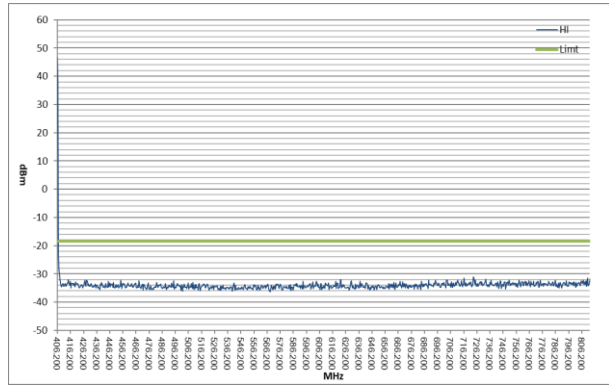

2Fc to 1GHz

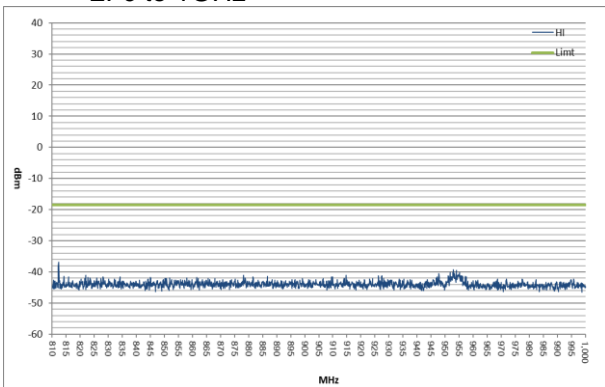

1GHz to 2GHz

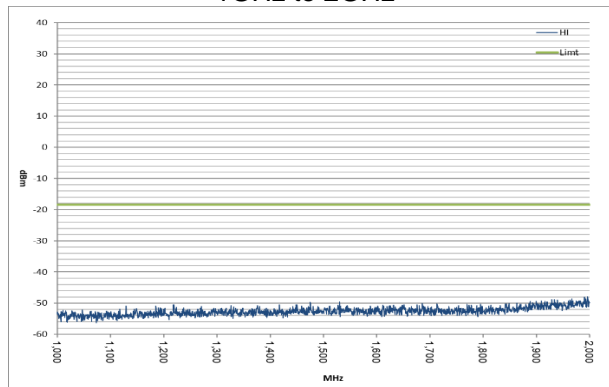

2GHz to 10Fc

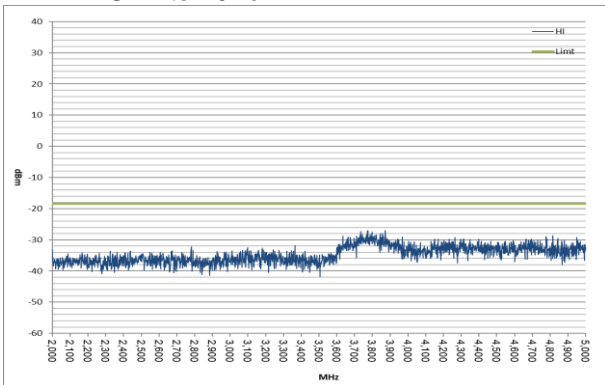

4K00F2D  
9 KHz to Fc

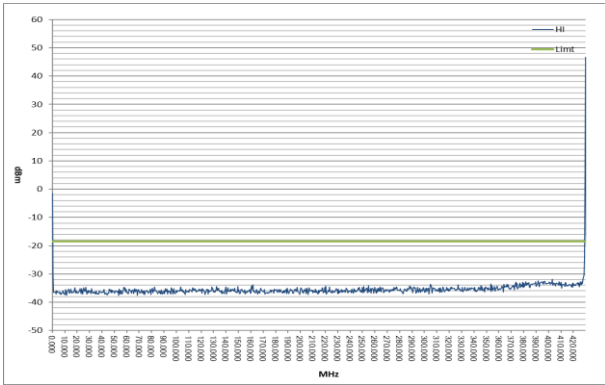

Hi Power

Fc to 2Fc

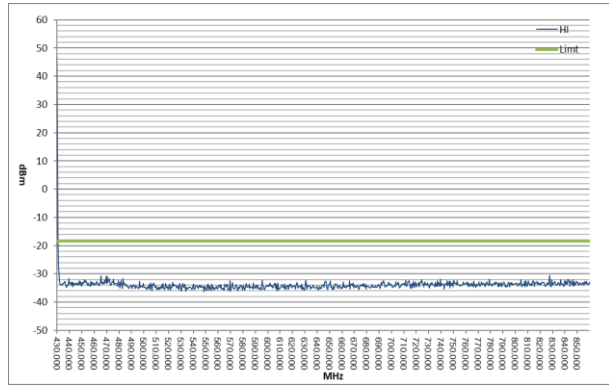

2Fc to 1GHz

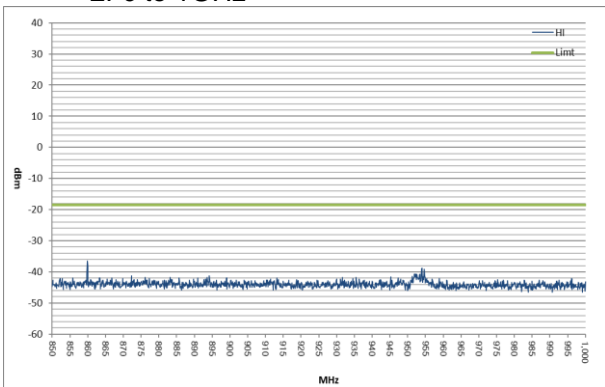

1GHz to 2GHz

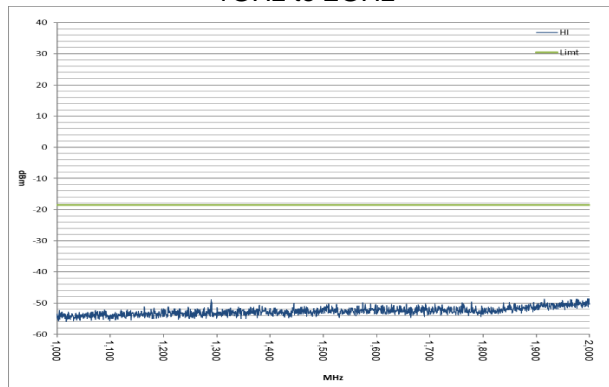

2GHz to 10Fc

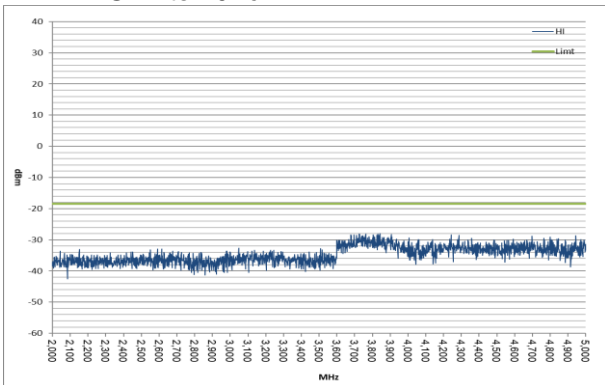

4K00F2D  
9 KHz to Fc

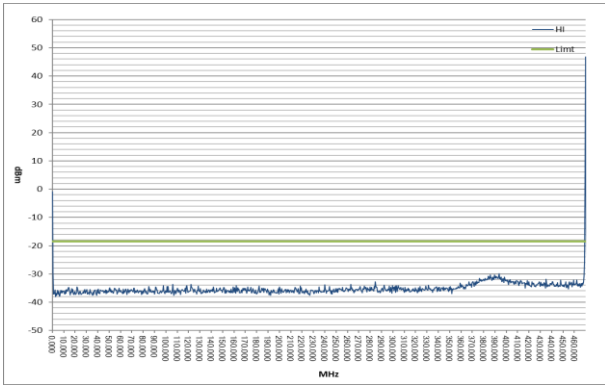

Hi Power

Fc to 2Fc

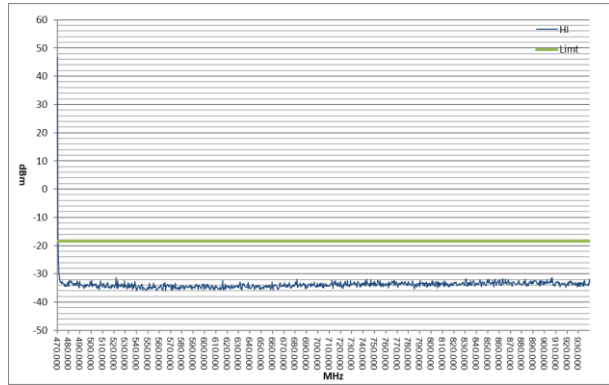

2Fc to 1GHz

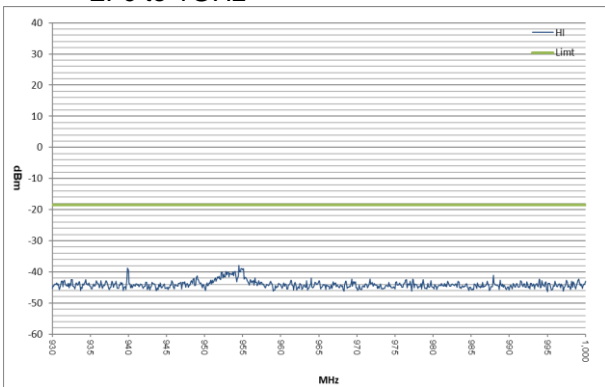

1GHz to 2GHz

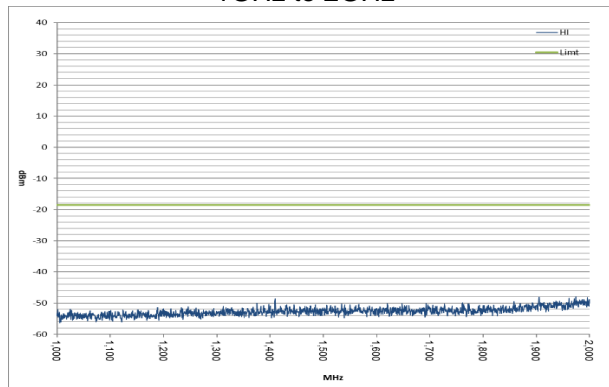

2GHz to 10Fc

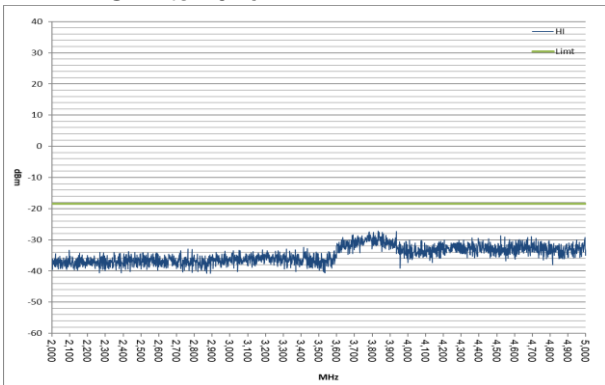

4K00F2D  
9 KHz to Fc

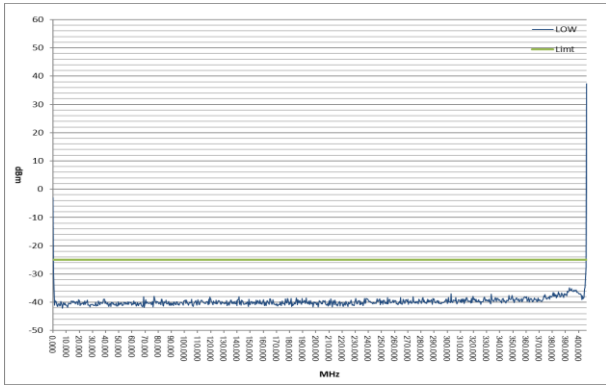

Low Power

Fc to 2Fc

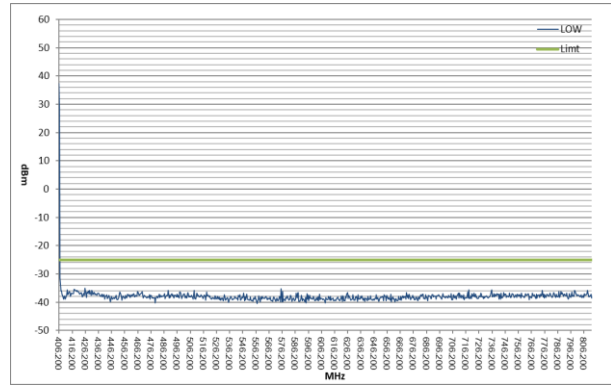

2Fc to 1GHz

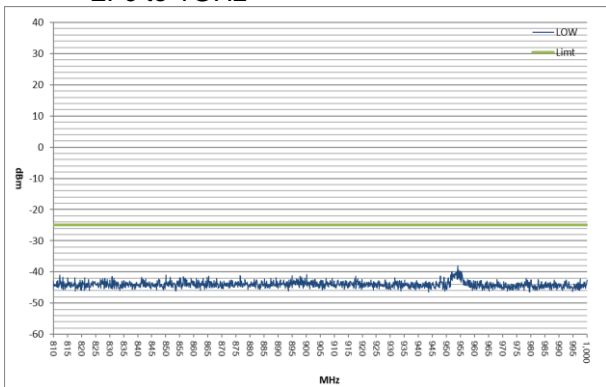

1GHz to 2GHz

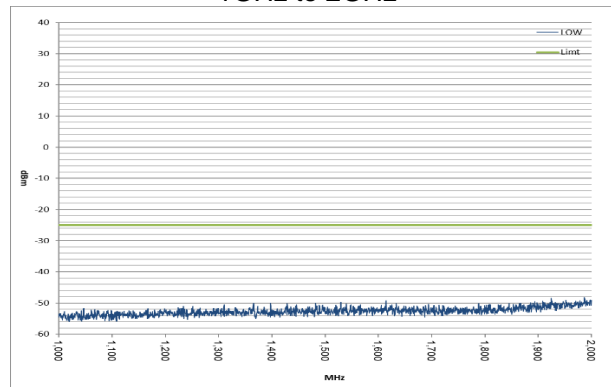

2GHz to 10Fc

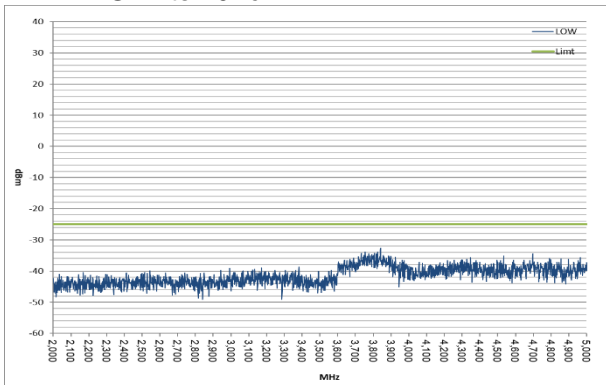

4K00F2D  
9 KHz to Fc

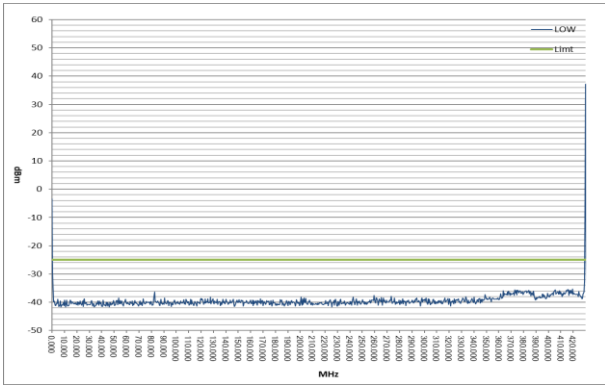

Low Power

Fc to 2Fc

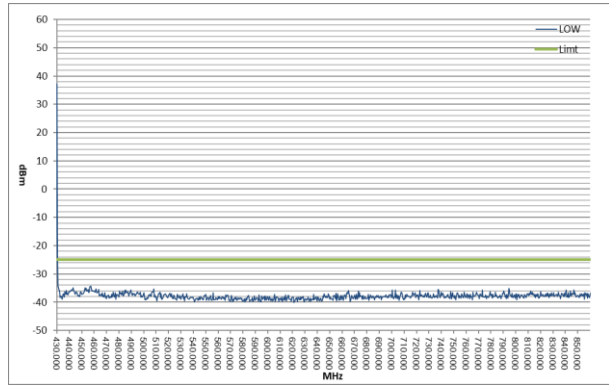

2Fc to 1GHz

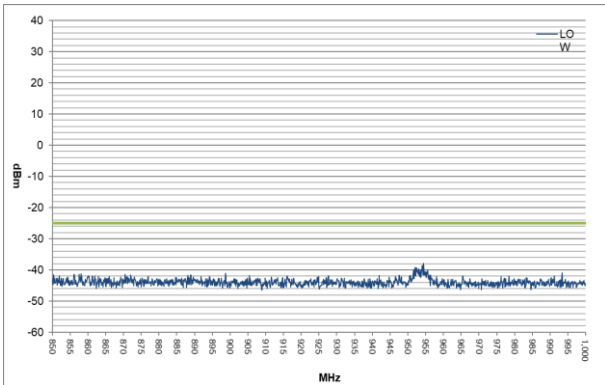

1GHz to 2GHz

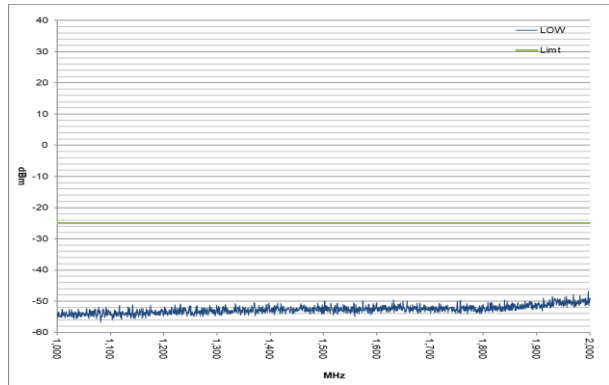

2GHz to 10Fc

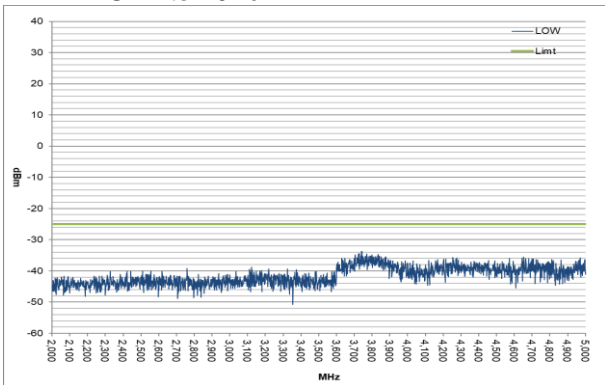

4K00F2D  
9 KHz to Fc

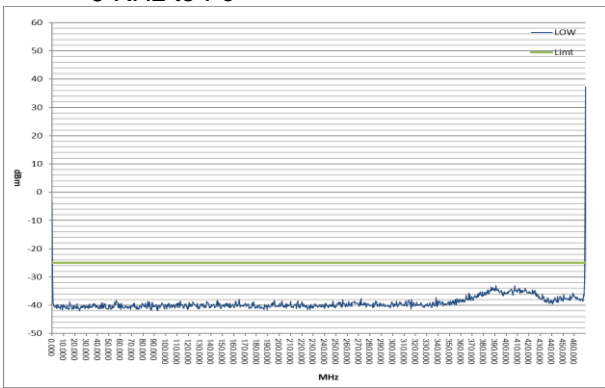

Low Power

Fc to 2Fc

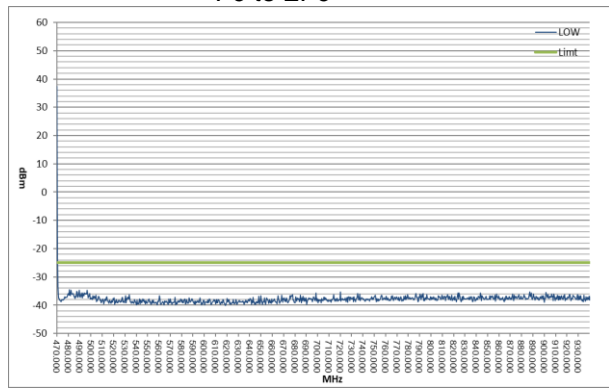

2Fc to 1GHz

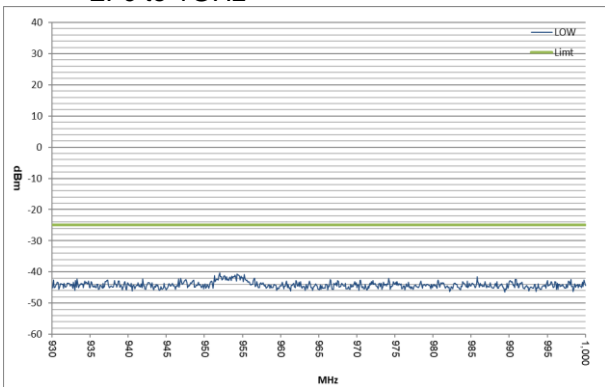

1GHz to 2GHz

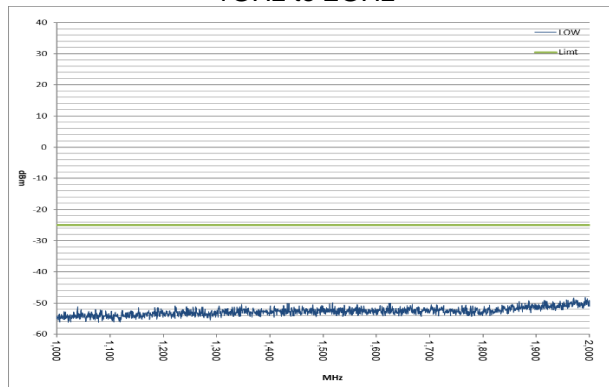

2GHz to 10Fc

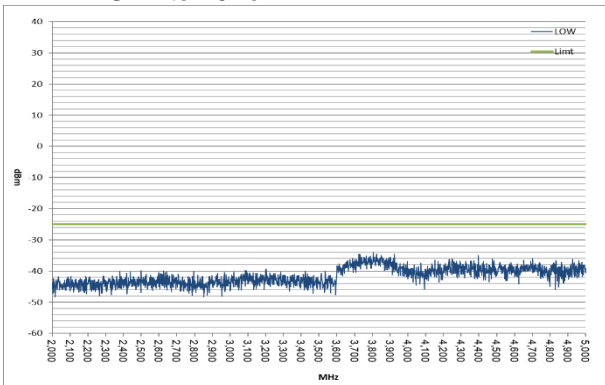

### 10.3 Field Strength of Spurious Radiation

REGULATIONS	:	FCC Part 2 Section 1053 (a), Part 22 Section 359, Part 90 Section 210 RSS-119 Section 5.8
TEST METHOD/GUIDE	:	ANSI/TIA-603-E Section 2.2.12.2 / RSS-119 Section 4.2 ANSI C63.26 Section 5.5

#### Test Procedure

- 1 The EUT and test equipment were set up as shown on the following page.
- 2 Adjust the spectrum analyzer for the following setting:
  - a) RBW : 100 kHz (< 1 GHz), 1 MHz (> 1 GHz).
  - b) VBW : 300 kHz (< 1 GHz), 3 MHz (> 1 GHz).
  - c) Detector mode : Positive Peak
- 3 The transmitter was placed on a wooden turntable, and it was transmitting into non-radiating load which was also placed on the turntable.
- 4 The measurement antenna was placed at a distance of 3 meters from the EUT.  
 During the tests, the antenna height and polarization as well as EUT azimuth were varied in order to identify the maximum level of emissions from the EUT.  
 The test was performed by placing the EUT on 3-orthogonal axis.
- 5 The frequency range up to tenth harmonic of the fundamental frequency was investigated.
- 6 Remove the EUT and replace it with substitution antenna. A signal generator was connected to the substitution antenna by a non-radiating cable.  
 The absolute levels of the spurious emissions were measured by the substitution.
- 7 Spurious emissions in dB = 10 Log (TX power in Watts/0.001) – the absolute level

#### Measuring Equipments

No.	Equipment	Manufacture	Model No.	Serial No.	Cal. Interval	Effective period
1	Attenuator(10dB)	HUBER+SUHNER	6810.17B	5061	1Y	Dec. 16, 22
2	Dummy Load	TME	CT-150NP	1138693	1Y	Dec. 08, 22
3	Signal Generator	Rohde&Schwarz	SMB 100A	105709	1Y	Jun. 05, 23
4	Spectrum Analyzer / Receiver	Agilent	N9038A	MY51210201	1Y	Nov. 25, 22
5	D.R.G Antenna(RX)	Schwarzbeck	3115	5044	1Y	Jun. 28, 23
6	D.R.G Antenna(TX)	Schwarzbeck	3115	5045	1Y	Apr. 04, 23
7	Dipole Antenna(TX)	Schwarzbeck	UHA9105	AM0082002	1Y	May. 17, 23
8	Dipole Antenna(TX)	Schwarzbeck	VHA9103	C01082007	1Y	May. 17, 23
9	Tri-log Antenna(RX)	Schwarzbeck	VULB9168WP	126	1Y	Nov. 09, 22
10	DC Power Supply	Daiichi denpa kogyo	GZV4000	90290931	None	None
11	Digital Multi Meter	FLUKE	8846A	9642018	1Y	Jun. 30, 23
12	Amplifier	TOYO	TPA0118-30	0402	1Y	Sep. 06, 22
13	Attenuator	HUBER + SUHNER	6803.17.B	5111	1Y	Sep. 05, 22
14	Amplifier	Intertek Japan	ZX60-3018G	002	1Y	Feb. 24, 23
15	Attenuator	TAMAGAWA	CFA-01	A00040805	1Y	Feb. 24, 23
16	RF Switch	Intertek Japan	ACX-150-1	A12301501	1Y	Feb. 24, 23



**Measuring Cables**

No.	Cable	Manufacturer	Model No.	Serial No.	Cal. Interval	Effective period
R11	Coaxial Cable	FUJIKURA	5D-2W	R11	1Y	Feb. 24, 23
R1	Coaxial Cable	FUJIKURA	5D-2W	R1	1Y	Feb. 24, 23
R3	Coaxial Cable	FUJIKURA	10D-2W	R3	1Y	Feb. 24, 23
R5	Coaxial Cable	FUJIKURA	RG-5A/U	R5	1Y	Feb. 24, 23
R7	Coaxial Cable	MIYAZAKI	5D-2W	R7	1Y	Feb. 24, 23
R10	Coaxial Cable	FUJIKURA	5D-2W	R10	1Y	Feb. 24, 23
R13	Coaxial Cable	SUHNER	SUCOFLEX 104	229603	1Y	Sep. 06, 22
R12	Coaxial Cable	Candox	5B-048-98-98-5000	111130	1Y	Sep. 06, 22
W13	Coaxial Cable	Suhner	SUCOFLEX106	KSR00207	1Y	Dec. 16, 22

**Measuring Equipment Configuration**

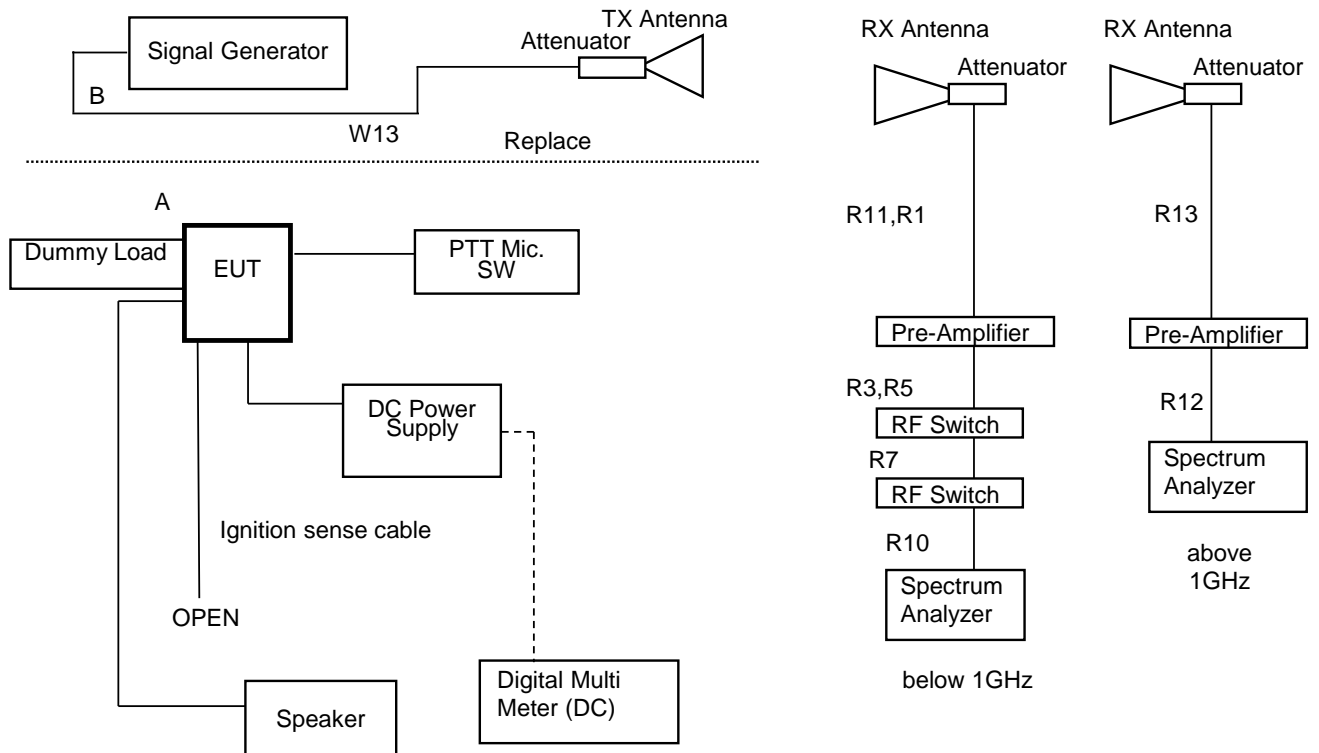

### Test Results

Test date	Jul 04, 2022	
Location	Kashima No.12 Test Site	
temperature	20.2 to 21.1	[degree C]
Humidity Variation	48 to 50	[%]
Atmospheric Pressure	100.6 to 100.7	[kPa]
Test Engineer	Koichi Wagatsuma	

Test was carried out for all the frequency band of section 10.1  
 State the worst case (below).

State : High Power / Authorized Bandwidth 11.25 kHz / 429.95MHz(FCC /RSS)

No	Frequency (MHz)	Pol	Reading Level (dBm)	SG Out Level (dBm)	Antenna Gain (dBd)	Loss (dB)	Correct Level (dBm)	Emission Level (dBc)	MASK D Limit Level (dBc)	Margin (dB)
1	859.90	Hor.	-70.42	-36.79	-1.41	12.39	-50.6	<b>-97.1</b>	-66.5	30.6
		Ver.	-74.14	-38.74	-1.41	12.39	-52.5	<b>-99.1</b>	-66.5	32.6
2	1289.85	Hor.	-44.49	-27.60	4.99	12.89	-35.5	<b>-82.0</b>	-66.5	15.5
		Ver.	-48.75	-32.20	4.99	12.89	-40.1	<b>-86.6</b>	-66.5	20.1
3	1719.80	Hor.	-57.08	-40.05	6.22	13.33	-47.2	<b>-93.7</b>	-66.5	27.2
		Ver.	-57.76	-40.56	6.22	13.33	-47.7	<b>-94.2</b>	-66.5	27.7
4	2149.75	Hor.	-57.48	-39.13	6.93	13.74	-45.9	<b>-92.5</b>	-66.5	26.0
		Ver.	-58.36	-40.02	6.93	13.74	-46.8	<b>-93.4</b>	-66.5	26.9
5	2579.70	Hor.	-59.48	-40.19	7.66	14.11	-46.6	<b>-93.2</b>	-66.5	26.7
		Ver.	-57.81	-37.89	7.66	14.11	-44.3	<b>-90.9</b>	-66.5	24.4
6	3009.65	Hor.	-	-	7.47	14.49	-	-	-66.5	-
		Ver.	-	-	7.47	14.49	-	-	-66.5	-
7	3439.60	Hor.	-	-	7.74	14.83	-	-	-66.5	-
		Ver.	-	-	7.74	14.83	-	-	-66.5	-
8	3869.55	Hor.	-59.54	-37.02	7.63	15.18	-44.6	<b>-91.1</b>	-66.5	24.6
		Ver.	-59.45	-36.41	7.63	15.18	-44.0	<b>-90.5</b>	-66.5	24.0
9	4299.50	Hor.	-	-	8.31	15.48	-	-	-66.5	-
		Ver.	-	-	8.31	15.48	-	-	-66.5	-

There is the margin of 20dB over except for the above points.

Mask D Limit (dBc) = whichever is the lesser attenuation ;  $-(50+10\log(P))$  or -70  
 Correct Level (dBm) = Substitute SG Level (dBm) + ANT Gain (dBd) - Loss (Cable, Attenuator) (dB)  
 Emission Level (dBc) = Correct Level (dBm) -  $10\log(P*1000)$   
 P = Carrier Level (W)  
 " - " = Measurement Limit

State : Low Power / Authorized Bandwidth 6 kHz / 429.95MHz(FCC /RSS)

No	Frequency (MHz)	Pol	Reading Level (dBm)	SG Out Level (dBm)	Antenna Gain (dBd)	Loss (dB)	Correct Level (dBm)	Emission Level (dBc)	MASK E Limit Level (dBc)	Margin (dB)
1	859.90	Hor.	-78.03	-44.40	-1.41	12.39	-58.2	<b>-95.2</b>	-62.0	33.2
		Ver.	-77.66	-42.27	-1.41	12.39	-56.1	<b>-93.1</b>	-62.0	31.1
2	1289.85	Hor.	-50.91	-34.02	4.99	12.89	-41.9	<b>-78.9</b>	-62.0	16.9
		Ver.	-53.89	-37.34	4.99	12.89	-45.2	<b>-82.2</b>	-62.0	20.2
3	1719.80	Hor.	-56.82	-39.80	6.22	13.33	-46.9	<b>-83.9</b>	-62.0	21.9
		Ver.	-58.52	-41.32	6.22	13.33	-48.4	<b>-85.4</b>	-62.0	23.4
4	2149.75	Hor.	-61.03	-42.68	6.93	13.74	-49.5	<b>-86.5</b>	-62.0	24.5
		Ver.	-59.93	-41.59	6.93	13.74	-48.4	<b>-85.4</b>	-62.0	23.4
5	2579.70	Hor.	-62.90	-43.61	7.66	14.11	-50.1	<b>-87.1</b>	-62.0	25.1
		Ver.	-61.67	-41.75	7.66	14.11	-48.2	<b>-85.2</b>	-62.0	23.2
6	3009.65	Hor.	-	-	7.47	14.49	-	-	-62.0	-
		Ver.	-	-	7.47	14.49	-	-	-62.0	-
7	3439.60	Hor.	-	-	7.74	14.83	-	-	-62.0	-
		Ver.	-	-	7.74	14.83	-	-	-62.0	-
8	3869.55	Hor.	-	-	7.63	15.18	-	-	-62.0	-
		Ver.	-	-	7.63	15.18	-	-	-62.0	-
9	4299.50	Hor.	-	-	8.31	15.48	-	-	-62.0	-
		Ver.	-	-	8.31	15.48	-	-	-62.0	-

There is the margin of 20dB over except for the above points.

Mask E Limit (dBc) = whichever is the lesser attenuation ;  $-(55+10\log(P))$  or -65

Correct Level (dBm) = Substitute SG Level (dBm) + ANT Gain (dBd) - Loss (Cable, Attenuator) (dB)

Emission Level (dBc) = Correct Level (dBm) -  $10\log(P*1000)$

P = Carrier Level (W)

" - " = Measurement Limit

#### 10.4 Emission Masks (Occupied Bandwidth)

REGULATIONS	: FCC Part 2 Section 1049 (c) (1), Part 22 Section 359, Part 74 Section 462, Part 90 Section 210 RSS-119 Section 5.8
TEST METHOD/GUIDE	: ANSI/TIA-603-E Section 2.2.11.2 / RSS-119 Section 5.8

#### Test Procedure

- 1 The EUT and test equipment were set up as shown on the following page.
- 2 For EUT supporting audio modulation, the audio signal generator was adjusted to the frequency of maximum response and with output level set for +/- 2.5 kHz deviation (or 50 % modulation). (FM modulation).
- 3 With level constant, the signal level was increased 16 dB.
- 4 For EUT supporting digital modulation, the digital modulation mode was operated to its maximum extent.
- 5 Adjust the spectrum analyzer for the following setting:
  - a) RBW : 100Hz (Non modulation and Authorized Band 6 kHz),  
100Hz (Non modulation and Authorized Band 11.25 kHz),  
300Hz (Non modulation and Authorized Band 20 kHz).
  - b) VBW : 10times the RBW (Non modulation , Authorized Band 6kHz, 11.25 kHz and 20 kHz).
  - c) RBW and VBW : 30 kHz (Non modulation(Digital Modulation)).
- 6 The occupied Bandwidth was measured with the Spectrum Analyzer controls set as shown on the test results.

**The selection of Emission Mask**

No.	Frequency (MHz)	Audio Filter	Channel Bandwidth (kHz)	Authorized Bandwidth (kHz)	Selection of Emission Mask	
					FCC	RSS
Emission Designation :		16K0F3E				
1	406.15 (FCC/RSS)	With	25	20	B	B
2	429.95 (FCC/RSS)	With	25	20	B	B
3	469.95 (FCC/RSS)	With	25	20	B	B
Emission Designation :		11K0F3E				
1	406.15 (FCC/RSS)	With	12.5	11.25	D	D
2	429.95 (FCC/RSS)	With	12.5	11.25	D	D
3	469.95 (FCC/RSS)	With	12.5	11.25	D	D
Emission Designation :		7K60FXD/FXE/F1E/F1D/F1W/FXW				
1	406.15 (FCC/RSS)	Without	12.5	11.25	D	D
2	429.95 (FCC/RSS)	Without	12.5	11.25	D	D
3	469.95 (FCC/RSS)	Without	12.5	11.25	D	D
Emission Designation :		8K30F1E/F1D/F7W				
1	406.15 (FCC/RSS)	Without	12.5	11.25	D	D
2	429.95 (FCC/RSS)	Without	12.5	11.25	D	D
3	469.95 (FCC/RSS)	Without	12.5	11.25	D	D
Emission Designation :		4K00F1E / F1D / F7W				
1	406.15 (FCC/RSS)	Without	6.25	6	E	E
2	429.95 (FCC/RSS)	Without	6.25	6	E	E
3	469.95 (FCC/RSS)	Without	6.25	6	E	E
Emission Designation :		4K00F2D				
1	406.15 (FCC/RSS)	Without	6.25	6	E	E
2	429.95 (FCC/RSS)	Without	6.25	6	E	E
3	469.95 (FCC/RSS)	Without	6.25	6	E	E

### Measuring Equipments

No.	Equipment	Manufacture	Model No.	Serial No.	Cal. Interval	Effective period
1	Attenuator (20dB)	Aeroflex/Wenshel	66-20-34	BY4357	1Y	Sep. 08, 22
2	Attenuator (30dB)	Weinschel	WA-29-30-34	8923	1Y	Sep. 08, 22
3	Modulation Analyzer	Hewlett Packard	8901B	3403A04852	1Y	Dec. 14, 22
4	Audio Generator	Anritsu	MG443B	M70150	1Y	Jun. 12, 23
5	Spectrum Analyzer	Agilent	N9030A	US51350220	1Y	Aug. 31, 22
6	DC Power Supply	Daiichi denpa kogyo	GZV4000	90290931	None	None
7	Digital Multi Meter	FLUKE	8846A	9642018	1Y	Jun. 30, 23
8	JIG	HP	ProBook 430 G3	PJPNYOKL0147	None	None

### Measuring Cables

No.	Cable	Manufacture	Model No.	Serial No.	Cal. Interval	Effective period
W3	Balance Cable	Nicoon	3D-2V	KSR00092	1Y	Sep. 09, 22
W4	Coaxial Cable	Pacific custom	RG-58 C/U	AM90C03	1Y	Jan. 19, 23
W2	Coaxial Cable	Suhner	SUCOFLEX104	F0000019	1Y	Mar. 24, 23

### Measuring Equipment Configuration

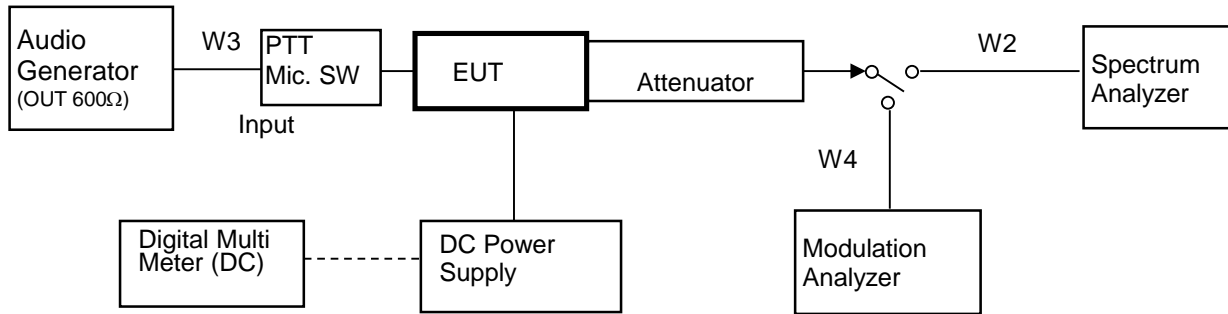

FM Modulation test is with the the Audio Generator.  
Configuration of other Modulation test is composed without the Audio Generator.

<DMR, NXDN and CW ID Modulation Case>

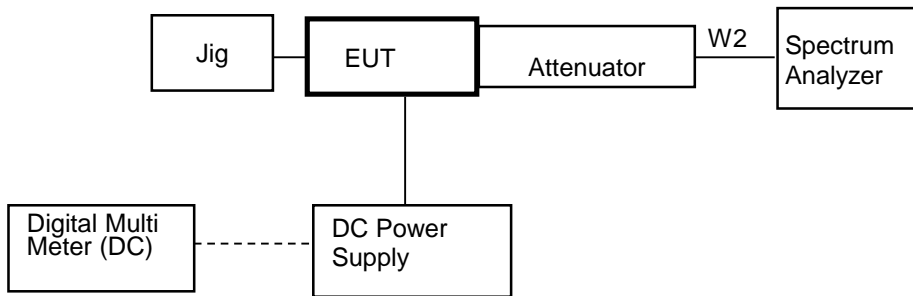

**Test Results**

Test date	Jul. 01, 2022	
Location	Kashima No.12 Test Site	
temperature	25.5	[degree C]
Humidity Variation	47.0	[%]
Atmospheric Pressure	101.1	[kPa]
Test Engineer	Koichi Wagatsuma	

Test was carried out for all the frequency band of section 10.1  
 State the worst case (below).

State : High Power / Authorized Bandwidth 20 kHz/ 16K0F3E / 429.95 MHz(FCC/RSS)  
 Limit : Mask B

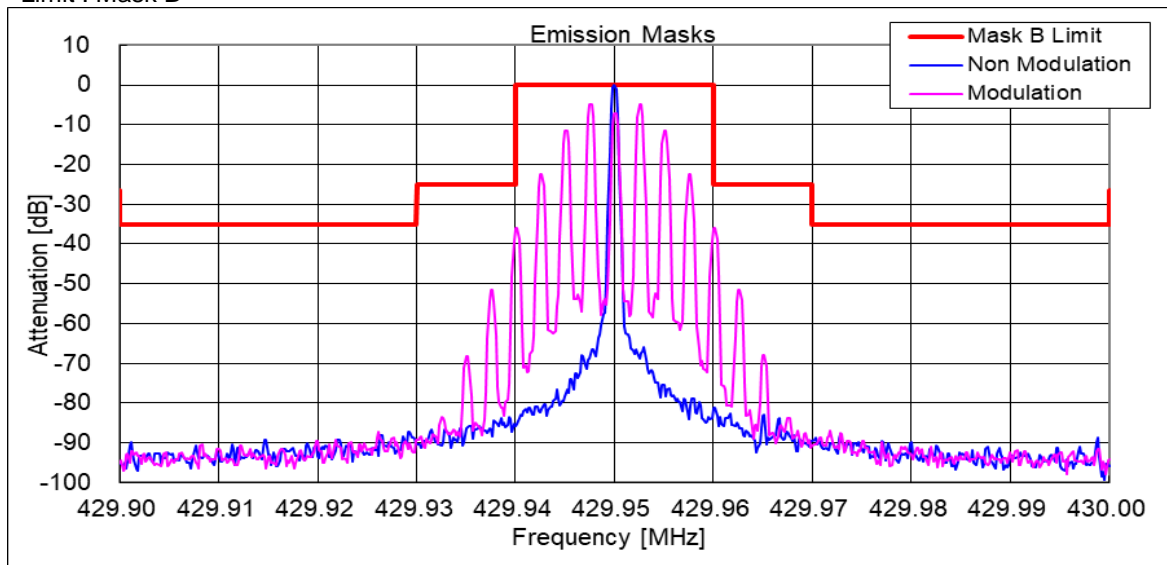

State : Low Power / Authorized Bandwidth 20 kHz/ 16K0F3E / 429.95 MHz(FCC/RSS)  
 Limit : Mask B

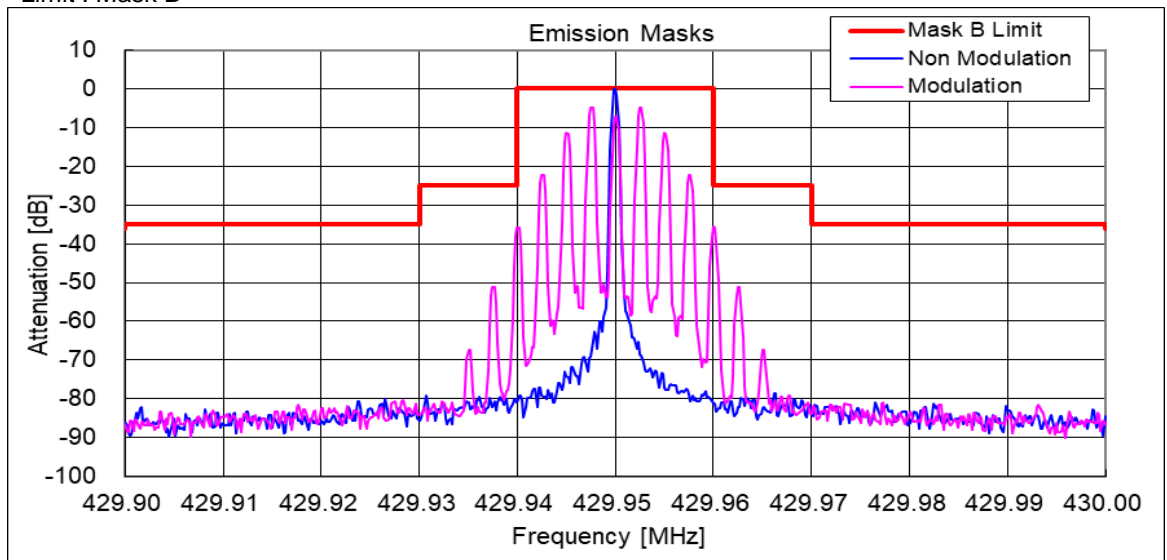



State : High Power / Authorized Bandwidth 11.25 kHz/ 11K0F3E / 469.95 MHz(FCC/RSS)  
Limit : Mask D

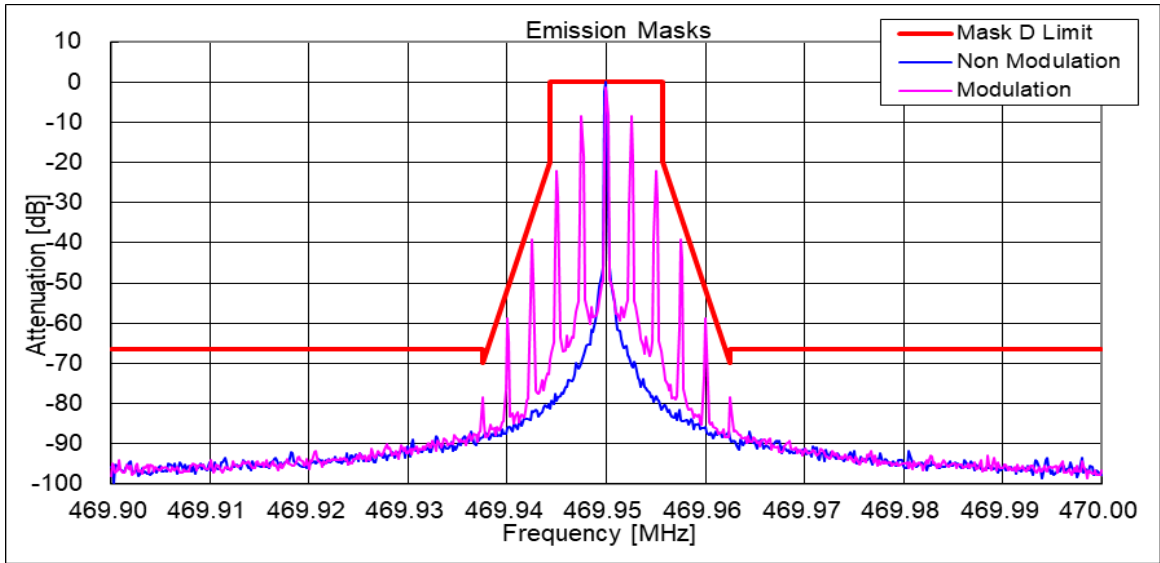

State : Low Power / Authorized Bandwidth 11.25 kHz/ 11K0F3E / 469.95 MHz(FCC/RSS)  
Limit : Mask D

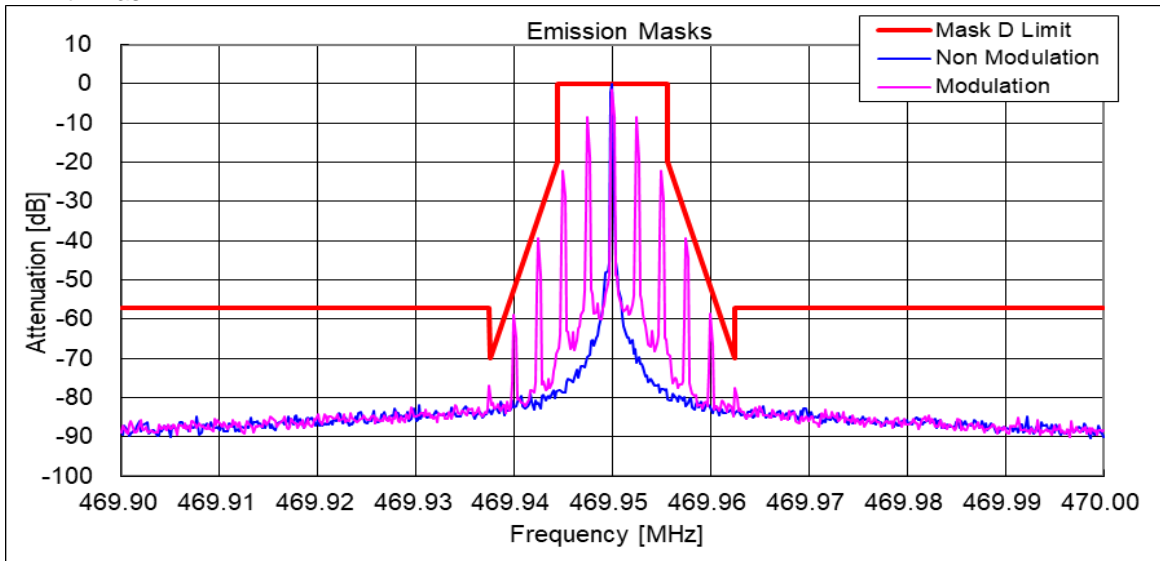

State : High Power / Authorized Bandwidth 11.25 kHz/ 7K60FXD / FXE / F1E / F1D / F1W / FXW / 469.95 MHz(FCC/RSS)  
Limit : Mask D

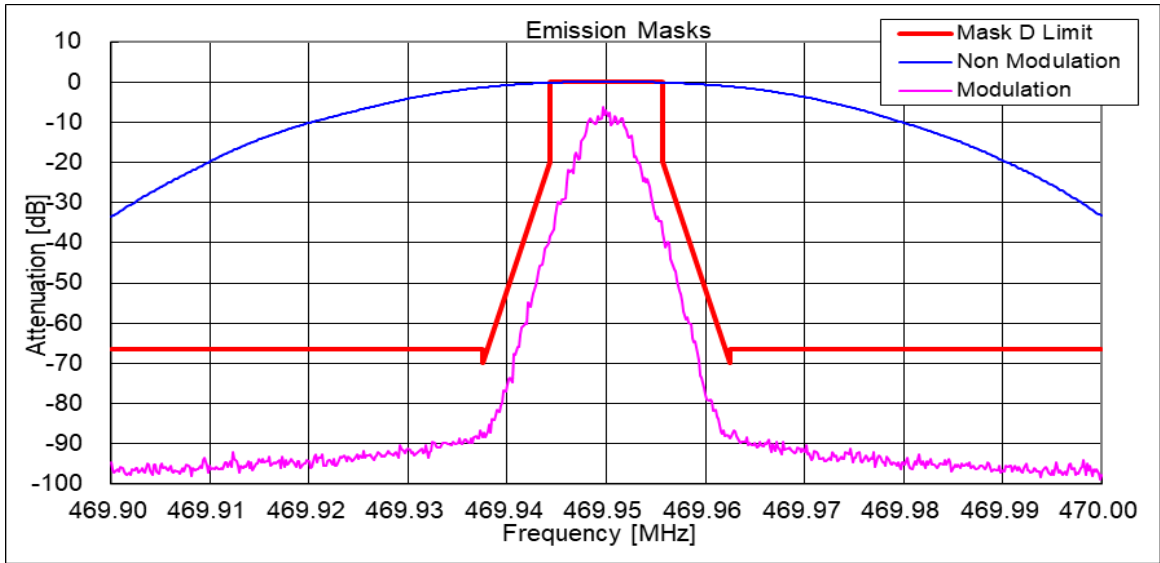

State : Low Power / Authorized Bandwidth 11.25 kHz/ 7K60FXD / FXE / F1E / F1D / F1W / FXW / 429.95 MHz(FCC/RSS)  
Limit : Mask D

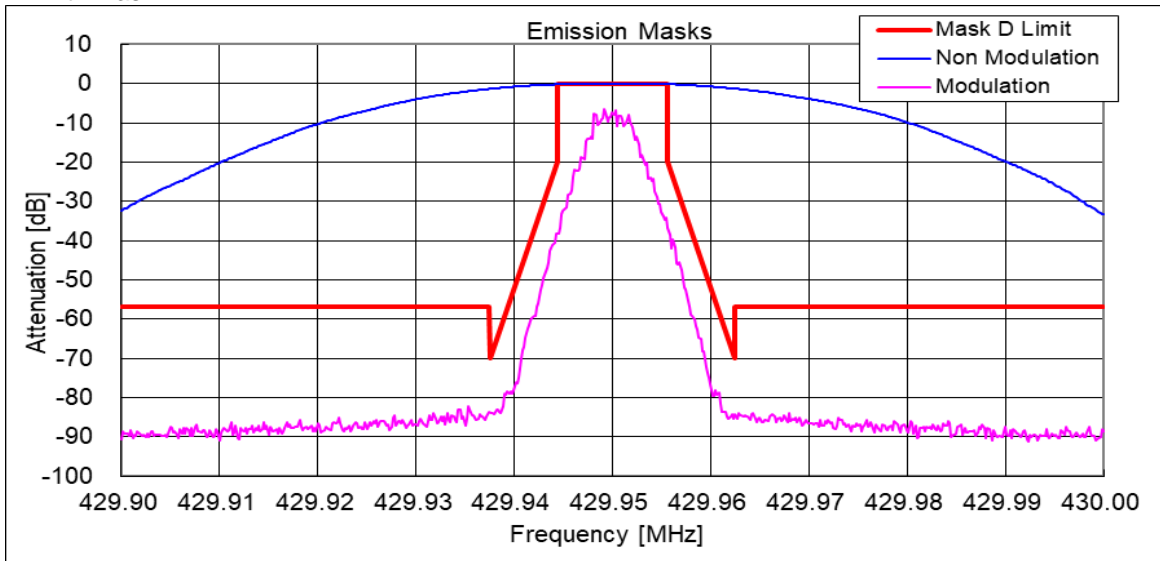

State : High Power / Authorized Bandwidth 11.25 kHz/ 8K30F1E / F1D / F7W / 469.95 MHz(FCC/RSS)  
Limit : Mask D

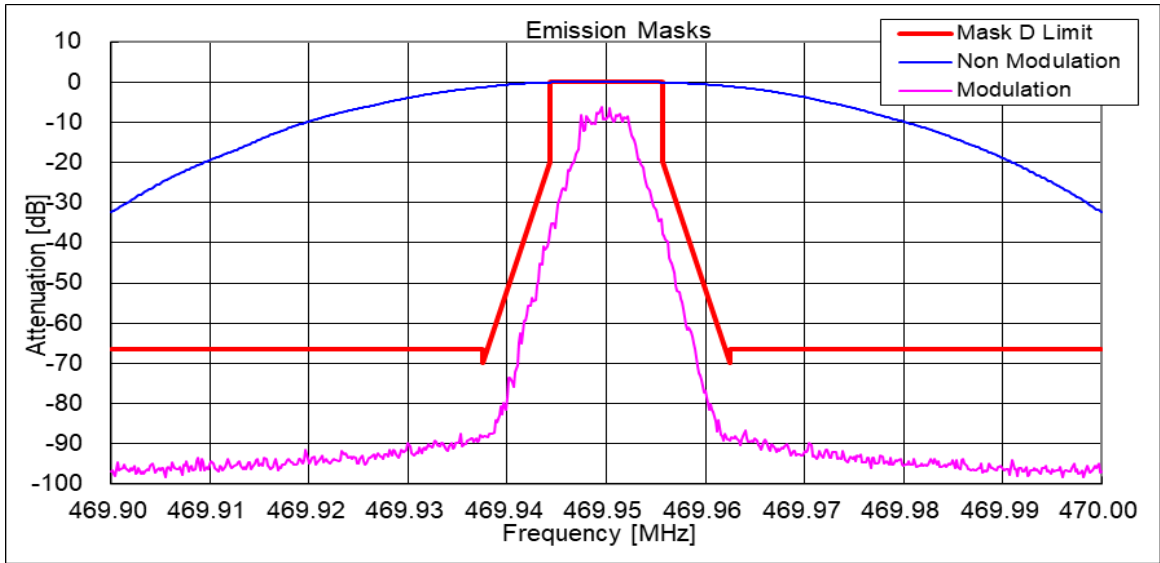

State : Low Power / Authorized Bandwidth 11.25 kHz/ 8K30F1E / F1D / F7W / 429.95 MHz(FCC/RSS)  
Limit : Mask D

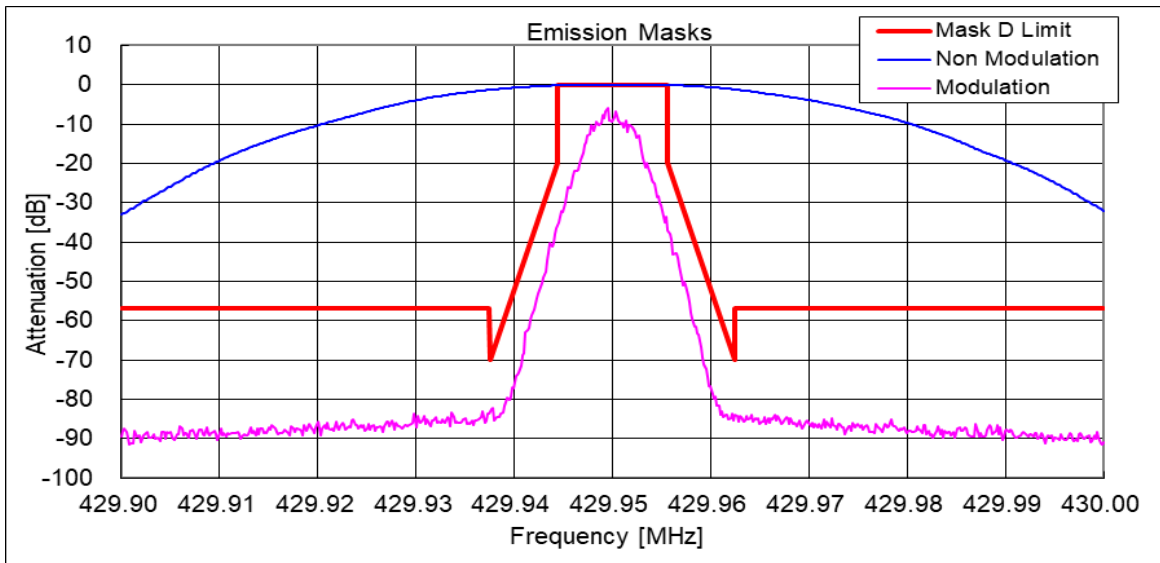

State : High Power / Authorized Bandwidth 6 kHz/ 4K00F1E / F1D / F7W / 406.15 MHz(FCC/RSS)  
Limit : Mask E

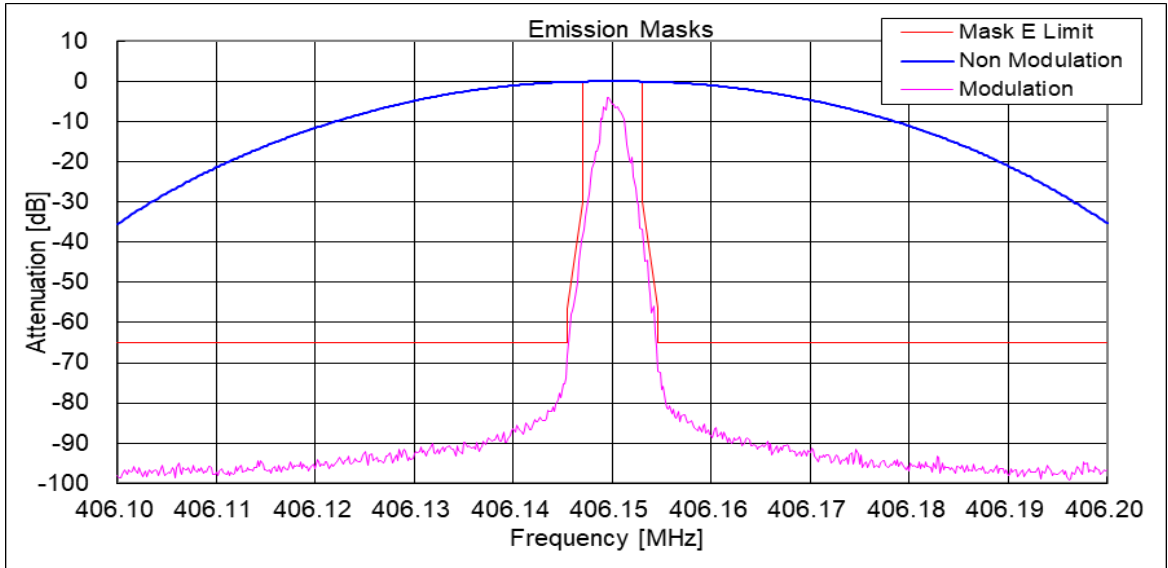

State : Low Power / Authorized Bandwidth 6 kHz/ 4K00F1E / F1D / F7W / 406.15 MHz(FCC/RSS)  
Limit : Mask E

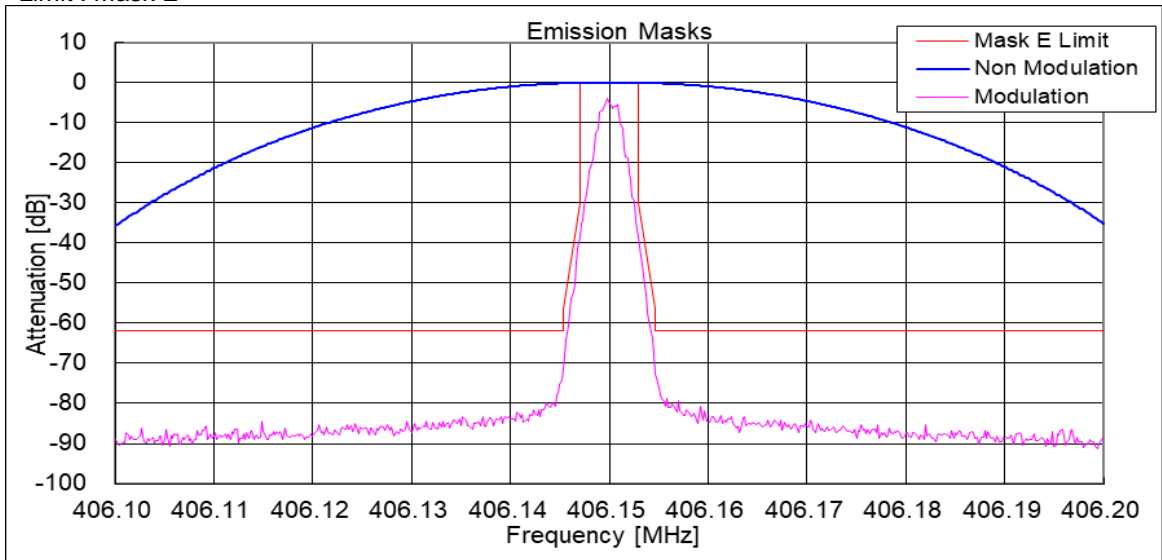

State : High Power / Authorized Bandwidth 6 kHz/ 4K00F2D / 469.95 MHz(FCC/RSS)  
Limit : Mask E

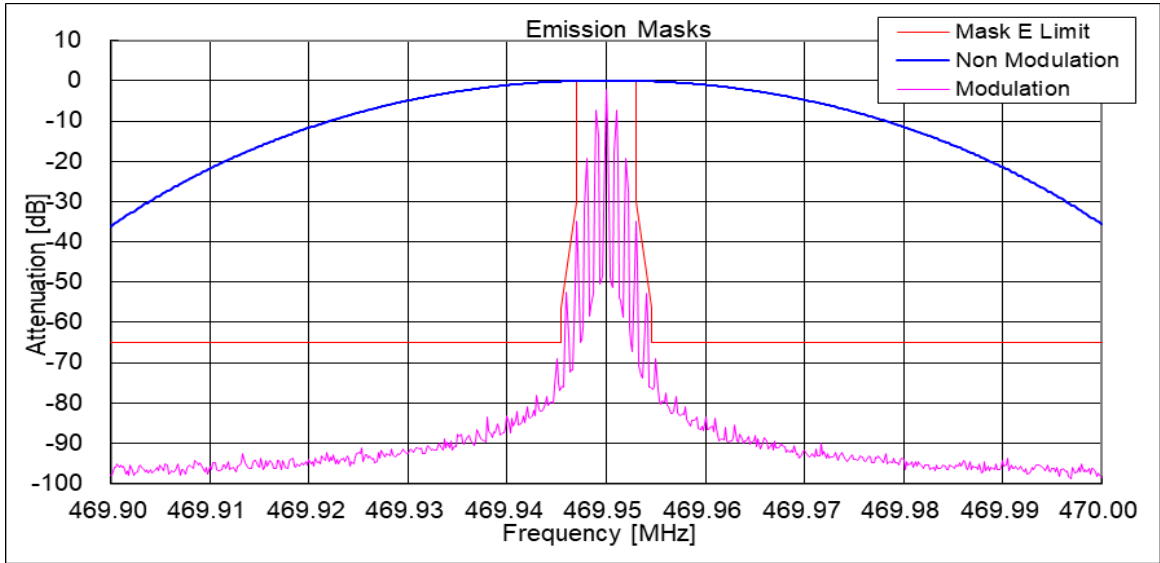

State : Low Power / Authorized Bandwidth 6 kHz/ 4K00F2D / 469.95 MHz(FCC/RSS)  
Limit : Mask E

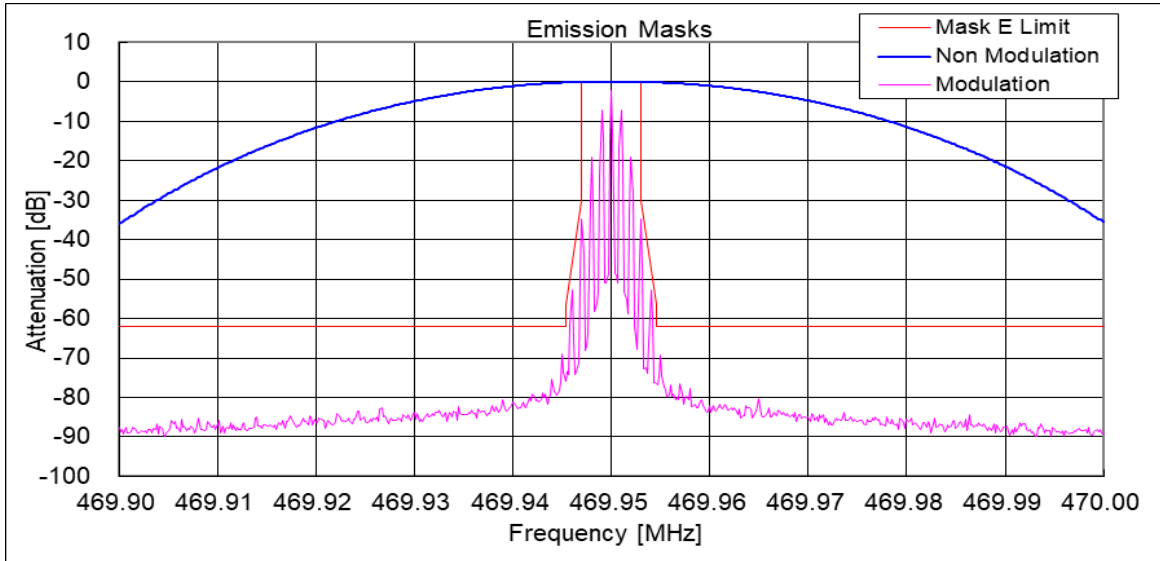

## 10.5 Transient Frequency Behavior

REGULATIONS : FCC Part 90 Section 214 / RSS-119 Section 5.9

TEST METHOD/GUIDE : ANSI/TIA-603-E, Section 2.2.19.3

### Test Procedure

- 1 The EUT and test equipment were set up as shown on the following page.
- 2 The transmitter was turned on.
- 3 The transmitter carrier level was measured at the output of the combiner .
- 4 The transmitter was turned off.
- 5 An RF signal generator (1) modulated with a 1 kHz tone at either 25 kHz or 12.5 kHz or 6.25 kHz deviation, and set to the same frequency as the assigned transmitter frequency, (2) was adjusted to a level -30 dB below the level recorded in Procedure 3, as measured at the output of the combiner.  
 This level was then fixed for the remainder of the test and is recorded at step h.
- 6 The oscilloscope was setup using TIA-603 steps j and k as a guide, however 1000 Hz tone was adjusted at +- 2.5 /div vertically centered on the display.
- 7 The transmitter was turned on, and the level of the carrier at the output of the combiner was recorded as step l.
- 8 The carrier on-time as referenced in TIA-603 steps m, n, and o was captured and plotted.
- 9 The carrier off-time as referenced in TIA-603 steps p, q, r, and s was captured and plotted.

No.	Equipment	Manufacture	Model No.	Serial No.	Cal. Interval	Effective period
1	Power Meter	Hewlett Packard	E4418B	GB38410265	1Y	Aug. 26, 22
2	Power Sensor	Hewlett Packard	8482A	US37292237	1Y	Aug. 26, 22
3	Attenuator (20dB)	Aeroflex/Wenshel	66-20-34	BY4357	1Y	Sep. 08, 22
4	Attenuator (3dB)	TME	CFA-20NPJ-3	679701	1Y	Mar. 28, 23
5	Attenuator (30dB)	Weinschel	WA-29-30-34	8923	1Y	Sep. 08, 22
6	Step Attenuator	Hewlett Packard	8494B	272614515	1Y	Sep. 21, 22
7	Combiner(1)	Anritsu	Z-164A	M89249	1Y	Mar. 28, 23
8	Combiner(2)	Anritsu	Z-164A	M89549	1Y	Mar. 28, 23
9	Modulation Analyzer	Hewlett Packard	8901B	3403A04852	1Y	Dec. 14, 22
10	Signal Generator	Rohde&Schwarz	SMB 100A	105709	1Y	Jun. 05, 23
11	Oscilloscope	Tektronix	TDS5104	B040901	1Y	Aug. 04, 22
12	DC Power Supply	Daiichi denpa kogyo	GZV4000	90290931	None	None
13	Digital Multi Meter	FLUKE	8846A	9642018	1Y	Jun. 30, 23

**Measuring Cables**

No.	Cable	Manufacture	Model No.	Serial No.	Cal. Interval	Effective period
W2	Coaxial Cable	Pacific custom	RG-58 C/U	KSR00094	1Y	Jan. 19, 23
W4	Coaxial Cable	Daiyu Densen	3D-2V	KSR00101	1Y	Jan. 19, 23
W3	Coaxial Cable	Pacific custom	RG-58 C/U	AM90C04	1Y	Mar. 28, 23
W5	Coaxial Cable	Pacific custom	RG-58 C/U	AM90C03	1Y	Jan. 19, 23

**Measuring Equipment Configuration**

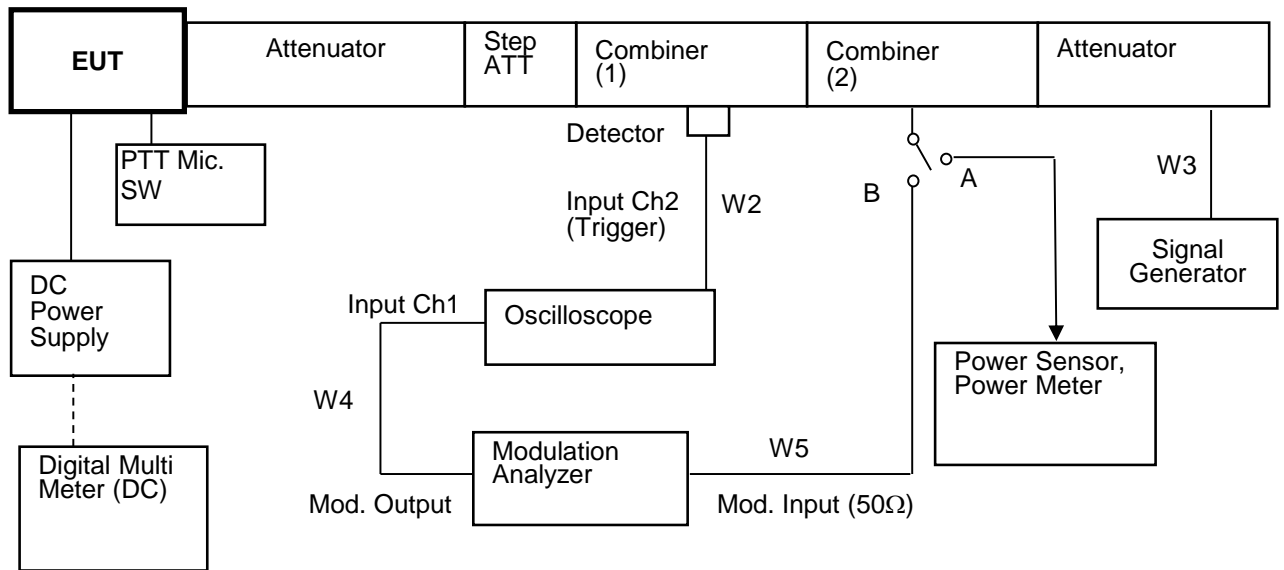

**Test Results**

Test date	Jul 01, 2022	
Location	Kashima No.12 Test Site	
temperature	25.2	[degree C]
Humidity Variation	48	[%]
Atmospheric Pressure	101.1	[kPa]
Test Engineer	Koichi Wagatsuma	

Test was carried out for all the frequency band of section 10.1  
 State the worst case (below).

State : High Power / Authorized Bandwidth 20 kHz / 16K0F3E / 406.15 MHz (FCC/RSS)/ PTT:OFF -ON

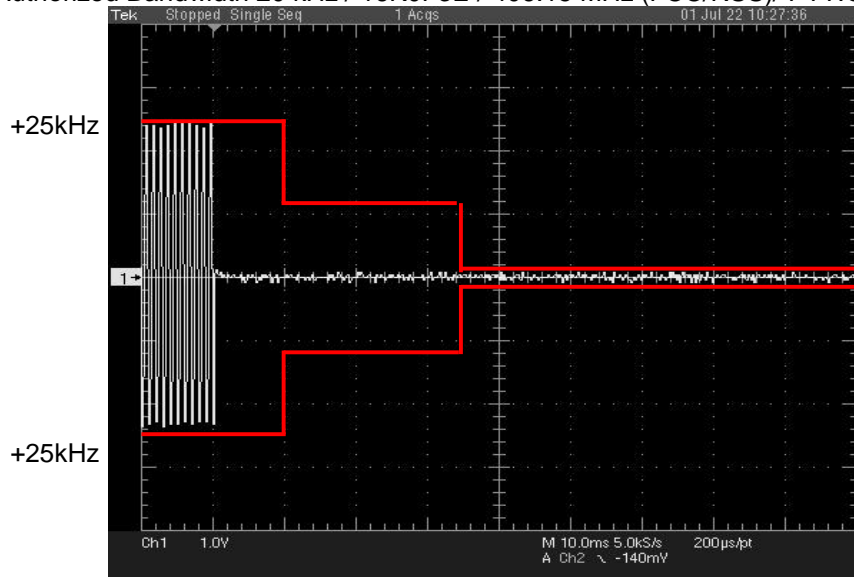

State : High Power / Authorized Bandwidth 20 kHz / 16K0F3E / 406.15 MHz (FCC/RSS)/ PTT:ON -OFF

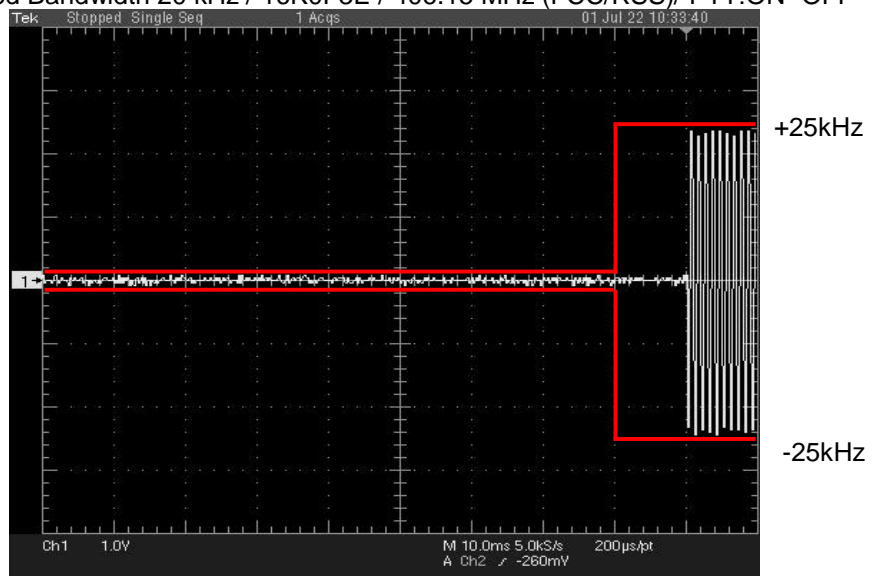



State : High Power / Authorized Bandwidth 11.25 kHz / 11K0F3E / 469.95 MHz (FCC/RSS)/ PTT:OFF-ON

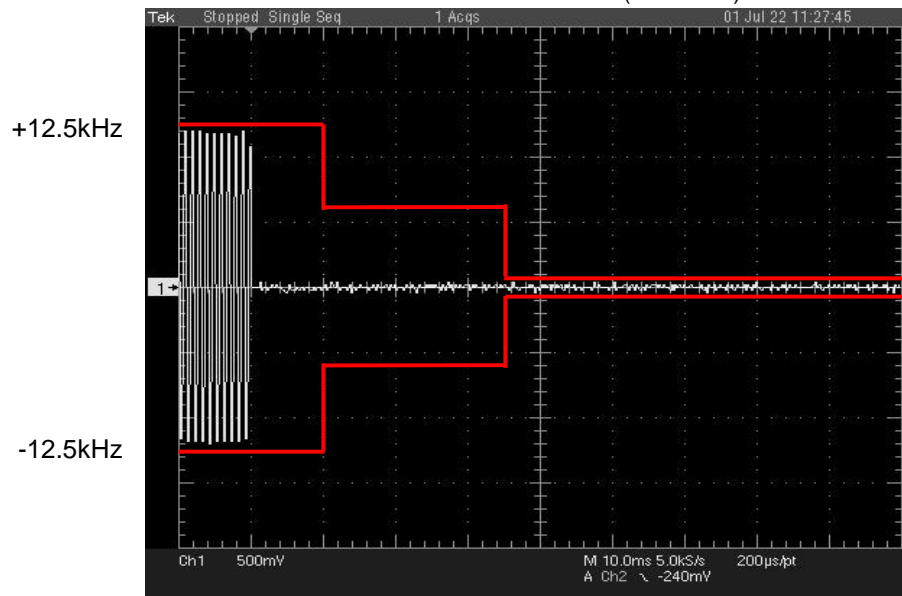

State : High Power / Authorized Bandwidth 11.25 kHz / 11K0F3E / 469.95 MHz (FCC/RSS)/ PTT:ON-OFF

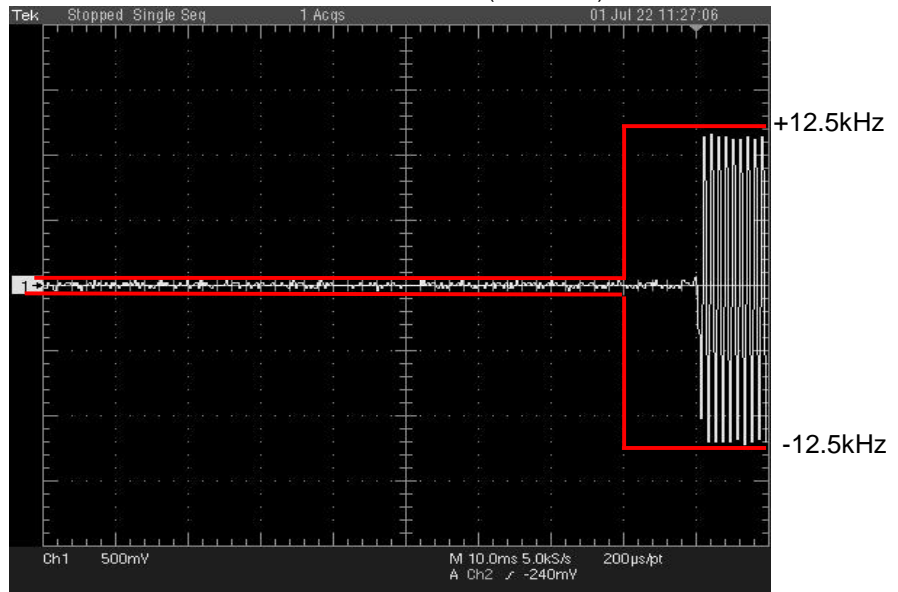

State : High Power / Authorized Bandwidth 11.25 kHz / 7K60FXD/FXE/F1E/F1D/F1W/FXW / 406.15 MHz (FCC/RSS)/ PTT:OFF -ON

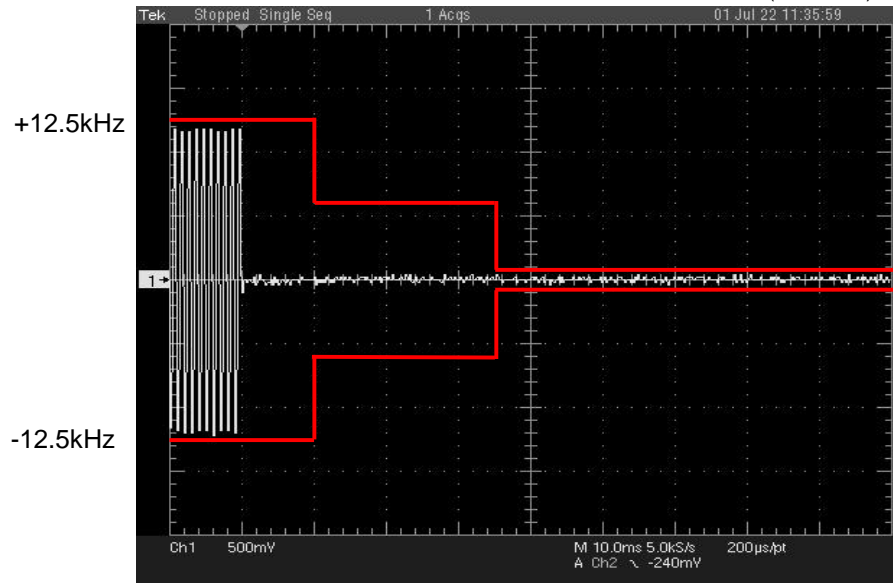

State : High Power / Authorized Bandwidth 11.25 kHz / 7K60FXD/FXE/F1E/F1D/F1W/FXW / 406.15 MHz (FCC/RSS)/ PTT:ON -OFF

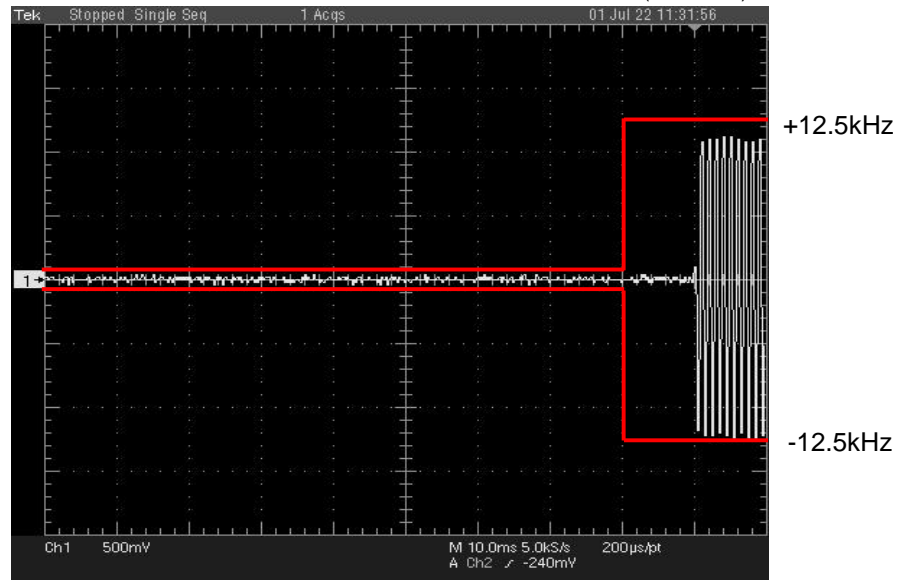

State : High Power / Authorized Bandwidth 11.25 kHz / 8K30F1E/F1D/F7W / 469.95 MHz (FCC/RSS)/ PTT:OFF -ON

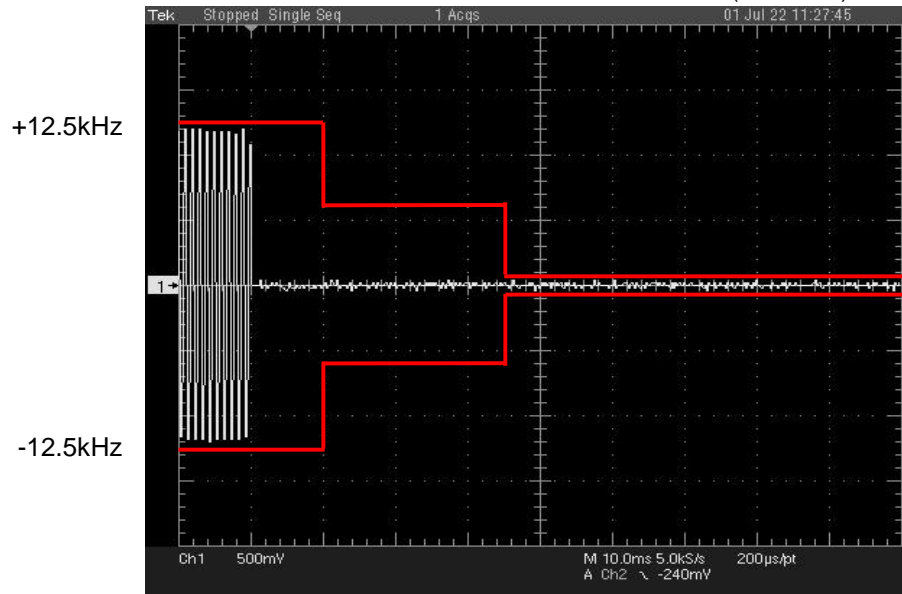

State : High Power / Authorized Bandwidth 11.25 kHz / 8K30F1E/F1D/F7W / 469.95 MHz (FCC/RSS)/ PTT:ON-OFF

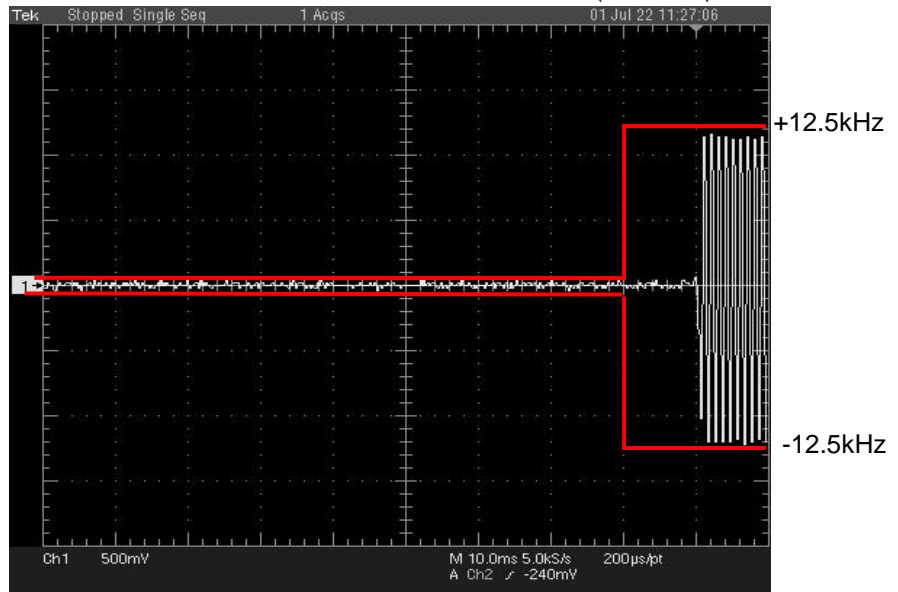

State : High Power / Authorized Bandwidth 6 kHz / 4K00F1E / F1D / F7W / 429.95 MHz (FCC/RSS)/ PTT:OFF -ON

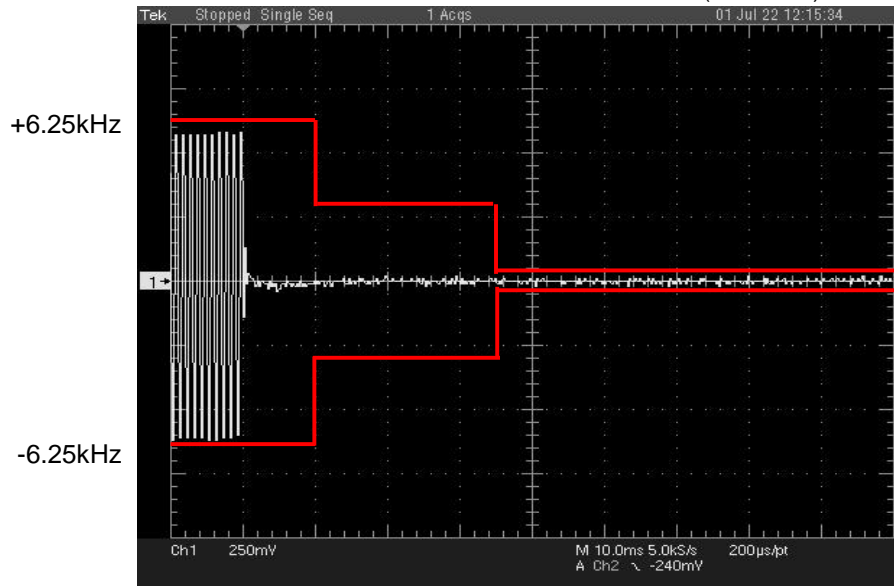

State : High Power / Authorized Bandwidth 6 kHz / 4K00F1E / F1D / F7W / 429.95 MHz (FCC/RSS)/ PTT:ON-OFF

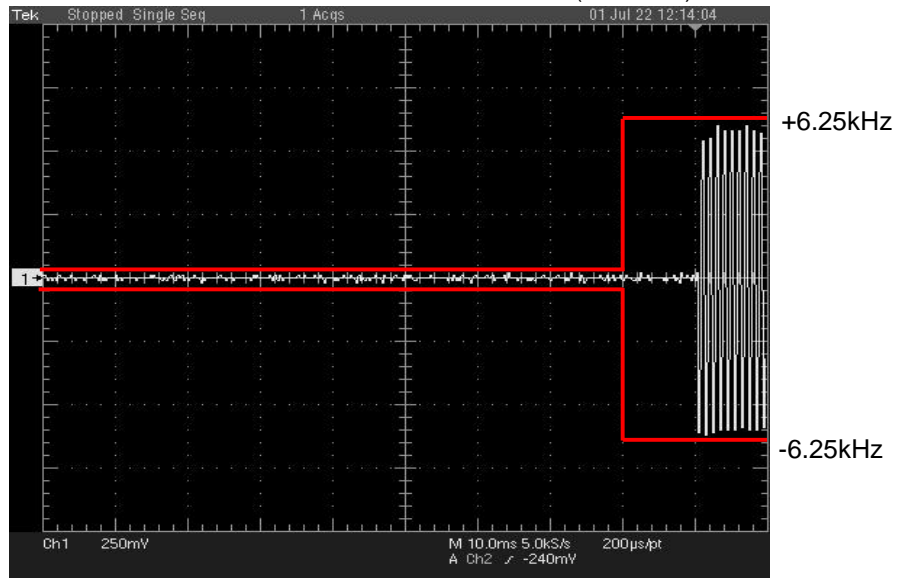

State : High Power / Authorized Bandwidth 6 kHz / 4K00F2D / 429.95 MHz (FCC/RSS)/ PTT:OFF -ON

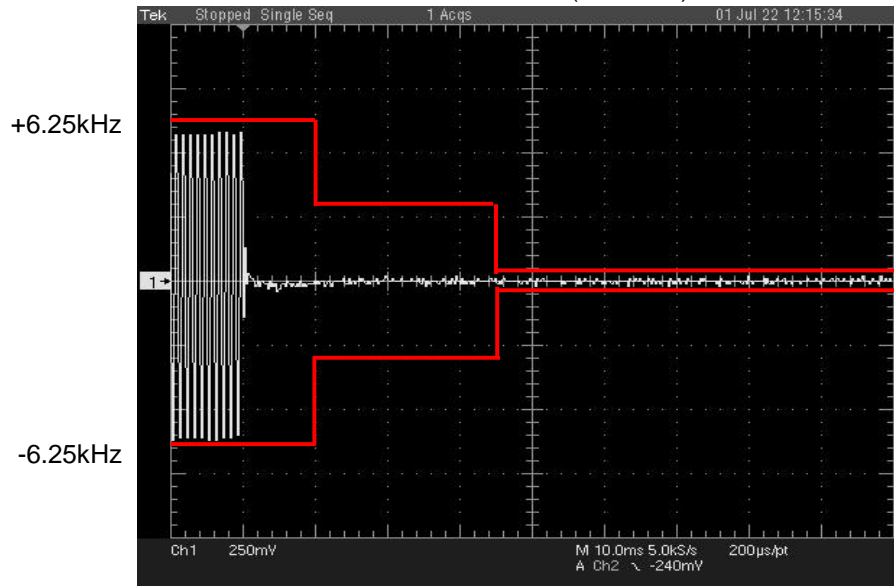

State : High Power / Authorized Bandwidth 6 kHz / 4K00F2D / 429.95 MHz (FCC/RSS)/ PTT:ON-OFF

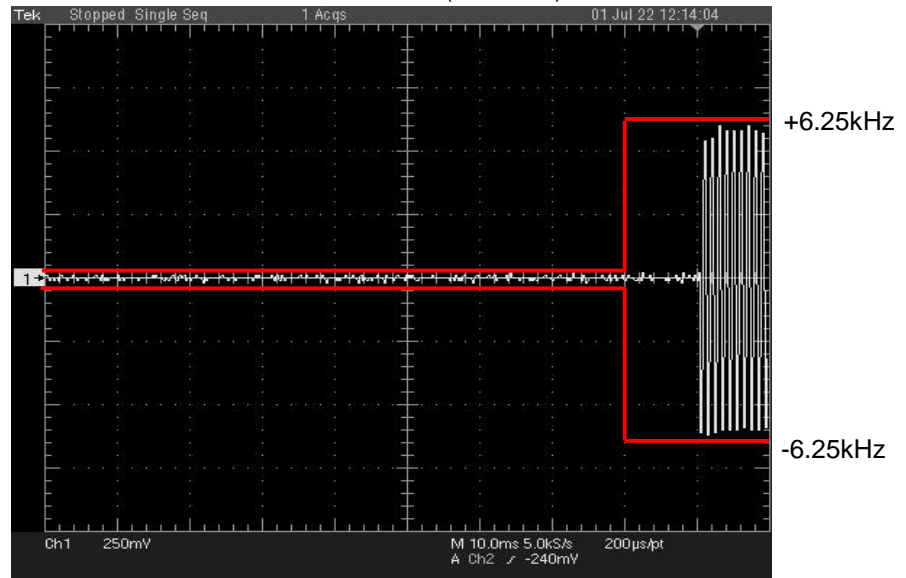

## 10.6 Audio Frequency Response / Audio Low Pass Filter (Voice Input)

REGULATIONS	: FCC Part 2 Section 1047 (a)
TEST METHOD/GUIDE	: ANSI/TIA-603-E Section 2.2.6.2.2, 3.2.6.2 ANSI C63.26 Section 5.3.3

### Test Procedure

- 1 The EUT and test equipment were set up as shown on the following page.
- 2 Adjust the Modulation Analyzer for the following setting:
  - a) High-pass filter : 50 Hz
  - b) Low-pass filter : 15 kHz
  - c) Detector : positive peak
  - d) Function : FM
- 3 The audio signal input was adjusted to obtain 20 % modulation at 1 kHz, and this point was taken as the 0 dB reference level.
- 4 With input levels held constant and below limiting at all frequencies, the audio signal generator was varied from 100 Hz to 5 kHz.
- 5 The response in dB relative to 1 kHz was then measured, using the Modulation Analyzer.

### Measuring Equipments

No.	Equipment	Manufacture	Model No.	Serial No.	Cal. Interval	Effective period
1	Attenuator (20dB)	Aeroflex/Wenshel	66-20-34	BY4357	1Y	Sep. 08, 22
2	Attenuator (30dB)	Weinschel	WA-29-30-34	8923	1Y	Sep. 08, 22
3	Modulation Analyzer	Hewlett Packard	8901B	3403A04852	1Y	Dec. 14, 22
4	Audio Generator	Anritsu	MG443B	M70150	1Y	Jun. 12, 23
5	Audio Analyzer	Hewlett Packard	8903B	2948A07326	1Y	Oct. 27, 22
6	DC Power Supply	Daiichi denpa kogyo	GZV4000	90290931	None	None
7	Digital Multi Meter	FLUKE	8846A	9642018	1Y	Jun. 30, 23

### Measuring Cables

No.	Cable	Manufacture	Model No.	Serial No.	Cal. Interval	Effective period
W2	Balance Cable	Nicoon	3D-2V	KSR00092	1Y	Sep. 09, 22
W4	Coaxial Cable	Daiyu Densen	3D-2V	KSR00101	1Y	Jan. 19, 23
W3	Coaxial Cable	Pacific custom	RG-58 C/U	AM90C03	1Y	Jan. 19, 23

### Measuring Equipment Configuration

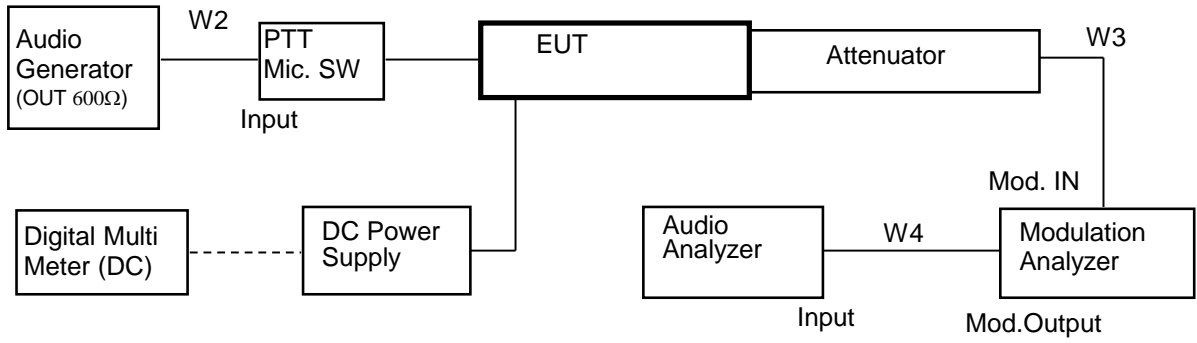

**Test Results**

Test date	Jul 01, 2022	
Location	Kashima No.12 Test Site	
temperature	22	[degree C]
Humidity Variation	45	[%]
Atmospheric Pressure	101.4	[kPa]
Test Engineer	Koichi Wagatsuma	

Test was carried out for all the frequency band of section 10.1  
 State the worst case (below).

State : High Power / Authorized Bandwidth 20 kHz / 16K0F3E / 429.95 MHz(FCC / RSS)

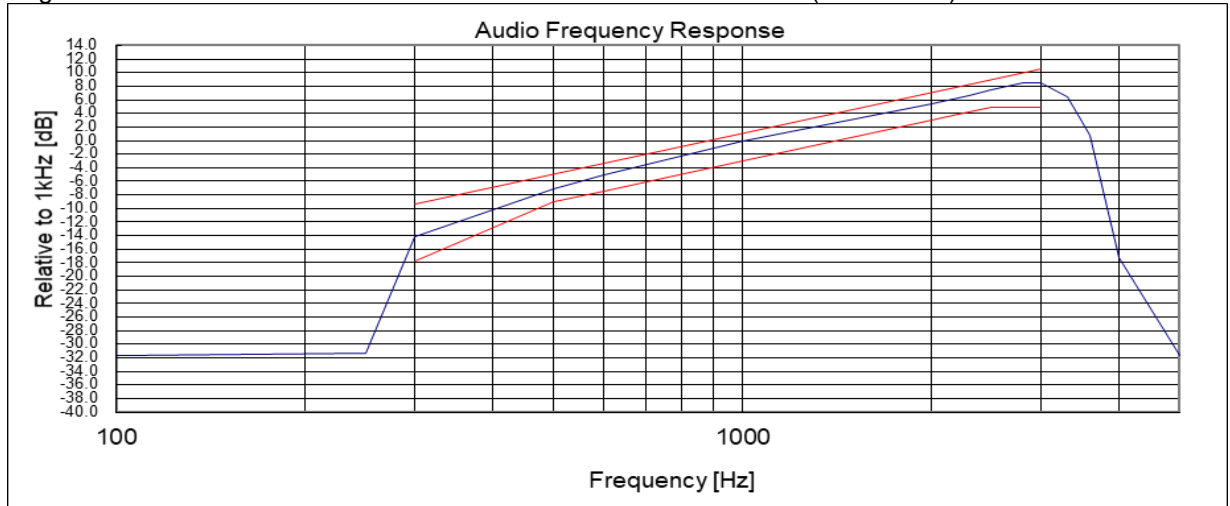

**Note:**

Audio Filter of the above result is substituted with the same structure as Audio Frequency Response.  
 On the transmission condition below 3kHz,  
 Transceiver shows pre-emphasis condition of transmission function.  
 On the transmission condition above 3kHz, Transceiver shows Audio Low Pass Filter.



State : High Power / Authorized Bandwidth 11.25 kHz / 11K0F3E / 469.95 MHz(FCC / RSS)

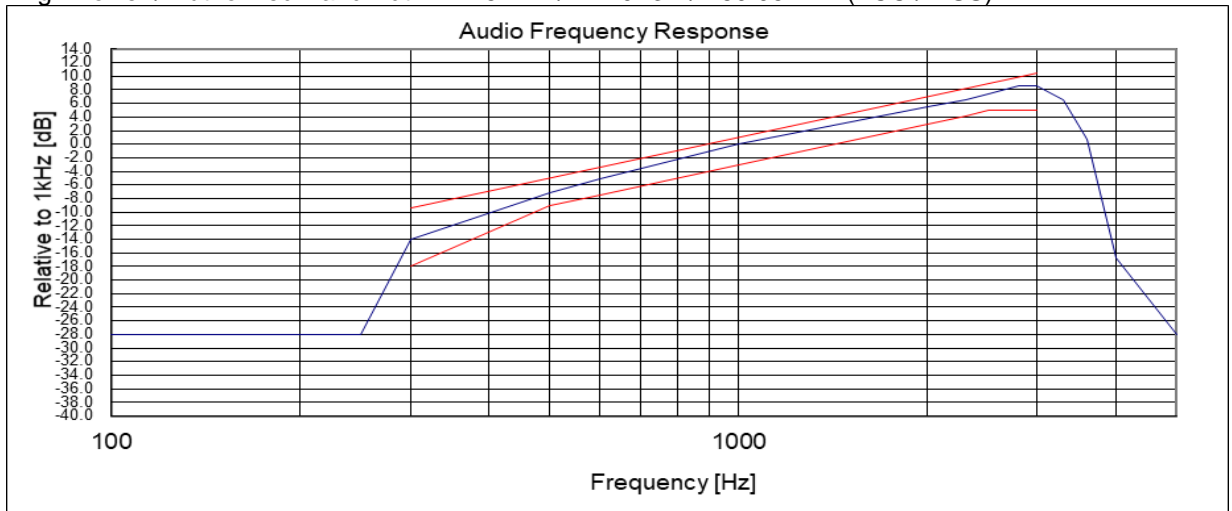

Note:

Audio Filter of the above result is substituted with the same structure as Audio Frequency Response.

On the transmission condition below 3kHz,

Transceiver shows pre-emphasis condition of transmission function.

On the transmission condition above 3kHz, Transceiver shows Audio Low Pass Filter.

## 10.7 Modulation Limiting

REGULATIONS	: FCC Part 2 Section 1047 (b)
TEST METHOD/GUIDE	: ANSI/TIA-603-E Section 2.2.3.2, 1.3.4.4 ANSI C63.26 Section 5.3.2

### Test Procedure

- 1 The EUT and test equipment were set up as shown on the following page.
- 2 Adjust the Modulation Analyzer for the following setting:
  - a) High-pass filter : off
  - b) Low-pass filter : 15 kHz
  - c) Detector : positive peak
  - d) Function : FM
- 3 Apply a 1kHz modulation signal to the transmitter from the audio generator, and adjust the level to obtain 60% of full rated system deviation.
- 4 Measure the modulation frequency that was showed on the Modulation Analyzer when the output levels of the Audio Generator were changed from -20 dB to +20 dB by 5 dB.
- 5 Set the output frequencies of the Audio Generator 300 Hz, 1kHz, 2.5 kHz and 3 kHz, and repeat test procedure 4.
- 6 Set the Detector of the Modulation Analyzer Negative Peak.
- 7 Repeat test procedure 4 and 5.

### Measuring Equipments

No.	Equipment	Manufacture	Model No.	Serial No.	Cal. Interval	Effective period
1	Attenuator (20dB)	Aeroflex/Wenshel	66-20-34	BY4357	1Y	Sep. 08, 22
2	Attenuator (30dB)	Weinschel	WA-29-30-34	8923	1Y	Sep. 08, 22
3	Modulation Analyzer	Hewlett Packard	8901B	3403A04852	1Y	Dec. 14, 22
4	Audio Generator	Anritsu	MG443B	M70150	1Y	Jun. 12, 23
5	DC Power Supply	Daiichi denpa kogyo	GZV4000	90290931	None	None
4	Digital Multi Meter	FLUKE	8846A	9642018	1Y	Jun. 30, 23

### Measuring Cables

No.	Cable	Manufacture	Model No.	Serial No.	Cal. Interval	Effective period
W2	Balance Cable	Nicoon	3D-2V	KSR00092	1Y	Sep. 09, 22
W3	Coaxial Cable	Pacific custom	RG-58 C/U	AM90C03	1Y	Jan. 19, 23

### Measuring Equipment Configuration

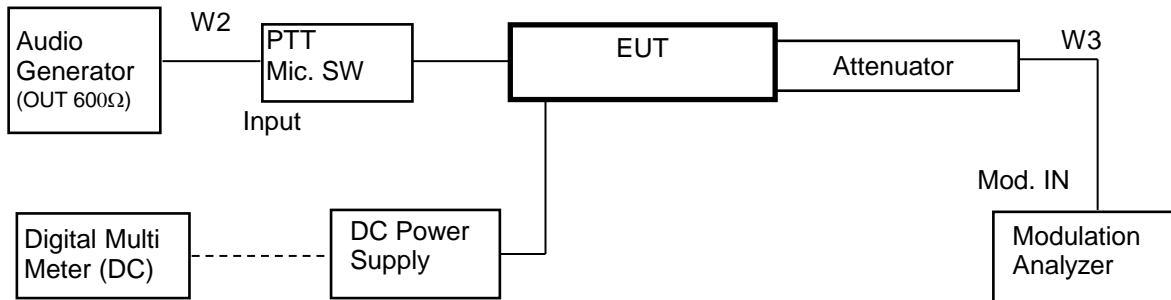

**Test Results**

Test date	Jul. 01, 2022	
Location	Kashima No.12 Test Site	
temperature	22	[degree C]
Humidity Variation	45	[%]
Atmospheric Pressure	101.4	[kPa]
Test Engineer	Koichi Wagatsuma	

Test was carried out for all the frequency band of section 10.1  
 State the worst case (below).

State : High Power / Authorized Bandwidth 20 kHz / 16K0F3E / 429.95 MHz(FCC / RSS)

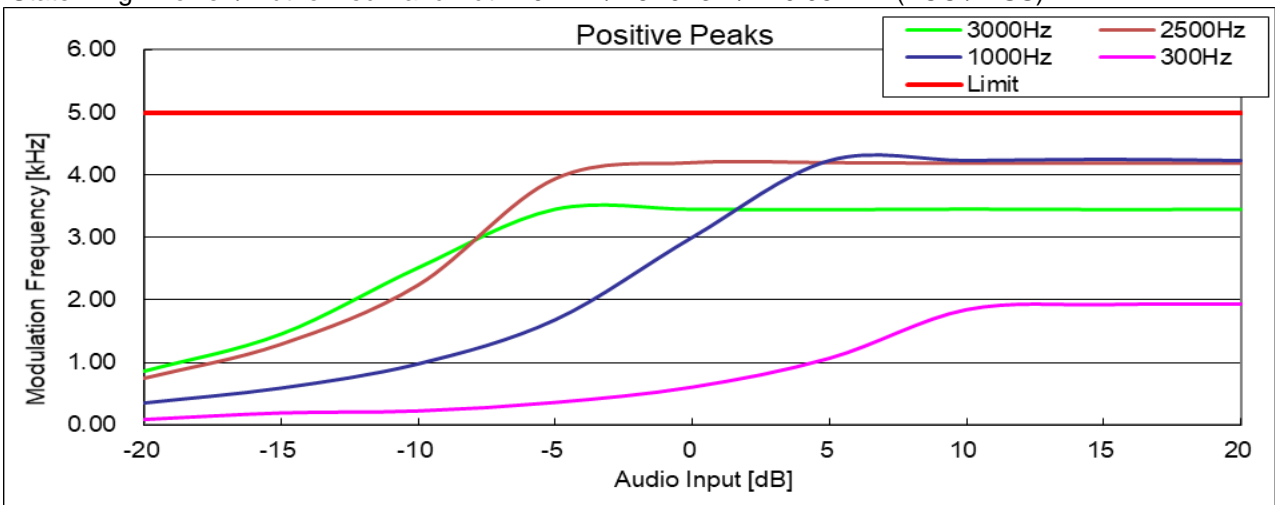

State : High Power / Authorized Bandwidth 20 kHz / 16K0F3E / 429.95 MHz(FCC / RSS)

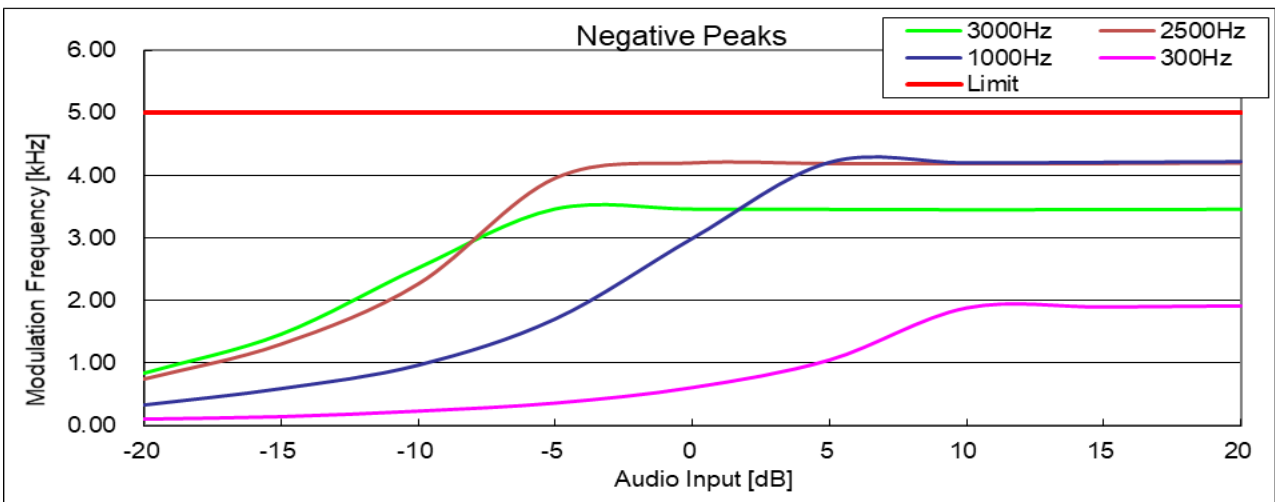

State : High Power / Authorized Bandwidth 11.25 kHz / 11K0F3E / 406.15 MHz(FCC / RSS)

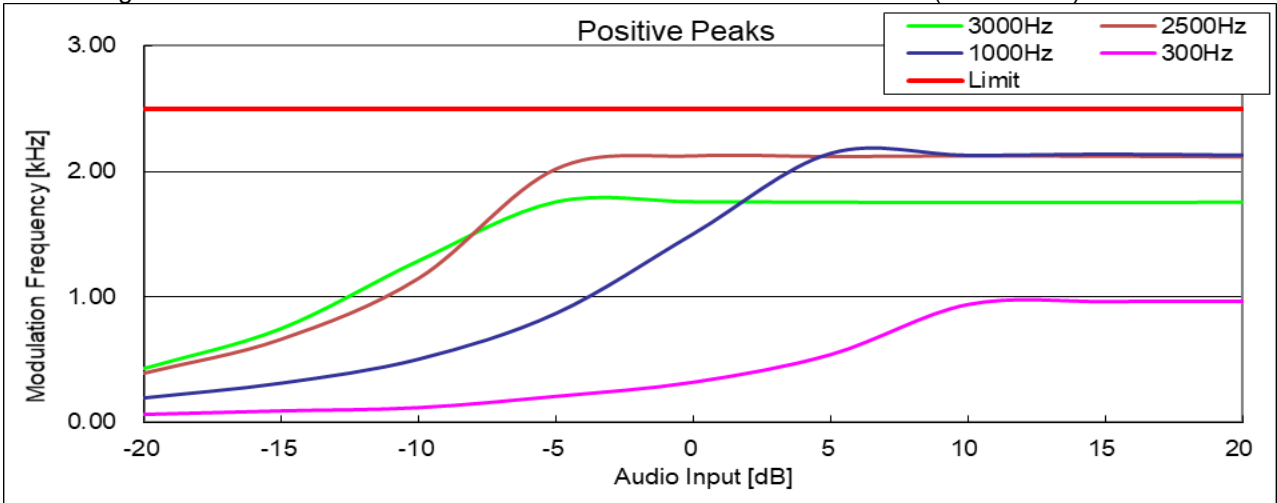

State : High Power / Authorized Bandwidth 11.25 kHz / 11K0F3E / 406.15 MHz(FCC / RSS)

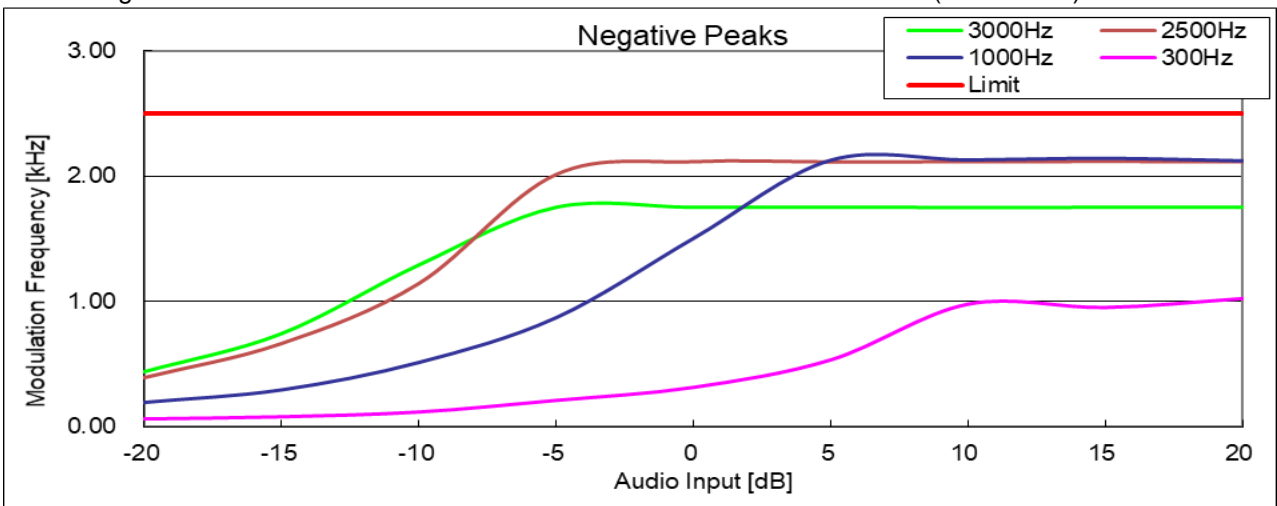

### 10.8 Frequency Stability (Temperature Variation)

REGULATIONS	: FCC Part 2 Section 1055 (a) (1), Part 22 Section 355 , Part 74Section 464 , Part 90 Section 213(a)
TEST METHOD/GUIDE	: ANSI/TIA-603-E Section 2.2.2.2 ANSI C63.26 Section 5.6

#### Test Procedure

- 1 The EUT and test equipment were set up as shown on the following page.
- 2 Set the temperature -30 degrees C.
- 3 Leave the EUT for 1 hour after it became the temperature that was set up.
- 4 Make the EUT the transmitting state.  
measure the output frequency.
- 5 Make the EUT the receiving state.
- 6 Set the temperature 50 degrees C by 10 degrees C.  
And repeat test procedure 4 to 6.

#### Measuring Equipments

No.	Equipment	Manufacture	Model No.	Serial No.	Cal. Interval	Effective period
1	Attenuator (20dB)	Aeroflex/Wenshel	66-20-34	BY4357	1Y	Sep. 08, 22
2	Attenuator (30dB)	Weinschel	WA-29-30-34	8923	1Y	Sep. 08, 22
3	Modulation Analyzer	Hewlett Packard	8901B	3403A04852	1Y	Dec. 14, 22
4	DC Power Supply	Takasago	GP035-20R	1014199060	None	None
5	Digital Multi Meter	FLUKE	8846A	9642018	1Y	Jun. 30, 23
6	Temperature Chamber	Tabai	PL-3F	5103661	None	None
7	Temperature Meter	T&D	TR-71nw	52160B67	1Y	Dec. 02, 22
8	GPS Receiver	Hewlett Packard	HP Z3801A	3542A02414	1Y	Feb. 28, 23

#### Measuring Cables

No.	Cable	Manufacture	Model No.	Serial No.	Cal. Interval	Effective period
W2	Coaxial Cable	Pacific custom	RG-58 C/U	AM90C04	1Y	Mar. 28, 23
W1	Coaxial Cable	Pacific custom	RG-58 C/U	AM90C03	1Y	Jan. 19, 23

### Measuring Equipment Configuration

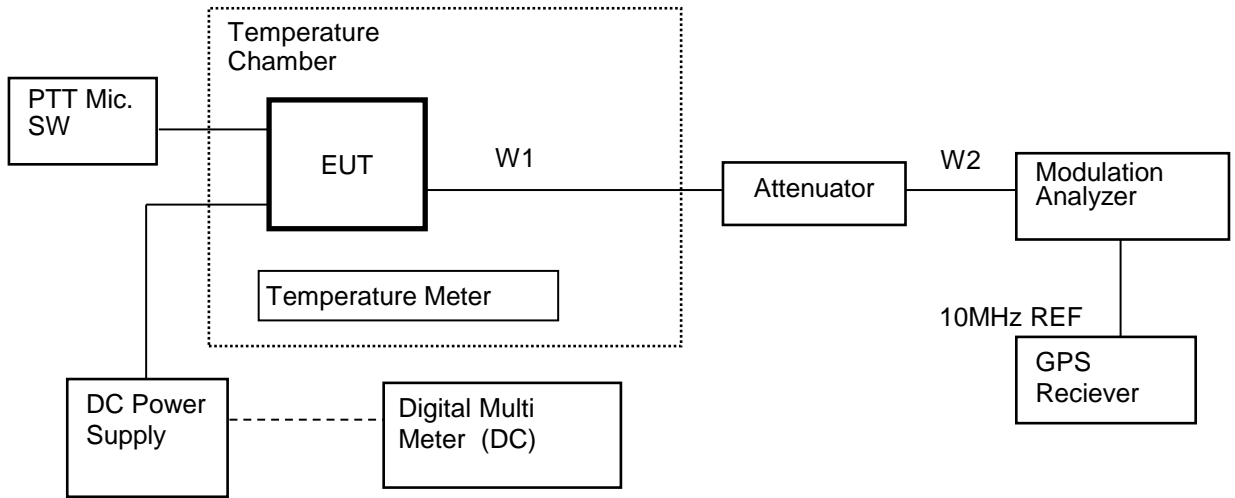

**Test Results**

Test date	Jul. 05, 2022
Location	Kashima No.12 Test Site
Test Engineer	Koichi Wagatsuma

Test was carried out for all the frequency band of section 10.1

State the worst case (below).

State : High Power / Authorized Bandwidth 20 kHz / 406.15 MHz (FCC / RSS)

Reference Frequency: 406.149990 MHz

No.	Temperature (Degree C)	Frequency (MHz)	Stability (ppm)	Limit (+/- ppm)	Margin (ppm)
1	-30	406.149950	-0.10	0.5	0.40
2	-20	406.150080	0.22	0.5	0.28
3	-10	406.150140	0.37	0.5	0.13
4	0	406.150130	0.34	0.5	0.16
5	10	406.150090	0.25	0.5	0.25
6	20	406.149990	0.00	0.5	0.50
7	30	406.149950	-0.10	0.5	0.40
8	40	406.149920	-0.17	0.5	0.33
9	50	406.149890	-0.25	0.5	0.25

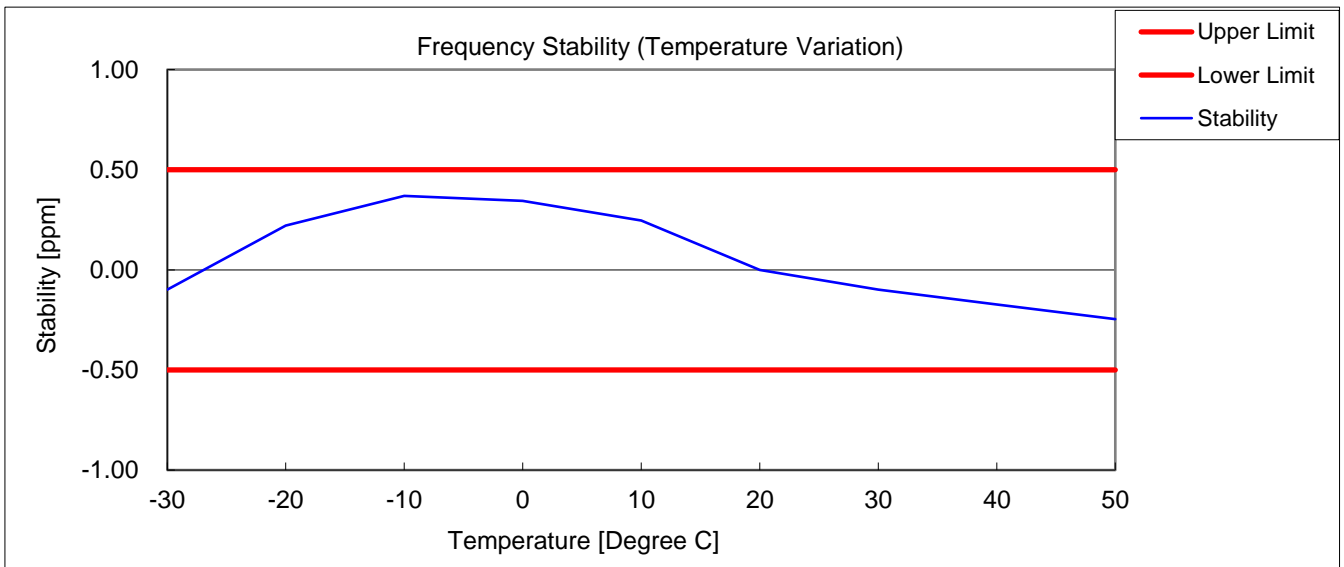



### 10.9 Frequency Stability (Voltage Variation)

REGULATIONS	: FCC Part 2 Section 1055 (a) (1), Part 22 Section 355 , Part 74Section 464 , Part 90 Section 213(a)
TEST METHOD/GUIDE	: ANSI/TIA-603-E Section 2.2.2.2 ANSI C63.26 Section 5.6

#### Test Procedure

- 1 The EUT and test equipment were set up as shown on the following page.
- 2 The power supply voltage to the EUT was varied from 85 % to 115 % of the nominal value measured at the input to the EUT.

#### Measuring Equipments

No.	Equipment	Manufacture	Model No.	Serial No.	Cal. Interval	Effective period
1	Attenuator (20dB)	Aeroflex/Wenshel	66-20-34	BY4357	1Y	Sep. 08, 22
2	Attenuator (30dB)	Weinschel	WA-29-30-34	8923	1Y	Sep. 08, 22
3	Modulation Analyzer	Hewlett Packard	8901B	3403A04852	1Y	Dec. 14, 22
4	DC Power Supply	Takasago	GP035-20R	1014199060	None	None
5	Digital Multi Meter	FLUKE	8846A	9642018	1Y	Jun. 30, 23
6	Temperature Chamber	Tabai	PL-3F	5103661	None	None
7	Temperature Meter	T&D	TR-71nw	52160B67	1Y	Dec. 02, 22

#### Measuring Cables

No.	Cable	Manufacture	Model No.	Serial No.	Cal. Interval	Effective period
W2	Coaxial Cable	Pacific custom	RG-58 C/U	AM90C04	1Y	Mar. 28, 23
W1	Coaxial Cable	Pacific custom	RG-58 C/U	AM90C03	1Y	Jan. 19, 23

#### Measuring Equipment Configuration

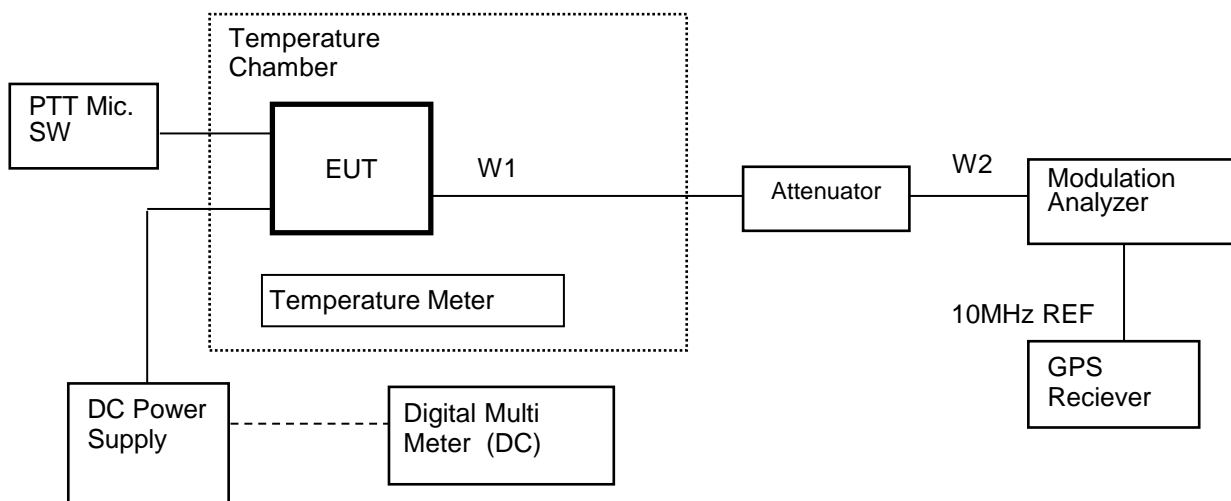

**Test Results**

Test date	Jul 05, 2022
Location	Kashima No.12 Test Site
Test Engineer	Koichi Wagatsuma

Test was carried out for all the frequency band of section 10.1

State the worst case (below).

State : High Power / Authorized Bandwidth 20 kHz / 406.15 MHz (FCC / RSS)

Reference Frequency: 406.149990 MHz

No.	Temperature (Degree C)	Diviation (%)	Voltage (V)	Frequency (MHz)	Stability (ppm)	Limit +/- (ppm)	Margin (ppm)
1	20+/-5	85	11.56	406.150000	0.02	0.5	0.48
2	20+/-5	100	13.60	406.149990	0.00	0.5	0.50
3	20+/-5	115	15.64	406.149990	0.00	0.5	0.50

**10.10 Necessary Bandwidth and Emission Bandwidth**

REGULATIONS	: FCC Part 2 Section 202 (g) & Federal Register/ Vol.68, No236
-------------	--

**Calculation Results**

This information was provided by the Applicant or customer.

State : 16K0F3E (Authorized Bandwidth 20 kHz)

Item	Mark		
Maximum Modulation	(M)	3	kHz
Maximum Deviation	(D)	5	kHz
Constant Factor	(K)	1	
Necessary Bandwidth	(Bn)	16	kHz

$$B_n = (2 \times M) + (2 \times D \times K)$$

- 1.types of modulation of the main carrier : F= Frequency modulation
- 2.nature of signal(s) modulating the main carrier: 3= A single channel containing analog information
- 3.type of information to be transmitted: E= Telephony (including sound broadcasting)

State : 11K0F3E (Authorized Bandwidth 11.25 kHz)

Item	Mark		
Maximum Modulation	(M)	3	kHz
Maximum Deviation	(D)	2.5	kHz
Constant Factor	(K)	1	
Necessary Bandwidth	(Bn)	11	kHz

$$B_n = (2 \times M) + (2 \times D \times K)$$

- 1.types of modulation of the main carrier : F= Frequency modulation
- 2.nature of signal(s) modulating the main carrier: 3= A single channel containing analog information
- 3.type of information to be transmitted: E= Telephony (including sound broadcasting)

State : 7K60FXE / 7K60FXD / 7K60F1E / 7K60F1D / 7K60F1W / 7K60FXW (9600bps, Authorized Bandwidth 11.25 kHz)

Item	Mark		
Digital information rate	(R)	9600	bps
Peak frequency deviation	(D)	3.024	kHz
Signaling states	(S)	4	
Numerical factor	(K)	0.463	
Necessary Bandwidth	(Bn)	7.6	kHz

$$B_n = (R / \log_2 S) + 2 \times D \times K$$

- 1.types of modulation of the main carrier : F= Frequency modulation
- 2.nature of signal(s) modulating the main carrier: X= Cases not otherwise covered
- 3.type of information to be transmitted: 1= A single channel containing quantized or digital
- E= Telephony (including sound broadcasting)
- D= Data transmission, telemetry, telecommand
- W= Combination of the above

State : 8K30F1E / 8K30F1D / 8K30F7W (4Level FSK / 9600bps, Authorized Bandwidth 11.25 kHz)

Item	Mark		
Digital information rate	(R)	9600	bps
Peak frequency deviation	(D)	3.391	kHz
Signaling states	(S)	4	
Numerical factor	(K)	0.516	
Necessary Bandwidth	(Bn)	8.3	kHz

$$B_n = (R/\log_2 S) + 2x D x K$$

- 1.types of modulation of the main carrier : F= Frequency modulation  
 2.nature of signal(s) modulating the main carrier: 1= A single channel containing quantized or digital  
 7= Two or more channels containing quantized or digital  
 3.type of information to be transmitted: E= Telephony (including sound broadcasting)  
 D= Data transmission, telemetry, telecommand  
 W= Combination of the above

State : 4K00F1E / 4K00F1D / 4K00F7W (4Level FSK / 4800bps, Authorized Bandwidth 6 kHz)

Item	Mark		
Digital information rate	(R)	4800	bps
Peak frequency deviation	(D)	1.55	kHz
Signaling states	(S)	4	
Numerical factor	(K)	0.516	
Necessary Bandwidth	(Bn)	4	kHz

$$B_n = (R/\log_2 S) + 2x D x K$$

- 1.types of modulation of the main carrier : F= Frequency modulation  
 2.nature of signal(s) modulating the main carrier: 1= A single channel containing quantized or digital  
 7= Two or more channels containing quantized or digital  
 3.type of information to be transmitted: E= Telephony (including sound broadcasting)  
 D= Data transmission, telemetry, telecommand  
 W= Combination of the above

State : 4K00F2D (CWID, Authorized Bandwidth 6 kHz)

Item	Mark		
Maximum Modulation	(M)	0.8	kHz
Maximum Deviation	(D)	1.2	kHz
Numerical factor	(K)	1	
Necessary Bandwidth	(Bn)	4	kHz

$$B_n = (2xM) + (2x D x K)$$

- 1.types of modulation of the main carrier : F= Frequency modulation  
 2.nature of signal(s) modulating the main carrier: 2= A single channel containing quantized or digital  
 3.type of information to be transmitted: D= Data transmission, telemetry, telecommand

### 10.11 99% Occupied Bandwidth

REGULATIONS	: RSS-119 Section 5.5
TEST METHOD/GUIDE	: RSS-Gen Section 6.6

#### Test Procedure

- 1 The EUT and test equipment were set up as shown on the following page.
- 2 Adjust the test instrument for the following setting:
  - RBW : 1 % to 5 % of the Necessary bandwidth
  - VBW : at least 3 times the RBW
  - Detector : Peak
  - Sweep Time : Auto
  - Trace mode : Max Hold
- 3 Allow trace to fully stabilize.
- 4 Use "Occupied Bandwidth Measurement" function to measure the 99% Occupied Bandwidth.
- 5 Modulate the transmitter with a 2.5 kHz sine wave at an input Level of 16 dB greater than that necessary to produce 50 % of rated system deviation.(Only 16K0F3E, 14K0F3E, 11K0F3E)

#### Measuring Equipments

No.	Equipment	Manufacture	Model No.	Serial No.	Cal. Interval	Effective period
1	Attenuator (20dB)	Aeroflex/Wenshel	66-20-34	BY4357	1Y	Sep. 08, 22
2	Attenuator (30dB)	Weinschel	WA-29-30-34	8923	1Y	Sep. 08, 22
3	Modulation Analyzer	Hewlett Packard	8901B	3403A04852	1Y	Dec. 14, 22
4	Audio Generator	Anritsu	MG443B	M70150	1Y	Jun. 12, 23
5	Spectrum Analyzer	Agilent	N9030A	US51350220	1Y	Aug. 31, 22
6	DC Power Supply	Daiichi denpa kogyo	GZV4000	90290931	None	None
7	Digital Multi Meter	FLUKE	8846A	9642018	1Y	Jun. 30, 23
8	JIG	HP	ProBook 430 G3	PJPNYOKL0147	None	None
9	Balance Cable	Nicoon	3D-2V	KSR00092	1Y	Sep. 09, 22
10	Coaxial Cable	Pacific custom	RG-58 C/U	AM90C03	1Y	Jan. 19, 23
11	Coaxial Cable	Suhner	SUCOFLEX104	F0000019	1Y	Mar. 24, 23

### Measuring Equipment Configuration

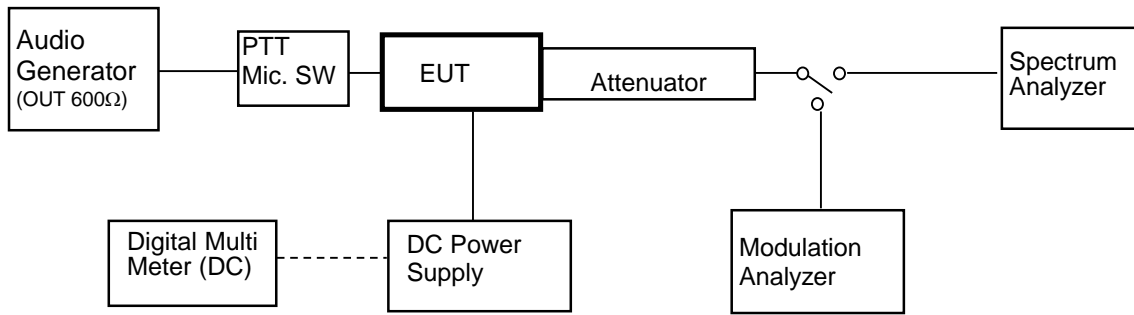

<DMR, and CW ID Modulation Case>

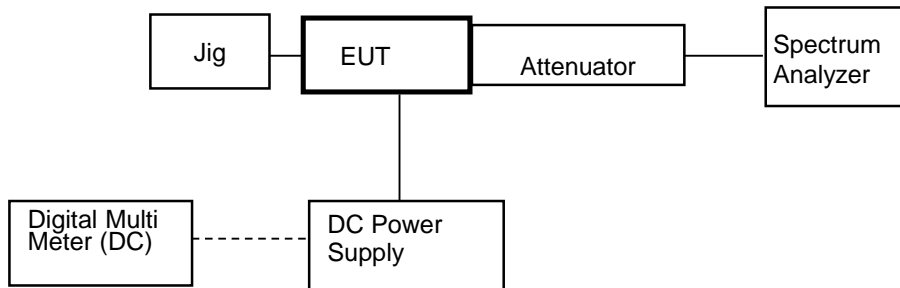

**Test Results**

Test date	Jul 01, 2022		
Location	Kashima No.12 Test Site		
temperature	25.5	[degree C]	
Humidity Variation	47.0	[%]	
Atmospheric Pressure	101.1	[kPa]	
Test Engineer	Koichi Wagatsuma		

Emission Designation	Frequency (MHz)	99% Occupied Bandwidth (kHz)	Authorized bandwidth (kHz)
16K0F3E	406.15	14.772	20
	429.95	14.756	
	469.95	14.753	
11K0F3E	406.15	9.921	11.25
	429.95	9.919	
	469.95	9.923	
7K60FXD/FXE/F1E/F1D/F1W/FXW	406.15	7.510	11.25
	429.95	7.520	
	469.95	7.545	
8K30F1E/F1D/F7W	406.15	7.792	11.25
	429.95	7.750	
	469.95	7.766	
4K00F1E / F1D / F7W	406.15	3.652	6
	429.95	3.623	
	469.95	3.650	
4K00F2D	406.15	4.028	6
	429.95	4.027	
	469.95	4.025	

Ferquency (MHz)	Emission Designation	
	16K0F3E	11K0F3E
406.15	<p>Center Freq 406.150000 MHz        Center Freq 406.150000 MHz        Trig Freq Run #ARef: 10 dB        AvgHold: 50dB        Radio Stat: None        Radio Device: BTS</p> <p>Center 406.2 MHz        #Res BW 300 Hz        VBW 3 kHz        Span 50 kHz        Sweep 512.8 ms</p> <p>Occupied Bandwidth <b>14.772 kHz</b> Total Power <b>-1.60 dBm</b>        Transmit Freq Error <b>53 Hz</b> OBW Power <b>99.00 %</b>        x dB Bandwidth <b>15.37 kHz</b> x dB <b>-20.00 dB</b></p>	<p>Center Freq 406.150000 MHz        Center Freq 406.150000 MHz        Trig Freq Run #ARef: 10 dB        AvgHold: 50dB        Radio Stat: None        Radio Device: BTS</p> <p>Center 406.2 MHz        #Res BW 110 Hz        VBW 1.1 kHz        Span 50 kHz        Sweep FFT</p> <p>Occupied Bandwidth <b>9.921 kHz</b> Total Power <b>-2.10 dBm</b>        Transmit Freq Error <b>18 Hz</b> OBW Power <b>99.00 %</b>        x dB Bandwidth <b>5.241 kHz</b> x dB <b>-20.00 dB</b></p>
429.95	<p>Center Freq 429.950000 MHz        Center Freq 429.950000 MHz        Trig Freq Run #ARef: 10 dB        AvgHold: 50dB        Radio Stat: None        Radio Device: BTS</p> <p>Center 430 MHz        #Res BW 300 Hz        VBW 3 kHz        Span 50 kHz        Sweep 512.8 ms</p> <p>Occupied Bandwidth <b>14.756 kHz</b> Total Power <b>-1.60 dBm</b>        Transmit Freq Error <b>54 Hz</b> OBW Power <b>99.00 %</b>        x dB Bandwidth <b>15.36 kHz</b> x dB <b>-20.00 dB</b></p>	<p>Center Freq 429.950000 MHz        Center Freq 429.950000 MHz        Trig Freq Run #ARef: 10 dB        AvgHold: 50dB        Radio Stat: None        Radio Device: BTS</p> <p>Center 430 MHz        #Res BW 110 Hz        VBW 1.1 kHz        Span 50 kHz        Sweep FFT</p> <p>Occupied Bandwidth <b>9.919 kHz</b> Total Power <b>-2.09 dBm</b>        Transmit Freq Error <b>20 Hz</b> OBW Power <b>99.00 %</b>        x dB Bandwidth <b>5.241 kHz</b> x dB <b>-20.00 dB</b></p>
469.95	<p>Center Freq 469.950000 MHz        Center Freq 469.950000 MHz        Trig Freq Run #ARef: 10 dB        AvgHold: 50dB        Radio Stat: None        Radio Device: BTS</p> <p>Center 470 MHz        #Res BW 300 Hz        VBW 3 kHz        Span 50 kHz        Sweep 512.8 ms</p> <p>Occupied Bandwidth <b>14.753 kHz</b> Total Power <b>-1.55 dBm</b>        Transmit Freq Error <b>53 Hz</b> OBW Power <b>99.00 %</b>        x dB Bandwidth <b>15.36 kHz</b> x dB <b>-20.00 dB</b></p>	<p>Center Freq 469.950000 MHz        Center Freq 469.950000 MHz        Trig Freq Run #ARef: 10 dB        AvgHold: 50dB        Radio Stat: None        Radio Device: BTS</p> <p>Center 470 MHz        #Res BW 110 Hz        VBW 1.1 kHz        Span 50 kHz        Sweep FFT</p> <p>Occupied Bandwidth <b>9.923 kHz</b> Total Power <b>-1.99 dBm</b>        Transmit Freq Error <b>26 Hz</b> OBW Power <b>99.00 %</b>        x dB Bandwidth <b>5.240 kHz</b> x dB <b>-20.00 dB</b></p>



Ferquency (MHz)	Emission Designation	
	7K60FXD/FXE/F1E/F1D/F1W/FXW	8K30F1E/F1D/F7W
406.15	<p>Agilent Spectrum Analyzer - Occupied BW        Center Freq 406.150000 MHz        Occupied Bandwidth: 7.510 kHz        Total Power: 4.77 dBm        Transmit Freq Error: 24 Hz        x dB Bandwidth: 8.391 kHz</p>	<p>Agilent Spectrum Analyzer - Occupied BW        Center Freq 406.150000 MHz        Occupied Bandwidth: 7.792 kHz        Total Power: 5.39 dBm        Transmit Freq Error: 26 Hz        x dB Bandwidth: 8.475 kHz</p>
429.95	<p>Agilent Spectrum Analyzer - Occupied BW        Center Freq 429.950000 MHz        Occupied Bandwidth: 7.520 kHz        Total Power: 4.96 dBm        Transmit Freq Error: 32 Hz        x dB Bandwidth: 8.446 kHz</p>	<p>Agilent Spectrum Analyzer - Occupied BW        Center Freq 429.950000 MHz        Occupied Bandwidth: 7.750 kHz        Total Power: 5.36 dBm        Transmit Freq Error: 25 Hz        x dB Bandwidth: 8.529 kHz</p>
469.95	<p>Agilent Spectrum Analyzer - Occupied BW        Center Freq 469.950000 MHz        Occupied Bandwidth: 7.545 kHz        Total Power: 4.88 dBm        Transmit Freq Error: 37 Hz        x dB Bandwidth: 8.360 kHz</p>	<p>Agilent Spectrum Analyzer - Occupied BW        Center Freq 469.950000 MHz        Occupied Bandwidth: 7.766 kHz        Total Power: 5.28 dBm        Transmit Freq Error: 18 Hz        x dB Bandwidth: 8.778 kHz</p>

Ferquency (MHz)	Emission Designation	
	4K00F1E / F1D / F7W	4K00F2D
406.15	<p>Agilent Spectrum Analyzer - Occupied BW        Center Freq 406.150000 MHz        Occupied Bandwidth: 3.652 kHz        Total Power: 5.15 dBm        Transmit Freq Error: 29 Hz        x dB Bandwidth: 4.128 kHz</p>	<p>Agilent Spectrum Analyzer - Occupied BW        Center Freq 406.150000 MHz        Occupied Bandwidth: 4.028 kHz        Total Power: -2.43 dBm        Transmit Freq Error: 9 Hz        x dB Bandwidth: 4.108 kHz</p>
429.95	<p>Agilent Spectrum Analyzer - Occupied BW        Center Freq 429.950000 MHz        Occupied Bandwidth: 3.623 kHz        Total Power: 5.43 dBm        Transmit Freq Error: 7 Hz        x dB Bandwidth: 4.167 kHz</p>	<p>Agilent Spectrum Analyzer - Occupied BW        Center Freq 429.950000 MHz        Occupied Bandwidth: 4.027 kHz        Total Power: -2.46 dBm        Transmit Freq Error: 9 Hz        x dB Bandwidth: 4.108 kHz</p>
469.95	<p>Agilent Spectrum Analyzer - Occupied BW        Center Freq 469.950000 MHz        Occupied Bandwidth: 3.650 kHz        Total Power: 5.25 dBm        Transmit Freq Error: 5 Hz        x dB Bandwidth: 4.314 kHz</p>	<p>Agilent Spectrum Analyzer - Occupied BW        Center Freq 469.950000 MHz        Occupied Bandwidth: 4.025 kHz        Total Power: -2.16 dBm        Transmit Freq Error: 13 Hz        x dB Bandwidth: 4.108 kHz</p>