



TEST REPORT

REGULATION : FCC Part 22, 74, 90

Applicant	Testing Laboratory
JVCKENWOOD Corporation 1-16-2, Hakusan, Midori-ku, Yokohama-shi Kanagawa, 226-8525 Japan Tel.: +81 45 939 6254 Fax.: +81 45 939 6261	Intertek Japan K.K. Kashima Laboratory URL: http://www.japan.intertek-etlsemko.com (No.12 Test site) 298-6 Sada, Kashima, Ibaraki 314-0027 Japan Tel. +81 299 82 8464

Equipment type	UHF REPEATER
Trademark	KENWOOD
FCC Model(s)	NXR-1800-E
Serial No.	015
FCC ID	K44513200
Test Result	Complied
Report Number	23020248JKA-001
Original Issue Date	June 09, 2023

This report is for the exclusive use of Intertek's Client and is provided pursuant to the agreement between Intertek and its Client. Intertek's responsibility and liability are limited to the terms and conditions of the agreement. Intertek assumes no liability to any party, other than to the Client in accordance with the agreement, for any loss, expense or damage occasioned by the use of this report. Only the Client is authorized to permit copying or distribution of this report and then only in its entirety. Any use of the Intertek name or one of its marks for the sale or advertisement of the tested material, product or service must first be approved in writing by Intertek. The observations and test results in this report are relevant only to the sample tested. This report by itself does not imply that the material, product, or service is or has ever been under an Intertek certification program.

Approved by

Hideaki Kosemura
[Technical Manager]

Tested by

Koichi Wagatsuma
[Engineer]



In Accordance with FCC Rules and Regulations, Volume II, Part 2 and 90

Sub-part 2.1033

Applicant and Manufacture Information	
APPLICANT	
Company	: JVCKENWOOD Corporation
Address	: 1-16-2, Hakusan, Midori-ku, Yokohama-shi Kanagawa, 226-8525 Japan
Contact Person	: Kazuyoshi Akaike
MANUFACTURER	
Company	: JVCKENWOOD Corporation
Address	: 1-16-2, Hakusan, Midori-ku, Yokohama-shi Kanagawa, 226-8525 Japan
(c)(2) FCC ID	
FCC ID	: K44513200
Model number	: NXR-1800-E
Serial number	: 015
Instruction Manual(S)	
Instruction manual(s)	: Please refer to attached Exhibits F
Type of Emission	
Emission Designation	: 16K0F3E(Wide) : FCC Part 90 (470 to 512MHz) 11K0F3E(Narrow) 7K60FXD(Narrow) / 7K60FXE(Narrow) / 7K60F7E(Narrow) / 7K60F7D(Narrow) / 7K60F7W(Narrow) / 7K60FXW(Narrow) 8K30F1E(Narrow) / 8K30F1D(Narrow) / 8K30F7W(Narrow) 4K00F1E(Very Narrow) / 4K00F1D(Very Narrow) / 4K00F7W(Very Narrow) 4K00F2D(Very Narrow)
Frequency range	
Frequency Range	: FCC:450 to 512 MHz 16K0F3E : FCC Part 90 (470 to 512MHz)
Power Rating	
Output Power	: 1 to 40 W
Type	: Continuously Variable
Maximum Power Rating	
Output Power	: 40 W
Voltages & currents in all elements in final RF stage, including final transistor or solid-state device	
Collector Current, A	: 12.0 A Maximum
Collector Voltage, Vdc	: DC 13.2 V (10.8 to 15.6 V)
Supply Voltage, Vdc	: 13.2 Vdc
Other Information	
Number of Channel	: 32 channels max.
Maximum Deviation	: ± 5 kHz (16K0F3E), ± 2.5 kHz (11K0F3E)
Frequency Stability	: 0.5 ppm
Antenna Impedance	: 50 Ω Norminal
Note	
This information was provided by the Applicant or customer. Intertek doesn't take any responsibility for the information.	

TABLE OF CONTENTS

	Page
SECTION 1. GENERAL INFORMATION	4
SECTION 2. SUMMARY OF TEST RESULT	5
SECTION 3. TEST AND MEASUREMENT DATA	6
SECTION 4. INFORMATION ABOUT EUT AND SUPPORT EQUIPMENT(S)	7
SECTION 5. SUPPORT EQUIPMENT	8
SECTION 6. USED CABLE(S)	9
SECTION 7. TEST CONFIGURATION	10
SECTION 8. OPERATING CONDITION	11
SECTION 9. MEASUREMENT UNCERTAINTY	12
SECTION 10. TEST DATA	
10.1 Carrier Output Power (Conducted)	13
10.2 Unwanted Emissions (Transmitter Conducted)	16
10.3 Field Strength of Spurious Radiation	64
10.4 Emission Masks (Occupied Bandwidth)	68
10.5 Transient Frequency Behavior	78
10.6 Audio Frequency Response / Audio Low Pass Filter (Voice Input)	86
10.7 Modulation Limiting	90
10.8 Frequency Stability (Temperature Variation)	95
10.9 Frequency Stability (Voltage Variation)	98
10.10 Necessary Bandwidth and Emission Bandwidth	100
APPENDIX PHOTOGRAPHS	

SECTION 1. GENERAL INFORMATION

TEST PERFORMED

Location	Kashima No.12 Test Site		
EUT Received	May 15, 2023		
Date of Test	May 15, 2023	to	June 05, 2023
Standard Applied	FCC Part 22, 74, 90		
Measurement Method	ANSI/TIA-603-E-2016 ANSI C63.26 2015		
Deviation from Standard(s)	Not applicable		

QUALIFICATIONS OF TESTING LABORATORY (Kashima Lab.)

ACCREDITATION	SCOPE	LAB. CODE	Remarks
VLAC	Wireless / EMC Testing	VLAC-008-1	JAPAN
NVLAP	Wireless Testing	600233-0	USA
FCC	Wireless / EMC Testing	JP0008	USA
ISED	Wireless Testing	JP0008(CABID)	Canada

ABBREVIATIONS

EUT	Equipment Under Test	DoC	Declaration of Conformity
AMN	Artificial Mains Network	ISN	Impedance Stabilization Network
LISN	Line Impedance Stabilization Network	Q-P	Quasi-peak
AMP	Amplifier	AVG	Average
ATT	Attenuator	PK	Peak
ANT	Antenna	Cal	Calibration
BBA	Broadband Antenna	N/A	Not applicable or Not available
DIP	Dipole Antenna	LCD	Liquid-Crystal Display
AE	Associated Equipment	4LEVEL FSK	4LEVEL Frequency Shift Key
GMSK	Gaussian Maximum Shift Key	CW ID	Continuously Repeating bit stream
FM	Frequency Modulation	C4FM	Constant envelope 4 Level FM
PTT	Push to Talk	AFC	Automatic frequency control

Revision Summary

Revised Date	Section	Description of Changes

SECTION 2. SUMMARY OF TEST RESULT

TEST ITEM	FCC			RESULTS	Comments
	Part22	Part74	Part90		
Carrier Output Power (Conducted)	-	74.461	-	2.1046 (a)	PASS
Unwanted Emissions (Transmitter Conducted)	22.359	-	90.210	2.1051	PASS
Field Strength of Spurious Radiation	22.359	-	90.210	2.1053 (a)	PASS
Emission Masks (Occupied Bandwidth)	22.359	74.462	90.210	2.1049 (c) (1)	PASS
Transient Frequency Behavior	-	-	90.214	-	PASS
Audio Low Pass Filter (Voice Input)	-	-	-	2.1047 (a)	PASS
Audio Frequency Response	-	-	-	2.1047 (a)	PASS
Modulation Limiting	-	-	-	2.1047 (b)	PASS
Frequency Stability (Temperature Variation)	22.355	74.464	90.213 (a)	2.1055 (a) (1)	PASS
Frequency Stability (Voltage Variation)	22.355	74.464	90.213 (a)	2.1055 (d) (1)	PASS
Certification required (FCC Part 90.203(j)(3))	-	-	90.203 (j)(3)	-	Complied
Certification required (FCC Part 90.203(j)(4))	-	-	90.203 (j)(4)	-	Complied
Certification required (FCC Part 90.203(j)(5))	-	-	90.203 (j)(5)	-	Complied
Certification required (FCC Part 90.203(e))	-	-	90.203 (e)	-	Complied

Limitation on Results

The test result of this report is effective equipment under test itself and under the test configuration described on the report.

This test report does not assure that whether the test result taken in other testing laboratory is compatible or reproducible to the test result on this report or not.

Note:

As for the FCC Part 15 Subpart B-Unintentional Radiators, the EUT has been measured and declared as Supplier's Declaration of Conformity (SDoC) by JVCKENWOOD Corporation.

SECTION 3. TEST AND MEASUREMENT DATA

All test and measurements indicated in this document were performed in accordance with the Code of Federal Regulations Title 47 Part 2, Sub-part J and Industry Canada as the following individual parts:

FCC Rule	Test Item	Tested
Part 22	Non Cellular	YES
Part 74	Experimental Radio Auxiliary , Special Broadcast and Other Program Distributional Services	YES
Part 90	Private Land Mobile radio Services	YES

SECTION 4. INFORMATION ABOUT EUT AND SUPPORT EQUIPMENT(S)

This information was provided by the Applicant or customer.
 Intertek doesn't take any responsibility for the information.

4.1 List of System Configuration

Symbol	Item	Model No.	Serial No.	Manufacture	Remarks
A	UHF REPEATER	NXR-1800-E	015	JVCKENWOOD Corporation	EUT
Power Ratings of EUT :		DC 13.2 V (10.8 to 15.6 V)		12.0 A Maximum	
Power Supply :		13.2 Vdc			
Condition of Equipment		Proto type			
Type		Base Fixed			
Suppression Devices		No Modifications by the laboratory were made to the device			

4.2 Port(s)/Connector(s)

Port Name	Connector Type	Connector Pin	Remarks
LAN	RJ-45	8pin	
ACC	USB Type-A	4 pin	
RF Antenna TX	N	2 pin	
RF Antenna RX	BNC	2 pin	
Control I/O	D-sub	25 pin	

4.3 Highest Frequency Oscillator(s)/Crystal(s)

Operating Frequency	Board Name	Remarks
1400 MHz	CPU	
512 MHz	Radio	

SECTION 5. SUPPORT EQUIPMENT

The EUT was supported by the following equipment during the test.

Example: Case of Section 10.3Test

Symbol	Item	Model No.	Serial No.	Manufacture	FCC ID	Remarks
B	USB ADAPTER	AU-MMSA	None	SABRENT	N/A	
C	Terminator	None	None	JVCKENWOOD	N/A	
D	Terminator	None	None	JVCKENWOOD	N/A	
E	HUB	SF100D-05 v2	PSJ16070C88	CISCO	DoC	
F	AC ADAPTER	MU06-6120050-A1	0432-011X000	LEADER ELECTRONICS INC.	N/A	
G	DC Power Supply	PMC35-3A	LE000716	KIKUSUI	N/A	
H	Terminator	CT-150NP	1138693	TME	N/A	
I	Terminator	UT-01	None(EMI121)	TME	N/A	
J	Controller	None	None	JVCKENWOOD	N/A	
Supplied Power:						
F, G	AC	100V,60Hz				

Note: The information of Symbol B, C, D, E, F and J are provided by the Applicant or customer. Intertek doesn't take any responsibility for the information.

SECTION 6. USED CABLE(S)

The following cable(s) was used for the test.

Example: Case of Section 10.3Test

No.	Name	Length (m)	Shield	Metal Connector	Ferrite core	Remarks
1	LAN cable	2.00	No	No		
2	D-Sub cable	1.60	Yes	Yes		
3	USB cable	2.00	Yes	Yes		
4	DC cable	4.00	No	No	Removable x 1	
5	DC cable	1.40	No	No	Removable x 2	
6	Power cable for DC Power Supply (AC)	1.80	No	No		

Note: The information of No.2, No.4 and No.5 cables are provided by the Applicant or customer.
 Intertek doesn't take any responsibility for the information.

One Ferrite cores of No.4 cable is supplied together with EUT(A).

Two Ferrite cores of No.5 cable is supplied together with HUB(E).

SECTION 7. TEST CONFIGURATION

Details of Configuration and Connection

Example: Case of Section 10.3 Test

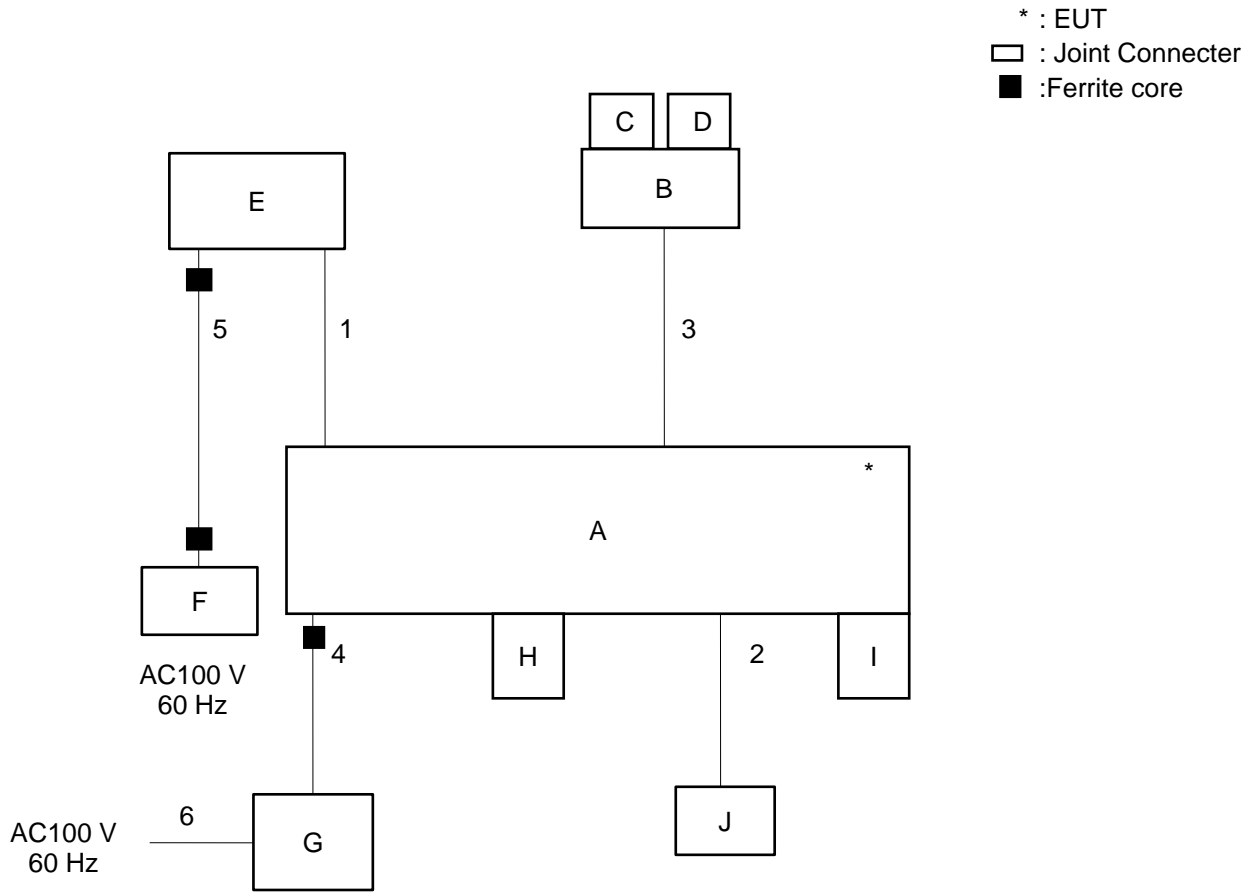

SECTION 8. OPERATING CONDITION

The EUT was operated under the following condition during the test.

8.1 Operating Condition

The test was carried out under Transmit mode.

(FCC: 450.05 MHz, 481.05 MHz, 511.95 MHz)

(16K0F3E : 450.05 MHz, 470.05MHz, 481.05 MHz, 491.05 MHz, 511.95 MHz)

(High Power : 40W, Low Power : 1W)

8.2 Operating Flow [Transmit mode]

Following operations were performed continuously.

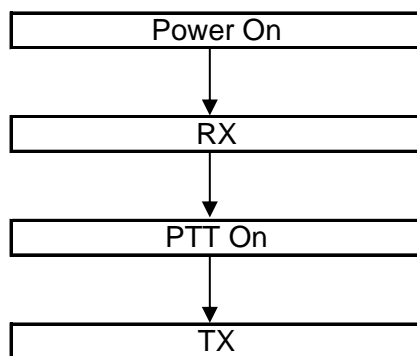

SECTION 9. MEASUREMENT UNCERTAINTY

Carrier Output Power (Conducted)	U_{lab}	Utia-603-e
	+/- 0.18dB ($k = 2$)	+/- 0.59 dB
Unwanted Emissions (Transmitter Conducted)		
	+/- 1.55 dB ($k = 2$)	+/- 1.1 dB
Field Strength of Spurious Radiation		
	+/- 3.60dB ($k = 2$)	+/- 3.3 dB
Emission Masks (Occupied Bandwidth)		
	+/- 0.87dB ($k = 2$)	+/- 2.1 dB
Transient Frequency Behavior		
	+/- 2.28% ($k = 2$)	+/- 21.6 %
Audio Low Pass Filter (Voice Input)		
	+/- 0.21dB ($k = 2$)	+/- 1.2 dB
Audio Frequency Response		
	+/- 0.12dB ($k = 2$)	+/- 1.2 dB
Modulation Limiting		
	+/- 0.99% ($k = 2$)	+/- 1.0 %
Frequency Stability (Temperature Variation)		
	+/- 9.93Hz ($k=2$)	+/-34.2 Hz
Frequency Stability (Voltage Variation)		
	+/- 9.93Hz ($k=2$)	+/-34.2 Hz
Receiver Spurious Emissions	U_{lab}	Ucispr
30-1000MHz	+/- 5.63dB ($k = 2$)	+/- 6.3 dB
abobe 1GHz 1-6GHz	+/- 5.06dB ($k = 2$)	+/- 5.2 dB
6-40GHz	+/- 5.41dB ($k = 2$)	+/- 5.5 dB (6-18 GHz), Nil (18-40 GHz)
Bandwidth		
	+/- 1.00% ($k = 2$)	-

SECTION 10. TEST DATA

10.1 Carrier Output Power (Conducted)

REGULATIONS	: FCC Part 2 Section 1046 (a)
TEST METHOD/GUIDE	: ANSI/TIA-603-E Section 2.2.1.2 ANSI C63.26 Section 5.2

Test Procedure

- 1 The EUT and test equipment were set up as shown on the following page.
- 2 The EUT was conducted to a resistive coaxial attenuator of normal load impedance.
 $RF\ Power\ (dBm) = Power\ Meter\ reading\ (dBm) + Attenuator\ Loss\ (dB) + Cable\ Loss\ (dB)$
 $RF\ Power\ (W) = 10^{(RF\ Power\ (dBm)/10)}/1000$
- 3 Modulate the transmitter with a 2.5 kHz sine wave at an input Level of 16 dB greater than that necessary to produce 50 % of rated system deviation.(Only as for the test of RSS)

Measuring Equipments

No.	Equipment	Manufacture	Model No.	Serial No.	Cal. Interval	Effective period
1	Power Meter	Hewlett Packard	E4418B	GB38410265	1Y	Sep. 15, 23
2	Power Sensor	Hewlett Packard	8482A	US37292237	1Y	Sep. 15, 23
3	Attenuator (20dB)	Aeroflex/Wenshel	66-20-34	BY4357	1Y	Sep. 25, 23
4	Attenuator (30dB)	Weinschel	WA-29-30-34	8923	1Y	Sep. 25, 23
5	DC Power Supply	Daiichi denpa kogyo	GZV4000	90290931	None	None
6	Digital Multi Meter	FLUKE	8846A	9642018	1Y	Jun. 30, 23
7	JIG	HP	EliteBook 2170p	JPA4139KMG	None	None

Measuring Cables

No.	Cable	Manufacturer	Model No.	Serial No.	Cal. Interval	Effective period
	None					

Measuring Equipment Configuration

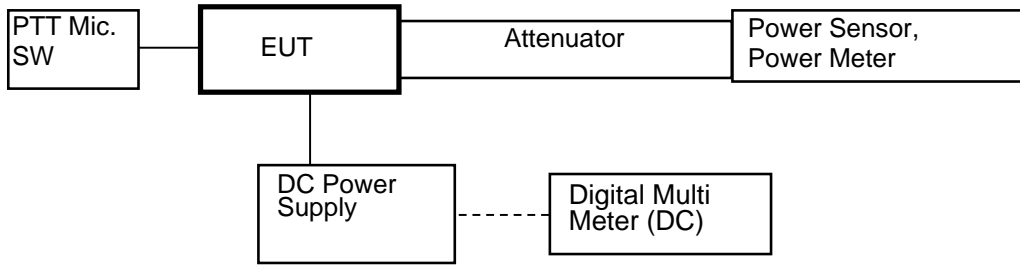

<NXDN and CW ID Modulation Case>

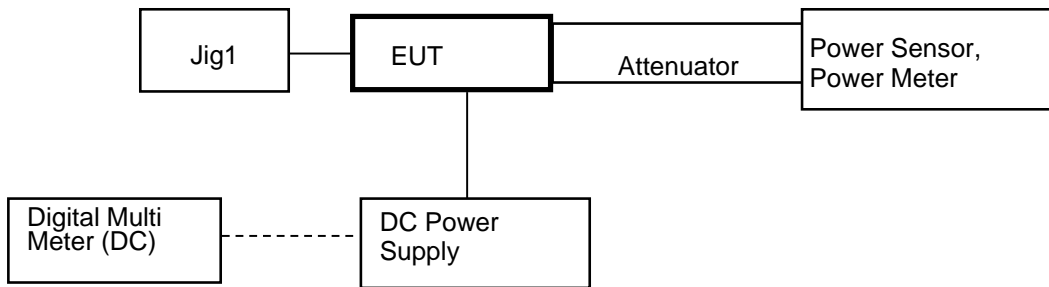

Test Results

Test date	May. 15, 2023	
Location	Kashima No.12 Test Site	
temperature	24.0	[degree C]
Humidity Variation	50.0	[%]
Atmospheric Pressure	100.5	[kPa]
Test Engineer	Koichi Wagatsuma	

Test was carried out for all the Authorized Bandwidth.
 State the worst case (below).

No.	Frequency (MHz)	Band	Setting	RF Power (W)
1	450.05	Low	High Power	40
2	470.05	Low (For 16K0F3E Part 90)	High Power	40
3	481.05	Middle	High Power	40
4	491.05	Middle (For 16K0F3E Part 90)	High Power	40
5	511.95	High	High Power	40
6	450.05	Low	Low Power	1
7	470.05	Low (For 16K0F3E Part 90)	Low Power	1
8	481.05	Middle	Low Power	1
9	491.05	Middle (For 16K0F3E Part 90)	Low Power	1
10	511.95	High	Low Power	1

RF Power: Maximum reading

10.2 Unwanted Emissions (Transmitter Conducted)

REGULATIONS	: FCC Part 2 Section 1051, Part 22 Section 359, Part 90 Section 210
TEST METHOD/GUIDE	: ANSI/TIA-603-E Section 2.2.13.2 ANSI C63.26 Section 5.7

Test Procedure

- 1 The EUT and test equipment were set up as shown on the following page.
- 2 Modulate the transmitter with a 2.5 kHz sine wave at an input Level of 16 dB greater than that than that necessary to produce 50 % of rated system deviation.
- 3 Adjust the spectrum analyzer for the following setting:
 - a) RBW : 100 kHz (< 1 GHz), 1 MHz (> 1 GHz).
 - b) VBW : 300 kHz (< 1 GHz), 3 MHz (> 1 GHz).
 - c) Detector mode : Average power (FM Modulation) , Positive peak with peak hold (Digital Modulation)
- 4 The emissions were measured for the worst case as follows:
 - a) : within a band of frequencies defined by the carrier frequency plus and minus one channel.
 - b) : from the lowest frequency generated in the EUT and to at least the 10th harmonic of the carrier frequency, or 40 GHz, whichever is lower.

Measuring Equipments

No.	Equipment	Manufacture	Model No.	Serial No.	Cal. Interval	Effective period
1	Attenuator (20dB)	Aeroflex/Wenshel	66-20-34	BY4357	1Y	Sep. 25, 23
2	Attenuator (30dB)	Weinschel	WA-29-30-34	8923	1Y	Sep. 25, 23
3	Highpass Filter	Anritsu	MP526D	6200220657	1Y	Jun. 28, 23
4	Modulation Analyzer	Hewlett Packard	8901B	3403A04852	1Y	Jan. 02, 24
5	Signal Generator	Rohde&Schwarz	SMB 100A	105709	1Y	Jun. 05, 23
6	Audio Generator	Anritsu	MG443B	M70150	1Y	Apr. 11, 24
7	Spectrum Analyzer	Agilent	N9030A	US51350170	1Y	Jul. 10, 23
8	DC Power Supply	Daiichi denpa kogyo	GZV4000	90290931	None	None
9	Digital Multi Meter	FLUKE	8846A	9642018	1Y	Jun. 30, 23
10	JIG	HP	ProBook 430 G3	PJPNYOKL0147	None	None

Measuring Cables

No.	Cable	Manufacture	Model No.	Serial No.	Cal. Interval	Effective period
W3	Balance Cable	Nicoon	3D-2V	KSR00092	1Y	Sep. 21, 23
W4	Coaxial Cable	Pacific custom	RG-58 C/U	AM90C03	1Y	Feb. 13, 24
W2	Coaxial Cable	Suhner	SUCOFLEX104	F0000019	1Y	May. 07, 24

Measuring Equipment Configuration

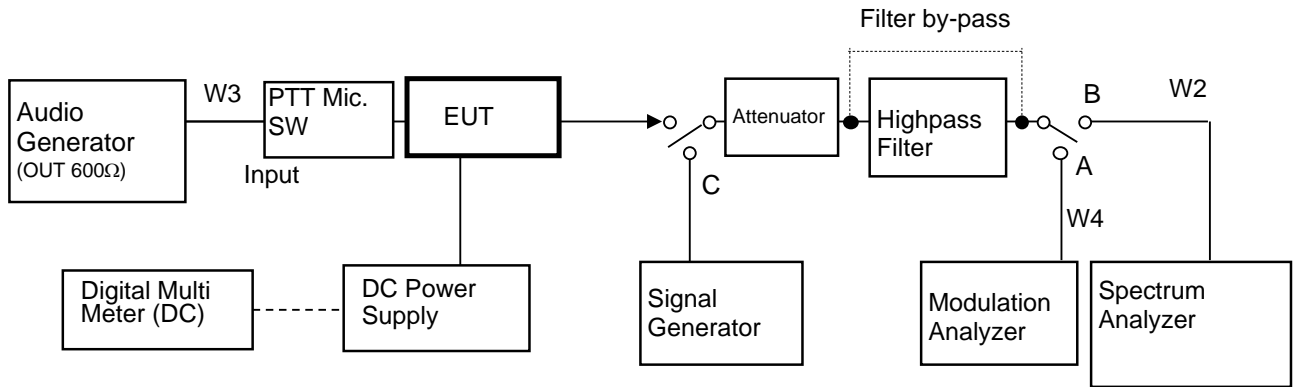

Note: Configuration of other Modulation test is composed without the Audio Generator.

<NXDN and CW ID Modulation Case>

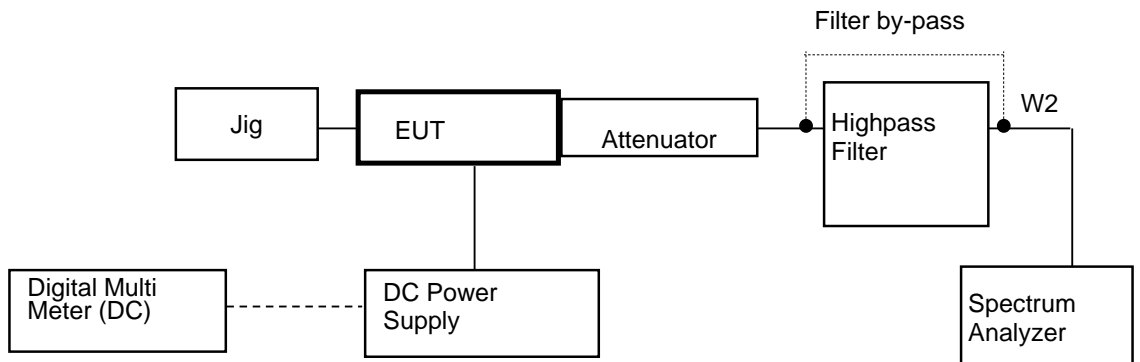

Test Results

Test date	May. 22, 2023	and	May. 25, 2023
Location	Kashima No.12 Test Site		
temperature	22.2	to	26.1 [degree C]
Humidity Variation	37.0	to	47.0 [%]
Atmospheric Pressure	100.4	to	101.6 [kPa]
Test Engineer	Koichi Wagatsuma		

Test was carried out for all the frequency band of section 10.1
State the worst case (below).

State : High Power / Authorized Bandwidth 20 kHz (16K0F3E)

No.	Tuned Frequency (MHz)	Band	Spurious Frequency (MHz)	Correct Level (dBm)	Emission Level (dBc)	Mask B Limit (dBc)	Margin (dB)
1	450.05	Low	900.10	-40.64	-86.66	-59.0	27.7
2	470.05 (For Prats 90)	Low	940.10	-39.89	-85.91	-59.0	26.9
3	481.05	Middle	962.10	-39.87	-85.89	-59.0	26.9
4	491.05 (For Prats 90)	Middle	982.10	-39.45	-85.47	-59.0	26.5
5	511.95	High	1023.90	-36.99	-83.01	-59.0	24.0

There is the margin of 20dB over except for the above points.

Mask B Limit(dBc)=- $(43+10\log(P))$
 Correct Level (dBm) = Substitute SG Level (dBm)
 Emission Level (dBc) = Correct Level (dBm) - $10\log(P*1000)$
 P = Carrier Level (W)
 " - " = Measurement Limit

State : Low Power / Authorized Bandwidth 20 kHz (16K0F3E)

No.	Tuned Frequency (MHz)	Band	Spurious Frequency (MHz)	Correct Level (dBm)	Emission Level (dBc)	Mask B Limit (dBc)	Margin (dB)
1	450.05	Low	900.10	-48.57	-78.57	-43.0	35.6
2	470.05 (For Prats 90)	Low	940.10	-48.39	-78.39	-43.0	35.4
3	481.05	Middle	962.10	-48.77	-78.77	-43.0	35.8
4	491.05 (For Prats 90)	Middle	982.10	-48.61	-78.61	-43.0	35.6
5	511.95	High	1023.90	-38.10	-68.10	-43.0	25.1

There is the margin of 20dB over except for the above points.

Mask B Limit(dBc)=- $(43+10\log(P))$
 Correct Level (dBm) = Substitute SG Level (dBm)
 Emission Level (dBc) = Correct Level (dBm) - $10\log(P*1000)$
 P = Carrier Level (W)
 " - " = Measurement Limit

16K0F3E
 9 KHz to Fc

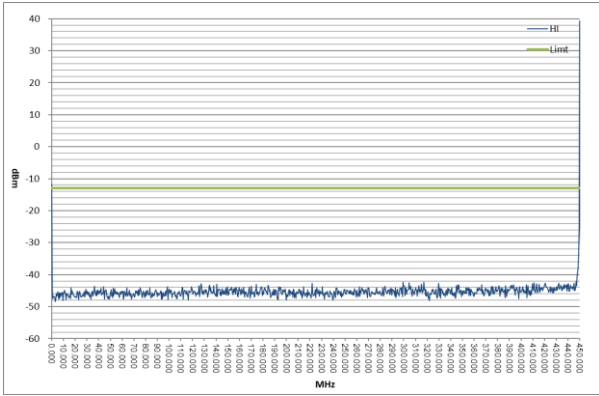

Hi Power
 Fc= 450.05 MHz
 Fc to 2Fc

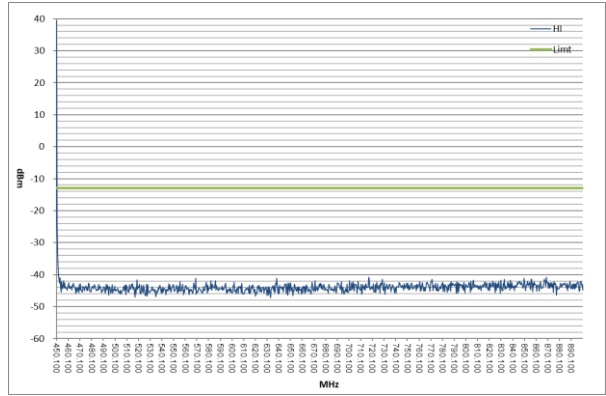

2Fc to 1GHz

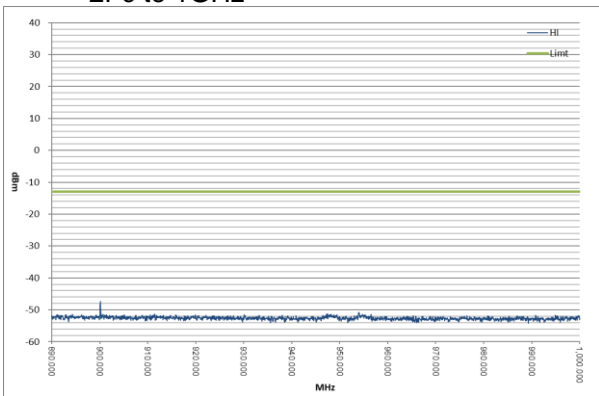

1GHz to 2GHz

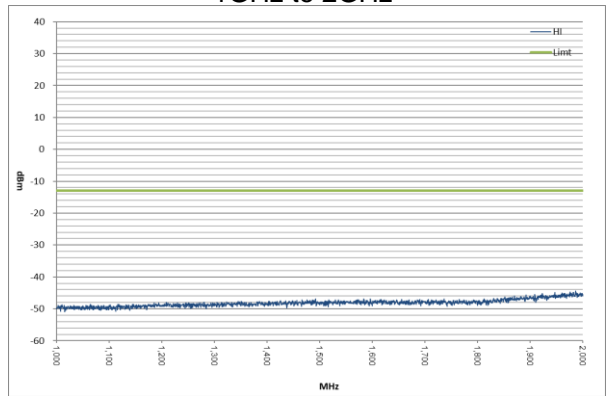

2GHz to 10Fc

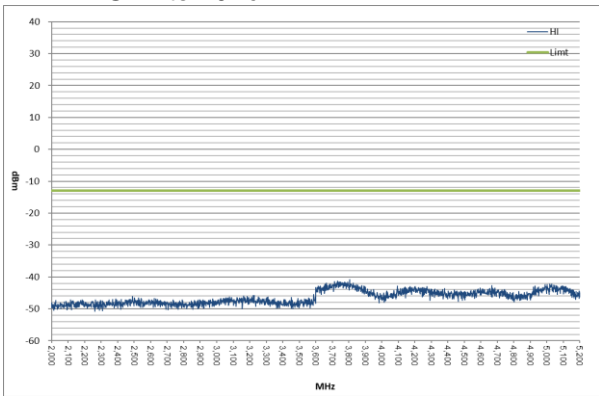

16K0F3E
 9 KHz to Fc

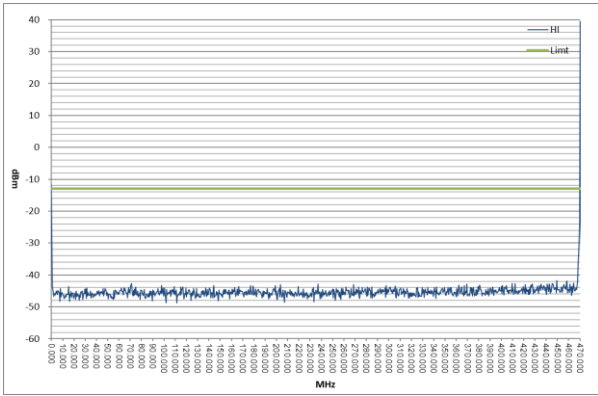

Hi Power
 Fc= 470.05 MHz
 Fc to 2Fc

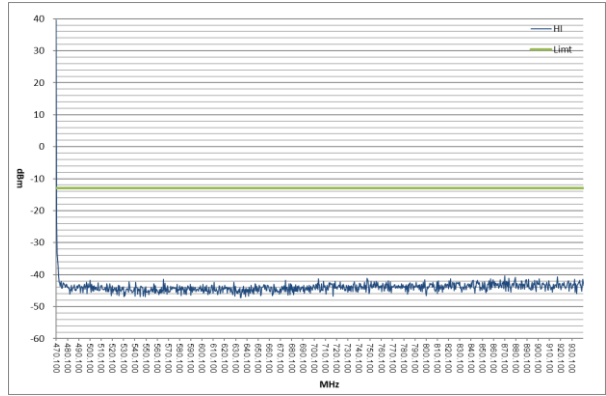

2Fc to 1GHz

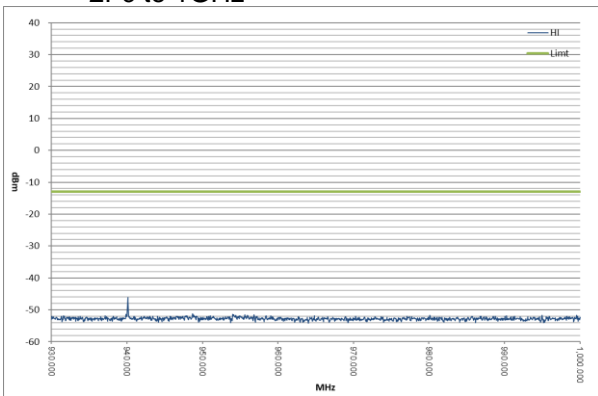

1GHz to 2GHz

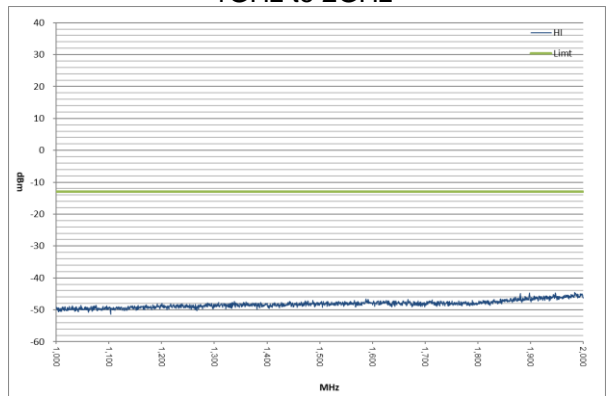

2GHz to 10Fc

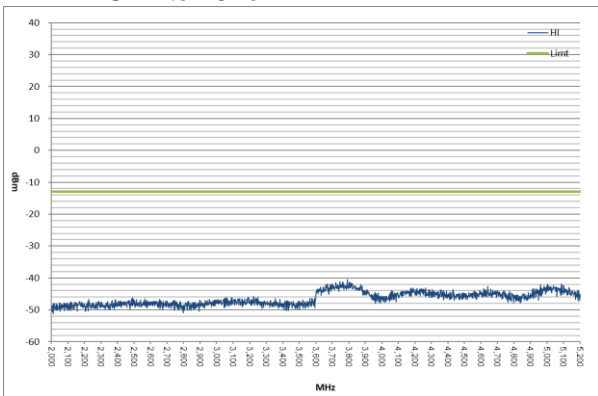

16K0F3E
 9 KHz to Fc

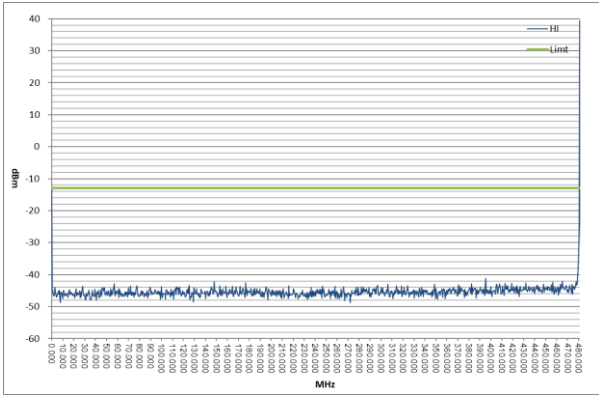

Hi Power
 Fc= 481.05 MHz
 Fc to 2Fc

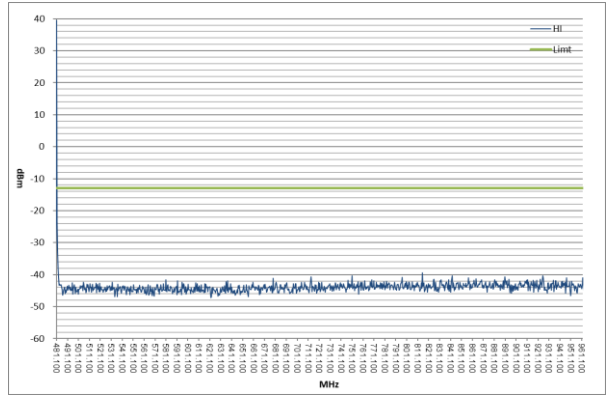

2Fc to 1GHz

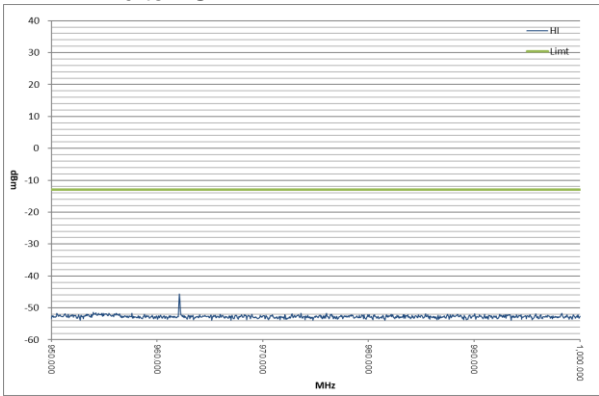

1GHz to 2GHz

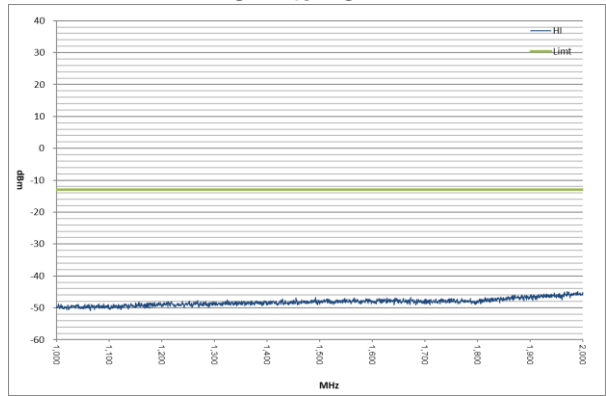

2GHz to 10Fc

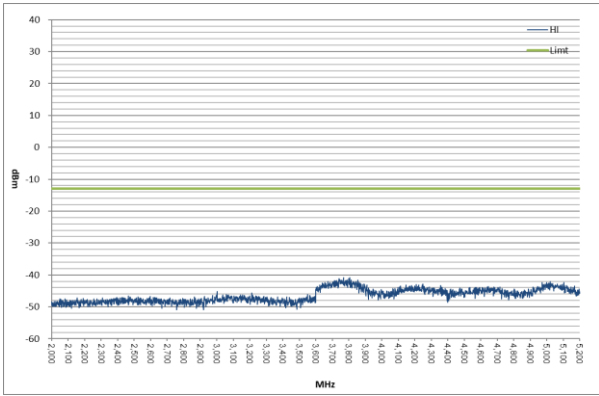

16K0F3E
 9 KHz to Fc

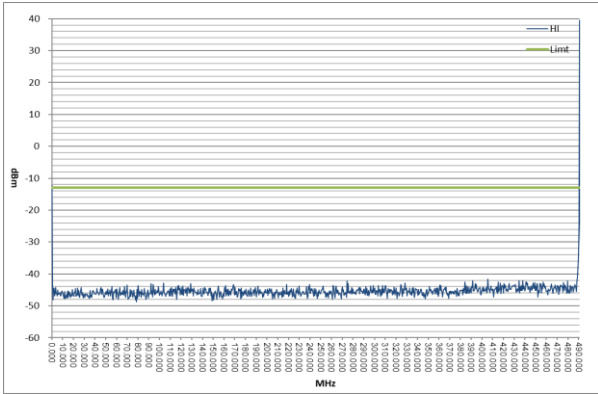

Hi Power
 Fc= 491.05 MHz
 Fc to 2Fc

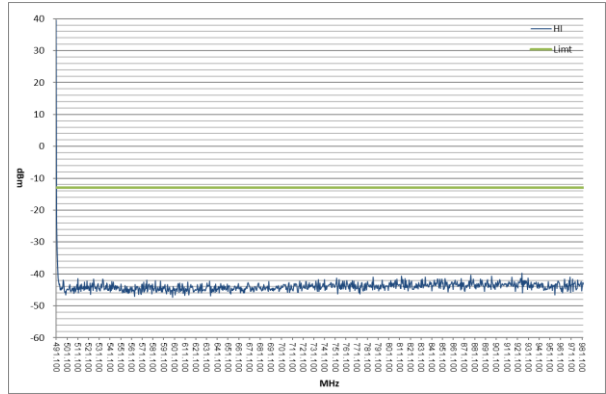

2Fc to 1GHz

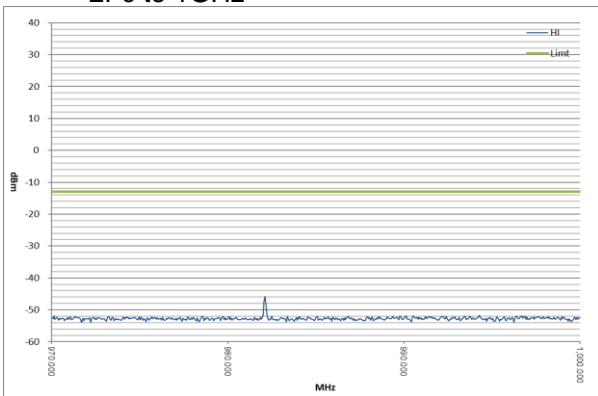

1GHz to 2GHz

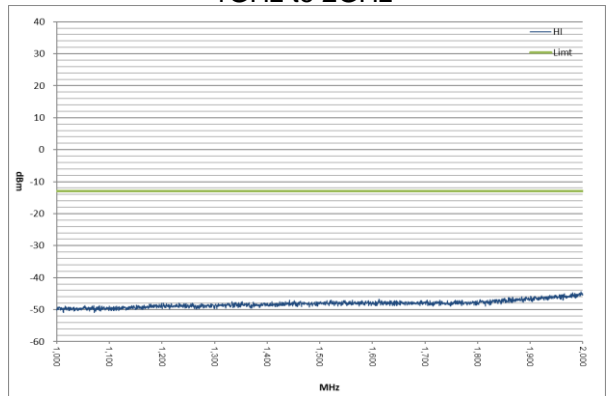

2GHz to 10Fc

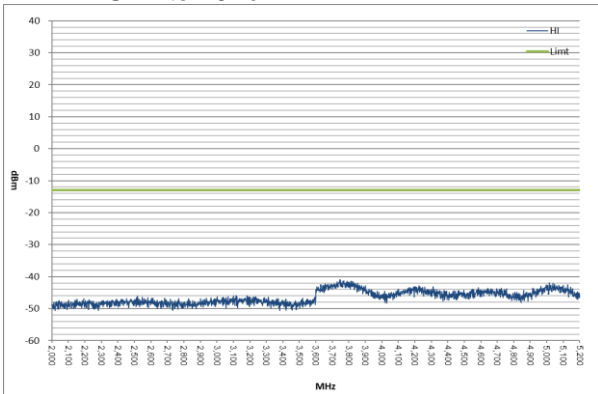

16K0F3E
 9 KHz to Fc

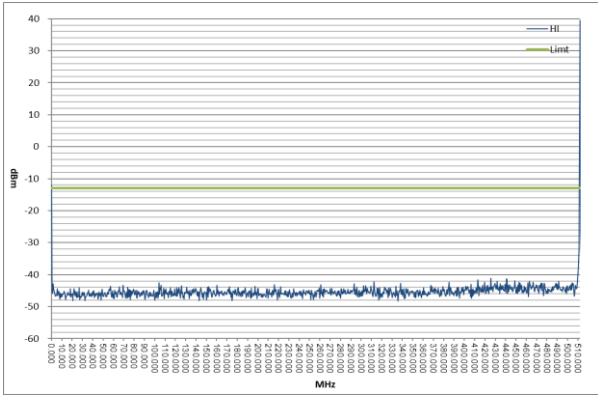

Hi Power
 Fc= 511.95 MHz
 Fc to 1GHz

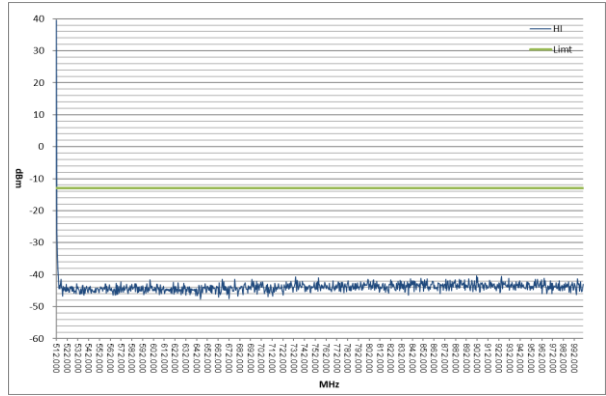

1GHz to 2Fc

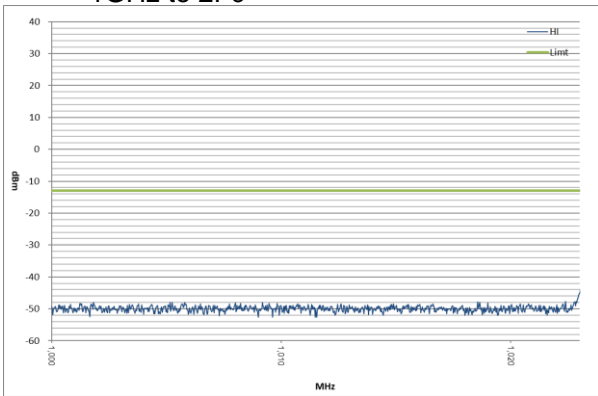

1GHz to 2GHz

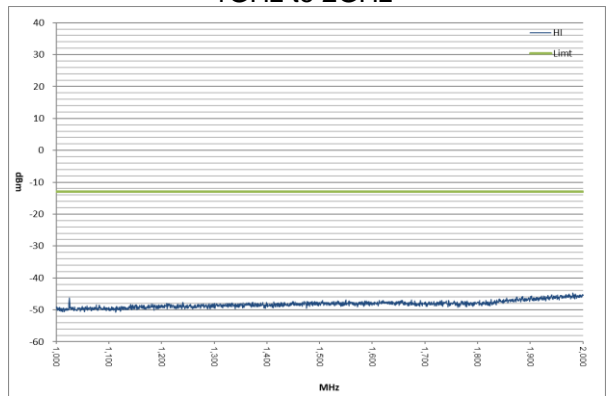

2GHz to 10Fc

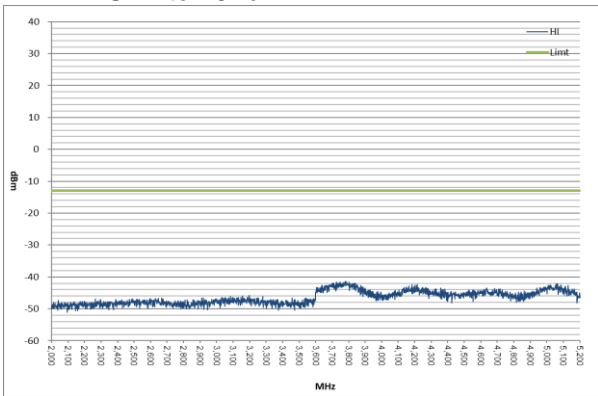

16K0F3E
 9 KHz to Fc

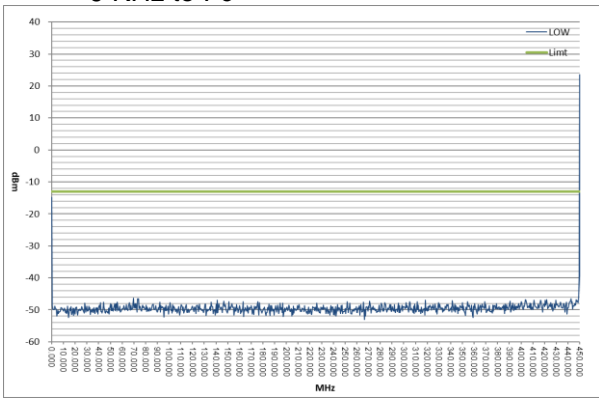

Low Power Fc= 450.05 MHz
 Fc to 2Fc

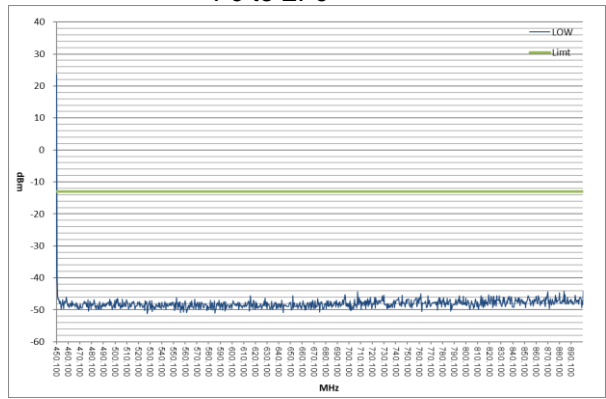

2Fc to 1GHz

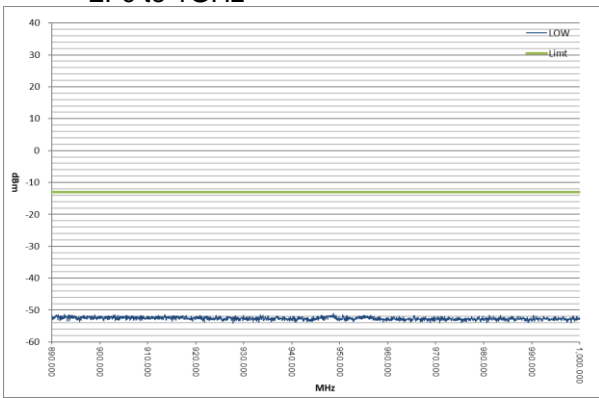

1GHz to 2GHz

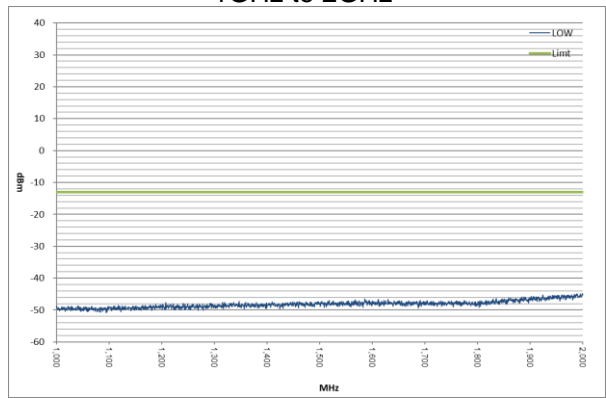

2GHz to 10Fc

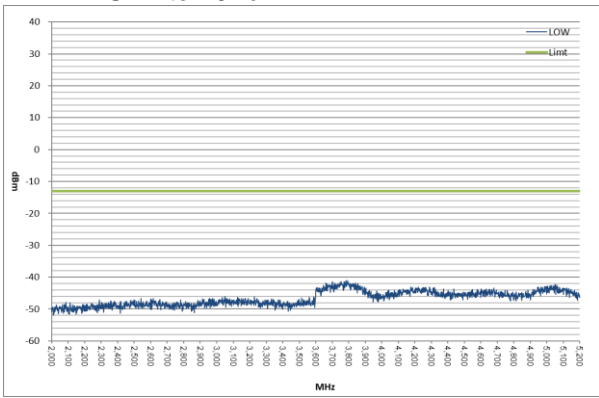

16K0F3E
9 KHz to Fc

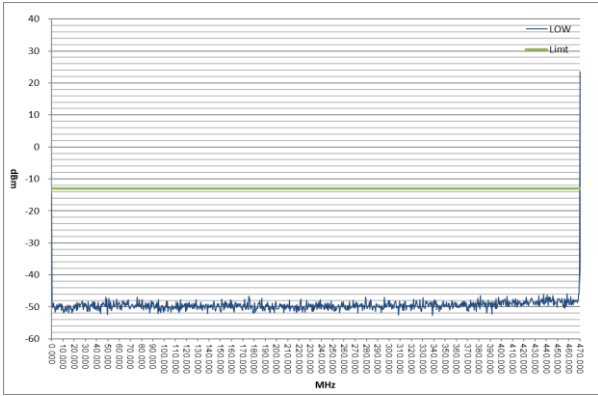

Low Power Fc= 470.05 MHz
Fc to 2Fc

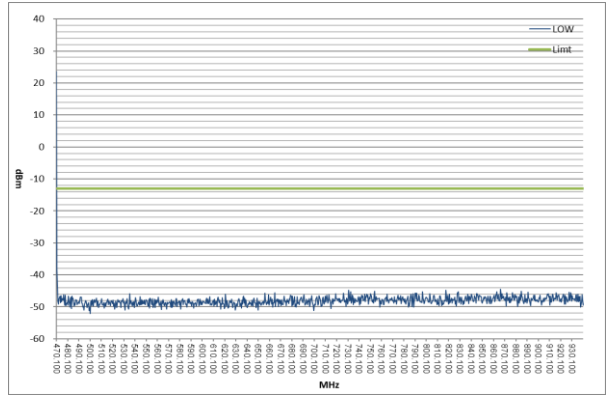

2Fc to 1GHz

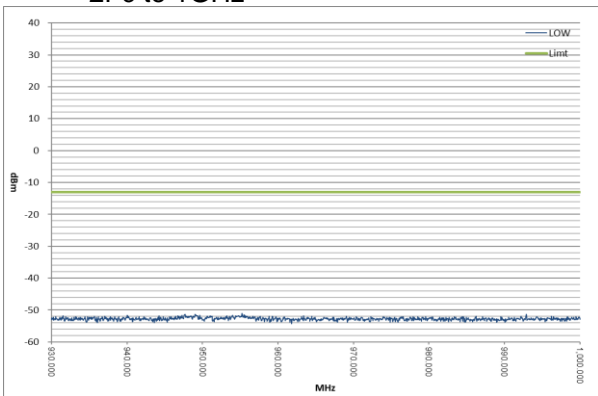

1GHz to 2GHz

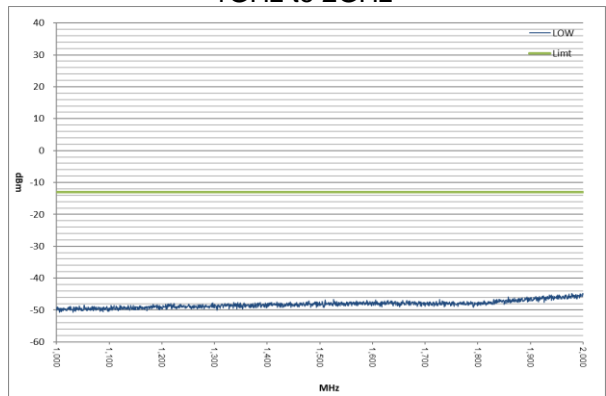

2GHz to 10Fc

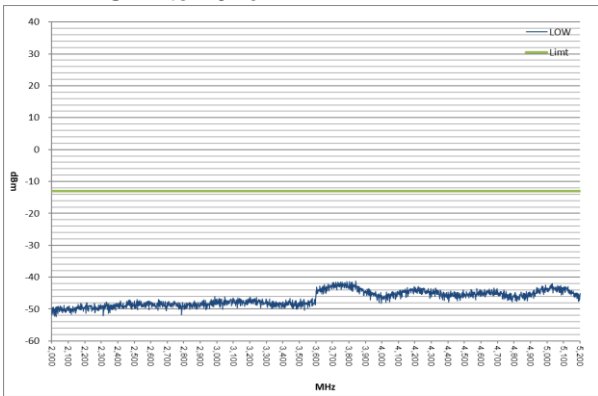

16K0F3E
 9 KHz to Fc

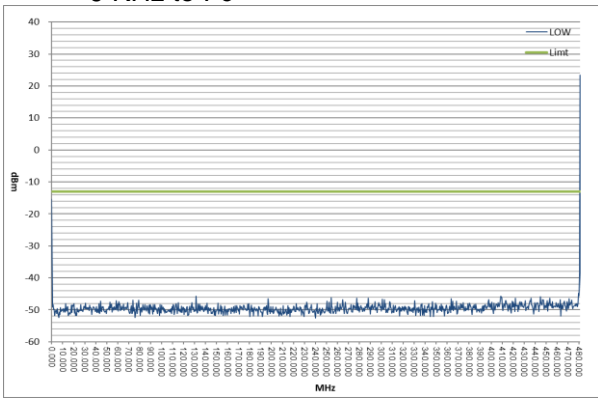

Low Power Fc= 481.05 MHz
 Fc to 2Fc

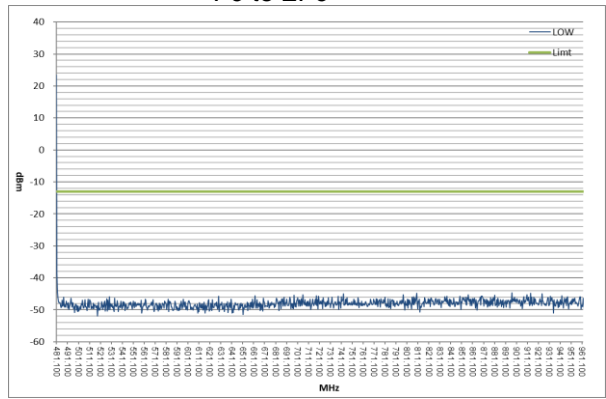

2Fc to 1GHz

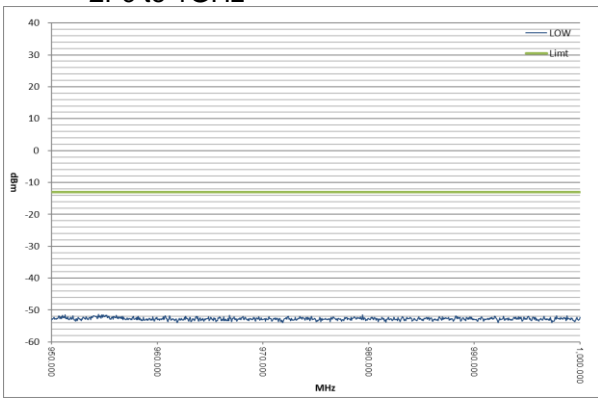

1GHz to 2GHz

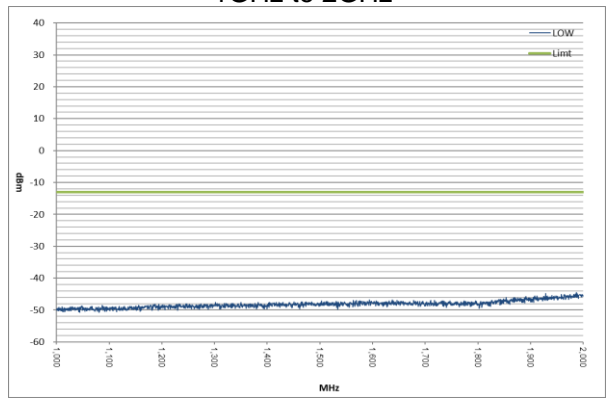

2GHz to 10Fc

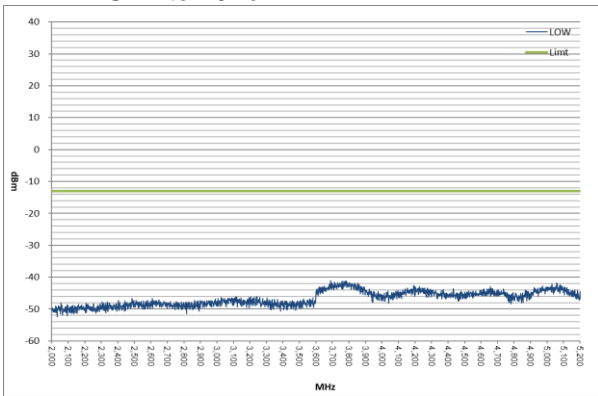

16K0F3E
9 KHz to Fc

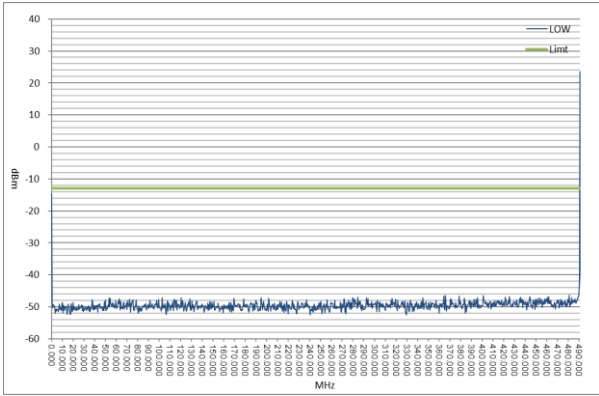

Low Power Fc= 491.05 MHz
Fc to 2Fc

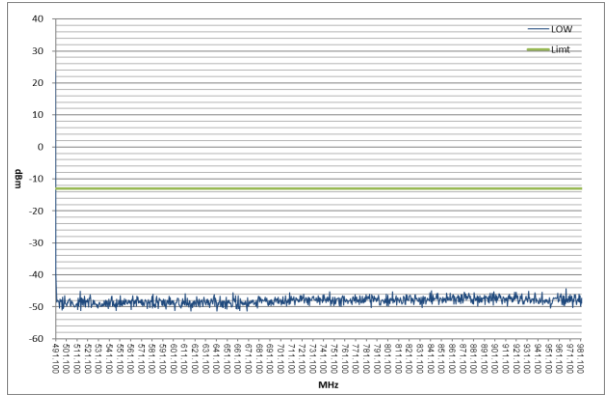

2Fc to 1GHz

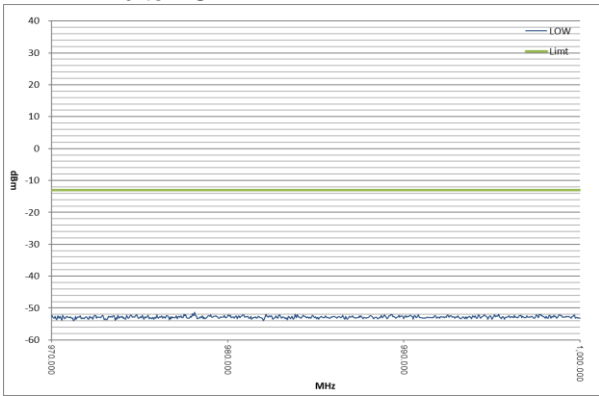

1GHz to 2GHz

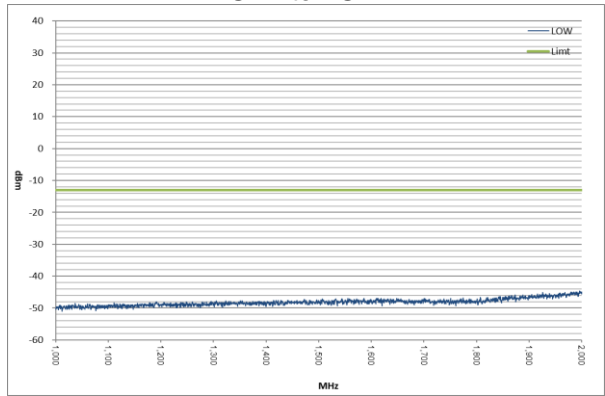

2GHz to 10Fc

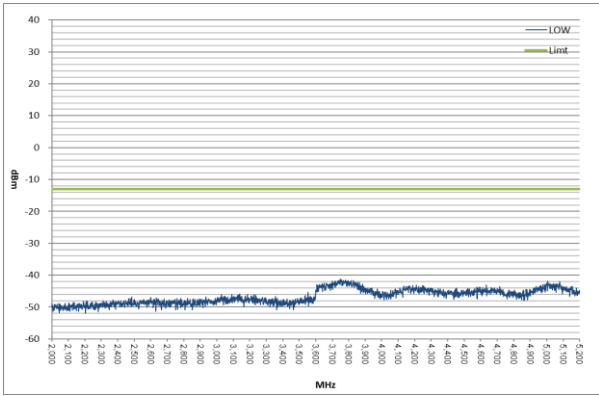

16K0F3E
9 KHz to Fc

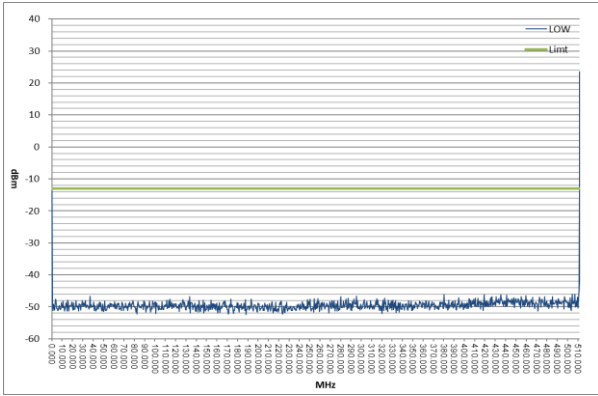

Low Power Fc= 511.95 MHz
Fc to 1GHz

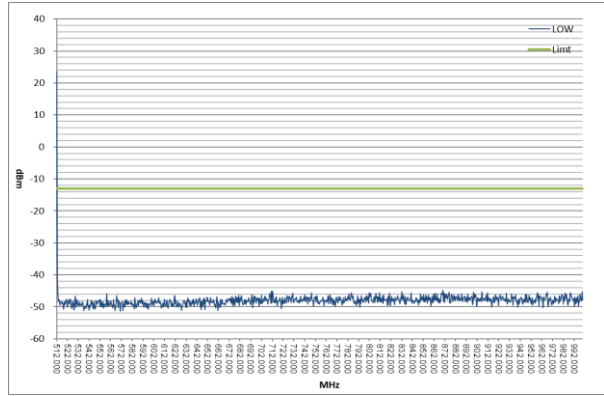

1GHz to 2Fc

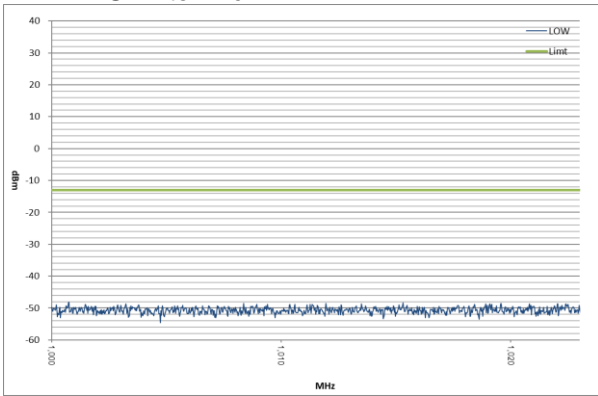

1GHz to 2GHz

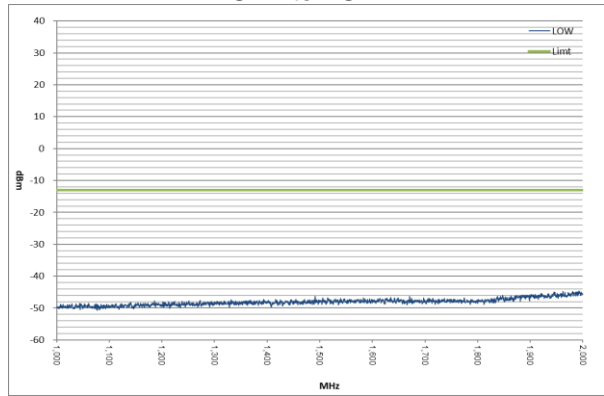

2GHz to 10Fc

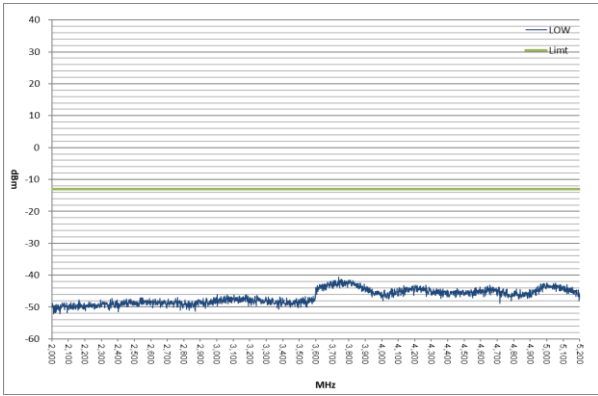

State : High Power / Authorized Bandwidth 11.25 kHz (11K0F3E)

No.	Tuned Frequency (MHz)	Band	Spurious Frequency (MHz)	Correct Level (dBm)	Emission Level (dBc)	Mask D Limit (dBc)	Margin (dB)
1	450.05	Low	900.10	-40.76	-86.78	-66.0	20.8
2	481.05	Middle	962.10	-40.24	-86.26	-66.0	20.3
3	511.95	High	1023.90	-36.90	-82.92	-66.0	16.9

There is the margin of 20dB over except for the above points.

Mask D Limit (dBc) = $-(50+10\log(P))$
 Correct Level (dBm) = Substitute SG Level (dBm)
 Emission Level (dBc) = Correct Level (dBm) - $10\log(P*1000)$
 P = Carrier Level (W)
 " - " = Measurement Limit

State : Low Power / Authorized Bandwidth 11.25 kHz (11K0F3E)

No.	Tuned Frequency (MHz)	Band	Spurious Frequency (MHz)	Correct Level (dBm)	Emission Level (dBc)	Mask D Limit (dBc)	Margin (dB)
1	450.05	Low	900.10	-48.57	-78.57	-50.0	28.6
2	481.05	Middle	962.10	-48.77	-78.77	-50.0	28.8
3	511.95	High	1023.90	-38.10	-68.10	-50.0	18.1

There is the margin of 20dB over except for the above points.

Mask D Limit (dBc) = $-(50+10\log(P))$
 Correct Level (dBm) = Substitute SG Level (dBm)
 Emission Level (dBc) = Correct Level (dBm) - $10\log(P*1000)$
 P = Carrier Level (W)
 " - " = Measurement Limit

11K0F3E
 9 KHz to Fc

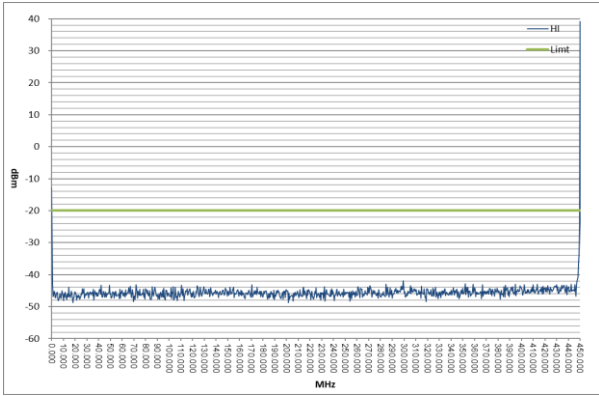

Hi Power
 Fc= 450.05 MHz
 Fc to 2Fc

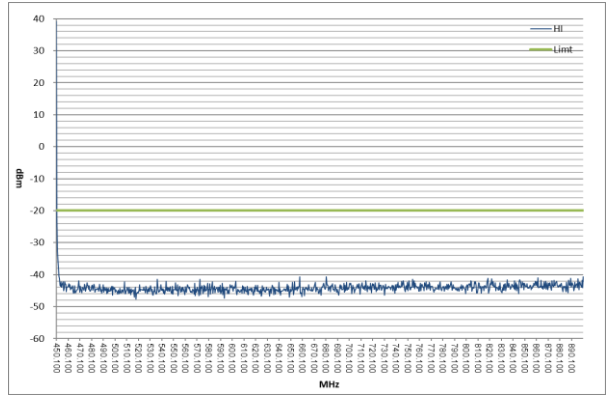

2Fc to 1GHz

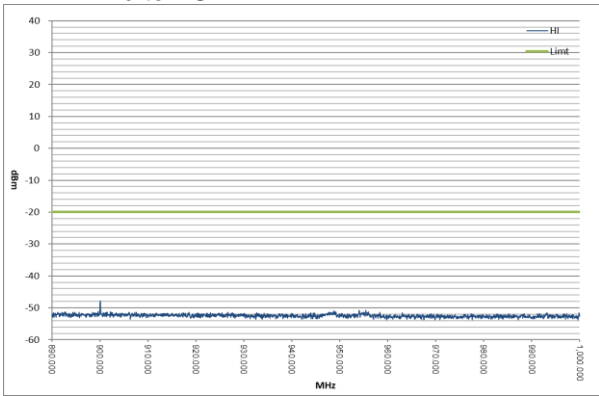

1GHz to 2GHz

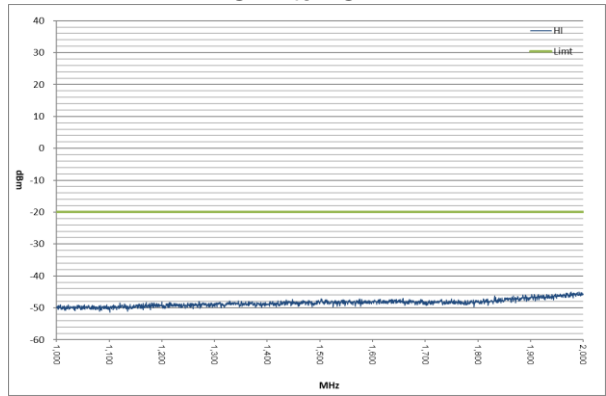

2GHz to 10Fc

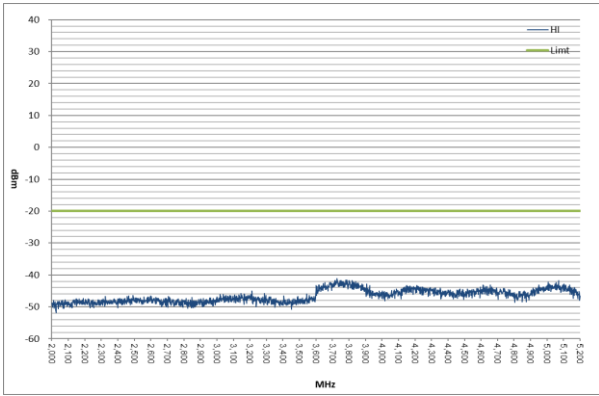

11K0F3E
 9 KHz to Fc

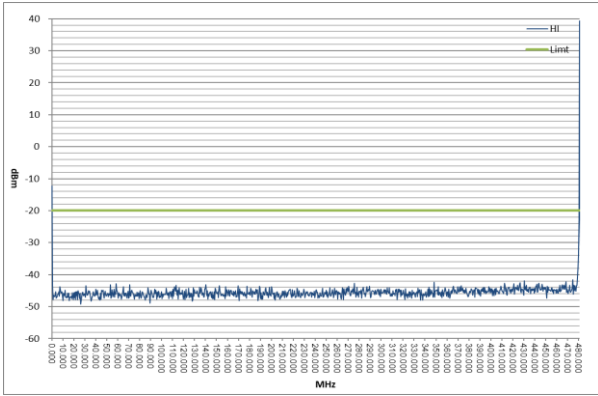

Hi Power
 Fc= 481.05 MHz
 Fc to 2Fc

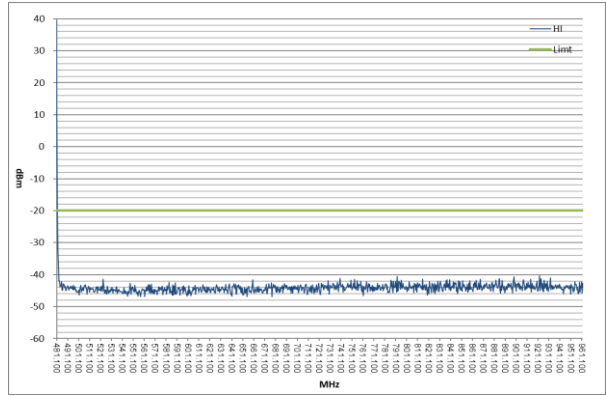

2Fc to 1GHz

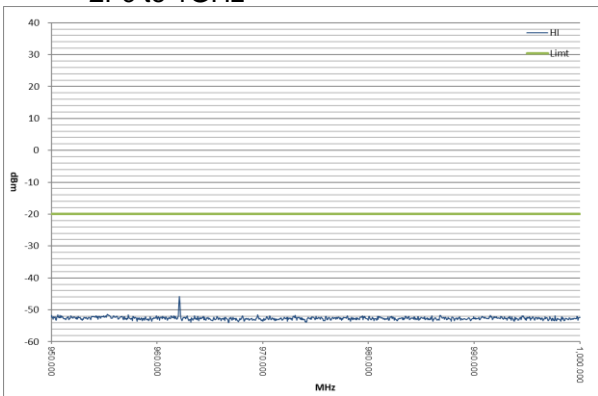

1GHz to 2GHz

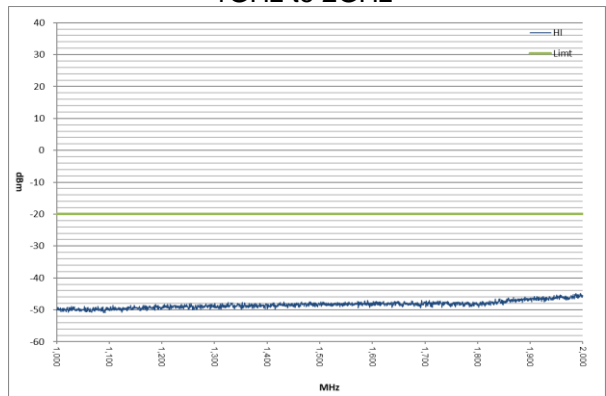

2GHz to 10Fc

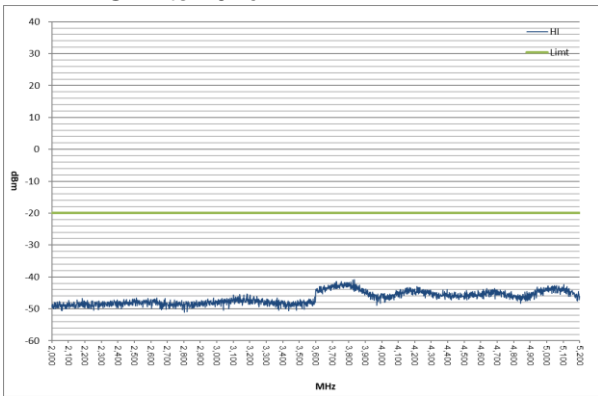

11K0F3E
9 KHz to Fc

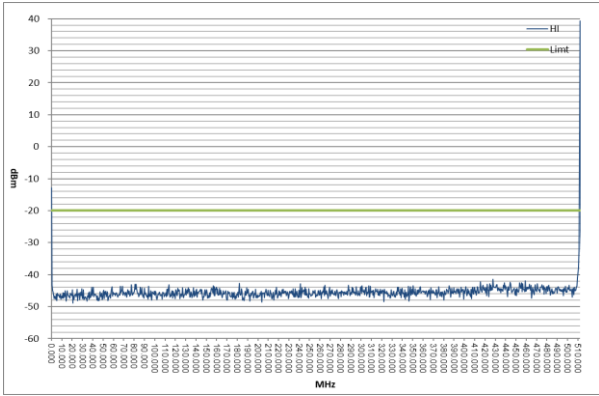

Hi Power
Fc= 511.95 MHz
Fc to 1GHz

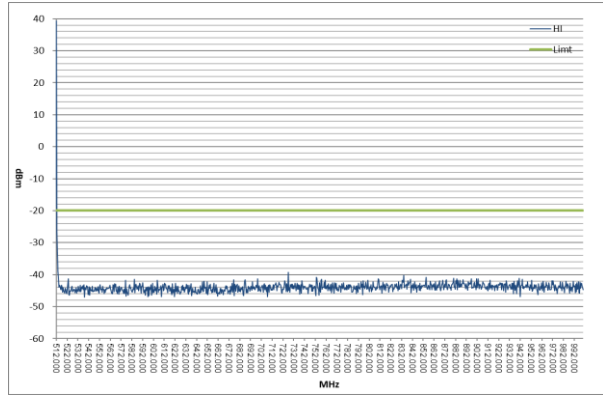

1GHz to 2Fc

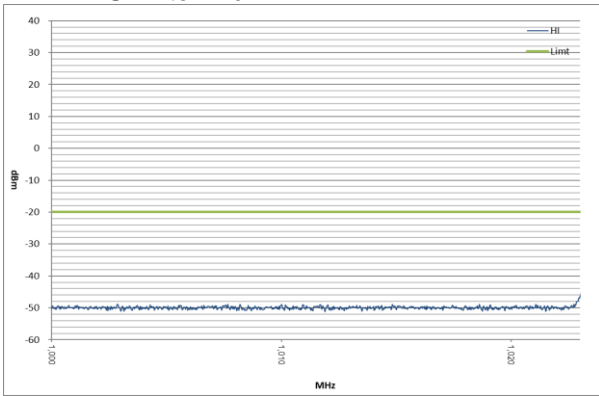

1GHz to 2GHz

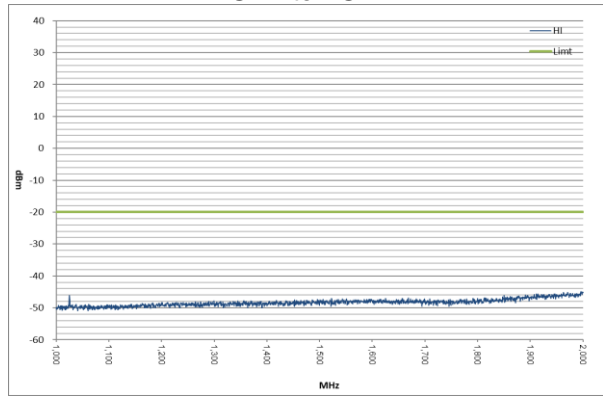

2GHz to 10Fc

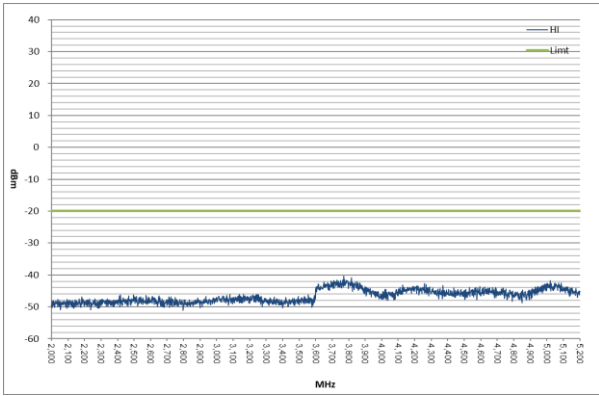

11K0F3E
 9 KHz to Fc

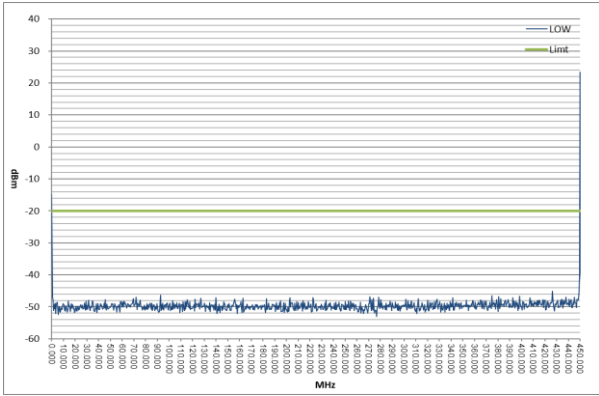

Low Power Fc= 450.05 MHz
 Fc to 2Fc

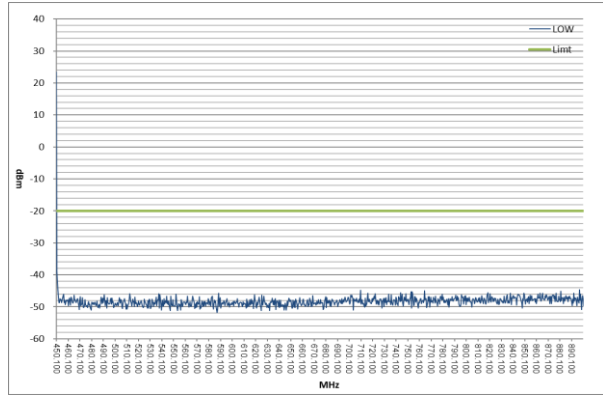

2Fc to 1GHz

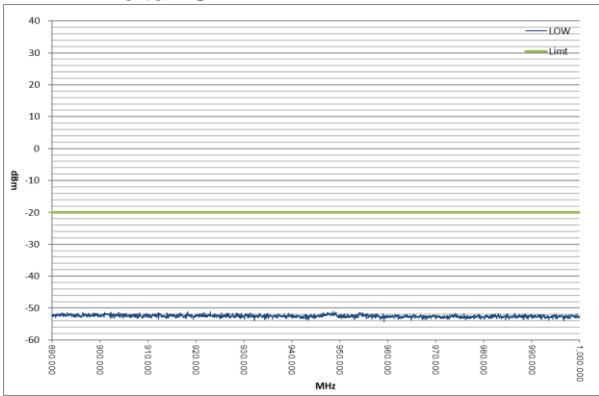

1GHz to 2GHz

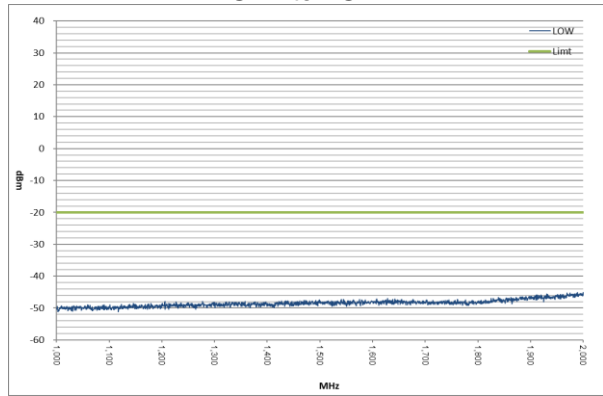

2GHz to 10Fc

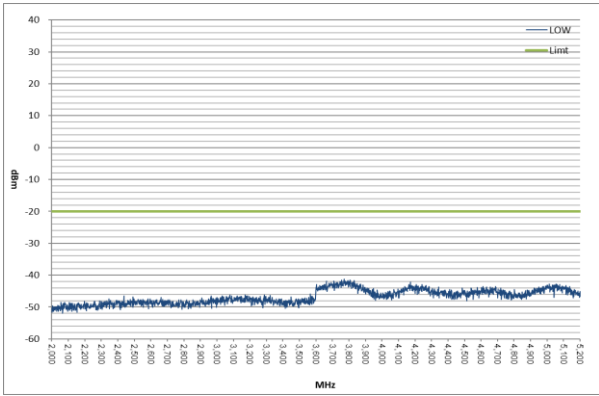

11K0F3E
9 KHz to Fc

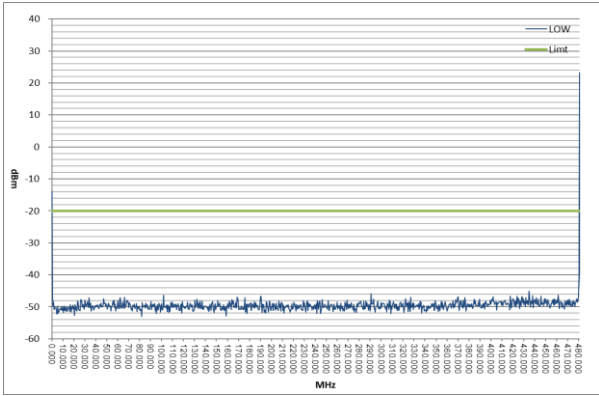

Low Power Fc= 481.05 MHz
Fc to 2Fc

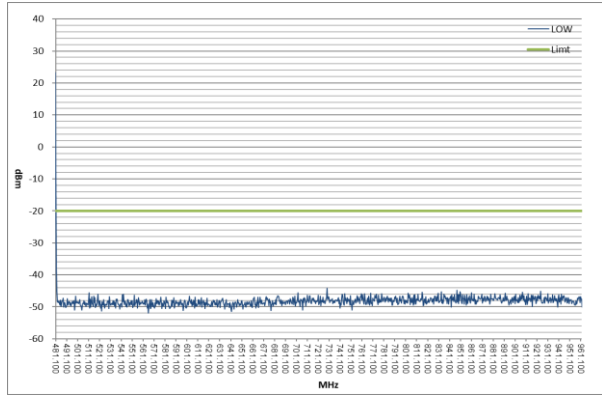

2Fc to 1GHz

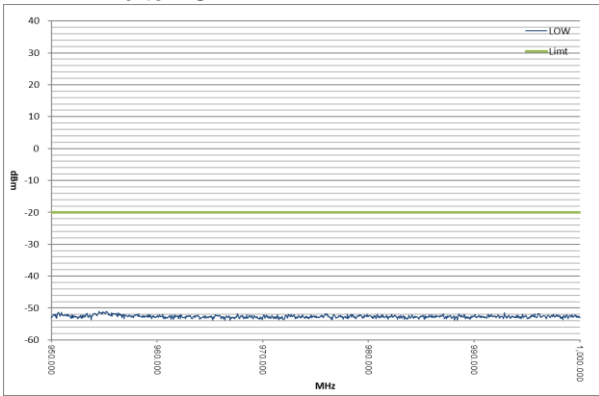

1GHz to 2GHz

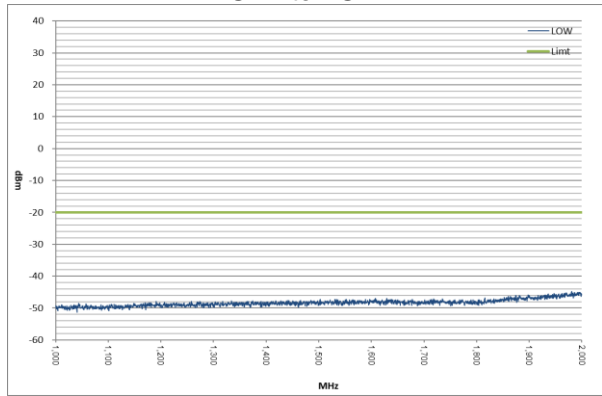

2GHz to 10Fc

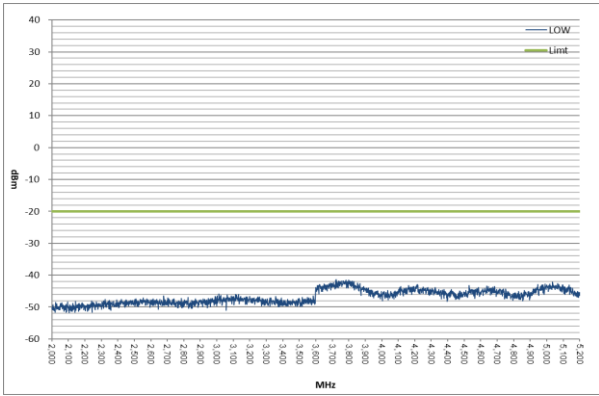

11K0F3E
9 KHz to Fc

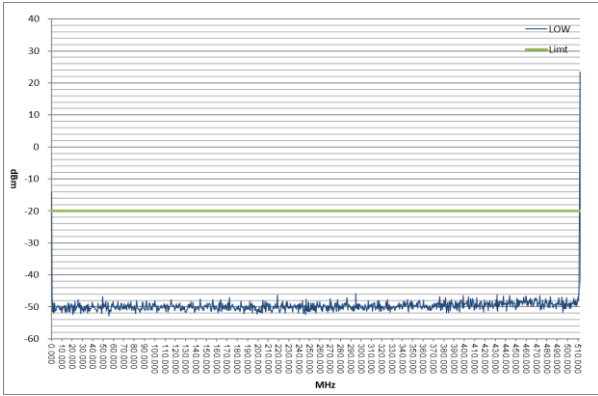

Low Power Fc= 511.95 MHz
Fc to 1GHz

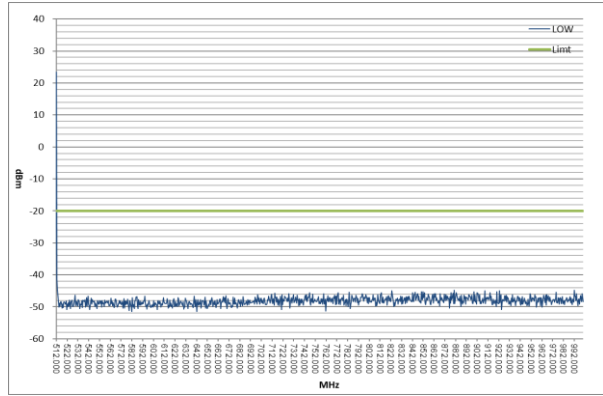

1GHz to 2Fc

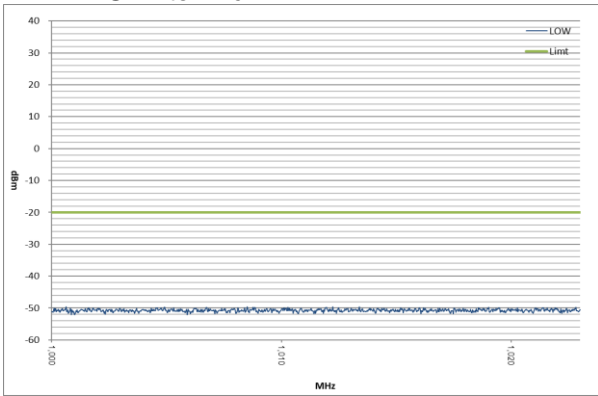

1GHz to 2GHz

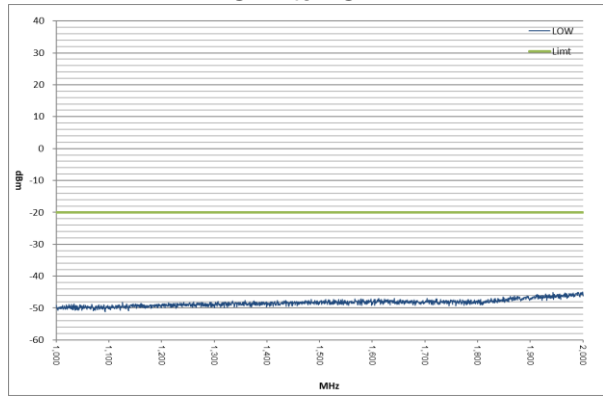

2GHz to 10Fc

