



TEST REPORT

REGULATION : FCC Part 2, 90
 RSS-119 Issue 12

Applicant	Testing Laboratory
JVC KENWOOD Corporation 1-16-2, Hakusan, Midori-ku, Yokohama-shi Kanagawa, 226-8525 Japan Tel.: +81 45 939 6254 Fax.: +81 45 939 6261	Intertek Japan K.K. Kashima Laboratory URL: http://www.japan.intertek-etlsemko.com (No.12 Test site) 298-6 Sada, Kashima, Ibaraki 314-0027 Japan Tel. +81 299 82 8464

Equipment type	800MHz DIGITAL TRANSCEIVER
Trademark	KENWOOD
FCC Model(s)	NX-3920G-K
IC Model(s)	NX-3920G-K
Serial No.	B8690006
FCC ID	B8960004 (for Receiver Spurious Emissions(Radiated))
IC CN and UPN	K44502600
Test Result	282F-502600
Report Number	Complied
Original Issue Date	18110225JKA-002
	December 19, 2018

This report is for the exclusive use of Intertek's Client and is provided pursuant to the agreement between Intertek and its Client. Intertek's responsibility and liability are limited to the terms and conditions of the agreement. Intertek assumes no liability to any party, other than to the Client in accordance with the agreement, for any loss, expense or damage occasioned by the use of this report. Only the Client is authorized to permit copying or distribution of this report and then only in its entirety. (This test report shall not be reproduced except in full, without written approval of Intertek Japan K. K.) Any use of the Intertek name or one of its marks for the sale or advertisement of the tested material, product or service must first be approved in writing by Intertek. The observations and test results in this report are relevant only to the sample tested. This report by itself does not imply that the material, product, or service is or has ever been under an Intertek certification program.

Approved by

Hideaki Kosemura

[Technical Manager]

Tested by

Koichi Wagatsuma

[Engineer]



In Accordance with FCC Rules and Regulations, Volume II, Part 2 and 90**Sub-part 2.1033**

Applicant and Manufacture Information	
APPLICANT	
Company	: JVC KENWOOD Corporation
Address	: 1-16-2, Hakusan, Midori-ku, Yokohama-shi Kanagawa, 226-8525 Japan
Contact Person	: Tamaki Shimamura Manager, Communications Systems Devision
MANUFACTURER	
Company	: JVC KENWOOD Corporation
Address	: 1-16-2, Hakusan, Midori-ku, Yokohama-shi Kanagawa, 226-8525 Japan
(c)(2) FCC ID	
FCC ID	: K44502600
Model number	: NX-3920G-K
Serial number	: B8690006
Instruction Manual(S)	
Instruction manual(s)	: Please refer to attached Exhibits F
Type of Emission	
Emission Designation	: 16K0F3E(Wide) 14K0F3E(Wide) 11K0F3E(Narrow) 8K30F1E(Narrow) / 8K30F1D(Narrow) / 8K30F7W(Narrow) 7K60FXD(Narrow) / 7K60FXE(Narrow) 4K00F1E(Very Narrow) / 4K00F1D(Very Narrow) / 4K00F7W(Very Narrow) 4K00F2D(Very Narrow)
Frequency range	
Frequency Range	: TX : 806 to 824 and 851 to 869 MHz RX : 851 to 869 MHz
Power Rating	
Output Power	: 5 to 15 W
Type	: Continuously Variable
Maximum Power Rating	
Output Power	: 15 W
Voltages & currents in all elements in final RF stage, including final transistor or solid-state device	
Collector Current, A	: 13.0 A Maximum
Collector Voltage, Vdc	: 13.6 Vdc
Supply Voltage, Vdc	: 13.6 Vdc
Other Information	
Number of Channel	: Zone 128max. Cannels 250 max.(per Zone)
Maximum Deviation	: ± 5 kHz (16K0F3E), ± 4 kHz (14K0F3E), ± 2.5 kHz (11K0F3E)
Frequency Stability	: 0.4 ppm
Antenna Impedance	: 50 Ω Norminal
Note	

TABLE OF CONTENTS

	Page
SECTION 1. GENERAL INFORMATION	4
SECTION 2. SUMMARY OF TEST RESULT	5
SECTION 3. TEST AND MEASUREMENT DATA	6
SECTION 4. INFORMATION ABOUT EUT AND SUPPORT EQUIPMENT(S)	7
SECTION 5. SUPPORT EQUIPMENT	8
SECTION 6. USED CABLE(S)	9
SECTION 7. TEST CONFIGURATION	10
SECTION 8. OPERATING CONDITION	11
SECTION 9. MEASUREMENT UNCERTAINTY	12
SECTION 10. TEST DATA	
10.1 Carrier Output Power (Conducted)	13
10.2 Unwanted Emissions (Transmitter Conducted)	16
10.3 Field Strength of Spurious Radiation	19
10.4 Emission Masks (Occupied Bandwidth)	25
10.5 Audio Frequency Response / Audio Low Pass Filter (Voice Input)	62
10.6 Modulation Limiting	68
10.7 Frequency Stability (Temperature Variation)	76
10.8 Frequency Stability (Voltage Variation)	80
10.9 Receiver Spurious Emissions(Radiated)	82
10.10 Necessary Bandwidth and Emission Bandwidth	86
10.11 99% Occupied Bandwidth	88
APPENDIX PHOTOGRAPHS	

SECTION 1. GENERAL INFORMATION

TEST PERFORMED

Location	Kashima No.12 Test Site		
EUT Received	November 16, 2018		
Date of Test	November 16, 2018	to	December 12, 2018
Standard Applied	FCC Part 2, 90 RSS-119 Issue 12		
Measurement Method	ANSI/TIA-603-E-2016 / RSS-119 Issue 12, RSS-Gen Issue 5		
Deviation from Standard(s)	Not applicable		

QUALIFICATIONS OF TESTING LABORATORY (Kashima Lab.)

ACCREDITATION	SCOPE	LAB. CODE	Remarks
VLAC	EMC Testing	VLAC-008-1	JAPAN
FILING			
VCCI	EMC Testing	A-0126	JAPAN
FCC	EMC Testing	JP0008	
IC	EMC Testing	IC-2042Q-12	CANADA
CB-Scheme	EMC Testing	TL222	IECEE

ABBREVIATIONS

EUT	Equipment Under Test	DoC	Declaration of Conformity
AMN	Artificial Mains Network	ISN	Impedance Stabilization Network
LISN	Line Impedance Stabilization Network	Q-P	Quasi-peak
AMP	Amplifier	AVG	Average
ATT	Attenuator	PK	Peak
ANT	Antenna	Cal	Calibration
BBA	Broadband Antenna	N/A	Not applicable or Not available
DIP	Dipole Antenna	LCD	Liquid-Crystal Display
AE	Associated Equipment	4LEVEL FSK	4LEVEL Frequency Shift Key
GMSK	Gaussian Maximum Shift Key	CW ID	Continuously Repeating bit stream
FM	Frequency Modulation	C4FM	Constant envelope 4 Level FM
PTT	Push to Talk	AFC	Automatic frequency control

Revision Summary

Revised Date	Section	Description of Changes

SECTION 2. SUMMARY OF TEST RESULT

FCC Part2	Part90	IC RSS-119	TEST ITEM	RESULTS	Comments
2.1046 (a)	-	5.4	Carrier Output Power (Conducted)	PASS	
2.1051	90.210	5.8	Unwanted Emissions (Transmitter Conducted)	PASS	
2.1053 (a)	90.210	5.8	Field Strength of Spurious Radiation	PASS	
2.1049 (c) (1)	90.210	5.5	Emission Masks (Occupied Bandwidth)	PASS	
-	90.214	5.9	Transient Frequency Behavior	PASS	
2.1047 (a)	-	-	Audio Low Pass Filter (Voice Input)	PASS	
2.1047 (a)	-	-	Audio Frequency Response	PASS	
2.1047 (b)	-	-	Modulation Limiting	PASS	
2.1055 (a) (1)	90.213 (a)	5.3	Frequency Stability (Temperature Variation)	PASS	
2.1055 (d) (1)	90.213 (a)	5.3	Frequency Stability (Voltage Variation)	PASS	
-	-	RSS-Gen 7.1	Receiver Spurious Emissions	PASS	
-	90.203 (e)	-	Certification required (FCC Part 90.203(e))	Complied	
-	-	5.5	99% Occupied Bandwidth	PASS	

Limitation on Results

The test result of this report is effective equipment under test itself and under the test configuration described on the report.

This test report does not assure that whether the test result taken in other testing laboratory is compatible or reproducible to the test result on this report or not.

Note:

As for the FCC Part 15 Subpart B-Unintentional Radiators, the EUT has been measured and declared as SDoC by JVC Kenwood Corporation.

SECTION 3. TEST AND MEASUREMENT DATA

All test and measurements indicated in this document were performed in accordance with the Code of Federal Regulations Title 47 Part 2, Sub-part J and Industry Canada as the following individual parts:

FCC Rule	Test Item	Tested
Part 90	Private Land Mobile radio Services	YES

IC Rule	Test Item	Tested
RSS-119	Radio Ttansmitters and Receivers Operating in the Land Mobile and Fixed Services in the Frequency Range 27.4-960 MHz	YES
RSS-Gen	General Requirements for Compliance of Radio Apparatus	YES

SECTION 4. INFORMATION ABOUT EUT AND SUPPORT EQUIPMENT(S)**4.1 List of System Configuration**

Symbol	Item	Model No.	Serial No.	Manufacture	Remarks
A	800MHz DIGITAL TRANSCEIVER	NX-3920G-K	B8690006 B8960004 (for Receiver Spurious Emissions(Radiated))	JVC KENWOOD Corporation	EUT
Power Ratings of EUT :			DC 13.6V \pm 15%	13.0 A Maximum	
Power Supply :			DC 13.6 V		
Condition of Equipment			Proto type		
Type			Mobile type		
Suppression Devices			No Modifications by the laboratory were made to the device		

4.2 Port(s)/Connector(s)

Port Name	Connector	Connector Pin	Remarks
ACC	D-sub	15 pin	
External Speaker	3.5 ϕ	2 pin	
RF Antenna	N	2 pin	
GPS Antenna	SMA	2 pin	
Microphone	RJ-45	8 pin	

4.3 Highest Frequency Oscillator(s)/Crystal(s)

Operating Frequency	Board Name	Remarks
1738 MHz	TXRX UNIT	
4960 MHz	Bluetooth UNIT	
3142.648 MHz	GPS UNIT	

SECTION 5. SUPPORT EQUIPMENT

The EUT was supported by the following equipment during the test.

Symbol	Item	Model No.	Serial No.	Manufacture	FCC ID
B	Panel Separate Kit	KRK-18H	04	JVC KENWOOD	DoC
C	Panel Separate Kit	KRK-19B	04	JVC KENWOOD	DoC
D	GPS Antenna	KRA-40G	No.2	JVC KENWOOD	N/A
E	External Speaker	KES-3	No.2	JVC KENWOOD	N/A
F	Dummy Load	CT-03NP	1037408	TME	N/A
G	DC Power Supply	PMC35-3A	LE000716	KIKUSUI	N/A
H	Keypad Microphone	KMC-36	No.01	JVC KENWOOD	N/A
I	Hands-free Microphone Kit	KCT-73MIC	None	JVC KENWOOD	N/A
J	Hands-free PTT Kit	KCT-74PTT	None	JVC KENWOOD	N/A
Supplied Power:					
G	AC	100V,60Hz			

SECTION 6. USED CABLE(S)

The following cable(s) was used for the test.

No.	Name	Length (m)	Shield	Metal	
				Connector	Ferrite core
1	GPS Antenna cable	4.00	Yes	Yes	
2	KCT-60 (Connection cable)	0.30	No	No	
3	KCT-18 (Ignition sense cable)	3.10	No	No	
4	Speaker cable	2.90	No	No	
5	DC cable	0.25	No	No	
6	KCT-71M3 (Connection Cable)	7.60	Yes	No	
7	KCT-72 (Remote Control Cable)	0.30	Yes	No	
8	Mic. Cable	0.55	No	No	
9	DC cable	3.00	No	No	
10	Mic. Cable (KCT-73MIC)	3.00	No	No	
11	PTT. Cable (KCT-74PTT)	3.00	No	No	
12	Power cable for DC Power Supply (3 core)	0.80	No	No	

SECTION 7. TEST CONFIGURATION

Details of Configuration and Connection

Example: Case of Section 10.3 Test

- * : EUT
- : Ferrite core
- : Joint Connector

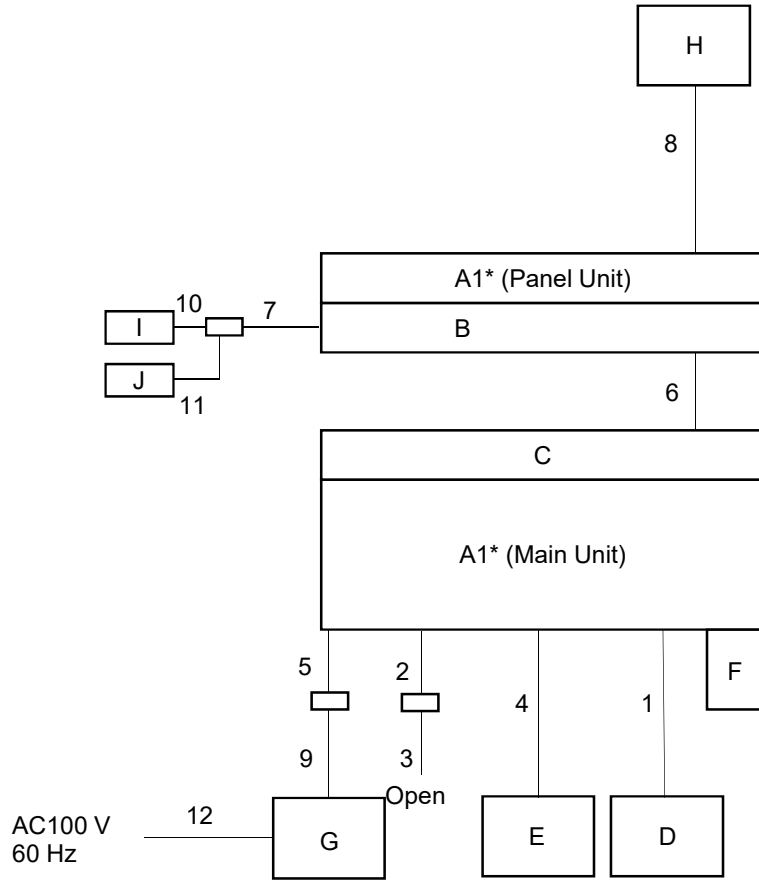

SECTION 8. OPERATING CONDITION

The EUT was operated under the following condition during the test.

8.1 Operating Condition

The test was carried out under Transmit mode.

: 806.05 MHz, 815.05 MHz, 823.95 MHz, 851.05 MHz, 860.05 MHz, 868.95 MHz

: High Power : 15W, Low Power : 5W

The test was carried out under Receive mode.

: 851.05 MHz, 860.05 MHz, 868.95 MHz

EUT was examined in the operating conditions that had maximum emissions.

8.2 Operating Flow [Transmit mode]

Following operations were performed continuously.

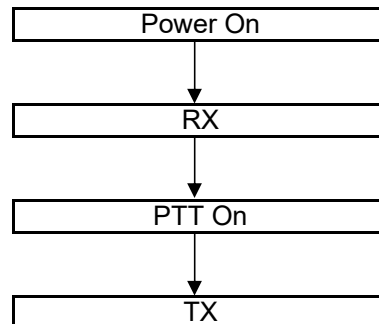

8.3 Operating Flow [Receive mode]

Following operations were performed continuously.

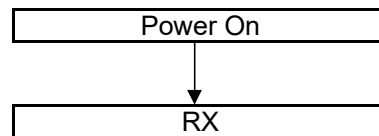

SECTION 9. MEASUREMENT UNCERTAINTY

Carrier Output Power (Conducted)	U _{lab}	Utia-603-d
	+/- 0.29dB (k = 2)	+/- 0.59 dB
Unwanted Emissions (Transmitter Conducted)		
	+/- 2.19 dB (k = 2)	+/- 1.1 dB
Field Strength of Spurious Radiation		
	+/- 2.78dB (k = 2)	+/- 3.3 dB
Emission Masks (Occupied Bandwidth)		
	+/- 0.5dB (k = 2)	+/- 2.1 dB
Transient Frequency Behavior		
	+/- 1.10% (k = 2)	+/- 21.6 %
Audio Low Pass Filter (Voice Input)		
	+/- 0.1dB (k = 2)	+/- 1.2 dB
Audio Frequency Response		
	+/- 0.1dB (k = 2)	+/- 1.2 dB
Modulation Limiting		
	+/- 1% (k = 2)	+/- 1.0 %
Frequency Stability (Temperature Variation)		
	+/- 10.1Hz (k=2)	+/-34.2 Hz
Frequency Stability (Voltage Variation)		
	+/- 10.1Hz (k=2)	+/-34.2 Hz
Receiver Spurious Emissions	U _{lab}	Ucisp
30-1000MHz	+/- 4.38dB (k = 2)	+/- 6.3 dB
abobe 1GHz	+/- 4.33dB (k = 2)	+/- 5.2 dB
Bandwidth		
	+/- 1.02% (k = 2)	-

SECTION 10. TEST DATA

10.1 Carrier Output Power (Conducted)

REGULATIONS	: FCC Part 2 Section 1046 (a) / RSS-119 Section 5.4
TEST METHOD/GUIDE	: ANSI/TIA-603-E Section 2.2.1.2 / RSS-119 Section 4.1

Test Procedure

- 1 The EUT and test equipment were set up as shown on the following page.
- 2 The EUT was conducted to a resistive coaxial attenuator of normal load impedance.
 $RF\ Power\ (dBm) = Power\ Meter\ reading\ (dBm) + Attenuator\ Loss\ (dB) + Cable\ Loss\ (dB)$
 $RF\ Power\ (W) = 10^{(RF\ Power\ (dBm)/10)}/1000$
- 3 Modulate the transmitter with a 2.5 kHz sine wave at an input Level of 16 dB greater than that necessary to produce 50 % of rated system deviation.(Only as for the test of RSS)

Measuring Equipments

No.	Equipment	Manufacture	Model No.	Serial No.	Cal. Interval	Effective period
1	Power Meter	Hewlett Packard	E4418B	GB38410265	1Y	Sep. 30, 19
2	Power Sensor	Hewlett Packard	8482A	US37292237	1Y	Sep. 30, 19
3	Attenuator (20dB)	Aeroflex/Wenshel	66-20-34	BY4357	1Y	Jul. 31, 19
4	Attenuator (30dB)	Weinschel	WA-29-30-34	8924	1Y	Jul. 31, 19
5	Modulation Analyzer	Hewlett Packard	8901B	3403A04852	1Y	Dec. 31, 18
6	Audio Generator	Anritsu	MG443B	M70150	1Y	Sep. 30, 19
7	DC Power Supply	Daiichi denpa kogyo	GZV4000	90290931	None	None
8	Digital Multi Meter	FLUKE	8846A	9642018	1Y	Sep. 30, 19

Measuring Cables

No.	Cable	Manufacturer	Model No.	Serial No.	Cal. Interval	Effective period
W2	Balance Cable	Nicoon	3D-2V	KSR00092	1Y	Feb. 28, 19
W3	Coaxial Cable	Pacific custom	RG-58 C/U	AM90C04	1Y	Feb. 28, 19

Measuring Equipment Configuration

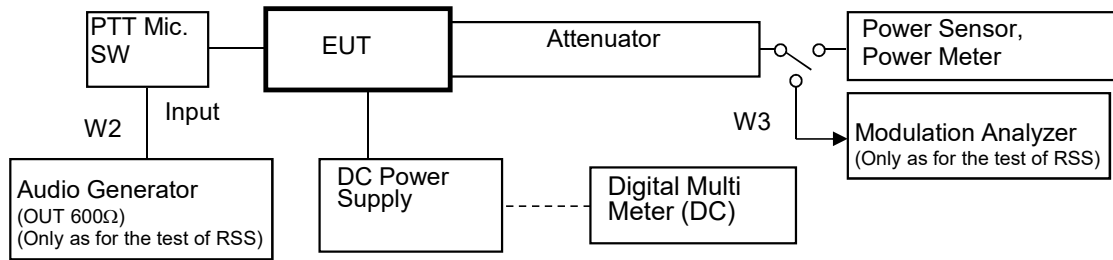

Note: Configuration of other Modulation test is composed without the Audio Generator.

Test Results

Test date	Nov. 16, 2018		
Location	Kashima No.12 Test Site		
temperature	26.4		[degree C]
Humidity Variation	45.0		[%]
Atmospheric Pressure	101.5		[kPa]
Test Engineer	Koichi Wagatsuma		

Test was carried out for all the Authorized Bandwidth.
 State the worst case (below).

No.	Frequency (MHz)	Band		Setting	RF Power (W)
1	806.05	Low	Band 1	High Power	15
2	815.05	Middle	Band 1	High Power	15
3	823.95	High	Band 1	High Power	15
4	851.05	Low	Band 2	High Power	15
5	860.05	Middle	Band 2	High Power	15
6	868.95	High	Band 2	High Power	15
7	806.05	Low	Band 1	Low Power	5
8	815.05	Middle	Band 1	Low Power	5
9	823.95	High	Band 1	Low Power	5
10	851.05	Low	Band 2	Low Power	5
11	860.05	Middle	Band 2	Low Power	5
12	868.95	High	Band 2	Low Power	5

RF Power: Peak reading

10.2 Unwanted Emissions (Transmitter Conducted)

REGULATIONS	: FCC Part 2 Section 1051, Part 90 Section 210 / RSS-119 Section 5.8
TEST METHOD/GUIDE	: ANSI/TIA-603-E Section 2.2.13.2 / RSS-119 Section 4.2

Test Procedure

- 1 The EUT and test equipment were set up as shown on the following page.
- 2 Modulate the transmitter with a 2.5 kHz sine wave at an input Level of 16 dB greater than that than that necessary to produce 50 % of rated system deviation.
- 3 Adjust the spectrum analyzer for the following setting:
 - a) RBW : 100 kHz (< 1 GHz), 1 MHz (> 1 GHz).
 - b) VBW : 300 kHz (< 1 GHz), 3 MHz (> 1 GHz).
 - c) Detector mode : Average power (FM Modulation) , Positive peak with peak hold (Digital Modulation)
- 4 The emissions were measured for the worst case as follows:
 - a) : within a band of frequencies defined by the carrier frequency plus and minus one channel.
 - b) : from the lowest frequency generated in the EUT and to at least the 10th harmonic of the carrier frequency, or 40 GHz, whichever is lower.

Measuring Equipments

No.	Equipment	Manufacture	Model No.	Serial No.	Cal. Interval	Effective period
1	Attenuator (20dB)	Aeroflex/Wenshel	66-20-34	BY4357	1Y	Jul. 31, 19
2	Attenuator (30dB)	Weinschel	WA-29-30-34	8923	1Y	Jul. 31, 19
3	Highpass Filter	TME	UHP-127	1511798E	1Y	Jul. 31, 19
4	Modulation Analyzer	Hewlett Packard	8901B	3403A04852	1Y	Dec. 31, 18
5	Signal Generator	Rohde&Schwarz	SMP02	845275/007	1Y	Jul. 31, 19
6	Audio Generator	Anritsu	MG443B	M70150	1Y	Sep. 30, 19
7	Spectrum Analyzer	Agilent	N9030A	US51350220	1Y	Mar. 31, 19
8	DC Power Supply	Daiichi denpa kogyo	GZV4000	90290931	None	None
9	Digital Multi Meter	FLUKE	8846A	9642018	1Y	Sep. 30, 19

Measuring Cables

No.	Cable	Manufacture	Model No.	Serial No.	Cal. Interval	Effective period
W3	Balance Cable	Nicoon	3D-2V	KSR00092	1Y	Feb. 28, 19
W4	Coaxial Cable	Pacific custom	RG-58 C/U	AM90C04	1Y	Feb. 28, 19
W2	Coaxial Cable	Suhner	SUCOFLEX104	F0000017	1Y	Jul. 31, 19

Measuring Equipment Configuration

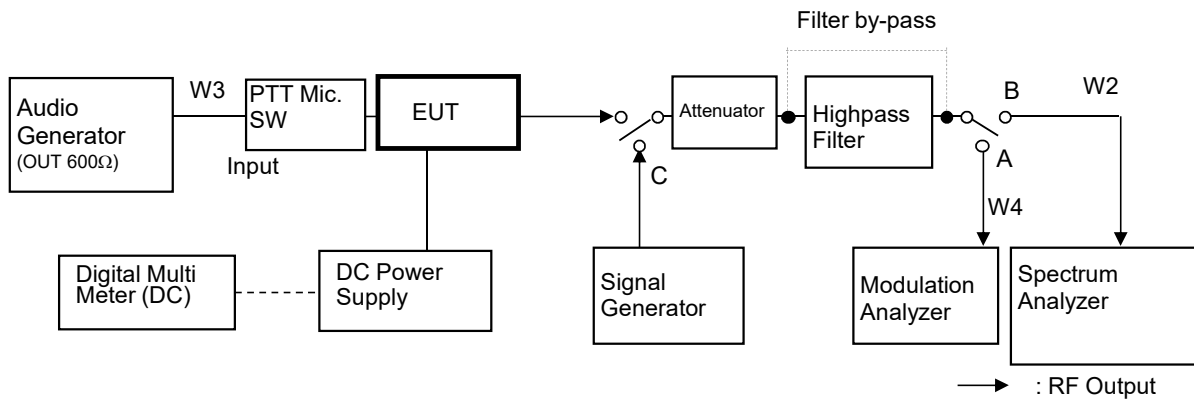

Note: Configuration of other Modulation test is composed without the Audio Generator.

Test Results

Test date	Nov. 20, 2018	and	Nov. 21, 2018
Location	Kashima No.12 Test Site		
temperature	20.0	to	26.0 [degree C]
Humidity Variation	50.0	to	62.0 [%]
Atmospheric Pressure	101.2	to	101.6 [kPa]
Test Engineer	Koichi Wagatsuma		

Test was carried out for all the frequency band of section 10.1
 State the worst case (below).

State : High Power / Authorized Bandwidth FCC: 20 kHz, RSS: 6 kHz (Band 1 / Band 2)

No.	Tuned Frequency (MHz)	Band	Spurious Frequency (MHz)	Correct Level (dBm)	Emission Level (dBc)	Mask H/G/EA Limit (dBc)	Mask E Limit (dBc)	Margin (Worst) (dB)
1	806.05	Low	1612.10	-30.28	-72.04	-54.8	-65.0	7.0
2	815.05	Middle	1630.10	-31.08	-72.84	-54.8	-65.0	7.8
3	823.95	High	1647.90	-32.14	-73.90	-54.8	-65.0	8.9
4	851.05	Low	1702.10	-32.76	-74.52	-54.8	-65.0	9.5
5	860.05	Middle	1720.10	-32.53	-74.29	-54.8	-65.0	9.3
6	868.95	High	1737.90	-32.86	-74.62	-54.8	-65.0	9.6

There is the margin of 20dB over except for the above points.

Mask B/H/G/EA Limit(dBc)=-43+10Log(P)

Mask E Limit (dBc) = whichever is the lesser attenuation ; -(55+10Log(P)) or -65

Correct Level (dBm) = Substitute SG Level (dBm)

Emission Level (dBc) = Correct Level (dBm) - 10Log(P*1000)

P = Carrier Level (W)

" - " = Measurement Limit

State : Low Power / Authorized Bandwidth FCC: 20 kHz, RSS: 6 kHz (Band 1 / Band 2)

No.	Tuned Frequency (MHz)	Band	Spurious Frequency (MHz)	Correct Level (dBm)	Emission Level (dBc)	Mask G Limit (dBc)	Mask J Limit (dBc)	Margin (Worst) (dB)
1	806.05	Low	1612.10	-30.94	-67.93	-50.0	-62.0	5.9
2	815.05	Middle	1630.10	-31.45	-68.44	-50.0	-62.0	6.4
3	823.95	High	1647.90	-32.28	-69.27	-50.0	-62.0	7.3
4	851.05	Low	1702.10	-32.92	-69.91	-50.0	-62.0	7.9
5	860.05	Middle	1720.10	-32.95	-69.94	-50.0	-62.0	7.9
6	868.95	High	1737.90	-33.41	-70.40	-50.0	-62.0	8.4

There is the margin of 20dB over except for the above points.

Mask B/H/G/EA Limit(dBc)=-43+10Log(P)

Mask E Limit (dBc) = whichever is the lesser attenuation ; -(55+10Log(P)) or -65

Correct Level (dBm) = Substitute SG Level (dBm)

Emission Level (dBc) = Correct Level (dBm) - 10Log(P*1000)

P = Carrier Level (W)

" - " = Measurement Limit

10.3 Field Strength of Spurious Radiation

REGULATIONS	:	FCC Part 2 Section 1053 (a), Part 90 Section 210 / RSS-119 Section 5.8
TEST METHOD/GUIDE	:	ANSI/TIA-603-E Section 2.2.12.2 / RSS-119 Section 4.2

Test Procedure

- 1 The EUT and test equipment were set up as shown on the following page.
- 2 Adjust the spectrum analyzer for the following setting:
 - a) RBW : 100 kHz (< 1 GHz), 1 MHz (> 1 GHz).
 - b) VBW : 300 kHz (< 1 GHz), 3 MHz (> 1 GHz).
 - c) Detector mode : Positive Peak
- 3 The transmitter was placed on a wooden turntable, and it was transmitting into non-radiating load which was also placed on the turntable.
- 4 During the tests, the antenna height and polarization as well as EUT azimuth were varied in order to identify the maximum level of emissions from the EUT.
- 5 The frequency range up to tenth harmonic of the fundamental frequency was investigated.
- 6 Remove the EUT and replace it with substitution antenna. A signal generator was connected to the substitution antenna by a non-radiating cable.
 The absolute levels of the spurious emissions were measured by the substitution.
- 7 Spurious emissions in dB = 10 Log (TX power in Watts/0.001) – the absolute level

Measuring Equipments

No.	Equipment	Manufacture	Model No.	Serial No.	Cal. Interval	Effective period
1	Attenuator(10dB)	HUBER+SUHNER	6810.17B	5061	1Y	Jan. 31, 19
2	Dummy Load	TME	CT-150NP	1138693	1Y	Feb. 28, 19
3	Signal Generator	Rohde&Schwarz	SMP02	845275/007	1Y	Jul. 31, 19
4	Spectrum Analyzer	Agilent	N9030A	US51350220	1Y	Mar. 31, 19
5	D.R.G Antenna(TX)	Schwarzbeck	3115	5044	1Y	Apr. 30, 19
6	D.R.G Antenna(RX)	Schwarzbeck	3115	5045	1Y	Apr. 30, 19
7	Dipole Antenna(TX)	Schwarzbeck	UHA9105	AM0082002	1Y	May. 31, 19
8	Dipole Antenna(TX)	Schwarzbeck	VHA9103	C01082007	1Y	May. 31, 19
9	Tri-log Antenna(RX)	Schwarzbeck	VULB9168WP	288	1Y	Jul. 31, 19
10	DC Power Supply	Daiichi denpa kogyo	GZV4000	90290931	None	None
11	Digital Multi Meter	FLUKE	8846A	9642018	1Y	Sep. 30, 19
12	Amplifier	TOYO	TPA0118-30	0402	1Y	May. 31, 19
13	Attenuator	HUBER + SUHNER	6803.17.B	5111	1Y	May. 31, 19
14	Amplifier	Intertek Japan	ZX60-3018G	002	1Y	Aug. 31, 19
15	Attenuator	TAMAGAWA	CFA-01	A00040805	1Y	Aug. 31, 19
16	RF Switch	Intertek Japan	ACX-150-1	A12301501	1Y	Aug. 31, 19

Measuring Cables

No.	Cable	Manufacturer	Model No.	Serial No.	Cal. Interval	Effective period
R11	Coaxial Cable	FUJIKURA	5D-2W	R11	1Y	Aug. 31, 19
R1	Coaxial Cable	FUJIKURA	5D-2W	R1	1Y	Aug. 31, 19
R3	Coaxial Cable	FUJIKURA	10D-2W	R3	1Y	Aug. 31, 19
R5	Coaxial Cable	FUJIKURA	RG-5A/U	R5	1Y	Aug. 31, 19
R7	Coaxial Cable	MIYAZAKI	5D-2W	R7	1Y	Aug. 31, 19
R10	Coaxial Cable	FUJIKURA	5D-2W	R10	1Y	Aug. 31, 19
R13	Coaxial Cable	SUHNER	SUCOFLEX 104	229603	1Y	May. 31, 19
R12	Coaxial Cable	Candox	5B-048-98-98-5000	111130	1Y	May. 31, 19
W13	Coaxial Cable	Suhner	SUCOFLEX106	KSR00207	1Y	Jan. 31, 19

Measuring Equipment Configuration

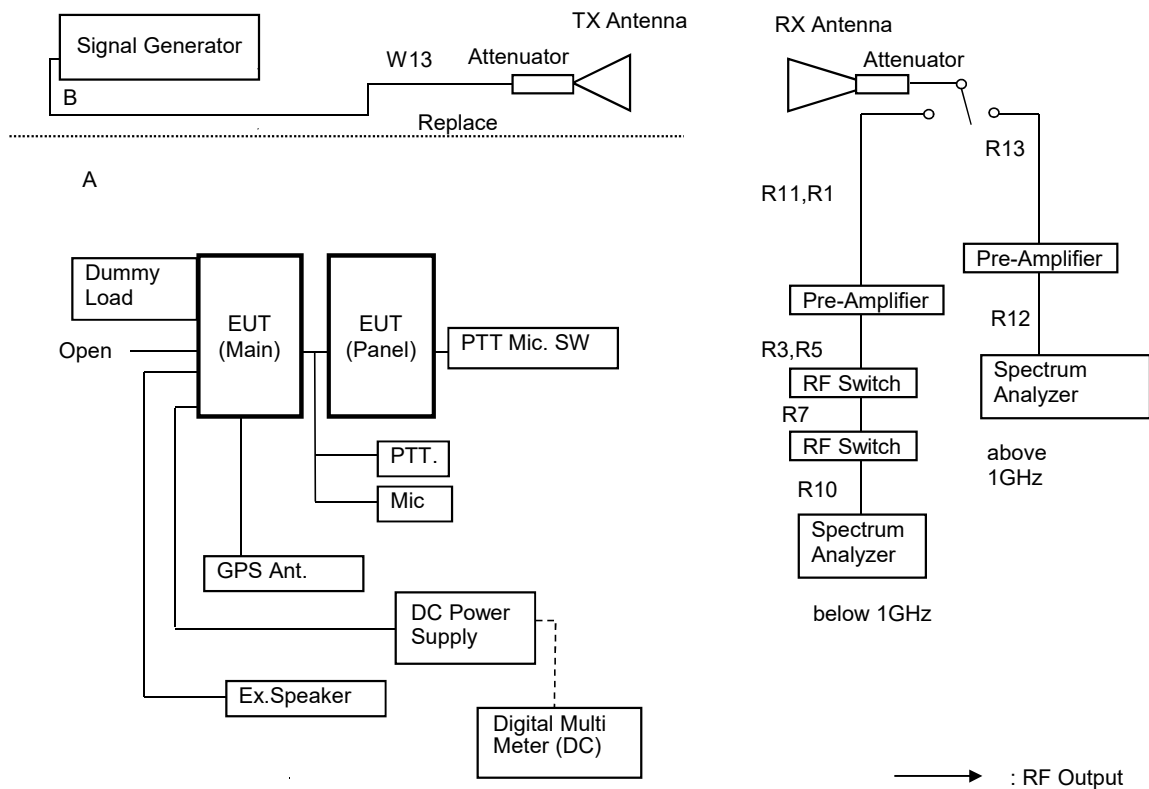

Test Results

Test date	Nov 26, 2018	to	Nov 29, 2018
Location	Kashima No.12 Test Site		
temperature	19.0 to 22.0	[degree C]	
Humidity Variation	45 to 60	[%]	
Atmospheric Pressure	101 to 108.7	[kPa]	
Test Engineer	Koichi Wagatsuma		

Test was carried out for all the frequency band of section 10.1
 State the worst case (below).

State : High Power / Authorized Bandwidth FCC: 20 kHz, RSS: 6 kHz / 823.95MHz (Band 1)

No	Frequency (MHz)	Pol	Reading Level (dBm)	SG Out Level (dBm)	Antenna		Correct Level (dBm)	Emission Level (dBc)	MASK		Margin (Worst) (dB)
					Gain (dBd)	Loss (dB)			H/G/EA Limit Level (dBc)	MASK E Limit Level (dBc)	
1	1647.90	Hor.	-53.81	-38.49	6.25	13.44	-45.7	-87.4	-54.8	-65.0	22.4
		Ver.	-54.57	-38.77	6.25	13.44	-46.0	-87.7	-54.8	-65.0	22.7
2	2471.85	Hor.	-63.77	-44.98	7.62	14.26	-51.6	-93.4	-54.8	-65.0	28.4
		Ver.	-62.13	-43.17	7.62	14.26	-49.8	-91.6	-54.8	-65.0	26.6
3	3295.80	Hor.	-63.16	-40.35	7.71	14.92	-47.5	-89.3	-54.8	-65.0	24.3
		Ver.	-62.04	-38.93	7.71	14.92	-46.1	-87.9	-54.8	-65.0	22.9
4	4119.75	Hor.	-62.31	-38.60	7.95	15.49	-46.1	-87.9	-54.8	-65.0	22.9
		Ver.	-60.78	-37.02	7.95	15.49	-44.6	-86.3	-54.8	-65.0	21.3
5	4943.70	Hor.	-52.86	-27.72	8.81	15.99	-34.9	-76.7	-54.8	-65.0	11.7
		Ver.	-52.52	-27.33	8.81	15.99	-34.5	-76.3	-54.8	-65.0	11.3
6	5767.65	Hor.	-52.08	-25.71	8.92	16.52	-33.3	-75.1	-54.8	-65.0	10.1
		Ver.	-46.38	-20.00	8.92	16.52	-27.6	-69.4	-54.8	-65.0	4.4
7	6591.60	Hor.	-68.14	-39.93	9.92	16.98	-47.0	-88.8	-54.8	-65.0	23.8
		Ver.	-65.71	-37.64	9.92	16.98	-44.7	-86.5	-54.8	-65.0	21.5
8	7415.55	Hor.	-67.96	-36.97	9.25	17.39	-45.1	-86.9	-54.8	-65.0	21.9
		Ver.	-65.44	-34.78	9.25	17.39	-42.9	-84.7	-54.8	-65.0	19.7
9	8239.50	Hor.	-68.63	-37.25	9.35	17.77	-45.7	-87.4	-54.8	-65.0	22.4
		Ver.	-66.90	-35.38	9.35	17.77	-43.8	-85.6	-54.8	-65.0	20.6

There is the margin of 20dB over except for the above points.

Mask J Limit (dBc) = $-(50+10\log(P))$

Mask E Limit (dBc) = whichever is the lesser attenuation ; $-(55+10\log(P))$ or -65

Correct Level (dBm) = Substitute SG Level (dBm) + ANT Gain (dBd) - Loss (Cable, Attenuator) (dB)

Emission Level (dBc) = Correct Level (dBm) - $10\log(P*1000)$

P = Carrier Level (W)

" - " = Measurement Limit

State : Low Power / Authorized Bandwidth FCC: 20 kHz, RSS: 6 kHz / 823.95MHz (Band 1)

No	Frequency (MHz)	Pol	Reading Level (dBm)	SG Out Level (dBm)	Antenna		Correct Level (dBm)	Emission Level (dBc)	MASK		Margin (Worst) (dB)
					Gain (dBd)	Loss (dB)			H/G/EA Limit Level (dBc)	MASK E Limit Level (dBc)	
1	1647.90	Hor.	-54.68	-39.36	6.25	13.44	-46.6	-83.5	-50.0	-57.0	26.5
		Ver.	-55.91	-40.11	6.25	13.44	-47.3	-84.3	-50.0	-57.0	27.3
2	2471.85	Hor.	-63.28	-44.49	7.62	14.26	-51.1	-88.1	-50.0	-57.0	31.1
		Ver.	-63.26	-44.31	7.62	14.26	-50.9	-87.9	-50.0	-57.0	30.9
3	3295.80	Hor.	-65.62	-42.81	7.71	14.92	-50.0	-87.0	-50.0	-57.0	30.0
		Ver.	-64.63	-41.52	7.71	14.92	-48.7	-85.7	-50.0	-57.0	28.7
4	4119.75	Hor.	-64.98	-41.26	7.95	15.49	-48.8	-85.8	-50.0	-57.0	28.8
		Ver.	-64.31	-40.55	7.95	15.49	-48.1	-85.1	-50.0	-57.0	28.1
5	4943.70	Hor.	-57.04	-31.90	8.81	15.99	-39.1	-76.1	-50.0	-57.0	19.1
		Ver.	-55.37	-30.18	8.81	15.99	-37.4	-74.4	-50.0	-57.0	17.4
6	5767.65	Hor.	-61.42	-35.05	8.92	16.52	-42.7	-79.6	-50.0	-57.0	22.6
		Ver.	-59.31	-32.94	8.92	16.52	-40.5	-77.5	-50.0	-57.0	20.5
7	6591.60	Hor.	-	-	9.92	16.98	-	-	-50.0	-57.0	-
		Ver.	-	-	9.92	16.98	-	-	-50.0	-57.0	-
8	7415.55	Hor.	-	-	9.25	17.39	-	-	-50.0	-57.0	-
		Ver.	-	-	9.25	17.39	-	-	-50.0	-57.0	-
9	8239.50	Hor.	-	-	9.35	17.77	-	-	-50.0	-57.0	-
		Ver.	-	-	9.35	17.77	-	-	-50.0	-57.0	-

There is the margin of 20dB over except for the above points.

Mask G Limit (dBc) = $-(43+10\log(P))$

Mask E Limit (dBc) = whichever is the lesser attenuation ; $-(55+10\log(P))$ or -65

Correct Level (dBm) = Substitute SG Level (dBm) + ANT Gain (dBd) - Loss (Cable, Attenuator) (dB)

Emission Level (dBc) = Correct Level (dBm) - $10\log(P*1000)$

P = Carrier Level (W)

" - " = Measurement Limit

State : High Power / Authorized Bandwidth FCC: 20 kHz, RSS: 6 kHz / 868.95MHz (Band 2)

No	Frequency (MHz)	Pol	Reading Level (dBm)	SG Out Level (dBm)	Antenna		Correct Level (dBm)	Emission Level (dBc)	MASK		Margin (Worst) (dB)
					Gain (dBd)	Loss (dB)			H/G/EA Limit Level (dBc)	MASK E Limit Level (dBc)	
1	1737.90	Hor.	-56.62	-40.41	6.36	13.55	-47.6	-89.4	-54.8	-65.0	24.4
		Ver.	-57.60	-40.73	6.36	13.55	-47.9	-89.7	-54.8	-65.0	24.7
2	2606.85	Hor.	-63.31	-43.74	7.65	14.38	-50.5	-92.2	-54.8	-65.0	27.2
		Ver.	-62.03	-42.02	7.65	14.38	-48.7	-90.5	-54.8	-65.0	25.5
3	3475.80	Hor.	-60.77	-37.84	7.85	15.05	-45.0	-86.8	-54.8	-65.0	21.8
		Ver.	-59.77	-36.77	7.85	15.05	-44.0	-85.7	-54.8	-65.0	20.7
4	4344.75	Hor.	-56.59	-33.31	8.56	15.63	-40.4	-82.1	-54.8	-65.0	17.1
		Ver.	-56.42	-33.29	8.56	15.63	-40.4	-82.1	-54.8	-65.0	17.1
5	5213.70	Hor.	-45.60	-19.35	8.72	16.17	-26.8	-68.6	-54.8	-65.0	3.6
		Ver.	-43.90	-17.48	8.72	16.17	-24.9	-66.7	-54.8	-65.0	1.7
6	6082.65	Hor.	-66.61	-38.47	9.31	16.71	-45.9	-87.6	-54.8	-65.0	22.6
		Ver.	-65.51	-37.27	9.31	16.71	-44.7	-86.4	-54.8	-65.0	21.4
7	6951.60	Hor.	-68.26	-38.34	9.69	17.17	-45.8	-87.6	-54.8	-65.0	22.6
		Ver.	-67.80	-37.60	9.69	17.17	-45.1	-86.8	-54.8	-65.0	21.8
8	7820.55	Hor.	-67.60	-36.32	9.32	17.58	-44.6	-86.3	-54.8	-65.0	21.3
		Ver.	-63.32	-32.27	9.32	17.58	-40.5	-82.3	-54.8	-65.0	17.3
9	8689.50	Hor.	-68.59	-35.42	9.33	17.97	-44.1	-85.8	-54.8	-65.0	20.8
		Ver.	-66.95	-34.39	9.33	17.97	-43.0	-84.8	-54.8	-65.0	19.8

There is the margin of 20dB over except for the above points.

Mask G Limit (dBc) = $-(43+10\log(P))$

Mask E Limit (dBc) = whichever is the lesser attenuation ; $-(55+10\log(P))$ or -65

Correct Level (dBm) = Substitute SG Level (dBm) + ANT Gain (dB) - Loss (Cable, Attenuator) (dB)

Emission Level (dBc) = Correct Level (dBm) - $10\log(P*1000)$

P = Carrier Level (W)

" - " = Measurement Limit

State : Low Power / Authorized Bandwidth FCC: 20 kHz, RSS: 6 kHz / 851.05MHz (Band 2)

No	Frequency (MHz)	Pol	Reading Level (dBm)	SG Out Level (dBm)	Antenna		Correct Level (dBm)	Emission Level (dBc)	MASK		Margin (Worst) (dB)
					Gain (dBd)	Loss (dB)			H/G/EA Limit Level (dBc)	MASK E Limit Level (dBc)	
1	1702.10	Hor.	-60.53	-44.74	6.32	13.51	-51.9	-88.9	-50.0	-57.0	31.9
		Ver.	-61.30	-45.15	6.32	13.51	-52.3	-89.3	-50.0	-57.0	32.3
2	2553.15	Hor.	-63.06	-44.40	7.66	14.33	-51.1	-88.1	-50.0	-57.0	31.1
		Ver.	-62.59	-43.37	7.66	14.33	-50.0	-87.0	-50.0	-57.0	30.0
3	3404.20	Hor.	-65.43	-42.46	7.80	15.00	-49.7	-86.6	-50.0	-57.0	29.6
		Ver.	-63.33	-40.38	7.80	15.00	-47.6	-84.6	-50.0	-57.0	27.6
4	4255.25	Hor.	-63.19	-40.26	8.32	15.58	-47.5	-84.5	-50.0	-57.0	27.5
		Ver.	-63.45	-40.34	8.32	15.58	-47.6	-84.6	-50.0	-57.0	27.6
5	5106.30	Hor.	-59.05	-33.56	8.76	16.10	-40.9	-77.9	-50.0	-57.0	20.9
		Ver.	-56.00	-30.51	8.76	16.10	-37.8	-74.8	-50.0	-57.0	17.8
6	5957.35	Hor.	-66.87	-39.74	9.12	16.64	-47.3	-84.2	-50.0	-57.0	27.2
		Ver.	-64.61	-37.19	9.12	16.64	-44.7	-81.7	-50.0	-57.0	24.7
7	6808.40	Hor.	-67.45	-37.86	9.79	17.10	-45.2	-82.2	-50.0	-57.0	25.2
		Ver.	-66.25	-36.60	9.79	17.10	-43.9	-80.9	-50.0	-57.0	23.9
8	7659.45	Hor.	-	-	9.25	17.50	-	-	-50.0	-57.0	-
		Ver.	-67.76	-37.40	9.25	17.50	-45.7	-82.7	-50.0	-57.0	25.7
9	8510.50	Hor.	-	-	9.29	17.89	-	-	-50.0	-57.0	-
		Ver.	-	-	9.29	17.89	-	-	-50.0	-57.0	-

There is the margin of 20dB over except for the above points.

Mask G Limit (dBc) = $-(43+10\log(P))$

Mask E Limit (dBc) = whichever is the lesser attenuation ; $-(55+10\log(P))$ or -65

Correct Level (dBm) = Substitute SG Level (dBm) + ANT Gain (dB) - Loss (Cable, Attenuator) (dB)

Emission Level (dBc) = Correct Level (dBm) - $10\log(P*1000)$

P = Carrier Level (W)

" - " = Measurement Limit

10.4 Emission Masks (Occupied Bandwidth)

REGULATIONS	: FCC Part 2 Section 1049 (c) (1), Part 90 Section 210 / RSS-119 Section 5.5 FCC Part 24 Section 133, RSS-134 Section 4.4
TEST METHOD/GUIDE	: ANSI/TIA-603-E Section 2.2.11.2 / RSS-119 Section 5.8

Test Procedure

- 1 The EUT and test equipment were set up as shown on the following page.
- 2 For EUT supporting audio modulation, the audio signal generator was adjusted to the frequency of maximum response and with output level set for +/- 2.5 kHz deviation (or 50 % modulation). (FM modulation).
- 3 With level constant, the signal level was increased 16 dB.
- 4 For EUT supporting digital modulation, the digital modulation mode was operated to its maximum extent.
- 5 Adjust the spectrum analyzer for the following setting:
 - a) RBW : 100Hz (Non modulation and Authorized Band 6 kHz),
100Hz (Non modulation and Authorized Band 11.25 kHz),
300Hz (Non modulation and Authorized Band 20 kHz).
 - b) VBW : 10times the RBW (Non modulation, Modulation).
 - c) RBW and VBW : 30 kHz (Non modulation(Digital Modulation)).
- 6 The occupied Bandwidth was measured with the Spectrum Analyzer controls set as shown on the test results.

The selection of Emission Mask

No.	Frequency (MHz)	Audio Filter	Authorized Bandwidth (kHz)		Selection of Emission Mask		
			FCC	IC	FCC	IC	
Emission Designation :		16K0F3E					
1	806.05	With	20	20	B	B	
2	815.05	With	20	20	B / EA	B	
3	823.95	With	20	20	B / EA	B	
4	851.05	With	20	20	B	B	
5	860.05	With	20	20	B / EA	B	
6	868.95	With	20	20	B / EA	B	
Emission Designation :		14K0F3E					
1	806.05	With	20	20	B	B	
2	815.05	With	20	20	B / EA	B	
3	823.95	With	20	20	B / EA	B	
4	851.05	With	20	20	B	B	
5	860.05	With	20	20	B / EA	B	
6	868.95	With	20	20	B / EA	B	
Emission Designation :		11K0F3E					
1	806.05	With	20	11.25	B	D	
2	815.05	With	20	11.25	B / EA	D	
3	823.95	With	20	11.25	B / EA	D	
4	851.05	With	20	11.25	B	D	
5	860.05	With	20	11.25	B / EA	D	
6	868.95	With	20	11.25	B / EA	D	
Emission Designation :		8K30F1E / F1D / F7W					
1	806.05	Without	20	11.25	H	D	
2	815.05	Without	20	11.25	G / EA	D	
3	823.95	Without	20	11.25	G / EA	D	
4	851.05	Without	20	11.25	H	D	
5	860.05	Without	20	11.25	G / EA	D	
6	868.95	Without	20	11.25	G / EA	D	
Emission Designation :		7K60FXD/FXE					
1	806.05	Without	20	11.25	H	D	
2	815.05	Without	20	11.25	G / EA	D	
3	823.95	Without	20	11.25	G / EA	D	
4	851.05	Without	20	11.25	H	D	
5	860.05	Without	20	11.25	G / EA	D	
6	868.95	Without	20	11.25	G / EA	D	
Emission Designation :		4K00F1E / F1D / F7W					
1	806.05	Without	20	6	H	E	
2	815.05	Without	20	6	G / EA	E	
3	823.95	Without	20	6	G / EA	E	
4	851.05	Without	20	6	H	E	
5	860.05	Without	20	6	G / EA	E	
6	868.95	Without	20	6	G / EA	E	
Emission Designation :		4K00F2D					
1	806.05	Without	20	6	H	E	
2	815.05	Without	20	6	G / EA	E	
3	823.95	Without	20	6	G / EA	E	
4	851.05	Without	20	6	H	E	
5	860.05	Without	20	6	G / EA	E	
6	868.95	Without	20	6	G / EA	E	

Measuring Equipments

No.	Equipment	Manufacture	Model No.	Serial No.	Cal. Interval	Effective period
1	Attenuator (20dB)	Aeroflex/Wenshel	66-20-34	BY4357	1Y	Jul. 31, 19
2	Attenuator (30dB)	Weinschel	WA-29-30-34	8923	1Y	Jul. 31, 19
3	Modulation Analyzer	Hewlett Packard	8901B	3403A04852	1Y	Dec. 31, 18
4	Audio Generator	Anritsu	MG443B	M70150	1Y	Sep. 30, 19
5	Spectrum Analyzer	Agilent	N9030A	US51350220	1Y	Mar. 31, 19
6	DC Power Supply	Daiichi denpa kogyo	GZV4000	90290931	None	None
7	Digital Multi Meter	FLUKE	8846A	9642018	1Y	Sep. 30, 19

Measuring Cables

No.	Cable	Manufacture	Model No.	Serial No.	Cal. Interval	Effective period
W3	Balance Cable	Nicoon	3D-2V	KSR00092	1Y	Feb. 28, 19
W4	Coaxial Cable	Pacific custom	RG-58 C/U	AM90C04	1Y	Feb. 28, 19
W2	Coaxial Cable	Suhner	SUCOFLEX104	F0000017	1Y	Jul. 31, 19

Measuring Equipment Configuration

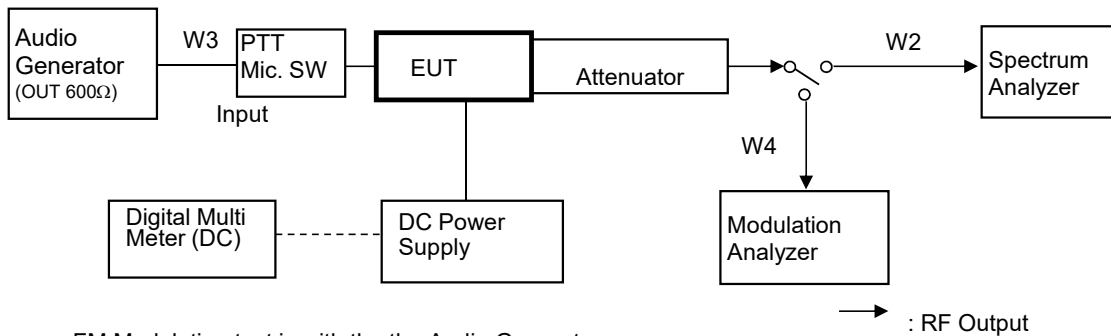

FM Modulation test is with the the Audio Generator.
 Configuration of other Modulation test is composed without the Audio Generator.

Test Results

Test date	Nov. 20, 2018		
Location	Kashima No.12 Test Site		
temperature	25.7	to	26 [degree C]
Humidity Variation	50	to	54 [%]
Atmospheric Pressure	99.2	to	101.6 [kPa]
Test Engineer	Koichi Wagatsuma		

Test was carried out for all the frequency band of section 10.1
 State the worst case (below).

State : High Power / Authorized Bandwidth 20 kHz/ 16K0F3E / 823.95 MHz(Band 1)
 Limit : Mask B / EA

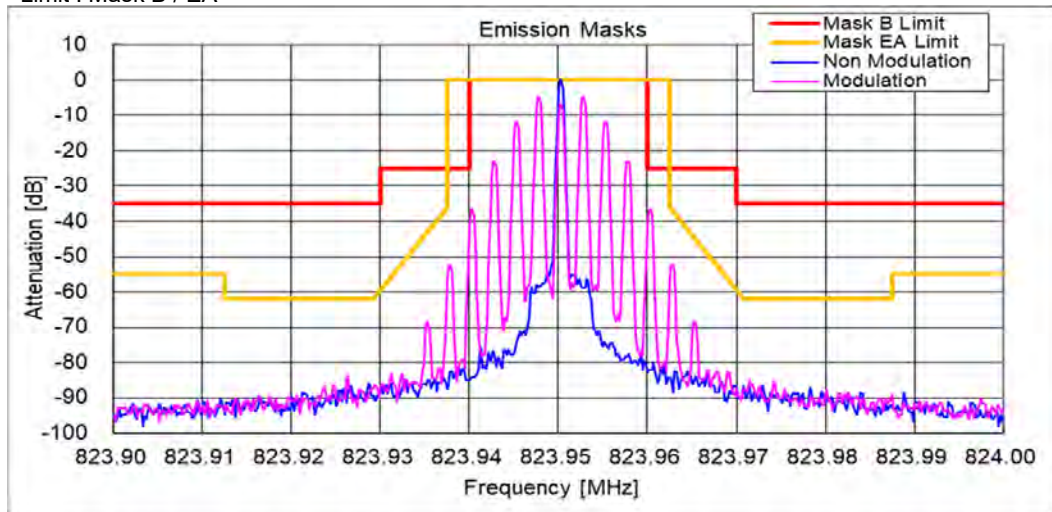

State : Low Power / Authorized Bandwidth 20 kHz/ 16K0F3E / 815.05 MHz(Band 1)
 Limit : Mask B / EA

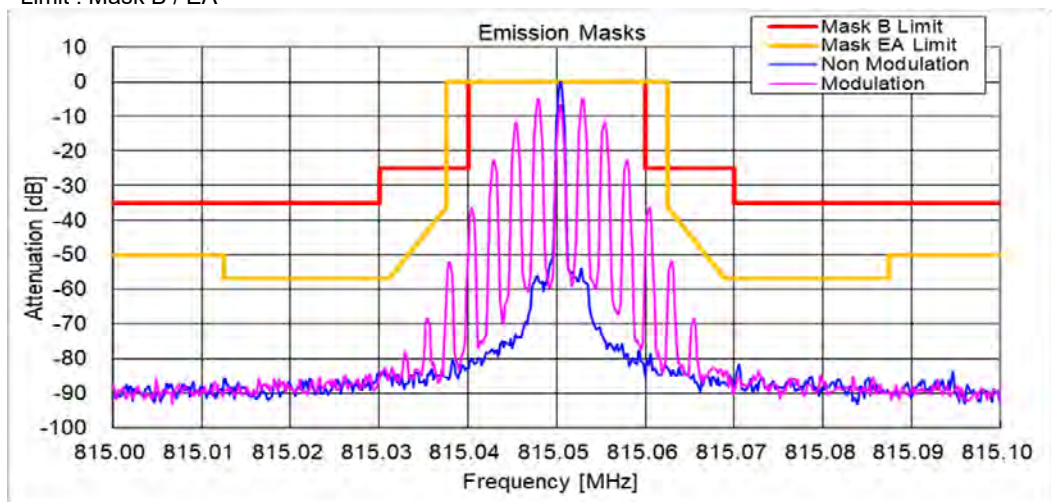

State : High Power / Authorized Bandwidth 20 kHz/ 16K0F3E / 868.95 MHz(Band 2)
Limit : Mask B / EA

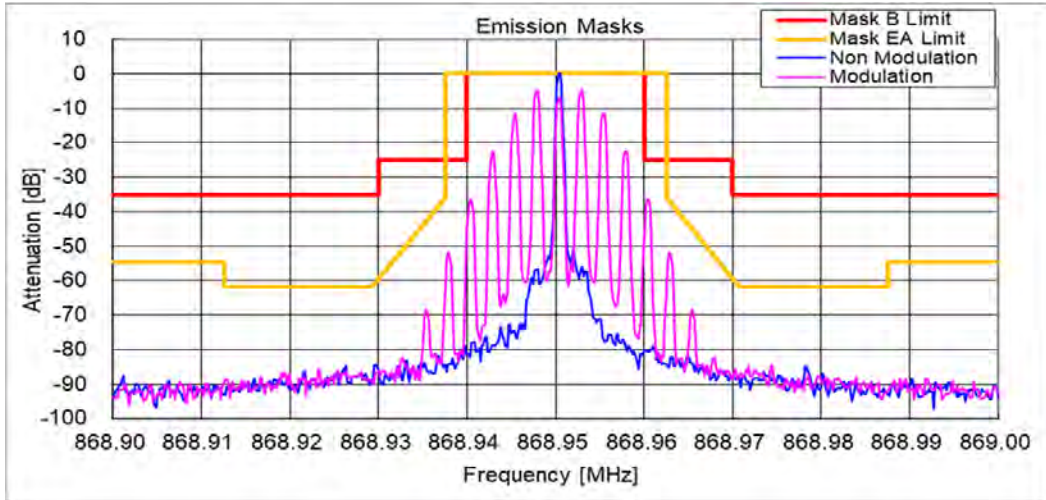

State : Low Power / Authorized Bandwidth 20 kHz/ 16K0F3E / 860.05 MHz(Band 2)
Limit : Mask B / EA

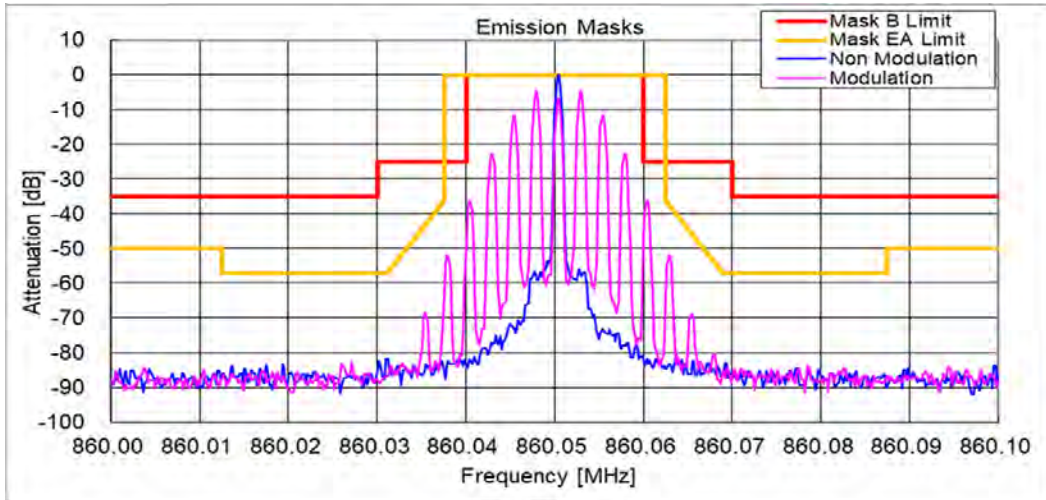

State : High Power / Authorized Bandwidth 20 kHz/ 14K0F3E / 815.05 MHz(Band 1)
Limit : Mask B / EA

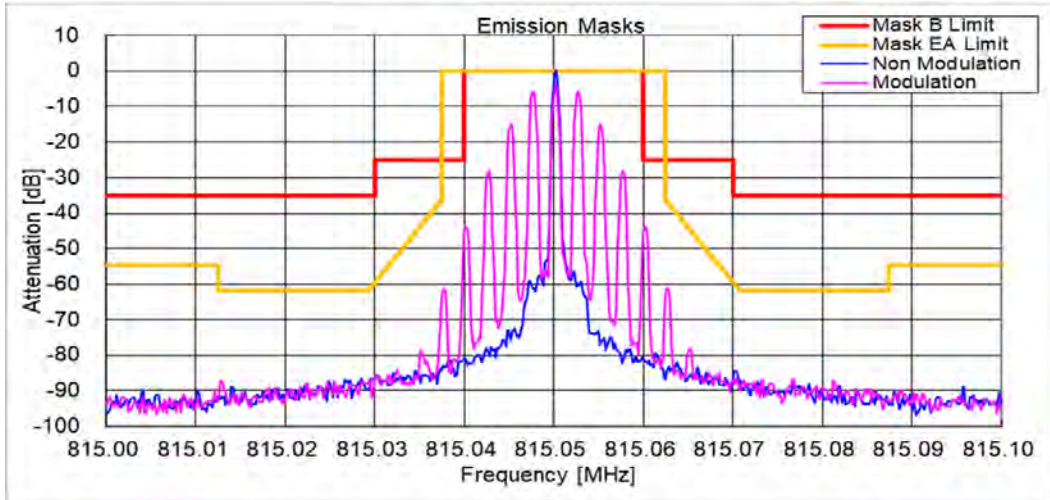

State : Low Power / Authorized Bandwidth 20 kHz/ 14K0F3E / 815.05 MHz(Band 1)
Limit : Mask B / EA

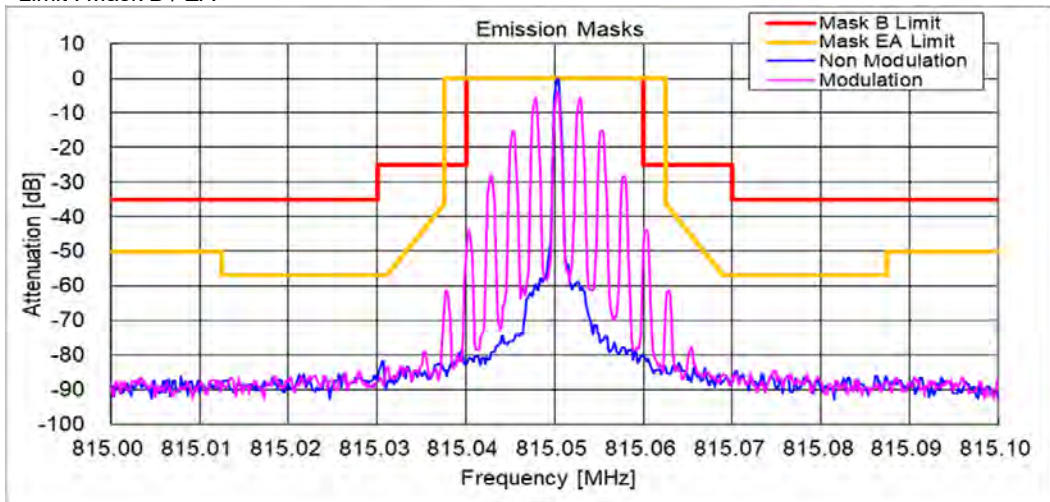

State : High Power / Authorized Bandwidth 20 kHz/ 14K0F3E / 868.95 MHz(Band 2)
Limit : Mask B / EA

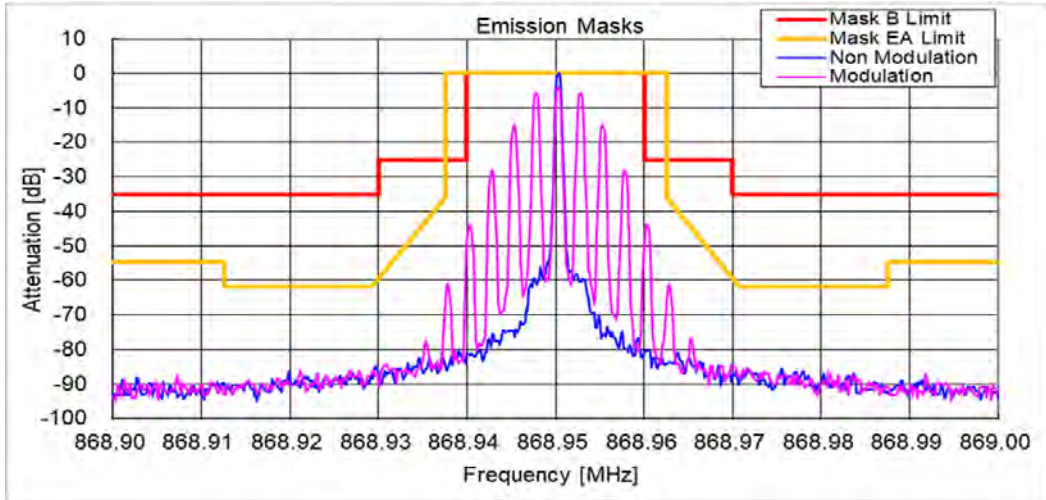

State : Low Power / Authorized Bandwidth 20 kHz/ 14K0F3E / 868.95 MHz(Band 2)
Limit : Mask B / EA

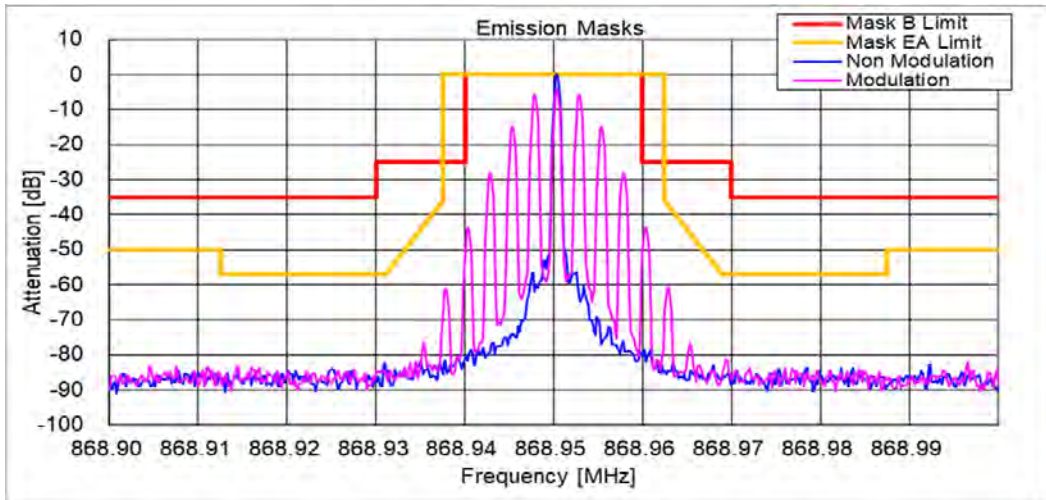

State : High Power / Authorized Bandwidth 20 kHz/ 11K0F3E / 815.05 MHz(Band 1)
Limit : Mask B / EA

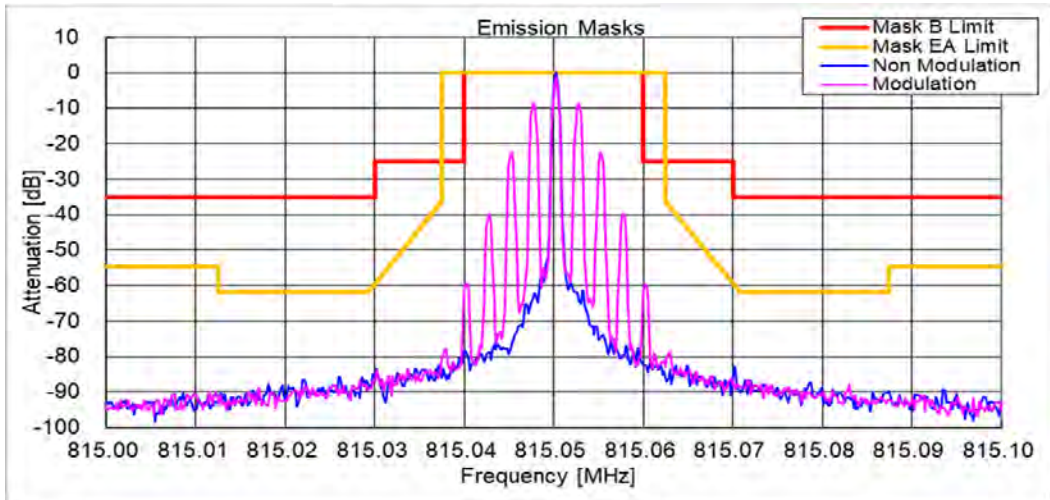

State : Low Power / Authorized Bandwidth 20 kHz/ 11K0F3E / 823.95 MHz(Band 1)
Limit : Mask B / EA

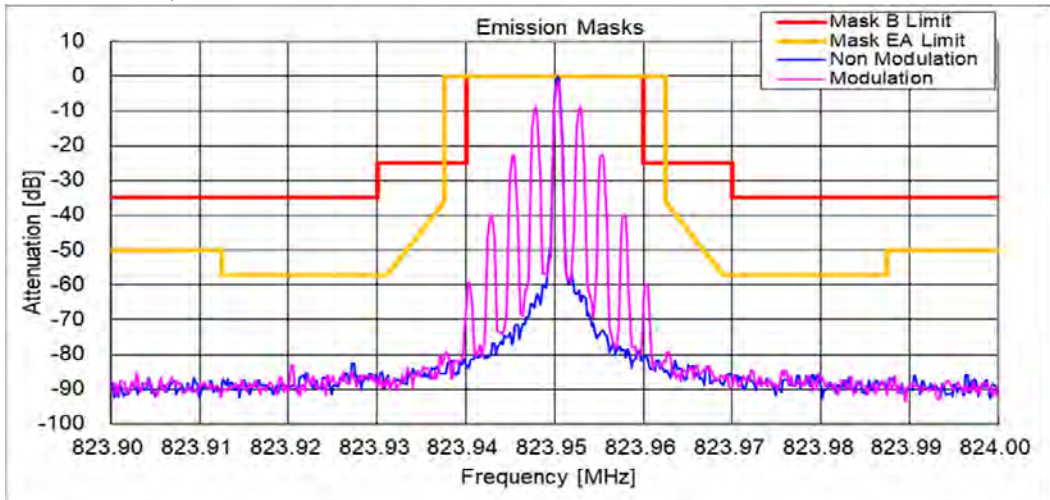

State : High Power / Authorized Bandwidth 20 kHz/ 11K0F3E / 868.95 MHz(Band 2)
Limit : Mask B / EA

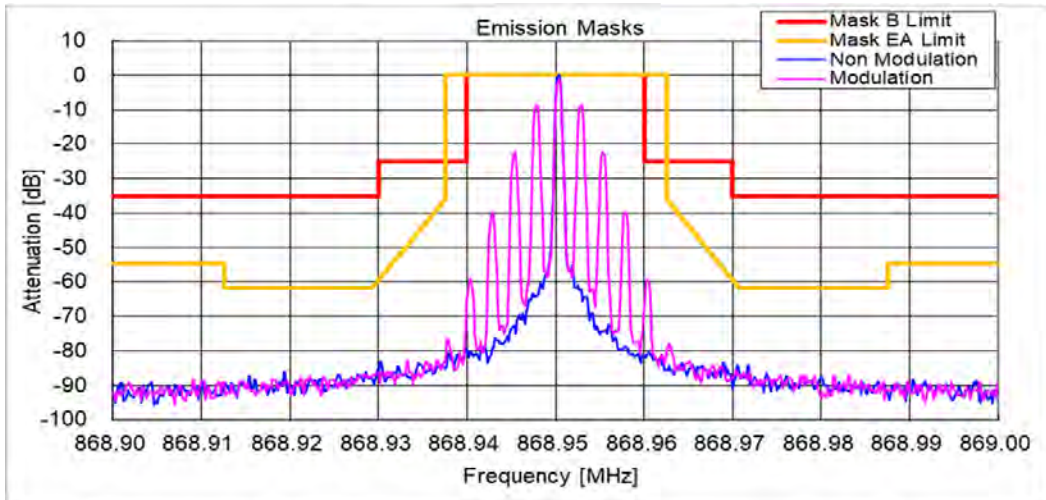

State : Low Power / Authorized Bandwidth 20 kHz/ 11K0F3E / 860.05 MHz(Band 2)
Limit : Mask B / EA

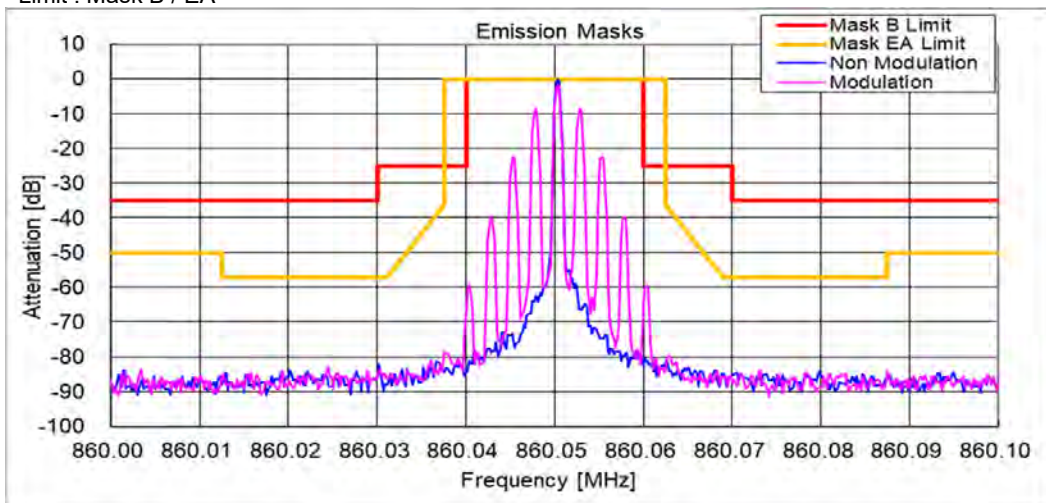

State : High Power/ Authorized Bandwidth 11.25 kHz/ 11K0F3E / 815.05 MHz(Band 1)
Limit : Mask D

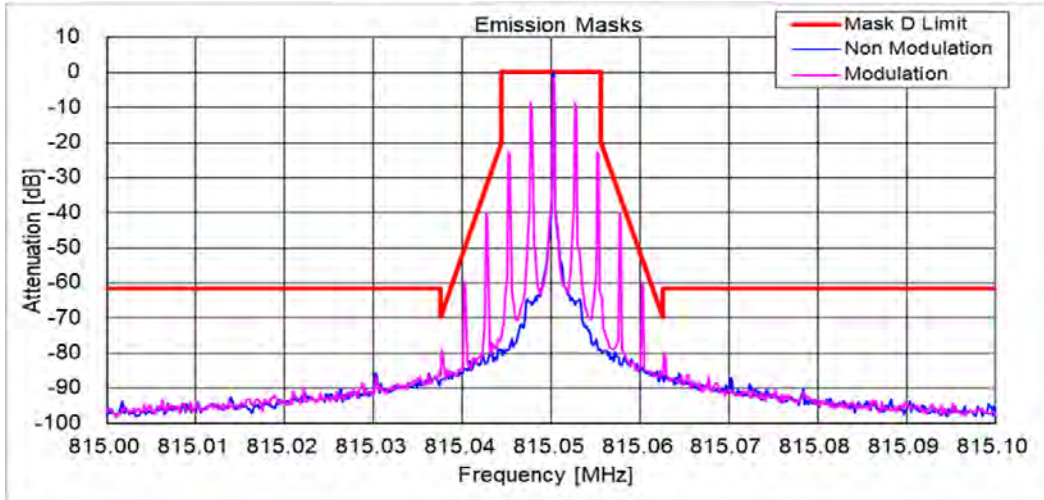

State : Low Power/ Authorized Bandwidth 11.25 kHz/ 11K0F3E / 815.05 MHz(Band 1)
Limit : Mask D

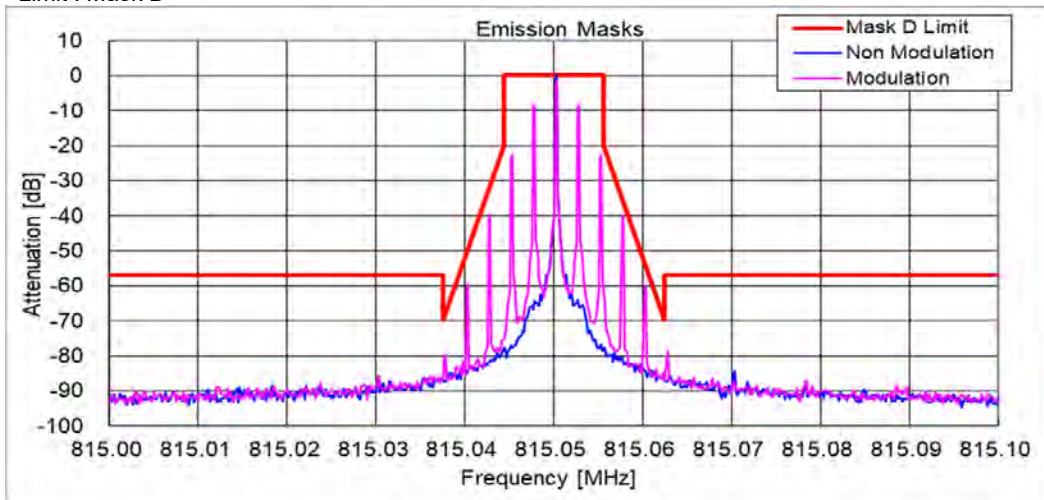

State : High Power / Authorized Bandwidth 11.25 kHz/ 11K0F3E / 851.05 MHz(Band 2)
Limit : Mask D

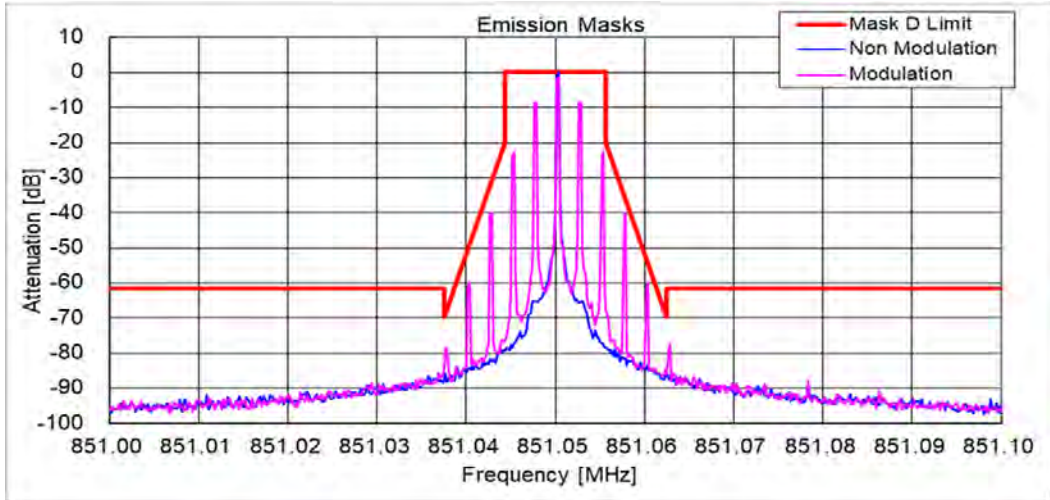

State : Low Power / Authorized Bandwidth 11.25 kHz/ 11K0F3E / 851.05 MHz(Band 2)
Limit : Mask D

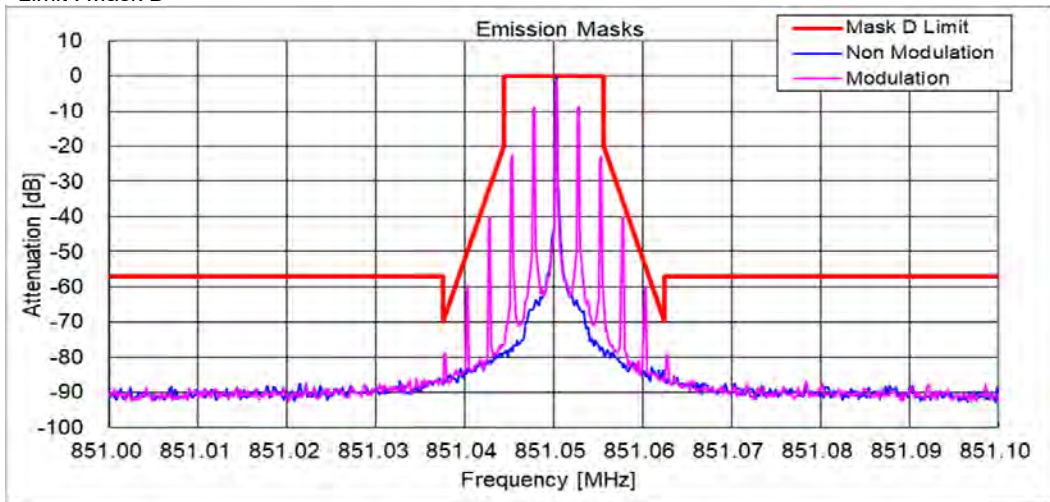

State : High Power / Authorized Bandwidth 20 kHz/ 8K30F1E/F1D/F7W / 806.05 MHz(Band 1)
Limit : Mask H

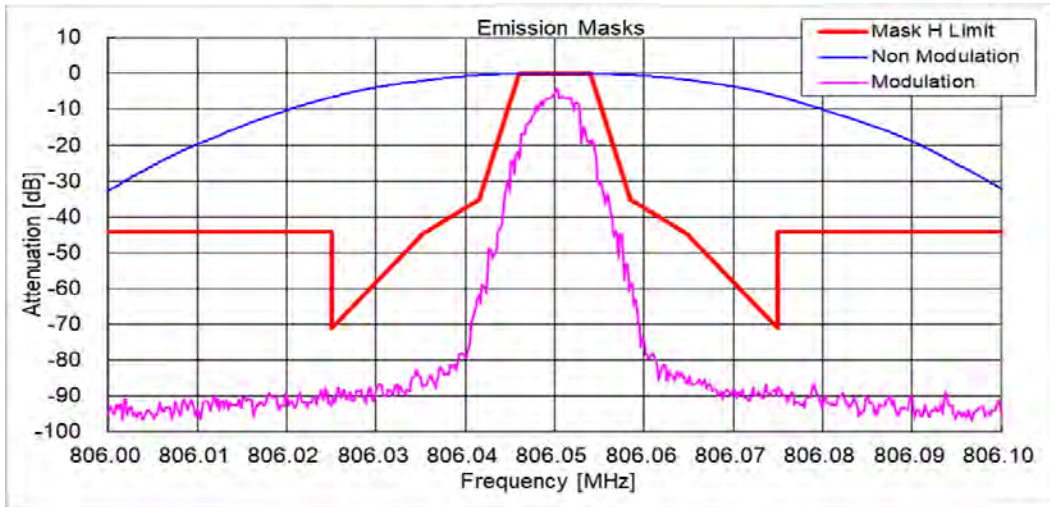

State : Low Power / Authorized Bandwidth 13.6 kHz/ 8K30F1E/F1D/F7W / 806.05 MHz(Band 1)
Limit : Mask H

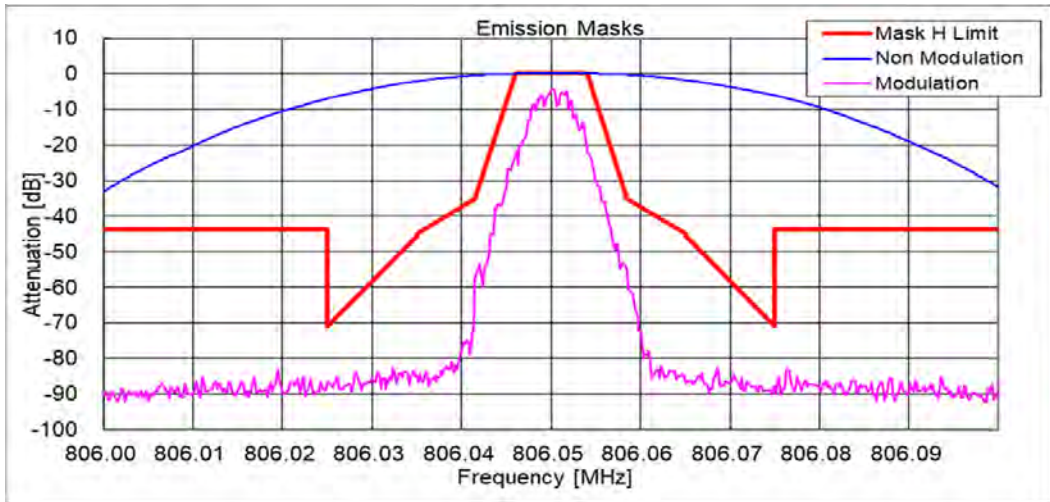

State : High Power / Authorized Bandwidth 20 kHz/ 8K30F1E/F1D/F7W / 851.05 MHz(Band 2)
Limit : Mask H

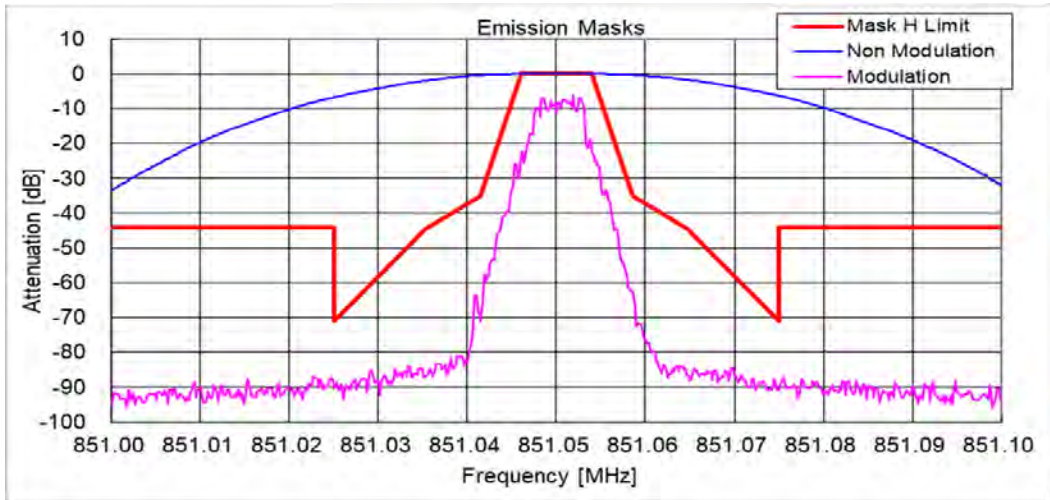

State : Low Power / Authorized Bandwidth 13.6 kHz/ 8K30F1E/F1D/F7W / 851.05 MHz(Band 2)
Limit : Mask H

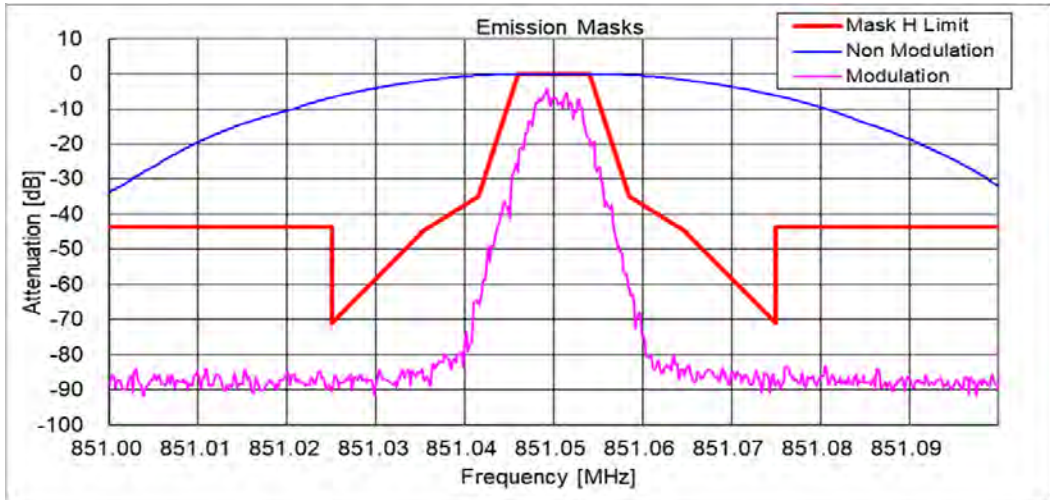

State : High Power / Authorized Bandwidth 20 kHz/ 8K30F1E/F1D/F7W / 823.95 MHz(Band 1)
Limit : Mask G / EA

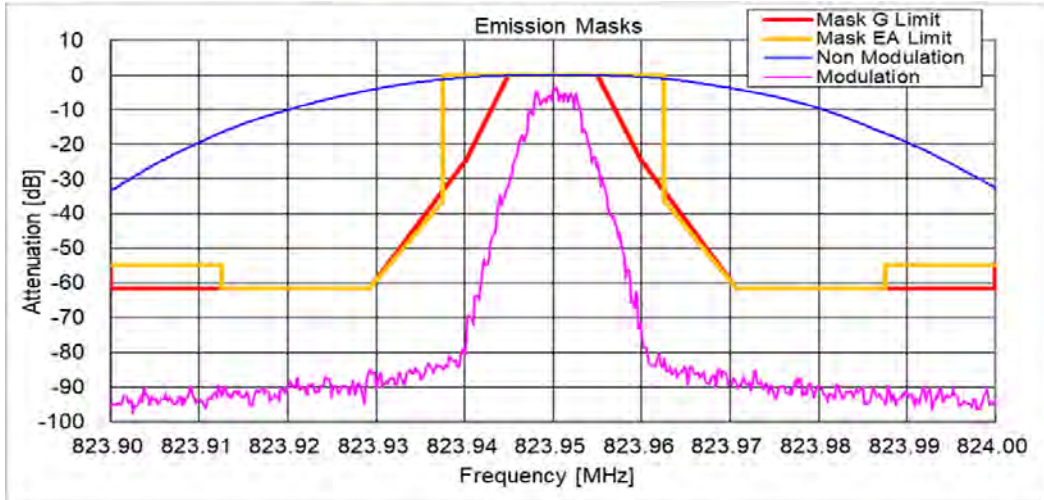

State : Low Power / Authorized Bandwidth 20 kHz/ 8K30F1E/F1D/F7W / 815.05 MHz(Band 1)
Limit : Mask G / EA

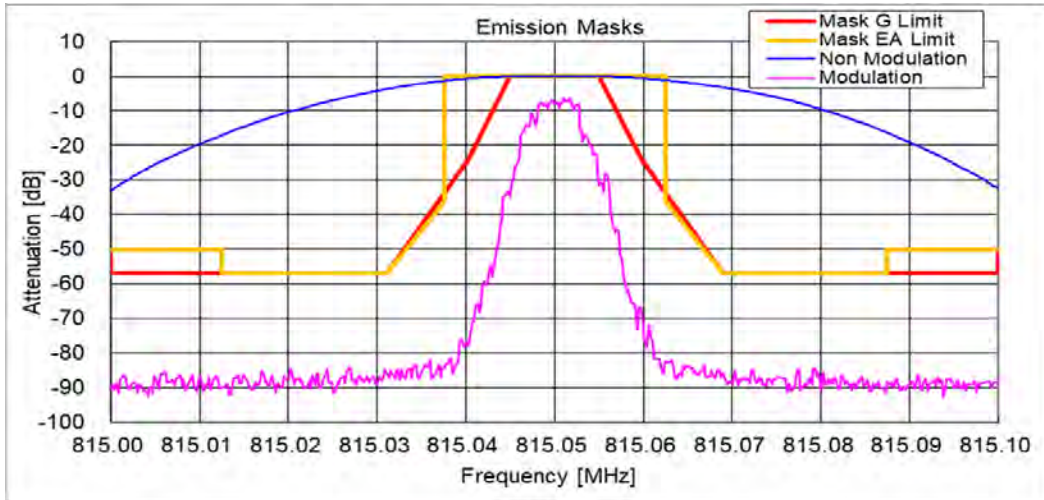

State : High Power / Authorized Bandwidth 20 kHz/ 8K30F1E/F1D/F7W / 860.05 MHz(Band 2)
Limit : Mask G / EA

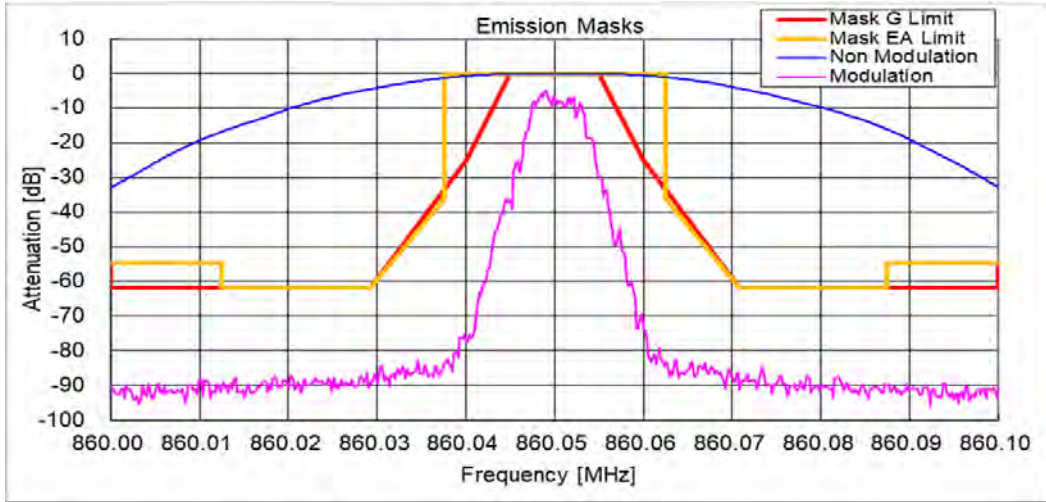

State : Low Power / Authorized Bandwidth 20 kHz/ 8K30F1E/F1D/F7W / 868.95 MHz(Band 2)
Limit : Mask G / EA

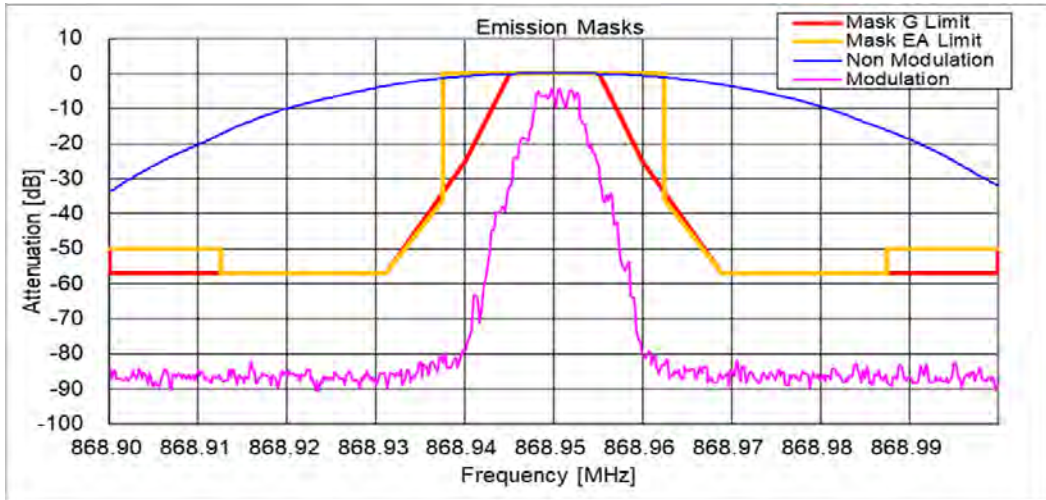

State : High Power / Authorized Bandwidth 11.25 kHz/ 8K30F1E/F1D/F7W / 815.05 MHz(Band 1)
Limit : Mask D

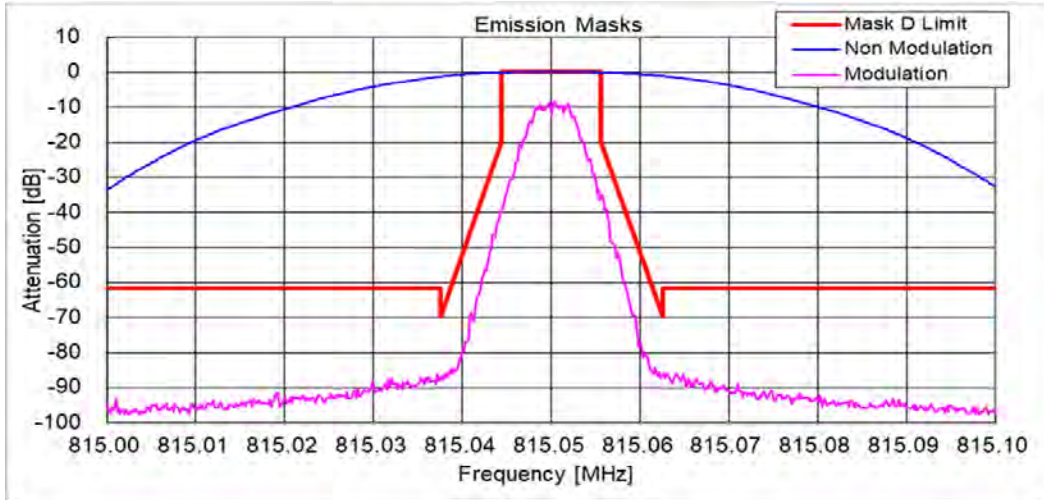

State : Low Power / Authorized Bandwidth 11.25 kHz/ 8K30F1E/F1D/F7W / 823.95 MHz(Band 1)
Limit : Mask D

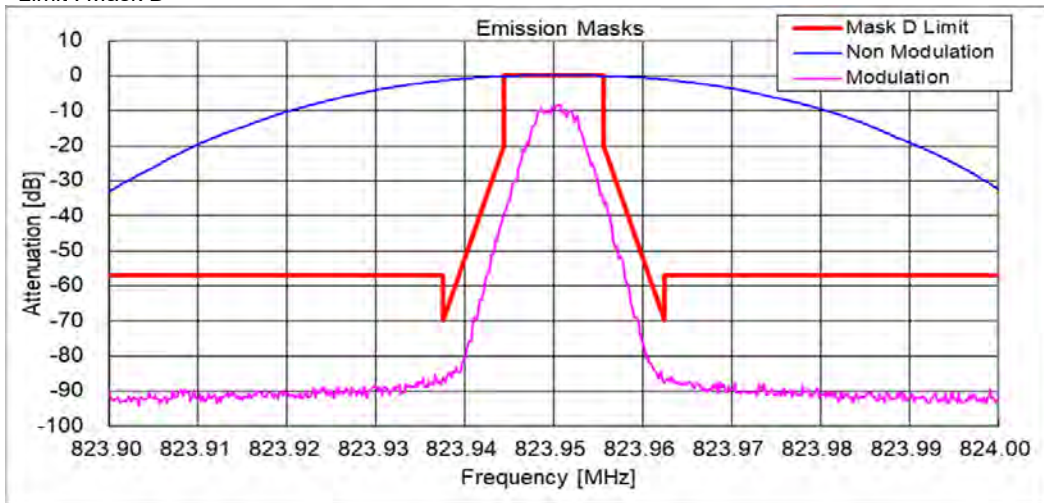

State : High Power / Authorized Bandwidth 11.25 kHz/ 8K30F1E/F1D/F7W / 868.95 MHz(Band 2)
Limit : Mask D

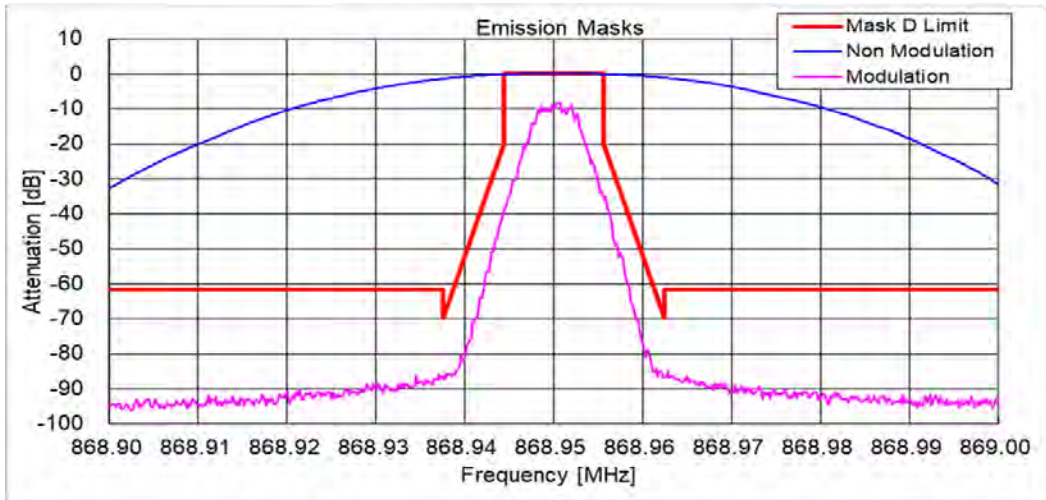

State : Low Power / Authorized Bandwidth 11.25 kHz/ 8K30F1E/F1D/F7W / 860.05 MHz(Band 2)
Limit : Mask D

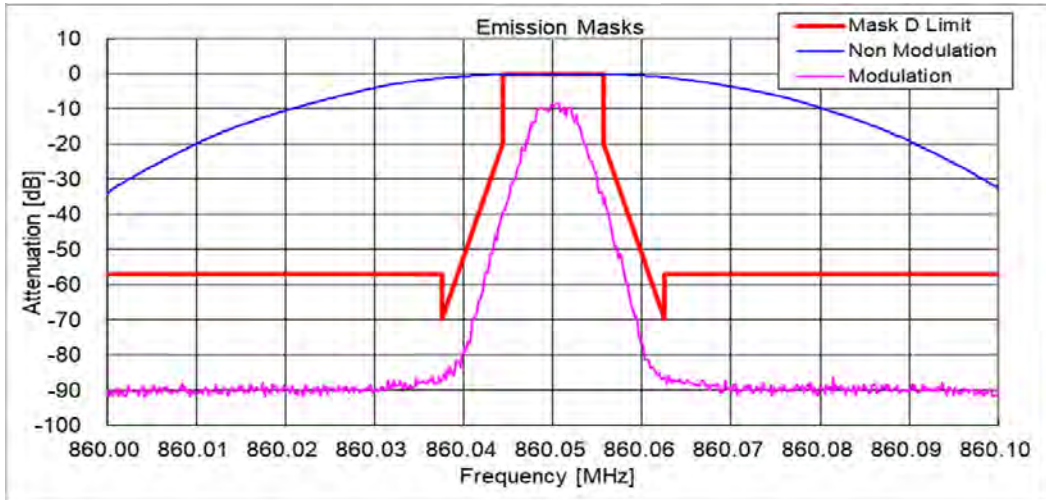

State : High Power / Authorized Bandwidth 20 kHz/ 7K60FXD/FXE / 806.05 MHz(Band 1)
Limit : Mask H

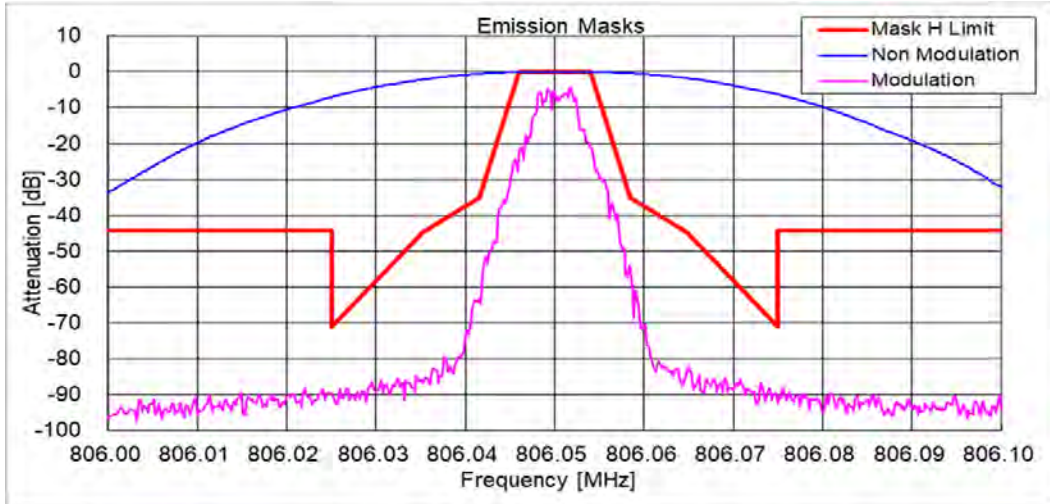

State : Low Power / Authorized Bandwidth 20 kHz/ 7K60FXD/FXE / 806.05 MHz(Band 1)
Limit : Mask H

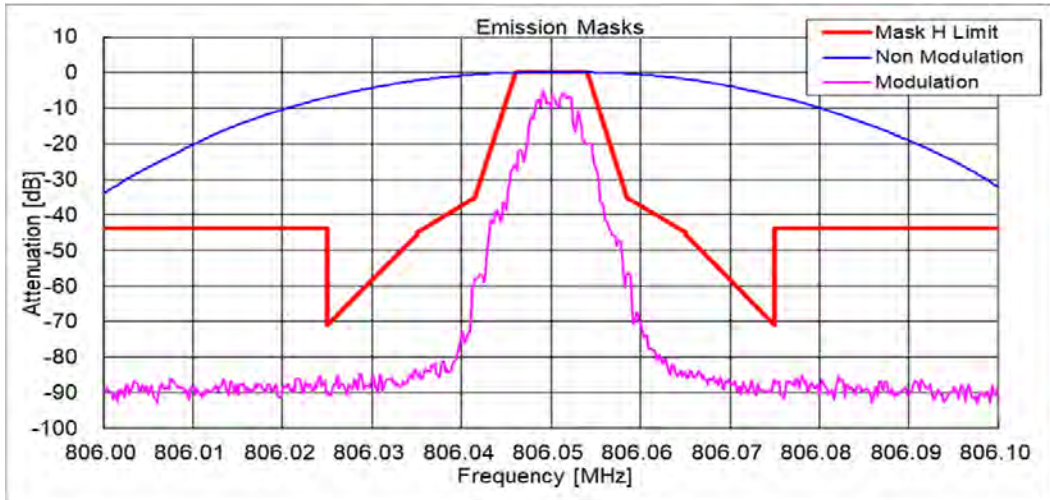

State : High Power / Authorized Bandwidth 20 kHz/ 7K60FXD/FXE / 851.05 MHz(Band 2)
Limit : Mask H

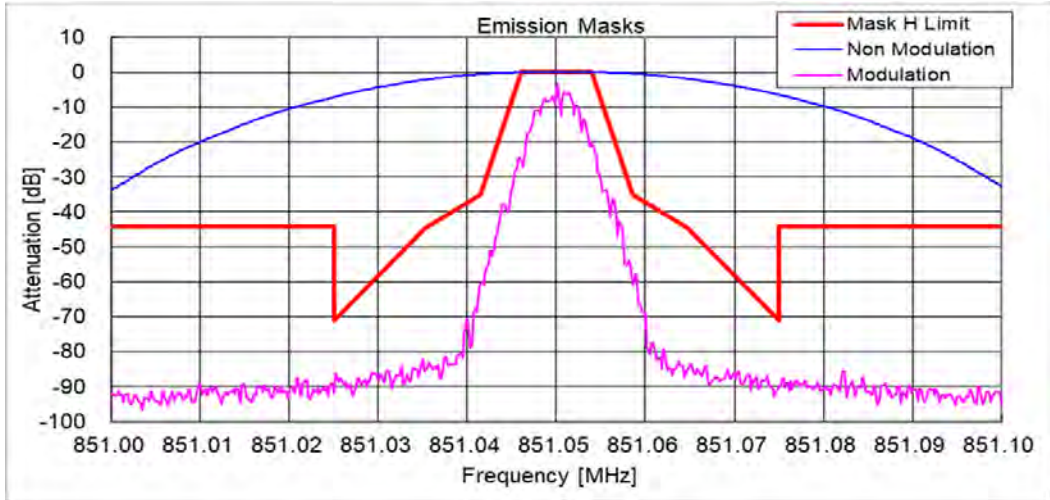

State : Low Power / Authorized Bandwidth 20 kHz/ 7K60FXD/FXE / 851.05 MHz(Band 2)
Limit : Mask H

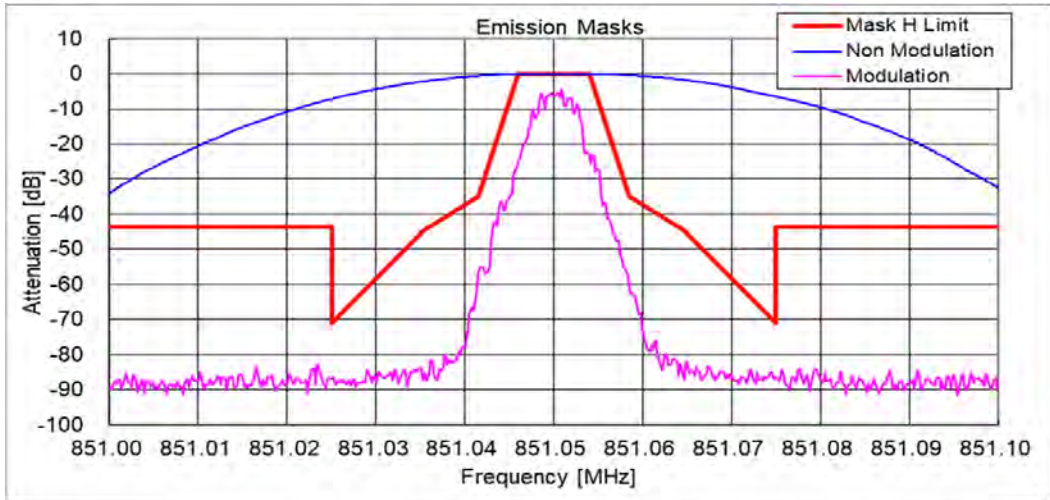

State : High Power / Authorized Bandwidth 20 kHz/ 7K60FXD/FXE / 823.95 MHz(Band 1)
Limit : Mask G / EA

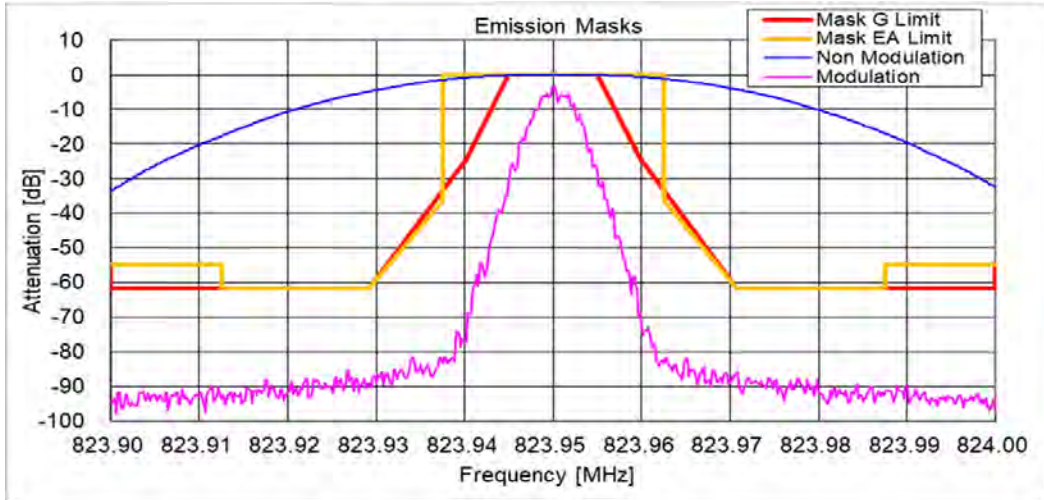

State : Low Power / Authorized Bandwidth 20 kHz/ 7K60FXD/FXE / 815.05 MHz(Band 1)
Limit : Mask G / EA

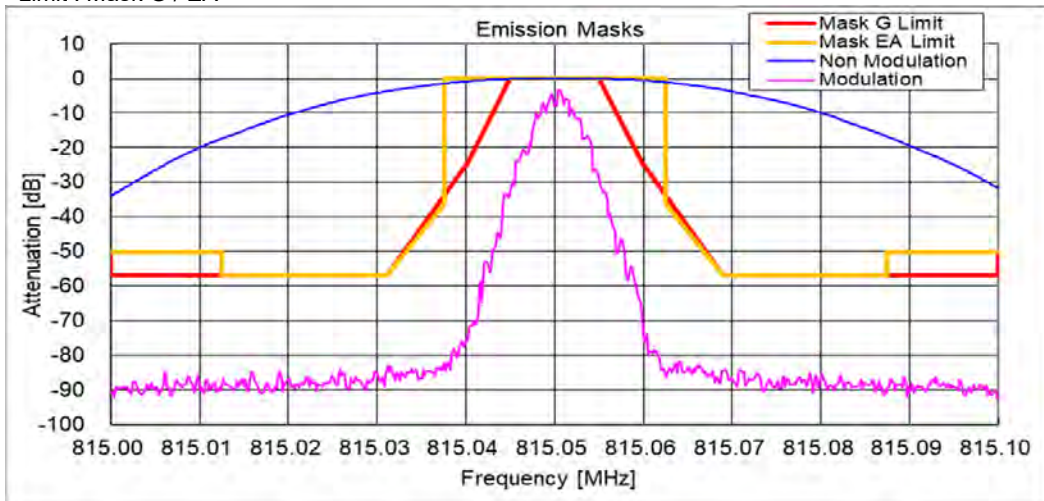

State : High Power / Authorized Bandwidth 20 kHz/ 7K60FXD/FXE / 868.95 MHz(Band 2)
Limit : Mask G / EA

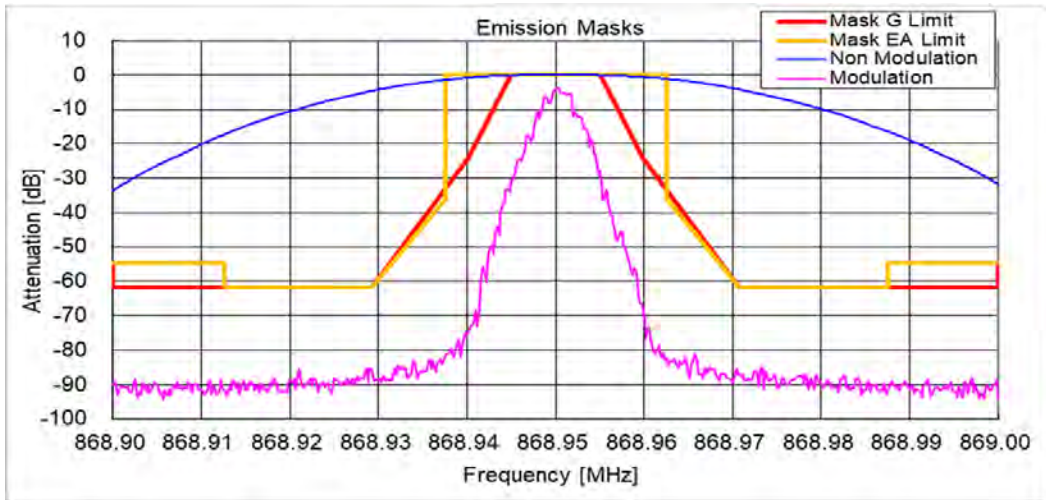

State : Low Power / Authorized Bandwidth 20 kHz/ 7K60FXD/FXE / 868.95 MHz(Band 2)
Limit : Mask G / EA

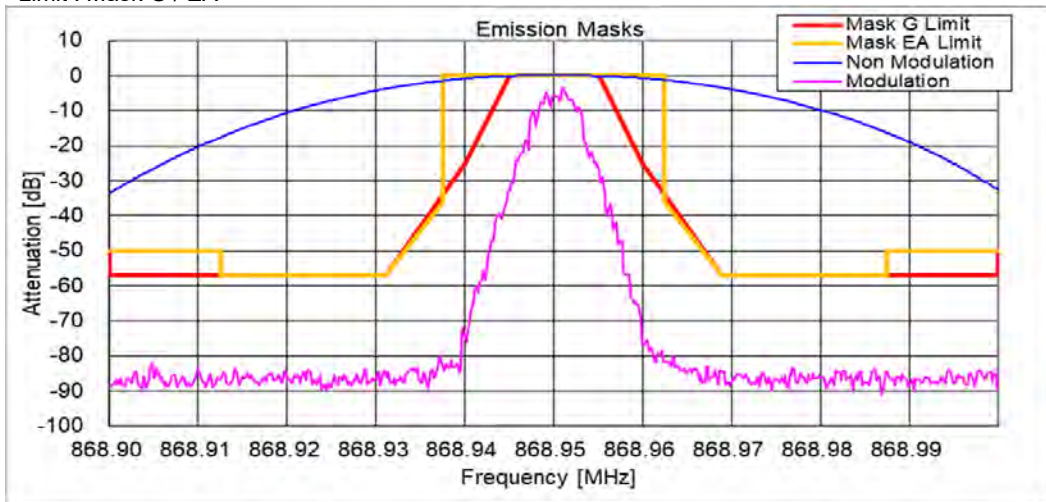

State : High Power / Authorized Bandwidth 11.25 kHz/ 7K60FXD/FXE / 815.05 MHz(Band 1)
Limit : Mask D

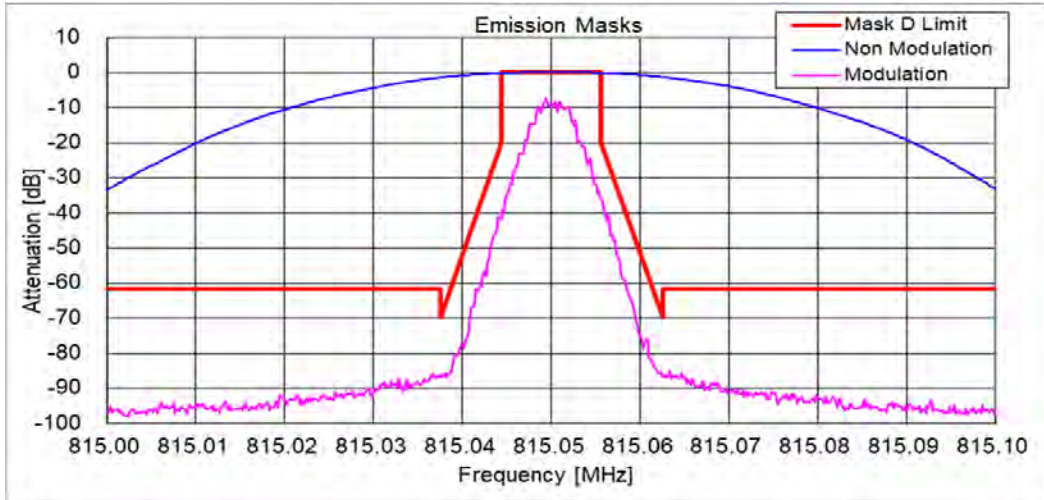

State : Low Power / Authorized Bandwidth 13.6 kHz/ 7K60FXD/FXE / 823.95 MHz(Band 1)
Limit : Mask D

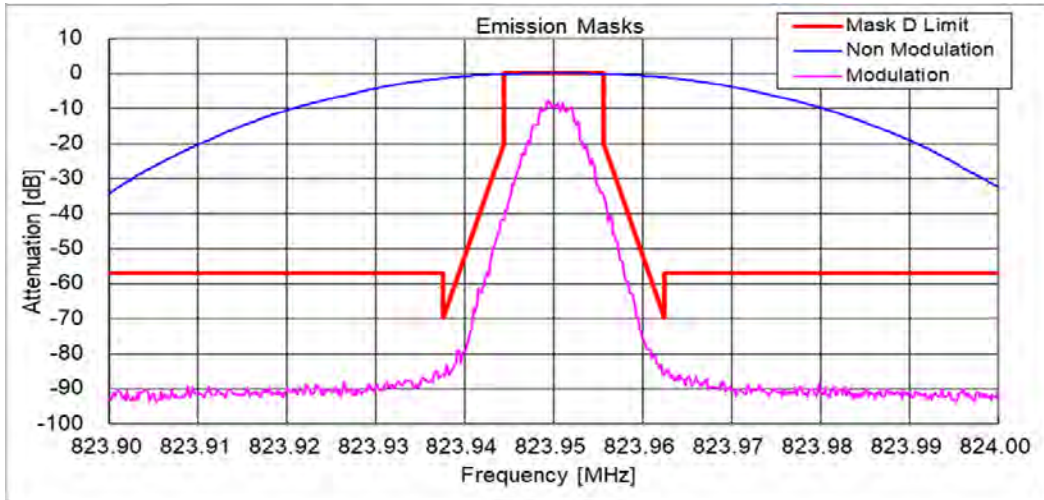

State : High Power / Authorized Bandwidth 11.25 kHz/ 7K60FXD/FXE / 868.95 MHz(Band 2)
Limit : Mask D

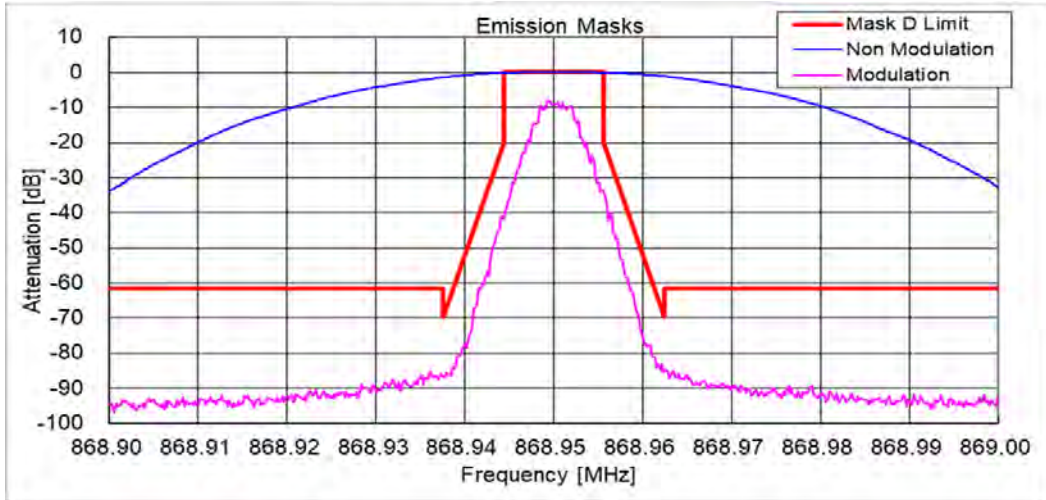

State : Low Power / Authorized Bandwidth 11.25 kHz/ 7K60FXD/FXE / 851.05 MHz(Band 2)
Limit : Mask D

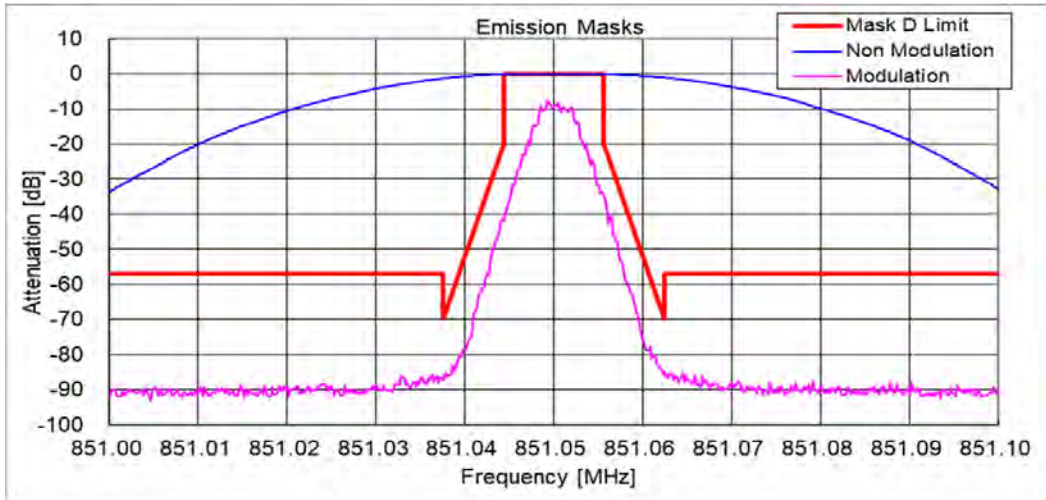

State : High Power / Authorized Bandwidth 20 kHz/ 4K00F1E / F1D / F7W / 806.05 MHz(Band 1)
Limit : Mask H

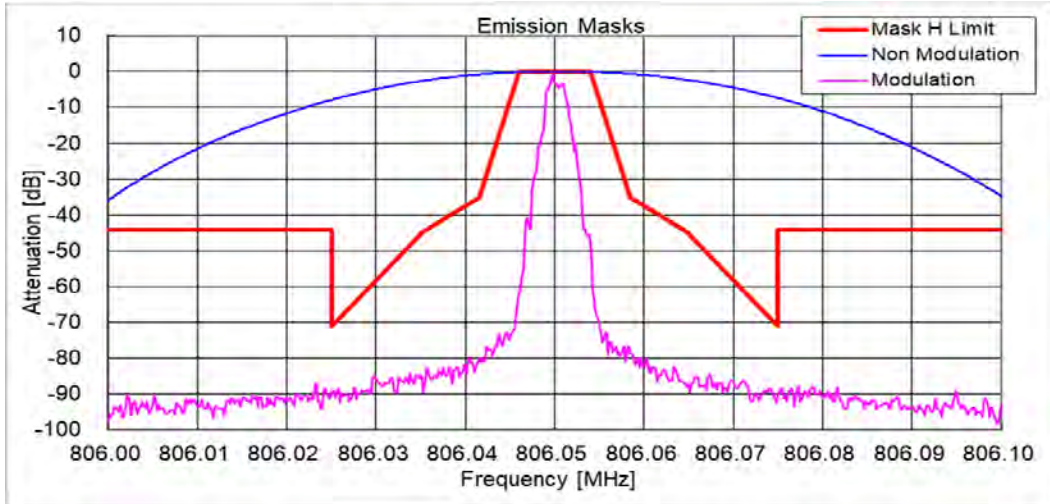

State : Low Power / Authorized Bandwidth 20 kHz/ 4K00F1E / F1D / F7W / 806.05 MHz(Band 1)
Limit : Mask H

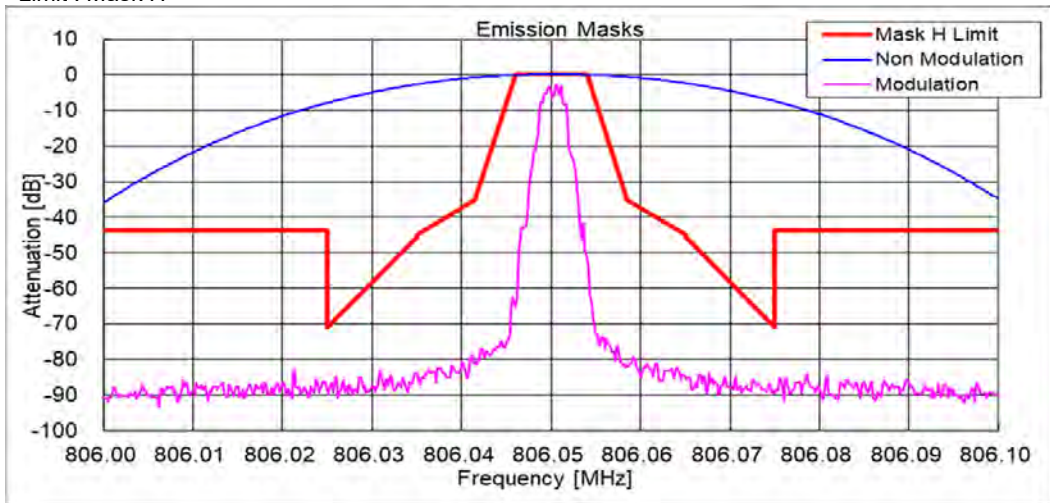

State : High Power / Authorized Bandwidth 20 kHz/ 4K00F1E / F1D / F7W / 851.05 MHz(Band 2)
Limit : Mask H

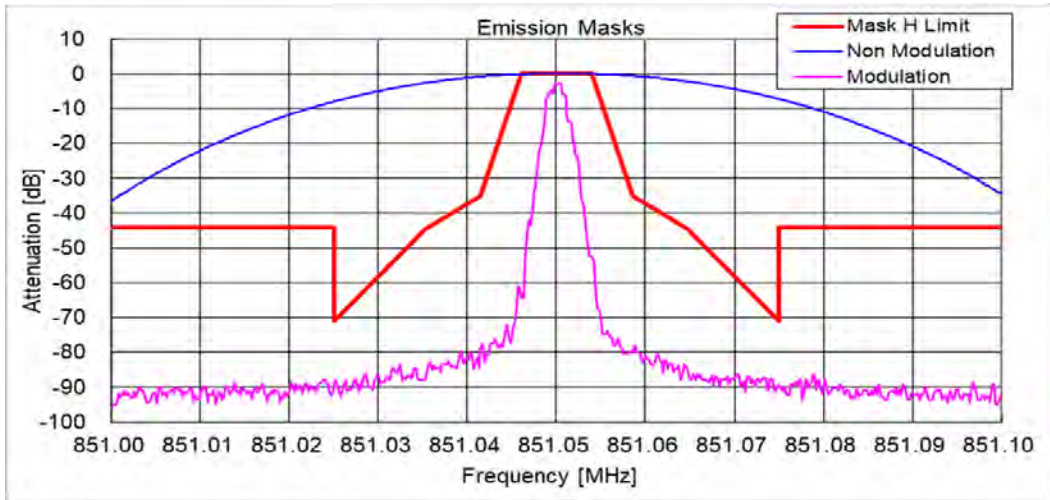

State : Low Power / Authorized Bandwidth 20 kHz/ 4K00F1E / F1D / F7W / 851.05 MHz(Band 2)
Limit : Mask H

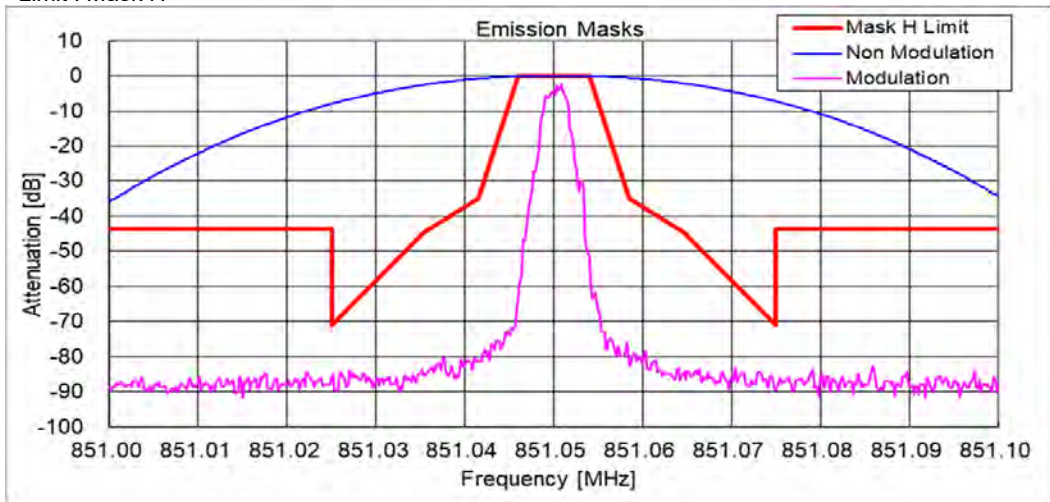

State : High Power / Authorized Bandwidth 20 kHz/ 4K00F1E / F1D / F7W / 823.95 MHz(Band 1)
Limit : Mask G / EA

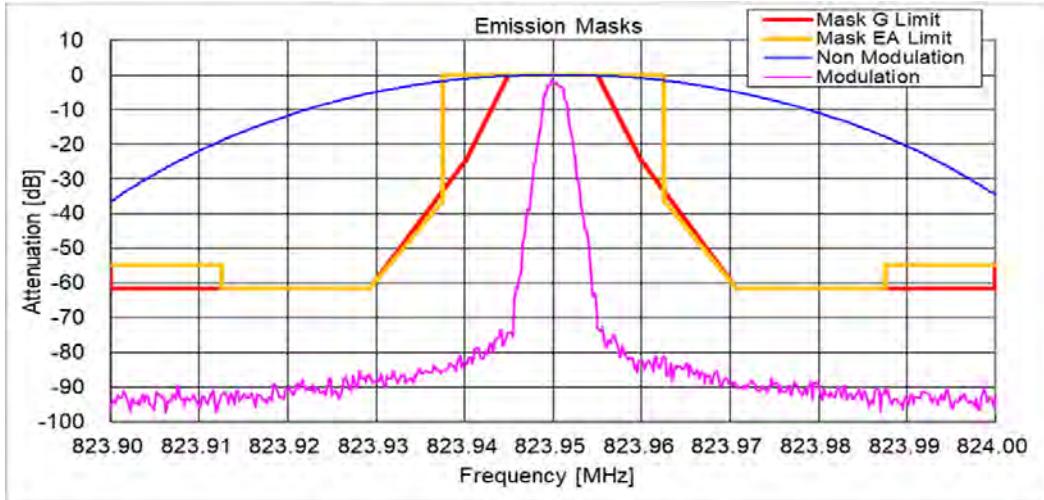

State : Low Power / Authorized Bandwidth 20 kHz/ 4K00F1E / F1D / F7W / 815.05 MHz(Band 1)
Limit : Mask G / EA

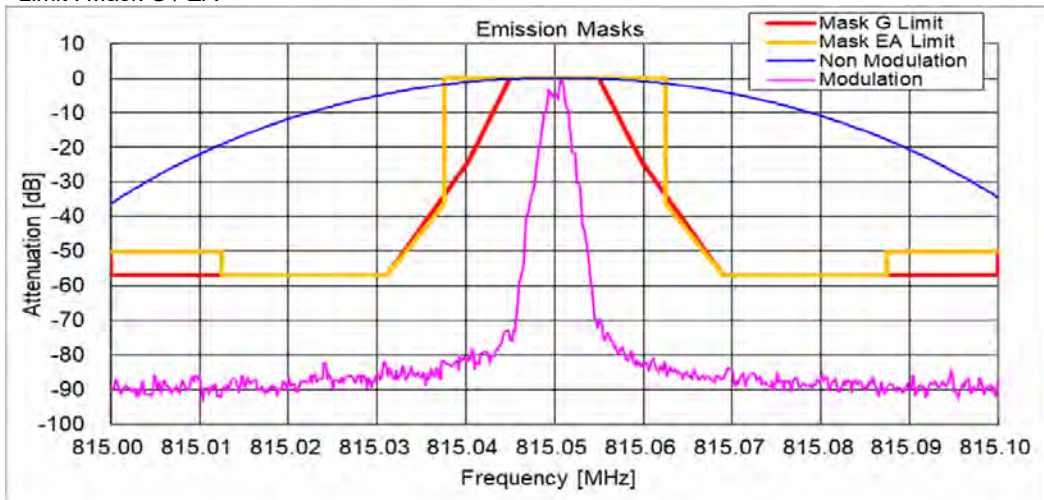

State : High Power / Authorized Bandwidth 20 kHz/ 4K00F1E / F1D / F7W / 860.05 MHz(Band 2)
Limit : Mask G / EA

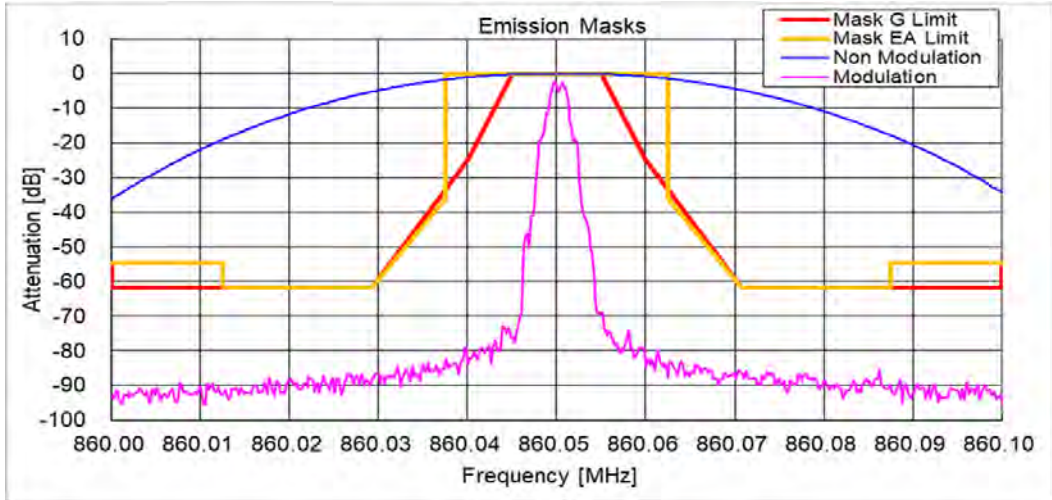

State : Low Power / Authorized Bandwidth 20 kHz/ 4K00F1E / F1D / F7W / 860.05 MHz(Band 2)
Limit : Mask G / EA

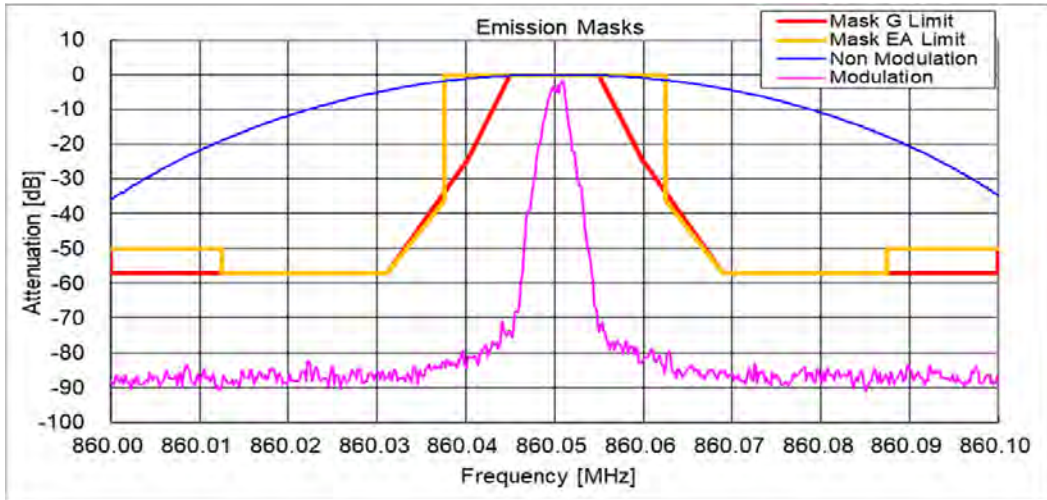

State : High Power / Authorized Bandwidth 6 kHz/ 4K00F1E / F1D / F7W / 815.05 MHz(Band 1)
Limit : Mask E

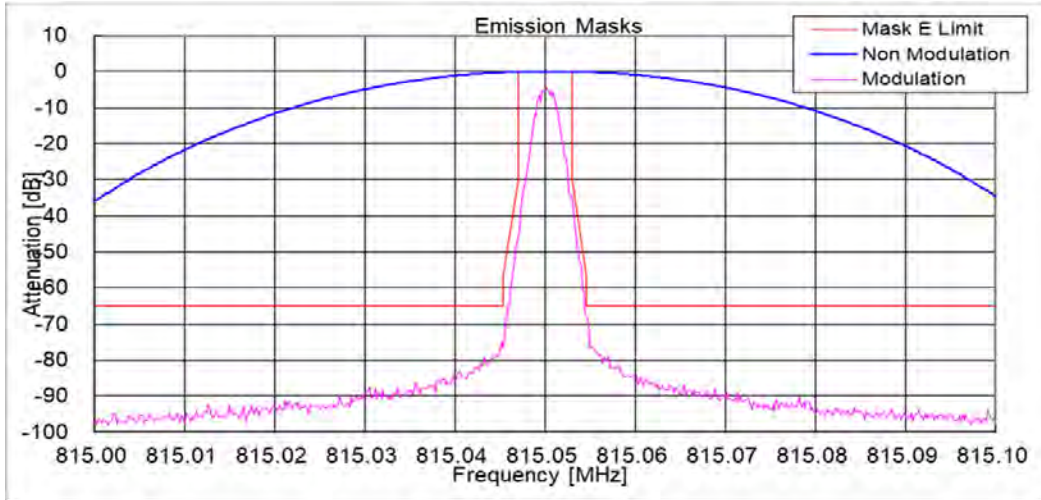

State : Low Power / Authorized Bandwidth 6 kHz/ 4K00F1E / F1D / F7W / 806.05 MHz(Band 1)
Limit : Mask E

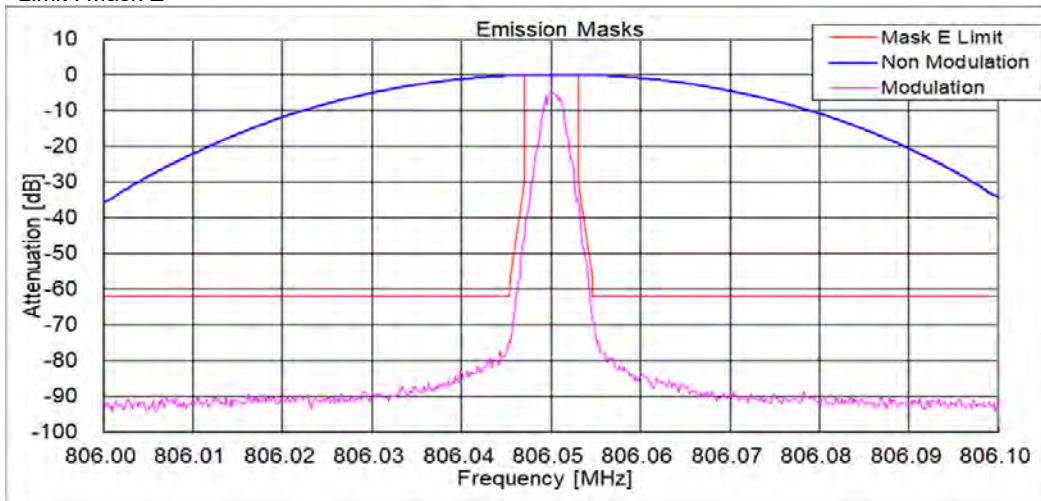

State : High Power / Authorized Bandwidth 6 kHz/ 4K00F1E / F1D / F7W / 860.05 MHz(Band 2)
Limit : Mask E

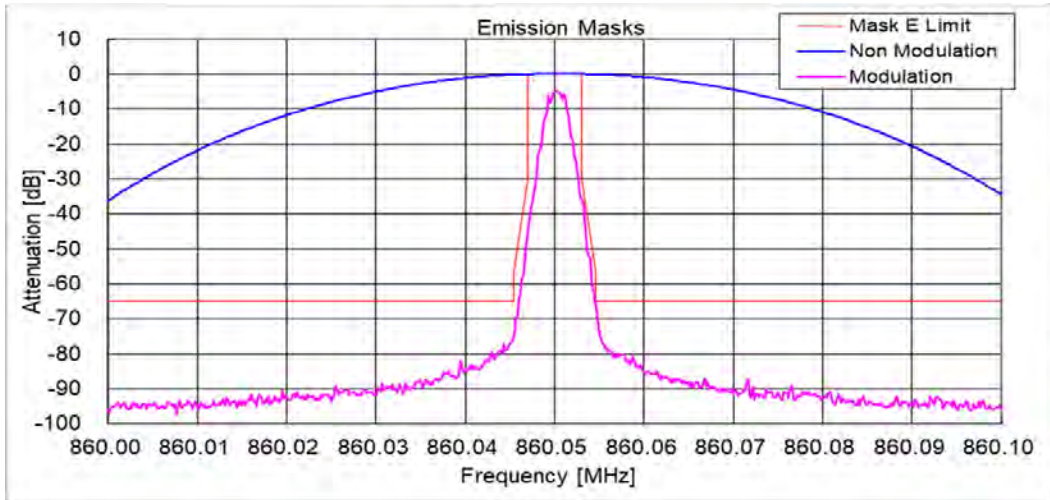

State : Low Power / Authorized Bandwidth 6 kHz/ 4K00F1E / F1D / F7W / 868.95 MHz(Band 2)
Limit : Mask E

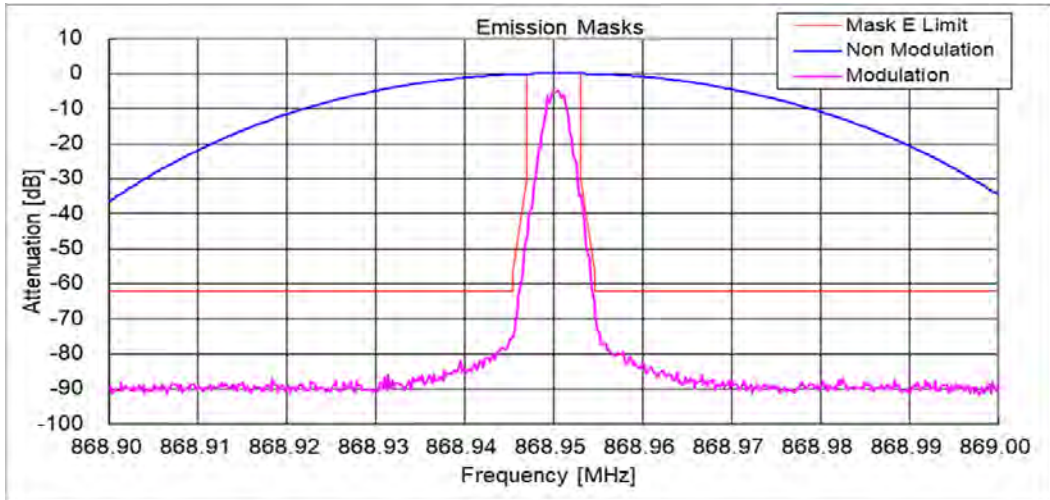

State : High Power / Authorized Bandwidth 20 kHz/ 4K00F2D / 806.05 MHz(Band 1)
Limit : Mask H

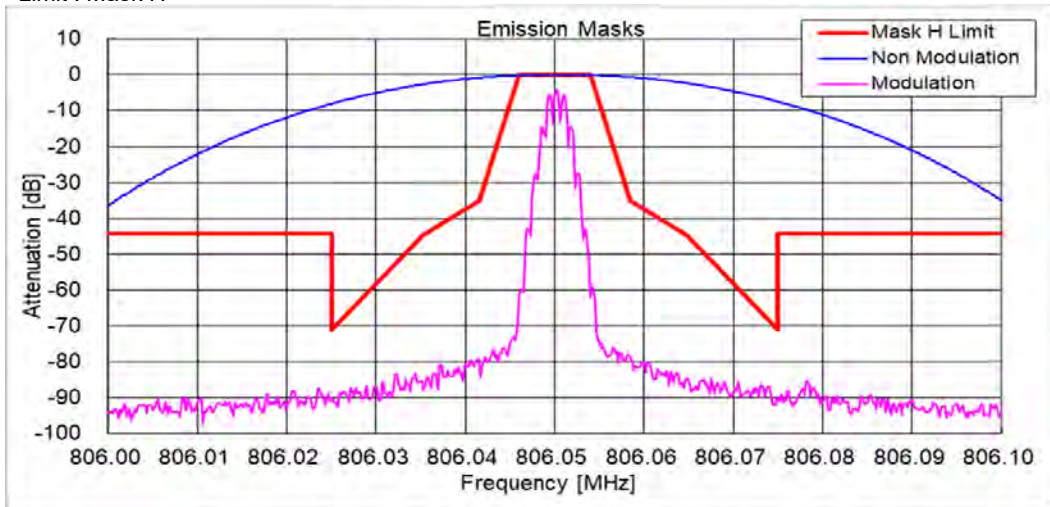

State : Low Power / Authorized Bandwidth 20 kHz/ 4K00F2D / 806.05 MHz(Band 1)
Limit : Mask H

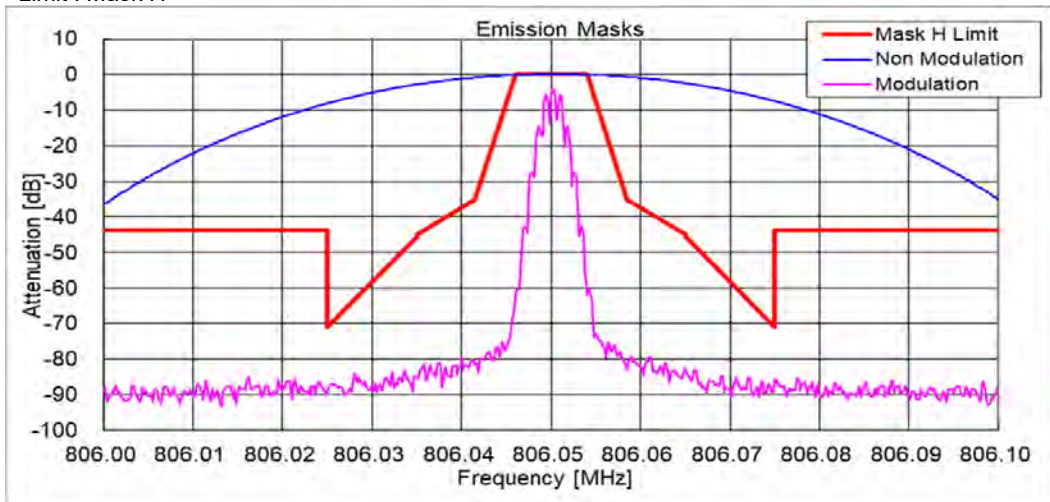

State : High Power / Authorized Bandwidth 20 kHz/ 4K00F2D / 851.05 MHz(Band 2)
Limit : Mask H

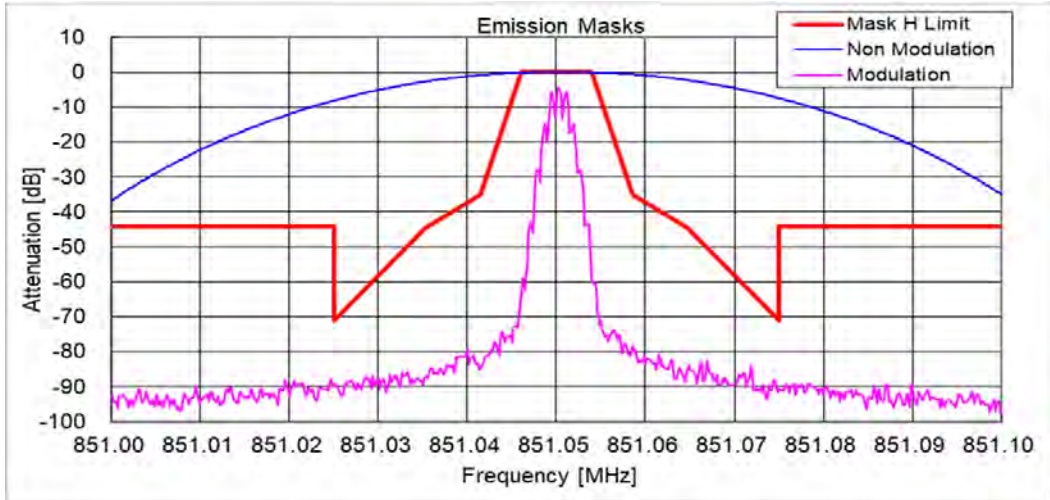

State : Low Power / Authorized Bandwidth 20 kHz/ 4K00F2D / 851.05 MHz(Band 2)
Limit : Mask H

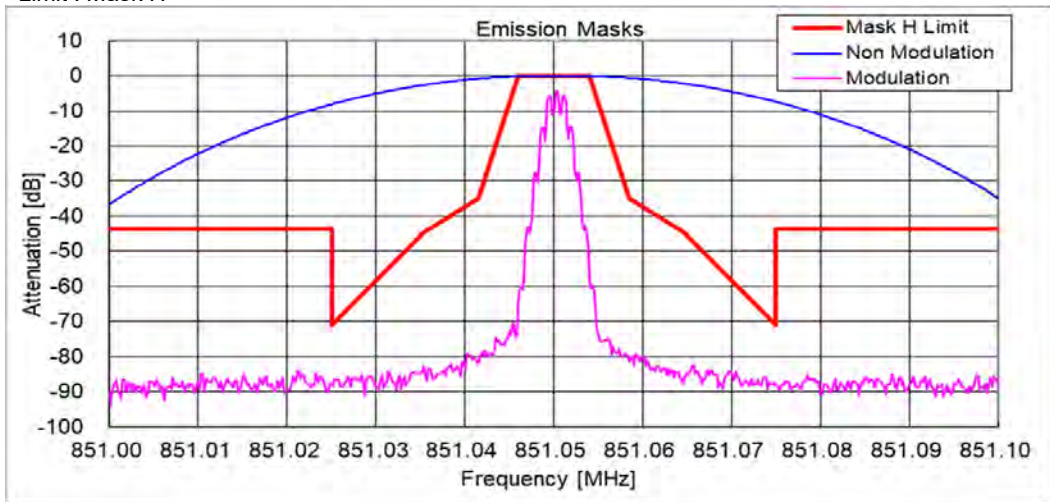

State : High Power / Authorized Bandwidth 20 kHz/ 4K00F2D / 823.95 MHz(Band 1)
Limit : Mask G / EA

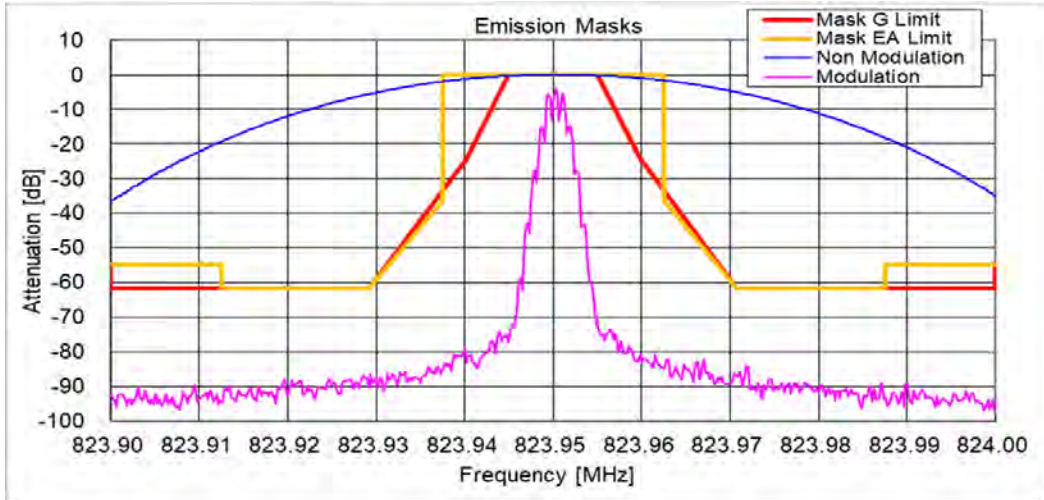

State : Low Power / Authorized Bandwidth 20 kHz/ 4K00F2D / 823.95 MHz(Band 1)
Limit : Mask G / EA

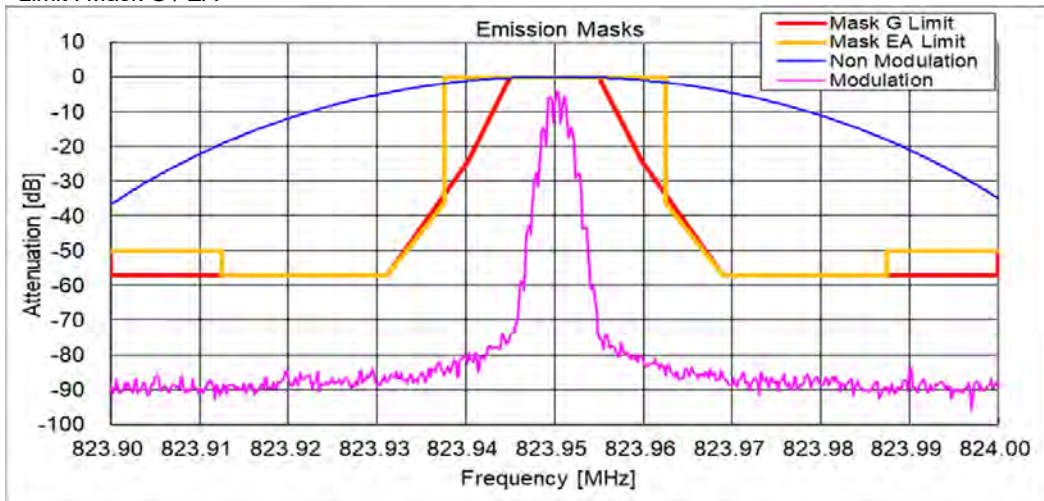

State : High Power / Authorized Bandwidth 20 kHz/ 4K00F2D / 860.05 MHz(Band 2)
Limit : Mask G / EA

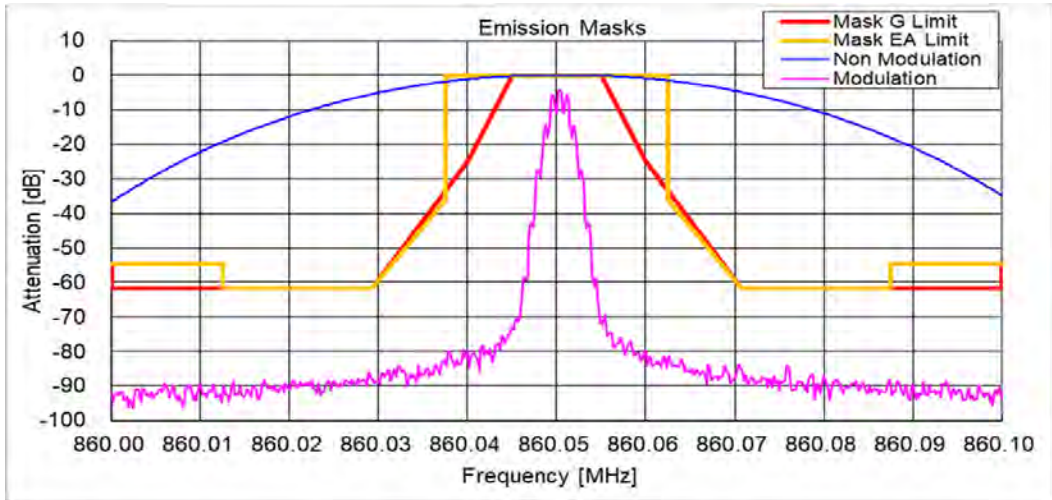

State : Low Power / Authorized Bandwidth 20 kHz/ 4K00F2D / 860.05 MHz(Band 2)
Limit : Mask G / EA

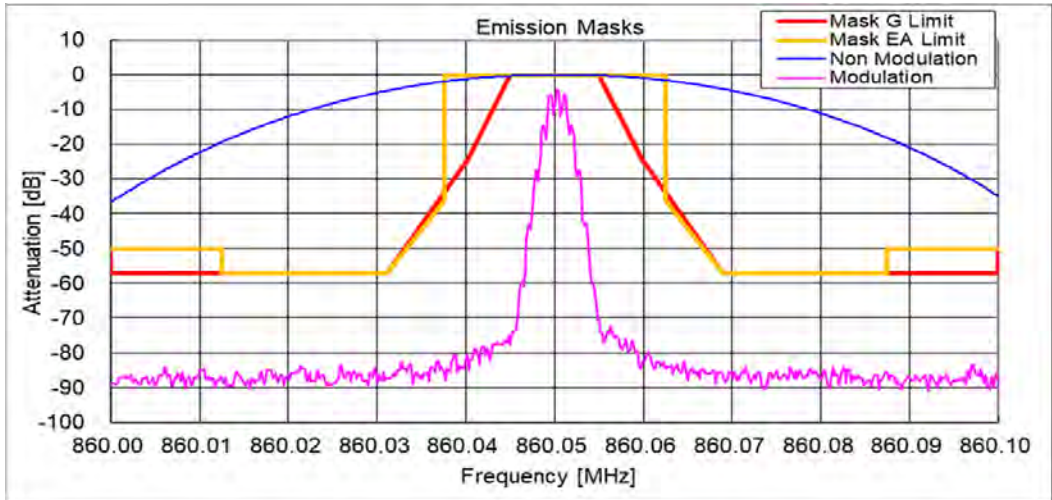

State : High Power / Authorized Bandwidth 6 kHz/ 4K00F2D / 815.05 MHz(Band 1)
Limit : Mask E

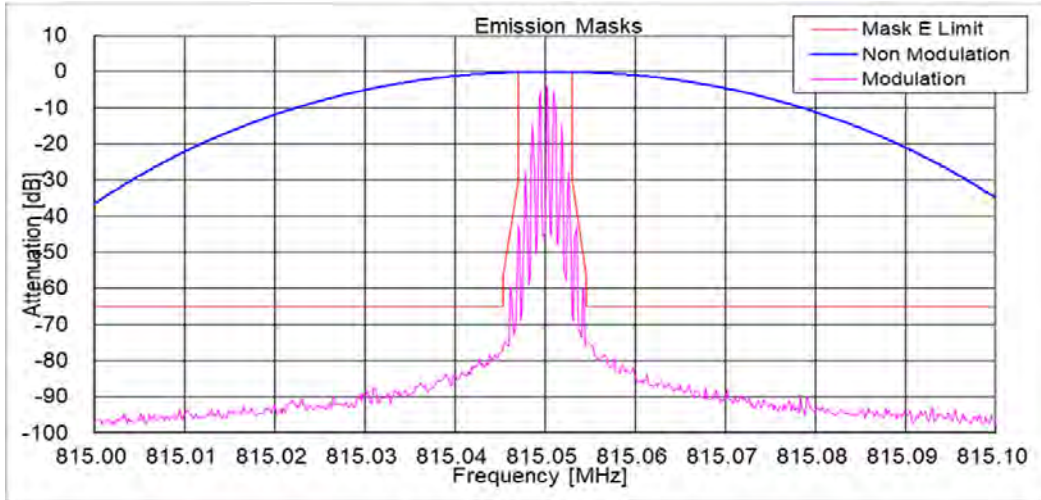

State : Low Power / Authorized Bandwidth 6 kHz/ 4K00F2D / 823.95 MHz(Band 1)
Limit : Mask E

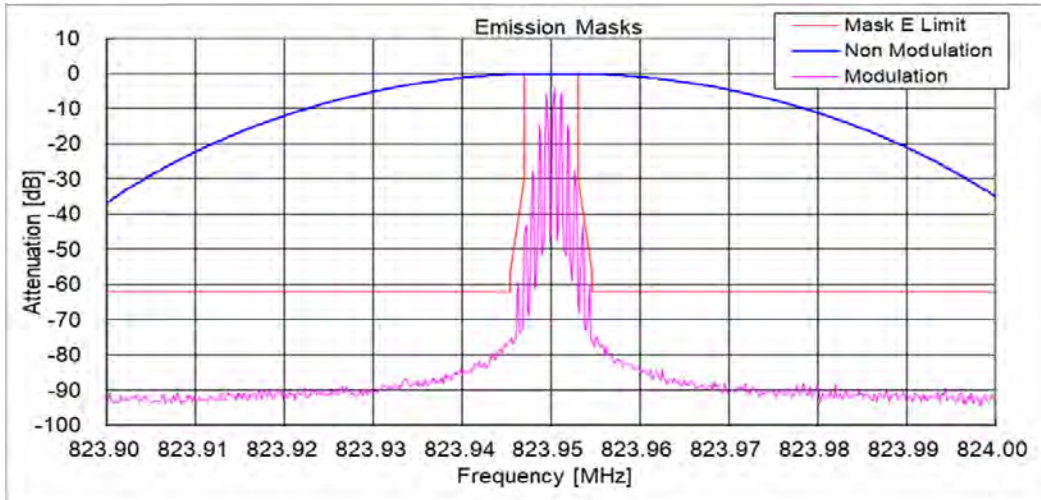

State : High Power / Authorized Bandwidth 6 kHz/ 4K00F2D / 860.05 MHz(Band 2)
Limit : Mask E

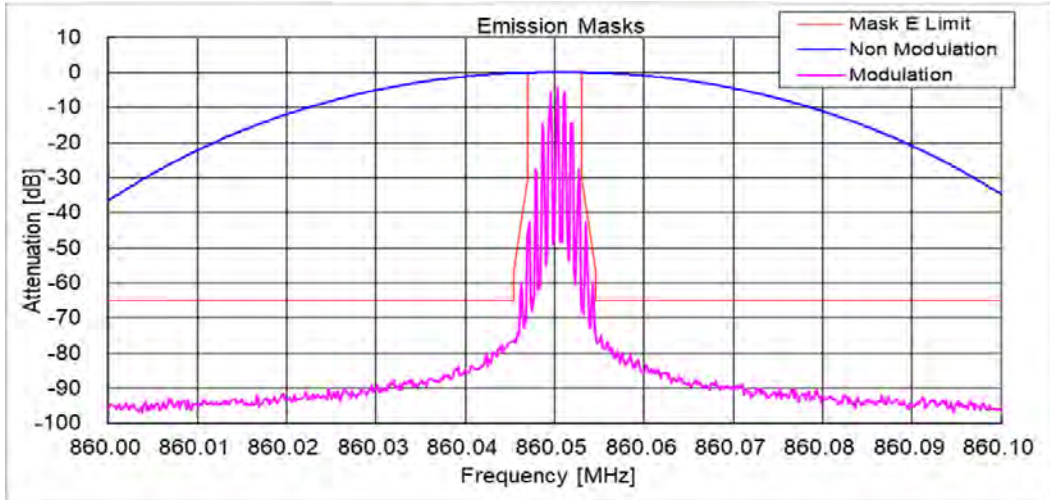

State : Low Power / Authorized Bandwidth 6 kHz/ 4K00F2D / 851.05 MHz(Band 2)
Limit : Mask E

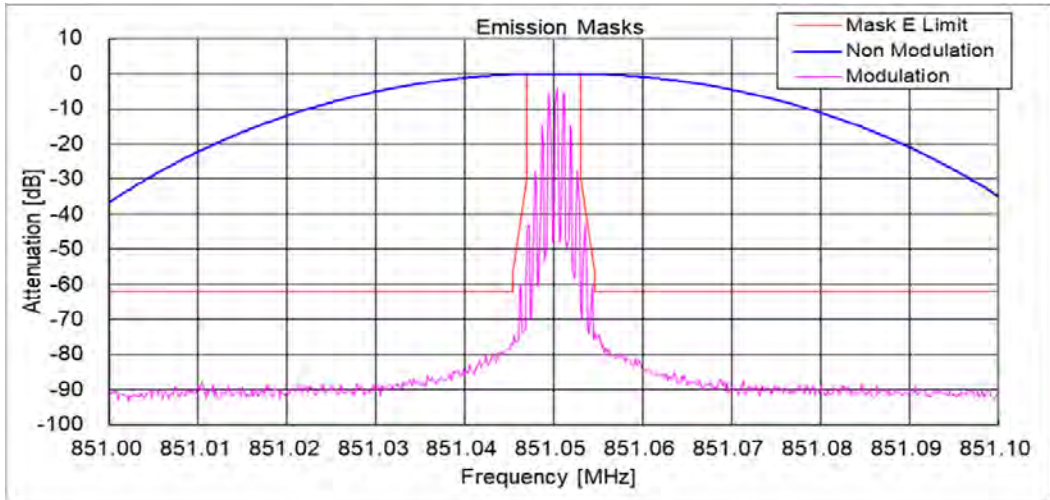

10.5 Audio Frequency Response / Audio Low Pass Filter (Voice Input)

REGULATIONS	: FCC Part 2 Section 1047 (a)
TEST METHOD/GUIDE	: ANSI/TIA-603-E Section 2.2.6.2.2, 3.2.6.2

Test Procedure

- 1 The EUT and test equipment were set up as shown on the following page.
- 2 Adjust the Modulation Analyzer for the following setting:
 - a) High-pass filter : 50 Hz
 - b) Low-pass filter : 15 kHz
 - c) Detector : positive peak
 - d) Function : FM
- 3 The audio signal input was adjusted to obtain 20 % modulation at 1 kHz, and this point was taken as the 0 dB reference level.
- 4 With input levels held constant and below limiting at all frequencies, the audio signal generator was varied from 100 Hz to 5 kHz.
- 5 The response in dB relative to 1 kHz was then measured, using the Modulation Analyzer.

Measuring Equipments

No.	Equipment	Manufacture	Model No.	Serial No.	Cal. Interval	Effective period
1	Attenuator (20dB)	Aeroflex/Wenshel	66-20-34	BY4357	1Y	Jul. 31, 19
2	Attenuator (30dB)	Weinschel	WA-29-30-34	8923	1Y	Jul. 31, 19
3	Modulation Analyzer	Hewlett Packard	8901B	3403A04852	1Y	Dec. 31, 18
4	Audio Generator	Anritsu	MG443B	M70150	1Y	Sep. 30, 19
5	Audio Analyzer	Hewlett Packard	8903B	2948A07326	1Y	Mar. 31, 19
6	DC Power Supply	Daiichi denpa kogyo	GZV4000	90290931	None	None
7	Digital Multi Meter	FLUKE	8846A	9642018	1Y	Sep. 30, 19

Measuring Cables

No.	Cable	Manufacture	Model No.	Serial No.	Cal. Interval	Effective period
W2	Balance Cable	Nicoon	3D-2V	KSR00092	1Y	Feb. 28, 19
W4	Coaxial Cable	Pacific custom	RG-58 C/U	KSR00096	1Y	Feb. 28, 19
W3	Coaxial Cable	Pacific custom	RG-58 C/U	AM90C04	1Y	Feb. 28, 19

Measuring Equipment Configuration

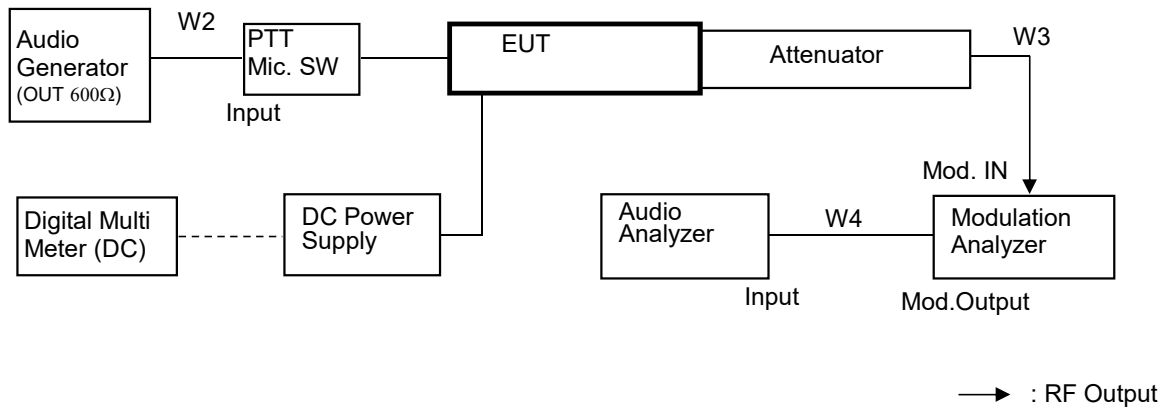

Test Results

Test date	Nov 19, 2018	
Location	Kashima No.12 Test Site	
temperature	25.7	[degree C]
Humidity Variation	47	[%]
Atmospheric Pressure	100.9	[kPa]
Test Engineer	Koichi Wagatsuma	

Test was carried out for all the frequency band of section 10.1
 State the worst case (below).

State : High Power / Authorized Bandwidth 20 kHz / 16K0F3E / 815.05 MHz(Band 1)

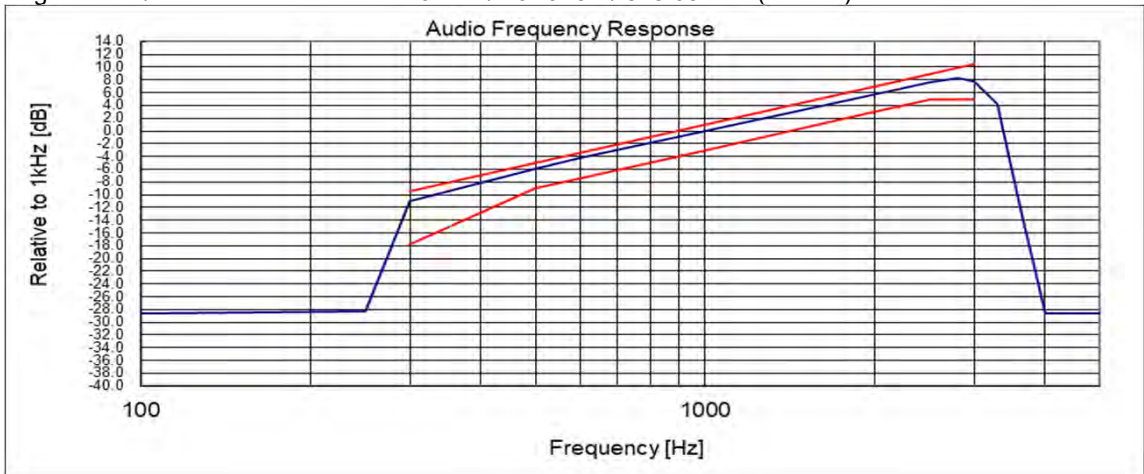

Note:

Audio Filter of the above result is substituted with the same structure as Audio Frequency Response.
 On the transmission condition below 3kHz,
 Transceiver shows pre-emphasis condition of transmission function.
 On the transmission condition above 3kHz, Transceiver shows Audio Low Pass Filter.

State : High Power / Authorized Bandwidth 20 kHz / 16K0F3E / 860.05 MHz(Band 2)

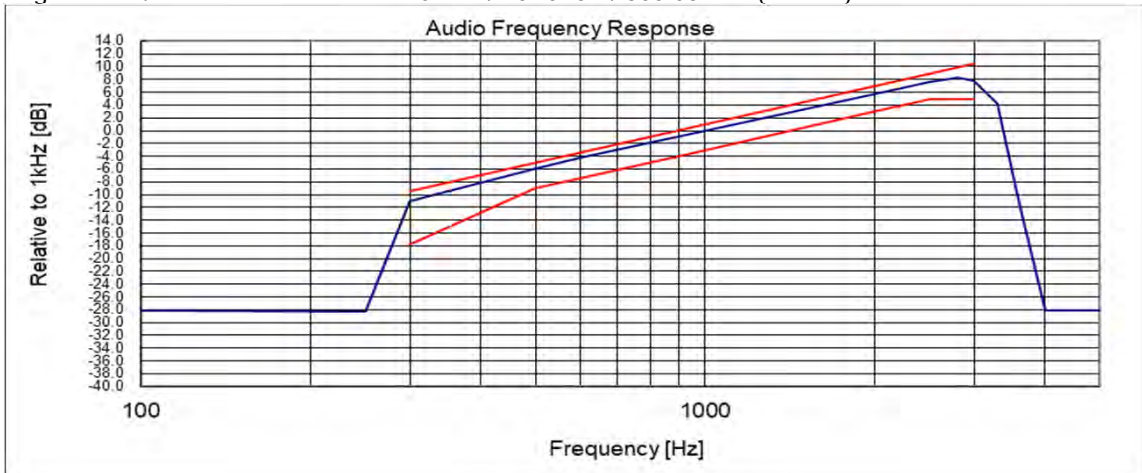

Note:

Audio Filter of the above result is substituted with the same structure as Audio Frequency Response.

On the transmission condition below 3kHz,

Transceiver shows pre-emphasis condition of transmission function.

On the transmission condition above 3kHz, Transceiver shows Audio Low Pass Filter.

State : High Power / Authorized Bandwidth 20 kHz / 14K0F3E / 806.05 MHz(Band 1)

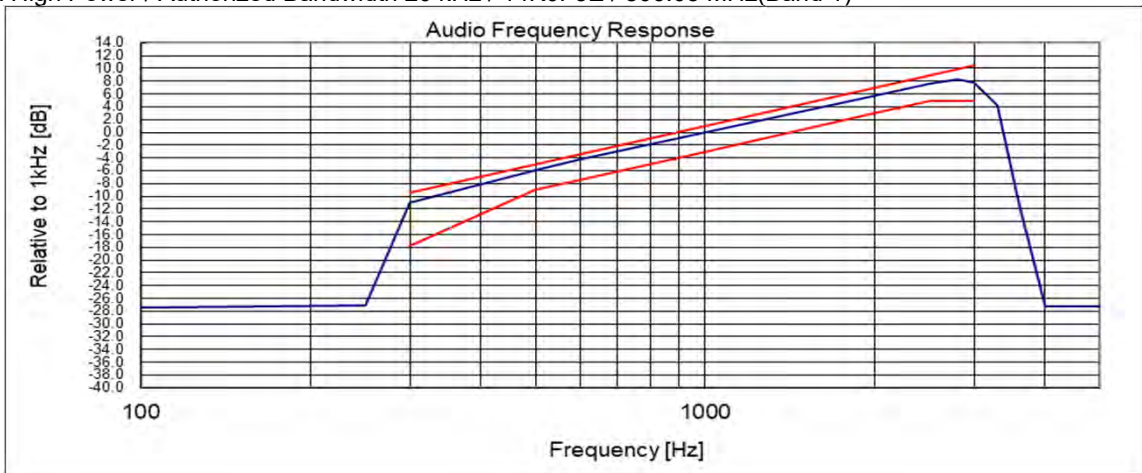

Note:

Audio Filter of the above result is substituted with the same structure as Audio Frequency Response.

On the transmission condition below 3kHz,

Transceiver shows pre-emphasis condition of transmission function.

On the transmission condition above 3kHz, Transceiver shows Audio Low Pass Filter.

State : High Power / Authorized Bandwidth 20 kHz / 14K0F3E / 851.05 MHz(Band 2)

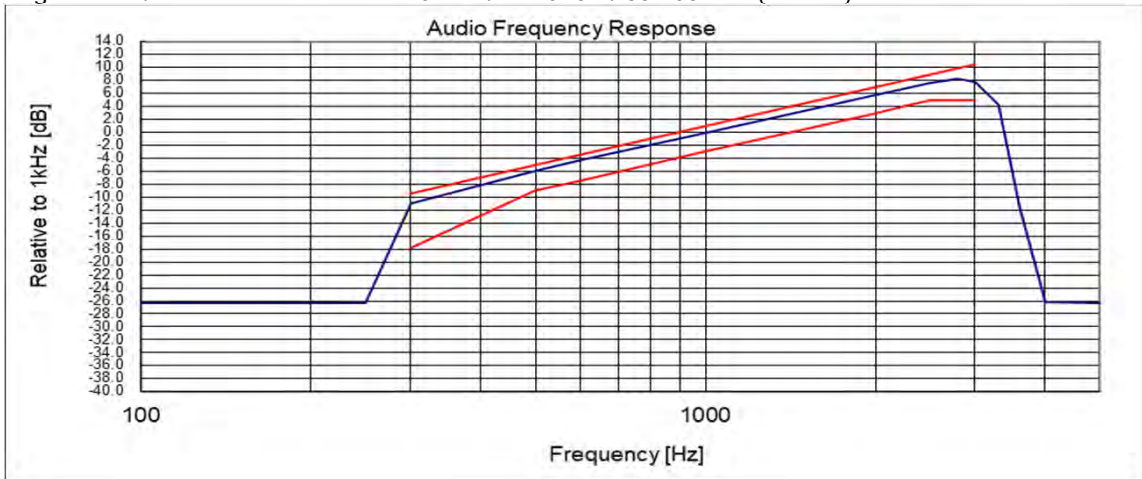

Note:

Audio Filter of the above result is substituted with the same structure as Audio Frequency Response.

On the transmission condition below 3kHz,

Transceiver shows pre-emphasis condition of transmission function.

On the transmission condition above 3kHz, Transceiver shows Audio Low Pass Filter.

State : High Power / Authorized Bandwidth 20 kHz / 11K0F3E / 815.05 MHz(Band 1)

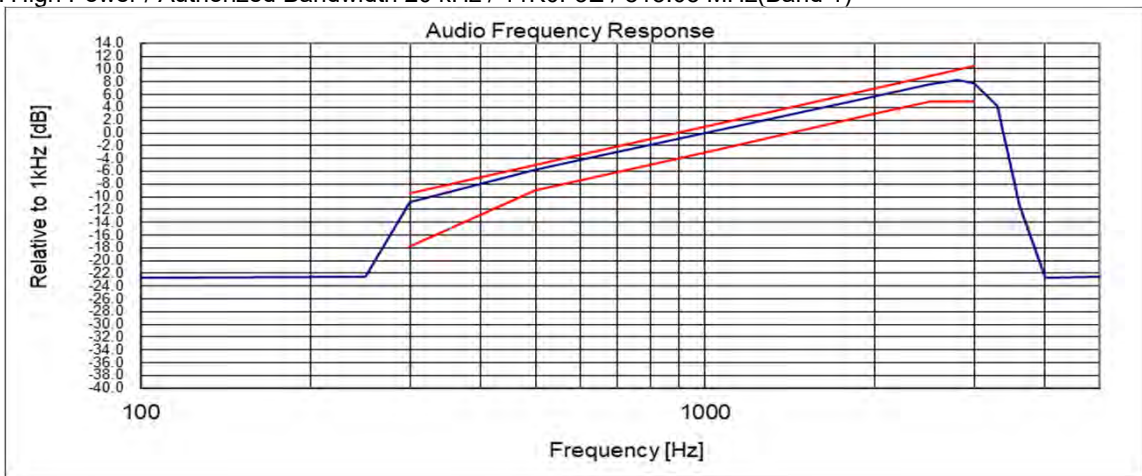

Note:

Audio Filter of the above result is substituted with the same structure as Audio Frequency Response.

On the transmission condition below 3kHz,

Transceiver shows pre-emphasis condition of transmission function.

On the transmission condition above 3kHz, Transceiver shows Audio Low Pass Filter.

State : High Power / Authorized Bandwidth 20 kHz / 11K0F3E / 851.05 MHz(Band 2)

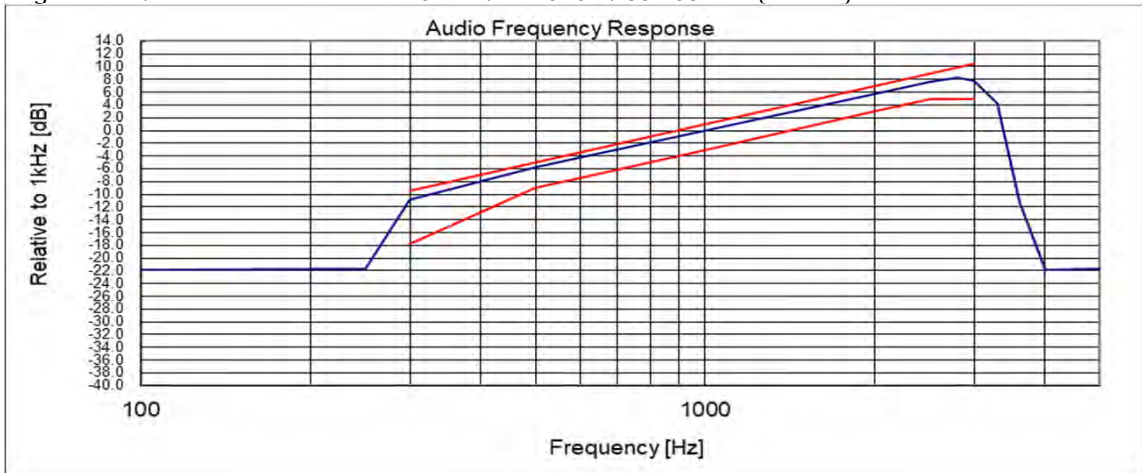

Note:

Audio Filter of the above result is substituted with the same structure as Audio Frequency Response.

On the transmission condition below 3kHz,

Transceiver shows pre-emphasis condition of transmission function.

On the transmission condition above 3kHz, Transceiver shows Audio Low Pass Filter.

10.6 Modulation Limiting

REGULATIONS	: FCC Part 2 Section 1047 (b)
TEST METHOD/GUIDE	: ANSI/TIA-603-E Section 2.2.3.2, 1.3.4.4

Test Procedure

- 1 The EUT and test equipment were set up as shown on the following page.
- 2 Adjust the Modulation Analyzer for the following setting:
 - a) High-pass filter : off
 - b) Low-pass filter : 15 kHz
 - c) Detector : positive peak
 - d) Function : FM
- 3 Apply a 1kHz modulation signal to the transmitter from the audio generator, and adjust the level to obtain 60% of full rated system deviation.
- 4 Measure the modulation frequency that was showed on the Modulation Analyzer when the output levels of the Audio Generator were changed from -20 dB to +50 dB by 10 dB.
- 5 Set the output frequencies of the Audio Generator 300 Hz and 3 kHz, and repeat test procedure 4.
- 6 Set the Detector of the Modulation Analyzer Negative Peak.
- 7 Repeat test procedure 4 and 5.

Measuring Equipments

No.	Equipment	Manufacture	Model No.	Serial No.	Cal. Interval	Effective period
1	Attenuator (20dB)	Aeroflex/Wenshel	66-20-34	BY4357	1Y	Jul. 31, 19
2	Attenuator (30dB)	Weinschel	WA-29-30-34	8923	1Y	Jul. 31, 19
3	Modulation Analyzer	Hewlett Packard	8901B	3403A04852	1Y	Dec. 31, 18
4	Audio Generator	Anritsu	MG443B	M70150	1Y	Sep. 30, 19
5	DC Power Supply	Daiichi denpa kogyo	GZV4000	90290931	None	None
4	Digital Multi Meter	FLUKE	8846A	9642018	1Y	Sep. 30, 19

Measuring Cables

No.	Cable	Manufacture	Model No.	Serial No.	Cal. Interval	Effective period
W2	Balance Cable	Nicoon	3D-2V	KSR00092	1Y	Feb. 28, 19
W3	Coaxial Cable	Pacific custom	RG-58 C/U	AM90C04	1Y	Feb. 28, 19

Measuring Equipment Configuration

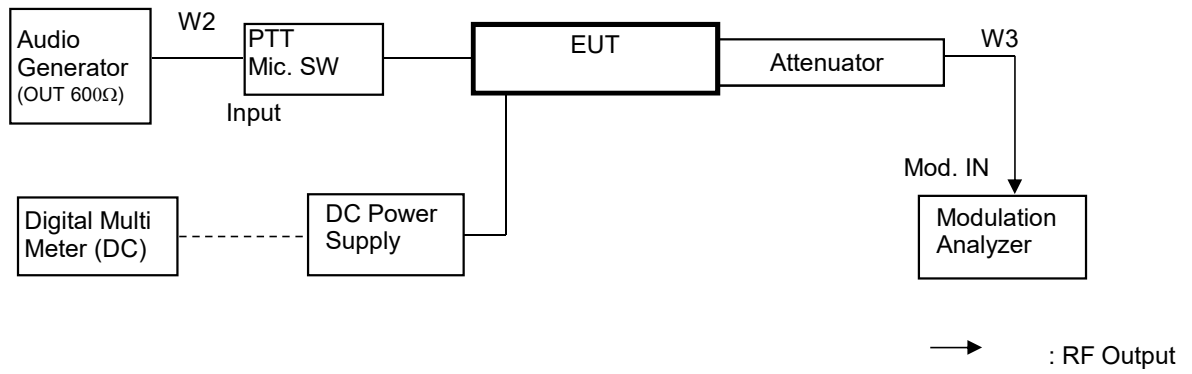

Test Results

Test date	Nov. 19, 2018	
Location	Kashima No.12 Test Site	
temperature	24.7	[degree C]
Humidity Variation	45	[%]
Atmospheric Pressure	100.9	[kPa]
Test Engineer	Koichi Wagatsuma	

Test was carried out for all the frequency band of section 10.1
 State the worst case (below).

State : High Power / Authorized Bandwidth 20 kHz / 16K0F3E / 806.05 MHz(Band 1)

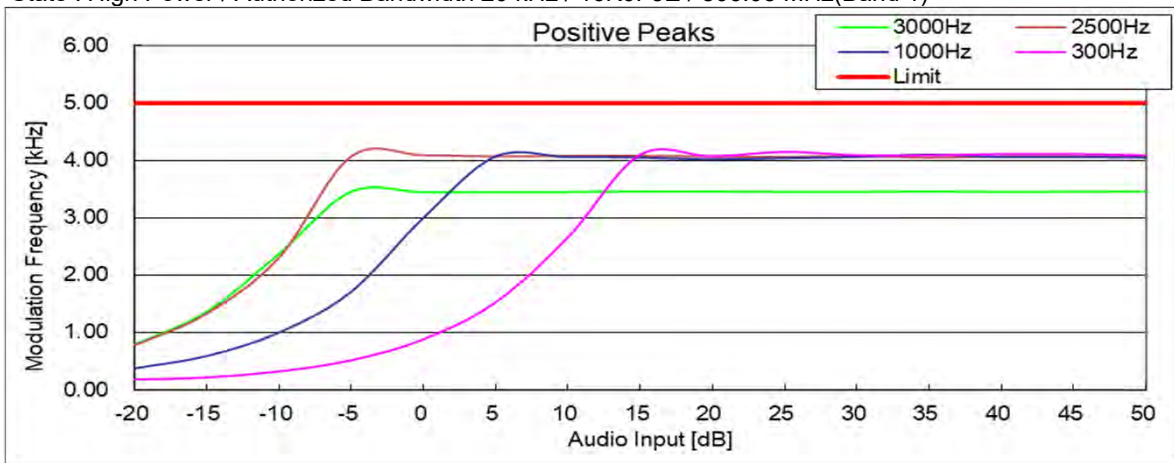

State : High Power / Authorized Bandwidth 20 kHz / 16K0F3E / 806.05 MHz(Band 1)

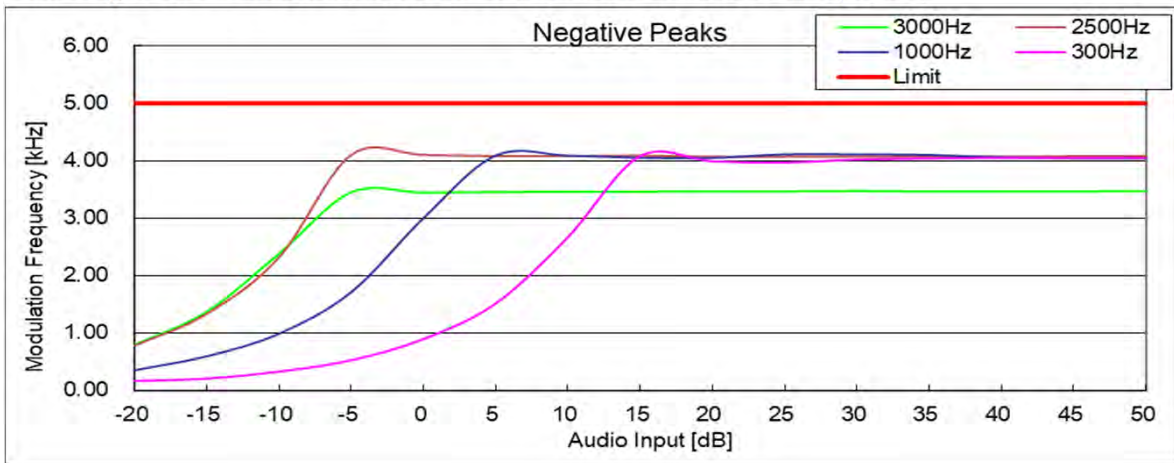

State : High Power / Authorized Bandwidth 20 kHz / 16K0F3E / 860.05 MHz(Band 2)

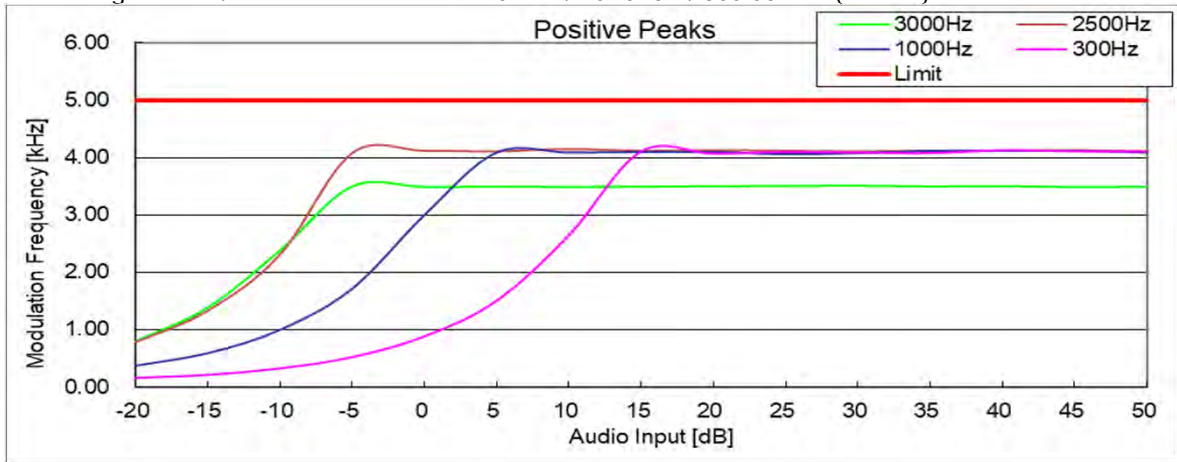

State : High Power / Authorized Bandwidth 20 kHz / 16K0F3E / 860.05 MHz(Band 2)

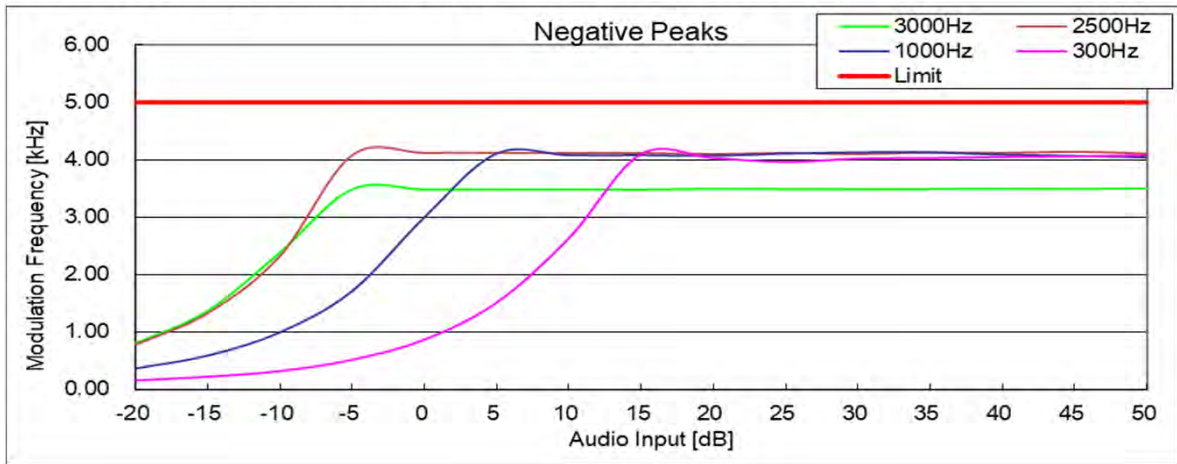

State : High Power / Authorized Bandwidth 20 kHz / 14K0F3E / 823.95 MHz(Band 1)

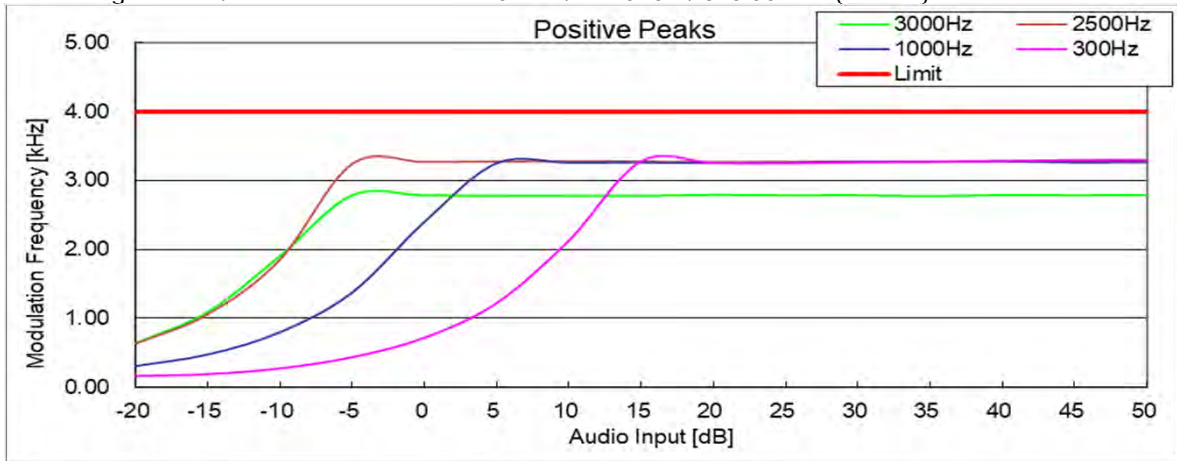

State : High Power / Authorized Bandwidth 20 kHz / 14K0F3E / 823.95 MHz(Band 1)

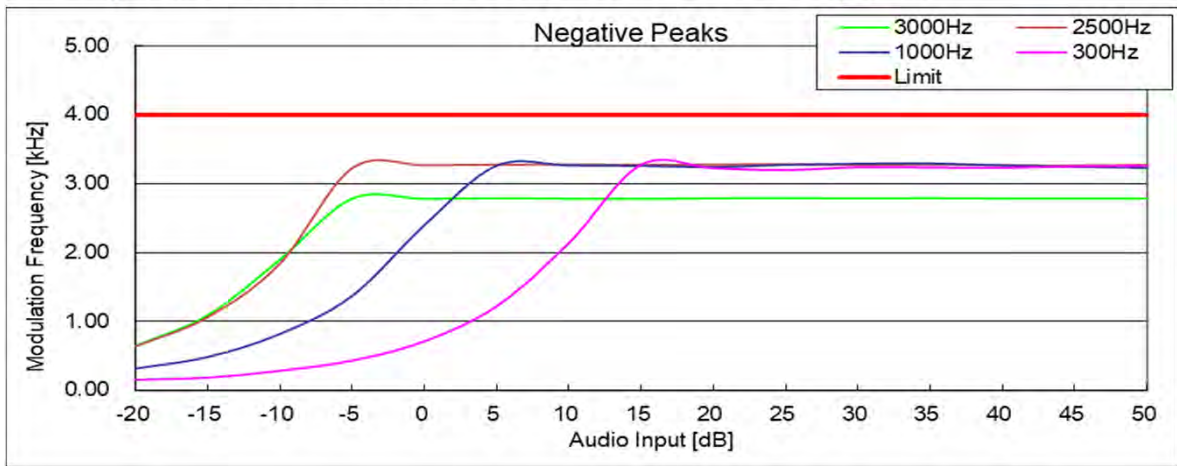

State : High Power / Authorized Bandwidth 20 kHz / 14K0F3E / 868.95 MHz(Band 2)

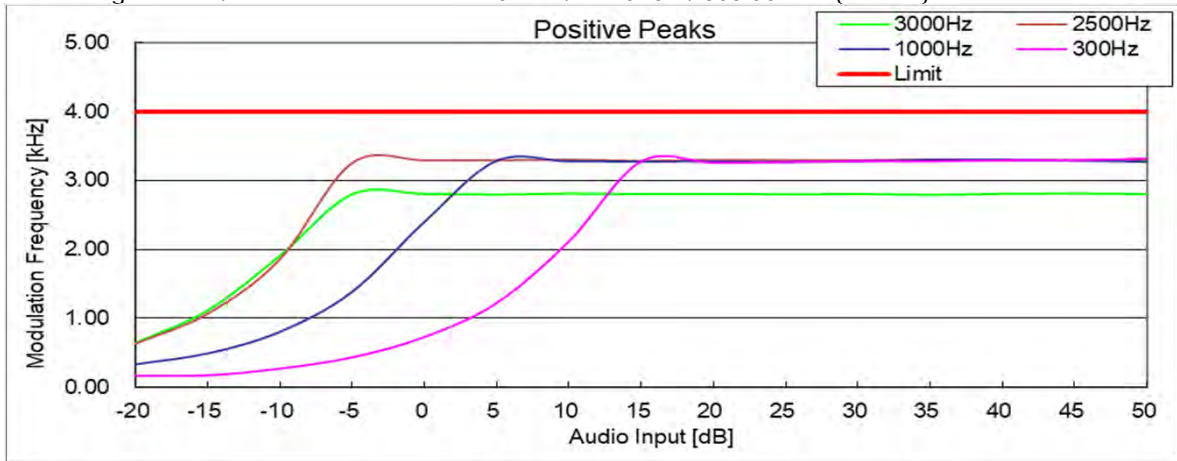

State : High Power / Authorized Bandwidth 20 kHz / 14K0F3E / 868.95 MHz(Band 2)

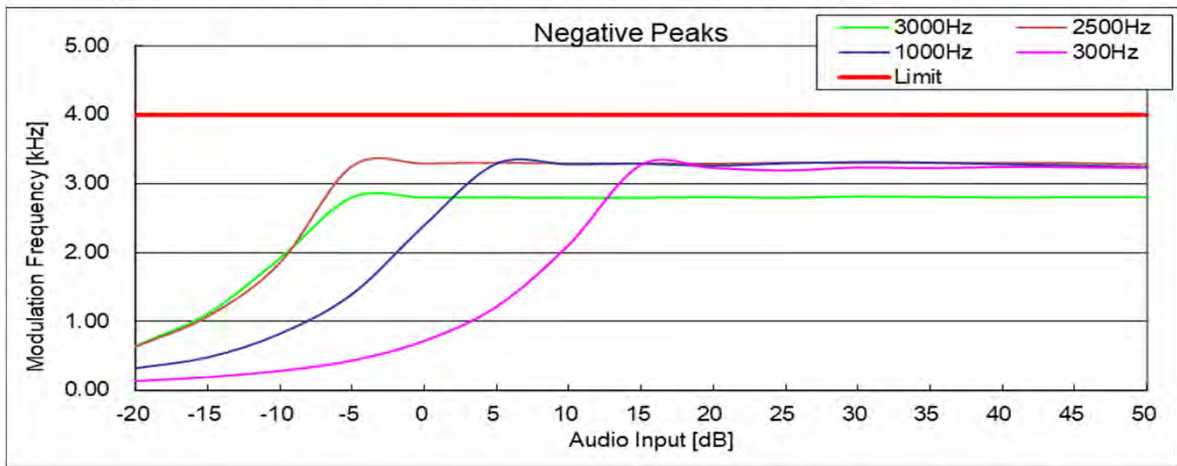

State : High Power / Authorized Bandwidth 20 kHz / 11K0F3E / 815.05 MHz(Band 1)

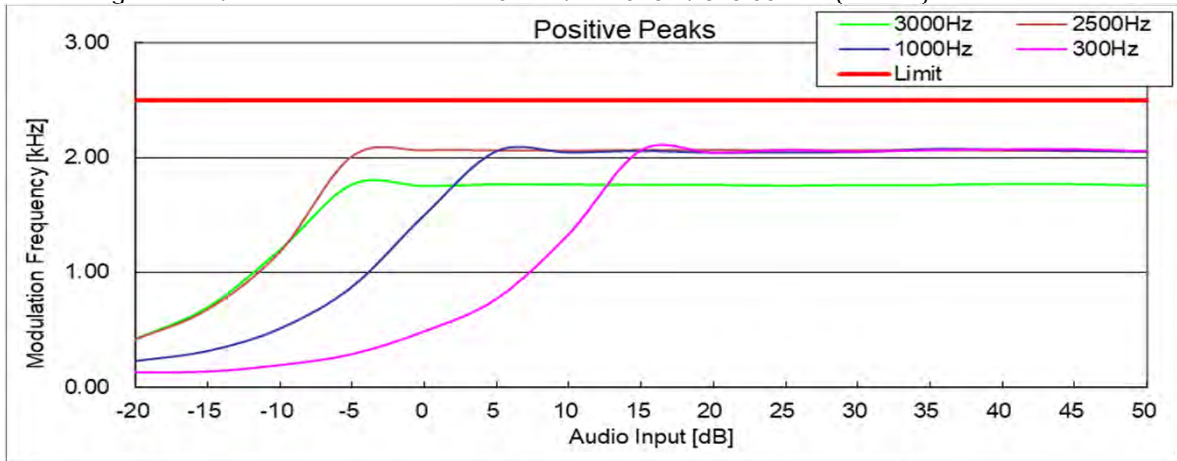

State : High Power / Authorized Bandwidth 20 kHz / 11K0F3E / 815.05 MHz(Band 1)

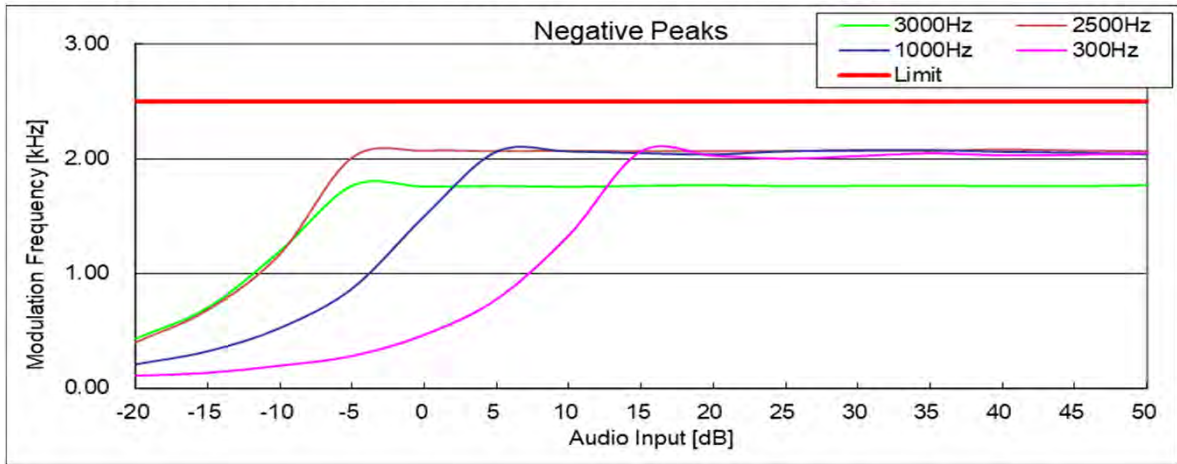

State : High Power / Authorized Bandwidth 20 kHz / 11K0F3E / 868.95 MHz(Band 2)

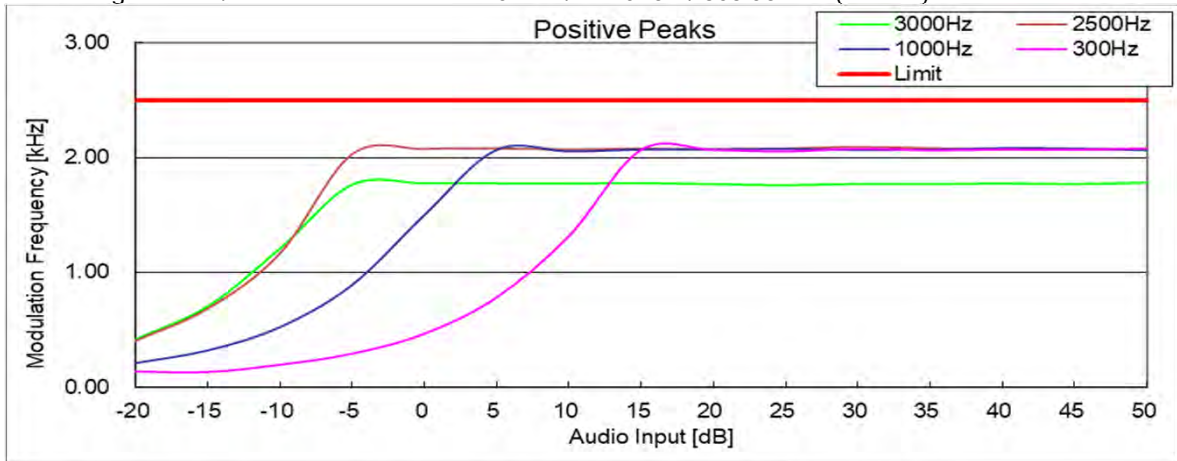

State : High Power / Authorized Bandwidth 20 kHz / 11K0F3E / 868.95 MHz(Band 2)

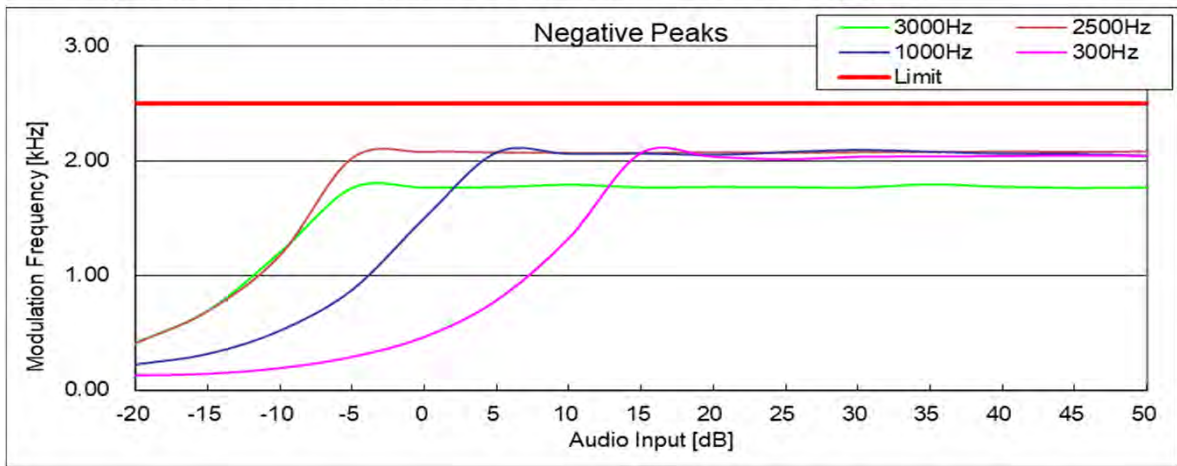

10.7 Frequency Stability (Temperature Variation)

REGULATIONS	: FCC Part 2 Section 1055 (a) (1), Part 90 Section 213(a) / RSS-119 Section 5.3
TEST METHOD/GUIDE	: ANSI/TIA-603-E Section 2.2.2.2 / RSS-Gen Section 6.11

Test Procedure

- 1 The EUT and test equipment were set up as shown on the following page.
- 2 Set the temperature -30 degrees C.
- 3 Leave the EUT for 1 hour after it became the temperature that was set up.
- 4 Make the EUT the transmitting state.
measure the output frequency.
- 5 Make the EUT the receiving state.
- 6 Set the temperature 50 degrees C by 10 degrees C.
And repeat test procedure 4 to 6.

Measuring Equipments

No.	Equipment	Manufacture	Model No.	Serial No.	Cal. Interval	Effective period
1	Attenuator (20dB)	Aeroflex/Wenshel	66-20-34	BY4357	1Y	Jul. 31, 19
2	Attenuator (30dB)	Weinschel	WA-29-30-34	8923	1Y	Jul. 31, 19
3	Modulation Analyzer	Hewlett Packard	8901B	3403A04852	1Y	Dec. 31, 18
4	DC Power Supply	Takasago	GP035-20R	1014199060	None	None
5	Digital Multi Meter	FLUKE	8846A	9642018	1Y	Sep. 30, 19
6	Temperature Chamber	Tabai	PL-3F	5103661	None	None
7	Temperature Meter	T&D	TR-71nw	52160B67	1Y	Dec. 31, 18
8	GPS Receiver	Hewlett Packard	HP Z3801A	3542A02414	None	None

Measuring Cables

No.	Cable	Manufacture	Model No.	Serial No.	Cal. Interval	Effective period
W2	Coaxial Cable	Pacific custom	RG-58 C/U	KSR00041	1Y	Feb. 28, 19
W1	Coaxial Cable	Suhner	SUCOFLEX104	KSR00042	1Y	Jul. 31, 19

Measuring Equipment Configuration

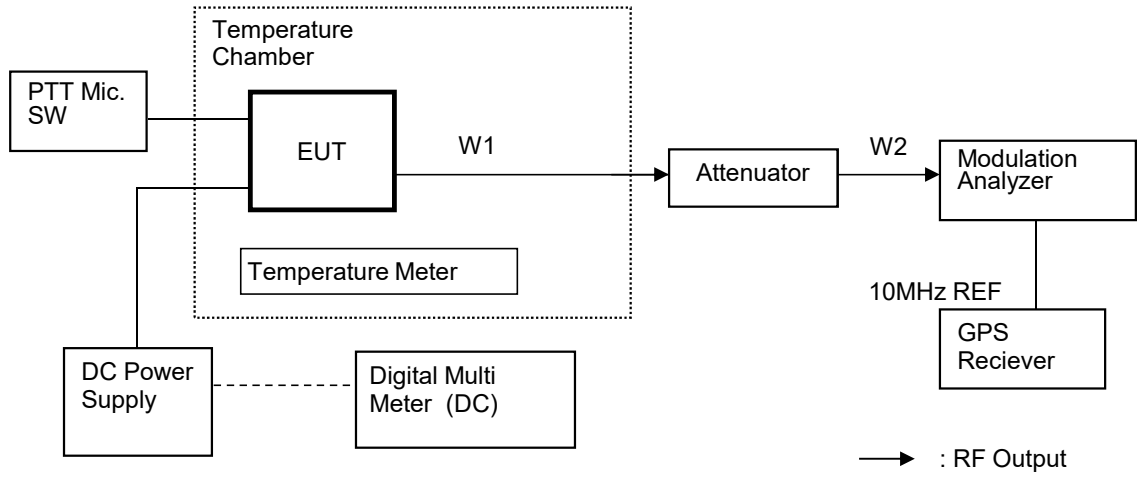

Test Results

Test date	Dec. 04, 2018
Location	Kashima No.12 Test Site
Test Engineer	Koichi Wagatsuma

Test was carried out for all the frequency band of section 10.1
 State the worst case (below).

State : High Power / Authorized Bandwidth 20 kHz / 823.95 MHz (Band 1)

Reference Frequency: 823.950190 MHz

No.	Temperature (Degree C)	Frequency (MHz)	Stability (ppm)	Limit (+/- ppm)	Min. Margin (ppm)
1	-30	823.949950	-0.29	0.4	0.11
2	-20	823.950000	-0.23	0.4	0.17
3	-10	823.950010	-0.22	0.4	0.18
4	0	823.950040	-0.18	0.4	0.22
5	10	823.950130	-0.07	0.4	0.33
6	20	823.950190	0.00	0.4	0.40
7	30	823.950280	0.11	0.4	0.29
8	40	823.950450	0.32	0.4	0.08
9	50	823.950450	0.32	0.4	0.08

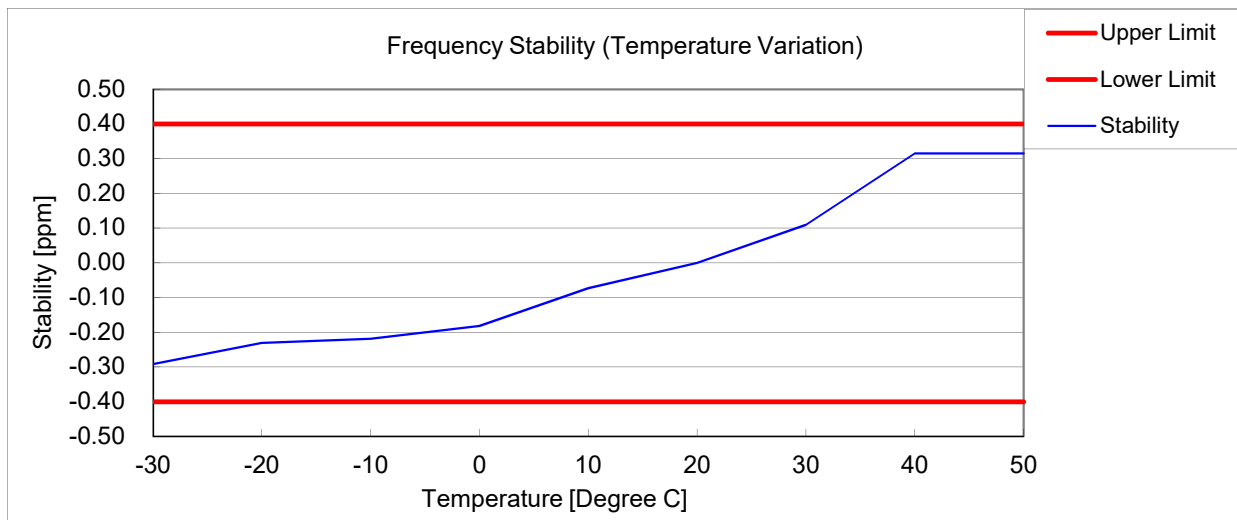

State : High Power / Authorized Bandwidth 20 kHz / 860.05 MHz (Band 2)

Reference Frequency: 860.050180 MHz

No.	Temperature (Degree C)	Frequency (MHz)	Stability (ppm)	Limit (+/- ppm)	Min. Margin (ppm)
1	-30	860.049940	-0.28	0.4	0.12
2	-20	860.049990	-0.22	0.4	0.18
3	-10	860.050020	-0.19	0.4	0.21
4	0	860.050050	-0.15	0.4	0.25
5	10	860.050150	-0.03	0.4	0.37
6	20	860.050180	0.00	0.4	0.40
7	30	860.050290	0.13	0.4	0.27
8	40	860.050450	0.31	0.4	0.09
9	50	860.050460	0.33	0.4	0.07

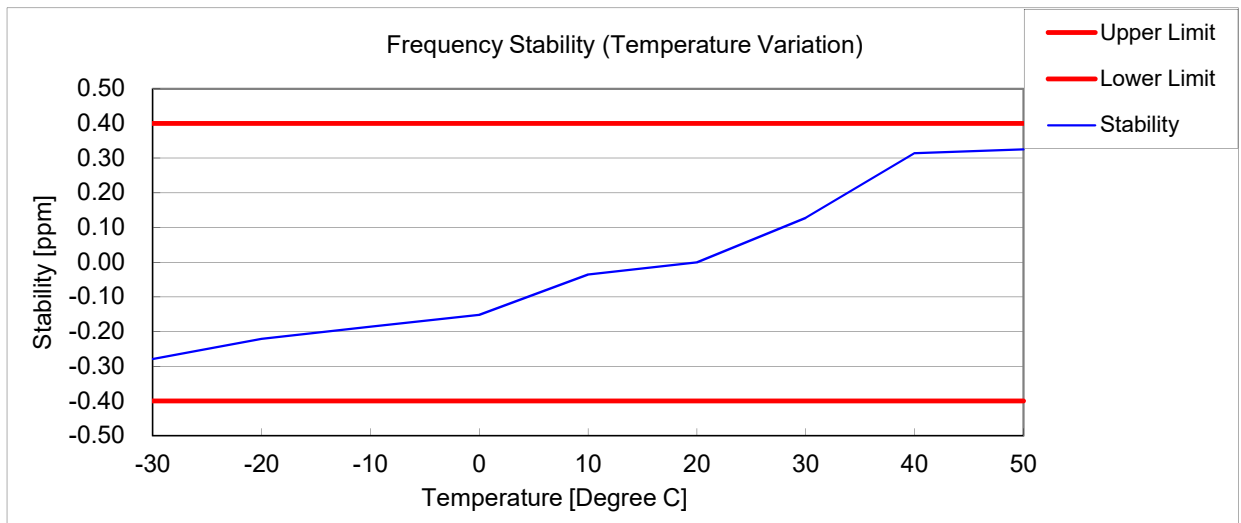

10.8 Frequency Stability (Voltage Variation)

REGULATIONS	: FCC Part 2 Section 1055 (a) (1), Part 90 Section 213(a) / RSS-119 Section 5.3
TEST METHOD/GUIDE	: ANSI/TIA-603-E Section 2.2.2.2 / RSS-Gen Section 6.11

Test Procedure

- 1 The EUT and test equipment were set up as shown on the following page.
- 2 The power supply voltage to the EUT was varied from 85 % to 115 % of the nominal value measured at the input to the EUT.

Measuring Equipments

No.	Equipment	Manufacture	Model No.	Serial No.	Cal. Interval	Effective period
1	Attenuator (20dB)	Aeroflex/Wenshel	66-20-34	BY4357	1Y	Jul. 31, 19
2	Attenuator (30dB)	Weinschel	WA-29-30-34	8923	1Y	Jul. 31, 19
3	Modulation Analyzer	Hewlett Packard	8901B	3403A04852	1Y	Dec. 31, 18
4	DC Power Supply	Takasago	GP035-20R	1014199060	None	None
5	Digital Multi Meter	FLUKE	8846A	9642018	1Y	Sep. 30, 19
6	Temperature Chamber	Tabai	PL-3F	5103661	None	None
7	Temperature Meter	T&D	TR-71nw	52160B67	1Y	Dec. 31, 18
8	GPS Receiver	Hewlett Packard	HP Z3801A	3542A02414	None	None

Measuring Cables

No.	Cable	Manufacture	Model No.	Serial No.	Cal. Interval	Effective period
W2	Coaxial Cable	Pacific custom	RG-58 C/U	KSR00041	1Y	Feb. 28, 19
W1	Coaxial Cable	Suhner	SUCOFLEX104	KSR00042	1Y	Jul. 31, 19

Measuring Equipment Configuration

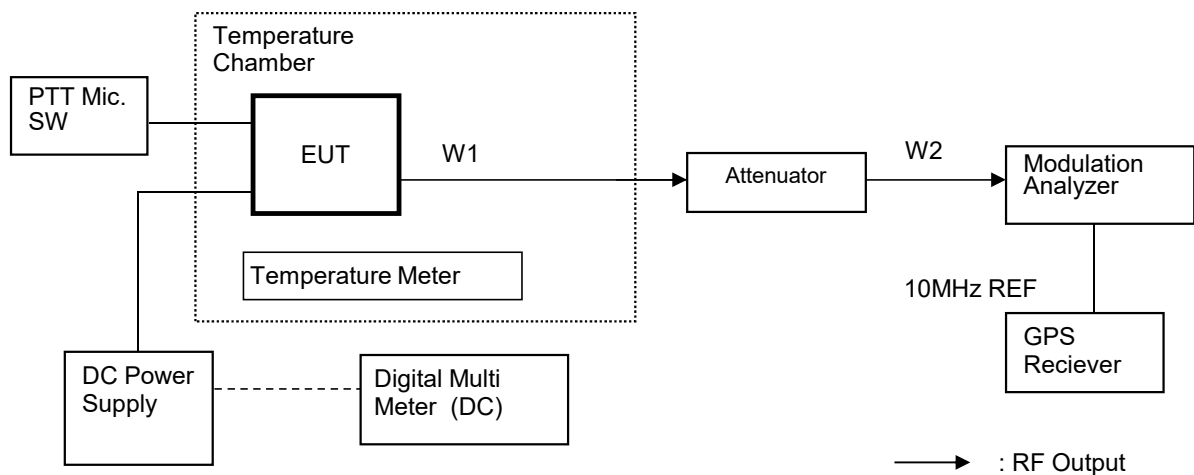

Test Results

Test date	Dec 04, 2018
Location	Kashima No.12 Test Site
Test Engineer	Koichi Wagatsuma

Test was carried out for all the frequency band of section 10.1
 State the worst case (below).

State : High Power / Authorized Bandwidth 20 kHz / 815.05 MHz (Band 1)

Reference Frequency: 815.050160 MHz

No.	Temperature (Degree C)	Diviation (%)	Voltage (V)	Frequency (MHz)	Stability (ppm)	Limit +/- (ppm)	Margin (ppm)
1	20+/-5	85	11.56	815.050170	0.01	0.4	0.39
2	20+/-5	100	13.60	815.050160	0.00	0.4	0.40
3	20+/-5	115	15.64	815.050180	0.02	0.4	0.38

State : High Power / Authorized Bandwidth 20 kHz / 851.05 MHz (Band 2)

Reference Frequency: 851.050170 MHz

No.	Temperature (Degree C)	Diviation (%)	Voltage (V)	Frequency (MHz)	Stability (ppm)	Limit +/- (ppm)	Margin (ppm)
1	20+/-5	85	11.56	851.050180	0.01	0.4	0.39
2	20+/-5	100	13.60	851.050170	0.00	0.4	0.40
3	20+/-5	115	15.64	851.050190	0.02	0.4	0.38

10.9 Receiver Spurious Emissions(Radiated)

REGULATIONS	:	RSS-Gen Section 7
TEST METHOD/GUIDE	:	RSS-Gen Section 7

TEST PROCEDURE

- 1 The EUT and test equipment were set up as shown on the following page.
- 2 Tabletop Equipment
EUT is placed on the wooden table, the top of which is 0.8meter above the metal ground plane(turntable).
- 3 Interconnecting Cables
Excess part of the interconnecting cables longer than 1 meter are bundled in the center.
Cables that hang closer than 40 cm to the ground plane is folded back and forth forming bundle to 40 cm long, hanging approx, in the middle between ground plane and table.
- 4 Measuring Instruments
Measuring instruments list and their calibration schedule are shown on Measurement Equipment Configuration.
The brief description are as follows;
- 5 Antennas
The broadband Bi-cog antenna or Biconical and Log periodic antenna is used for measurement on the frequency range 30 – 1000 MHz.
The Double ridged guide antenna is used for frequency higher than 1000 MHz.
- 6 Pre-amplifier
The broadband pre-amplifier is used for radiated emission measurement.
The signal to noise ratio is improved by using pre-amplifier.
- 7 Spectrum Analyzer
The spectrum analyzer is used for preliminary measurement of frequency range 30 – 1000 MHz, and also used for final measurement of higher than 1000 MHz (RBW : 1 MHz).
- 8 EMI Test Receiver
The Quasi-peak detector (IF bandwidth : 120 kHz) built in test receiver is used for final measurement of the frequency 30 – 1000 MHz.
The test receiver is complied with the specification of the CISPR publication 16.
- 9 Turntable
The turntable is capable for EUT weight and rotatable 0 to 360 degree horizontally by remote control in the test room.
- 10 Antenna Mast
The antenna mast is attachable to all antennas described on antenna height is adjustable 1 to 4 meters continuously by remote control at the test room, and antenna polarization is also changed by the remote control.
- 11 Preliminary Measurement
EUT is tested on all operating conditions.
The spectrum analyzer is set max-hold mode and swept during turntable was rotated 0 to 360 degree. Then spectrum chart are plotted out to find the worst emission conditions in configuration, operating mode, or ambient noise notation.

12 Final Measurement

The EUT operated in the condition where maximum emission is found in the preliminary test.

The turntable azimuth(EUT direction) and antenna height are adjusted the position so that maximum field strength is obtained for each frequency spectrum to be measured.

The equipment and cables are arranged or manipulated within the range of the test standard in the above condition.

When the uncertain result was obtained, the measurement is retried by using the half wave dipole antenna instead of the broadband antenna.

TEST EQUIPMENTS

No.	Equipment	Manufacture	Model No.	Serial No.	Cal. Interval	Effective period
1	Spectrum Analyzer	Agilent	N9030A	US51350220	1Y	Mar. 31, 19
2	Receiver	Agilent	N9038A	MY51210201	1Y	Nov. 30, 19
3	D.R.G Antenna(TX)	Schwarzbeck	3115	5044	1Y	Apr. 30, 19
4	Tri-log Antenna(RX)	Schwarzbeck	VULB9168WP	288	1Y	Jul. 31, 19
5	Horn Antenna with Preat	TSJ	MLA-18265-B03-	1694440	1Y	Mar. 31, 19
6	Amplifier	TOYO	TPA0118-30	0402	1Y	May. 31, 19
7	Attenuator	HUBER + SUHNER	6803.17.B	5111	1Y	May. 31, 19
8	Amplifier	Intertek Japan	ZX60-3018G	002	1Y	Aug. 31, 19
9	Attenuator	TAMAGAWA	CFA-01	A00040805	1Y	Aug. 31, 19
10	RF Switch	Intertek Japan	ACX-150-1	A12301501	1Y	Aug. 31, 19
11	Site Attenuation	-	-	-	1Y	Mar. 31, 19
12	SVSWR	-	-	-	1Y	Feb. 28, 19

USED CABLES

No.	Cable	Manufacture	Model No.	Serial No.	Cal. Interval	Effective period
R11	Coaxial Cable	FUJIKURA	5D-2W	R11	1Y	Aug. 31, 19
R1	Coaxial Cable	FUJIKURA	5D-2W	R1	1Y	Aug. 31, 19
R3	Coaxial Cable	FUJIKURA	10D-2W	R3	1Y	Aug. 31, 19
R5	Coaxial Cable	FUJIKURA	RG-5A/U	R5	1Y	Aug. 31, 19
R7	Coaxial Cable	MIYAZAKI	5D-2W	R7	1Y	Aug. 31, 19
R10	Coaxial Cable	FUJIKURA	5D-2W	R10	1Y	Aug. 31, 19
G1	Coaxial Cable	SUHNER	SUCOFLEX 104	229603	1Y	May. 31, 19
G2	Coaxial Cable	Candox	5B-048-98-98-5000	111130	1Y	May. 31, 19
G3	Coaxial Cable	Candox	5B-048-98-98-6000	120315	1Y	May. 31, 19

MEASUREMENT EQUIPMENT CONFIGURATION

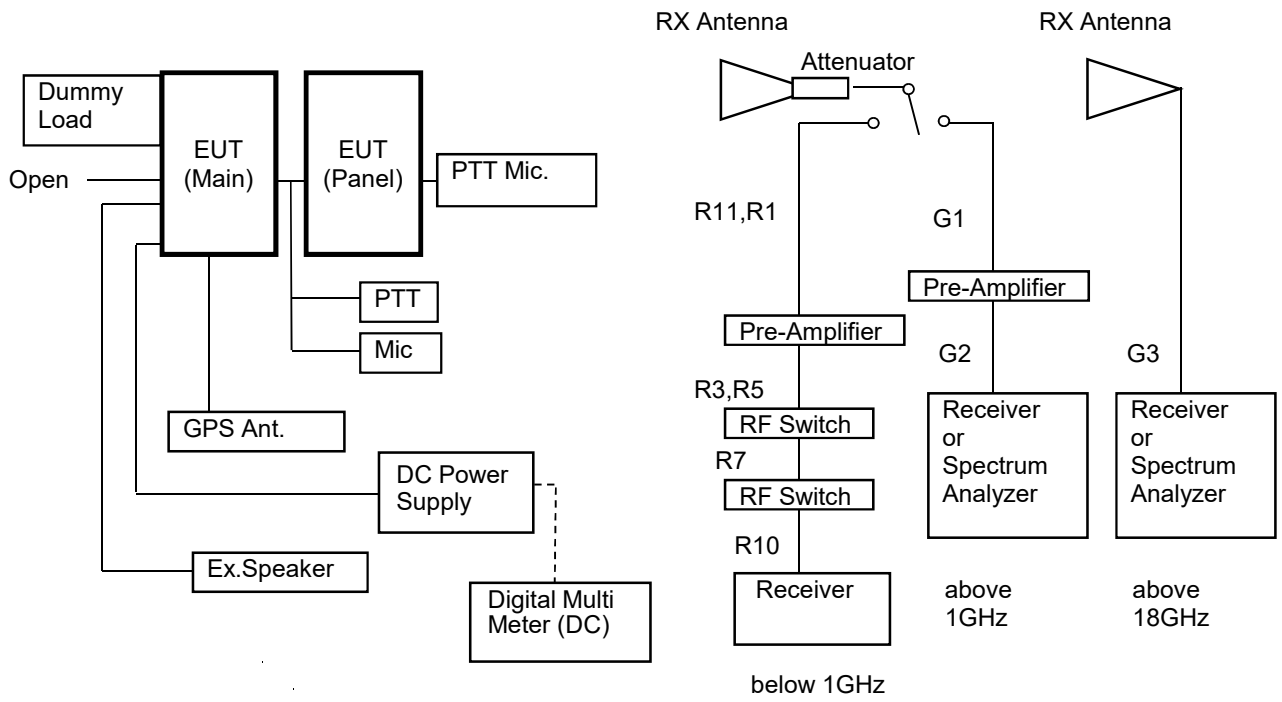

TEST RESULTS

Test date	Dec. 10, 2018
Location	Kashima No.12 Test Site
temperature	18.0 to 20.0 [degree C]
Humidity Variation	30.0 to 40.0 [%]
Atmospheric Pressure	100.5 to 103.0 [kPa]
Test Engineer	Koichi Wagatsuma

Test was carried out for the frequency band of section 10.1
 State the worst case (below).

State : 851.05 MHz Receiver Condition

No.	Frequency (MHz)	Pol	Mode	Reading Level (dBuv)	Factor* (dB)	Emission Level (dBuV/m)	Limit Level (dBuV/m)	Margin (dB)
1	38.74	Hor.		-	-2.5	-	40.0	-
		Ver.		17.6	-2.5	15.1	40.0	24.9
2	153.38	Hor.		-	-1.0	-	43.5	-
		Ver.		21.1	-1.0	20.1	43.5	23.4
3	337.80	Hor.		-	2.9	-	46.0	-
		Ver.		24.3	2.9	27.2	46.0	18.8
4	595.20	Hor.		19.9	10.2	30.1	46.0	15.9
		Ver.		-	10.2	-	46.0	-
5	825.60	Hor.		-	14.9	-	46.0	-
		Ver.		17.8	14.9	32.7	46.0	13.3
6	902.41	Hor.		-	16.1	-	46.0	-
		Ver.		22.1	16.1	38.2	46.0	7.8
7	940.81	Hor.		16.3	16.8	33.1	46.0	12.9
		Ver.		16.4	16.8	33.2	46.0	12.8
8	1209.61	Hor.	AVG	35.7	-4.0	31.7	54.0	22.3
		Ver.	AVG	30.8	-4.0	26.8	54.0	27.2
9	3404.20	Hor.	AVG	26.9	3.4	30.3	54.0	23.7
		Ver.	AVG	29.7	3.4	33.1	54.0	20.9
10	18723.10	Hor.	AVG	17.6	11.1	28.7	54.0	25.3
		Ver.	AVG	21.1	11.1	32.2	54.0	21.8

There is the margin of 20dB over except for the above points.

* Factor = Antenna, Antenna Pad, Cable, Preamp, (Dist. Conversion)

Emission Level = Reading Level + Factor

Note:

- 1 Measurement distance is 3 metres. (Above 1GHz is 4.1 meters)
- 2 Scanned frequency are 30 to 25000 MHz.
- 3 Highest oscillator frequency is 4960 MHz.
(TXRX UNIT : 1738MHz.)

10.10 Necessary Bandwidth and Emission Bandwidth

REGULATIONS	: FCC Part 2 Section 202 (g) & Federal Register/ Vol.68, No236 TRC 43
-------------	--

Calculation Results

State : 16K0F3E (Authorized Bandwidth 20 kHz)

Item	Mark		
Maximum Modulation	(M)	3	kHz
Maximum Deviation	(D)	5	kHz
Constant Factor	(K)	1	
Necessary Bandwidth	(Bn)	16	kHz

$B_n = (2 \times M) + (2 \times D \times K)$

- 1.types of modulation of the main carrier : F= Frequency modulation
- 2.nature of signal(s) modulating the main carrier: 3= A single channel containing analog information
- 3.type of information to be transmitted: E= Telephony (including sound broadcasting)

State : 14K0F3E (Authorized Bandwidth 20 kHz)

Item	Mark		
Maximum Modulation	(M)	3	kHz
Maximum Deviation	(D)	4	kHz
Constant Factor	(K)	1	
Necessary Bandwidth	(Bn)	14	kHz

$B_n = (2 \times M) + (2 \times D \times K)$

- 1.types of modulation of the main carrier : F= Frequency modulation
- 2.nature of signal(s) modulating the main carrier: 3= A single channel containing analog information
- 3.type of information to be transmitted: E= Telephony (including sound broadcasting)

State : 11K0F3E (Authorized Bandwidth 11.25 kHz)

Item	Mark		
Maximum Modulation	(M)	3	kHz
Maximum Deviation	(D)	2.5	kHz
Constant Factor	(K)	1	
Necessary Bandwidth	(Bn)	11	kHz

$B_n = (2 \times M) + (2 \times D \times K)$

- 1.types of modulation of the main carrier : F= Frequency modulation
- 2.nature of signal(s) modulating the main carrier: 3= A single channel containing analog information
- 3.type of information to be transmitted: E= Telephony (including sound broadcasting)

State : 8K30F1E / 8K30F1D / 8K30F7W (4Level FSK / 9600bps, Authorized Bandwidth 11.25 kHz)

Item	Mark		
Digital information rate	(R)	9600	bps
Peak frequency deviation	(D)	3.391	kHz
Signaling states	(S)	4	
Numerical factor	(K)	0.516	
Necessary Bandwidth	(Bn)	8.3	kHz

$B_n = (R / \log_2 S) + 2 \times D \times K$

- 1.types of modulation of the main carrier : F= Frequency modulation
- 2.nature of signal(s) modulating the main carrier: 1= A single channel containing quantized or digital information without the use of a modulating sub-carrier
7= Two or more channels containing quantized or digital information
- 3.type of information to be transmitted: E= Telephony (including sound broadcasting)
D= Data transmission, telemetry, telecommand
W= Combination of the above

State : 7K60FXE / 7K60FXD (9600bps, Authorized Bandwidth 11.25 kHz)

Item	Mark		
Digital information rate	(R)	9600	bps
Peak frequency deviation	(D)	3.024	kHz
Signaling states	(S)	4	
Numerical factor	(K)	0.463	
Necessary Bandwidth	(Bn)	7.6	kHz

$$B_n = (R/\log_2 S) + 2x D x K$$

- 1.types of modulation of the main carrier : F= Frequency modulation
 2.nature of signal(s) modulating the main carrier: X= Cases not otherwise covered
 3.type of information to be transmitted: E= Telephony (including sound broadcasting)
 D= Data transmission, telemetry, telecommand

State : 4K00F1E / 4K00F1D / 4K00F7W (4Level FSK / 4800bps, Authorized Bandwidth 6 kHz)

Item	Mark		
Digital information rate	(R)	4800	bps
Peak frequency deviation	(D)	1.55	kHz
Signaling states	(S)	4	
Numerical factor	(K)	0.516	
Necessary Bandwidth	(Bn)	4	kHz

$$B_n = (R/\log_2 S) + 2x D x K$$

- 1.types of modulation of the main carrier : F= Frequency modulation
 2.nature of signal(s) modulating the main carrier: 1= A single channel containing quantized or digital information without the use of a modulating sub-carrier
 7= Two or more channels containing quantized or digital information
 3.type of information to be transmitted: E= Telephony (including sound broadcasting)
 D= Data transmission, telemetry, telecommand
 W= Combination of the above

State : 4K00F2D (CWID, Authorized Bandwidth 6 kHz)

Item	Mark		
Maximum Modulation	(M)	0.8	kHz
Maximum Deviation	(D)	1.2	kHz
Numerical factor	(K)	1	
Necessary Bandwidth	(Bn)	4	kHz

$$B_n = (2xM) + (2x D x K)$$

- 1.types of modulation of the main carrier : F= Frequency modulation
 2.nature of signal(s) modulating the main carrier: 2= A single channel containing quantized or digital information with the
 3.type of information to be transmitted: D= Data transmission, telemetry, telecommand

10.11 99% Occupied Bandwidth

REGULATIONS	:	RSS-119 Section 5.5 RSS-134 Section 4.4
TEST METHOD/GUIDE	:	RSS-Gen Section 6.6

Test Procedure

- 1 The EUT and test equipment were set up as shown on the following page.
- 2 Adjust the test instrument for the following setting:
 - RBW : 1 % to 5 % of the Necessary bandwidth
 - VBW : at least 3 times the RBW
 - Detector : Peak
 - Sweep Time : Auto
 - Trace mode : Max Hold
- 3 Allow trace to fully stabilize.
- 4 Use "Occupied Bandwidth Measurement" function to measure the 99% Occupied Bandwidth.
- 5 Modulate the transmitter with a 2.5 kHz sine wave at an input Level of 16 dB greater than that necessary to produce 50 % of rated system deviation.(Only 16K0F3E, 11K0F3E)

Measuring Equipments

No.	Equipment	Manufacture	Model No.	Serial No.	Cal. Interval	Effective period
1	Attenuator (20dB)	Aeroflex/Wenshel	66-20-34	BY4357	1Y	Jul. 31, 19
2	Attenuator (30dB)	Weinschel	WA-29-30-34	8923	1Y	Jul. 31, 19
3	Modulation Analyzer	Hewlett Packard	8901B	3403A04852	1Y	Dec. 31, 18
4	Audio Generator	Anritsu	MG443B	M70150	1Y	Sep. 30, 19
5	Spectrum Analyzer	Agilent	N9030A	US51350220	1Y	Mar. 31, 19
6	DC Power Supply	Daiichi denpa kogyo	GZV4000	90290931	None	None
7	Digital Multi Meter	FLUKE	8846A	9642018	1Y	Sep. 30, 19
8	Balance Cable	Nicoon	3D-2V	KSR00092	1Y	Feb. 28, 19
9	Coaxial Cable	Pacific custom	RG-58 C/U	AM90C04	1Y	Feb. 28, 19
10	Coaxial Cable	Suhner	SUCOFLEX104	F0000017	1Y	Jul. 31, 19



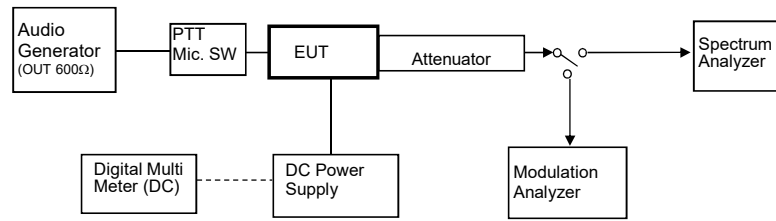



Measuring Equipment Configuration



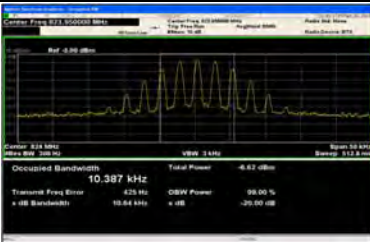

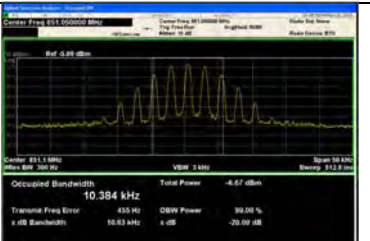

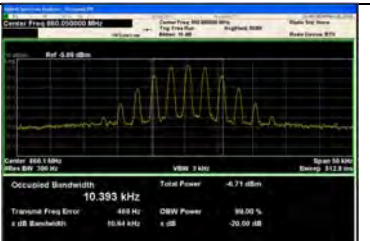



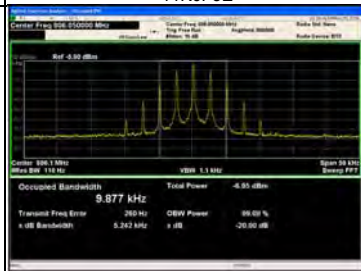

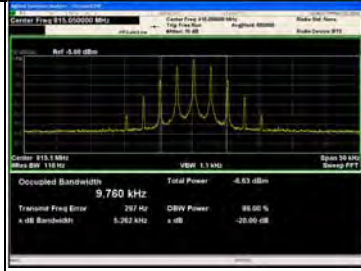

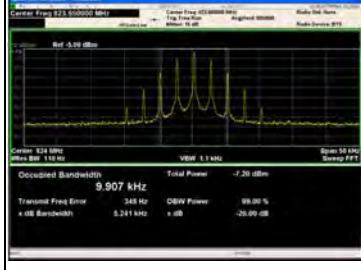

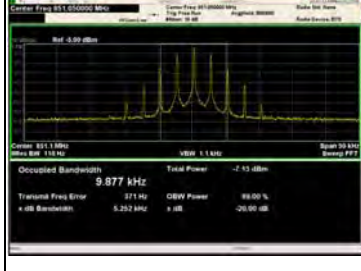

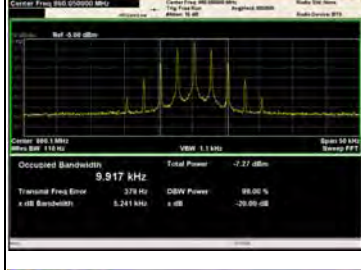



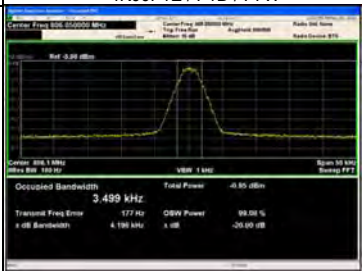

Test Results

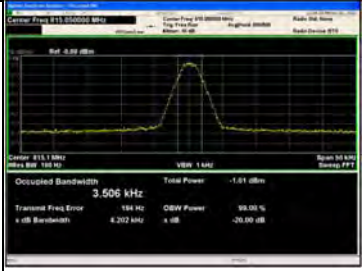



Test date	Nov 20, 2018		
Location	Kashima No.12 Test Site		
temperature	25.7	to	26.0 [degree C]
Humidity Variation	60.0	to	54.0 [%]
Atmospheric Pressure	101.0	to	101.6 [kPa]
Test Engineer	Koichi Wagatsuma		

Emission Designation	Frequency (MHz)	99% Occupied Bandwidth (kHz)	Authorized bandwidth (kHz)
16K0F3E	806.05	14.645	20
	815.05	14.645	
	823.95	14.655	
	851.05	14.613	
	860.05	14.681	
14K0F3E	806.05	10.399	20
	815.05	10.394	
	823.95	10.387	
	851.05	10.384	
	860.05	10.393	
11K0F3E	806.05	9.877	11.25
	815.05	9.760	
	823.95	9.907	
	851.05	9.877	
	860.05	9.917	
8K30F1E/F1D/F7W	806.05	7.633	11.25
	815.05	7.612	
	823.95	7.628	
	851.05	7.597	
	860.05	7.656	
7K60FXE/FXD	806.05	7.510	11.25
	815.05	7.506	
	823.95	7.521	
	851.05	7.487	
	860.05	7.531	
4K00F1E / F1D / F7W	806.05	3.499	6
	815.05	3.506	
	823.95	3.500	
	851.05	3.506	
	860.05	3.507	
4K00F2D	806.05	3.326	6
	815.05	3.316	
	823.95	3.315	
	851.05	3.323	
	860.05	3.318	
868.95	3.308		

Frequency (MHz)	Emission Designation	
	16K0F3E	14K0F3E
806.05	 <p>Occupied Bandwidth: 14.645 kHz Total Power: -4.54 dBm Transmitt Freq Error: 422 Hz OOB Power: 99.00 % > dB Bandwidth: 15.33 kHz</p>	 <p>Occupied Bandwidth: 10.399 kHz Total Power: -4.40 dBm Transmitt Freq Error: 368 Hz OOB Power: 99.00 % > dB Bandwidth: 10.94 kHz</p>
815.05	 <p>Occupied Bandwidth: 14.645 kHz Total Power: -4.64 dBm Transmitt Freq Error: 433 Hz OOB Power: 99.00 % > dB Bandwidth: 15.34 kHz</p>	 <p>Occupied Bandwidth: 10.394 kHz Total Power: -4.58 dBm Transmitt Freq Error: 404 Hz OOB Power: 99.00 % > dB Bandwidth: 10.84 kHz</p>
823.95	 <p>Occupied Bandwidth: 14.645 kHz Total Power: -4.68 dBm Transmitt Freq Error: 449 Hz OOB Power: 99.00 % > dB Bandwidth: 15.34 kHz</p>	 <p>Occupied Bandwidth: 10.387 kHz Total Power: -4.62 dBm Transmitt Freq Error: 425 Hz OOB Power: 99.00 % > dB Bandwidth: 10.84 kHz</p>
851.05	 <p>Occupied Bandwidth: 14.655 kHz Total Power: -4.69 dBm Transmitt Freq Error: 470 Hz OOB Power: 99.00 % > dB Bandwidth: 15.33 kHz</p>	 <p>Occupied Bandwidth: 10.384 kHz Total Power: -4.67 dBm Transmitt Freq Error: 455 Hz OOB Power: 99.00 % > dB Bandwidth: 10.83 kHz</p>
860.05	 <p>Occupied Bandwidth: 14.681 kHz Total Power: -4.70 dBm Transmitt Freq Error: 481 Hz OOB Power: 99.00 % > dB Bandwidth: 15.34 kHz</p>	 <p>Occupied Bandwidth: 10.383 kHz Total Power: -4.71 dBm Transmitt Freq Error: 480 Hz OOB Power: 99.00 % > dB Bandwidth: 10.84 kHz</p>
868.95	 <p>Occupied Bandwidth: 14.690 kHz Total Power: -4.71 dBm Transmitt Freq Error: 488 Hz OOB Power: 99.00 % > dB Bandwidth: 15.34 kHz</p>	 <p>Occupied Bandwidth: 10.381 kHz Total Power: -4.75 dBm Transmitt Freq Error: 480 Hz OOB Power: 99.00 % > dB Bandwidth: 10.84 kHz</p>

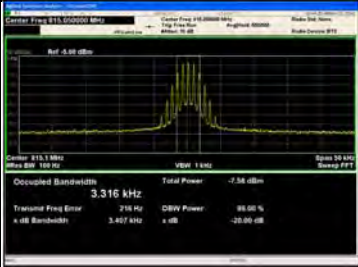
Frequency (MHz)	Emission Designation	
	11K0F3E	8K30F1E/F1D/F7W
806.05	 <p>Center Freq: 806.050000 MHz Ref: -5.00 dBm Occupied Bandwidth: 9.877 kHz Total Power: -4.95 dBm Transmitt Freq Error: 260 Hz OBW Power: 99.00 % x dB Bandwidth: 5.252 kHz x dB: -20.00 dB</p>	 <p>Center Freq: 806.050000 MHz Ref: -5.00 dBm Occupied Bandwidth: 7.633 kHz Total Power: -1.51 dBm Transmitt Freq Error: 213 Hz OBW Power: 99.00 % x dB Bandwidth: 5.673 kHz x dB: -20.00 dB</p>
815.05	 <p>Center Freq: 815.050000 MHz Ref: -5.00 dBm Occupied Bandwidth: 9.760 kHz Total Power: -4.63 dBm Transmitt Freq Error: 267 Hz OBW Power: 99.00 % x dB Bandwidth: 5.252 kHz x dB: -20.00 dB</p>	 <p>Center Freq: 815.050000 MHz Ref: -5.00 dBm Occupied Bandwidth: 7.612 kHz Total Power: -1.51 dBm Transmitt Freq Error: 267 Hz OBW Power: 99.00 % x dB Bandwidth: 5.676 kHz x dB: -20.00 dB</p>
823.95	 <p>Center Freq: 823.950000 MHz Ref: -5.00 dBm Occupied Bandwidth: 9.907 kHz Total Power: -7.20 dBm Transmitt Freq Error: 348 Hz OBW Power: 99.00 % x dB Bandwidth: 5.241 kHz x dB: -20.00 dB</p>	 <p>Center Freq: 823.950000 MHz Ref: -5.00 dBm Occupied Bandwidth: 7.628 kHz Total Power: -1.51 dBm Transmitt Freq Error: 270 Hz OBW Power: 99.00 % x dB Bandwidth: 5.664 kHz x dB: -20.00 dB</p>
851.05	 <p>Center Freq: 851.050000 MHz Ref: -5.00 dBm Occupied Bandwidth: 9.907 kHz Total Power: -7.12 dBm Transmitt Freq Error: 371 Hz OBW Power: 99.00 % x dB Bandwidth: 5.252 kHz x dB: -20.00 dB</p>	 <p>Center Freq: 851.050000 MHz Ref: -5.00 dBm Occupied Bandwidth: 7.597 kHz Total Power: -1.51 dBm Transmitt Freq Error: 287 Hz OBW Power: 99.00 % x dB Bandwidth: 5.664 kHz x dB: -20.00 dB</p>
860.05	 <p>Center Freq: 860.050000 MHz Ref: -5.00 dBm Occupied Bandwidth: 9.917 kHz Total Power: -7.27 dBm Transmitt Freq Error: 378 Hz OBW Power: 99.00 % x dB Bandwidth: 5.241 kHz x dB: -20.00 dB</p>	 <p>Center Freq: 860.050000 MHz Ref: -5.00 dBm Occupied Bandwidth: 7.656 kHz Total Power: -1.57 dBm Transmitt Freq Error: 321 Hz OBW Power: 99.00 % x dB Bandwidth: 5.673 kHz x dB: -20.00 dB</p>
868.95	 <p>Center Freq: 868.950000 MHz Ref: -5.00 dBm Occupied Bandwidth: 9.912 kHz Total Power: -7.38 dBm Transmitt Freq Error: 411 Hz OBW Power: 99.00 % x dB Bandwidth: 5.254 kHz x dB: -20.00 dB</p>	 <p>Center Freq: 868.950000 MHz Ref: -5.00 dBm Occupied Bandwidth: 7.639 kHz Total Power: -1.54 dBm Transmitt Freq Error: 330 Hz OBW Power: 99.00 % x dB Bandwidth: 5.673 kHz x dB: -20.00 dB</p>

Frequency (MHz)	Emission Designation	
	7K60FXE/FXD	4K00F1E / F1D / F7W
806.05		
815.05		
823.95		
851.05		
860.05		
868.95		

Ferquency (MHz)	Emission Designation	
	4K00F2D	
806.05	 <p>Center Freq: 806.050000 MHz Ref: -3.00 dBm Occupied Bandwidth: 3.326 kHz Total Power: -7.34 dBm Transmitt Freq Error: 202 Hz + dB Bandwidth: 3.322 kHz OSW Power: 99.00 % - dB: -20.00 dB</p>	
815.05	 <p>Center Freq: 815.050000 MHz Ref: -3.00 dBm Occupied Bandwidth: 3.316 kHz Total Power: -7.34 dBm Transmitt Freq Error: 748 Hz + dB Bandwidth: 3.407 kHz OSW Power: 99.00 % - dB: -20.00 dB</p>	
823.95	 <p>Center Freq: 823.950000 MHz Ref: -3.00 dBm Occupied Bandwidth: 3.315 kHz Total Power: -7.33 dBm Transmitt Freq Error: 738 Hz + dB Bandwidth: 3.401 kHz OSW Power: 99.00 % - dB: -20.00 dB</p>	
851.05	 <p>Center Freq: 851.050000 MHz Ref: -3.00 dBm Occupied Bandwidth: 3.323 kHz Total Power: -7.34 dBm Transmitt Freq Error: 291 Hz + dB Bandwidth: 3.390 kHz OSW Power: 99.00 % - dB: -20.00 dB</p>	
860.05	 <p>Center Freq: 860.050000 MHz Ref: -3.00 dBm Occupied Bandwidth: 3.318 kHz Total Power: -7.35 dBm Transmitt Freq Error: 281 Hz + dB Bandwidth: 3.399 kHz OSW Power: 99.00 % - dB: -20.00 dB</p>	
868.95	 <p>Center Freq: 868.950000 MHz Ref: -3.00 dBm Occupied Bandwidth: 3.308 kHz Total Power: -6.95 dBm Transmitt Freq Error: 774 Hz + dB Bandwidth: 3.455 kHz OSW Power: 99.00 % - dB: -20.00 dB</p>	