

# TEST REPORT

FCC/ISED Test for NX-1300-K6

**APPLICANT**  
JVCKENWOOD Corporation

**REPORT NO.**  
HCT-RF-2105-FI001

**DATE OF ISSUE**  
May 14, 2021

**Tested by**  
Kwon Jeong



**Technical Manager**  
Jong Seok Lee



**HCT CO., LTD.**  
*Bongjai Huh*  
BongJai Huh / CEO



**HCT Co., Ltd.**

74, Seoicheon-ro 578beon-gil, Majang-myeon, Icheon-si, Gyeonggi-do, 17383 KOREA  
Tel. +82 31 634 6300 Fax. +82 31 645 6401

**TEST  
REPORT**  
FCC/ISED Test for  
NX-1300-K6

**REPORT NO.**  
HCT-RF-2105-FI001

**DATE OF ISSUE**  
May 14, 2021

**Additional Model(s)**  
NX-1300-K4, NX-1300-K5

**Applicant** **JVCKENWOOD Corporation**  
1-16-2 Hakusan Midori-ku Yokohama-shi Kanagawa 226-8525 Japan

<b>Product Name</b>	UHF TRANSCEIVER
<b>Model(s)</b>	NX-1300-K6
<b>FCC ID IC</b>	K44501102 282F-501102
<b>Test Standard Used</b>	Part 2, 22, 74, 90 / RSS- Gen Issue 5, RSS-119 Issue 12
<b>Frequency Range</b>	FCC: 406.1 MHz ~ 470.0 MHz ISED: 406.1 ~ 430.0 MHz, 450.0 ~ 470.0 MHz

The result shown in this test report refer only to the sample(s) tested unless otherwise stated.  
This test results were applied only to the test methods required by the standard.

## REVISION HISTORY

The revision history for this test report is shown in table.

Revision No.	Date of Issue	Description
0	May 14, 2021	Initial Release

The measurements shown in this report were made in accordance with the procedures specified in § 2.947. I assume full responsibility for the accuracy and completeness of these measurements, and for the qualifications of all persons taking them.

HCT CO., LTD. Certifies that no party to this application has subject to a denial of Federal benefits that includes FCC benefits pursuant to section 5301 of the Anti-Drug Abuse Act of 1998, 21 U.S. C. 853(a)

\* The report shall not be reproduced except in full (only partly) without approval of the laboratory.

## CONTENTS

1. GENERAL INFORMATION	5
2. EUT DESCRIPTION	6
3. TEST METHODOLOGY	8
3.1 EUT CONFIGURATION	8
3.2 EUT EXERCISE	8
3.3 GENERAL TEST PROCEDURES	8
3.4 DESCRIPTION OF TEST MODES	9
4. INSTRUMENT CALIBRATION	9
5. FACILITIES AND ACCREDITATIONS	9
5.1 FACILITIES	9
5.2 EQUIPMENT	9
6. WORST CASE CONFIGURATION AND MODE	10
7. SUMMARY TEST OF RESULTS	11
8. TEST RESULT	15
8.1 Carrier Output Power	15
8.2 Carrier Frequency Stability	18
8.3 Occupied Bandwidth	31
8.4 Modulation Limiting	57
8.5 Audio Frequency Response / Audio Low Pass Filter Response	74
8.6 Emission Mask	100
8.7 Transient Frequency Behavior	126
8.8 Unwanted Emissions : Conducted Spurious Emission	146
8.9 Unwanted Emissions : Radiated Spurious Emission	187
8.10 Unwanted Emissions : Receiver Radiated Spurious Emission	192
8.11 Necessary Bandwidth Calculations	193
9. LIST OF TEST EQUIPMENT	194
10. ANNEX A_ TEST SETUP PHOTO	195

**1. GENERAL INFORMATION**

Manufacturer:	JVCKENWOOD Corporation
Address:	1-16-2 Hakusan Midori-ku Yokohama-shi Kanagawa 226-8525 Japan
FCC ID:	K44501102
ISED:	282F-501102
EUT Type:	UHF TRANSCEIVER
Model(s):	NX-1300-K6
Additional Model(s):	NX-1300-K4, NX-1300-K5
Date(s) of Tests:	April 16, 2021 ~ May 12, 2021
Place of Tests:	HCT Co., Ltd. 74, Seoicheon-ro 578beon-gil, Majang-myeon, Icheon-si, Gyeonggi-do, 17383, Rep. of KOREA

## 2. EUT DESCRIPTION

Power Supply Voltage	DC 7.5V $\pm$ 20%
Output Power	5 W (Power output continuously variable to 0.25 W) (Max : 5.2 W)
Battery type	KNB-45L Li-Ion Battery Pack (2000mA) KNB-53N Ni-MH Battery Pack (1400mA) KNB-29N Ni-MH Battery Pack (1500mA) KNB-69L Li-ion Battery Pack (2450mA) KNB-82LC (Li-ion Battery Pack) KNB-84L Li-Ion Battery Pack (2000mA)
Antenna	KRA-23M UHF Low Profile Helical Antenna (440-490 MHz) KRA-23M3 UHF Low Profile Helical Antenna (400-450 MHz) KRA-27M UHF Whip Antenna (440-490 MHz) KRA-27M3 UHF Whip Antenna (400-450 MHz) KRA-42M UHF Stubby Antenna (440-490 MHz) KRA-42M3 UHF Stubby Antenna (400-450 MHz)
Peak Antenna gain	KRA-23M UHF Low Profile Helical Antenna: 0 dBd KRA-23M3 UHF Low Profile Helical Antenna: 0 dBd KRA-27M UHF Whip Antenna: 0 dBd KRA-27M3 UHF Whip Antenna: 0 dBd KRA-42M UHF Stubby Antenna: 0 dBd KRA-42M3 UHF Stubby Antenna: 0 dBd
Type of Emission	16K0F3E: Analogue (*16K0F3E is ISED only) 11K0F3E: Analogue 8K30F1E, 8K30F1D, 8K30F7W: NXDN 7K60FXE, 7K60FXD: DMR 4K00F1E, 4K00F1D, 4K00F7W: NXDN 4K00F2D: CWID
Channel Bandwidth	25 kHz* / 6.25 kHz / 12.5 kHz (*25kHz is ISED only)
Operating Temperature	-30 °C ~ +60 °C
Frequency Range	406.1 MHz ~ 470.0 MHz (FCC) 406.1 ~ 430.0 MHz, 450.0 ~ 470.0 MHz (ISED)
Test Frequency	406.15 MHz / 429.95 MHz / 469.95 MHz

Maximum deviation	16K0F3E: $\pm 5$ kHz 11K0F3E: $\pm 2.5$ kHz
Frequency Stability	$\pm 1.0$ ppm
PMN	NX-1300-K4, NX-1300-K5, NX-1300-K6
HVIN	NX-1300-K4-21, NX-1300-K5-21, NX-1300-K6-21
FVIN	N/A
HMN	N/A

### 3. TEST METHODOLOGY

TIA-603-E dated March 2016 entitled “Land Mobile FM or PM Communications Equipment Measurement and Performance Standards” were used in the measurement.

#### 3.1 EUT CONFIGURATION

The EUT configuration for testing is installed on RF field strength measurement to meet the Commissions requirement and operating in a manner that intends to maximize its emission characteristics in a continuous normal application.

#### 3.2 EUT EXERCISE

The EUT was operated in the engineering mode to fix the Tx frequency that was for the purpose of the measurements. According to its specifications, the EUT must comply with the requirements of the FCC Rules Part 2 and Part 90.

#### 3.3 GENERAL TEST PROCEDURES

##### Radiated Emissions

Radiated emission measurements are performed in the Fully-anechoic chamber. The equipment under test is placed on a non-conductive table 3-meters away from the receive antenna in accordance with ANSI/TIA-603-E-2016. The turntable is rotated through 360 degrees, and the receiving antenna scans in order to determine the level of the maximized emission. The level and position of the maximized emission is recorded with the spectrum analyzer using a positive peak detector.

A half wave dipole is then substituted in place of the EUT. For emissions above 1GHz, a horn antenna is substituted in place of the EUT. The substitute antenna is driven by a signal generator and the previously recorded signal was duplicated.

The power is calculated by the following formula;

$$P_{d(dBm)} = P_{g(dBm)} - \text{cable loss}_{(dB)} + \text{antenna gain}_{(dB)}$$

Where:  $P_d$  is the dipole equivalent power and  $P_g$  is the generator output power into the substitution antenna.

The maximum EIRP is calculated by adding the forward power to the calibrated source plus its appropriate gain value. These steps are repeated with the receiving antenna in both vertical and horizontal polarization. the difference between the gain of the horn and an isotropic antenna are taken into consideration



### 3.4 DESCRIPTION OF TEST MODES

The EUT has been tested under operating condition. Test program used to control the EUT for staying in continuous transmitting is programmed.

## 4. INSTRUMENT CALIBRATION

The measuring equipment, which was utilized in performing the tests documented herein, has been calibrated in accordance with the manufacturer's recommendations for utilizing calibration equipments, which is traceable to recognized national standards.

## 5. FACILITIES AND ACCREDITATIONS

### 5.1 FACILITIES

The Fully-anechoic chamber and conducted measurement facility used to collect the radiated data are located at the 74, Seoicheon-ro 578beon-gil, Majang-myeon, Icheon-si, Gyeonggi-do, Korea.

### 5.2 EQUIPMENT

Radiated emissions are measured with one or more of the following types of Linearly polarized antennas: tuned dipole, bi-conical, log periodic, bi-log, and/or ridged waveguide, horn. Spectrum analyzers with pre-selectors and quasi-peak detectors are used to perform radiated measurements. Conducted emissions are measured with Line Impedance Stabilization Networks and EMI Test Receivers. Calibrated wideband preamplifiers, coaxial cables, and coaxial attenuators are also used for making measurements.

All receiving equipment conforms to CISPR Publication 16-1, "Radio Interference Measuring Apparatus and Measurement Methods."

## 6. WORST CASE CONFIGURATION AND MODE

### Radiated test

1. NX-1300-K6 & Additional Models were tested and the worst case results are reported.  
(Worst case : NX-1300-K6)
2. All modes of operation were investigated and the worst case configuration results are reported.
  - Mode : Stand alone + Microphone (High Power/ Low Power)  
Stand alone + Accessories (High Power/ Low Power)  
Stand alone + Microphone + Accessories (High Power/ Low Power)
  - Worst case : Stand alone + Microphone (High Power)
3. All type of battery were investigated and the worst case configuration results are reported.
  - Battery type : KNB-45L, KNB-53N, KNB-29N, KNB-69L, KNB-82LC, KNB-84L
  - Worst case : KNB-69L
4. All Antenna were investigated and the worst case configuration results are reported.
  - Antenna type : KRA-23M, KRA-23M3, KRA-27M, KRA-27M3,  
KRA-42M, KRA-42M3
  - Worst case : KRA-27M, KRA-27M3
5. Measurements value show only up to 8 maximum emissions noted, or would be lesser if no specific emissions from the EUT are recorded (ie: margin > 20 dB from the applicable limit) and considered that's already beyond the background noise floor.

### Conducted test

1. NX-1300-K6 & Additional Models were tested and the worst case results are reported.  
(Worst case : NX-1300-K6)
2. Conducted Spurious Emission :  
All Power of operation were investigated and the worst case configuration results are reported.
  - Power : High Power/ Low Power
  - Worst case : High Power
3. Frequency Stability :  
All Type of Emission were investigated and the worst case Type results are reported.
  - Worst case : 16K0F3E, 11K0F3E, 4K00F2D
4. Transient Frequency Behavior :  
All Type of Emission were investigated and the worst case Type results are reported.
  - Worst case : 16K0F3E, 11K0F3E, 4K00F1E, 4K00F1D, 4K00F7W

## 7. SUMMARY TEST OF RESULTS

Test Description	FCC Part Section(s)	ISED Part Section(s)	Test Condition	Test Result
Carrier RF Output Power	§ 2.1046, § 22.565, § 74.461, § 90.205	RSS119 (5.4)	CONDUCTED	PASS
Unwanted Emissions	§ 2.1051 § 22.359, § 74.462, § 74.535, § 90.210	RSS119 (5.8)	CONDUCTED	PASS
99% Bandwidth(ISED)	NA	RSS119 (5.5)		PASS
Carrier Frequency Stability	§ 2.1055, § 22.355, § 74.464, § 90.213(a)	RSS119 (5.3)		PASS
Audio Frequency Response	§ 2.1047(a)	-		PASS
Audio Low Pass Filter	§ 2.1047(a)	-		PASS
Modulation Limiting	§ 2.1047(b)	-		PASS
Transient Frequency Behavior	§ 74.462, § 90.214	RSS119 (5.9)		PASS
Emission Mask	§ 2.1049, § 22.359, § 74.462, § 74.535, § 90.210	RSS119 (5.8)		PASS
Field Strength of Spurious Radiation	§ 2.1053 § 22.359, § 74.462, § 74.535, § 90.210	RSS119 (5.8)	RADIATED	PASS
Receiver Spurious Emissions	NA	RSS-Gen(7)		PASS
Necessary Bandwidth	§ 2.202(g)	-	-	-

Test Description	Test Limit(FCC)	Test Limit(ISED)
Carrier RF Output Power	Varies	60W
Unwanted Emissions	6.25 kHz: 55+ 10 log (P)dB 12.5 kHz: 50 + 10 log (P)dB 25 kHz: 43 + 10 log (P)dB	6.25 kHz: 55+ 10 log (P)dB 12.5 kHz: 50 + 10 log (P)dB 25 kHz: 43 + 10 log (P)dB
99% Bandwidth(ISED)	N/A	6.25 kHz: 6 kHz 12.5 kHz: 11.25kHz 25 kHz: 20 kHz
Carrier Frequency Stability	6.25 kHz = 1 ppm 12.5 kHz = 2.5 ppm 25 kHz = 5 ppm	6.25 kHz = 1 ppm 12.5 kHz = 2.5 ppm 25 kHz = 5 ppm
Audio Frequency Response	Varies	N/A
Audio Low Pass Filter		
Modulation Limiting	25 kHz = 5 kHz 12.5 kHz = 2.5 kHz	N/A
Transient Frequency Behavior	<u>See Note3</u>	<u>See Note3</u>
Emission Mask	<u>See Note2</u>	<u>See Note2</u>
Field Strength of Spurious Radiation	6.25 kHz: 55+ 10 log (P)dB 12.5 kHz: 50 + 10 log (P)dB 25 kHz: 43 + 10 log (P)dB	6.25 kHz: 55+ 10 log (P)dB 12.5 kHz: 50 + 10 log (P)dB 25 kHz: 43 + 10 log (P)dB
Receiver Spurious Emissions	N/A	<u>See Note1</u>

**Note:**

## 1. Receiver Spurious Emissions Limit :

Frequency (MHz)	Field Strength ( $\mu\text{v/m}$ at 3 meters)
30 – 88	100
88 - 216	150
216 – 960	200
Above 960	500

## 2. Emission Mask Limit :

Channel Bandwidth: 25kHz

Displacement Frequency (% of Authorized Bandwidth)	Minimum Attenuation (dB)
50 to 100	25 dB
100 to 250	35 dB
>250	$43 + 10 \log_{10}(COP)$

Channel Bandwidth: 12.5kHz

Channel Spacing (kHz)	Displacement Frequency Range	Minimum Attenuation (dB)
12.5 & 15	>5.625 kHz to 12.5 kHz	$7.27(f_d - 2.88)$
	>12.5 kHz	Whichever is less attenuation; 70 or $50 + 10 \log_{10}(COP)$

Channel Bandwidth: 6.25kHz

Channel Spacing (kHz)	Displacement Frequency Range	Minimum Attenuation (dB)
6.25 & 7.5	>3.0 kHz to 4.6 kHz	Whichever is less attenuation; 65 or $30 + 16.67(f_d - 3)$ or $55 + 10 \log_{10}(COP)$
	Greater than 4.6 kHz	Whichever is less attenuation; 65 or $55 + 10 \log_{10}(COP)$

## 3. Transient Frequency Behavior Limit :

Channel Bandwidth (kHz)	Time Intervals (Notes 1, 2)	Maximum Frequency Difference (kHz)	Transient Duration Limit (ms)	
			138-174 MHz	406.1-512 MHz
25	t <sub>1</sub>	±25	5	10
	t <sub>2</sub>	±12.5	20	25
	t <sub>3</sub>	±25	5	10
12.5	t <sub>1</sub>	±12.5	5	10
	t <sub>2</sub>	±6.25	20	25
	t <sub>3</sub>	±12.5	5	10
6.25	t <sub>1</sub>	±6.25	5	10
	t <sub>2</sub>	±3.125	20	25
	t <sub>3</sub>	±6.25	5	10

## 8. TEST RESULT

### 8.1 Carrier Output Power

#### ▣ Definition

The conducted carrier power output rating for a transmitter is the power available at the output terminals of the transmitter when the output terminals are connected to the standard transmitter load.

#### ▣ TEST CONFIGURATION

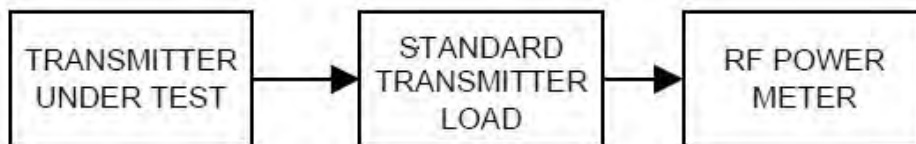

#### ▣ TEST PROCEDURE

According to 2.2.1 in TIA-603-E Standard.

- a) Connect the equipment as illustrated.
- b) Measure the transmitter output power during the defined duty cycle(see 1.3.2).  
Correct for all losses in the RF path.
- c) The value recorded in step b) is the conducted carrier output power rating.

## ▣ TEST RESULTS(Carrier Output Power)

Certification	Type of Emission	Channel Bandwidth (kHz)	Test Frequency (MHz)	Carrier Output Power			
				High Power		Low Power	
				dBm	W	dBm	W
ISED	16K0F3E	25	406.15	36.62	4.59	23.84	0.24
			429.95	36.52	4.48	24.50	0.28
			469.95	36.54	4.51	24.13	0.26
FCC/ISED	11K0F3E	12.5	406.15	36.66	4.64	23.79	0.24
			429.95	36.60	4.58	24.42	0.28
			469.95	36.61	4.58	24.16	0.26
FCC/ISED	8K30F1E, 8K30F1D, 8K30F7W	12.5	406.15	36.77	4.75	23.94	0.25
			429.95	36.57	4.54	24.39	0.27
			469.95	36.72	4.70	23.93	0.25
FCC/ISED	7K60FXD, 7K60FXE	12.5	406.15	36.82	4.80	24.00	0.25
			429.95	36.68	4.66	24.44	0.28
			469.95	36.71	4.69	24.18	0.26
FCC/ISED	4K00F1E, 4K00F1D, 4K00F7W	6.25	406.15	36.85	4.85	23.78	0.24
			429.95	36.70	4.68	24.41	0.28
			469.95	36.73	4.71	24.12	0.26
FCC/ISED	4K00F2D	6.25	406.15	36.89	4.89	24.09	0.26
			429.95	36.87	4.87	24.50	0.28
			469.95	36.60	4.57	24.02	0.25



## ▣ TEST RESULTS(ERP)

Certification	Type of Emission	Channel Bandwidth (kHz)	Test Frequency (MHz)	ERP			
				High Power		Low Power	
				dBm	W	dBm	W
ISED	16K0F3E	25	406.15	36.62	4.59	23.84	0.24
			429.95	36.52	4.48	24.50	0.28
			469.95	36.54	4.51	24.13	0.26
FCC/ISED	11K0F3E	12.5	406.15	36.66	4.64	23.79	0.24
			429.95	36.60	4.58	24.42	0.28
			469.95	36.61	4.58	24.16	0.26
FCC/ISED	8K30F1E, 8K30F1D, 8K30F7W	12.5	406.15	36.77	4.75	23.94	0.25
			429.95	36.57	4.54	24.39	0.27
			469.95	36.72	4.70	23.93	0.25
FCC/ISED	7K60FXD, 7K60FXE	12.5	406.15	36.82	4.80	24.00	0.25
			429.95	36.68	4.66	24.44	0.28
			469.95	36.71	4.69	24.18	0.26
FCC/ISED	4K00F1E, 4K00F1D, 4K00F7W	6.25	406.15	36.85	4.85	23.78	0.24
			429.95	36.70	4.68	24.41	0.28
			469.95	36.73	4.71	24.12	0.26
FCC/ISED	4K00F2D	6.25	406.15	36.89	4.89	24.09	0.26
			429.95	36.87	4.87	24.50	0.28
			469.95	36.60	4.57	24.02	0.25

Note:

1. ERP = Carrier Output Power + Peak Antenna gain(0 dBd)

## 8.2 Carrier Frequency Stability

### ▣ Definition

The carrier frequency stability is the ability of the transmitter to maintain an assigned carrier frequency.

### ▣ TEST CONFIGURATION

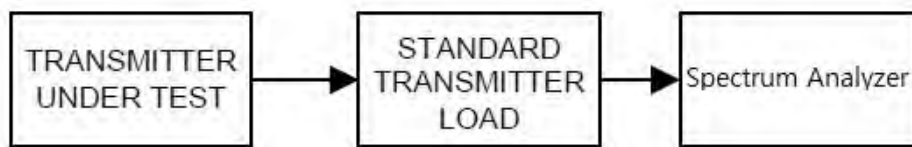

### ▣ TEST PROCEDURE

According to 2.2.2 in TIA-603-E Standard.

- a) Connect the equipment as illustrated.
- b) Operate the equipment in standby conditions for 15 minutes before proceeding.
- c) Record the carrier frequency of the transmitter as  $MCF_{MHz}$
- d) Calculate the ppm frequency error by the following:

$$\text{ppm error} = ((MCF_{MHz} / ACF_{MHz}) - 1) * 10^6$$

where

$MCF_{MHz}$  is the Measured Carrier Frequency in MHz

$ACF_{MHz}$  is the Assigned Carrier Frequency in MHz

- e) The value recorded in step d) is the carrier frequency stability.

## ▣ TEST RESULTS

## (1) Frequency Stability (Temperature Variation)

406.15 MHz

Type of Emission	Power	Temperature (Degree C)	Frequency (Hz)	Frequency Error (Hz)	Frequency stability (ppm)	Limit (ppm)
16K0F3E	High Power	+20(Ref)	406.150430922	0.0000000	0.0000	1.0
		-30	406.150404606	-0.0000263	-0.0648	
		-20	406.150401231	-0.0000297	-0.0731	
		-10	406.150426159	-0.0000048	-0.0117	
		0	406.150429286	-0.0000016	-0.0040	
		+10	406.150430922	0.0000000	0.0000	
		+30	406.150433227	0.0000023	0.0057	
		+40	406.150432939	0.0000020	0.0050	
		+50	406.150426838	-0.0000041	-0.0101	
	Low Power	+20(Ref)	406.150423666	0.0000000	0.0000	
		-30	406.150451285	0.0000276	0.0680	
		-20	406.150406921	-0.0000167	-0.0412	
		-10	406.150410490	-0.0000132	-0.0324	
		0	406.150430548	0.0000069	0.0169	
		+10	406.150423666	0.0000000	0.0000	
		+30	406.150443012	0.0000193	0.0476	
		+40	406.150395695	-0.0000280	-0.0689	
		+50	406.150401824	-0.0000218	-0.0538	

429.95 MHz

Type of Emission	Power	Temperature (Degree C)	Frequency (Hz)	Frequency Error (Hz)	Frequency stability (ppm)	Limit (ppm)
16K0F3E	High Power	+20(Ref)	429.950454374	0.0000000	0.0000	1.0
		-30	429.950425557	-0.0000288	-0.0670	
		-20	429.950432374	-0.0000220	-0.0512	
		-10	429.950424828	-0.0000295	-0.0687	
		0	429.950450735	-0.0000036	-0.0085	
		+10	429.950454374	0.0000000	0.0000	
		+30	429.950457501	0.0000031	0.0073	
		+40	429.950482282	0.0000279	0.0649	
	Low Power	+50	429.950445034	-0.0000093	-0.0217	
		+20(Ref)	429.950448676	0.0000000	0.0000	
		-30	429.950420687	-0.0000280	-0.0651	
		-20	429.950472681	0.0000240	0.0558	
		-10	429.950445522	-0.0000032	-0.0073	
		0	429.950421597	-0.0000271	-0.0630	
		+10	429.950448676	0.0000000	0.0000	
		+30	429.950442885	-0.0000058	-0.0135	
+40	429.950468324	0.0000196	0.0457			
+50	429.950423727	-0.0000249	-0.0580			

469.95 MHz

Type of Emission	Power	Temperature (Degree C)	Frequency (Hz)	Frequency Error (Hz)	Frequency stability (ppm)	Limit (ppm)
16K0F3E	High Power	+20(Ref)	469.950496677	0.0000000	0.0000	1.0
		-30	469.950496940	0.0000003	0.0006	
		-20	469.950490319	-0.0000064	-0.0135	
		-10	469.950512368	0.0000157	0.0334	
		0	469.950500705	0.0000040	0.0086	
		+10	469.950496677	0.0000000	0.0000	
		+30	469.950517727	0.0000210	0.0448	
		+40	469.950518737	0.0000221	0.0469	
		+50	469.950524439	0.0000278	0.0591	
	Low Power	+20(Ref)	469.950495260	0.0000000	0.0000	
		-30	469.950492911	-0.0000023	-0.0050	
		-20	469.950505280	0.0000100	0.0213	
		-10	469.950480583	-0.0000147	-0.0312	
		0	469.950522590	0.0000273	0.0582	
		+10	469.950495260	0.0000000	0.0000	
		+30	469.950491853	-0.0000034	-0.0072	
		+40	469.950487016	-0.0000082	-0.0175	
		+50	469.950503165	0.0000079	0.0168	

406.15 MHz

Type of Emission	Power	Temperature (Degree C)	Frequency (Hz)	Frequency Error (Hz)	Frequency stability (ppm)	Limit (ppm)
11K0F3E	High Power	+20(Ref)	406.150416145	0.0000000	0.0000	1.0
		-30	406.150413583	-0.0000026	-0.0063	
		-20	406.150391309	-0.0000248	-0.0611	
		-10	406.150399415	-0.0000167	-0.0412	
		0	406.150408592	-0.0000076	-0.0186	
		+10	406.150416145	0.0000000	0.0000	
		+30	406.150397078	-0.0000191	-0.0469	
		+40	406.150429963	0.0000138	0.0340	
		+50	406.150386918	-0.0000292	-0.0720	
	Low Power	+20(Ref)	406.150434353	0.0000000	0.0000	
		-30	406.150405450	-0.0000289	-0.0712	
		-20	406.150437386	0.0000030	0.0075	
		-10	406.150425804	-0.0000085	-0.0210	
		0	406.150416284	-0.0000181	-0.0445	
		+10	406.150434353	0.0000000	0.0000	
		+30	406.150457828	0.0000235	0.0578	
		+40	406.150444507	0.0000102	0.0250	
		+50	406.150415950	-0.0000184	-0.0453	

429.95 MHz

Type of Emission	Power	Temperature (Degree C)	Frequency (Hz)	Frequency Error (Hz)	Frequency stability (ppm)	Limit (ppm)
11K0F3E	High Power	+20(Ref)	429.950452203	0.0000000	0.0000	1.0
		-30	429.950459954	0.0000078	0.0180	
		-20	429.950481531	0.0000293	0.0682	
		-10	429.950423528	-0.0000287	-0.0667	
		0	429.950463151	0.0000109	0.0255	
		+10	429.950452203	0.0000000	0.0000	
		+30	429.950465224	0.0000130	0.0303	
		+40	429.950461418	0.0000092	0.0214	
		+50	429.950446521	-0.0000057	-0.0132	
	Low Power	+20(Ref)	429.950454400	0.0000000	0.0000	
		-30	429.950443973	-0.0000104	-0.0243	
		-20	429.950462764	0.0000084	0.0195	
		-10	429.950447389	-0.0000070	-0.0163	
		0	429.950435997	-0.0000184	-0.0428	
		+10	429.950454400	0.0000000	0.0000	
		+30	429.950425452	-0.0000289	-0.0673	
		+40	429.950471635	0.0000172	0.0401	
		+50	429.950466796	0.0000124	0.0288	

469.95 MHz

Type of Emission	Power	Temperature (Degree C)	Frequency (Hz)	Frequency Error (Hz)	Frequency stability (ppm)	Limit (ppm)
11K0F3E	High Power	+20(Ref)	469.950503886	0.0000000	0.0000	1.0
		-30	469.950517152	0.0000133	0.0282	
		-20	469.950522272	0.0000184	0.0391	
		-10	469.950531060	0.0000272	0.0578	
		0	469.950524084	0.0000202	0.0430	
		+10	469.950503886	0.0000000	0.0000	
		+30	469.950505430	0.0000015	0.0033	
		+40	469.950531802	0.0000279	0.0594	
		+50	469.950521845	0.0000180	0.0382	
	Low Power	+20(Ref)	469.950500055	0.0000000	0.0000	
		-30	469.950489807	-0.0000102	-0.0218	
		-20	469.950509063	0.0000090	0.0192	
		-10	469.950491664	-0.0000084	-0.0179	
		0	469.950476994	-0.0000231	-0.0491	
		+10	469.950500055	0.0000000	0.0000	
		+30	469.950483651	-0.0000164	-0.0349	
		+40	469.950527064	0.0000270	0.0575	
		+50	469.950482965	-0.0000171	-0.0364	



406.15 MHz

Type of Emission	Power	Temperature (Degree C)	Frequency (Hz)	Frequency Error (Hz)	Frequency stability (ppm)	Limit (ppm)
4K00F2D	High Power	+20(Ref)	406.150052449	0.0000000	0.0000	1.0
		-30	406.150065408	0.0000130	0.0319	
		-20	406.150060000	0.0000076	0.0186	
		-10	406.150063028	0.0000106	0.0260	
		0	406.150036830	-0.0000156	-0.0385	
		+10	406.150052449	0.0000000	0.0000	
		+30	406.150047318	-0.0000051	-0.0126	
		+40	406.150070360	0.0000179	0.0441	
	+50	406.150061025	0.0000086	0.0211		
	Low Power	+20(Ref)	406.150023850	0.0000000	0.0000	
		-30	406.150036138	0.0000123	0.0303	
		-20	406.150017197	-0.0000067	-0.0164	
		-10	406.150005509	-0.0000183	-0.0452	
		0	406.150023907	0.0000001	0.0001	
		+10	406.150023850	0.0000000	0.0000	
		+30	406.150001851	-0.0000220	-0.0542	
+40		406.150015443	-0.0000084	-0.0207		
+50	406.150034292	0.0000104	0.0257			

429.95 MHz

Type of Emission	Power	Temperature (Degree C)	Frequency (Hz)	Frequency Error (Hz)	Frequency stability (ppm)	Limit (ppm)
4K00F2D	High Power	+20(Ref)	429.697564914	0.0000000	0.0000	1.0
		-30	429.697541465	-0.0000234	-0.0546	
		-20	429.697593447	0.0000285	0.0664	
		-10	429.697535717	-0.0000292	-0.0679	
		0	429.697540045	-0.0000249	-0.0579	
		+10	429.697564914	0.0000000	0.0000	
		+30	429.697548646	-0.0000163	-0.0379	
		+40	429.697569555	0.0000046	0.0108	
		+50	429.697579328	0.0000144	0.0335	
	Low Power	+20(Ref)	429.950015046	0.0000000	0.0000	
		-30	429.950022567	0.0000075	0.0175	
		-20	429.949986836	-0.0000282	-0.0656	
		-10	429.950010422	-0.0000046	-0.0108	
		0	429.950024694	0.0000096	0.0224	
		+10	429.950015046	0.0000000	0.0000	
		+30	429.950000801	-0.0000142	-0.0331	
		+40	429.950025421	0.0000104	0.0241	
		+50	429.950026903	0.0000119	0.0276	

469.95 MHz

Type of Emission	Power	Temperature (Degree C)	Frequency (Hz)	Frequency Error (Hz)	Frequency stability (ppm)	Limit (ppm)
4K00F2D	High Power	+20(Ref)	469.950021026	0.0000000	0.0000	1.0
		-30	469.950005746	-0.0000153	-0.0325	
		-20	469.949992180	-0.0000288	-0.0614	
		-10	469.950026502	0.0000055	0.0117	
		0	469.950037364	0.0000163	0.0348	
		+10	469.950021026	0.0000000	0.0000	
		+30	469.950030917	0.0000099	0.0210	
		+40	469.950012897	-0.0000081	-0.0173	
		+50	469.950006069	-0.0000150	-0.0318	
	Low Power	+20(Ref)	469.950022243	0.0000000	0.0000	
		-30	469.950028408	0.0000062	0.0131	
		-20	469.950005576	-0.0000167	-0.0355	
		-10	469.950005999	-0.0000162	-0.0346	
		0	469.950002756	-0.0000195	-0.0415	
		+10	469.950022243	0.0000000	0.0000	
		+30	469.950007317	-0.0000149	-0.0318	
		+40	469.950033097	0.0000109	0.0231	
		+50	469.950033381	0.0000111	0.0237	

## (2) Frequency Stability (Voltage Variation)

406.15 MHz

Type of Emission	Power	Diviation (%)	Voltage (V)	Frequency (MHz)	Frequency stability (ppm)	Limit (ppm)
16K0F3E	High Power	85	6.38	406.150330958	0.8149	1.0
		100	7.50	406.150330816	0.8145	
		115	8.63	406.150330723	0.8143	
	Low Power	85	6.38	406.150322991	0.7953	
		100	7.50	406.150323548	0.7966	
		115	8.63	406.150323586	0.7967	

429.95 MHz

Type of Emission	Power	Diviation (%)	Voltage (V)	Frequency (MHz)	Frequency stability (ppm)	Limit (ppm)
16K0F3E	High Power	85	6.38	429.950353301	0.8217	1.0
		100	7.50	429.950353060	0.8212	
		115	8.63	429.950353072	0.8212	
	Low Power	85	6.38	429.950348390	0.8103	
		100	7.50	429.950349114	0.8120	
		115	8.63	429.950348691	0.8110	

469.95 MHz

Type of Emission	Power	Diviation (%)	Voltage (V)	Frequency (MHz)	Frequency stability (ppm)	Limit (ppm)
16K0F3E	High Power	85	6.38	469.950397077	0.8449	1.0
		100	7.50	469.950396455	0.8436	
		115	8.63	469.950397211	0.8452	
	Low Power	85	6.38	469.950396060	0.8428	
		100	7.50	469.950396300	0.8433	
		115	8.63	469.950395430	0.8414	

## 406.15 MHz

Type of Emission	Power	Diviation (%)	Voltage (V)	Frequency (MHz)	Frequency stability (ppm)	Limit (ppm)
11K0F3E	High Power	85	6.38	406.150316747	0.7799	1.0
		100	7.50	406.150318727	0.7848	
		115	8.63	406.150316943	0.7804	
	Low Power	85	6.38	406.150333475	0.8211	
		100	7.50	406.150329838	0.8121	
		115	8.63	406.150333402	0.8209	

## 429.95 MHz

Type of Emission	Power	Diviation (%)	Voltage (V)	Frequency (MHz)	Frequency stability (ppm)	Limit (ppm)
11K0F3E	High Power	85	6.38	429.950353688	0.8226	1.0
		100	7.50	429.950354598	0.8247	
		115	8.63	429.950353179	0.8214	
	Low Power	85	6.38	429.950353642	0.8225	
		100	7.50	429.950352932	0.8209	
		115	8.63	429.950353688	0.8226	

## 469.95 MHz

Type of Emission	Power	Diviation (%)	Voltage (V)	Frequency (MHz)	Frequency stability (ppm)	Limit (ppm)
11K0F3E	High Power	85	6.38	469.950404790	0.8613	1.0
		100	7.50	469.950404332	0.8604	
		115	8.63	469.950405395	0.8626	
	Low Power	85	6.38	469.950400160	0.8515	
		100	7.50	469.950398650	0.8483	
		115	8.63	469.950398910	0.8488	

## 406.15 MHz

Type of Emission	Power	Diviation (%)	Voltage (V)	Frequency (MHz)	Frequency stability (ppm)	Limit (ppm)
4K00F2D	High Power	85	6.38	406.150023770	0.0585	1.0
		100	7.50	406.150023608	0.0581	
		115	8.63	406.150022564	0.0556	
	Low Power	85	6.38	406.150023887	0.0588	
		100	7.50	406.150023207	0.0571	
		115	8.63	406.150023183	0.0571	

## 429.95 MHz

Type of Emission	Power	Diviation (%)	Voltage (V)	Frequency (MHz)	Frequency stability (ppm)	Limit (ppm)
4K00F2D	High Power	85	6.38	429.950023578	0.0548	1.0
		100	7.50	429.950020782	0.0483	
		115	8.63	429.950022284	0.0518	
	Low Power	85	6.38	429.950015490	0.0360	
		100	7.50	429.950014823	0.0345	
		115	8.63	429.950014302	0.0333	

## 469.95 MHz

Type of Emission	Power	Diviation (%)	Voltage (V)	Frequency (MHz)	Frequency stability (ppm)	Limit (ppm)
4K00F2D	High Power	85	6.38	469.950020834	0.0443	1.0
		100	7.50	469.950021902	0.0466	
		115	8.63	469.950021959	0.0467	
	Low Power	85	6.38	469.950021587	0.0459	
		100	7.50	469.950023022	0.0490	
		115	8.63	469.950021600	0.0460	

### 8.3 Occupied Bandwidth

#### ▣ Definition

The transmitter sideband spectrum denotes the sideband power produced at a discrete frequency separation from the carrier up to the test bandwidth (see TIA-603-E Section 1.3.4.4) due to all sources of unwanted noise within the transmitter in a modulated condition.

#### ▣ TEST CONFIGURATION

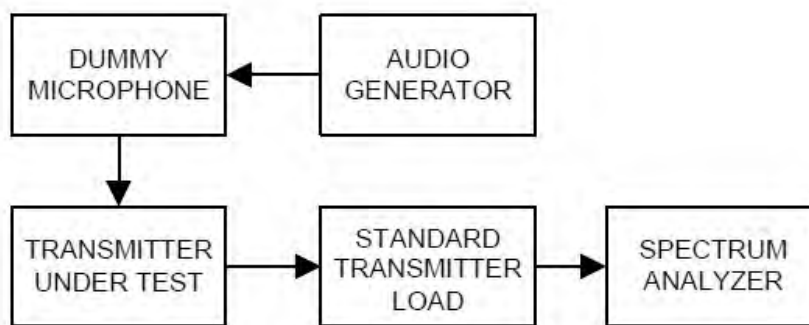

#### ▣ TEST PROCEDURE

According to TIA-603-E Section 2.2.11.2 / RSS-119 Section 5.5

- a) For EUT supporting audio modulation, the audio signal generator was adjusted to the frequency of maximum response and with output level set for +/- 2.5 kHz deviation (or 50 % modulation). (FM modulation).
- b) With level constant, the signal level was increased 16 dB.
- c) For EUT supporting digital modulation, the digital modulation mode was operated to its maximum extent.
- d) Adjust the spectrum analyzer for the following setting:
  - 1) RBW : 100Hz (Authorized Band 6 kHz),  
100Hz (Authorized Band 11.25 kHz),  
300Hz (Authorized Band 20 kHz)
  - 2) VBW : Video Bandwidth at least 10 times the resolution bandwidth.
  - 4) Sweep Speed : Sweep Speed slow enough to maintain measurement calibration.
  - 5) Sampling Time : 10 times
  - 6) Detector Mode = Positive Peak.
- e) The occupied Bandwidth was measured with the Spectrum Analyzer controls set as shown on the test results.

## TEST RESULTS

Certification	Type of Emission	Channel Bandwidth (kHz)	Power	Test Frequency (MHz)	Measured 99% OBW at Maximum Freq. Deviation(kHz)	Limit (kHz)
ISED	16K0F3E	25	High Power	406.15	14.690	20.00
				429.95	14.714	
				469.95	14.616	
			Low Power	406.15	14.690	
				429.95	14.714	
				469.95	14.622	
FCC/ISED	11K0F3E	12.5	High Power	406.15	9.905	11.25
				429.95	9.910	
				469.95	9.888	
			Low Power	406.15	9.917	
				429.95	9.909	
				469.95	9.889	
FCC/ISED	8K30F1E, 8K30F1D, 8K30F7W	12.5	High Power	406.15	7.701	11.25
				429.95	7.717	
				469.95	7.662	
			Low Power	406.15	7.685	
				429.95	7.718	
				469.95	7.652	
FCC/ISED	7K60FXD, 7K60FXE	12.5	High Power	406.15	7.627	11.25
				429.95	7.590	
				469.95	7.535	
			Low Power	406.15	7.550	
				429.95	7.606	
				469.95	7.571	
FCC/ISED	4K00F1E, 4K00F1D, 4K00F7W	6.25	High Power	406.15	3.551	6.00
				429.95	3.524	
				469.95	3.477	
			Low Power	406.15	3.523	
				429.95	3.524	
				469.95	3.527	
FCC/ISED	4K00F2D	6.25	High Power	406.15	4.016	6.00
				429.95	4.016	
				469.95	4.018	
			Low Power	406.15	4.022	
				429.95	4.021	
				469.95	4.019	



Plots of 99% Bandwidth

16K0F3E\_ISED

(406.15 MHz)\_High

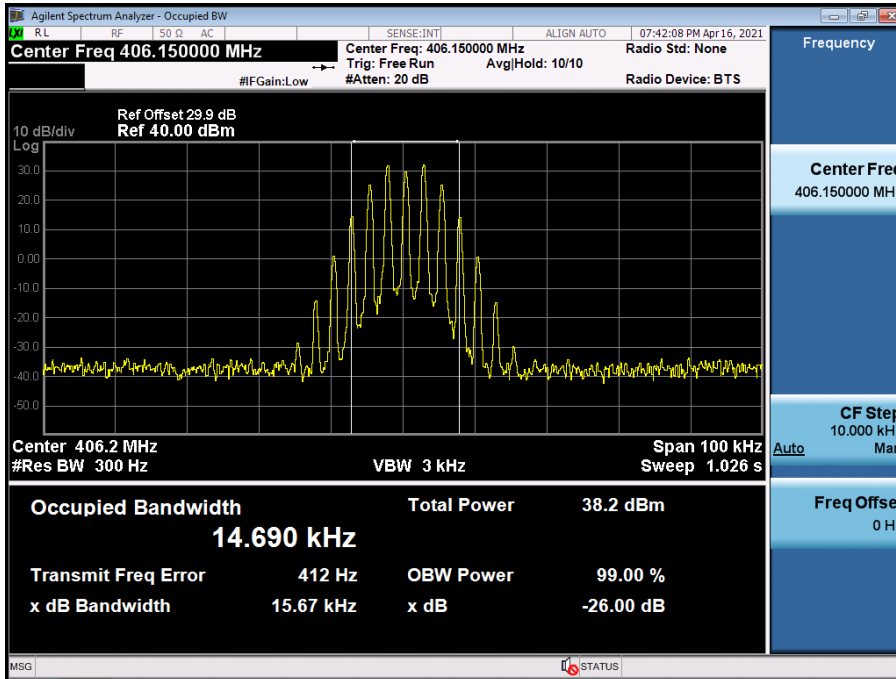

(429.95 MHz)\_High

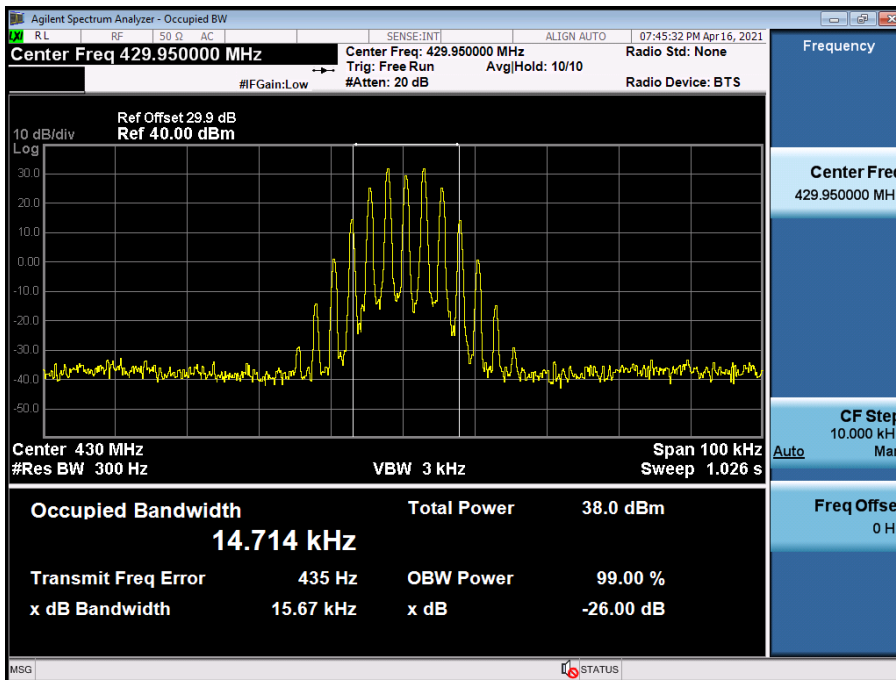

(469.95 MHz)\_High

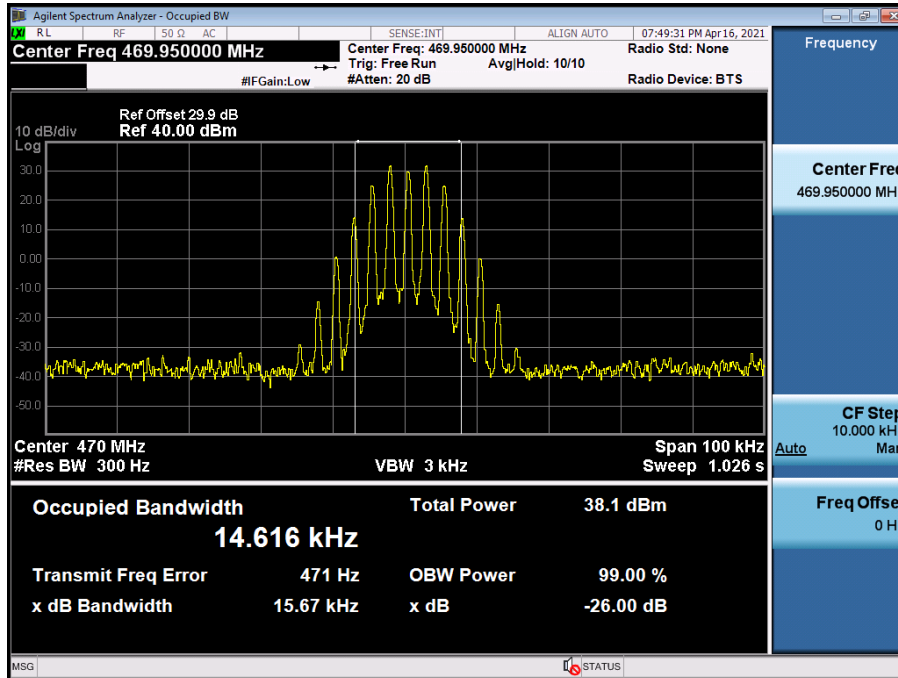

(406.15 MHz)\_Low

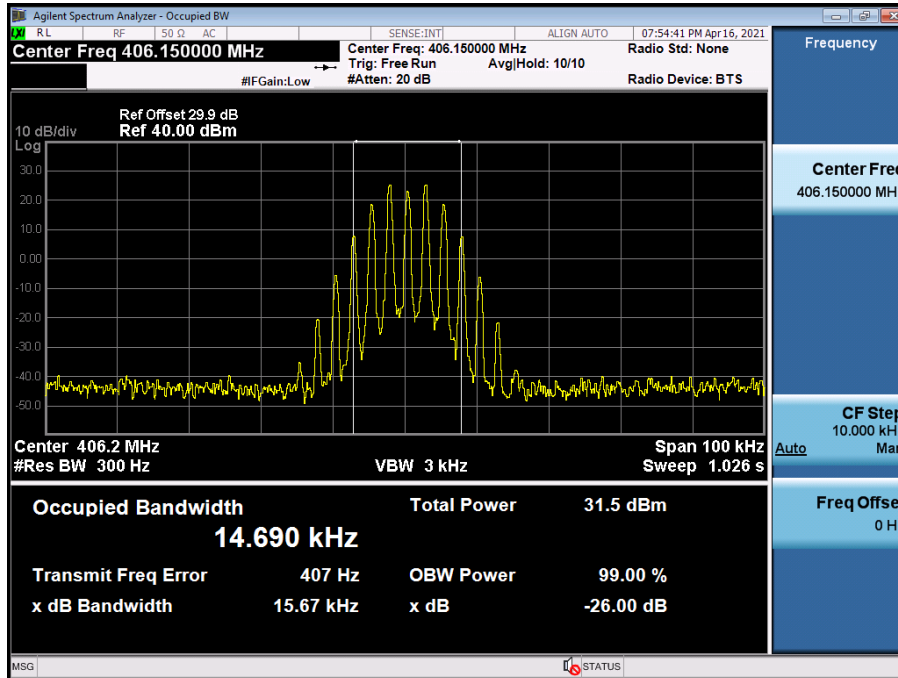

(429.95 MHz)\_Low

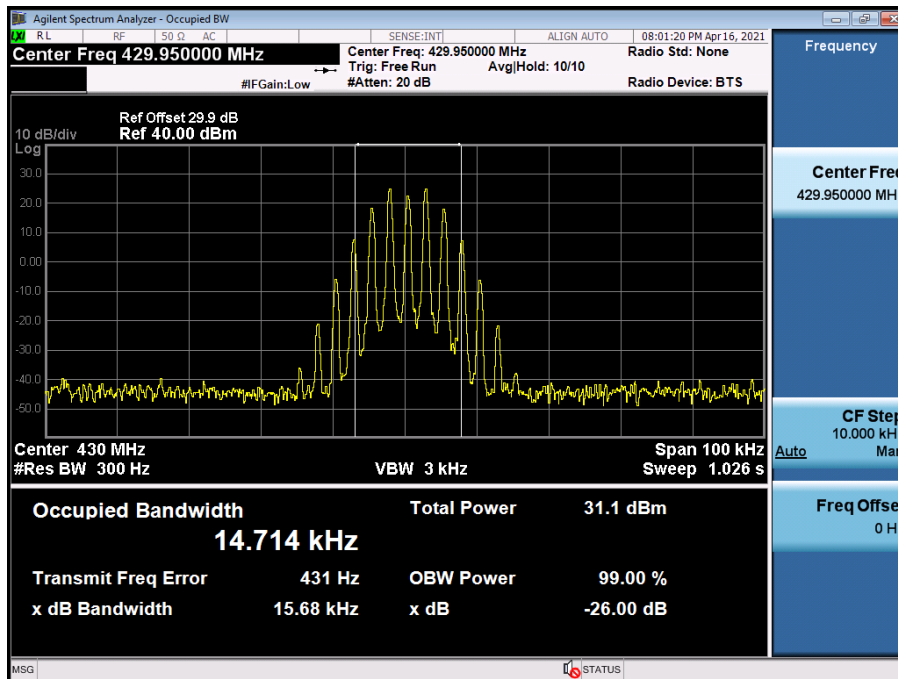

(469.95 MHz)\_ Low

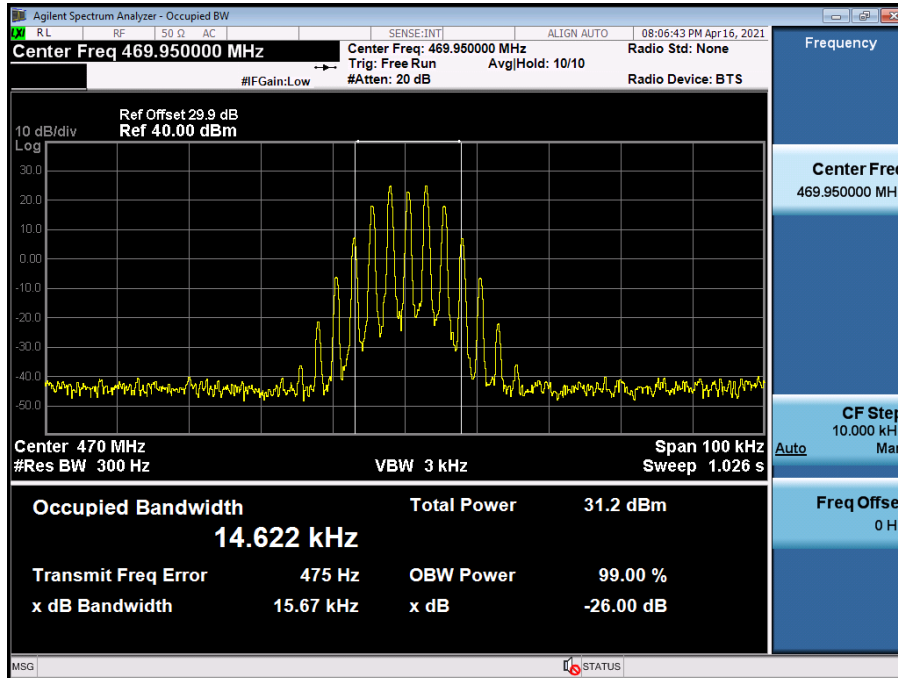

11K0F3E\_FCC/ISED

(406.15 MHz)\_High

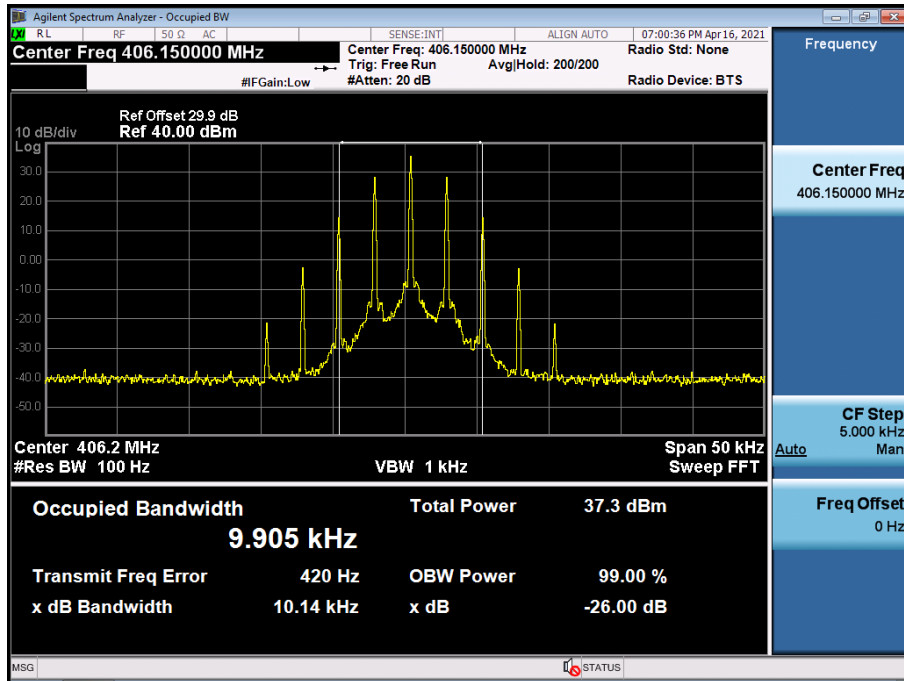

(429.95 MHz)\_High

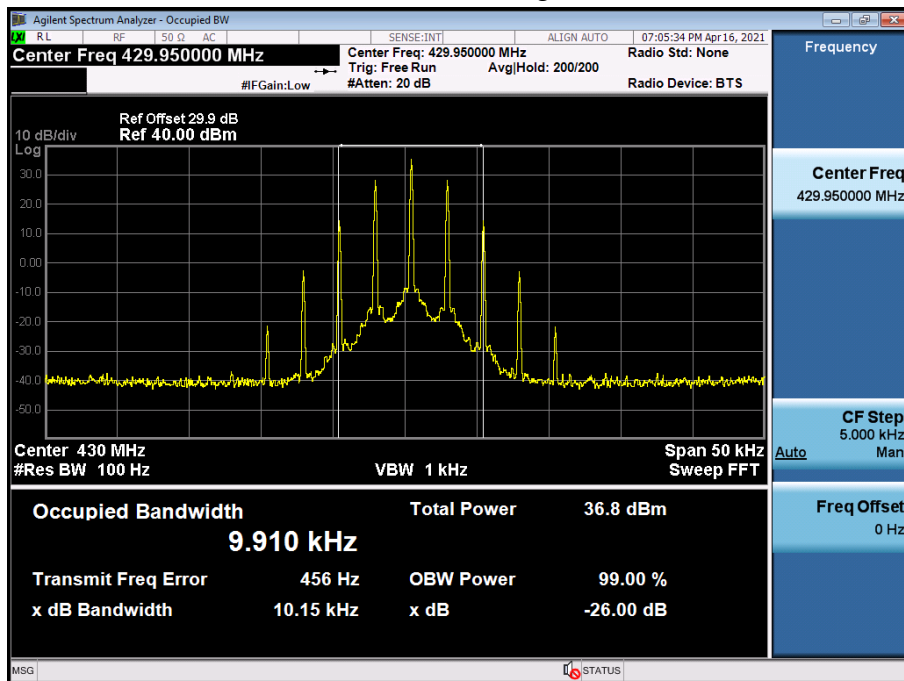

(469.95 MHz)\_High

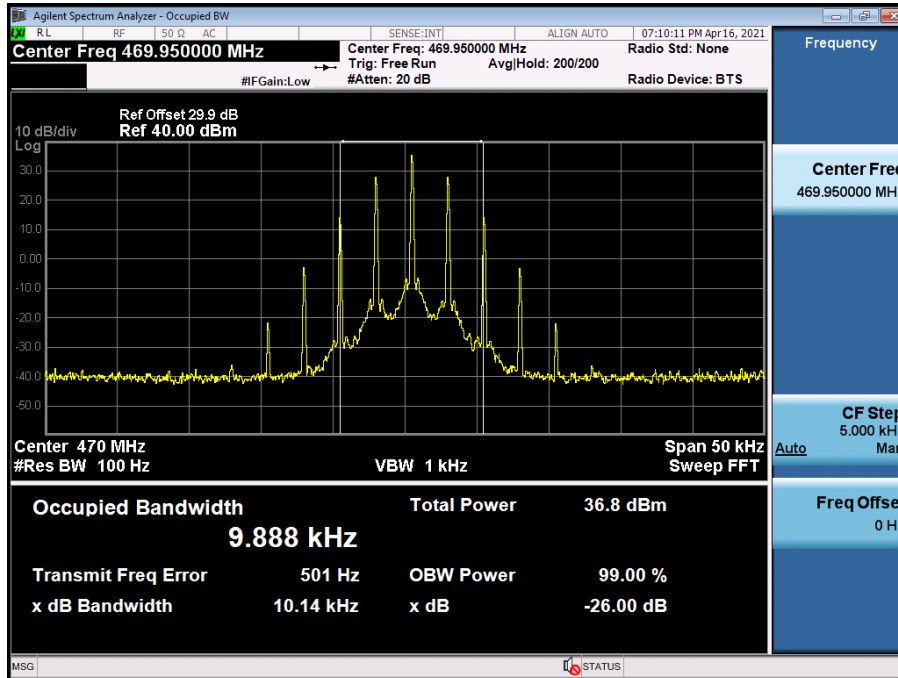

(406.15 MHz)\_Low

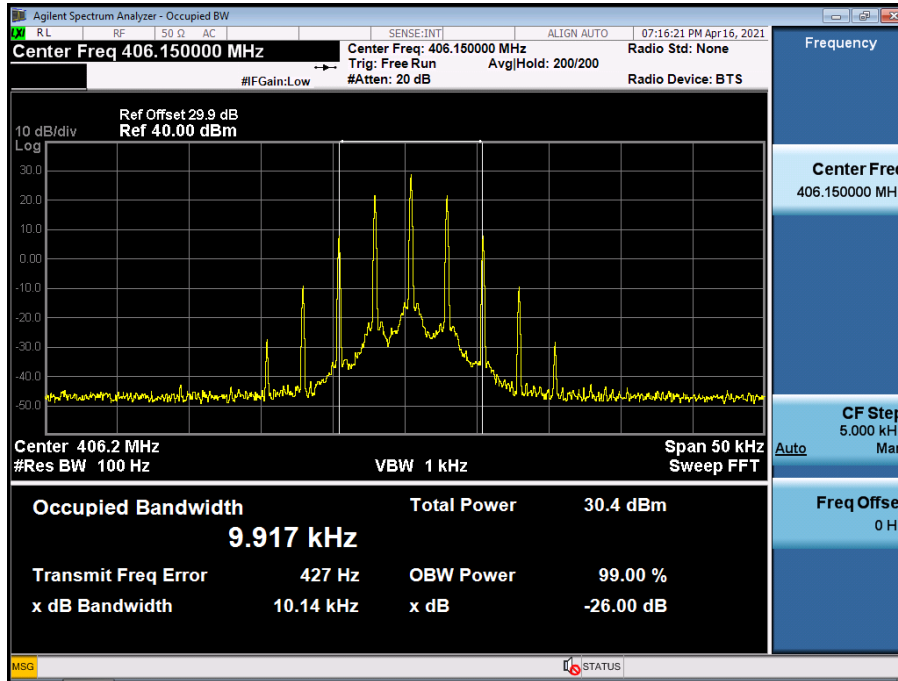

(429.95 MHz)\_Low

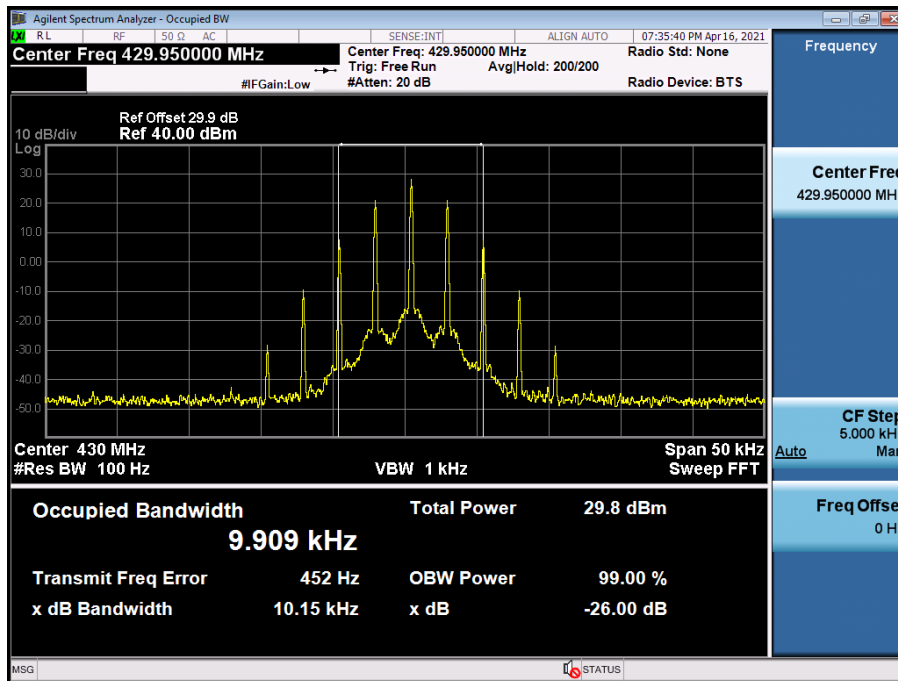

(469.95 MHz)\_ Low

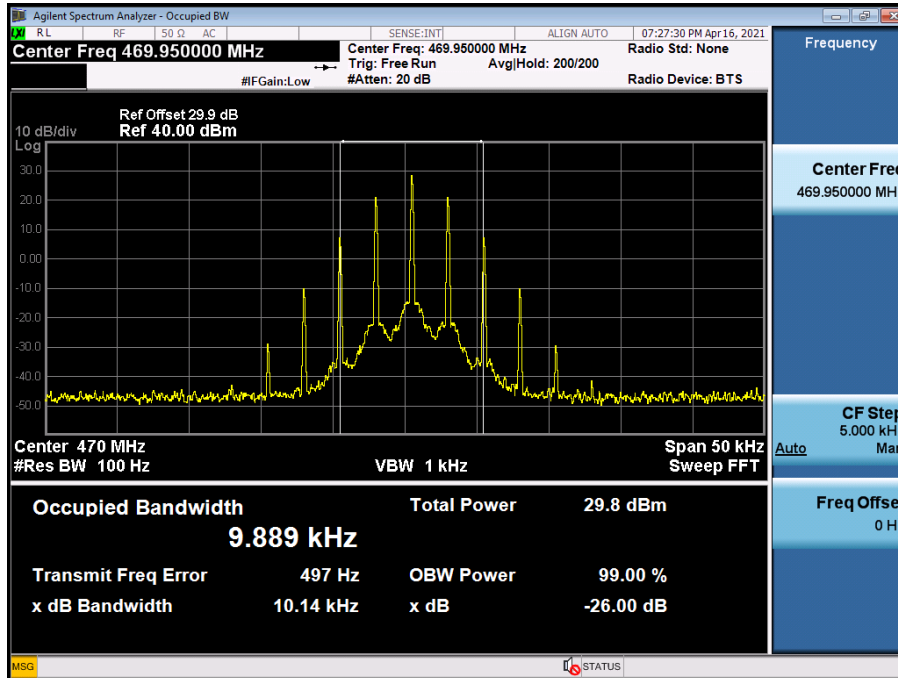



8K30F1E, 8K30F1D, 8K30F7W\_FCC/ISED

(406.15 MHz)\_High

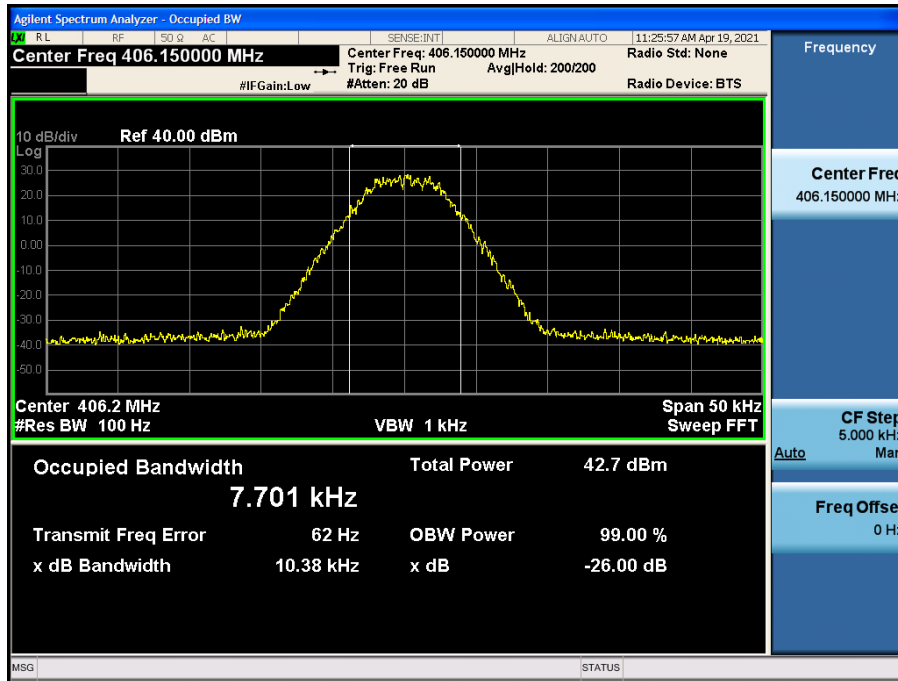

(429.95 MHz)\_High

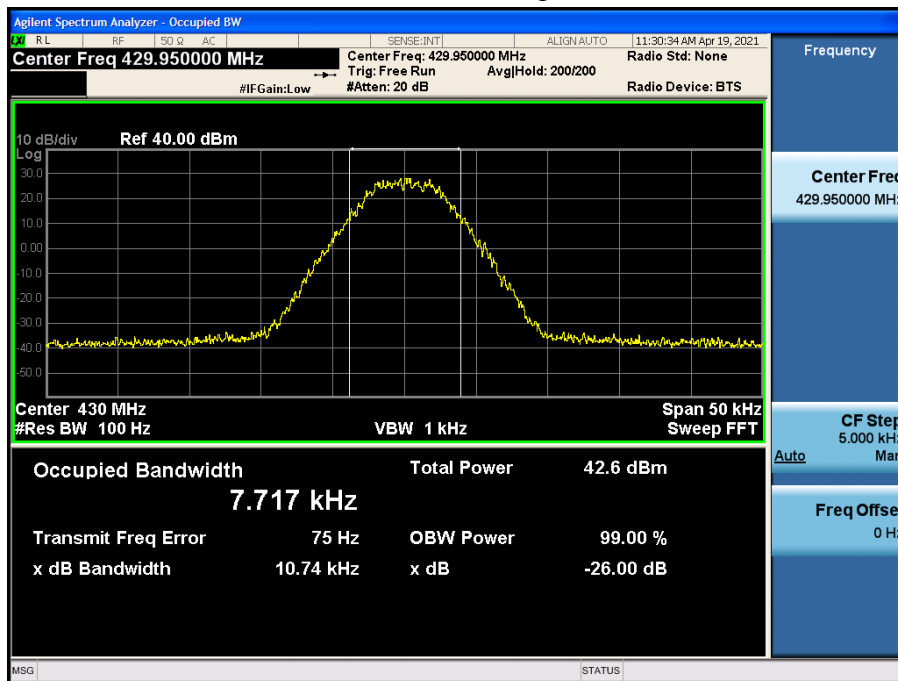

(469.95 MHz)\_High

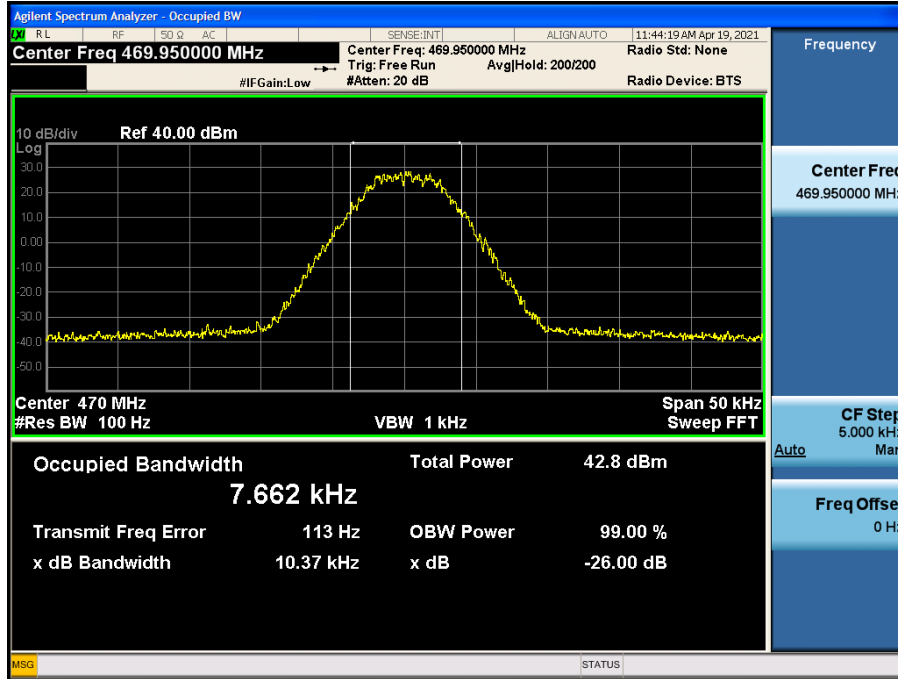

(406.15 MHz)\_Low

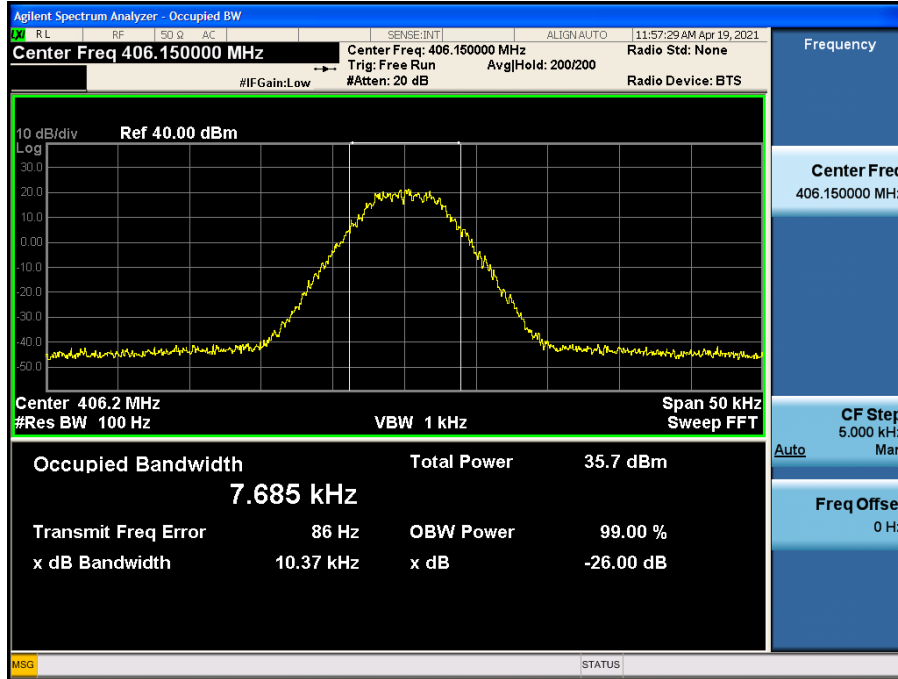

(429.95 MHz)\_Low

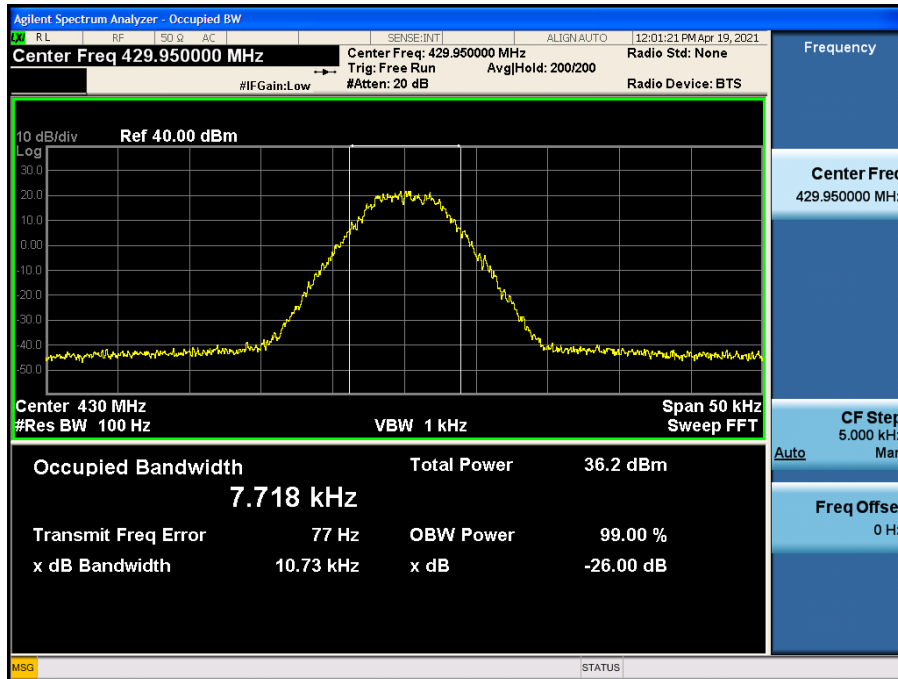

(469.95 MHz)\_ Low

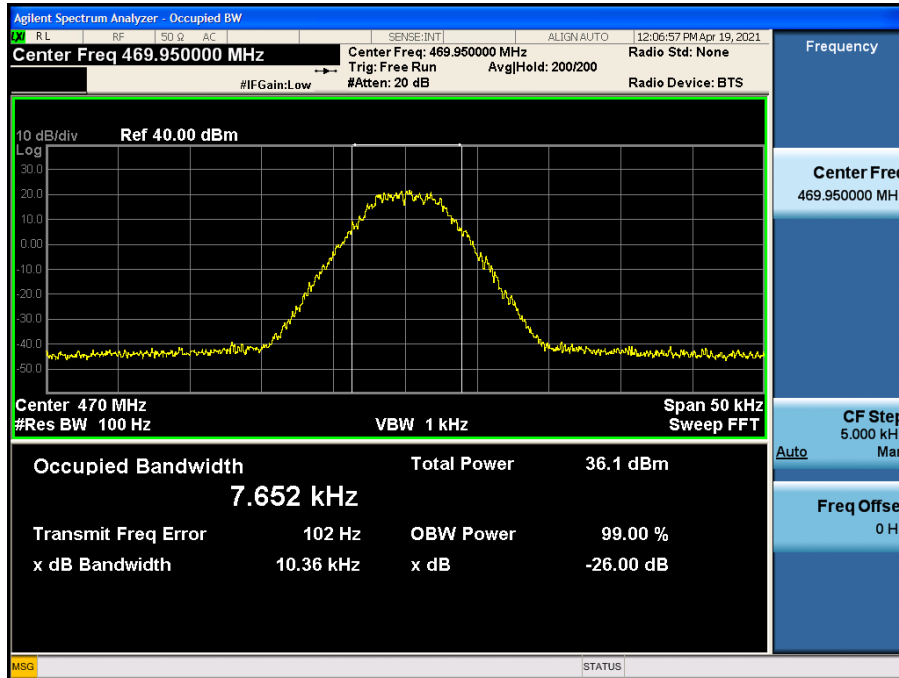

7K60FXD, 7K60FXE\_FCC/ISED

(406.15 MHz)\_High

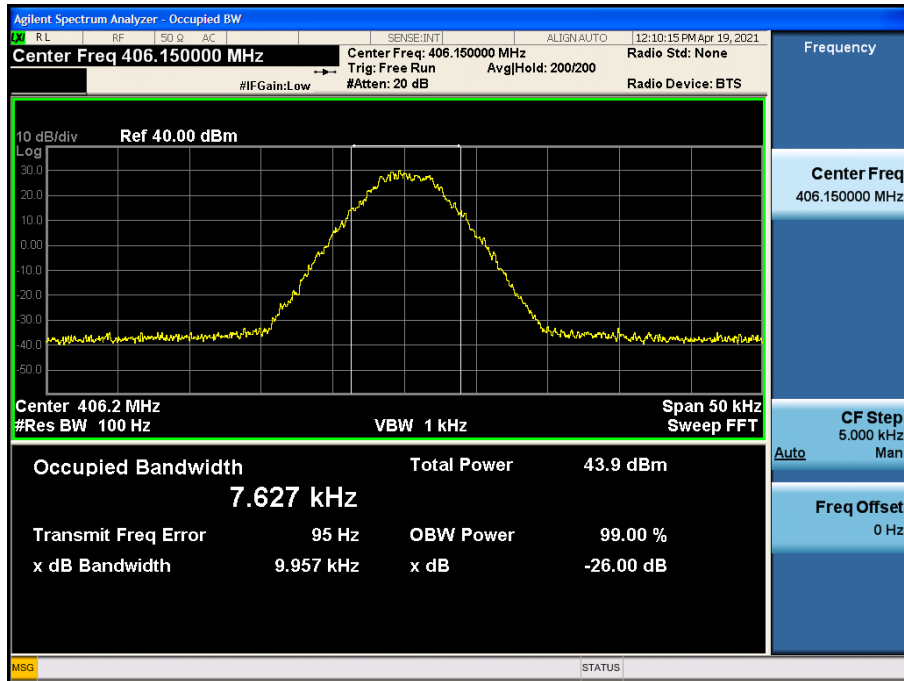

(429.95 MHz)\_High

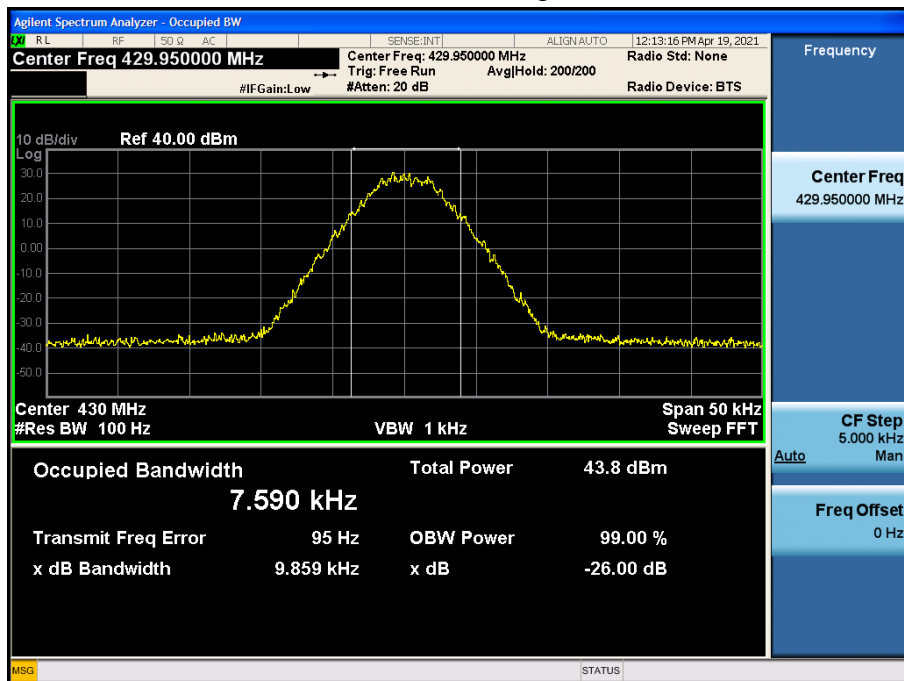

(469.95 MHz)\_High

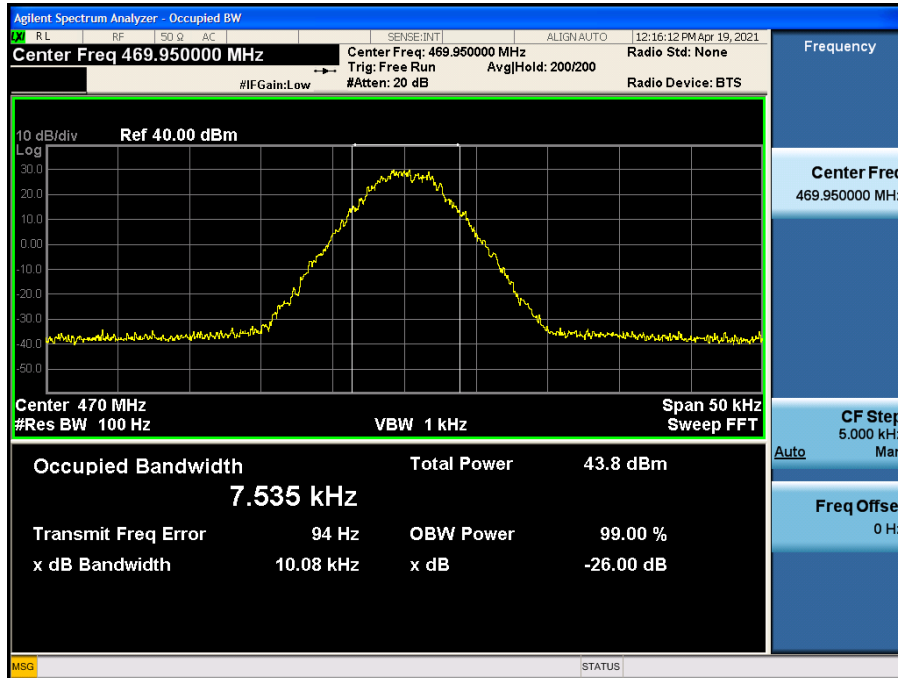

(406.15 MHz)\_Low

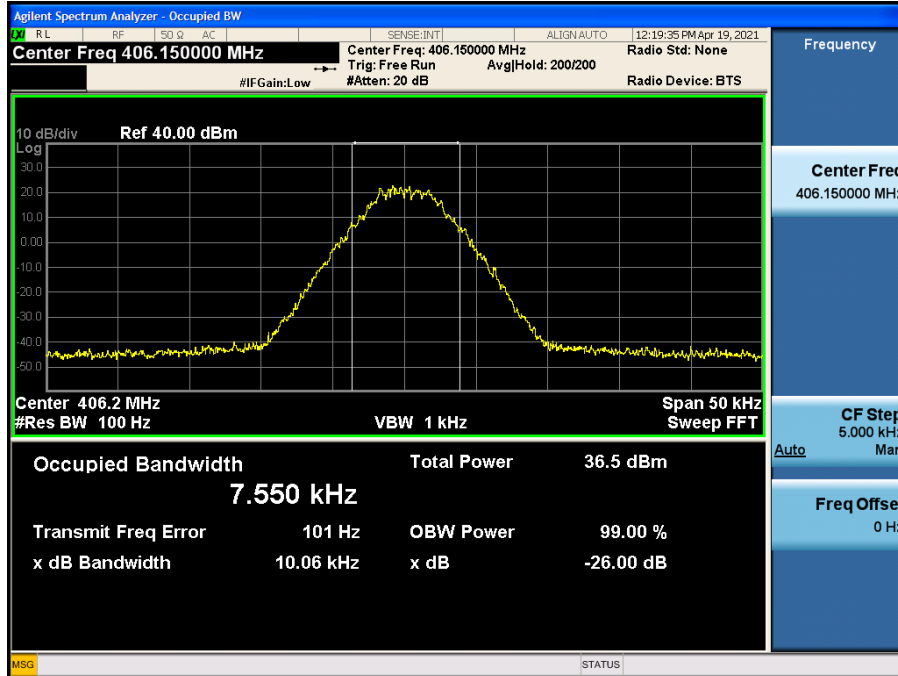

(429.95 MHz)\_Low

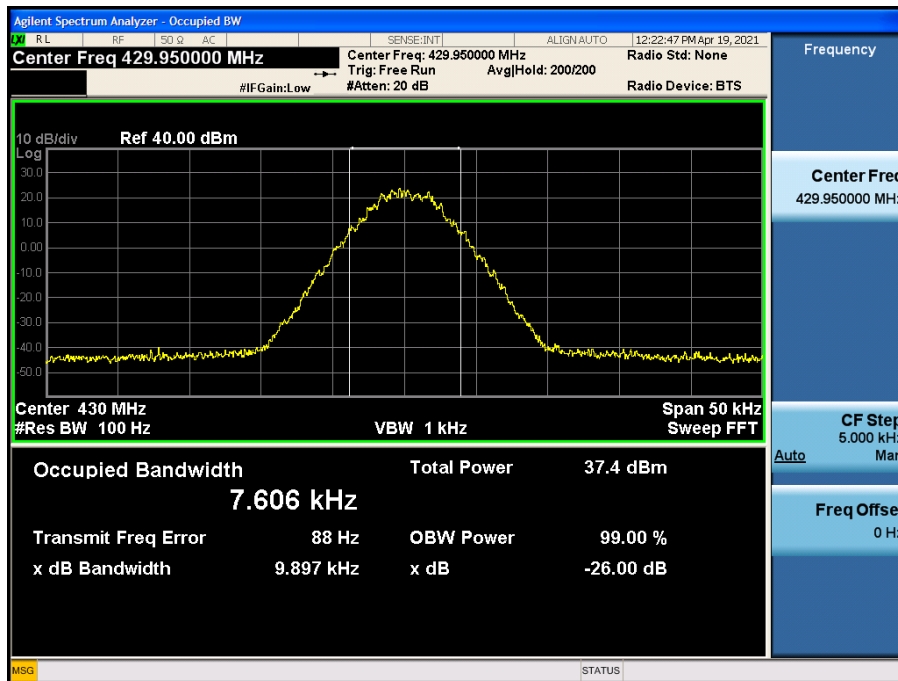

(469.95 MHz)\_ Low

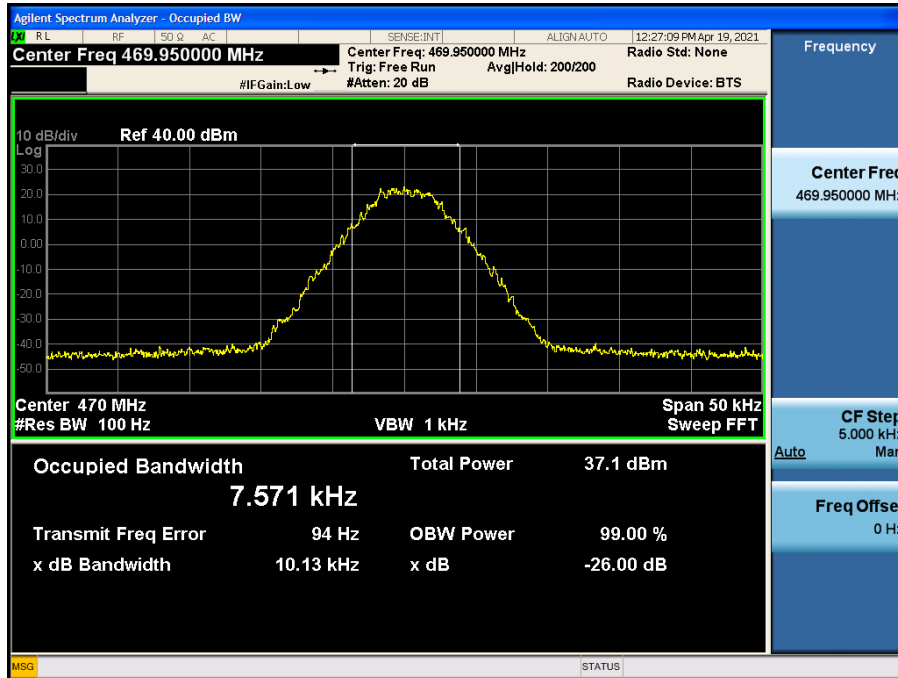



4K00F1E, 4K00F1D, 4K00F7W\_FCC/ISED

(406.15 MHz)\_High

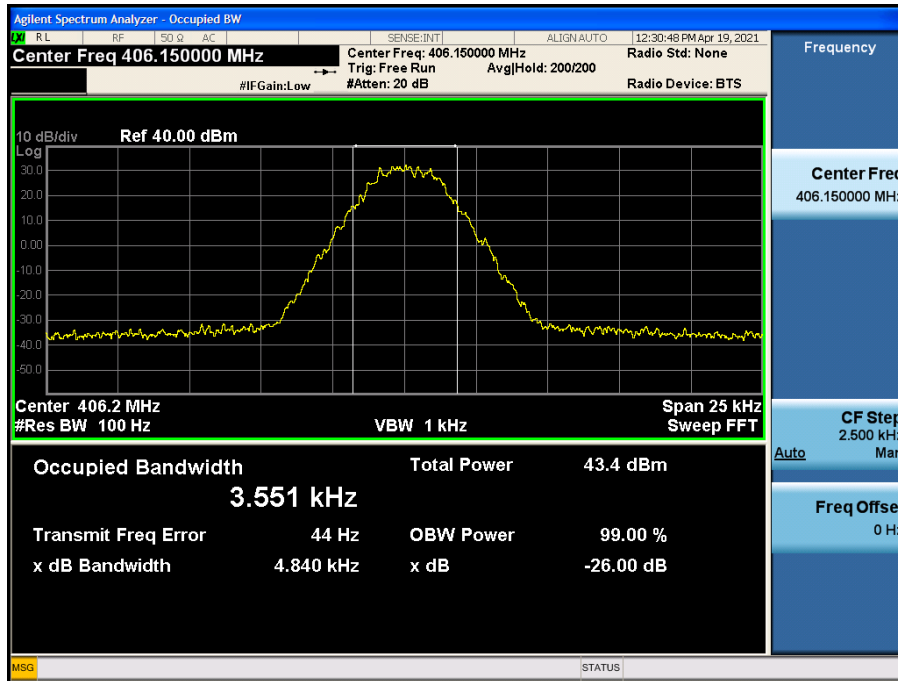

(429.95 MHz)\_High

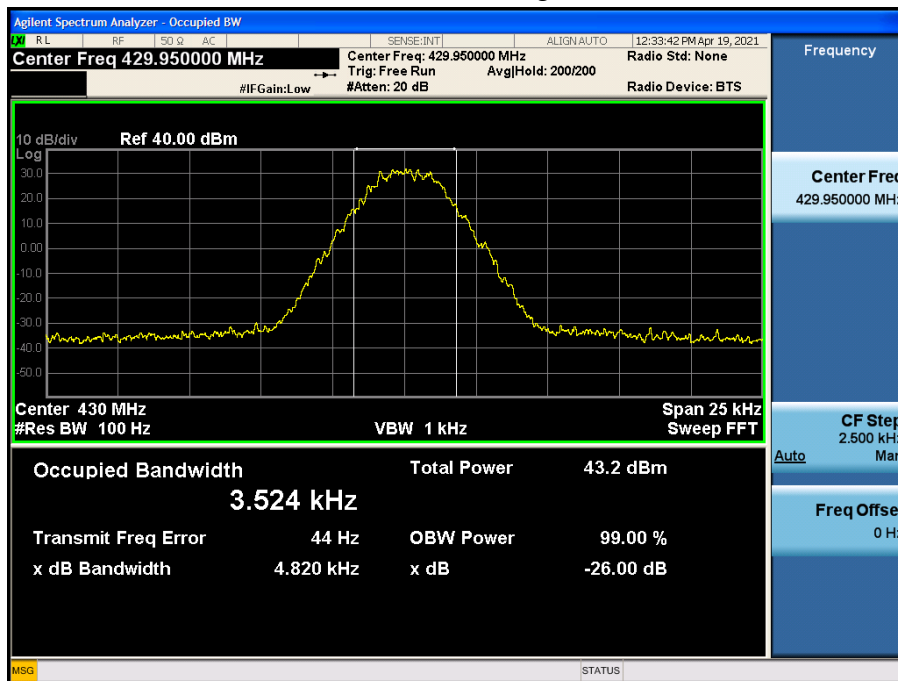

(469.95 MHz)\_High

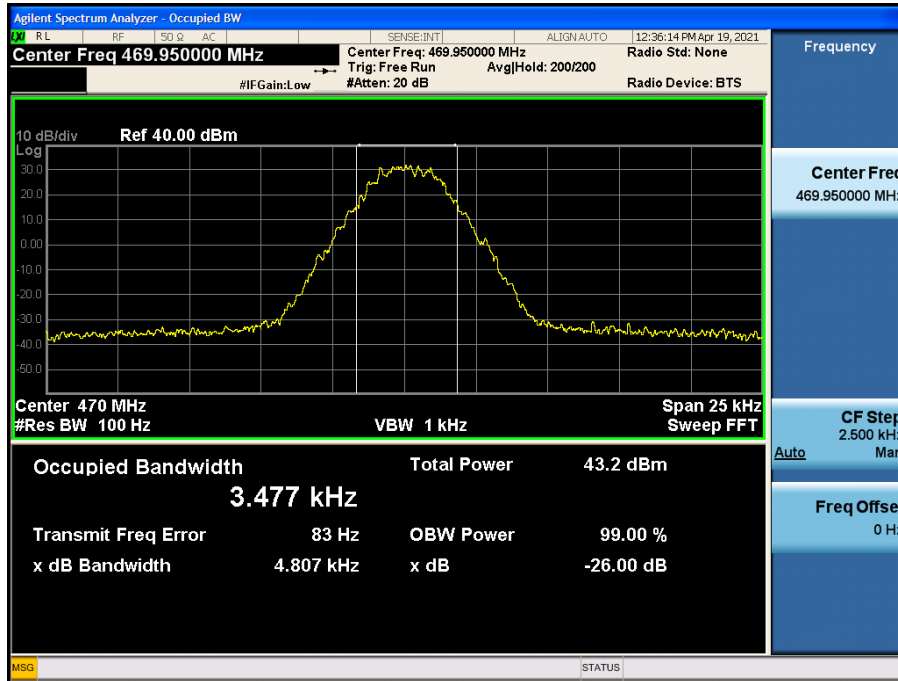

(406.15 MHz)\_Low

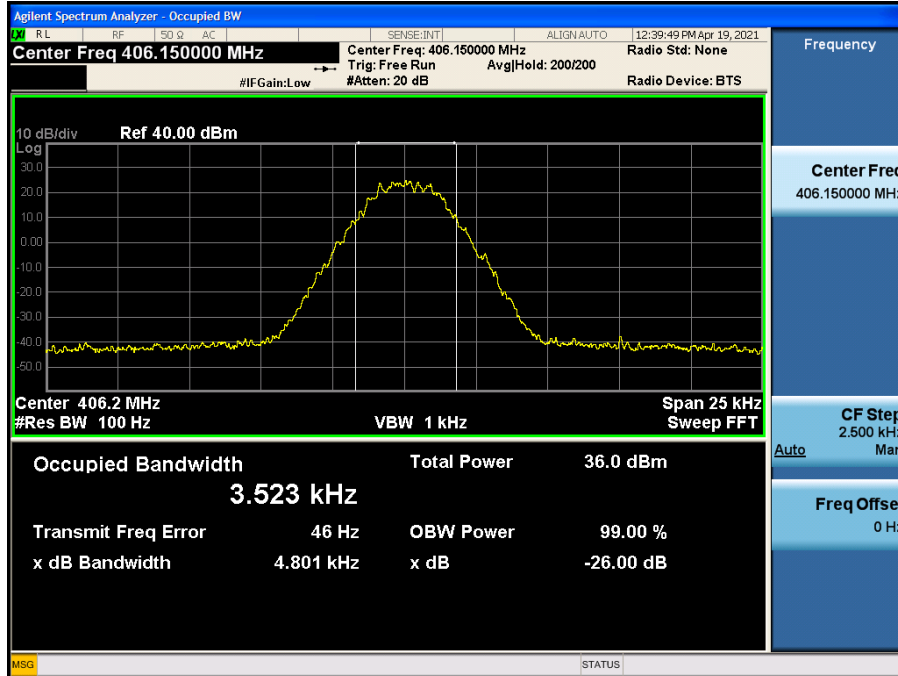

(429.95 MHz)\_Low

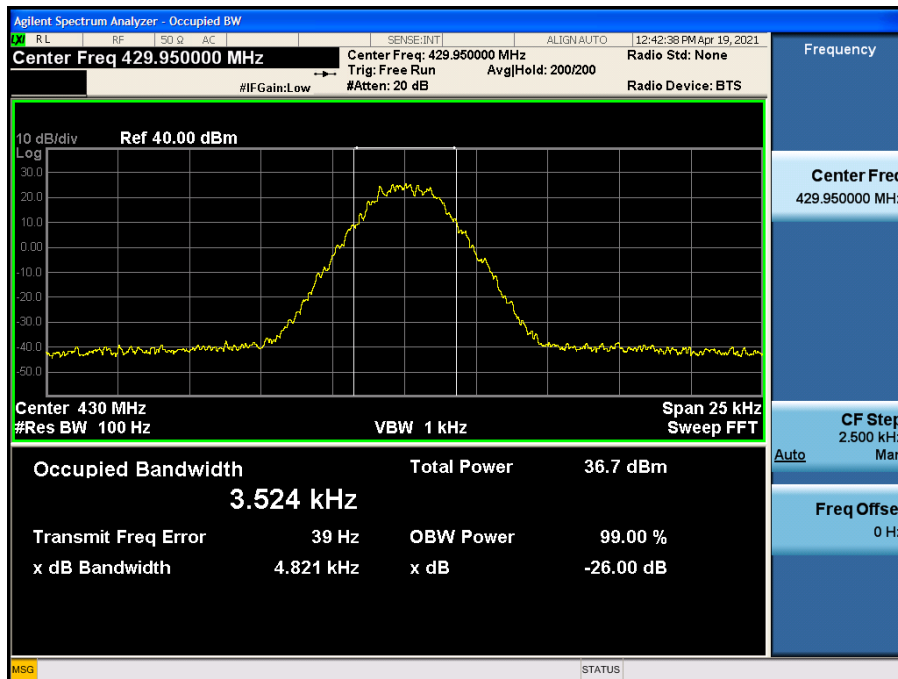

(469.95 MHz)\_ Low

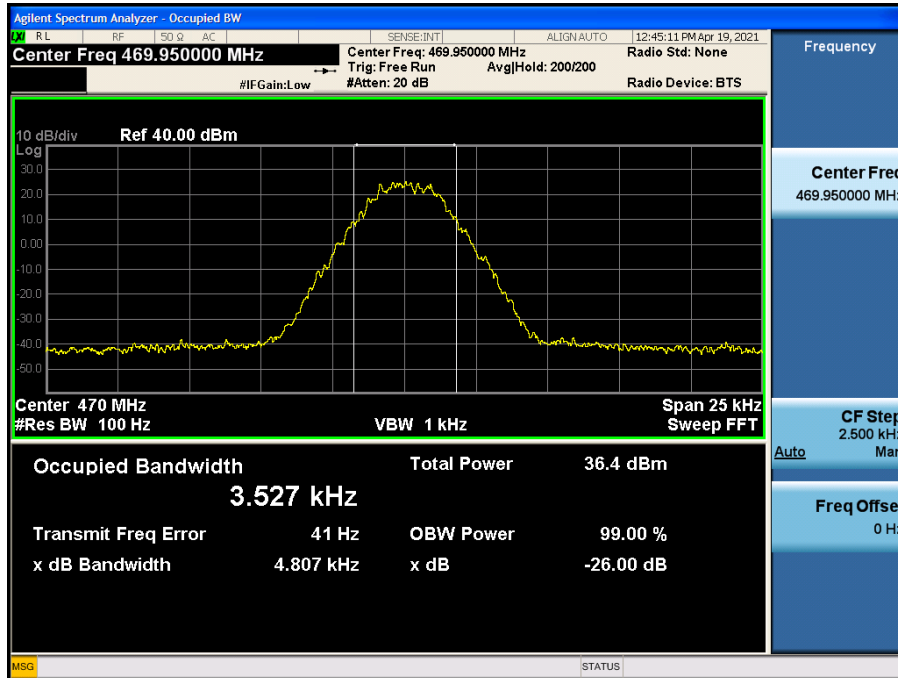

4K00F2D\_FCC/ISED

(406.15 MHz)\_High

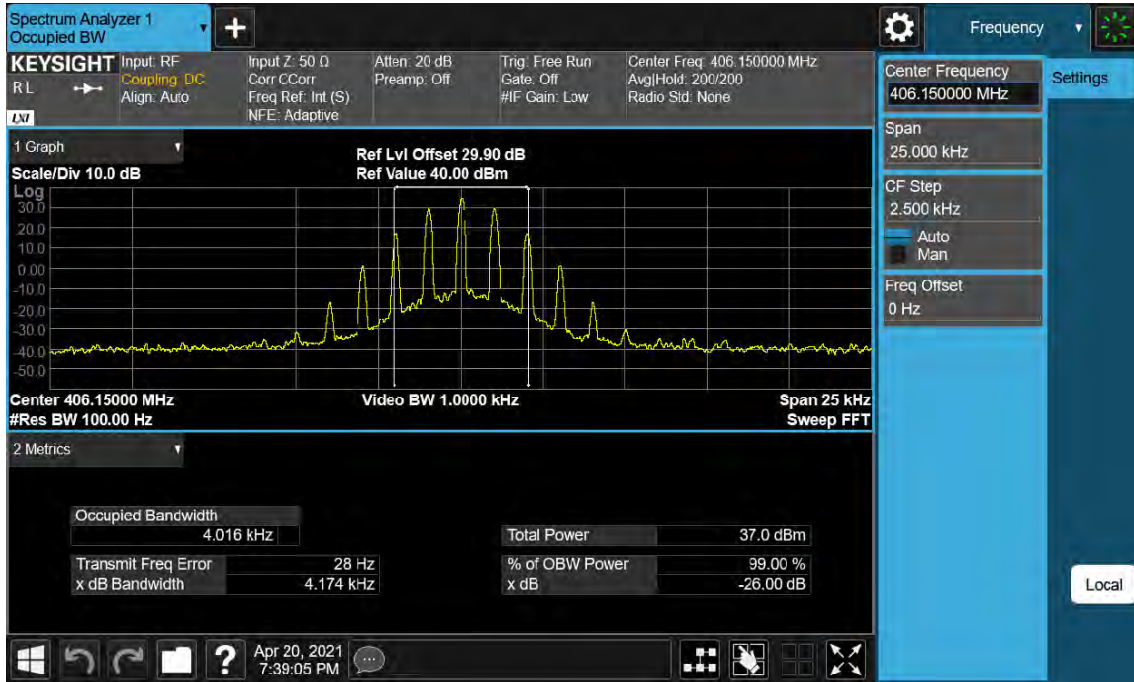

(429.95 MHz)\_High

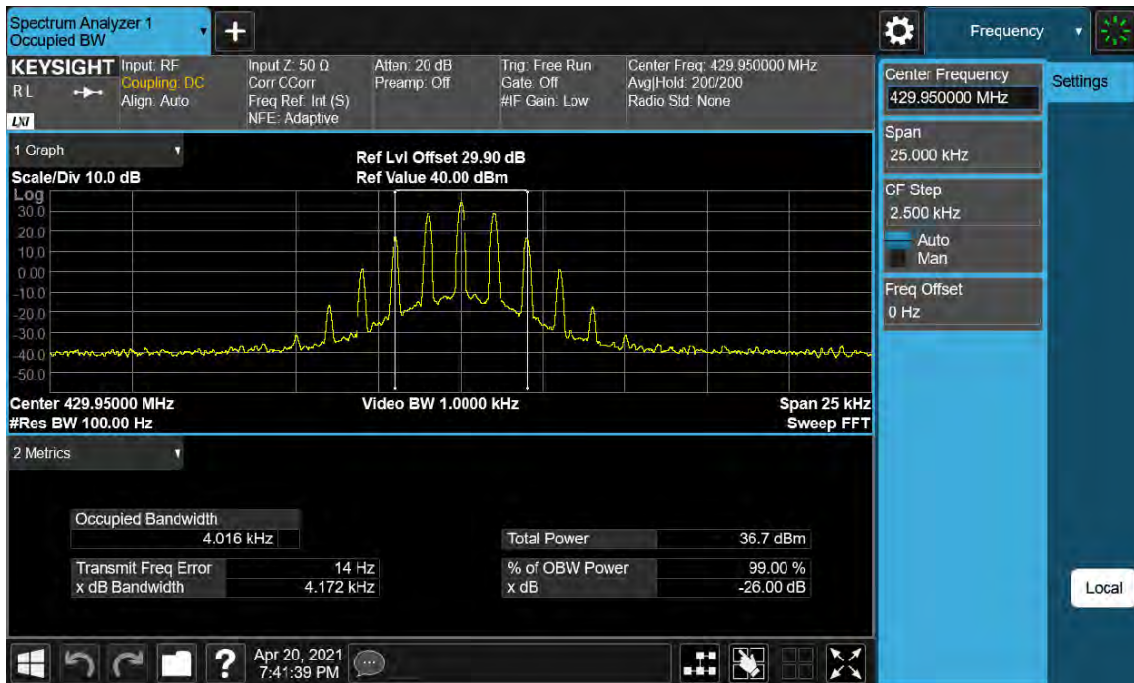

(469.95 MHz)\_High

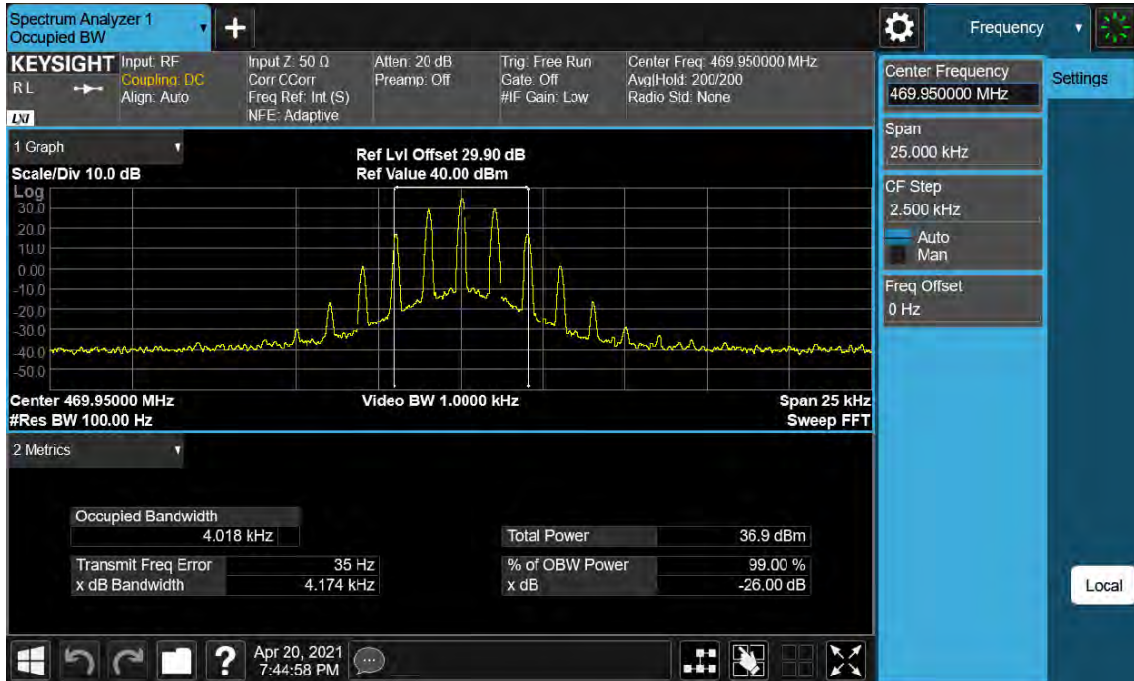



(469.95 MHz)\_ Low

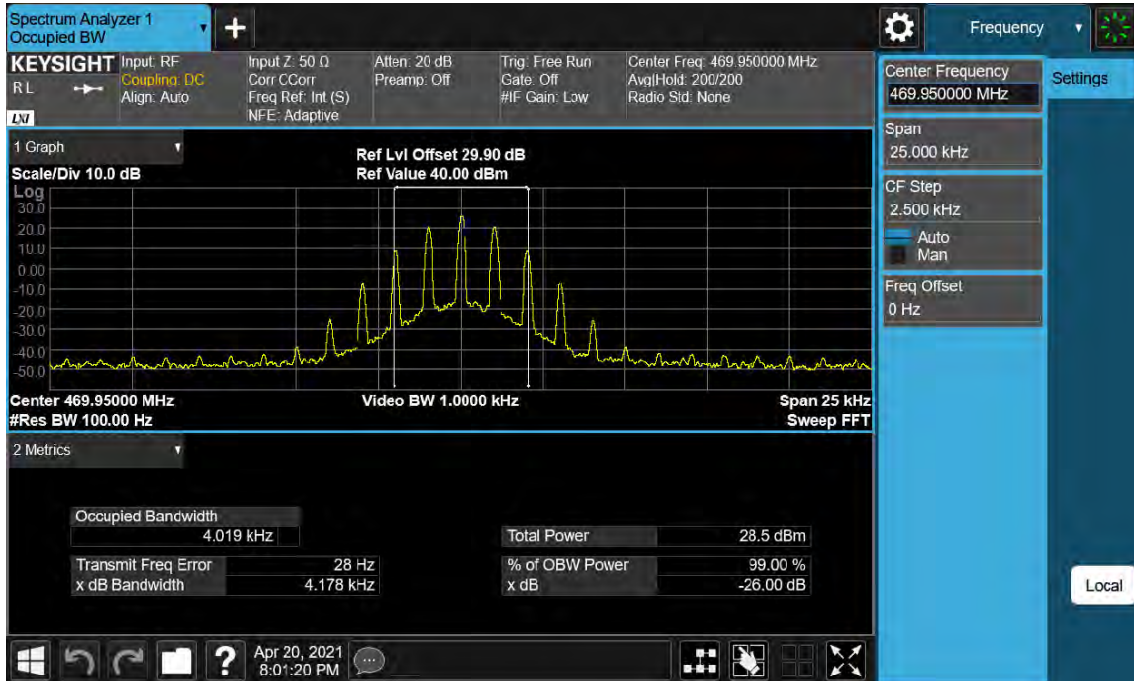



## 8.4 Modulation Limiting

### ▣ Definition

Modulation limiting is the transmitter circuit's ability to limit the transmitter from producing deviations in excess of a rated system deviation.

### ▣ TEST CONFIGURATION

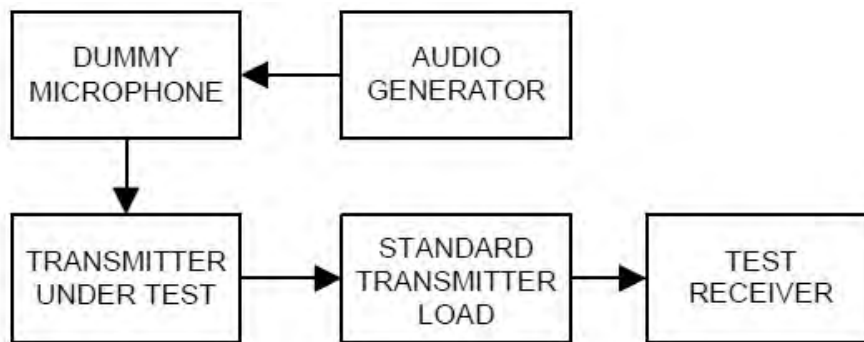

### ▣ TEST PROCEDURE

According to 2.2.3 in TIA-603-E Standard.

- a) Connect the equipment as illustrated.
- b) Adjust the transmitter per the manufacturer's procedure for full rated system deviation.
- c) Set the test receiver to measure peak positive deviation.  
Set the audio bandwidth for  $\leq 0.25$  Hz to  $\geq 15,000$  Hz.  
Turn the de-emphasis function off.
- d) Apply a 1000 Hz modulating signal to the transmitter from the audio frequency generator, and adjust the level obtain 60% of full rated system deviation.
- e) Increase the level form the audio frequency generator by 20 dB in one step(rise time between the 10% and 90% points shall be 0.1 second maximum).
- f) Measure both the instantaneous and steady-state deviation at and after the time of increasing the audio input level.
- g) With the level from the audio frequency generator held constant at the level obtained in step e), Slowly vary the audio frequency from 300 Hz to 3000 Hz and observe the steady-state deviation. Record the maximum deviation.
- h) Set the test receiver to measure peak negative deviation and repeat steps d) through g).
- i) The values recorded in steps g) and h) are the modulation limiting.

▣ TEST RESULTS (11K0F3E)

Positive Peaks

HIGH POWER

406.15 MHz

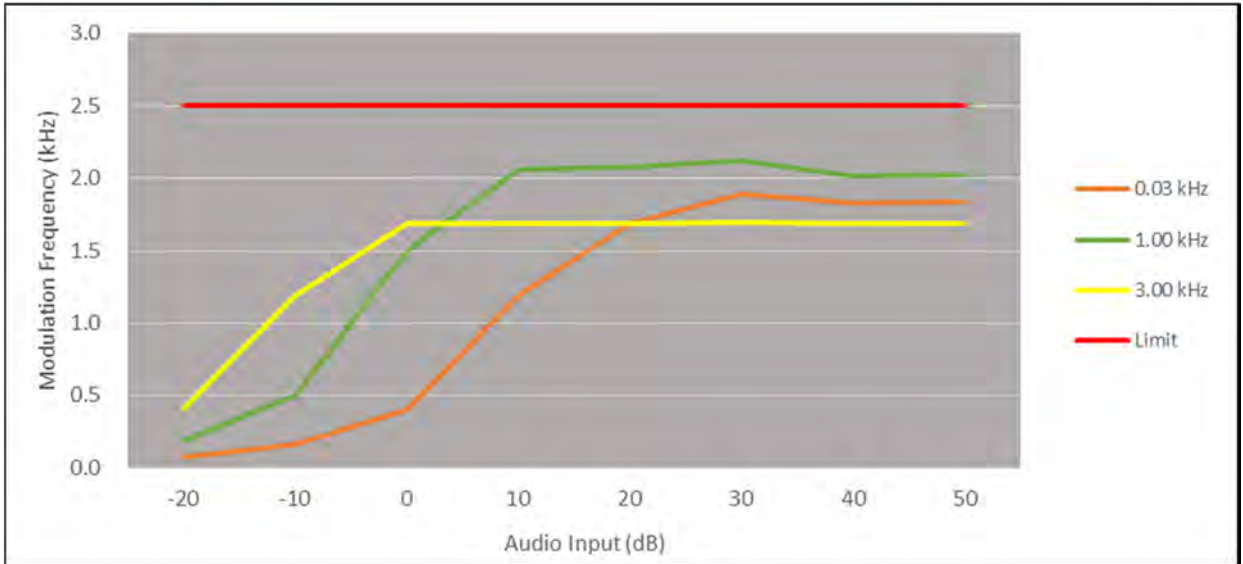

429.95 MHz

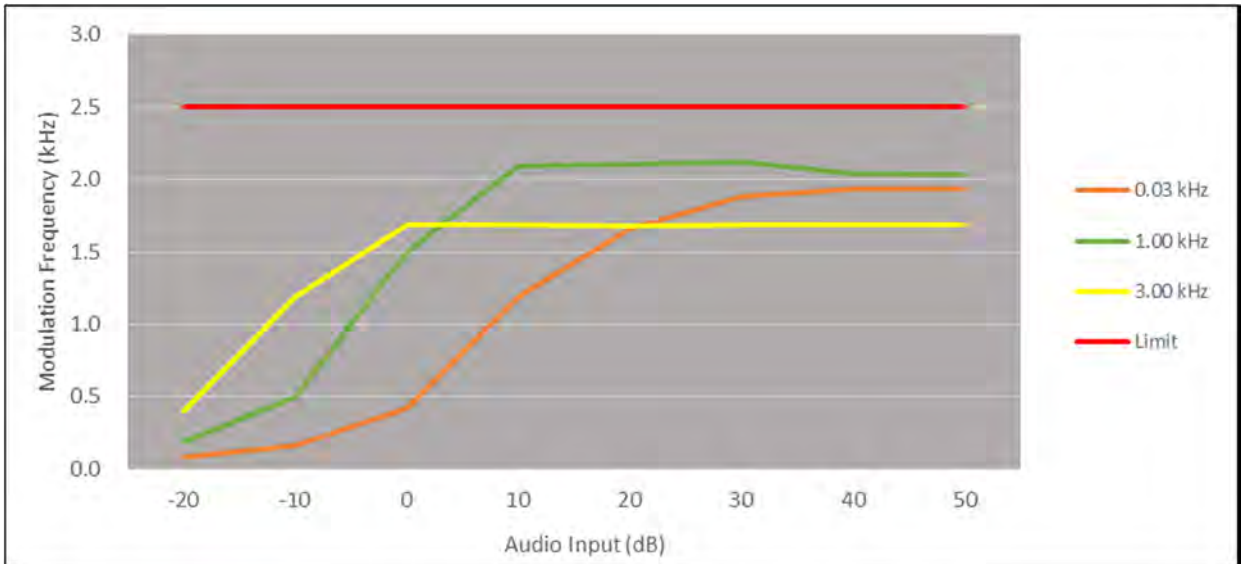

469.95 MHz

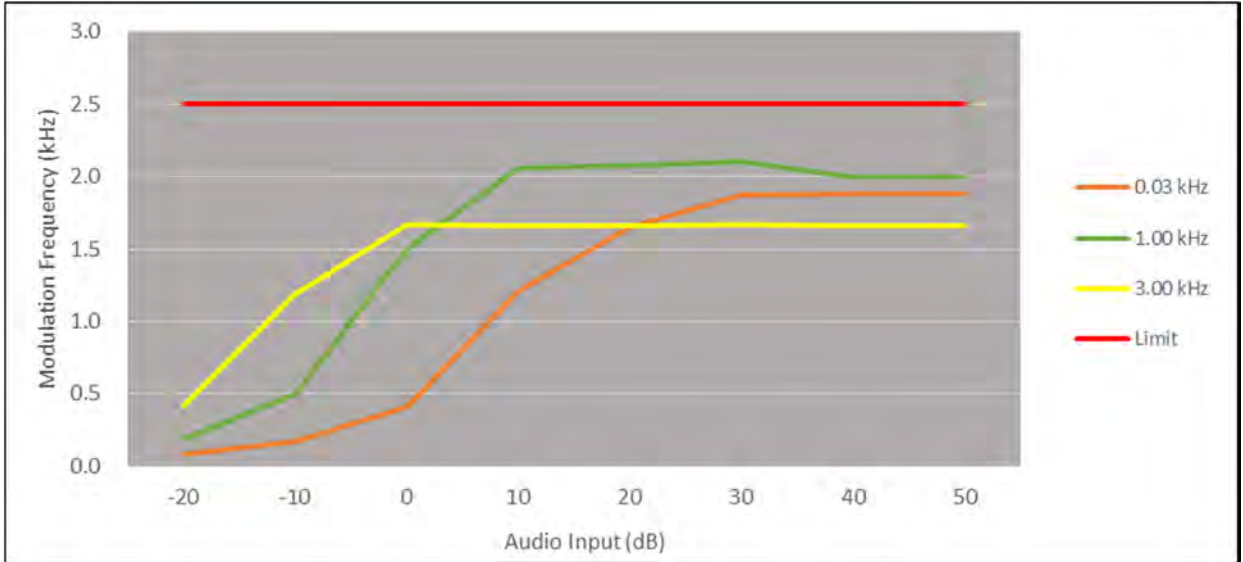

## LOW POWER

406.15 MHz

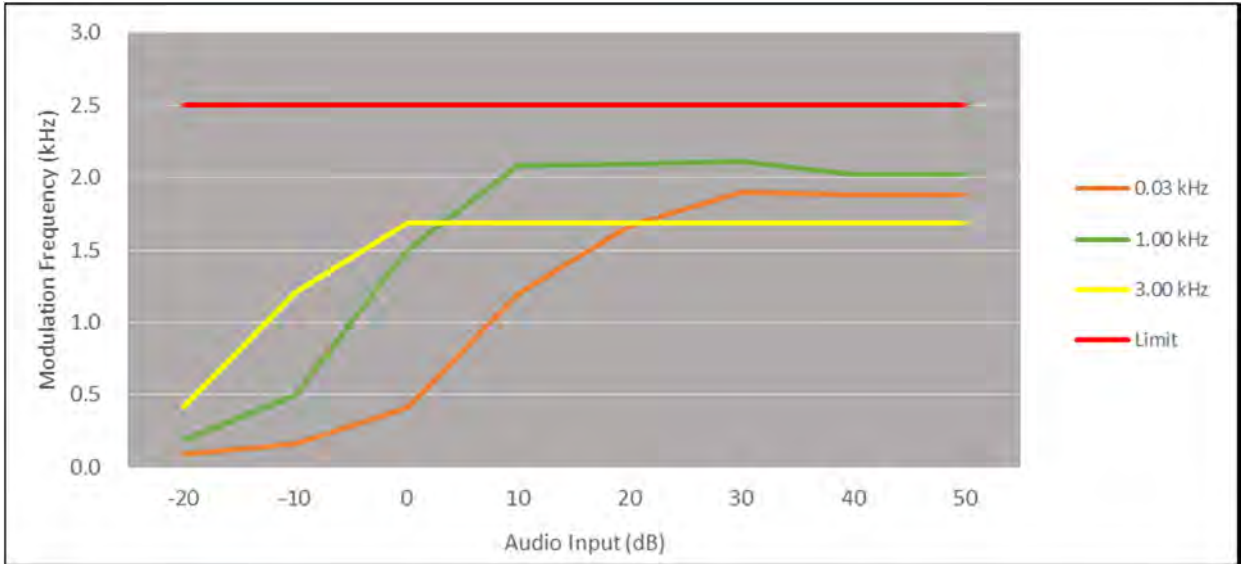

429.95 MHz

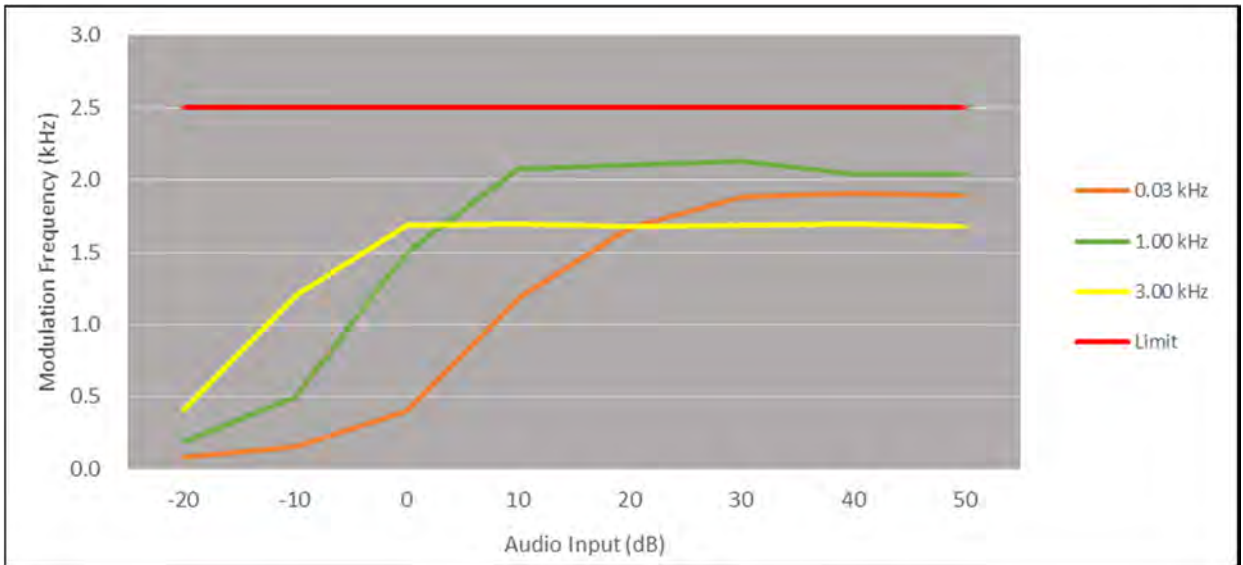

### 469.95 MHz

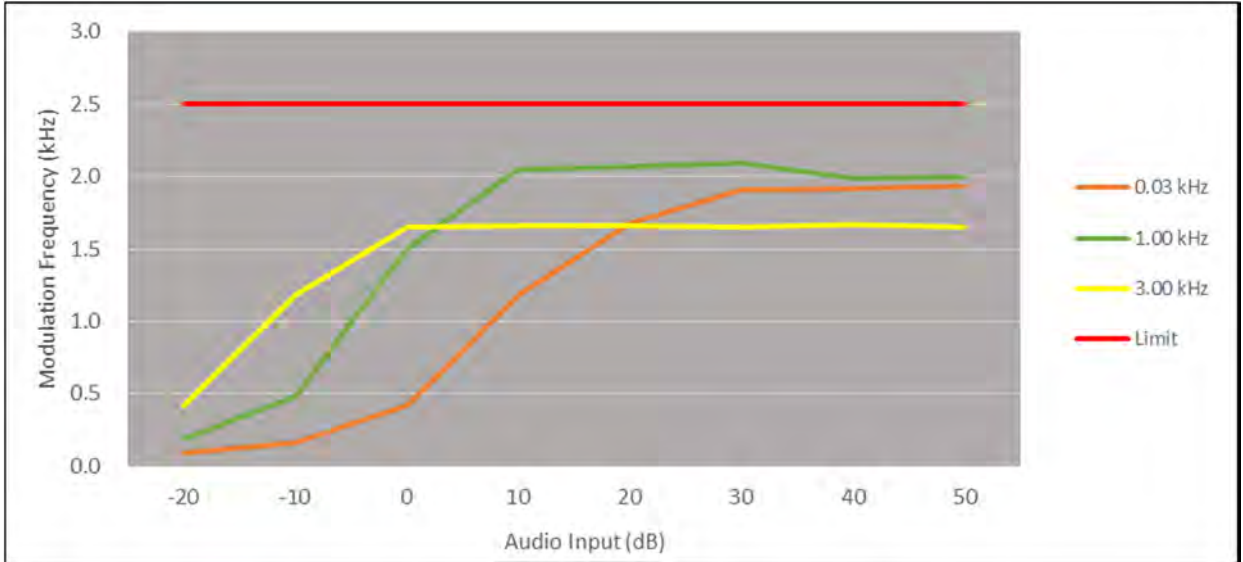

### Negative Peaks

### HIGH POWER

406.15 MHz

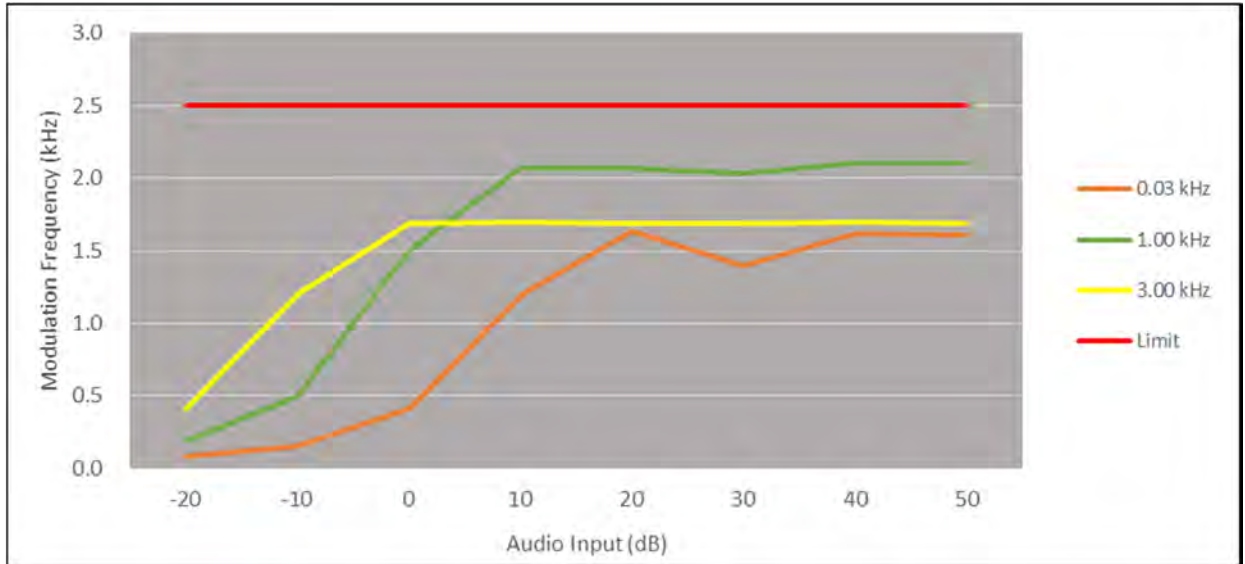

429.95 MHz

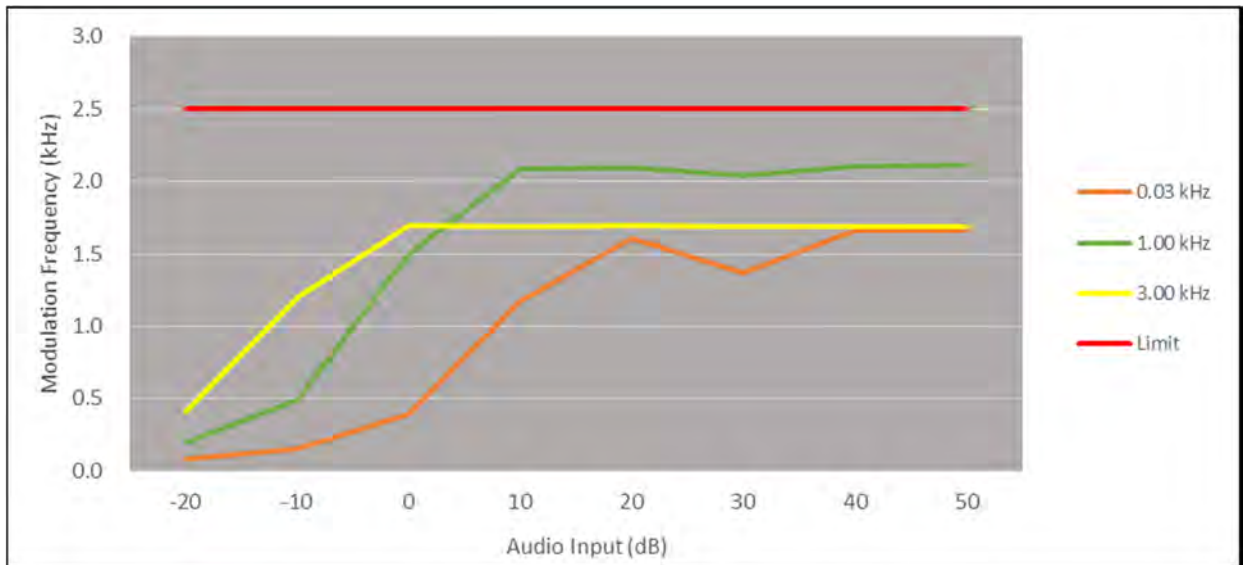

469.95 MHz

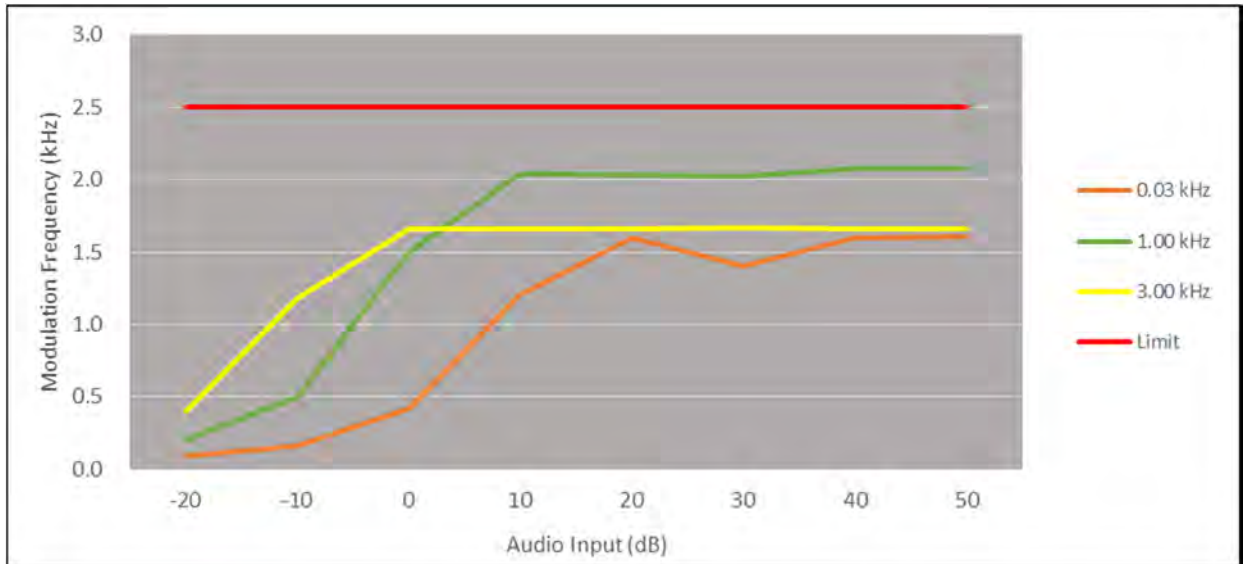

## LOW POWER

406.15 MHz

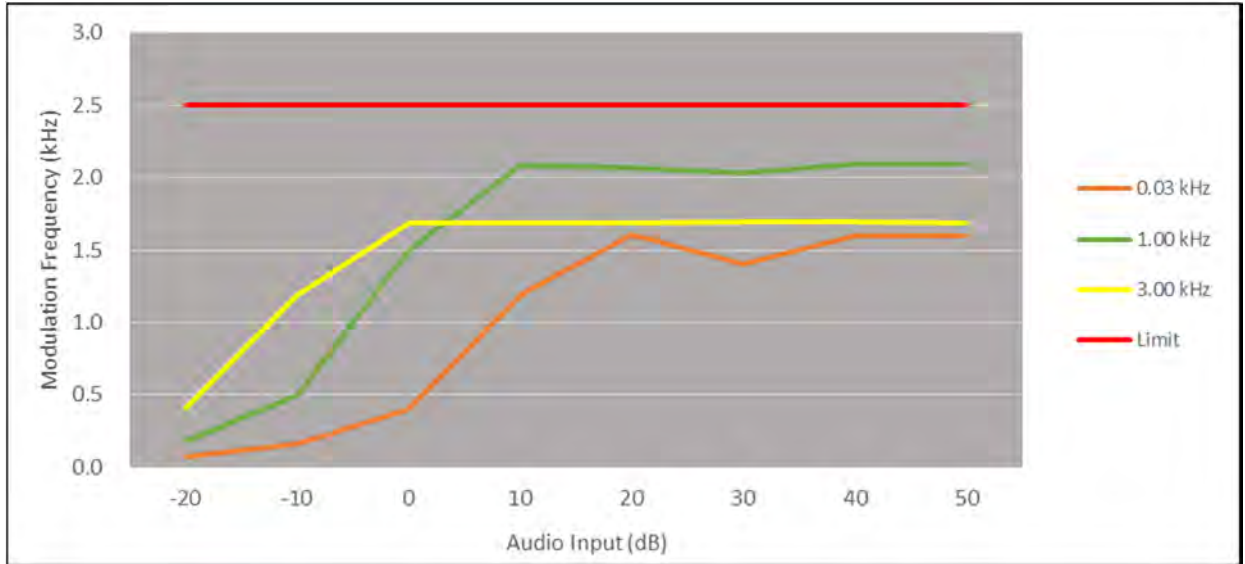

429.95 MHz

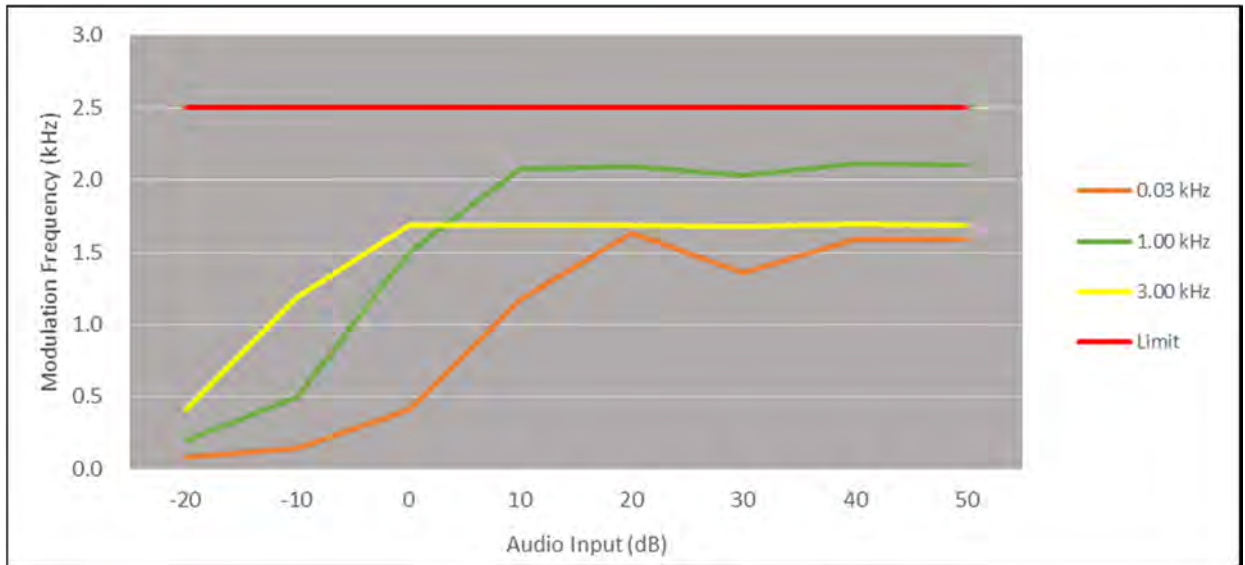



469.95 MHz

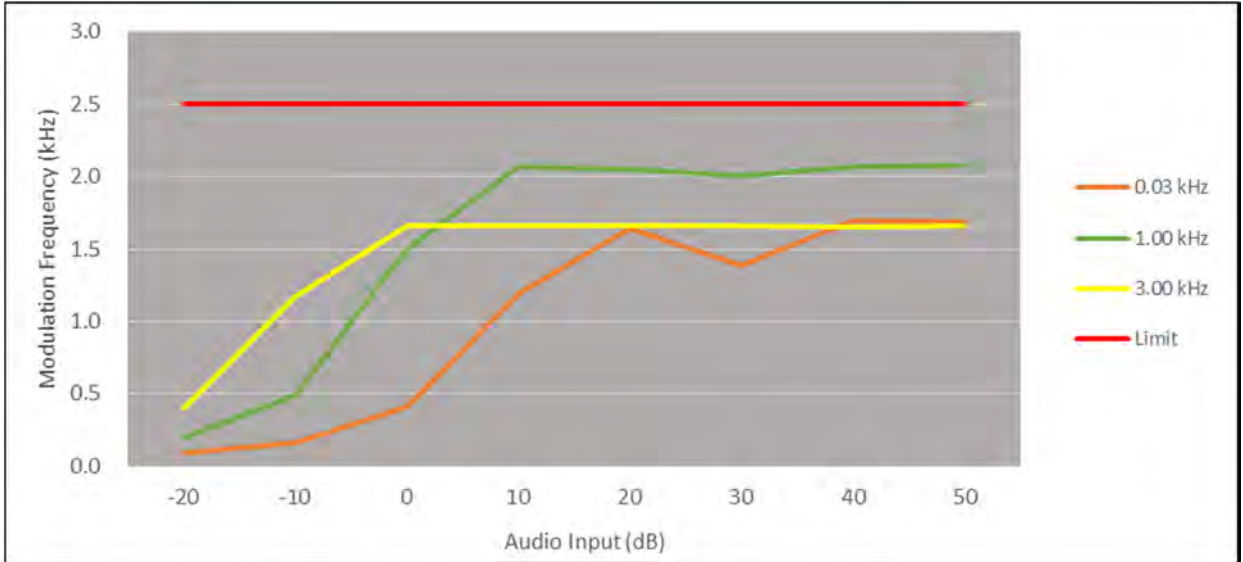

▣ TEST RESULTS(16K0F3E)

Positive Peaks

HIGH POWER

406.15 MHz

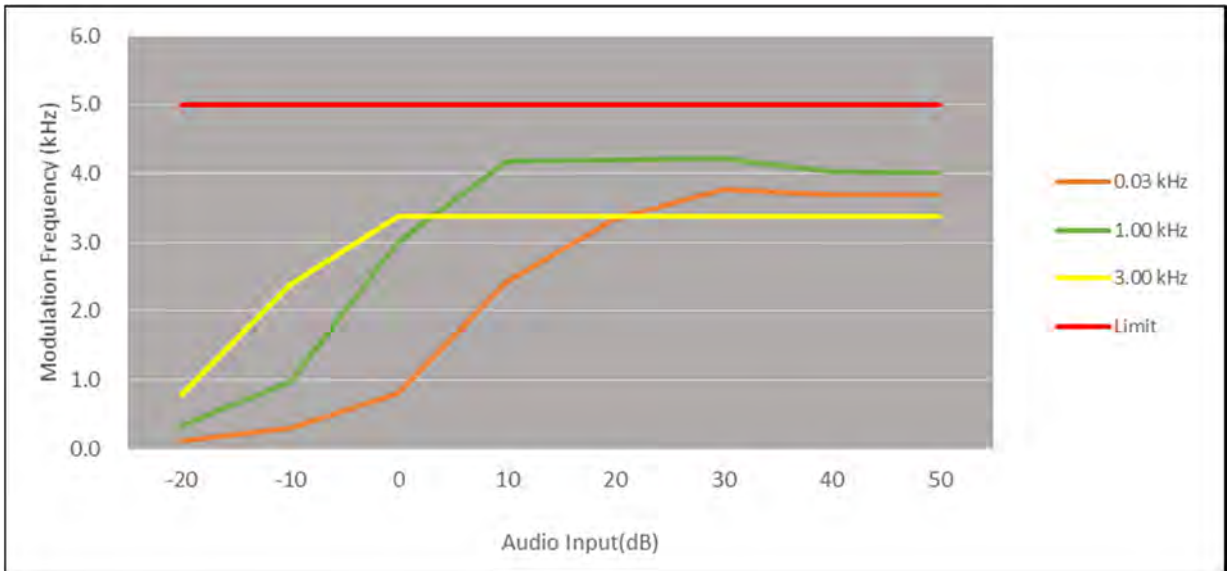

429.95 MHz

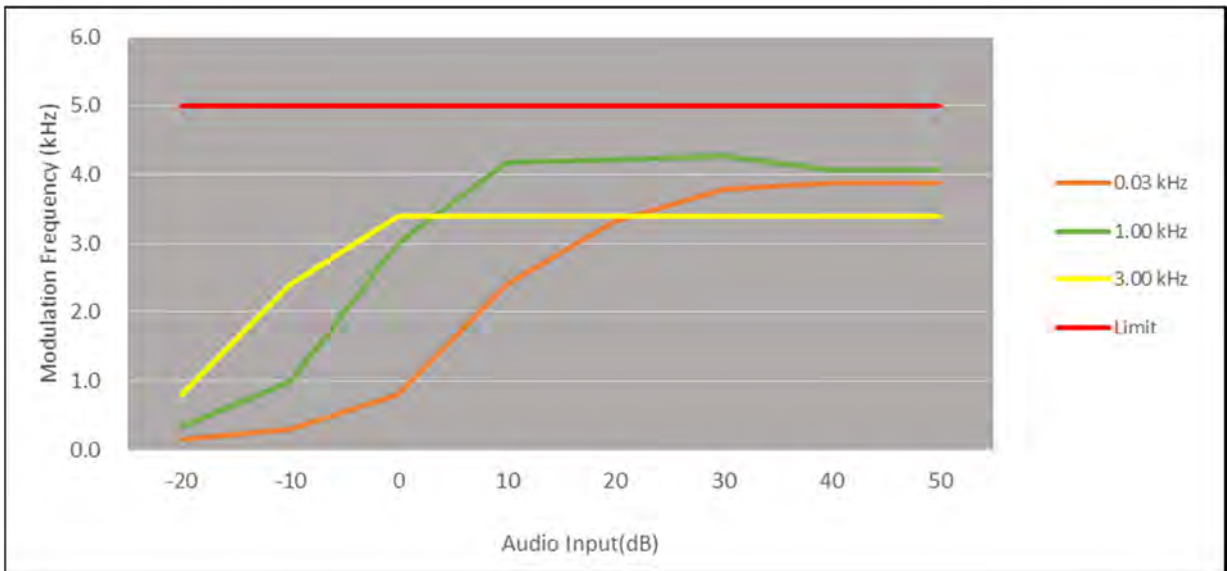

469.95 MHz

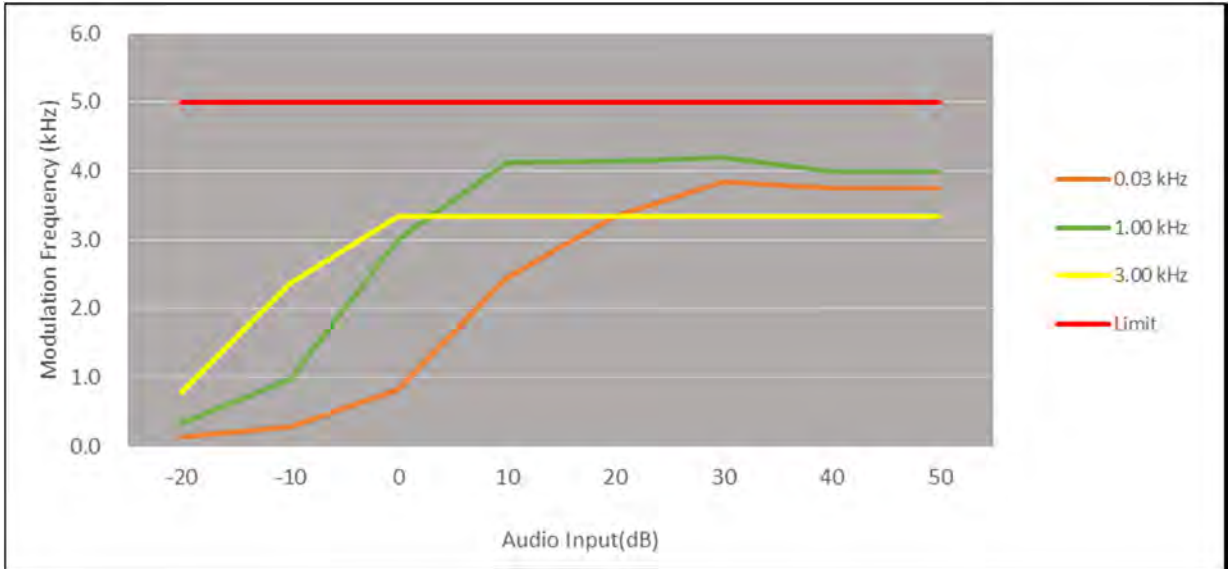

LOW POWER

406.15 MHz

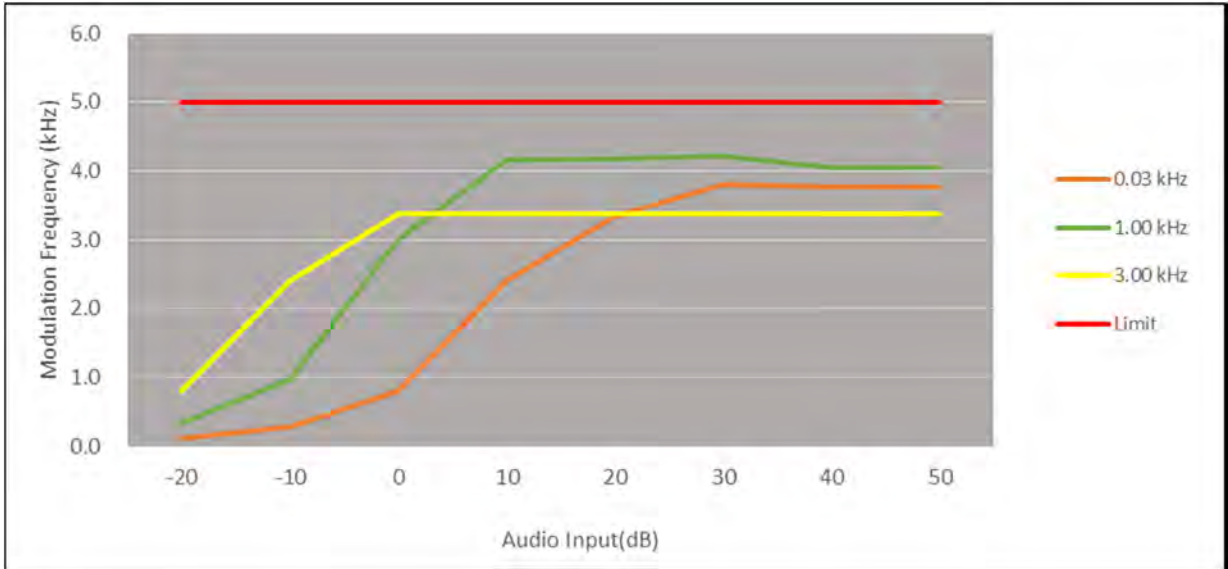

429.95 MHz

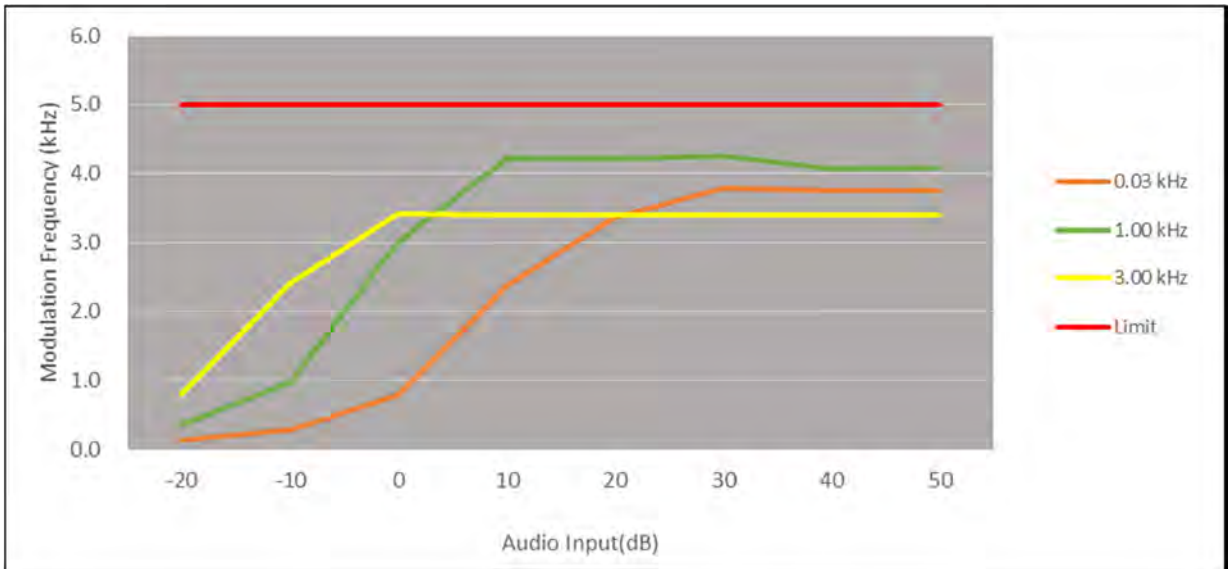

### 469.95 MHz

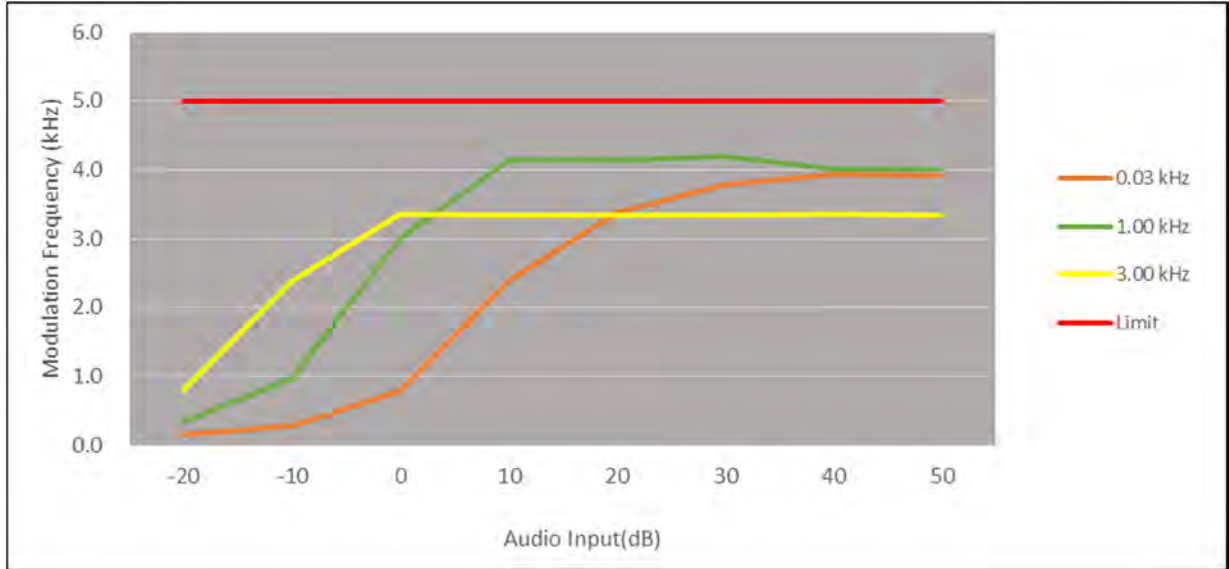

### Negative Peaks

### HIGH POWER

406.15 MHz

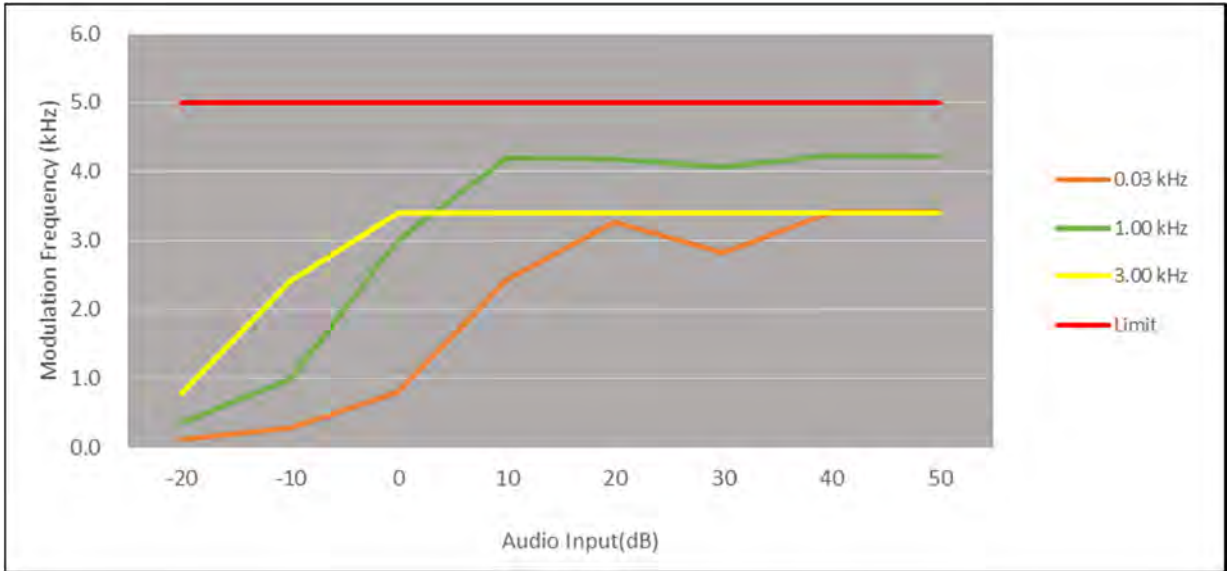

429.95 MHz

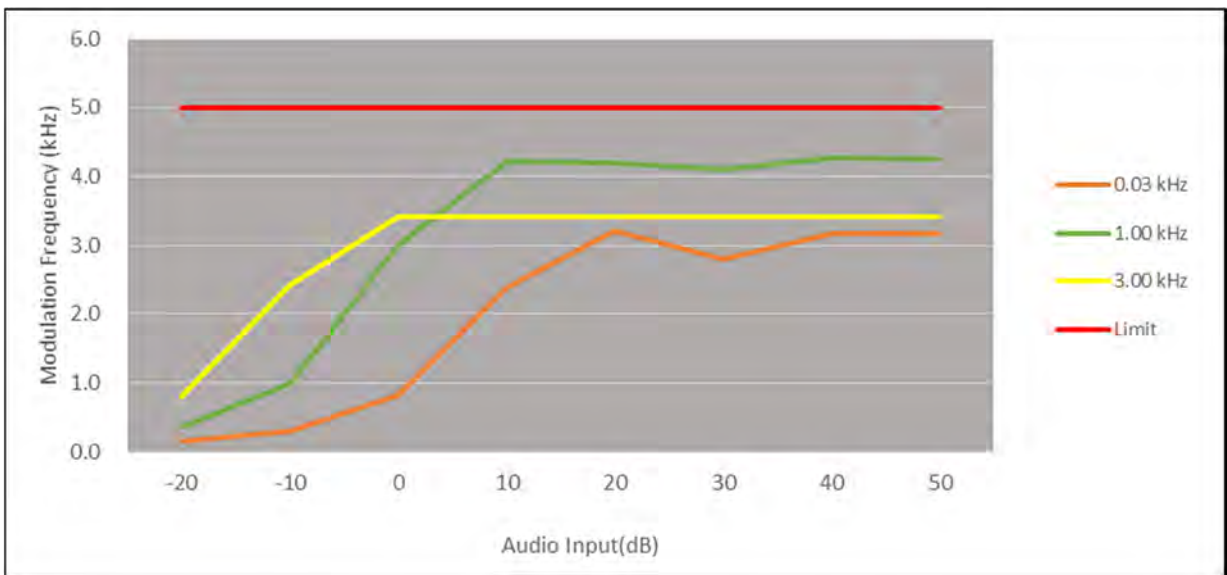

469.95 MHz

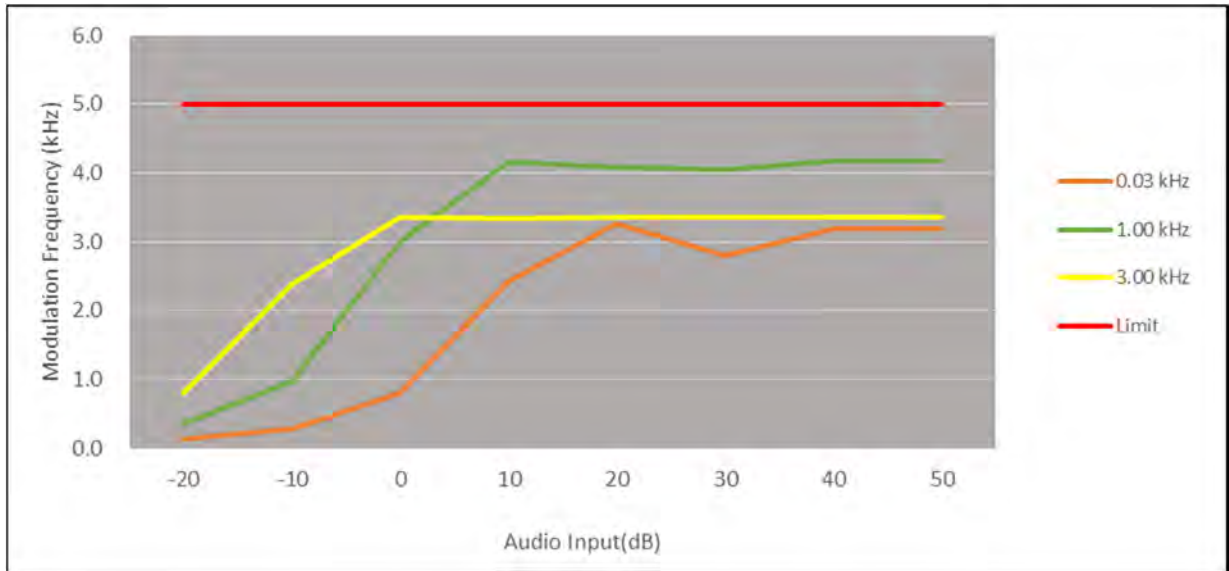

## LOW POWER

406.15 MHz

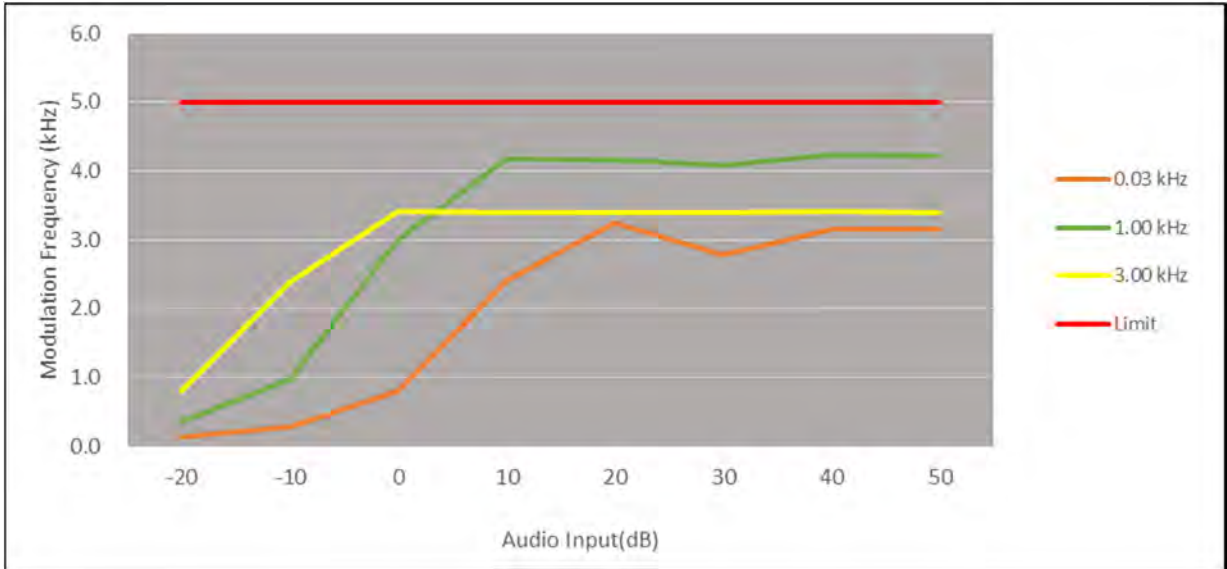

429.95 MHz

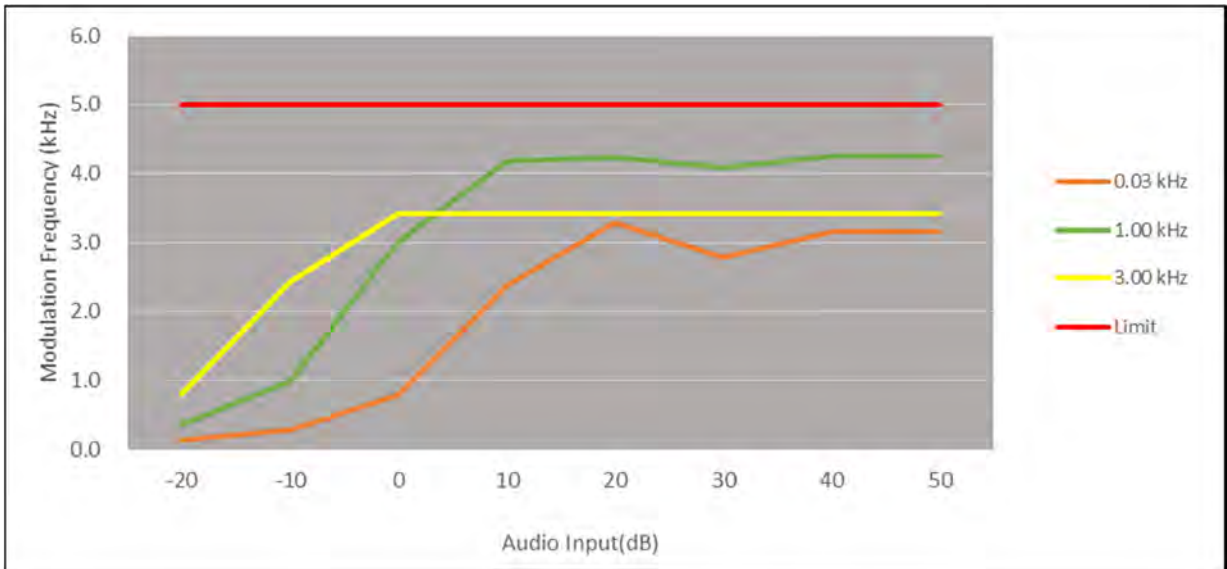



### 469.95 MHz

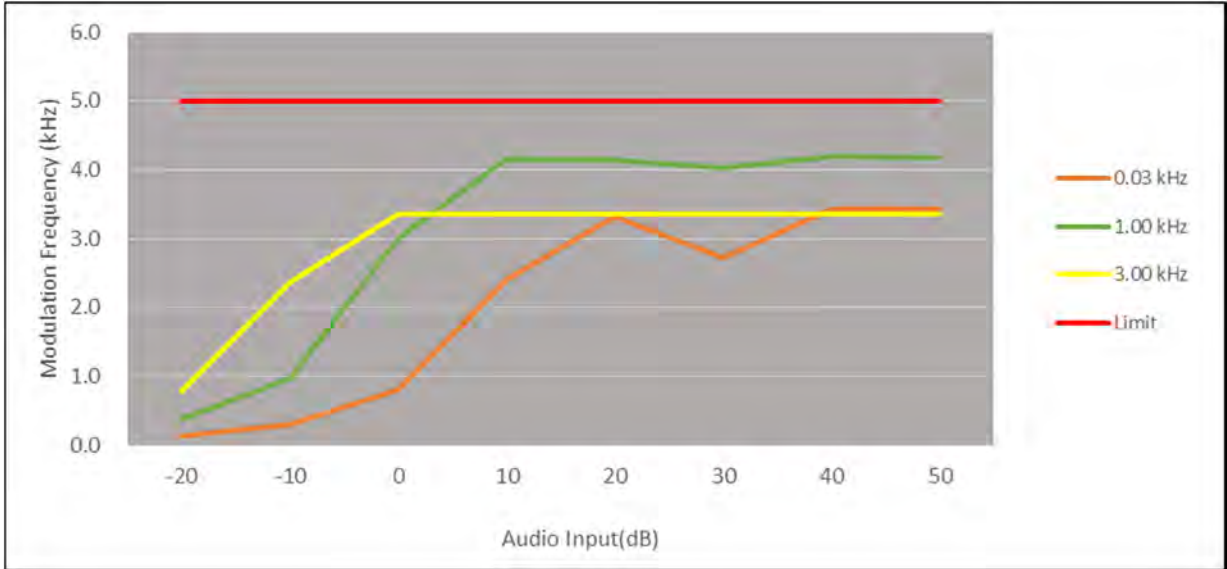

## 8.5 Audio Frequency Response / Audio Low Pass Filter Response

### ▣ Definition

The audio frequency response is the degree of closeness to which the frequency deviation of the transmitter follows a prescribed characteristic.

### ▣ TEST CONFIGURATION

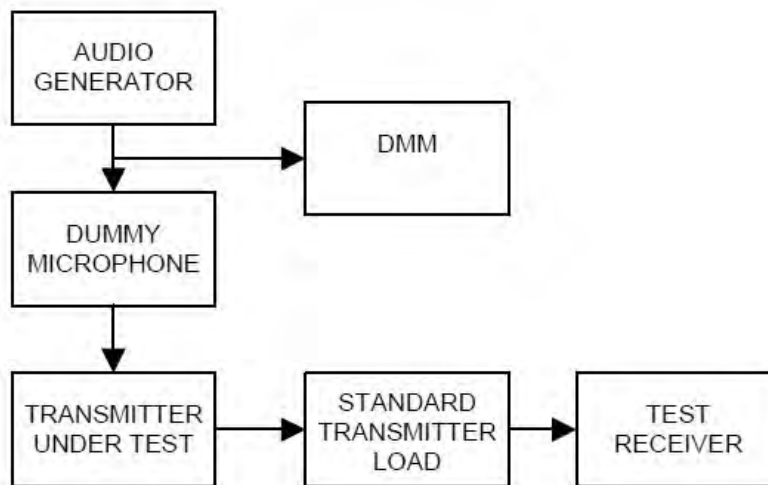

### ▣ TEST PROCEDURE

According to 2.2.6 in TIA-603-E Standard.

- a) Connect the equipment as illustrated.
- b) Set the test receiver to measure peak positive deviation. Set the audio bandwidth for  $\leq 50$  Hz to  $\geq 15,000$  Hz. Turn the de-emphasis function off.
- c) Set the DMM to measure rms voltage.
- d) Adjust the transmitter per the manufacturer's procedure for full rated system deviation.
- e) Apply a 1000 Hz tone and adjust the audio frequency generator to produce 20% of the rated system deviation.
- f) Set the test receiver to measure rms deviation and record the deviation reading.
- g) Record the DMM reading as  $V_{REF}$ .
- h) Set the audio frequency generator to the desired test frequency between 300 Hz and 3000 Hz.
- i) Vary the audio frequency generator output level until the deviation reading that was recorded in step f) is obtained.
- j) Record the DMM reading as  $V_{FREQ}$ .
- k) Calculate the audio frequency response at the present frequency as:  
 audio frequency response =  $20 * \log_{10}(V_{FREQ}/V_{REF})$
- l) Repeat steps h) through k) for all the desired test frequencies.

Note

Audio Filter of the above result is substituted with the same structure as Audio Frequency Response.

On the transmission condition below 3kHz, Transceiver shows pre-emphasis condition of transmission function.

On the transmission condition above 3kHz, Transceiver shows Audio Low Pass Filter.

▣ TEST RESULTS (11K0F3E)

HIGH POWER

406.15 MHz

Frequency (Hz)	Attenuation Rel. to 1kHz (dB)	Upper limit (dB)	Lower limit (dB)
100	-26.72	-18.93	-42.86
125	-26.77	-17.00	-39.00
300	-11.50	-9.42	-23.84
500	-6.02	-5.00	-9.00
750	-2.34	-1.49	-5.49
1000	0.00	1.00	-3.00
1250	1.73	2.93	-1.07
1500	3.11	4.51	0.51
2000	5.15	7.00	3.00
2500	7.04	8.93	4.93
3000	7.99	10.51	4.93
4000	-23.79	-	-
5000	-27.42	-	-
6000	-27.48	-	-
7000	-27.40	-	-
8000	-27.47	-	-
9000	-27.51	-	-
10000	-27.44	-	-
20000	-27.45	-	-
30000	-27.52	-	-
40000	-27.39	-	-

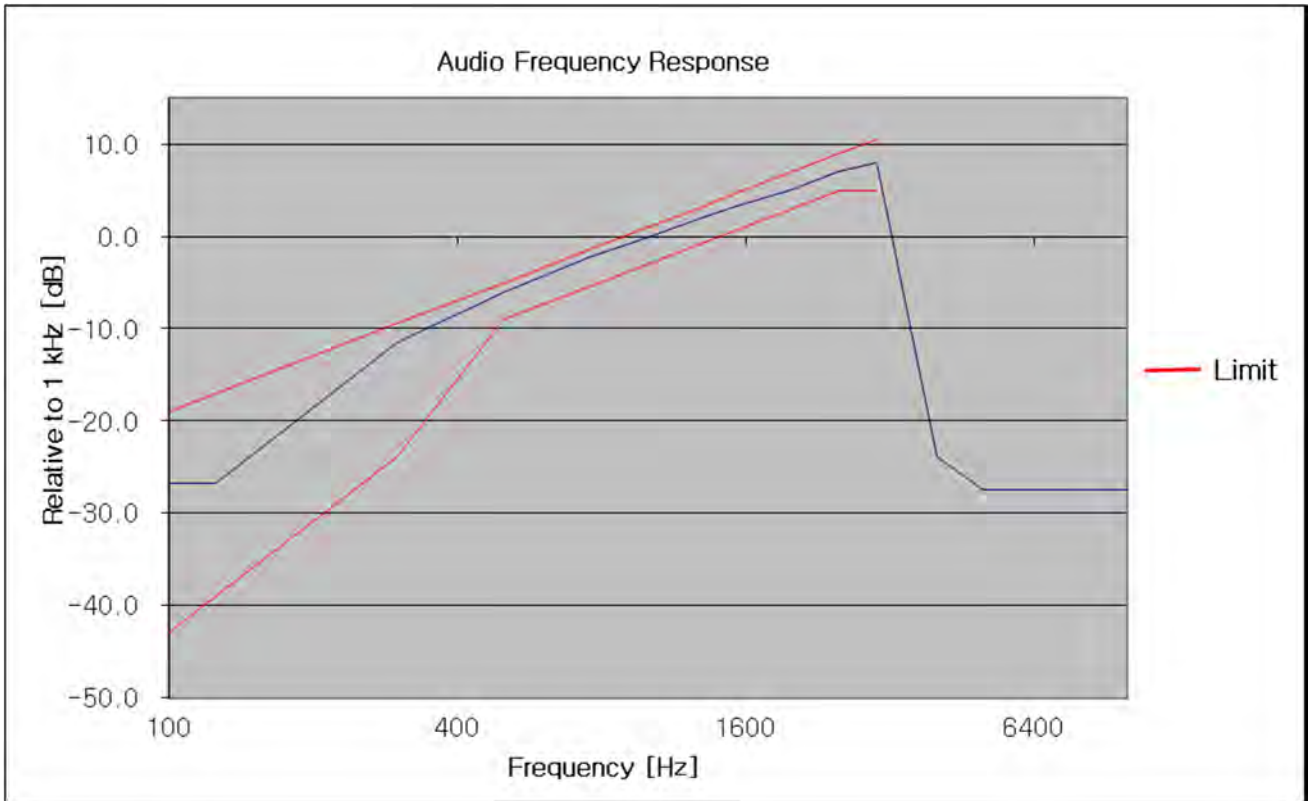

## 429.95 MHz

Frequency (Hz)	Attenuation Rel. to 1kHz (dB)	Upper limit (dB)	Lower limit (dB)
100	-26.04	-18.93	-42.86
125	-26.00	-17.00	-39.00
300	-11.55	-9.42	-23.84
500	-6.16	-5.00	-9.00
750	-2.41	-1.49	-5.49
1000	0.00	1.00	-3.00
1250	1.78	2.93	-1.07
1500	3.11	4.51	0.51
2000	5.06	7.00	3.00
2500	6.92	8.93	4.93
3000	7.90	10.51	4.93
4000	-23.79	-	-
5000	-27.42	-	-
6000	-27.48	-	-
7000	-27.40	-	-
8000	-27.47	-	-
9000	-27.51	-	-
10000	-27.44	-	-
20000	-27.45	-	-
30000	-27.52	-	-
40000	-27.39	-	-

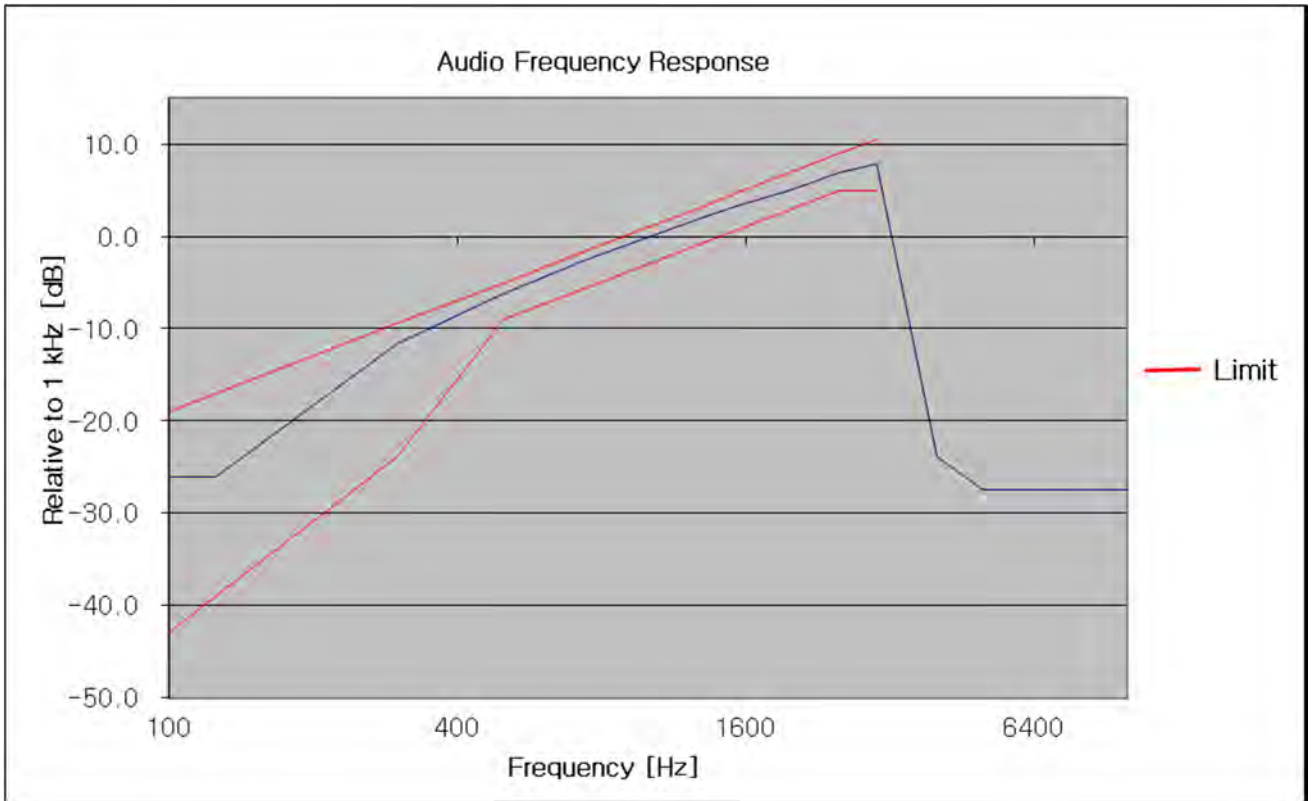

469.95 MHz

Frequency (Hz)	Attenuation Rel. to 1kHz (dB)	Upper limit (dB)	Lower limit (dB)
100	-25.51	-18.93	-42.86
125	-26.12	-17.00	-39.00
300	-11.32	-9.42	-23.84
500	-5.91	-5.00	-9.00
750	-2.31	-1.49	-5.49
1000	0.00	1.00	-3.00
1250	1.72	2.93	-1.07
1500	3.09	4.51	0.51
2000	5.00	7.00	3.00
2500	6.92	8.93	4.93
3000	7.91	10.51	4.93
4000	-23.79	-	-
5000	-27.42	-	-
6000	-27.48	-	-
7000	-27.40	-	-
8000	-27.47	-	-
9000	-27.51	-	-
10000	-27.44	-	-
20000	-27.45	-	-
30000	-27.52	-	-
40000	-27.39	-	-



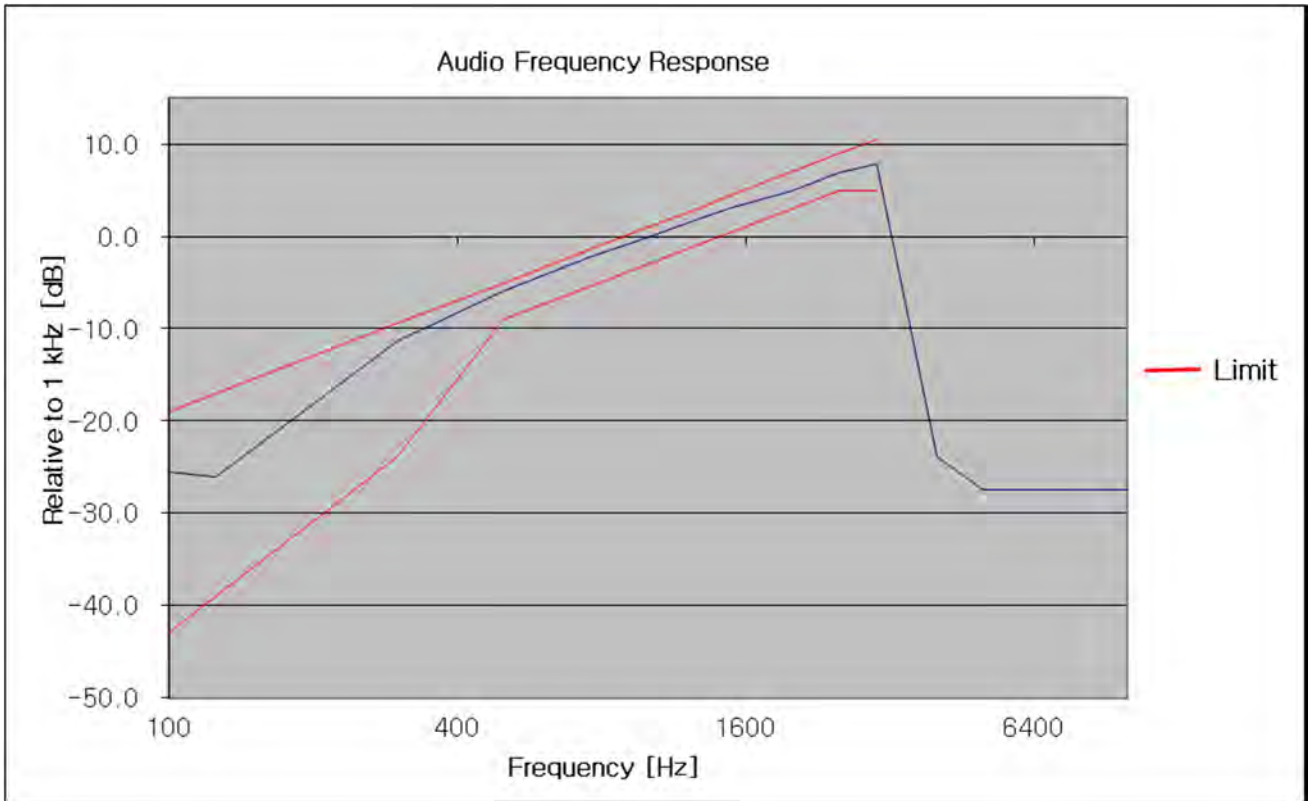

LOW POWER

406.15 MHz

Frequency (Hz)	Attenuation Rel. to 1kHz (dB)	Upper limit (dB)	Lower limit (dB)
100	-26.73	-18.93	-42.86
125	-26.67	-17.00	-39.00
300	-11.47	-9.42	-23.84
500	-6.00	-5.00	-9.00
750	-2.35	-1.49	-5.49
1000	0.00	1.00	-3.00
1250	1.71	2.93	-1.07
1500	3.13	4.51	0.51
2000	5.08	7.00	3.00
2500	6.99	8.93	4.93
3000	7.97	10.51	4.93
4000	-23.79	-	-
5000	-27.42	-	-
6000	-27.48	-	-
7000	-27.40	-	-
8000	-27.47	-	-
9000	-27.51	-	-
10000	-27.44	-	-
20000	-27.45	-	-
30000	-27.52	-	-
40000	-27.39	-	-

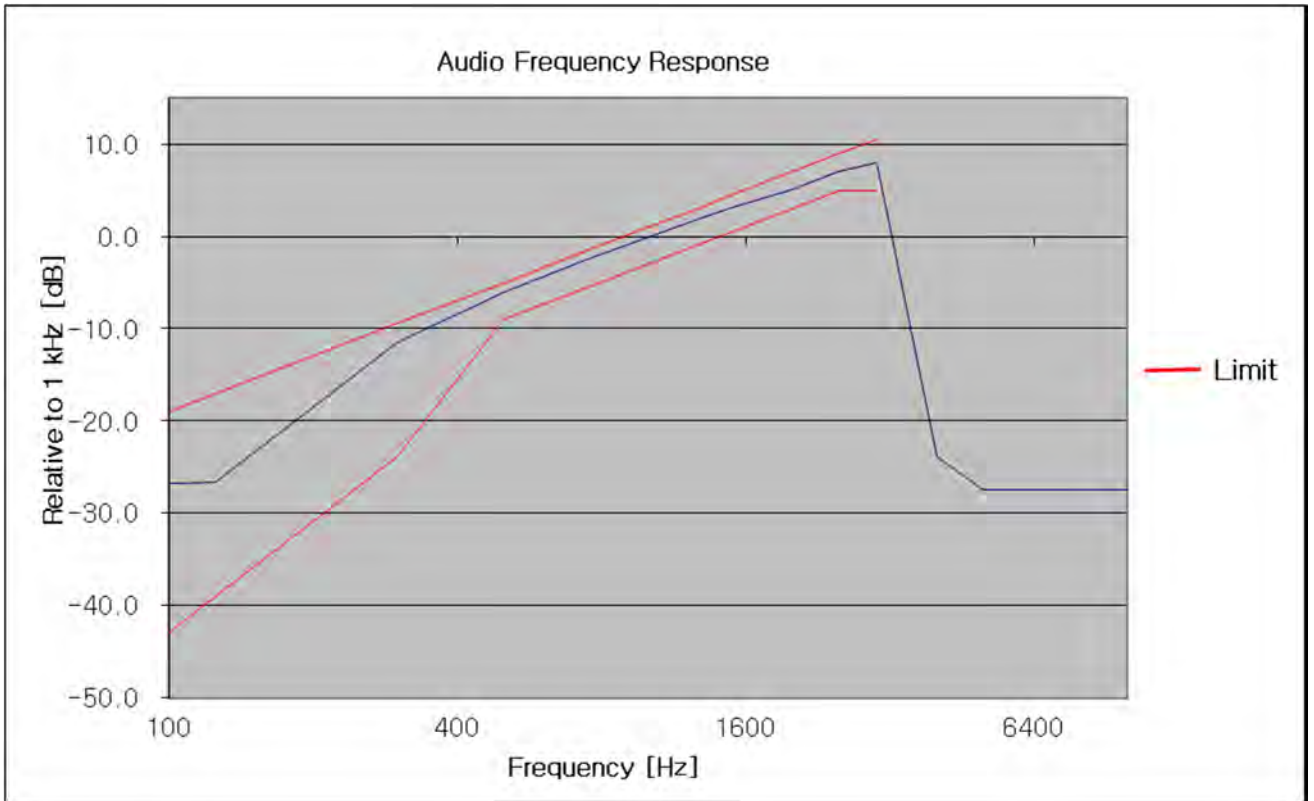

## 429.95 MHz

Frequency (Hz)	Attenuation Rel. to 1kHz (dB)	Upper limit (dB)	Lower limit (dB)
100	-26.56	-18.93	-42.86
125	-26.39	-17.00	-39.00
300	-11.56	-9.42	-23.84
500	-6.06	-5.00	-9.00
750	-2.35	-1.49	-5.49
1000	0.00	1.00	-3.00
1250	1.77	2.93	-1.07
1500	3.17	4.51	0.51
2000	5.11	7.00	3.00
2500	6.97	8.93	4.93
3000	7.96	10.51	4.93
4000	-23.79	-	-
5000	-27.42	-	-
6000	-27.48	-	-
7000	-27.40	-	-
8000	-27.47	-	-
9000	-27.51	-	-
10000	-27.44	-	-
20000	-27.45	-	-
30000	-27.52	-	-
40000	-27.39	-	-

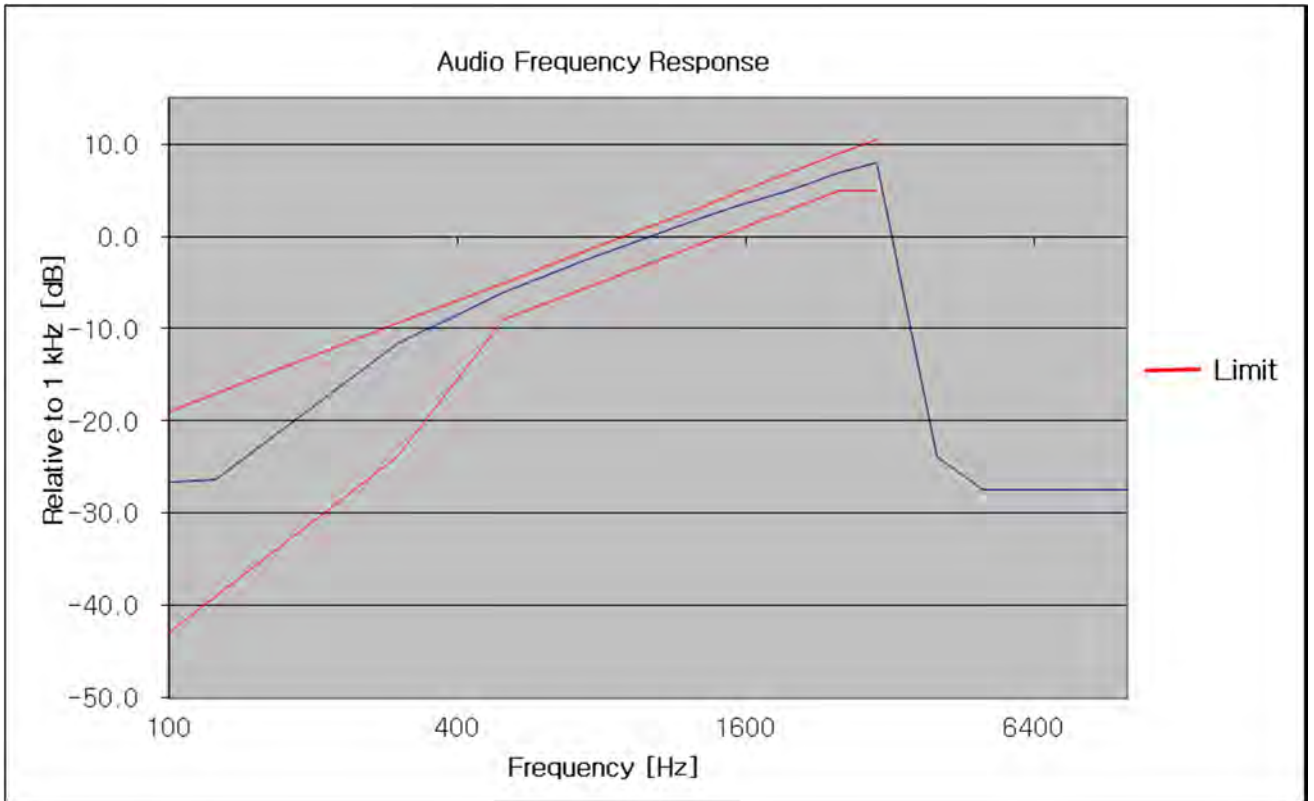

469.95 MHz

Frequency (Hz)	Attenuation Rel. to 1kHz (dB)	Upper limit (dB)	Lower limit (dB)
100	-26.12	-18.93	-42.86
125	-25.86	-17.00	-39.00
300	-11.39	-9.42	-23.84
500	-5.94	-5.00	-9.00
750	-2.32	-1.49	-5.49
1000	0.00	1.00	-3.00
1250	1.67	2.93	-1.07
1500	3.05	4.51	0.51
2000	5.02	7.00	3.00
2500	6.92	8.93	4.93
3000	7.90	10.51	4.93
4000	-23.79	-	-
5000	-27.42	-	-
6000	-27.48	-	-
7000	-27.40	-	-
8000	-27.47	-	-
9000	-27.51	-	-
10000	-27.44	-	-
20000	-27.45	-	-
30000	-27.52	-	-
40000	-27.39	-	-

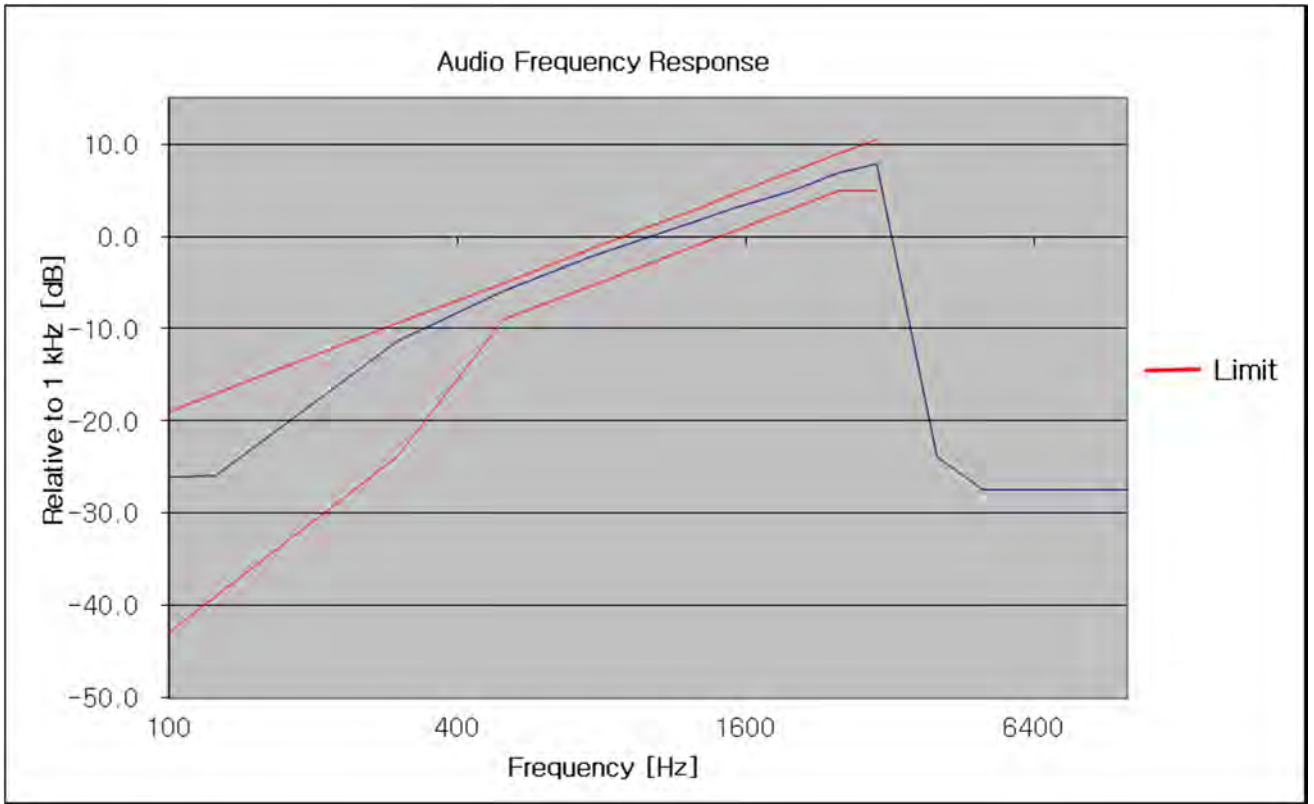

▣ TEST RESULTS (16K0F3E)

HIGH POWER

406.15 MHz

Frequency (Hz)	Attenuation Rel. to 1kHz (dB)	Upper limit (dB)	Lower limit (dB)
100	-30.14	-18.93	-42.86
125	-29.99	-17.00	-39.00
300	-11.55	-9.42	-23.84
500	-6.11	-5.00	-9.00
750	-2.41	-1.49	-5.49
1000	0.00	1.00	-3.00
1250	1.81	2.93	-1.07
1500	3.22	4.51	0.51
2000	5.18	7.00	3.00
2500	7.04	8.93	4.93
3000	8.09	10.51	4.93
4000	-15.77	-	-
5000	-23.11	-	-
6000	-23.13	-	-
7000	-23.14	-	-
8000	-23.12	-	-
9000	-23.10	-	-
10000	-23.17	-	-
20000	-23.14	-	-
30000	-23.24	-	-
40000	-23.18	-	-



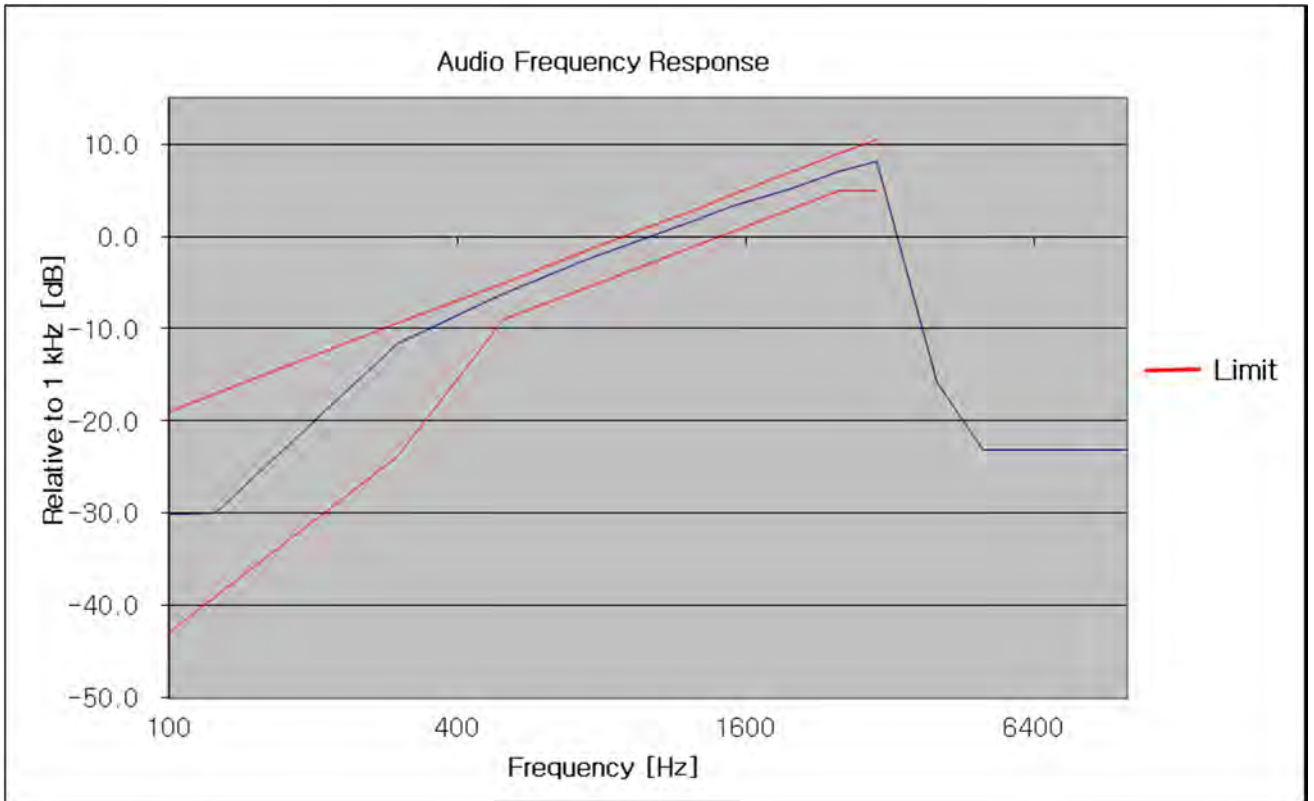

429.95 MHz

Frequency (Hz)	Attenuation Rel. to 1kHz (dB)	Upper limit (dB)	Lower limit (dB)
100	-29.32	-18.93	-42.86
125	-29.71	-17.00	-39.00
300	-11.61	-9.42	-23.84
500	-6.16	-5.00	-9.00
750	-2.46	-1.49	-5.49
1000	0.00	1.00	-3.00
1250	1.72	2.93	-1.07
1500	3.13	4.51	0.51
2000	5.11	7.00	3.00
2500	6.98	8.93	4.93
3000	7.96	10.51	4.93
4000	-20.68	-	-
5000	-22.94	-	-
6000	-22.74	-	-
7000	-22.78	-	-
8000	-22.83	-	-
9000	-22.79	-	-
10000	-22.79	-	-
20000	-22.76	-	-
30000	-22.76	-	-
40000	-22.76	-	-

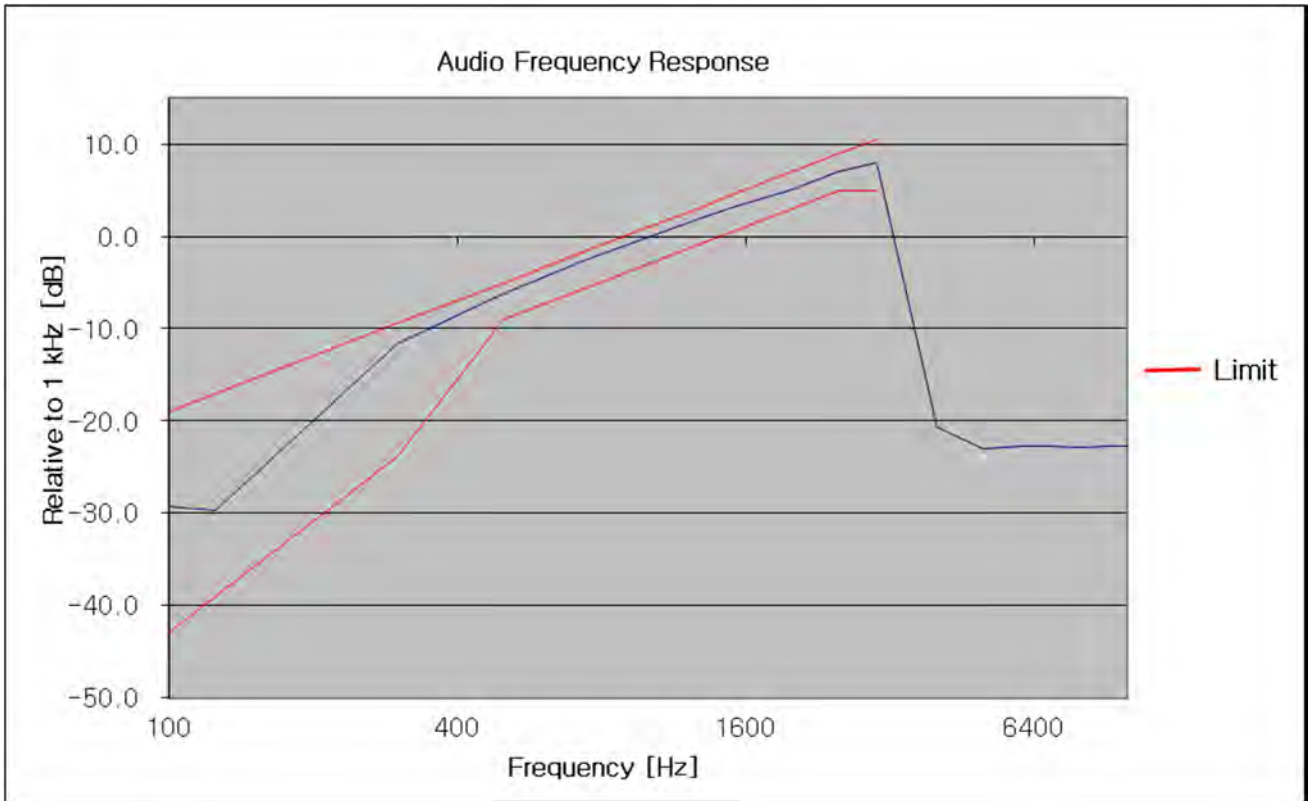

469.95 MHz

Frequency (Hz)	Attenuation Rel. to 1kHz (dB)	Upper limit (dB)	Lower limit (dB)
100	-28.97	-18.93	-42.86
125	-29.19	-17.00	-39.00
300	-11.45	-9.42	-23.84
500	-5.92	-5.00	-9.00
750	-2.34	-1.49	-5.49
1000	0.00	1.00	-3.00
1250	1.69	2.93	-1.07
1500	3.08	4.51	0.51
2000	5.06	7.00	3.00
2500	7.00	8.93	4.93
3000	8.00	10.51	4.93
4000	-15.51	-	-
5000	-21.69	-	-
6000	-21.62	-	-
7000	-21.57	-	-
8000	-21.53	-	-
9000	-21.63	-	-
10000	-21.69	-	-
20000	-21.68	-	-
30000	-21.53	-	-
40000	-21.63	-	-

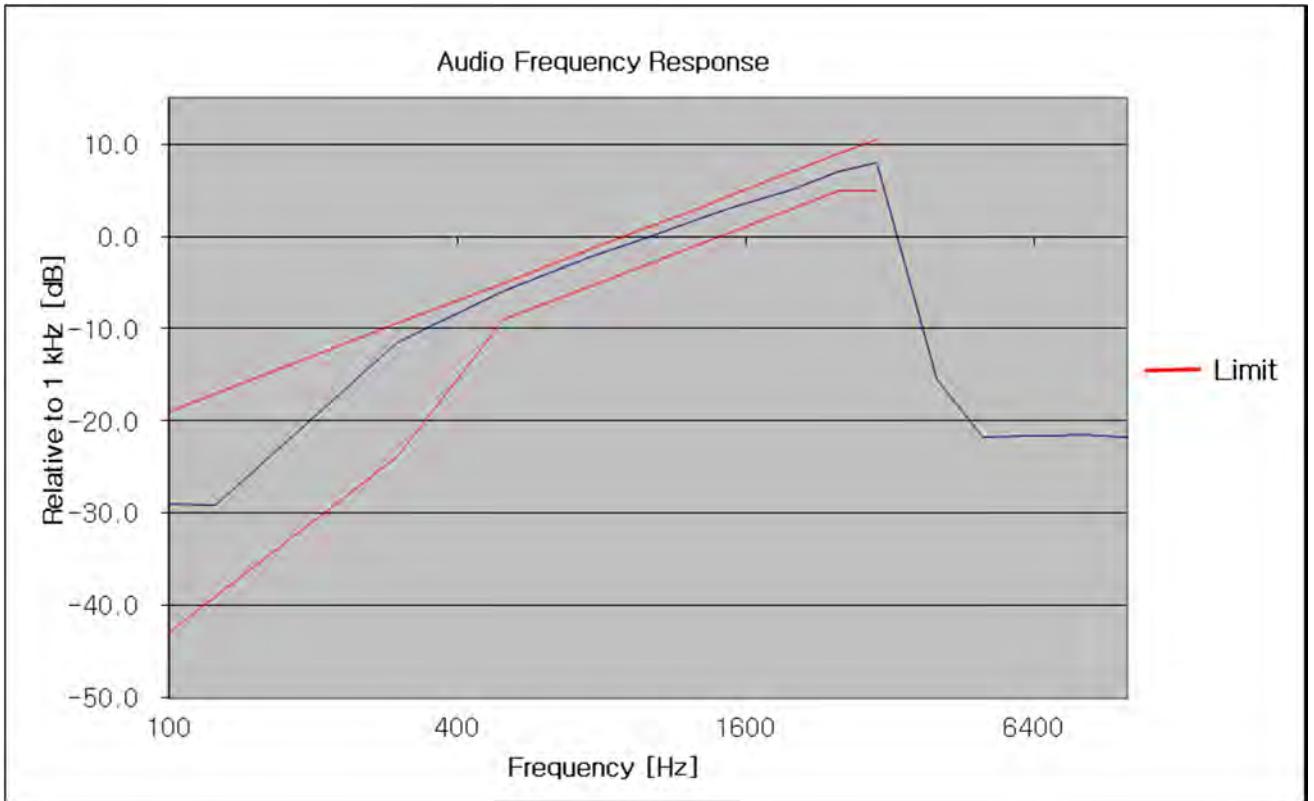

## LOW POWER

406.15 MHz

Frequency (Hz)	Attenuation Rel. to 1kHz (dB)	Upper limit (dB)	Lower limit (dB)
100	-30.11	-18.93	-42.86
125	-29.98	-17.00	-39.00
300	-11.47	-9.42	-23.84
500	-6.07	-5.00	-9.00
750	-2.39	-1.49	-5.49
1000	0.00	1.00	-3.00
1250	1.71	2.93	-1.07
1500	3.14	4.51	0.51
2000	5.12	7.00	3.00
2500	7.00	8.93	4.93
3000	8.01	10.51	4.93
4000	-15.69	-	-
5000	-23.09	-	-
6000	-23.11	-	-
7000	-23.03	-	-
8000	-23.03	-	-
9000	-23.09	-	-
10000	-23.16	-	-
20000	-23.11	-	-
30000	-23.22	-	-
40000	-23.15	-	-

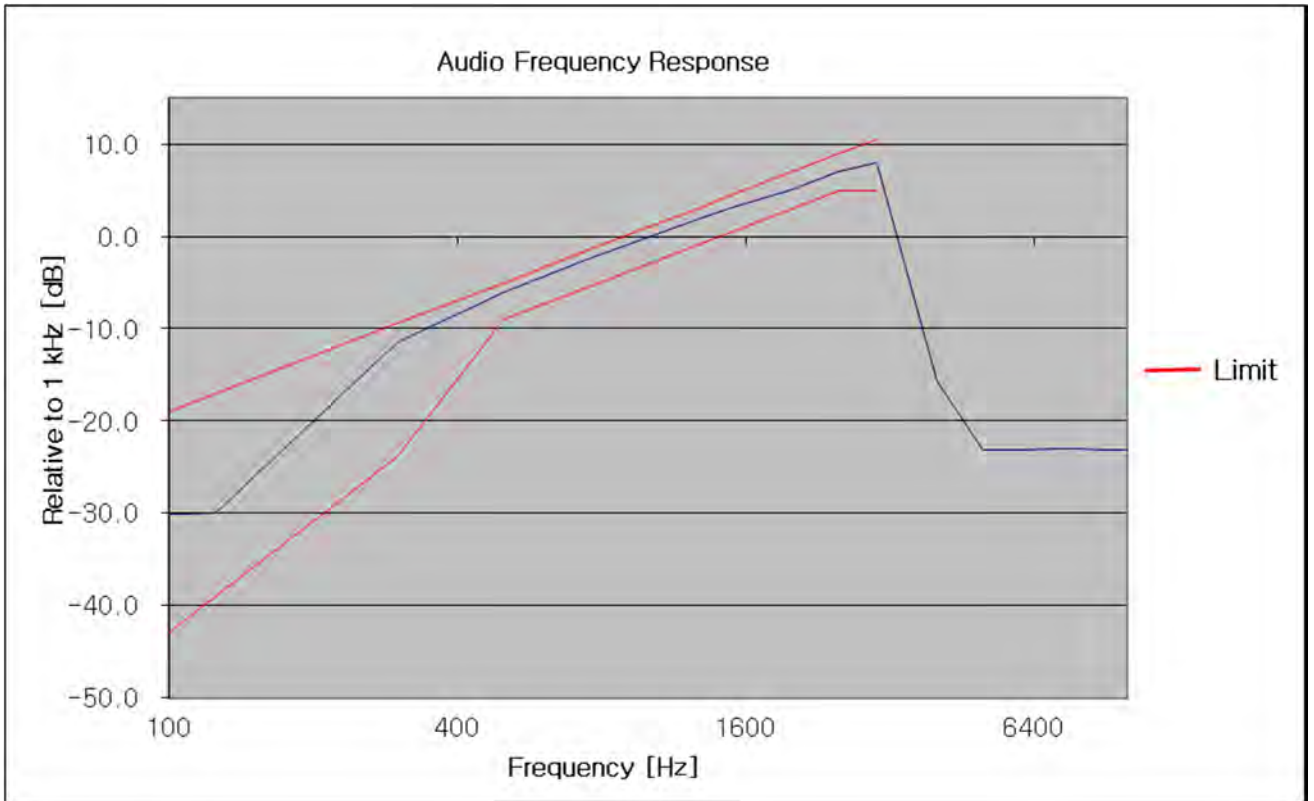

## 429.95 MHz

Frequency (Hz)	Attenuation Rel. to 1kHz (dB)	Upper limit (dB)	Lower limit (dB)
100	-30.14	-18.93	-42.86
125	-29.76	-17.00	-39.00
300	-11.67	-9.42	-23.84
500	-6.18	-5.00	-9.00
750	-2.43	-1.49	-5.49
1000	0.00	1.00	-3.00
1250	1.75	2.93	-1.07
1500	3.16	4.51	0.51
2000	5.13	7.00	3.00
2500	7.02	8.93	4.93
3000	7.99	10.51	4.93
4000	-17.05	-	-
5000	-22.76	-	-
6000	-22.90	-	-
7000	-22.85	-	-
8000	-22.82	-	-
9000	-22.74	-	-
10000	-22.78	-	-
20000	-22.85	-	-
30000	-22.64	-	-
40000	-22.76	-	-



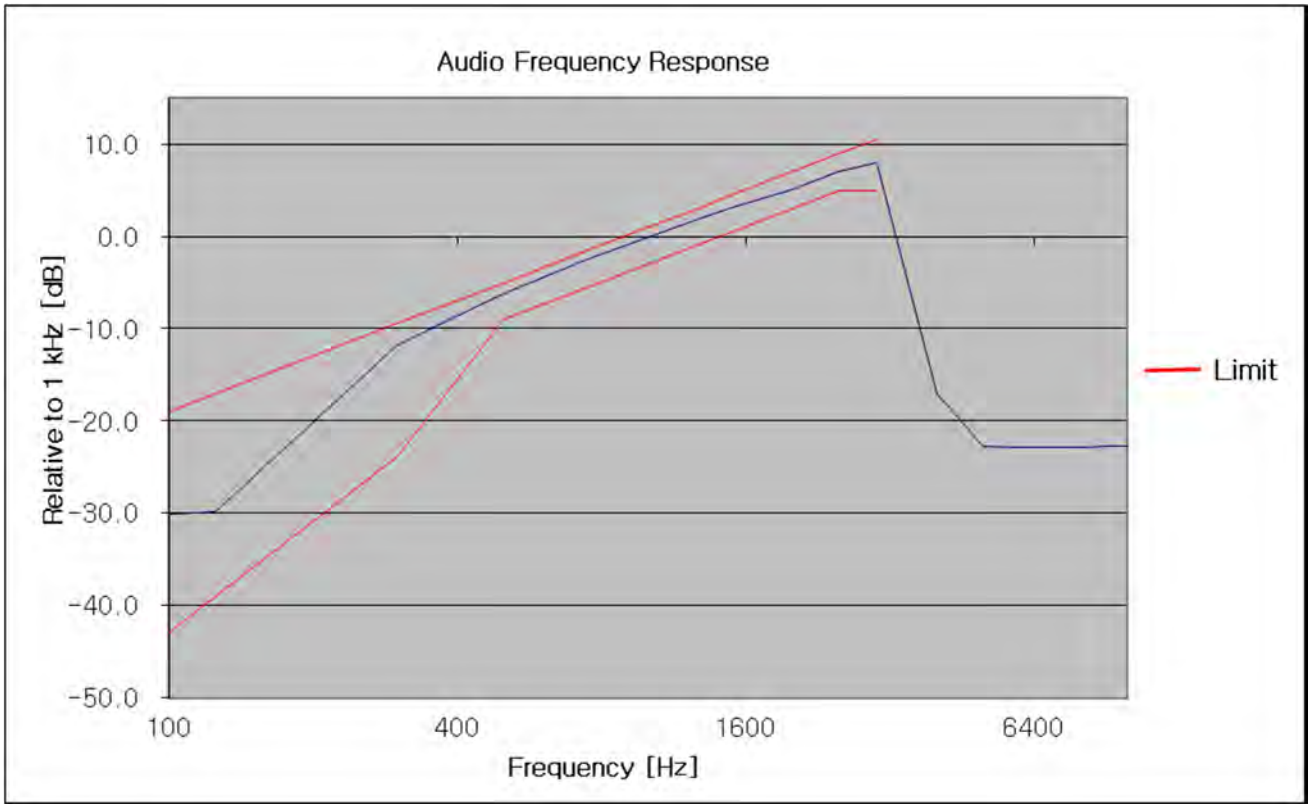

469.95 MHz

Frequency (Hz)	Attenuation Rel. to 1kHz (dB)	Upper limit (dB)	Lower limit (dB)
100	-29.50	-18.93	-42.86
125	-29.42	-17.00	-39.00
300	-11.40	-9.42	-23.84
500	-5.95	-5.00	-9.00
750	-2.33	-1.49	-5.49
1000	0.00	1.00	-3.00
1250	1.76	2.93	-1.07
1500	3.12	4.51	0.51
2000	5.08	7.00	3.00
2500	7.01	8.93	4.93
3000	8.02	10.51	4.93
4000	-15.69	-	-
5000	-21.74	-	-
6000	-21.59	-	-
7000	-21.56	-	-
8000	-21.69	-	-
9000	-21.59	-	-
10000	-21.62	-	-
20000	-21.66	-	-
30000	-21.68	-	-
40000	-21.69	-	-

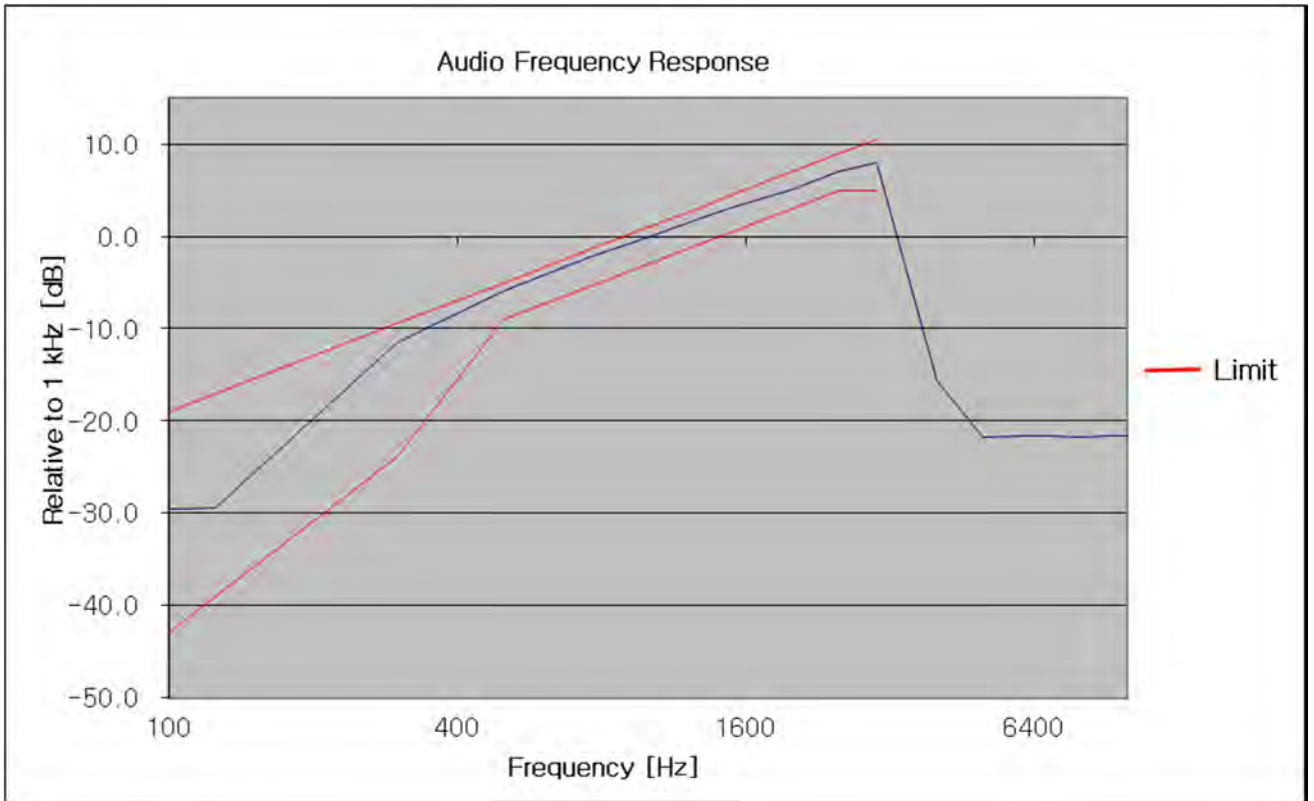

### 8.6 Emission Mask

▣ Definition

The transmitter sideband spectrum denotes the sideband power produced at a discrete frequency separation from the carrier up to the test bandwidth (see 1.3.4.4) due to all sources of unwanted noise within the transmitter in a modulated condition.

▣ TEST CONFIGURATION

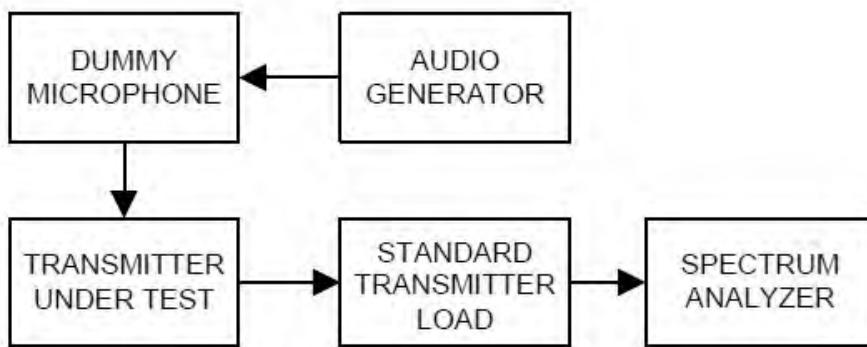

▣ TEST PROCEDURE

According to 2.2.11 in TIA-603-E Standard.

- a) Connect the equipment as illustrated. Use the table to determine the spectrum analyzer resolution bandwidth:

Spectrum Analyzer Resolution Bandwidth

Frequency Band (MHz)	Mask for Equipment with Audio Low Pass Filter	Mask for Equipment without Low Pass Filter	Spectrum Analyzer Resolution Bandwidth (Hz)
25-50	B	C	300
72-76	B	C	300
138-174	NTIA	NTIA	300
150-174	B	C	300
150-174	D or E	D or E	100
406-420	NTIA	NTIA	300
421-512	B	C	300
421-512	D or E	D or E	100
806-821/851-866	B or EA	G or EA	300
821-824/866-869	B	H	300
896-901/935-940	I	J	300

- b) Adjust the spectrum analyzer for the following settings:
  - 1) Resolution Bandwidth per the above table

- 2) Video Bandwidth at least 10 times the resolution bandwidth.
  - 3) Sweep Speed slow enough to maintain measurement calibration.
  - 4) Detector Mode = Positive Peak.
  - 5) Span that will allow proper viewing of the test bandwidth (see 1.3.4.4).
- c) Set the center frequency of the spectrum analyzer to the assigned transmitter frequency. Key the transmitter, and set the level of the unmodulated carrier to a full scale reference line. This is the 0 dB reference for the measurement.
  - d) Modulate the transmitter with a 2500 Hz sine wave at an input level 16 dB greater than that necessary to produce 50% of rated system deviation. The input level shall be established at the frequency of maximum response of the audio modulating circuit. Transmitters employing digital modulation techniques that bypass the limiter and the audio low-pass filter shall be modulated as specified by the manufacturer.
  - e) Record the resulting spectrum analyzer presentation of the emission level with an on-line recording device or in a photograph. It is recommended that the emission limit (as given in 3.2.11) be drawn on the plotted graph or photograph. The spectrum analyzer presentation is the sideband spectrum.

Plots of Emission Mask

16K0F3E\_ISED

(406.15 MHz)\_High

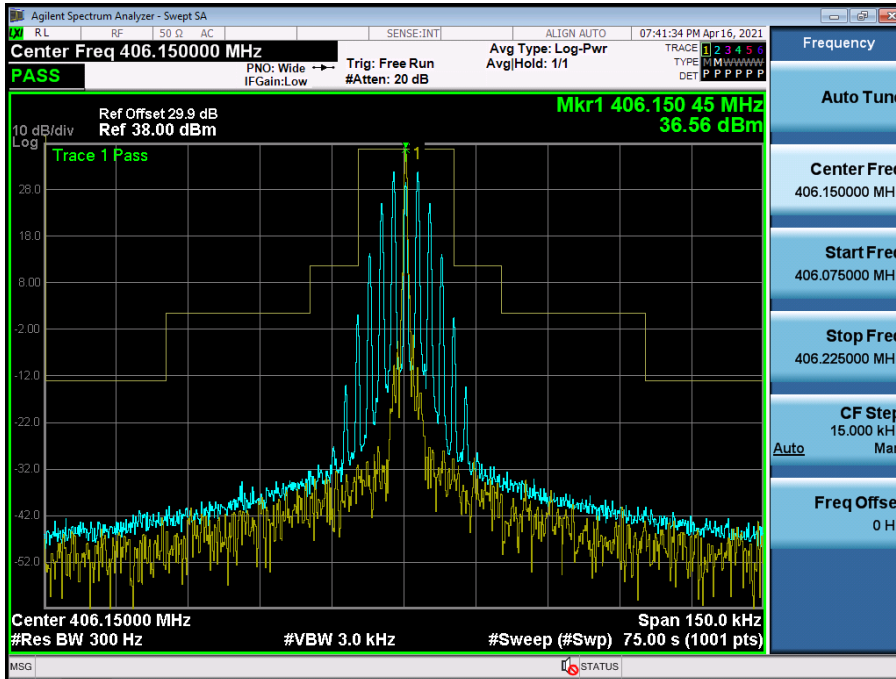

(429.95 MHz)\_High

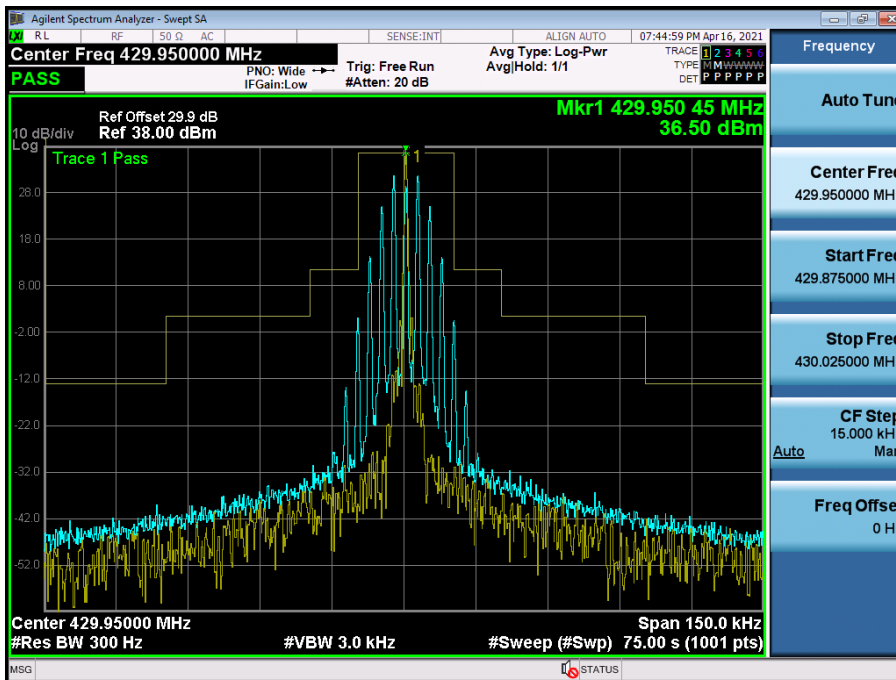

### (469.95 MHz)\_High

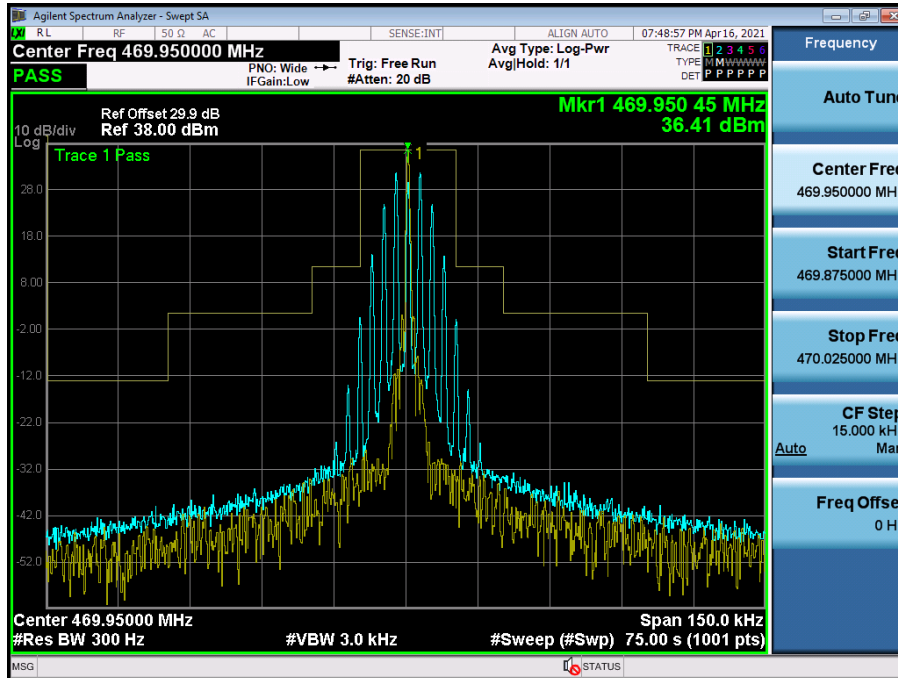

(406.15 MHz)\_Low

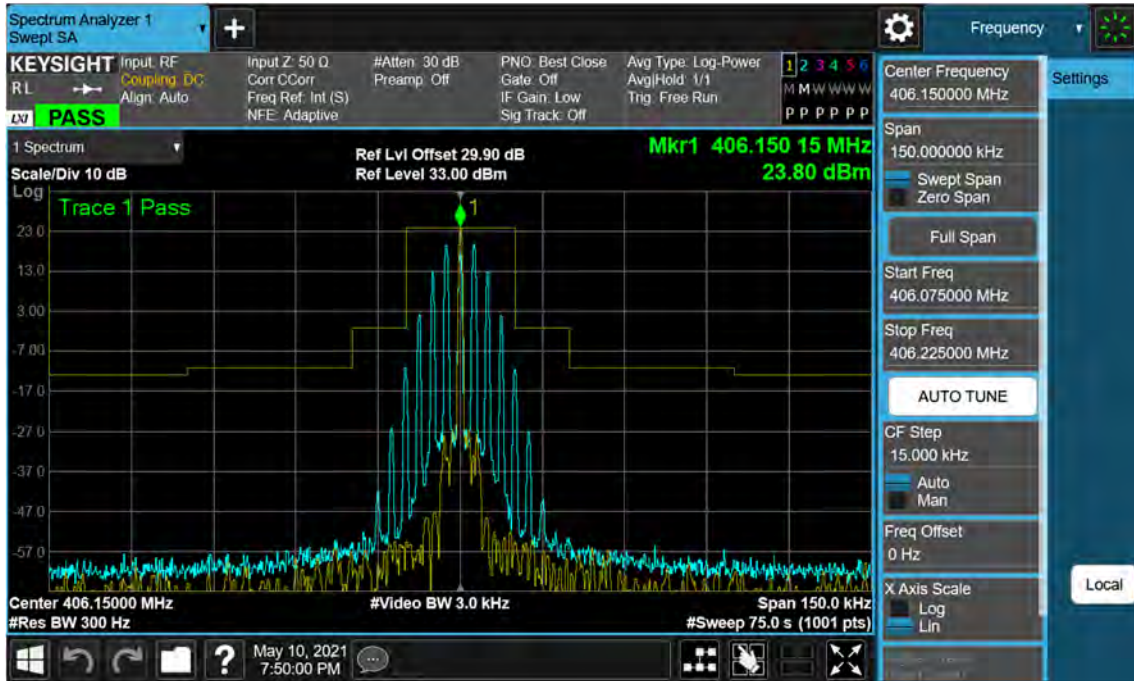

(429.95 MHz)\_Low

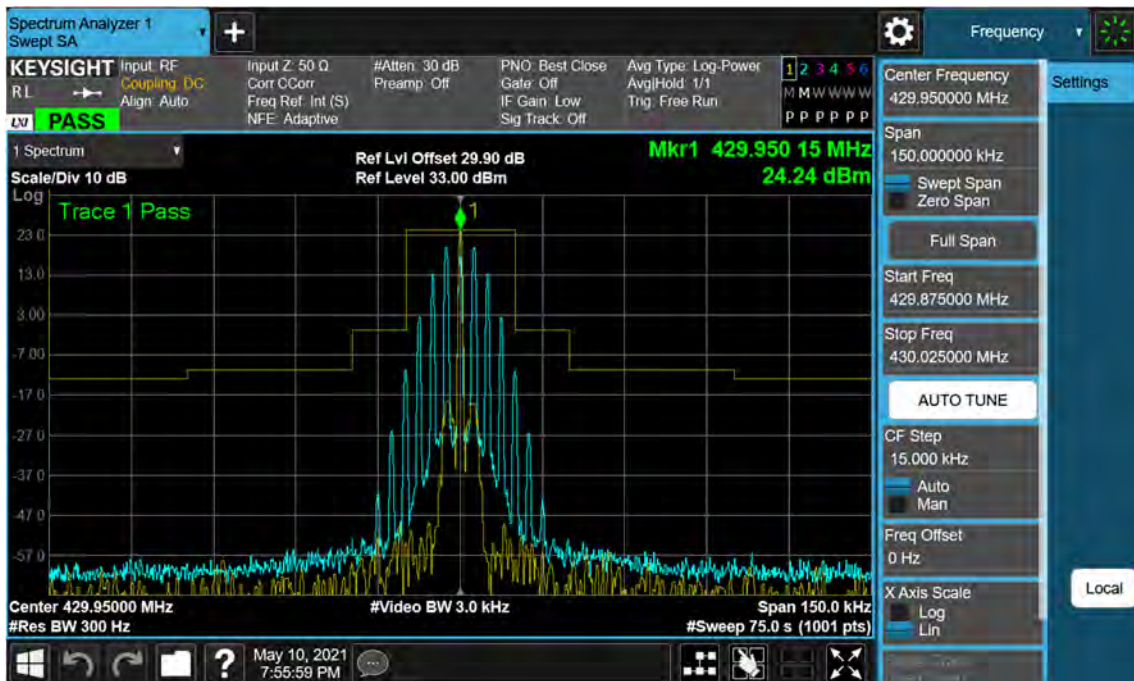



(469.95 MHz)\_ Low

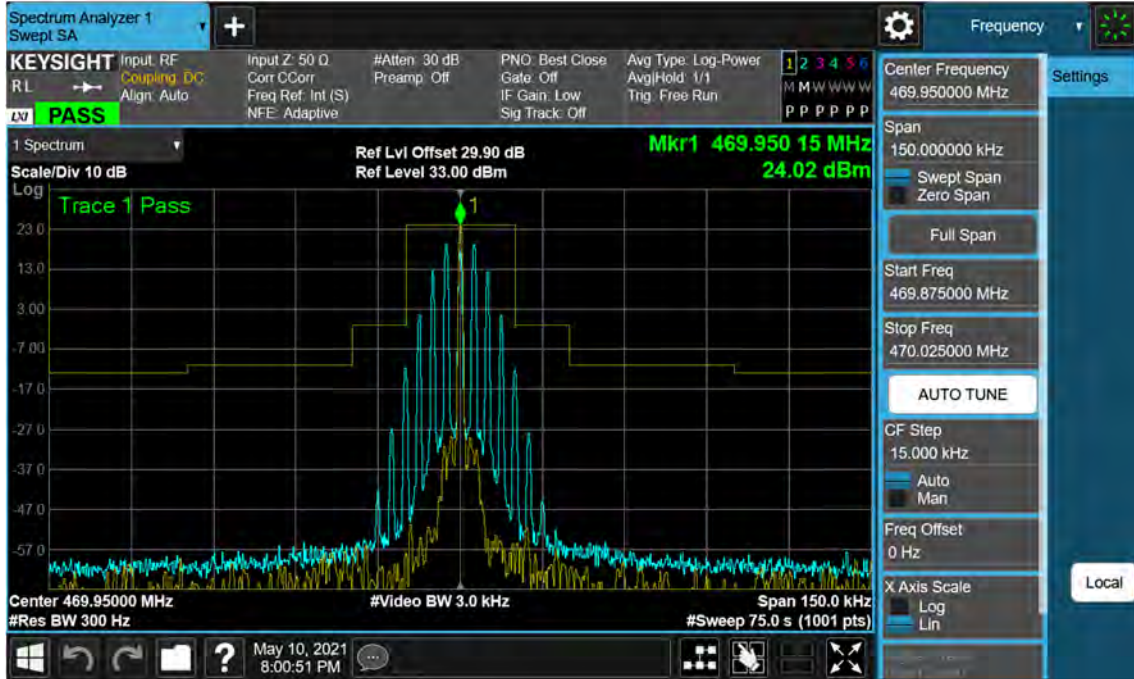

11K0F3E\_FCC/ISED

(406.15 MHz)\_High

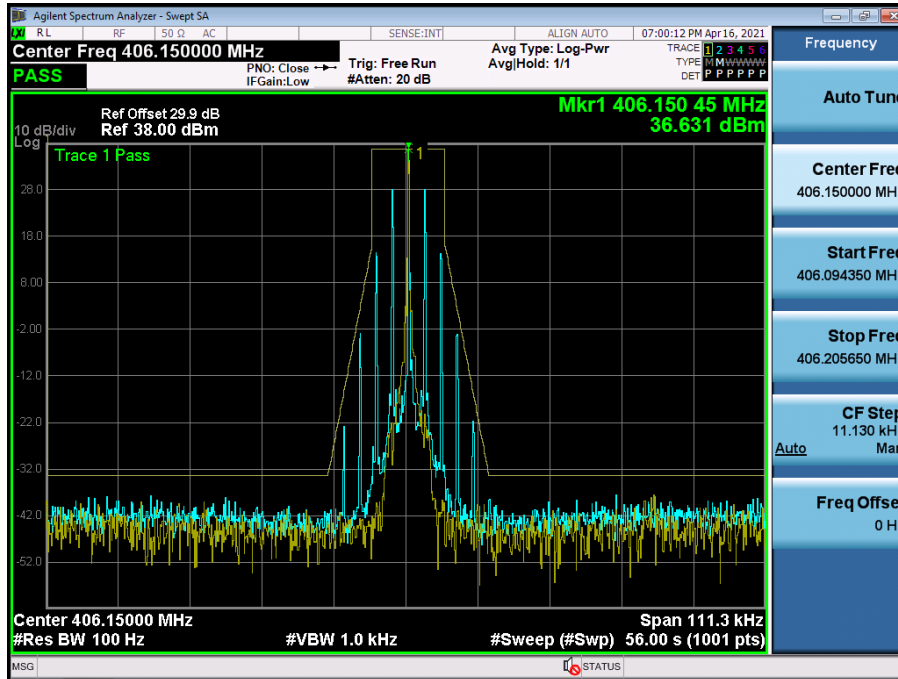

(429.95 MHz)\_High

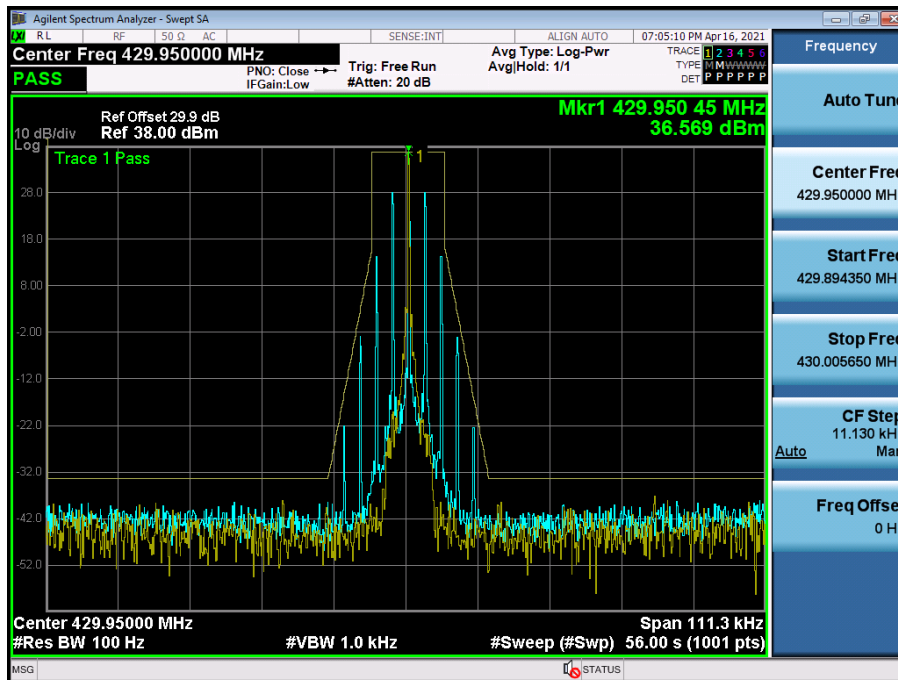

(469.95 MHz)\_High

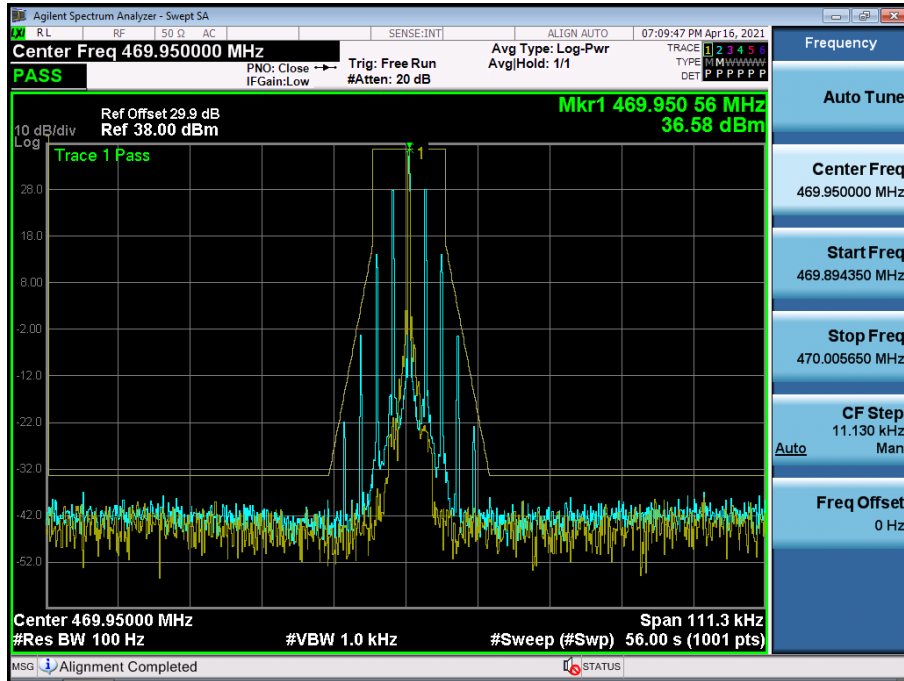

(406.15 MHz)\_Low

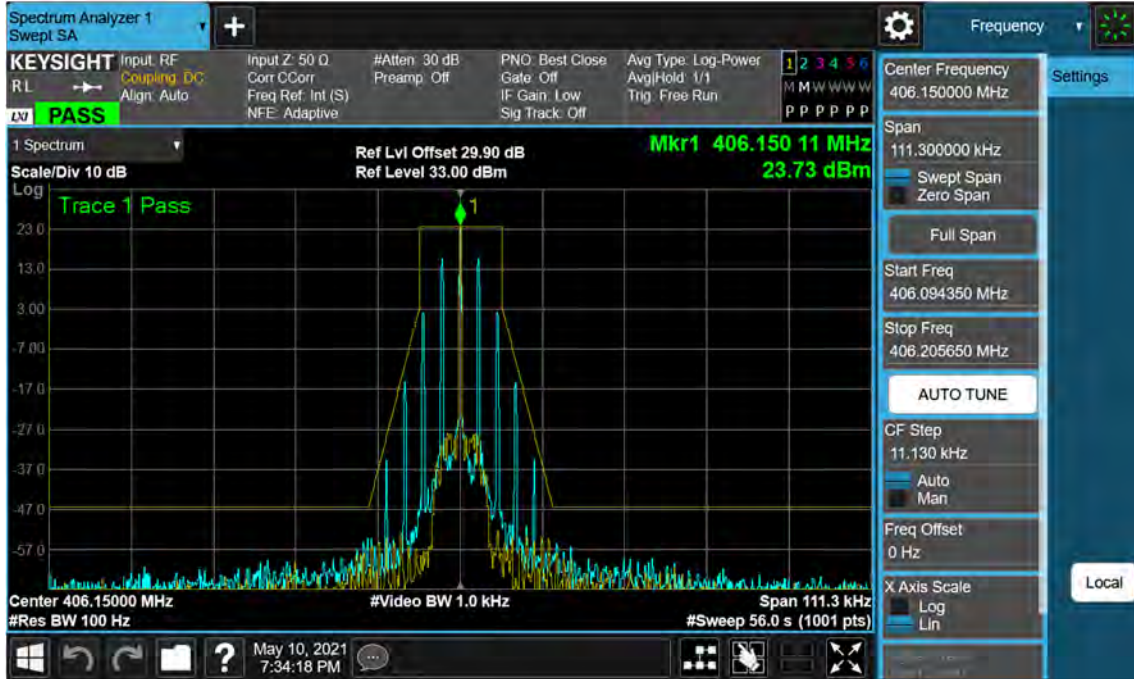

(429.95 MHz)\_Low

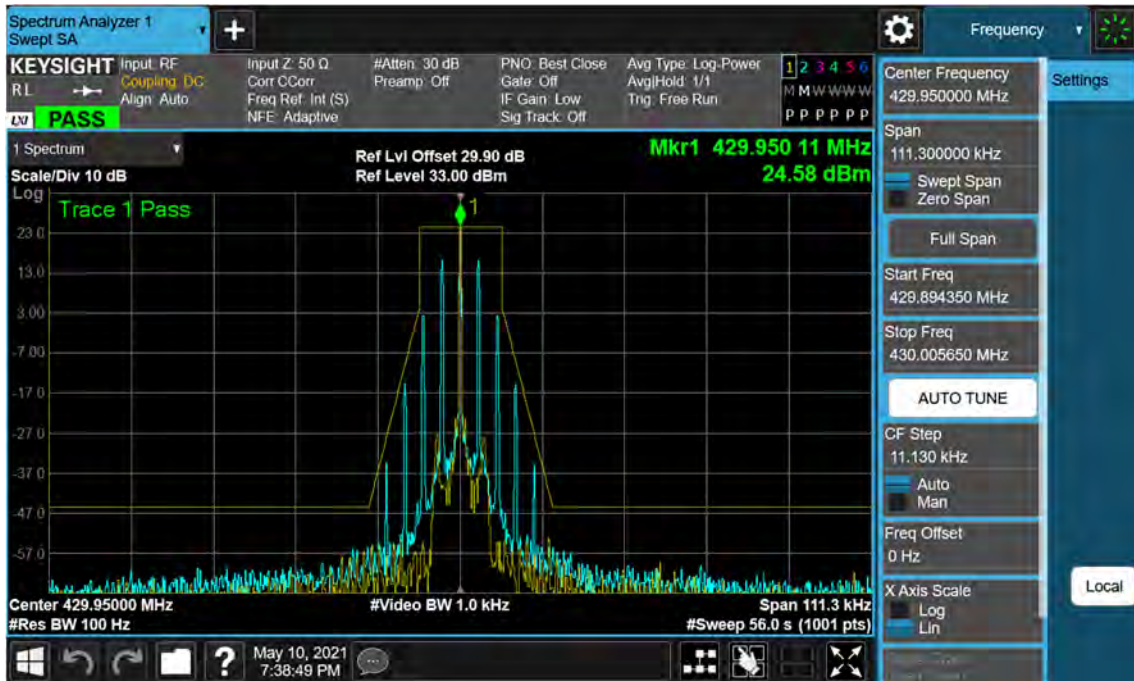

(469.95 MHz)\_ Low

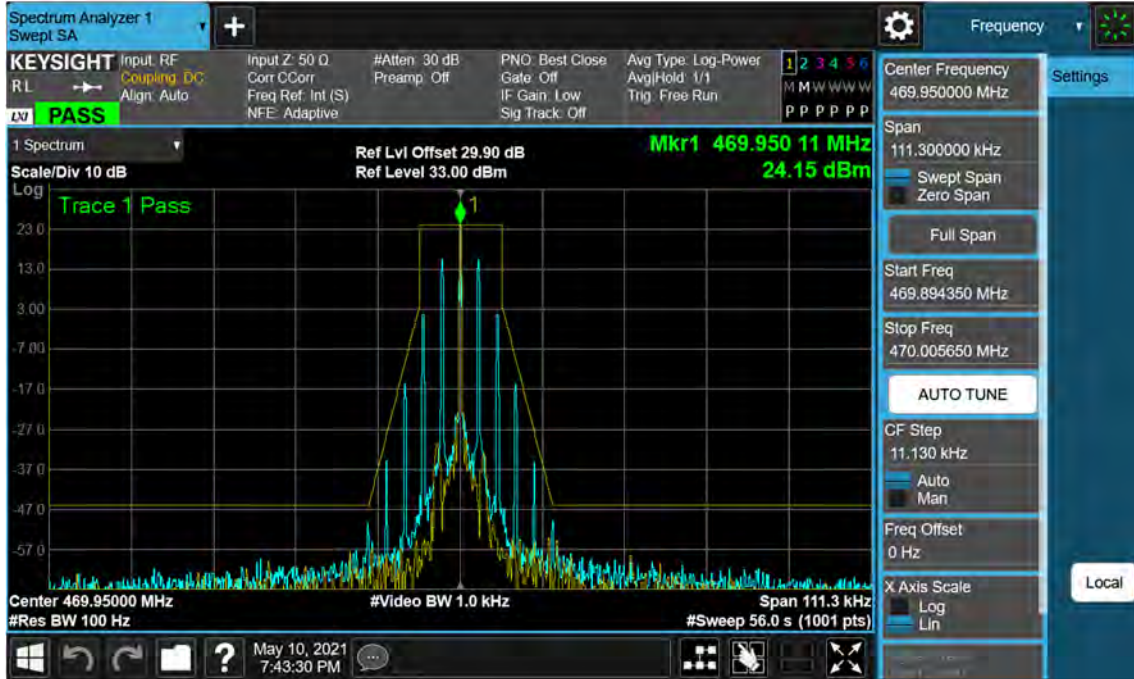

8K30F1E, 8K30F1D, 8K30F7W\_FCC/ISED

(406.15 MHz)\_High

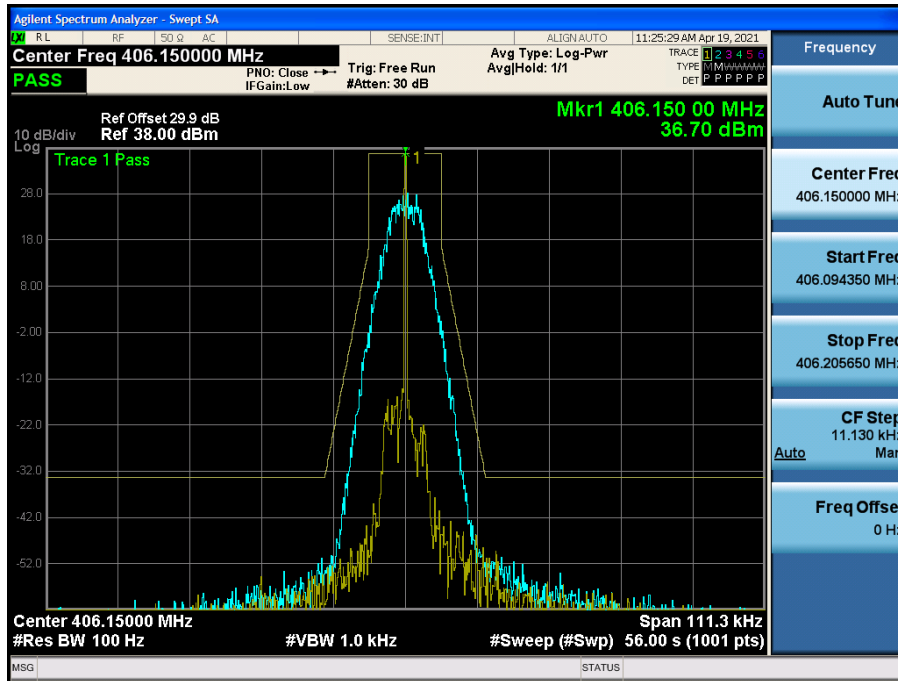

(429.95 MHz)\_High

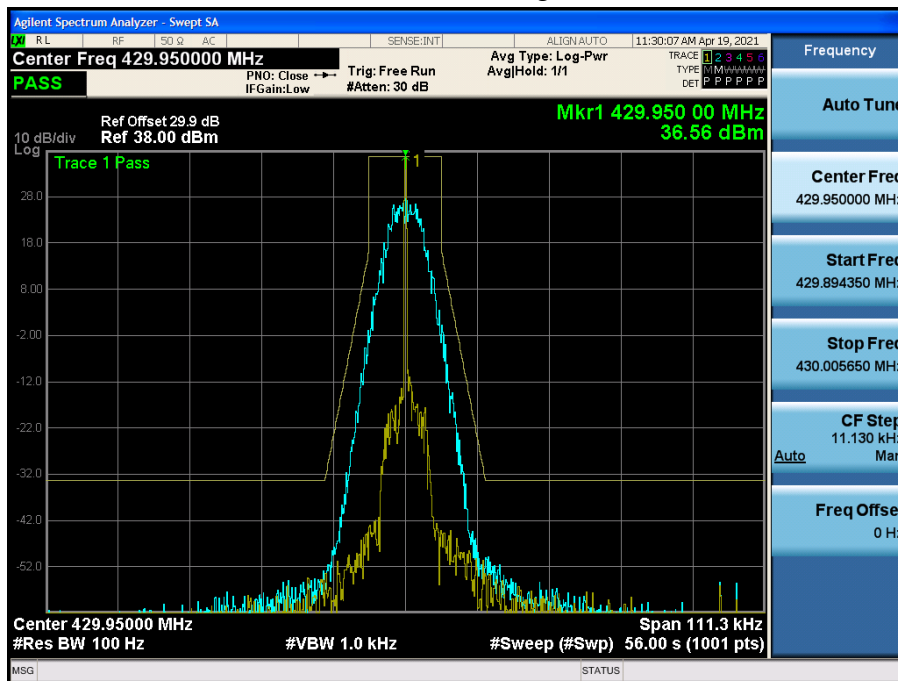

(469.95 MHz)\_High

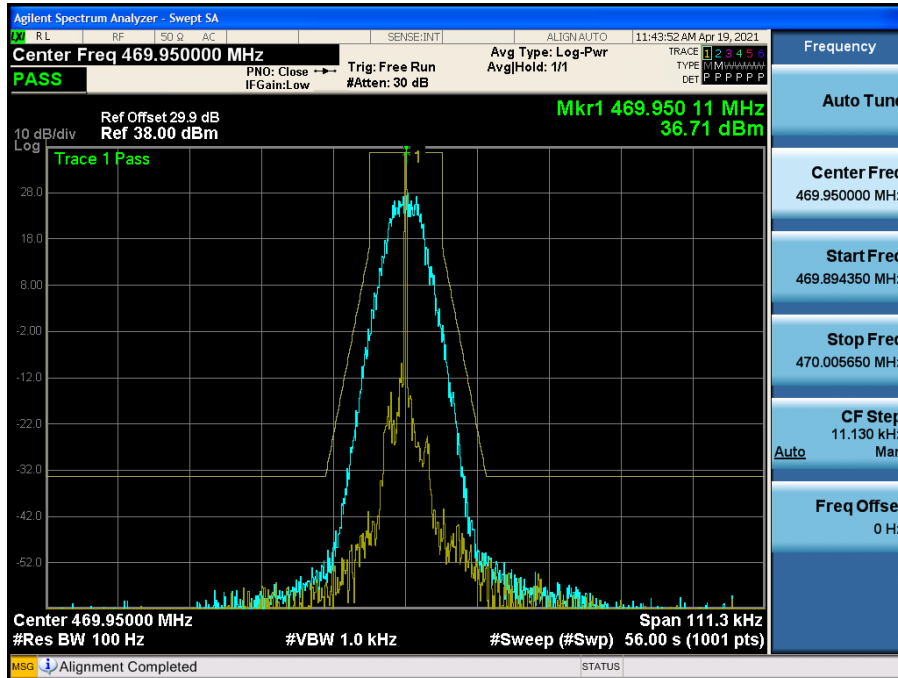

(406.15 MHz)\_Low

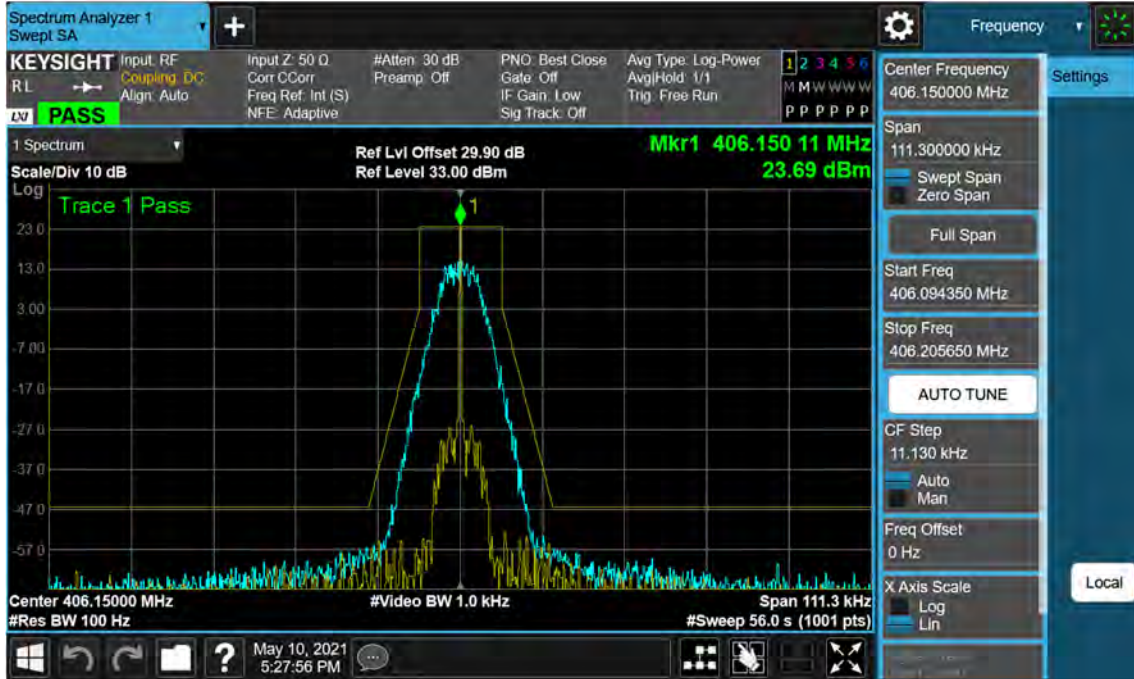

(429.95 MHz)\_Low

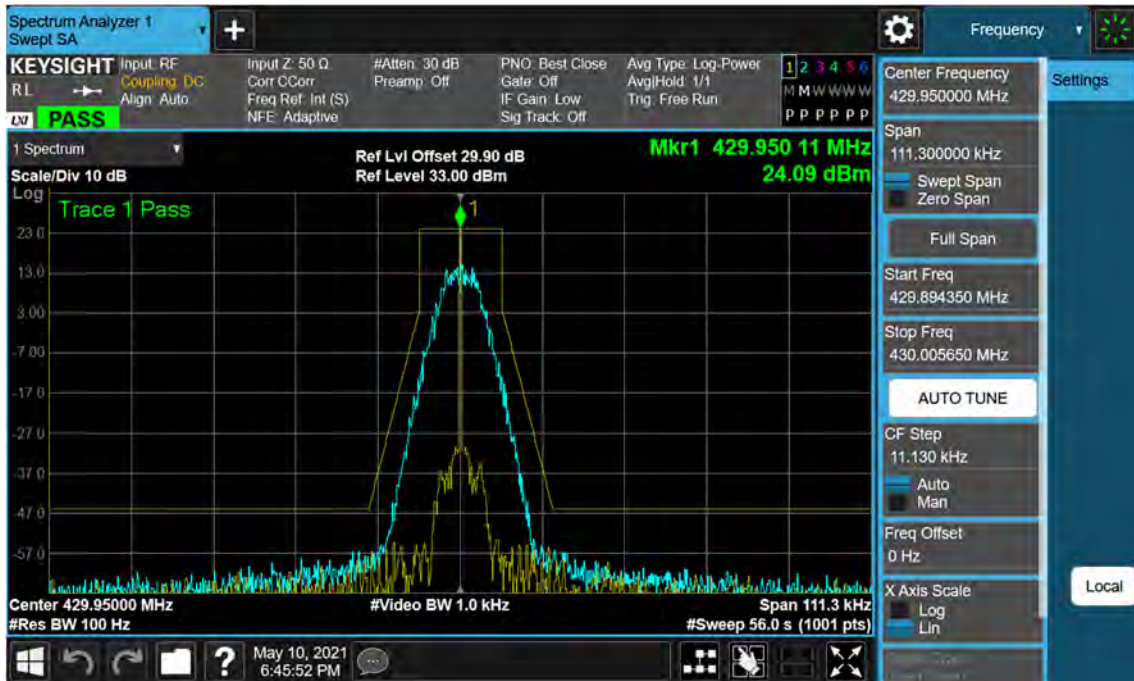



(469.95 MHz)\_ Low

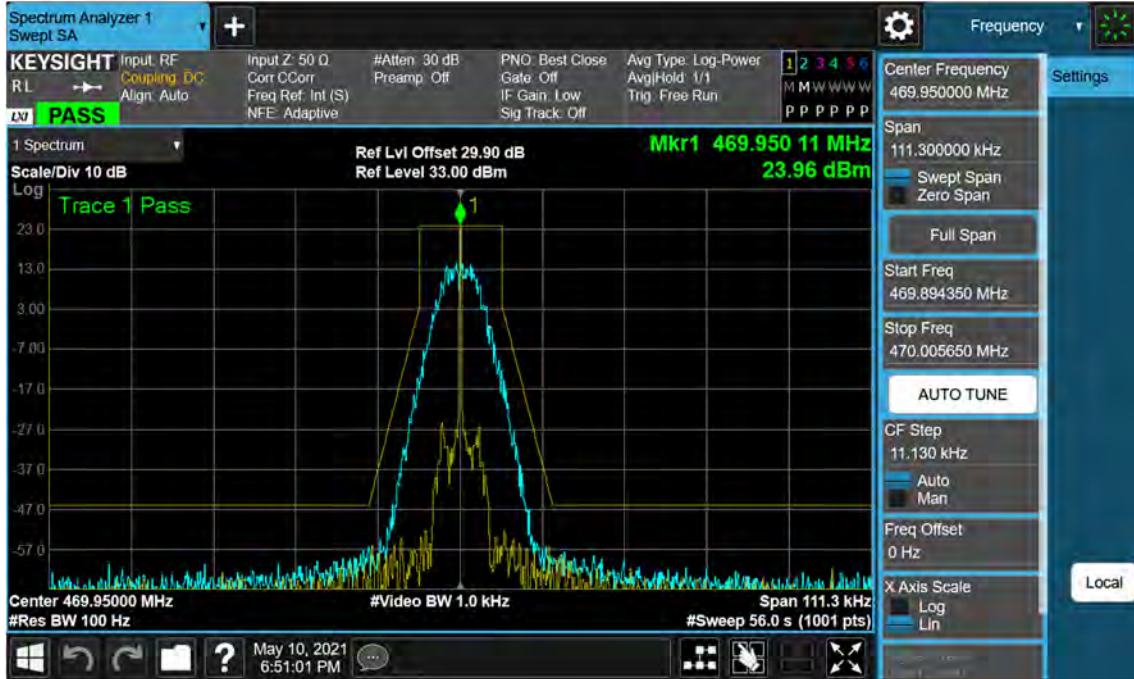

7K60FXD, 7K60FXE\_FCC/ISED

(406.15 MHz)\_High

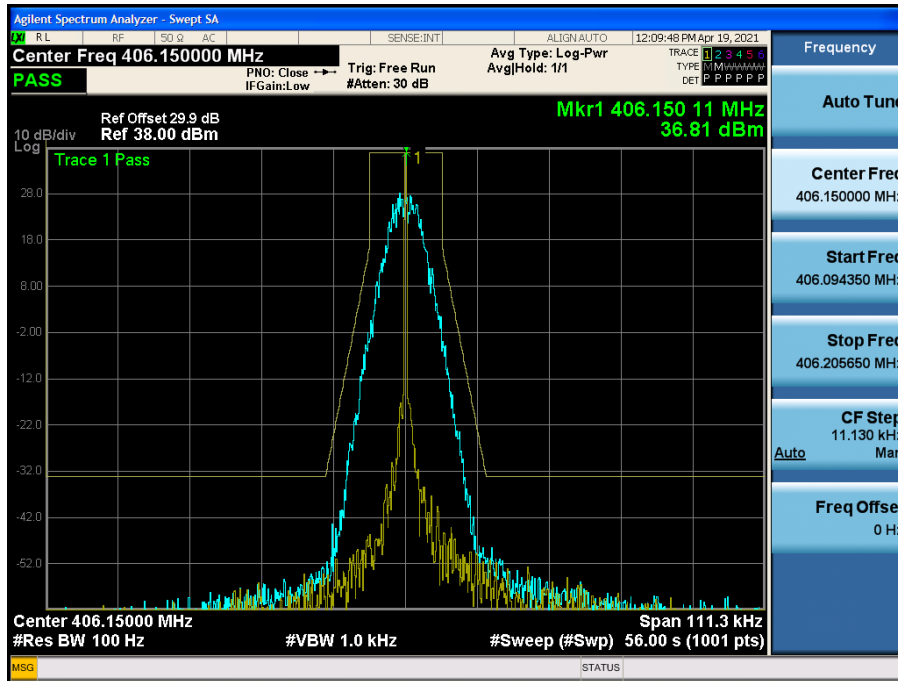

(429.95 MHz)\_High

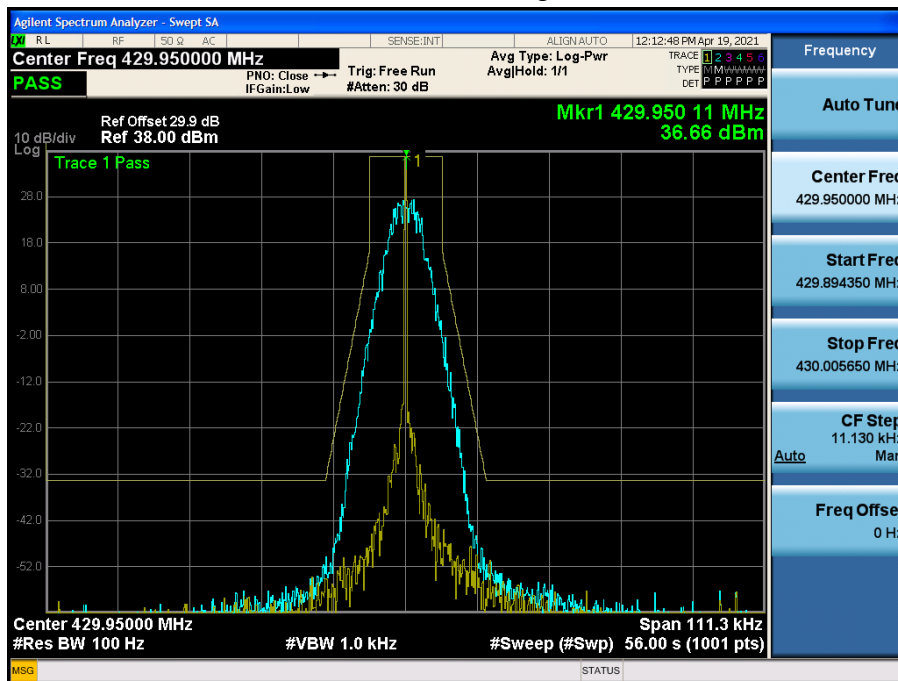

(469.95 MHz)\_High

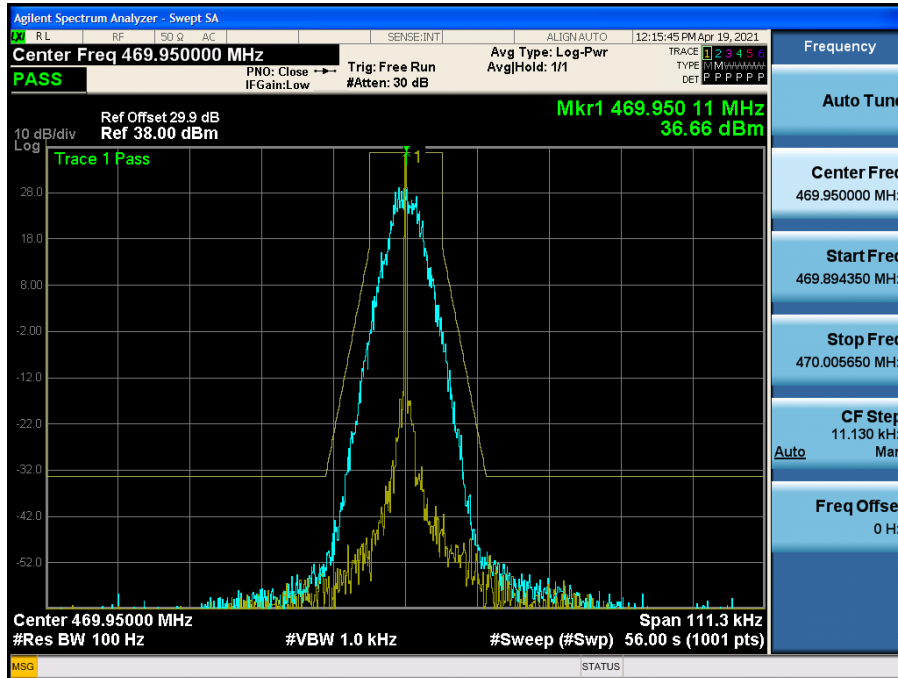

(406.15 MHz)\_Low

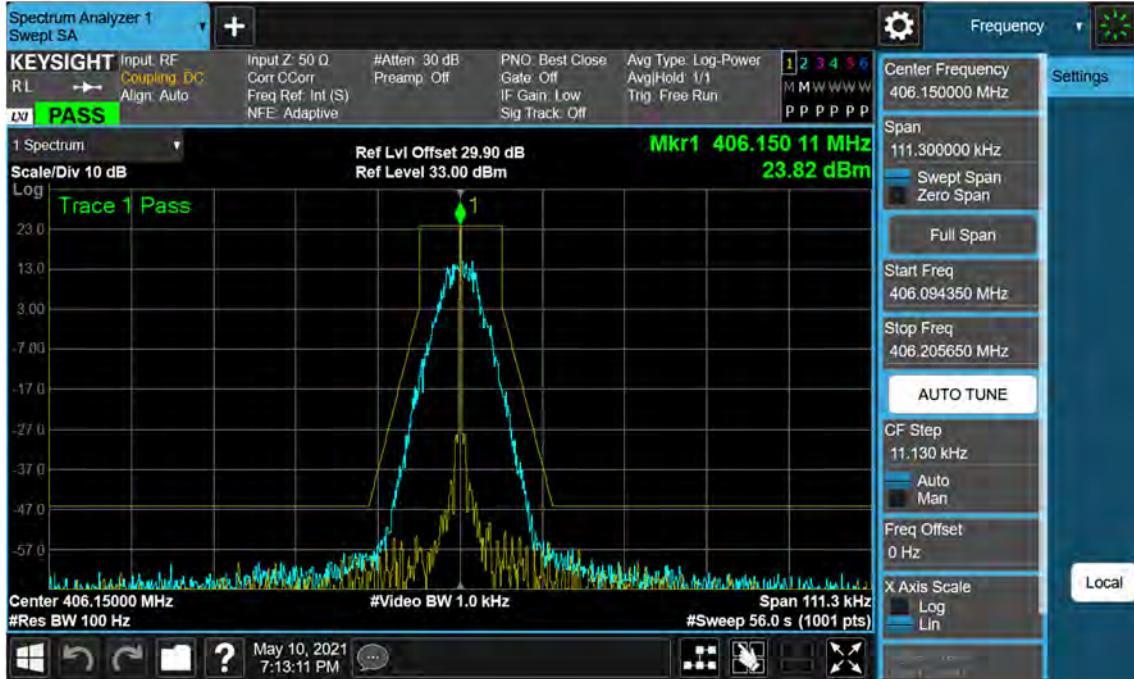

(429.95 MHz)\_Low

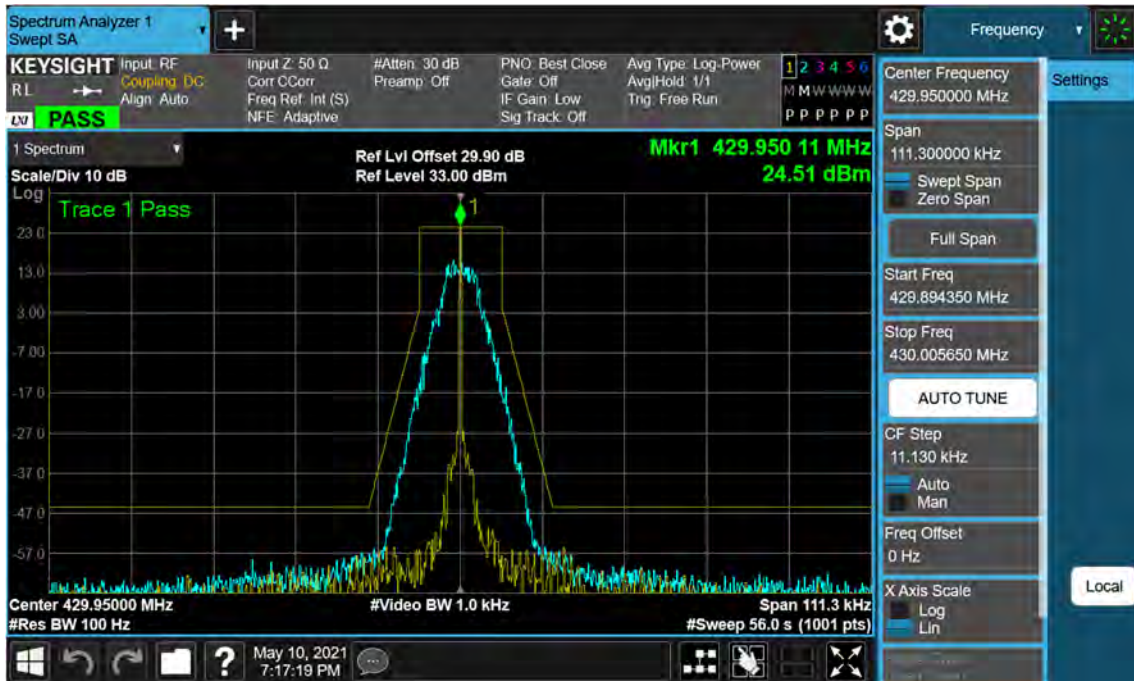

(469.95 MHz)\_ Low

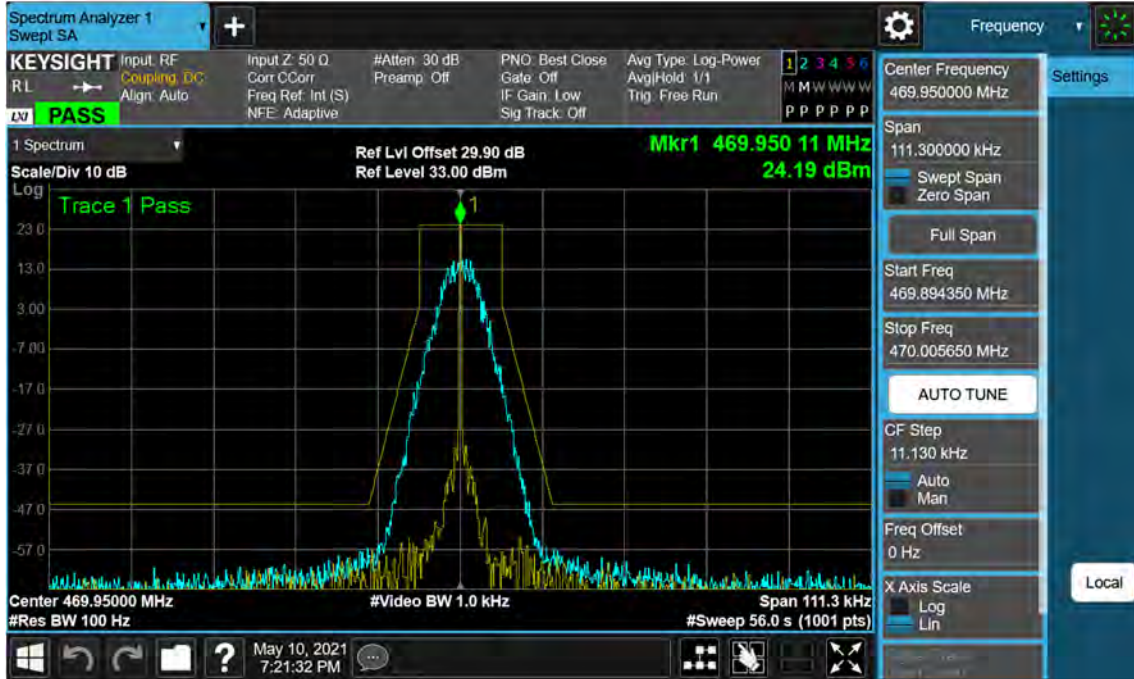

4K00F1E, 4K00F1D, 4K00F7W\_FCC/ISED

(406.15 MHz)\_High

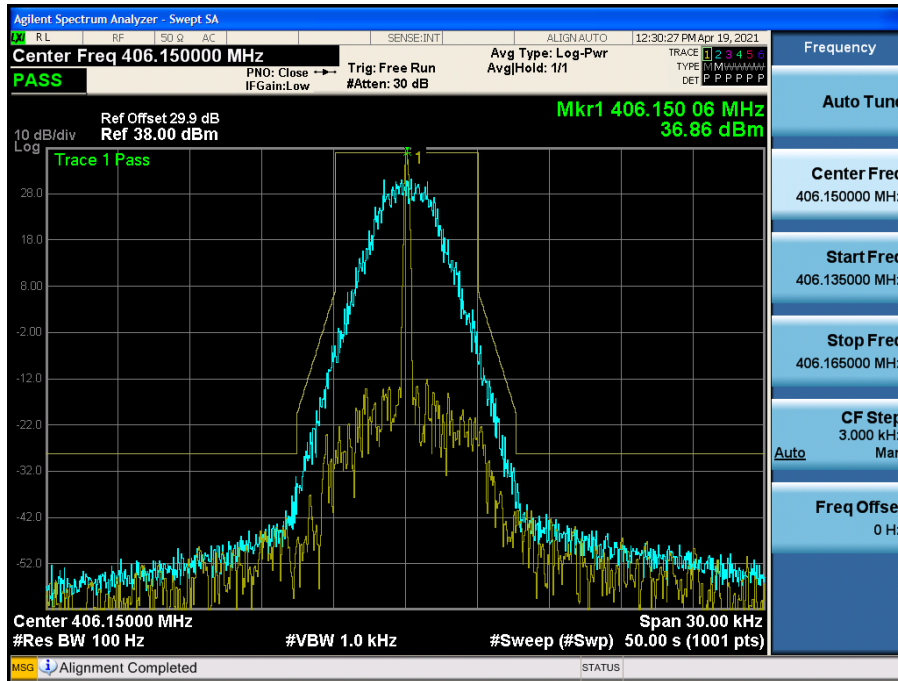

(429.95 MHz)\_High

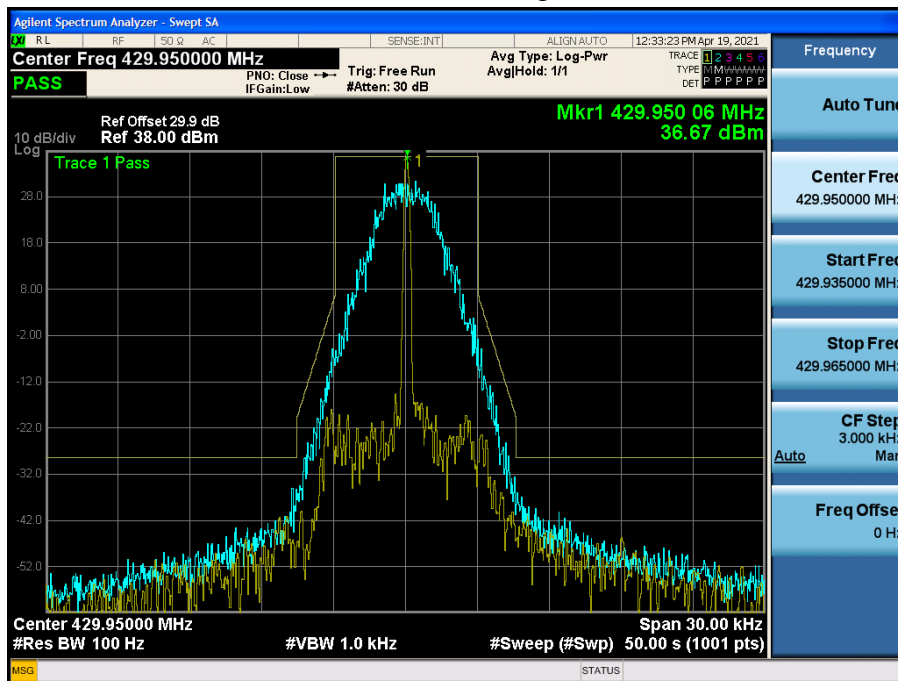

(469.95 MHz)\_High

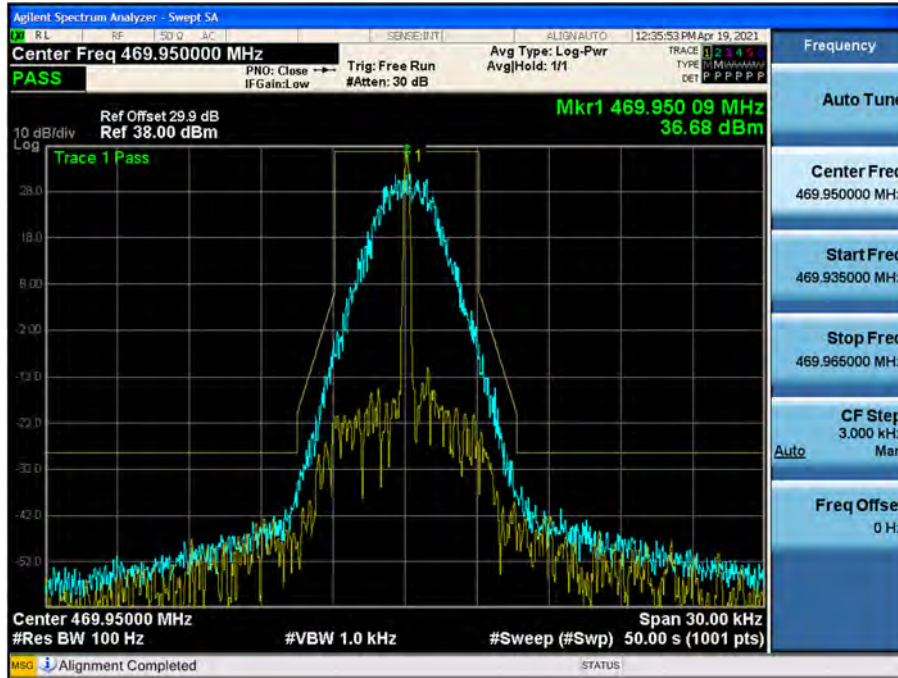

(406.15 MHz)\_Low

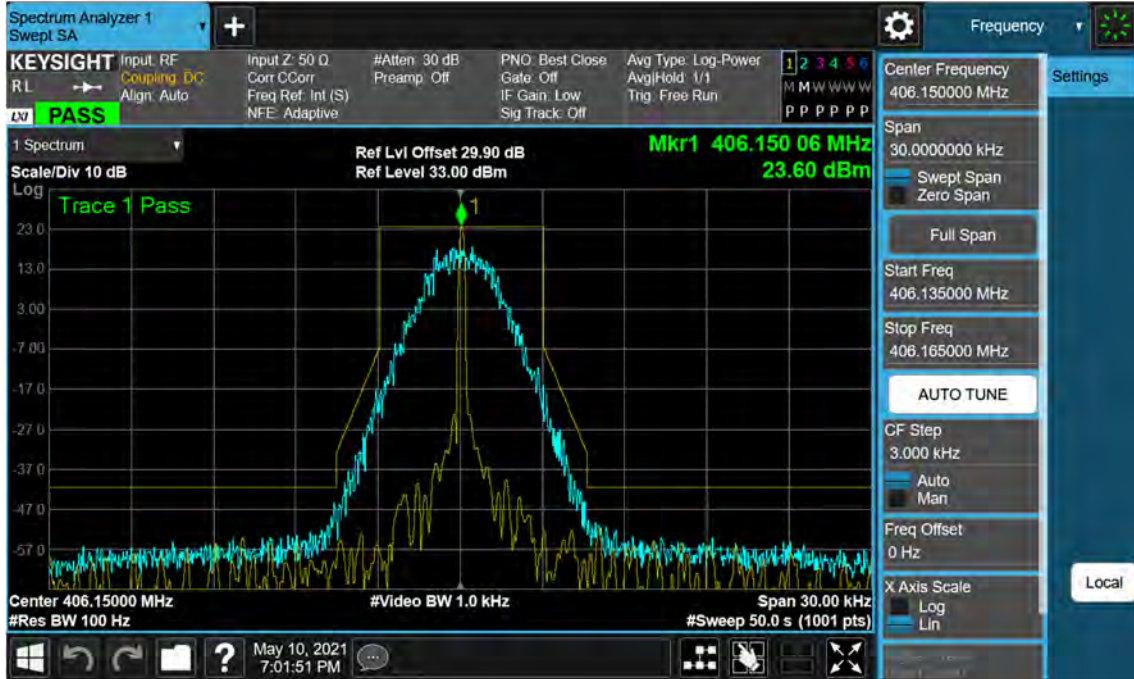

(429.95 MHz)\_Low

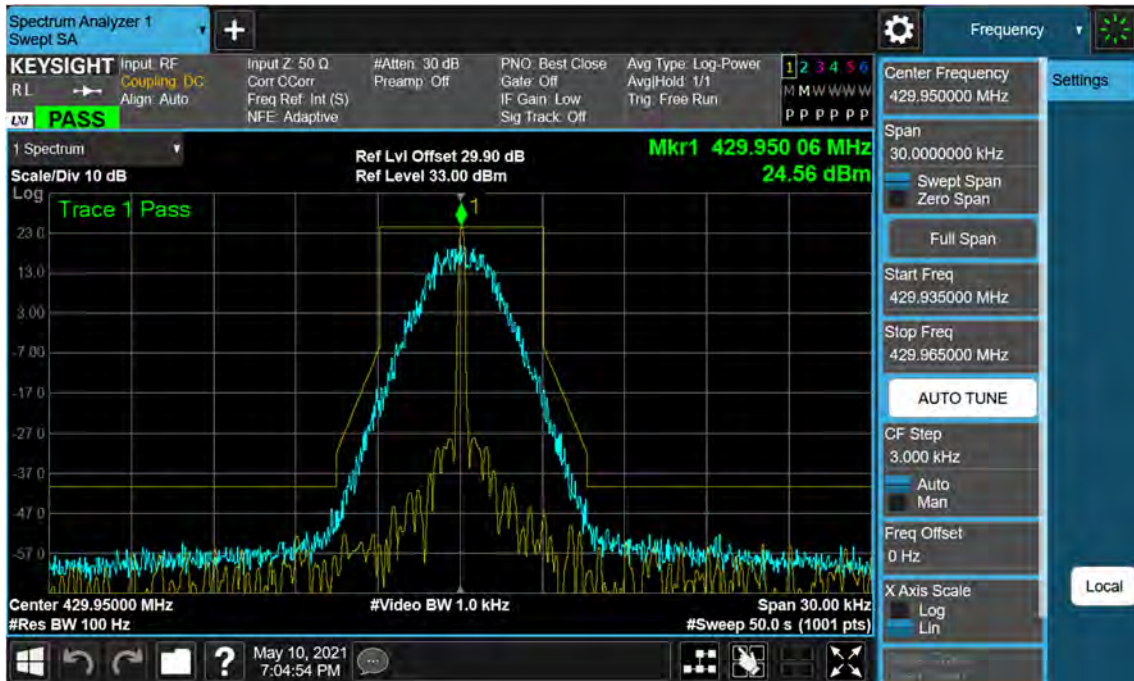





4K00F2D\_FCC/ISED

(406.15 MHz)\_High

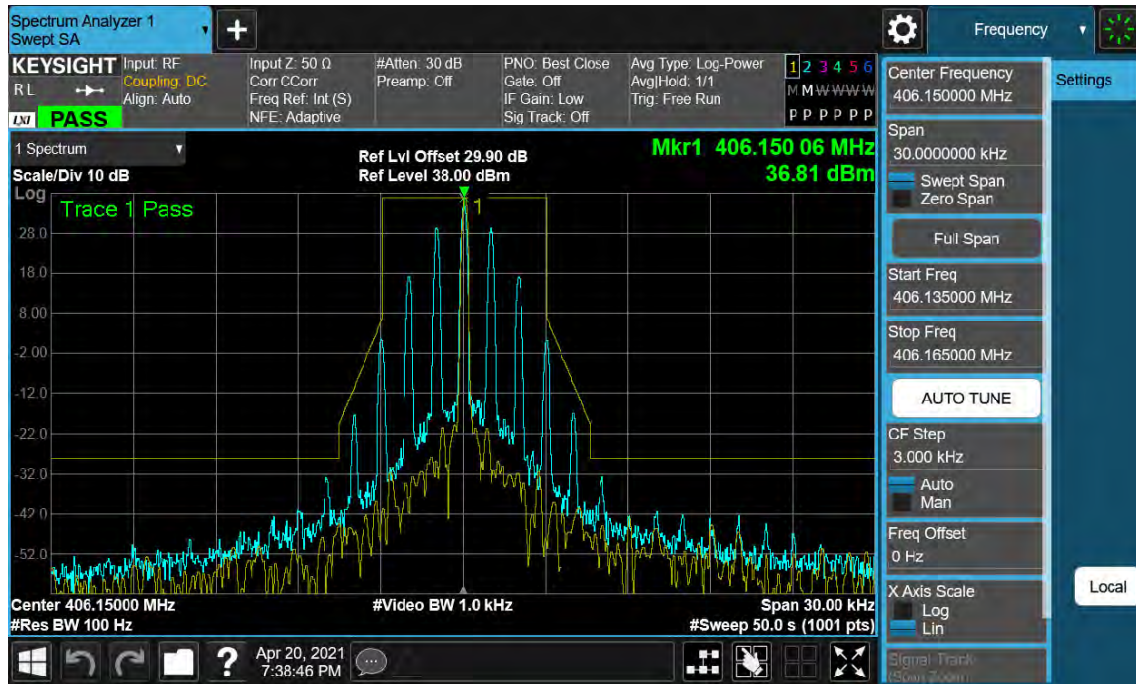

(429.95 MHz)\_High

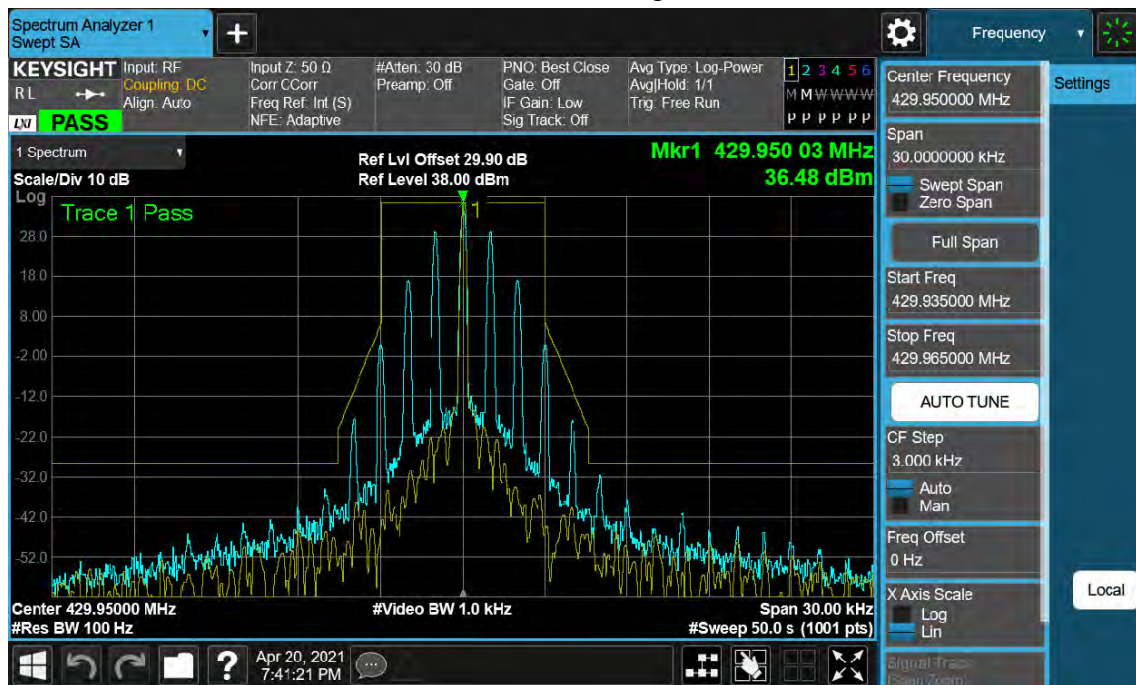

### (469.95 MHz)\_High

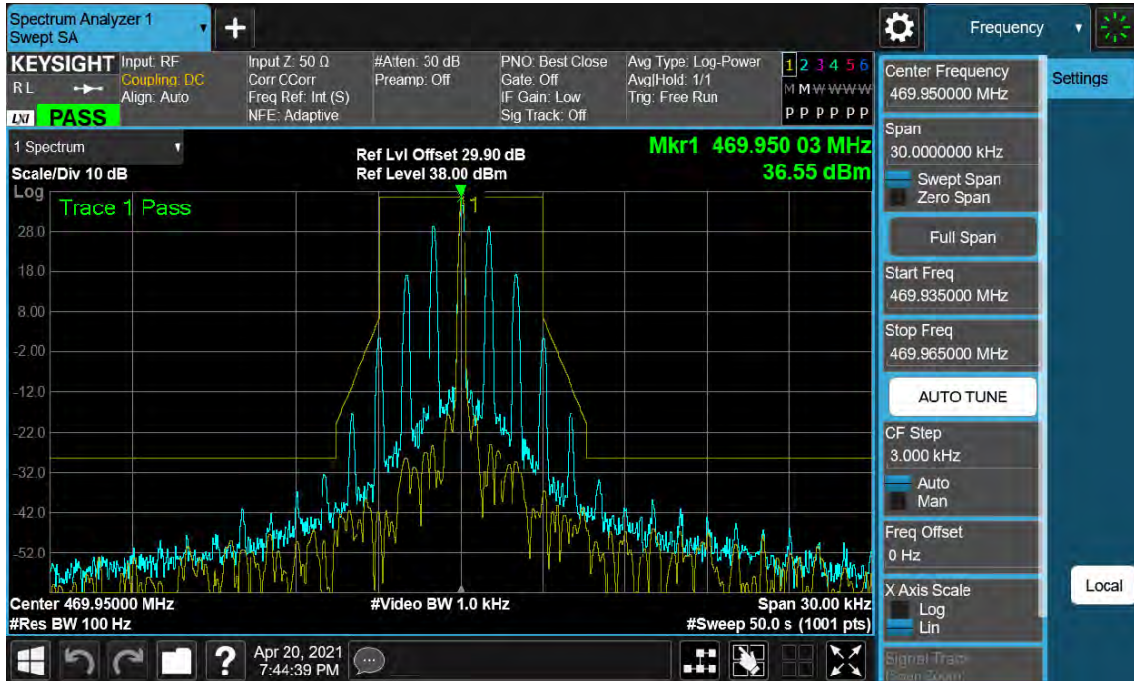

(406.15 MHz)\_Low

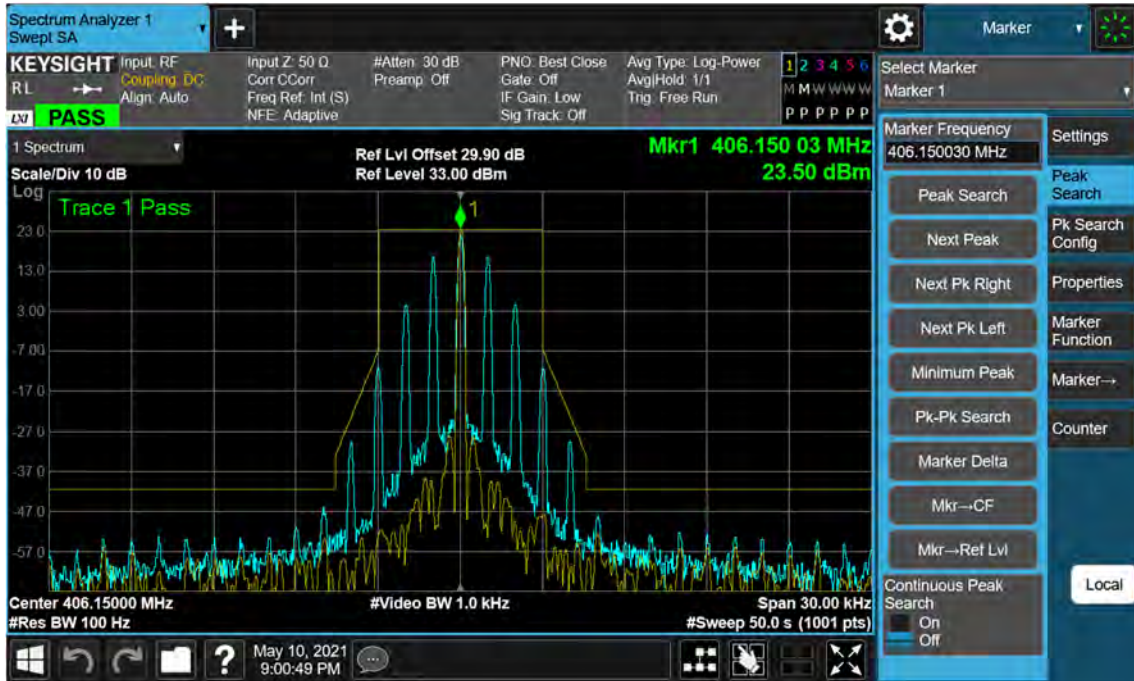

(429.95 MHz)\_Low

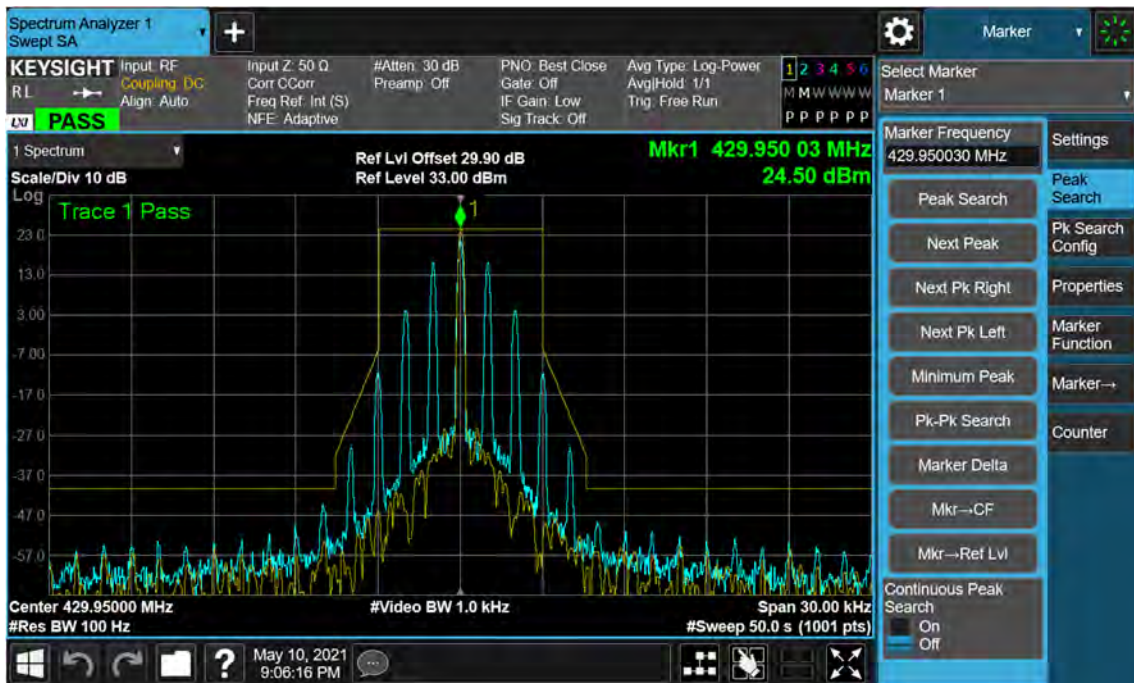

(469.95 MHz)\_ Low

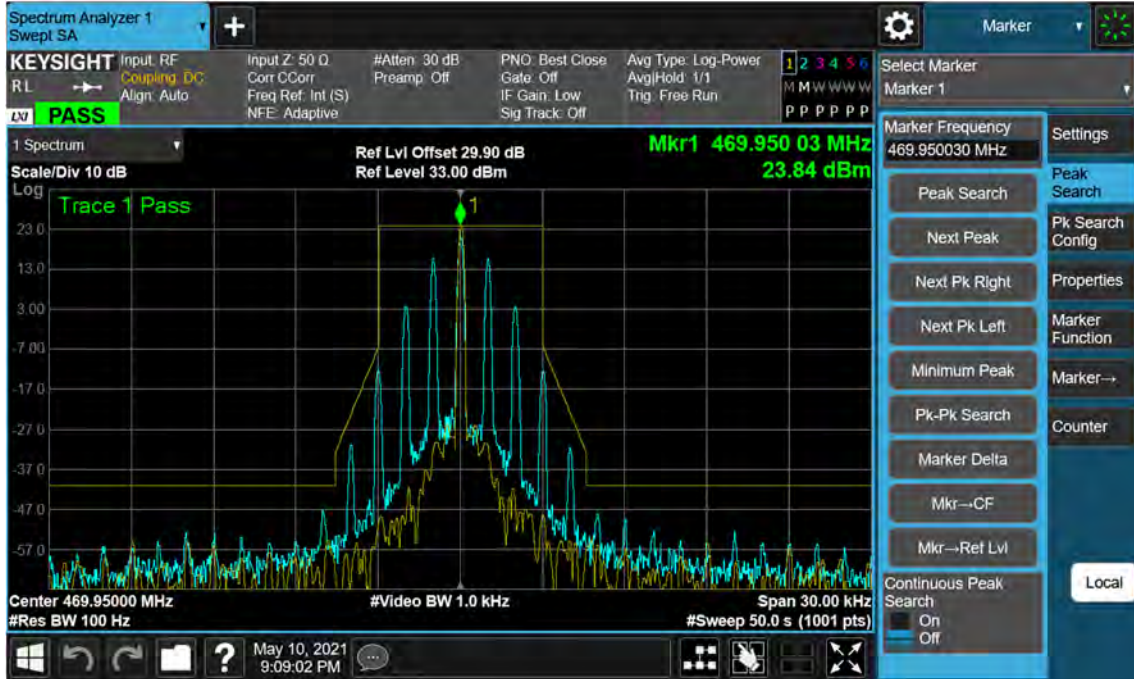

## 8.7 Transient Frequency Behavior

### ▣ Definition

Transient frequency behavior is a measure of the difference, as a function in time, of the actual transmitter frequency to the assigned transmitter frequency when the transmitted RF output power is switched on or off.

### ▣ TEST CONFIGURATION

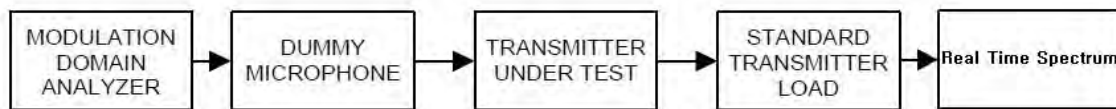

### ▣ TEST PROCEDURE

According to 2.2.19 in TIA-603-E Standard.

- a) Connect the equipment as illustrated.
- b) Connect the output of the standard transmitter load to the RF power meter.  
Supply sufficient attenuation via the RF attenuator to provide a level that is approximately 40 dB below the maximum allowable input to the modulation domain analyzer.
- c) Unkey the transmitter.
- d) Disconnect the RF power meter and connect the modulation domain analyzer in its place.  
Set the envelope trigger of the modulation domain analyzer to the minimum level that will trigger when the transmitter is keyed.
- e) Reduce the attenuation of the RF attenuator so that the input to the modulation domain analyzer is increased by 30 dB when the transmitter is keyed.
- f) Set the modulation domain analyzer to trigger on the rising edge of the waveform in order to capture a single-shot turn-on of the transmitter signal.
- g) Adjust the display of the modulation domain analyzer for proper viewing of the transmitter transient behavior. Set the time base reference to the left for observing the transmitter turn-on transient.
- h) Key the transmitter.
- i) Observe the stored display of the modulation domain analyzer.  
The signal trace shall be maintained within the allowable limits during the periods  $t_1$  and  $t_2$ , and shall also remain within limits following  $t_2$ .
- j) Adjust the modulation domain analyzer to trigger on the falling edge of the transmitter waveform in order to capture a single-shot turn-off transient of the transmitter signal.

- k) Adjust the display of the modulation domain analyzer for proper viewing of the transmitter transient behavior. Set the time base reference to the right for observing the transmitter turn-off transient.
- l) Unkey the transmitter.
- m) Observe the stored display of the modulation domain analyzer. The signal trace shall be maintained within the allowable limits during the period  $t_3$ .

Plots of Transient Frequency Behavior

11K0F3E

(406.15 MHz)\_High





(429.95 MHz)\_High

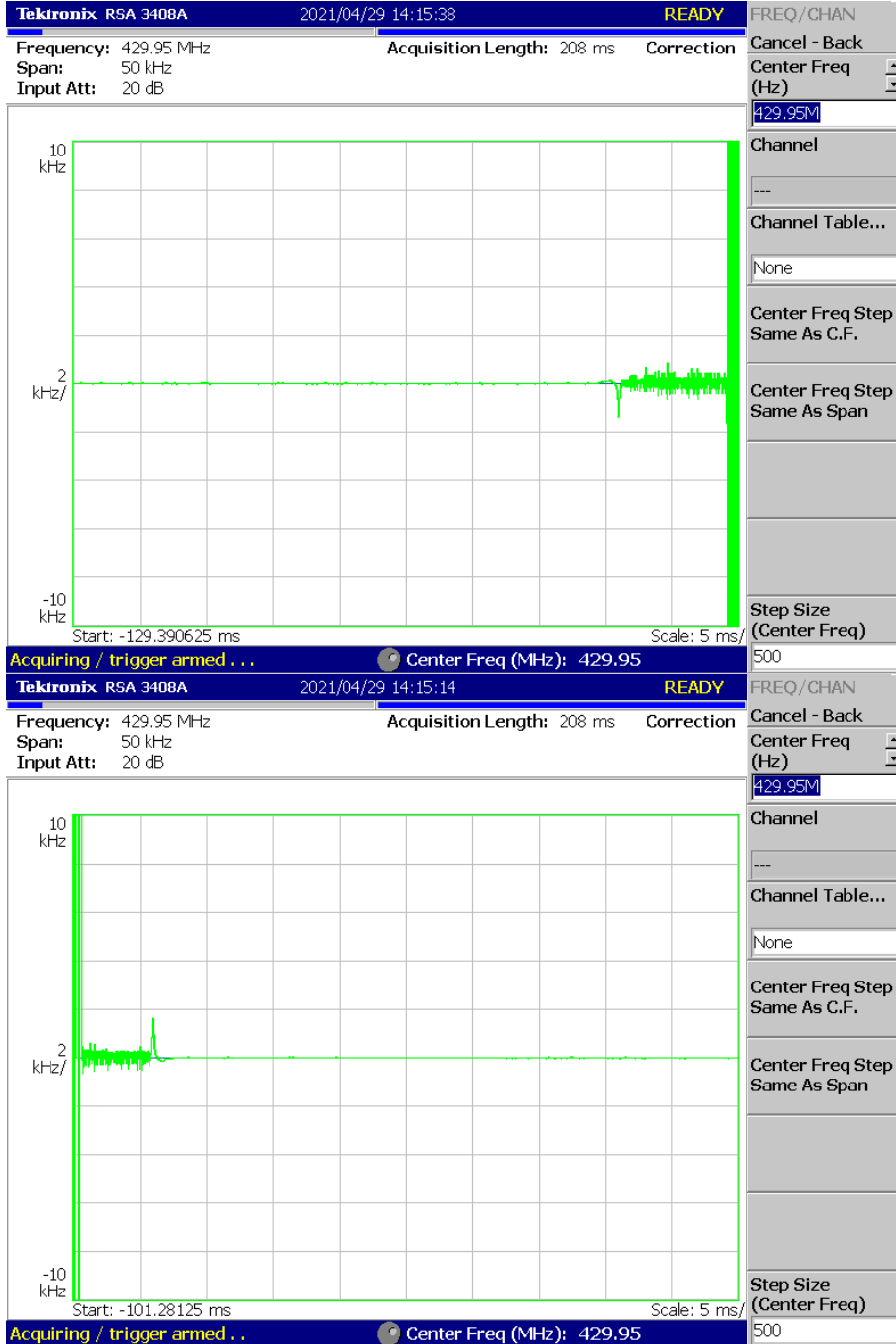

## (469.95 MHz)\_High

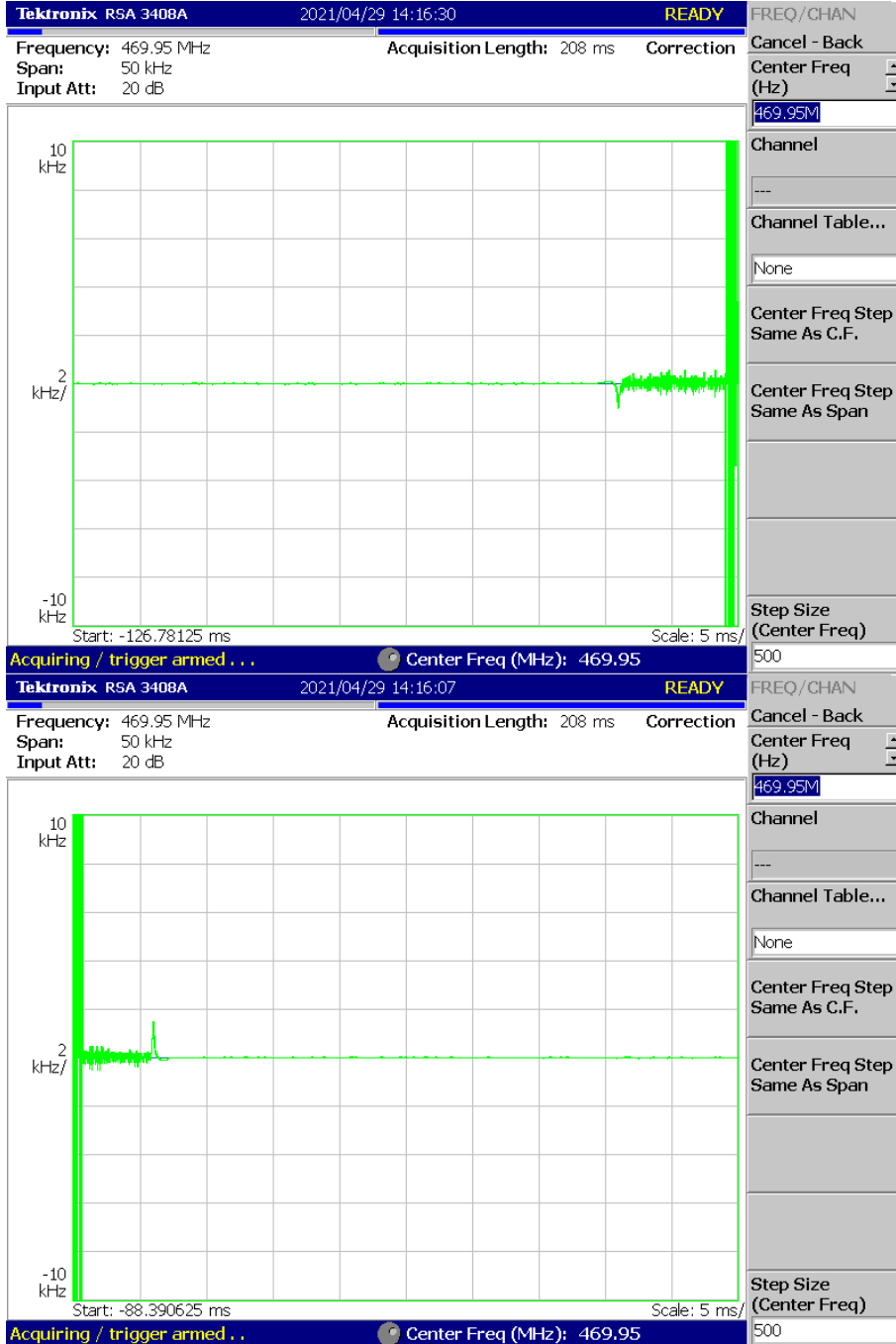

(406.15 MHz)\_Low



(429.95 MHz)\_ Low

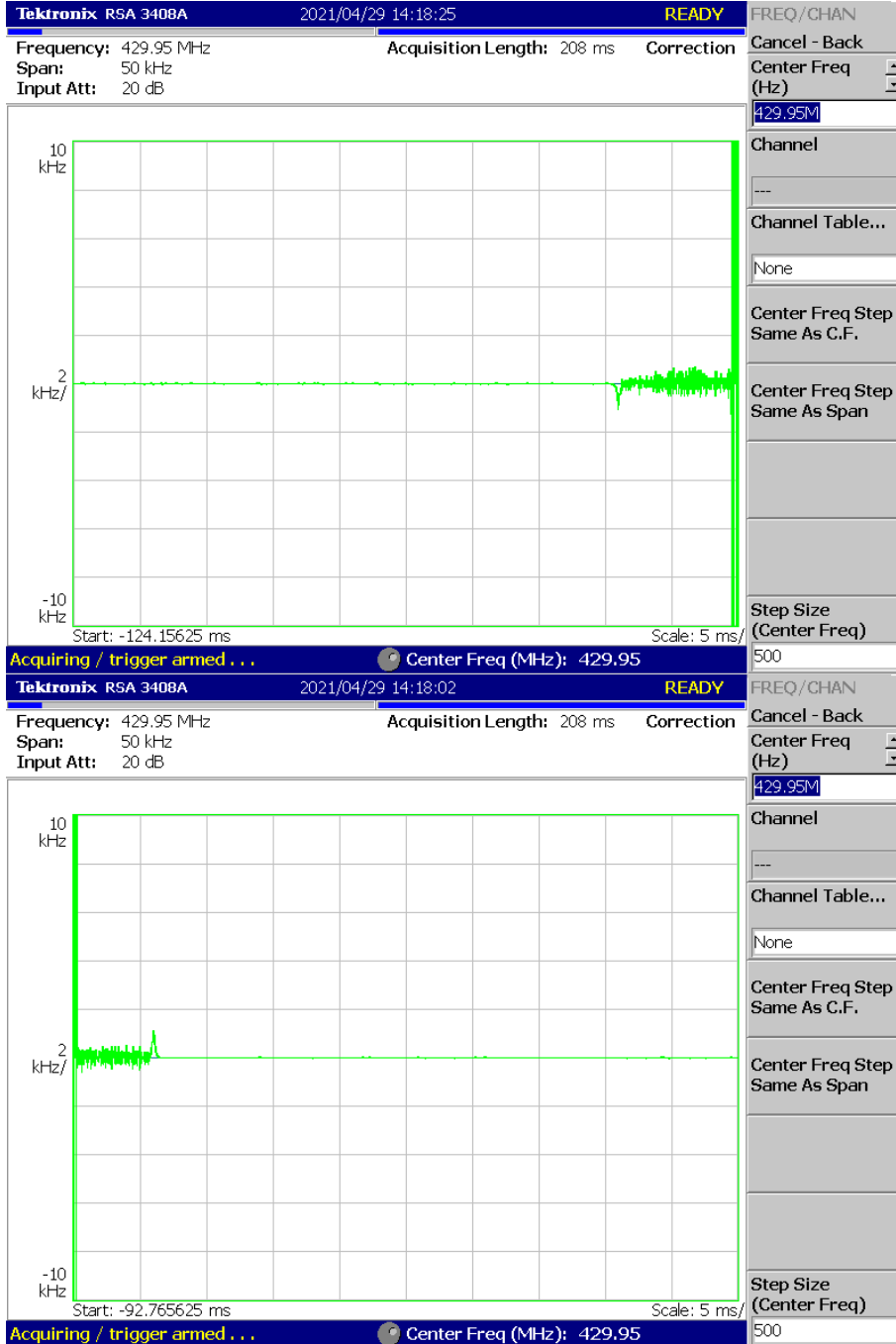

(469.95 MHz)\_ Low



16K0F3E

(406.15 MHz)\_High

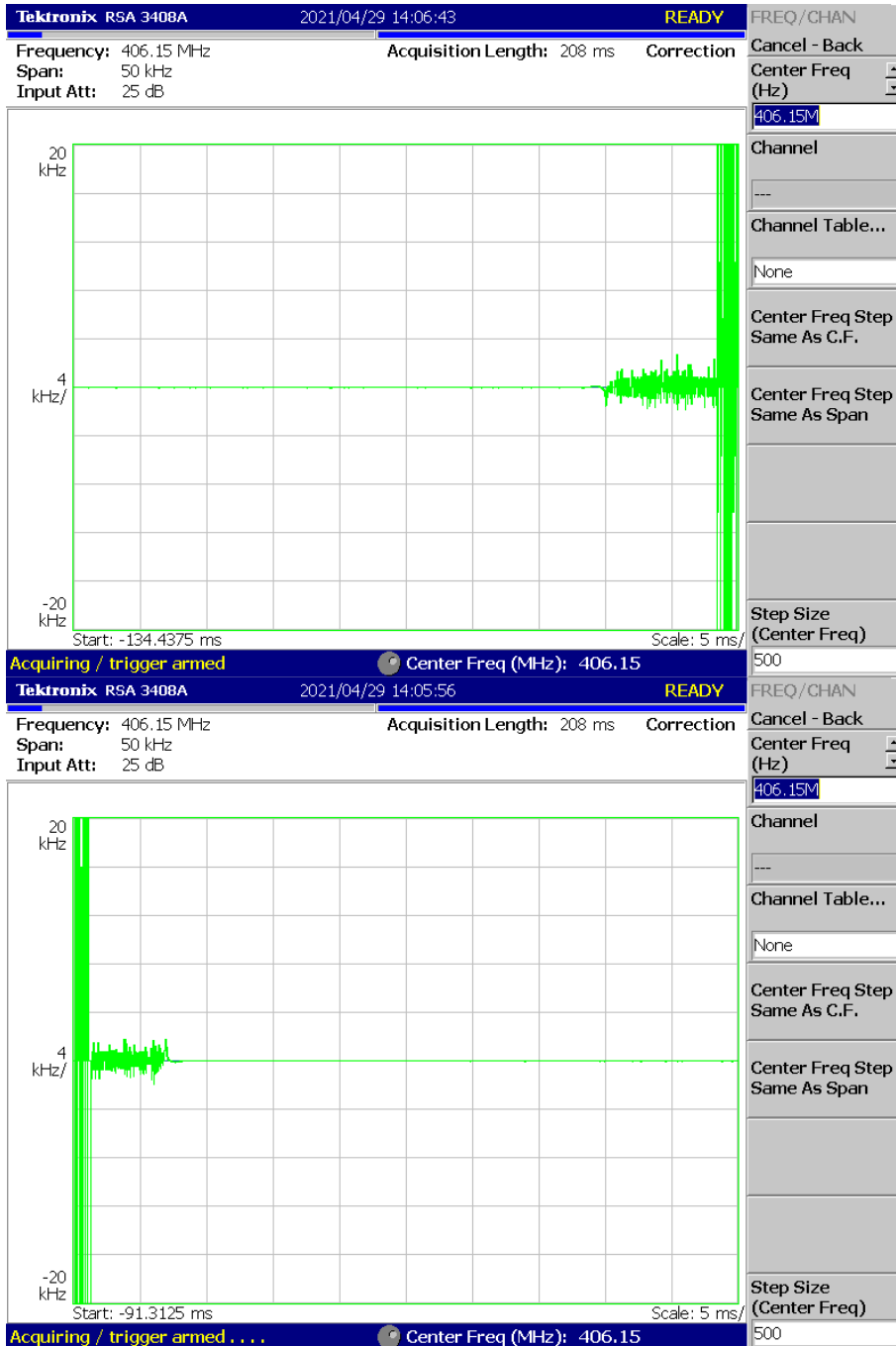

## (429.95 MHz)\_High

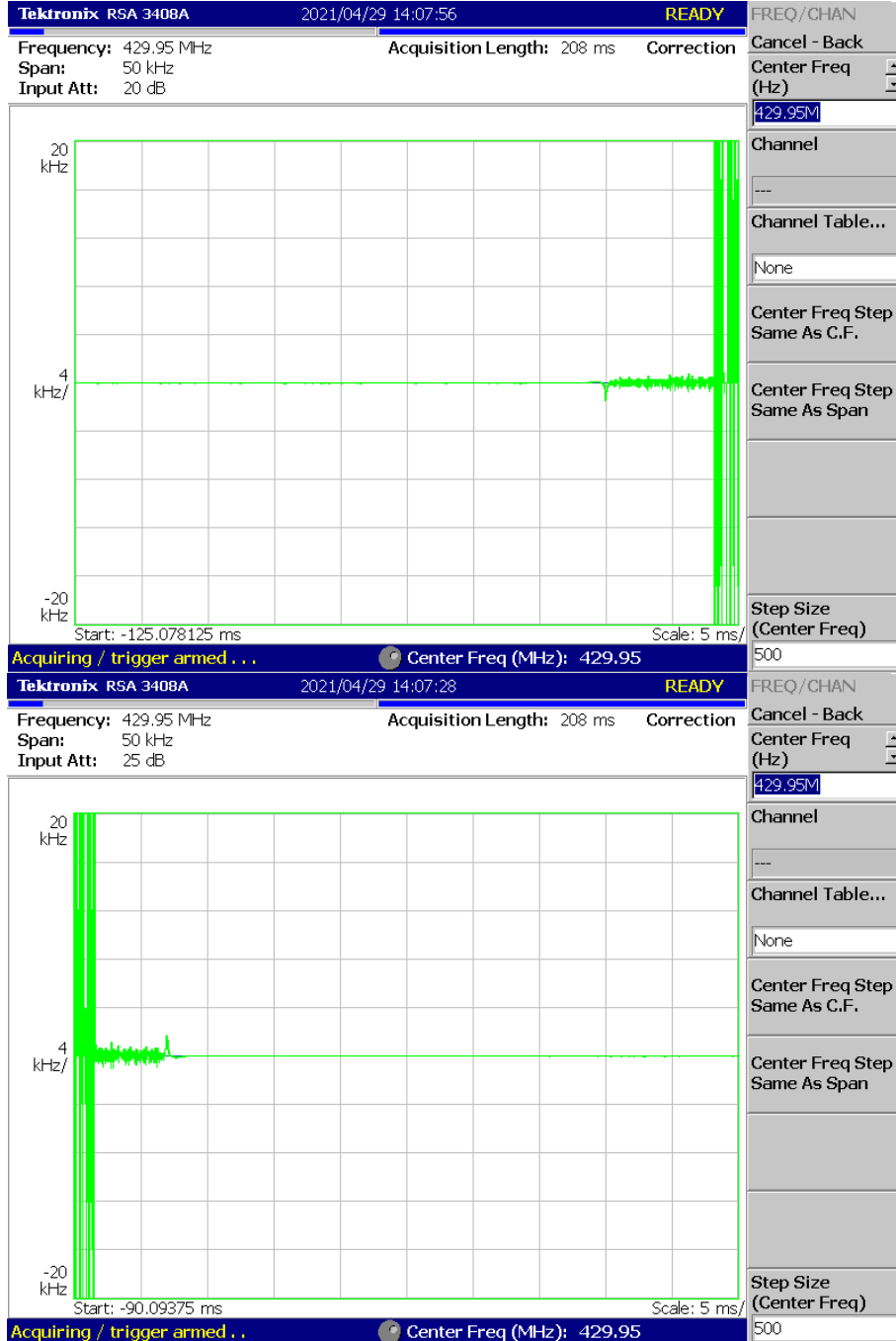

(469.95 MHz)\_High

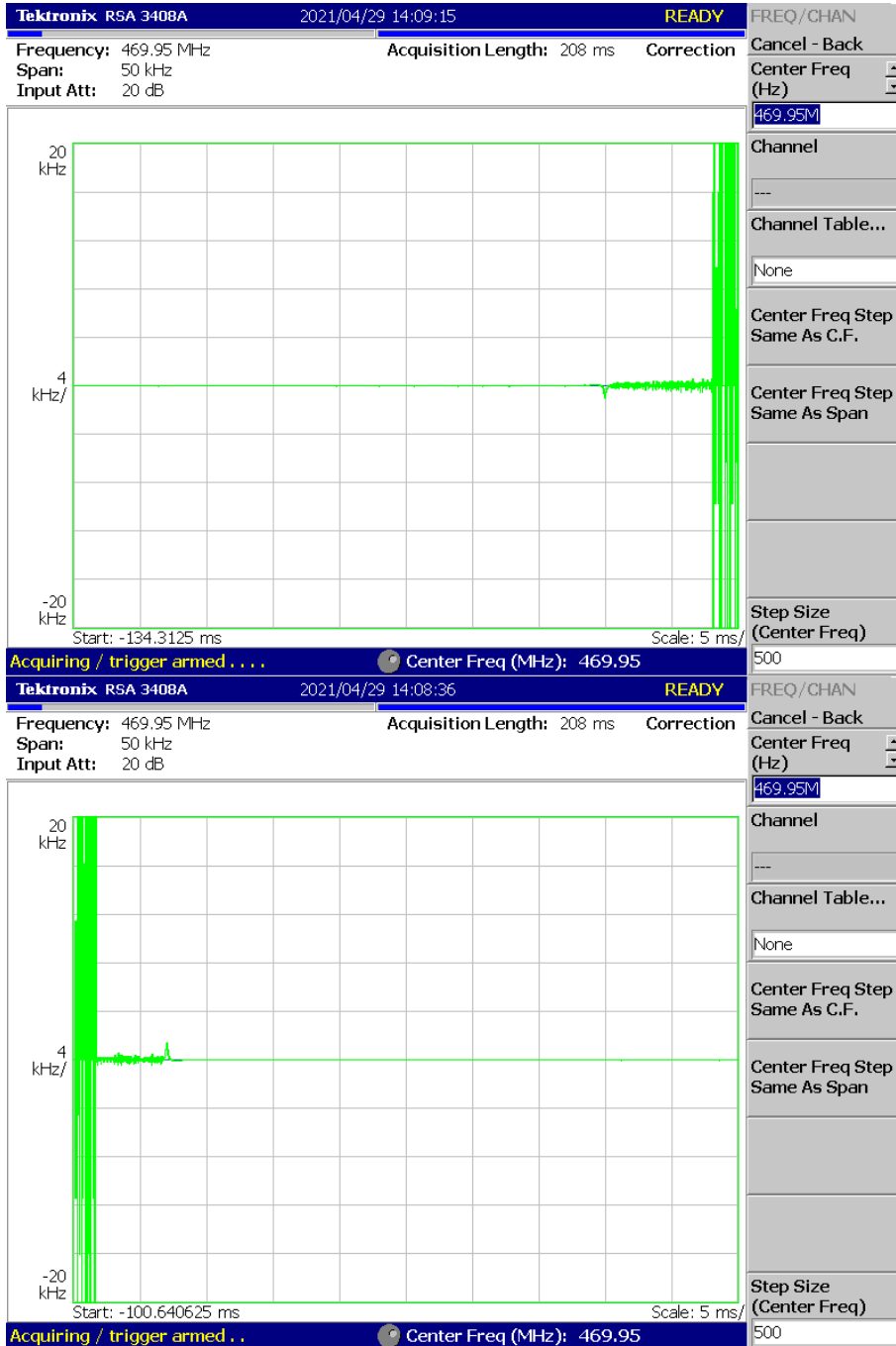



(406.15 MHz)\_Low

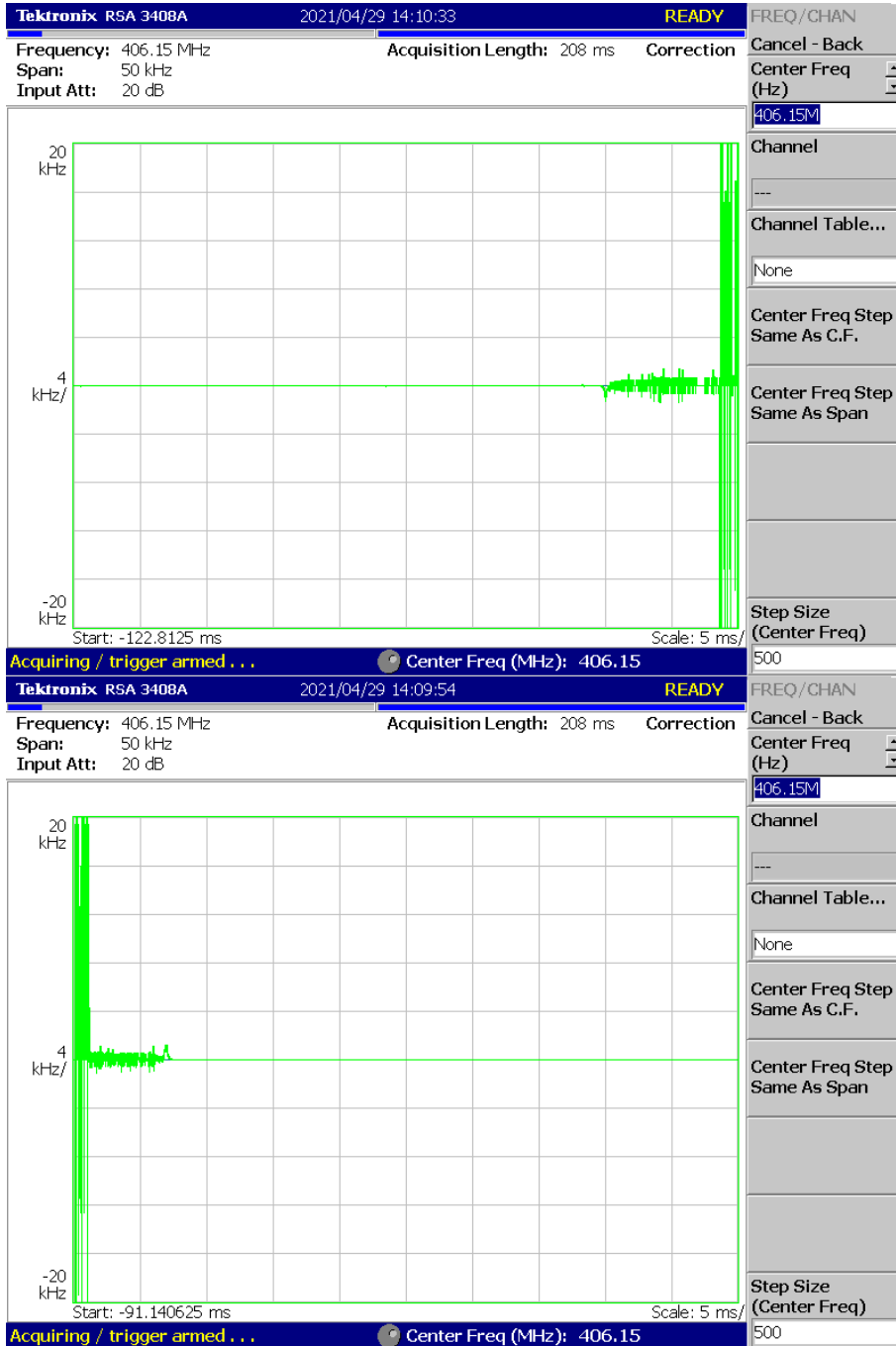

(429.95 MHz)\_ Low

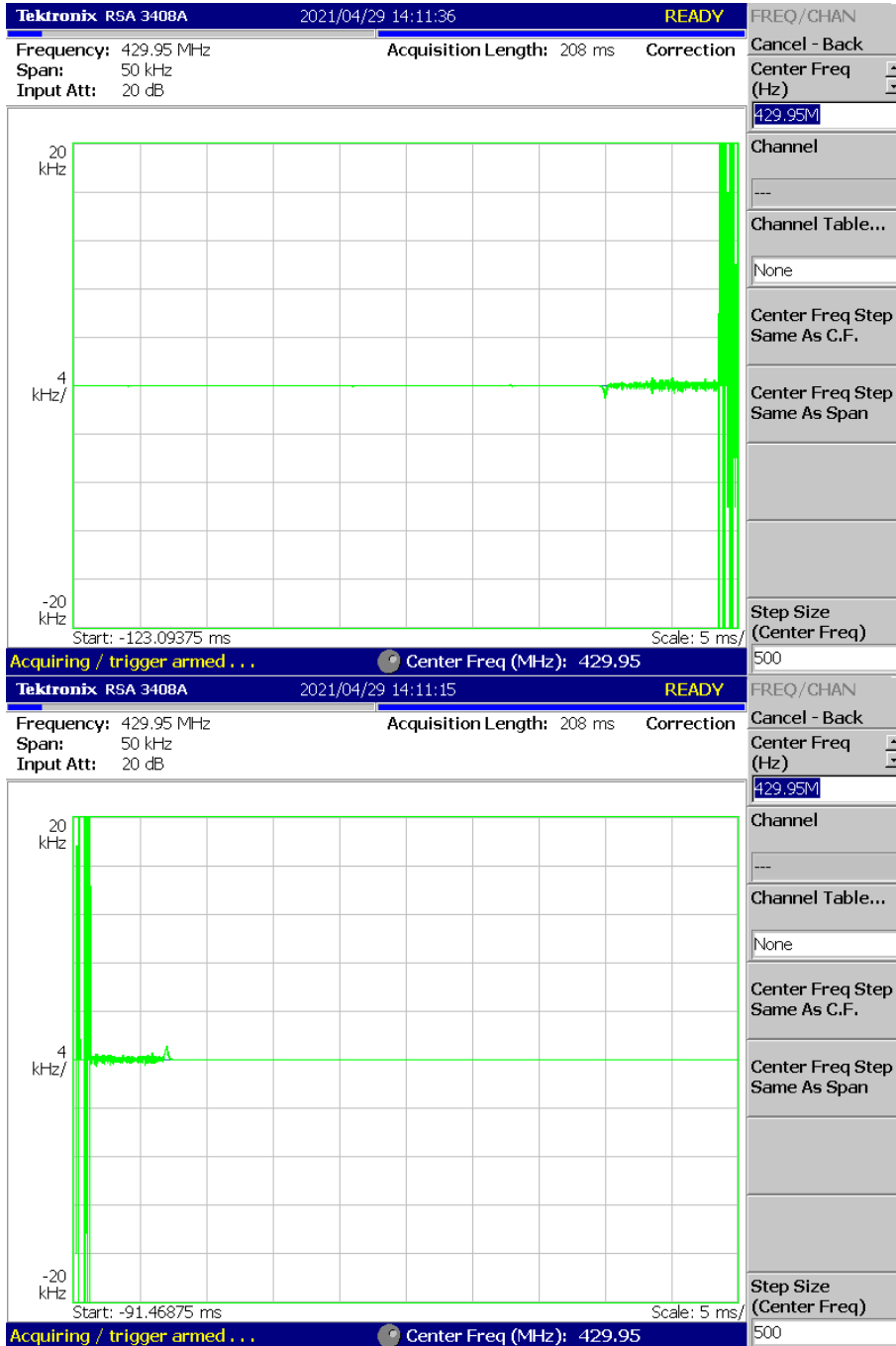

(469.95 MHz)\_ Low

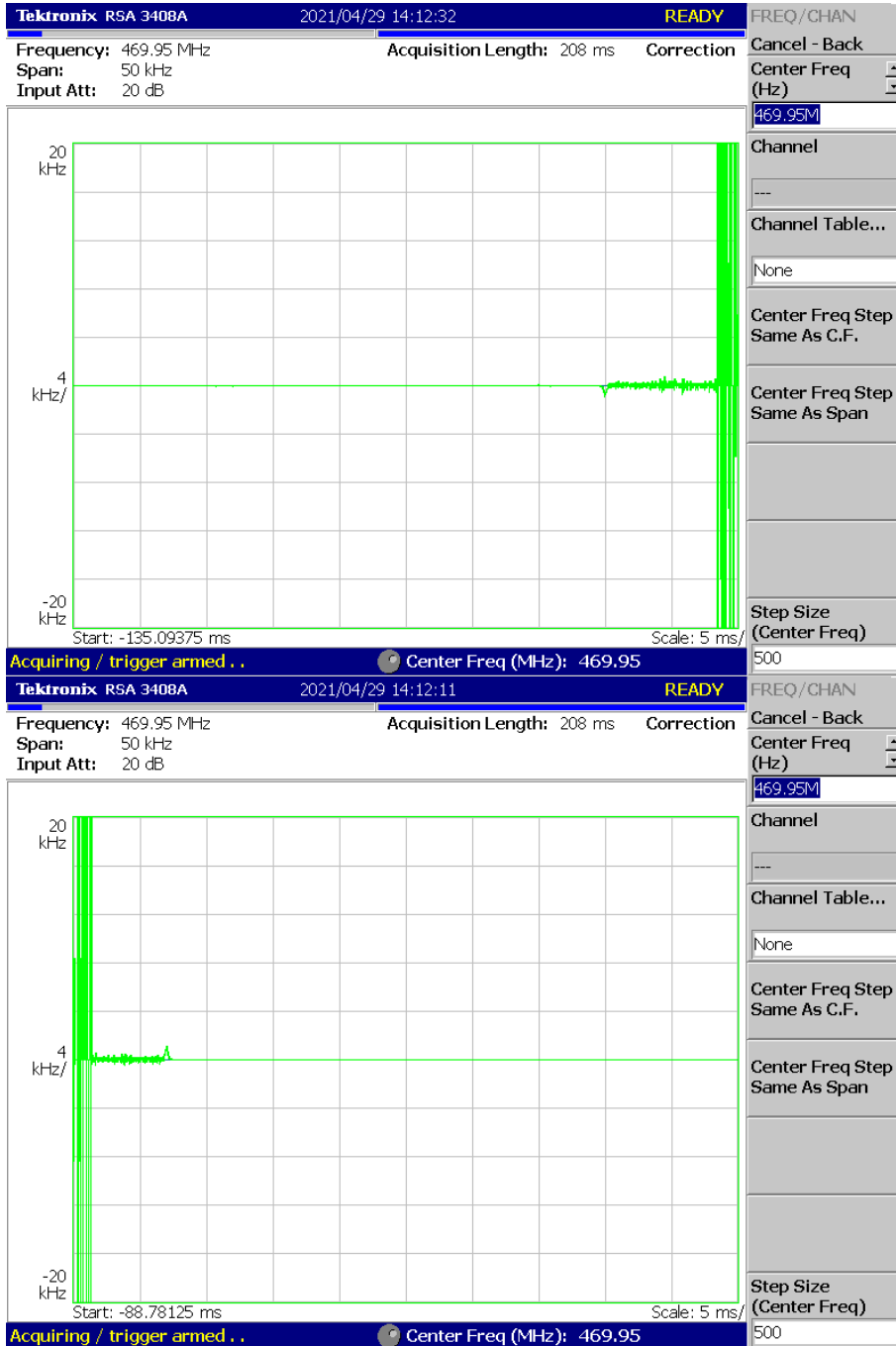

4K00F1E

(406.15 MHz)\_High

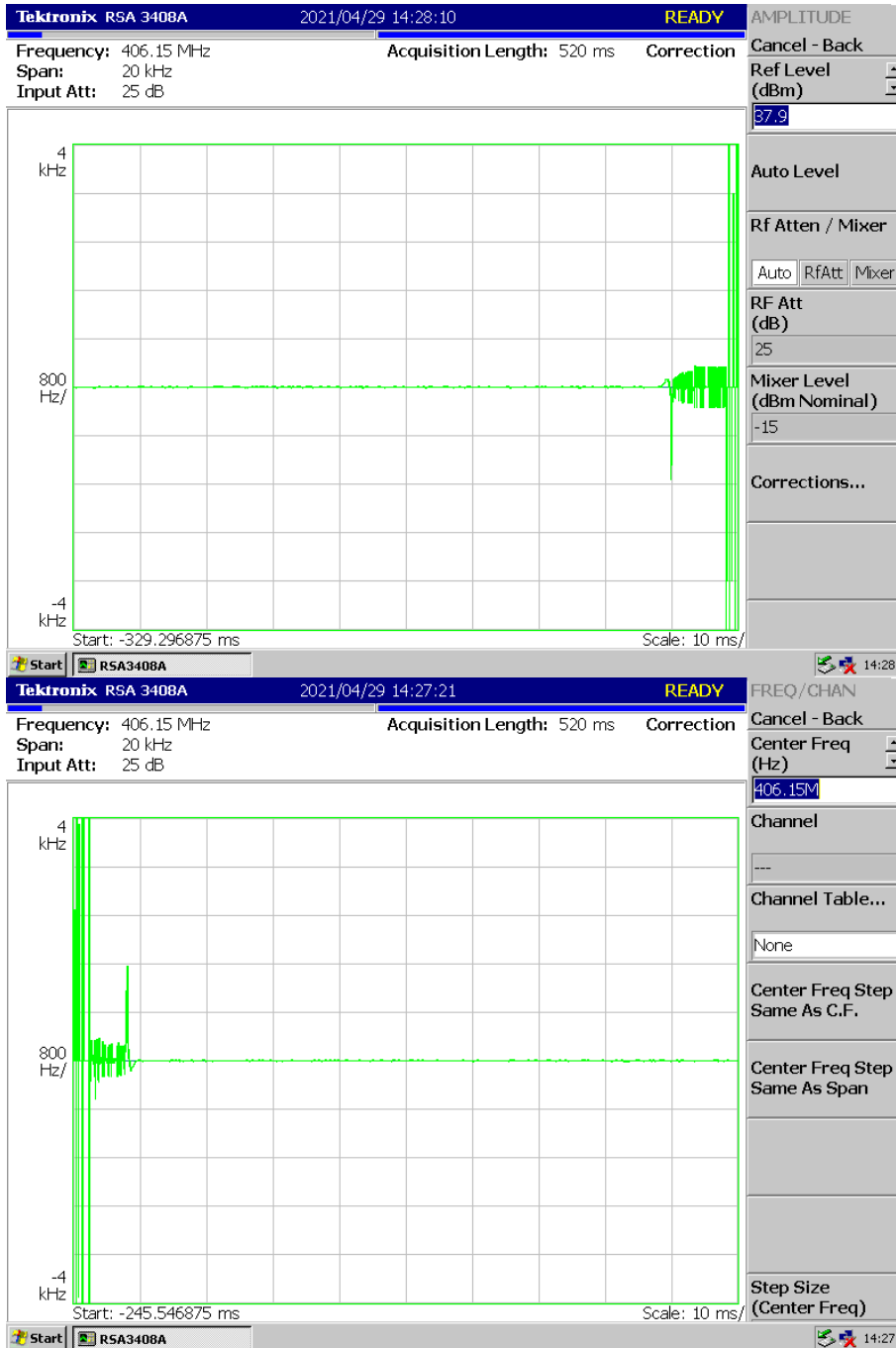

(429.95 MHz)\_High

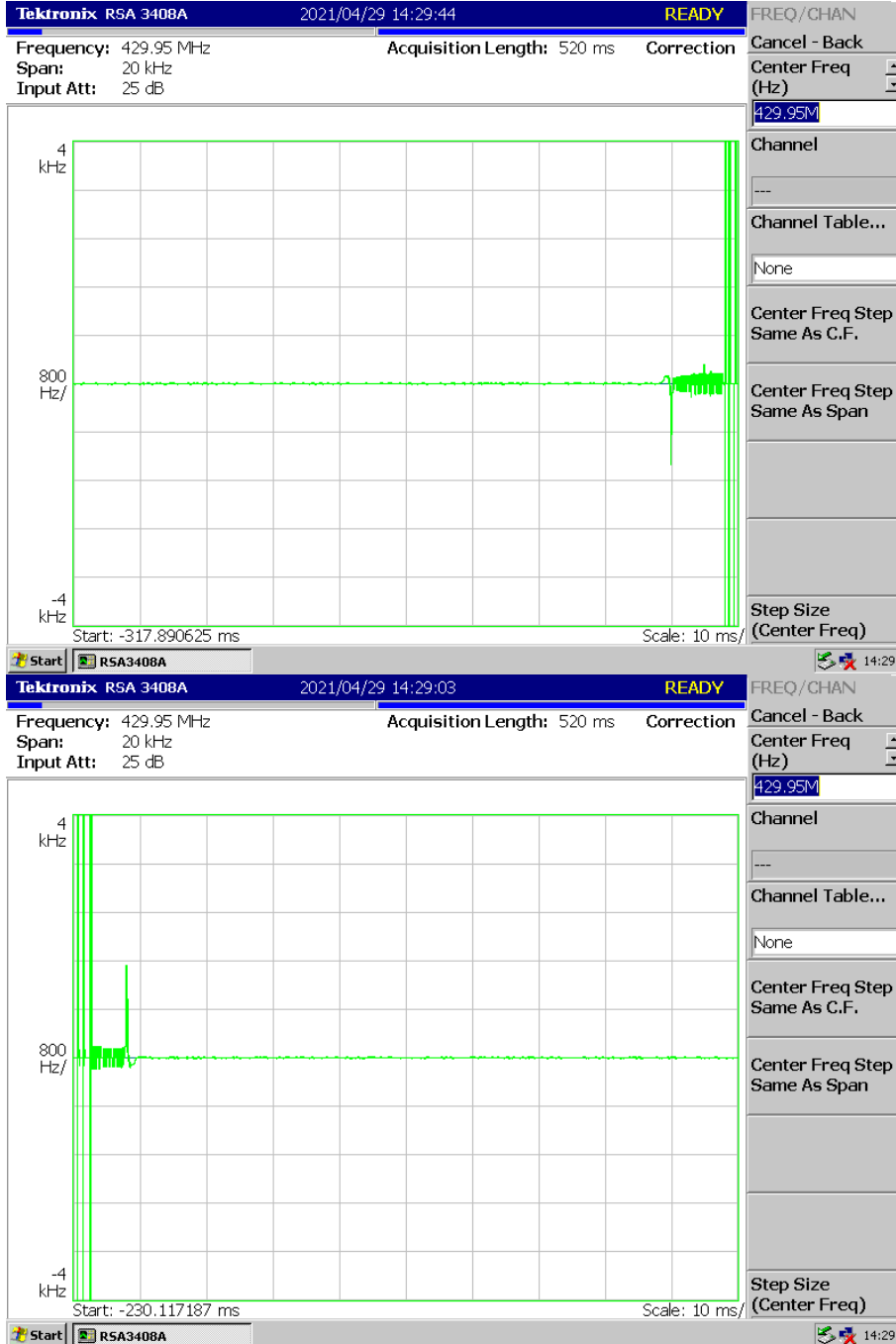

## (469.95 MHz)\_High

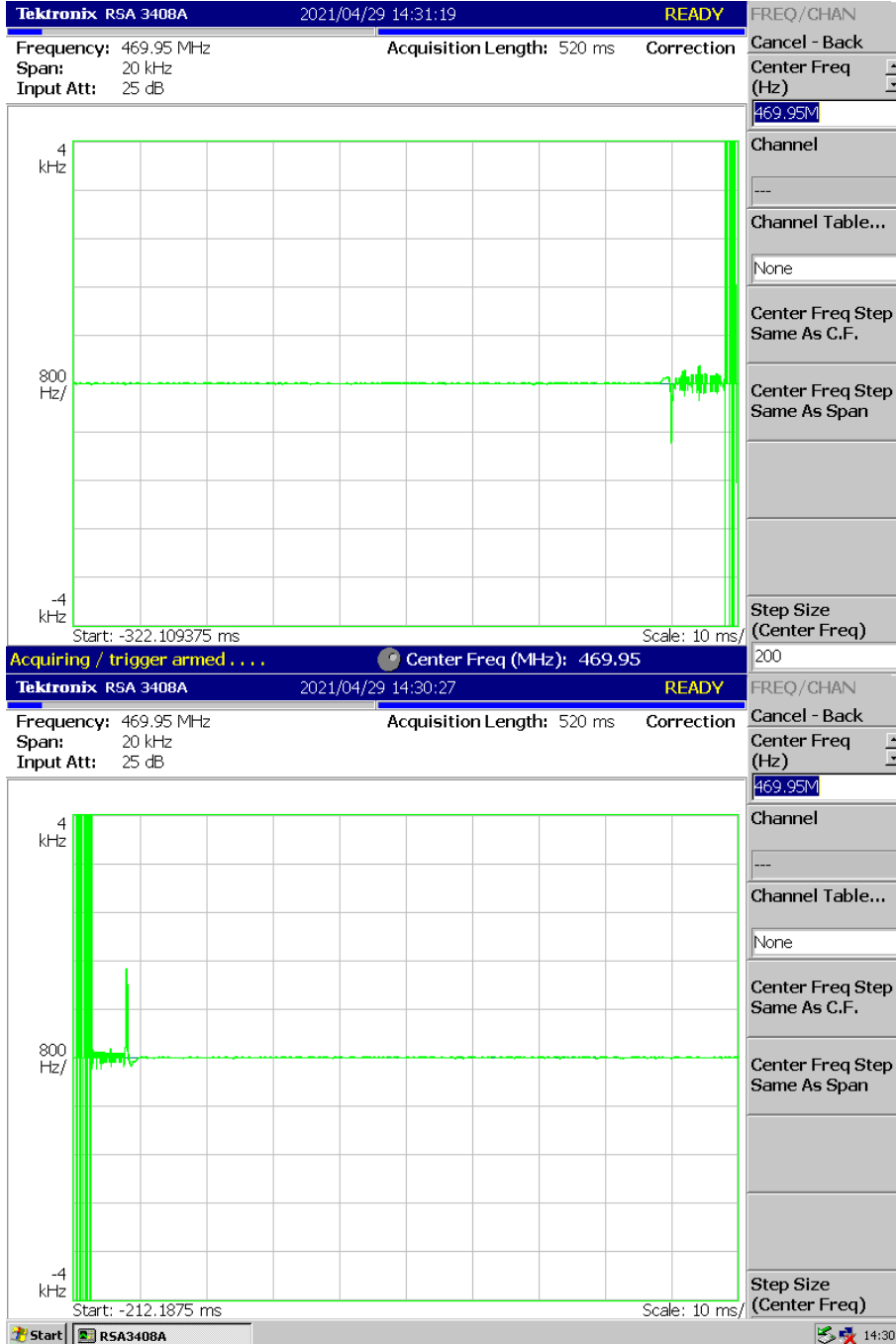

(406.15 MHz)\_Low



(429.95 MHz)\_ Low





(469.95 MHz)\_ Low



## 8.8 Unwanted Emissions : Conducted Spurious Emission

### ▣ Definition

Conducted spurious emissions are emissions at the antenna terminals on a frequency or frequencies that are outside a band sufficient to ensure transmission of information of required quality for the class of communication desired.

### ▣ TEST CONFIGURATION

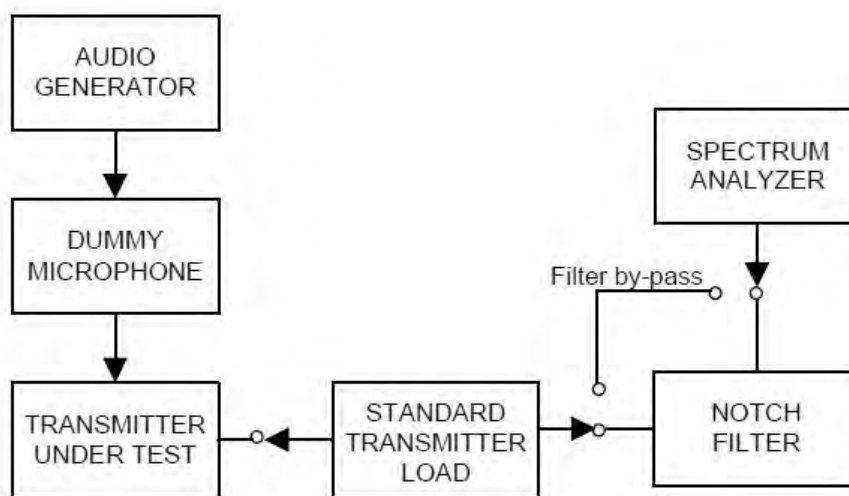

### ▣ TEST PROCEDURE

According to 2.2.13 in TIA-603-E Standard.

- e) Connect the equipment as illustrated, with the notch filter by-passed.
- f) Set the center frequency of the spectrum analyzer to the assigned transmitter frequency, key the transmitter, and set the level of the carrier to the full scale reference line.
- g) Modulate the transmitter with a 2500 Hz sine wave at an input level 16 dB greater than that necessary to produce 50% of rated system deviation. The input level shall be established at the frequency of maximum response of the audio modulation circuit.
- h) Adjust the spectrum analyzer for the following settings:
  - 1) Resolution Bandwidth = 10 kHz for spurious emissions below 1 GHz, and 1 MHz for spurious emissions above 1 GHz.
  - 2) Video Bandwidth  $\geq 3$  times the resolution bandwidth.
  - 3) Sweep Speed  $\leq 2000$  Hz per second.
  - 4) Detector Mode = mean or average power.
- e) Adjust the center frequency of the spectrum analyzer for incremental coverage of the range from:
  - 1) The lowest radio frequency generated in the equipment to the carrier frequency minus the test bandwidth (see 1.3.4.4).

- 2) The carrier frequency plus the test bandwidth to a frequency less than 2 times the carrier frequency.
- f) Record the frequencies and levels of spurious emissions from step e).
- g) Unkey the transmitter. Replace the transmitter under test with the signal generator and adjust the signal level to reproduce the frequencies and levels of every spurious emission recorded in step f). Record the signal generator levels in dBm.
- h) Insert the notch filter.
- i) Adjust the spectrum analyzer for the following settings:
  - 1) Resolution Bandwidth = 10 kHz for spurious emissions below 1 GHz, and 1 MHz for spurious emissions above 1 GHz.
  - 2) Video Bandwidth  $\geq 3$  times the resolution bandwidth.
  - 3) Sweep Speed  $\leq 2000$  Hz per second.
  - 4) Detector Mode = mean or average power.
- j) Key the transmitter. Adjust the center frequency of the spectrum analyzer for incremental coverage of the range from a frequency equal to 2 times the carrier frequency and to the tenth harmonic of the carrier frequency.

## ▣ TEST RESULTS

Type of Emission	Power	Test Frequency (MHz)	Measured Frequency (MHz)	Result (dBm)	Limit (dBm)	Margin (dB)
16K0F3E (ISED)	High Power	406.15	0.01	-35.497	-13.000	22.497
			0.17	-37.099	-13.000	24.099
			224.99	-40.917	-13.000	27.917
			1218.71	-31.271	-13.000	18.271
		429.95	0.01	-34.622	-13.000	21.622
			0.17	-35.939	-13.000	22.939
			493.03	-40.537	-13.000	27.537
			1290.71	-30.619	-13.000	17.619
		469.95	0.01	-33.095	-13.000	20.095
			0.16	-37.023	-13.000	24.023
			939.95	-36.145	-13.000	23.145
			1410.42	-29.810	-13.000	16.810

Type of Emission	Power	Test Frequency (MHz)	Measured Frequency (MHz)	Result (dBm)	Limit (dBm)	Margin (dB)
11K0F3E (FCC/ISED)	High Power	406.15	0.01	-35.016	-20.000	15.016
			0.15	-34.887	-20.000	14.887
			873.50	-41.259	-20.000	21.259
			1219.16	-32.192	-20.000	12.192
		429.95	0.01	-35.424	-20.000	15.424
			0.15	-37.102	-20.000	17.102
			885.72	-41.670	-20.000	21.670
			1290.71	-30.492	-20.000	10.492
		469.95	0.01	-35.374	-20.000	15.374
			0.16	-37.543	-20.000	17.543
			939.95	-35.855	-20.000	15.855
			1410.42	-29.684	-20.000	9.684

Type of Emission	Power	Test Frequency (MHz)	Measured Frequency (MHz)	Result (dBm)	Limit (dBm)	Margin (dB)
8K30F1E, 8K30F1D, 8K30F7W (FCC/ISED)	High Power	406.15	0.03	-62.975	-20.000	42.975
			26.34	-53.960	-20.000	33.960
			842.07	-43.701	-20.000	23.701
			1218.26	-29.618	-20.000	9.618
		429.95	0.01	-63.839	-20.000	43.839
			0.17	-53.939	-20.000	33.939
			788.23	-42.888	-20.000	22.888
			1289.81	-28.753	-20.000	8.753
		469.95	0.13	-63.583	-20.000	43.583
			2.48	-53.963	-20.000	33.963
			939.85	-40.095	-20.000	20.095
			1409.52	-30.924	-20.000	10.924

Type of Emission	Power	Test Frequency (MHz)	Measured Frequency (MHz)	Result (dBm)	Limit (dBm)	Margin (dB)
7K60FXD, 7K60FXE (FCC/ISED)	High Power	406.15	0.02	-61.833	-20.000	41.833
			1.21	-54.310	-20.000	34.310
			892.42	-42.948	-20.000	22.948
			1218.26	-29.701	-20.000	9.701
		429.95	0.01	-63.142	-20.000	43.142
			26.11	-54.989	-20.000	34.989
			864.57	-42.646	-20.000	22.646
			1289.81	-27.944	-20.000	7.944
		469.95	0.12	-64.154	-20.000	44.154
			16.09	-53.871	-20.000	33.871
			939.95	-40.393	-20.000	20.393
			1409.97	-31.168	-20.000	11.168

Type of Emission	Power	Test Frequency (MHz)	Measured Frequency (MHz)	Result (dBm)	Limit (dBm)	Margin (dB)
4K00F1E, 4K00F1D, 4K00F7W (FCC/ISED)	High Power	406.15	0.01	-63.768	-25.000	38.768
			29.48	-54.745	-25.000	29.745
			932.09	-42.843	-25.000	17.843
			1218.26	-29.177	-25.000	4.177
		429.95	0.01	-62.905	-25.000	37.905
			7.90	-54.694	-25.000	29.694
			859.92	-41.161	-25.000	16.161
			1289.81	-28.504	-25.000	3.504
		469.95	0.13	-63.661	-25.000	38.661
			28.05	-55.057	-25.000	30.057
			939.85	-37.441	-25.000	12.441
			1409.97	-30.319	-25.000	5.319

Type of Emission	Power	Test Frequency (MHz)	Measured Frequency (MHz)	Result (dBm)	Limit (dBm)	Margin (dB)
4K00F2D (FCC/ISED)	High Power	406.15	0.13	-49.11	-25.000	24.114
			0.26	-50.57	-25.000	25.570
			912.50	-40.18	-25.000	15.182
			1218.26	-30.99	-25.000	5.989
		429.95	0.12	-49.20	-25.000	24.202
			0.26	-52.03	-25.000	27.031
			884.07	-41.48	-25.000	16.484
			1289.81	-32.31	-25.000	7.312
		469.95	0.13	-49.04	-25.000	24.043
			0.86	-51.85	-25.000	26.845
			939.95	-39.32	-25.000	14.319
			4044.40	-35.90	-25.000	10.901

Plots of Unwanted Emissions : Conducted Spurious Emission

16K0F3E\_ISED

(406.15 MHz)\_High

9 kHz~150 kHz

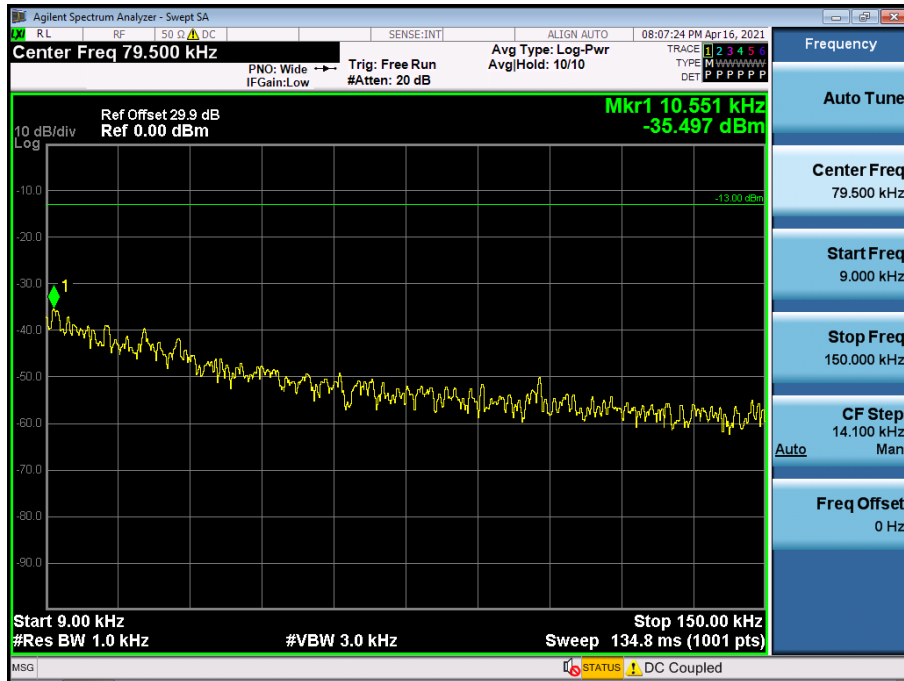

150 kHz~30 MHz

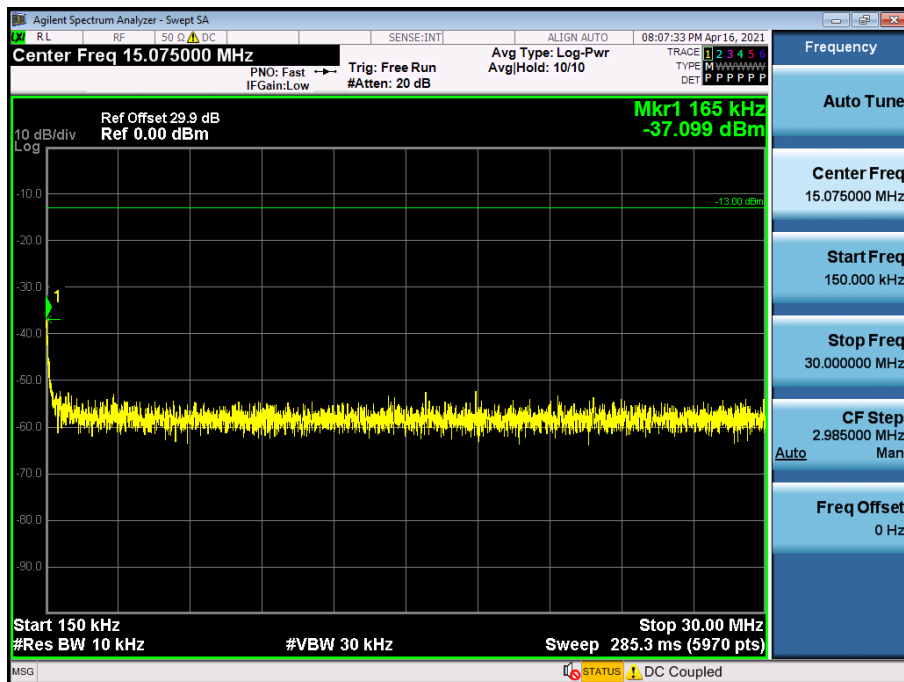

30 MHz~1 GHz

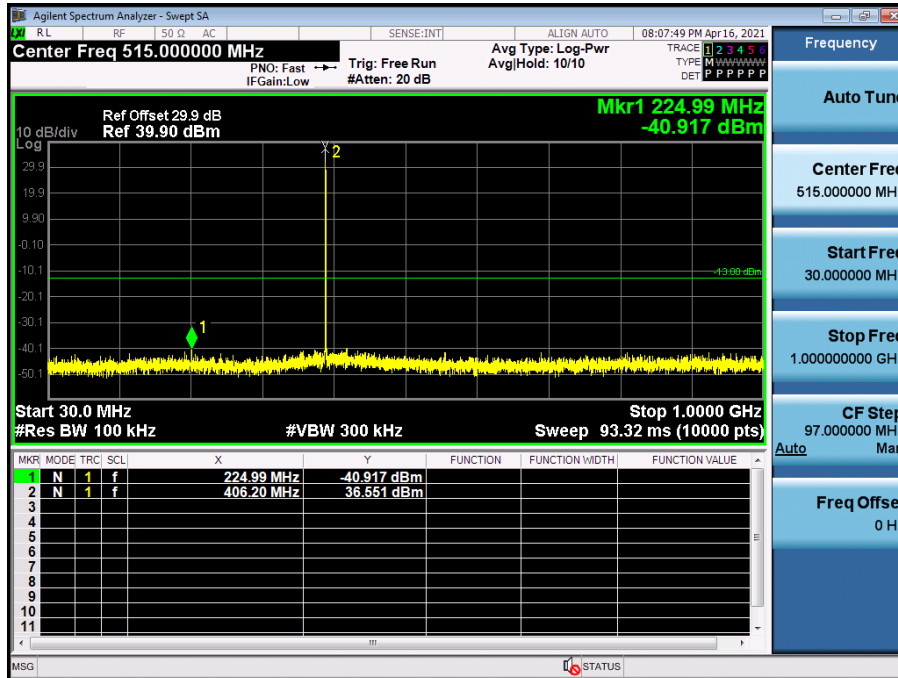

1 GHz~10 GHz

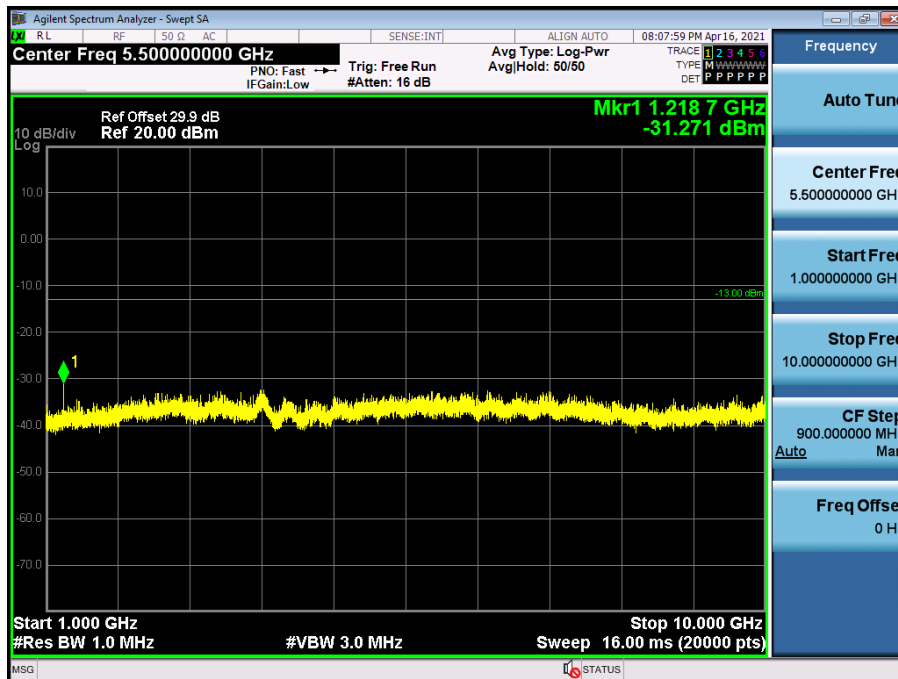



(429.95 MHz)\_High

9 kHz~150 kHz

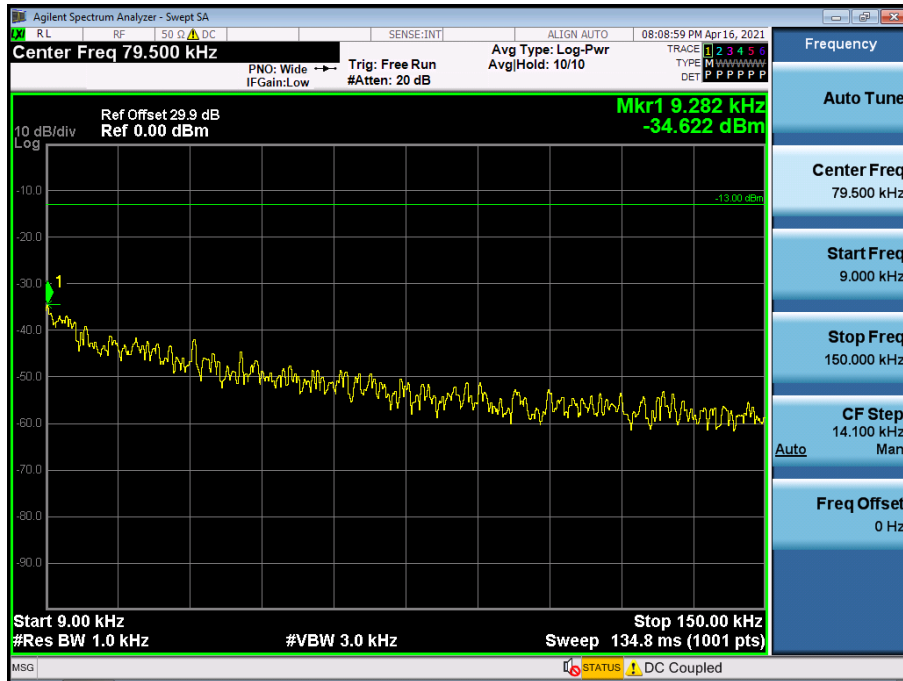

150 kHz~30 MHz

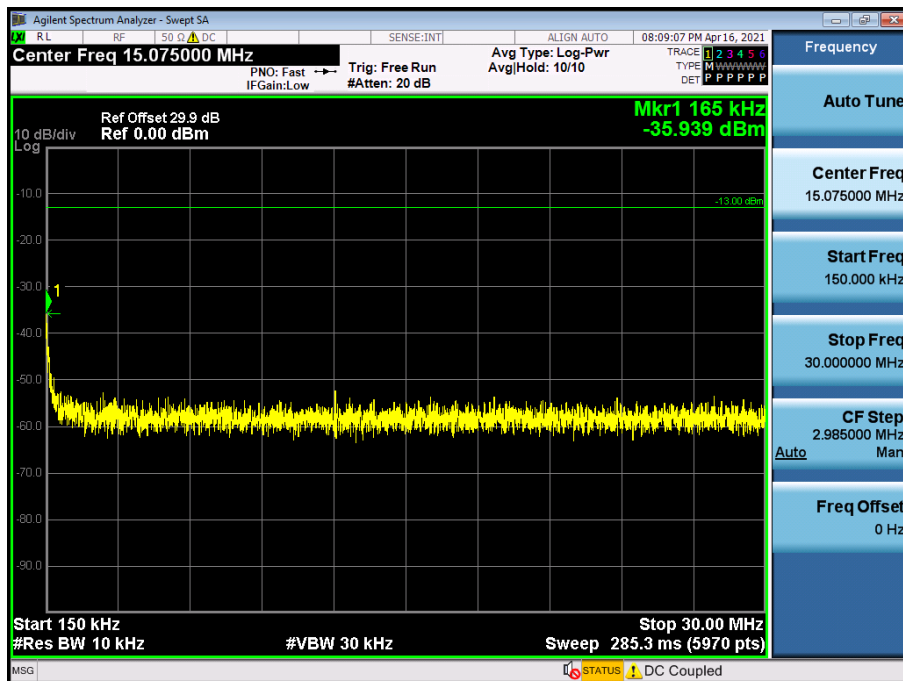

30 MHz~1 GHz

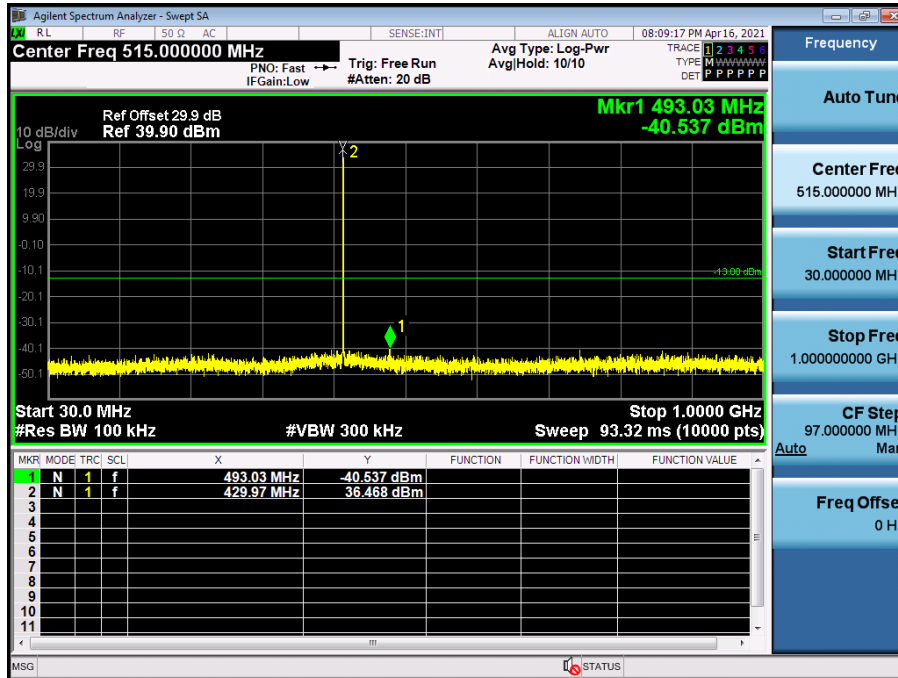

1 GHz~10 GHz

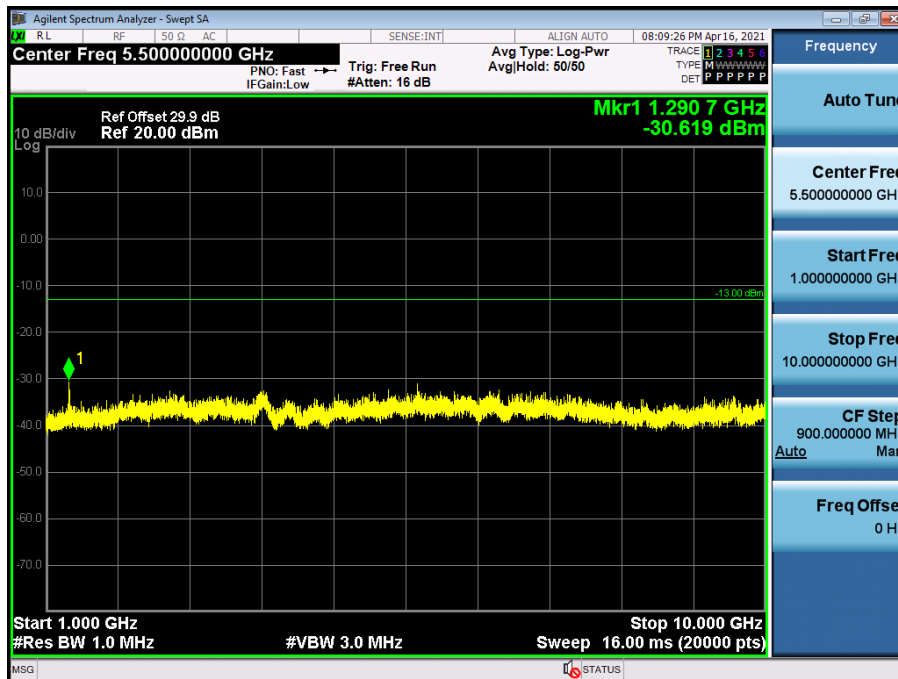

(469.95 MHz)\_High

9 kHz~150 kHz



150 kHz~30 MHz

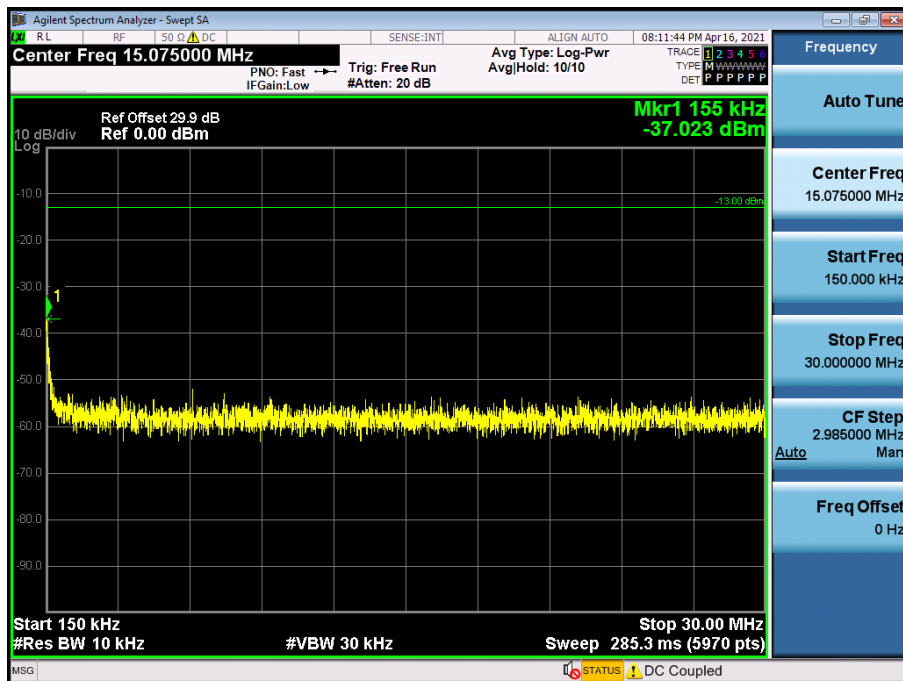

30 MHz~1 GHz

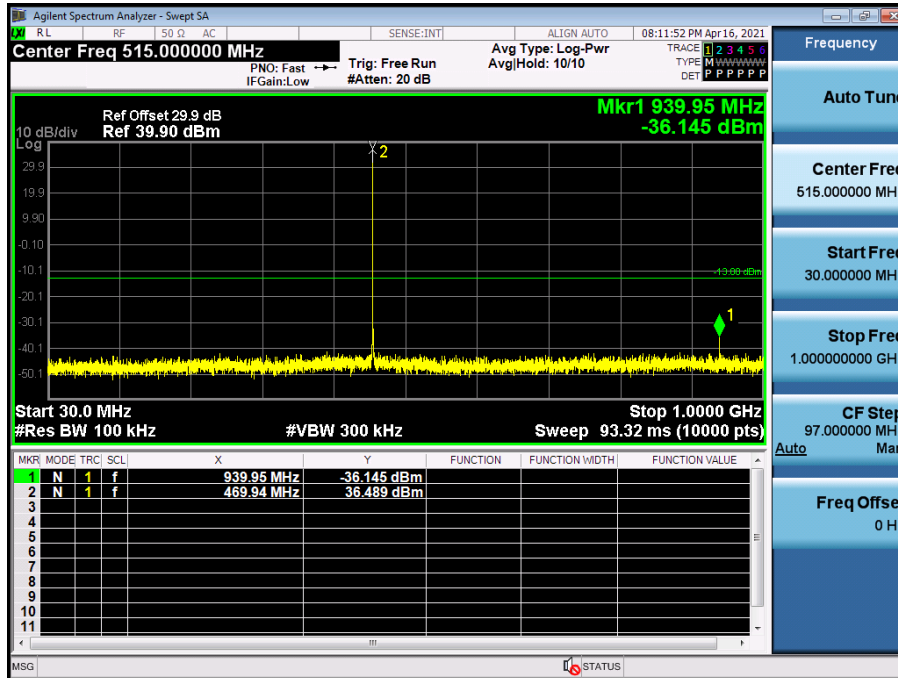

1 GHz~10 GHz

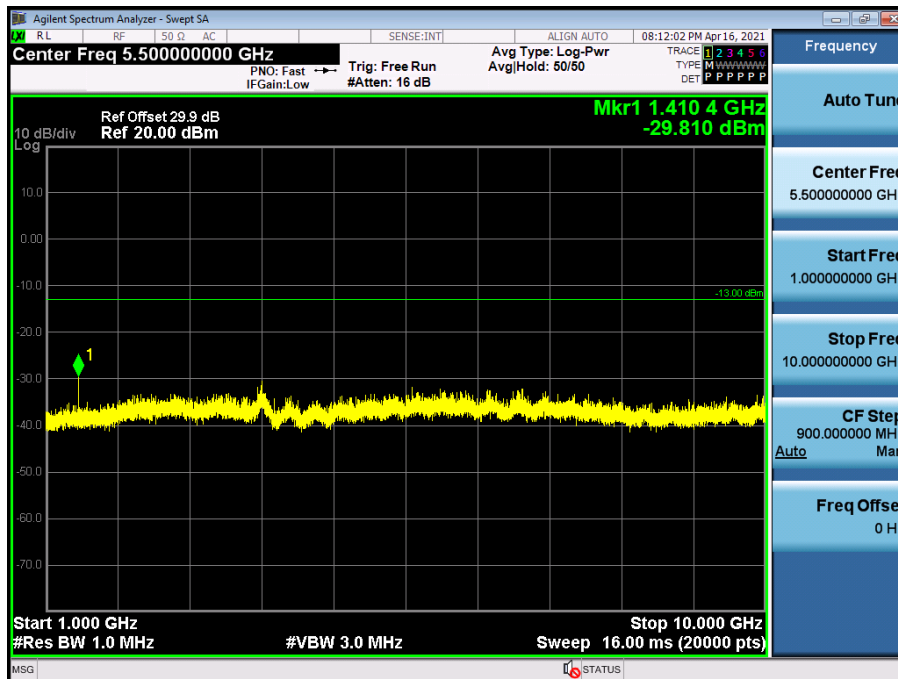

11K0F3E\_FCC/ISED

(406.15 MHz)\_High  
9 kHz~150 kHz

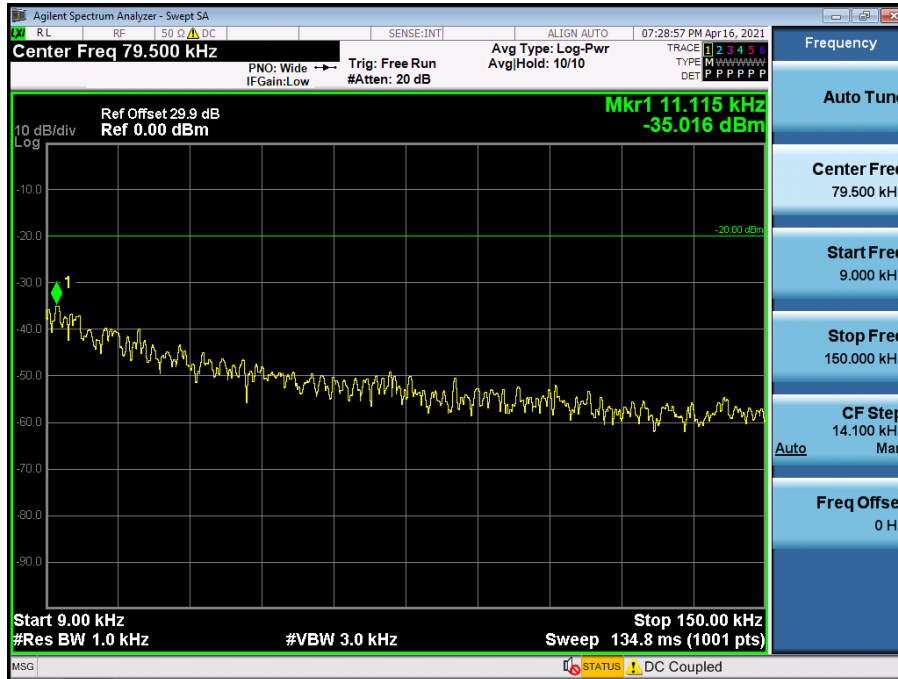

150 kHz~30 MHz

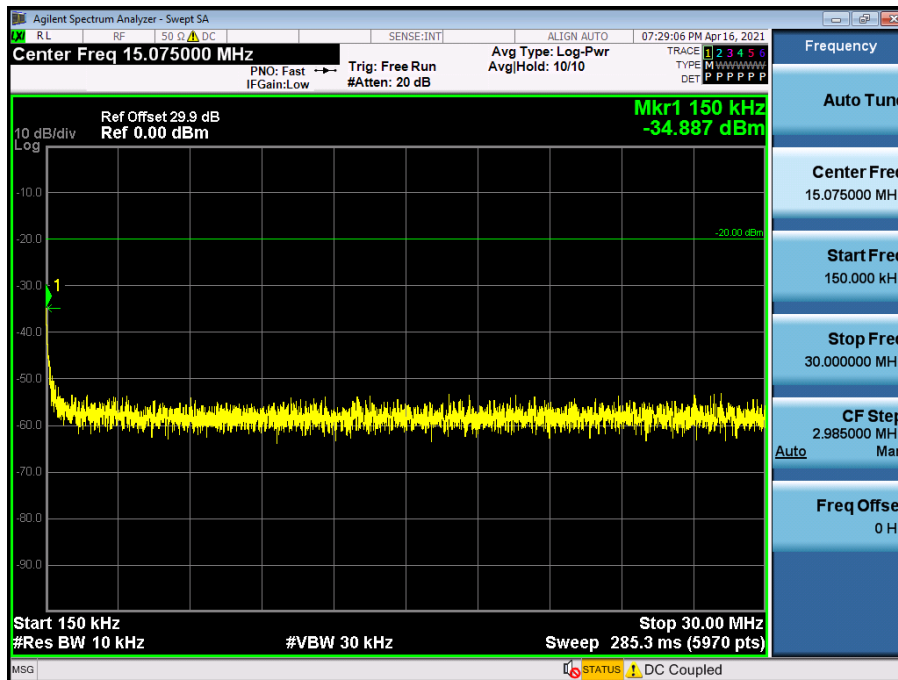

30 MHz~1 GHz

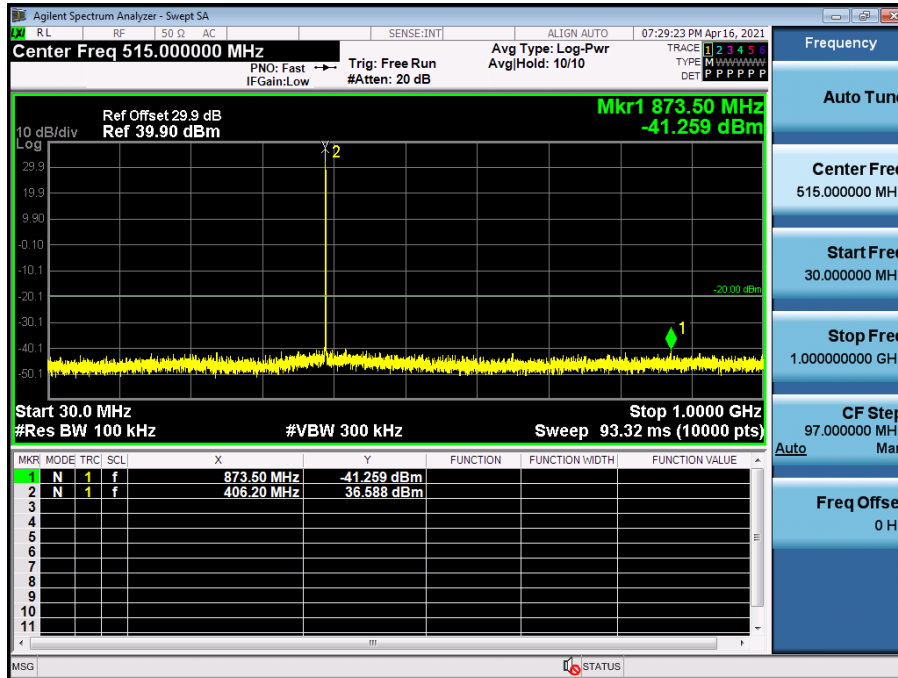

1 GHz~10 GHz

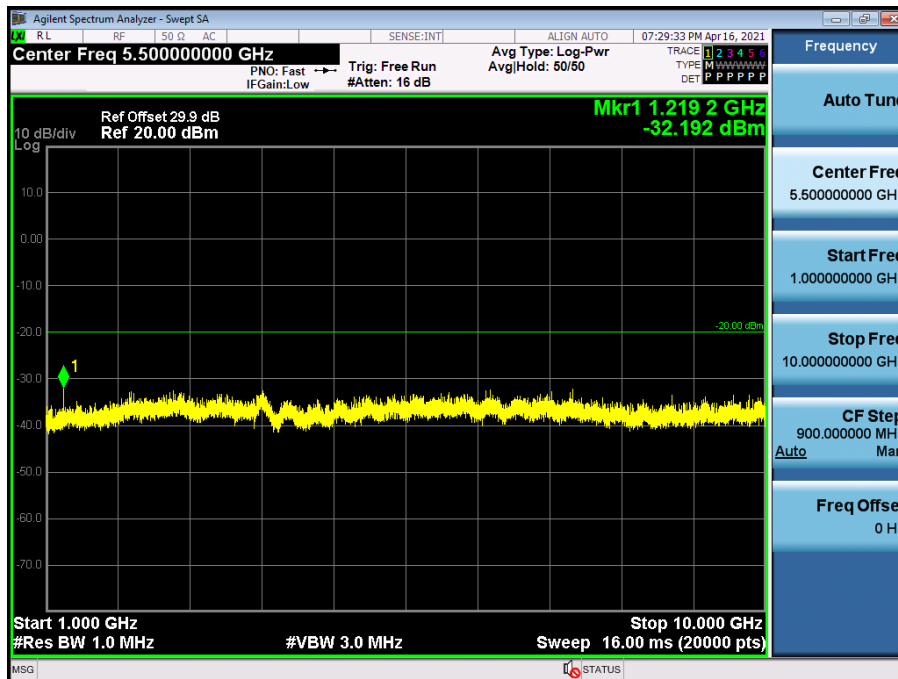

(429.95 MHz)\_High

9 kHz~150 kHz

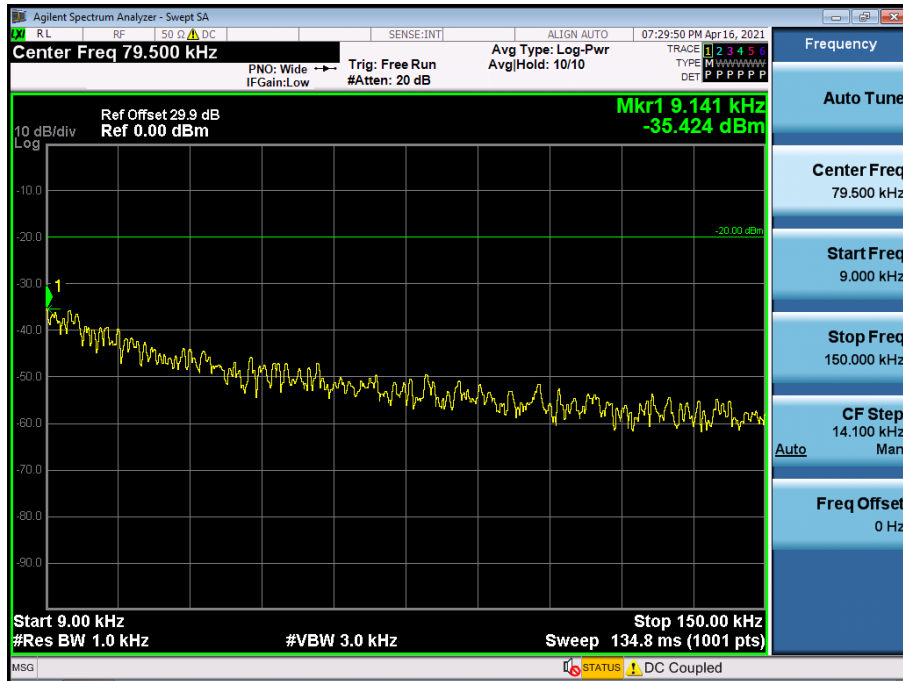

150 kHz~30 MHz

