

FCC / ISED REPORT

Certification

Applicant Name:

JVC KENWOOD CORPORATION

Address:1-16-2 Hakusan Midori-ku Yokohama-shi Kanagawa
226-8525 Japan**Date of Issue:**

March 09, 2018

Location:HCT CO., LTD.,
74, Seoicheon-ro 578beon-gil, Majang-myeon,
Icheon-si, Gyeonggi-do, 17383, Rep. of KOREA**Report No.:** HCT-RF-1802-FI002-R1**ISED Registration Number :** 5944A-5

FCC ID:	K44500000
ISED:	282F-500000
APPLICANT:	JVC KENWOOD CORPORATION

FCC Model(s): NX-P500-K
ISED Model(s): NX-P500-P
EUT Type: UHF DIGITAL TRANSCEIVER
Frequency Range: 450 MHz – 470 MHz
FCC Rule Part(s): Part 90 and Part 2
IC Rule: RSS- Gen Issue 4, RSS-119 Issue 12

The measurements shown in this report were made in accordance with the procedures specified in §2.947. I assume full responsibility for the accuracy and completeness of these measurements, and for the qualifications of all persons taking them.

HCT CO., LTD. Certifies that no party to this application has subject to a denial of Federal benefits that includes FCC benefits pursuant to section 5301 of the Anti-Drug Abuse Act of 1998, 21 U.S. C.853(a)



Report prepared by : Kwon Jeong
Engineer of Telecommunication testing center



Approved by : Jong Seok Lee
Manager of Telecommunication testing center

This report only responds to the tested sample and may not be reproduced, except in full, without written approval of the HCT Co., Ltd.

Version

TEST REPORT NO.	DATE	DESCRIPTION
HCT-RF-1802-FI002	March 06, 2018	- First Approval Report
HCT-RF-1802-FI002-R1	March 09, 2018	- Revised the standard (TIA-603-D → TIA-603-E)

Table of Contents

1. GENERAL INFORMATION	4
2. EUT DESCRIPTION	4
3. TEST METHODOLOGY	5
3.1 EUT CONFIGURATION	5
3.2 EUT EXERCISE	5
3.3 GENERAL TEST PROCEDURES	5
3.4 DESCRIPTION OF TEST MODES	6
3.5 TYPE OF EMISSION	6
4. INSTRUMENT CALIBRATION.....	7
5. FACILITIES AND ACCREDITATIONS	7
5.1 FACILITIES	7
5.2 EQUIPMENT	7
6. SUMMARY TEST OF RESULTS	8
7. TEST RESULT	10
7.1 Carrier Output Power	10
7.2 Carrier Frequency Stability	13
7.3 Occupied Bandwidth.....	19
7.4 Modulation Limiting	37
7.5 Audio Frequency Response / Audio Low Pass Filter Response.....	50
7.6 Emission Mask.....	64
7.7 Adjacent Channel Power	81
7.8 Transient Frequency Behavior.....	86
7.9 Unwanted Emissions : Conducted Spurious Emission	100
7.10 Unwanted Emissions : Radiated Spurious Emission	167
7.11 Unwanted Emissions : Receiver Radiated Spurious Emission	185
7.12 Necessary Bandwidth Calculations	186
8. LIST OF TEST EQUIPMENT	187

1. GENERAL INFORMATION

Manufacturer:	JVC KENWOOD CORPORATION
Address:	1-16-2 Hakusan Midori-ku Yokohama-shi Kanagawa 226-8525 Japan
FCC ID:	K44500000
ISED:	282F-500000
EUT Type:	UHF DIGITAL TRANSCEIVER
FCC Model(s):	NX-P500-K
ISED Model(s):	NX-P500-P
Date(s) of Tests:	February 21, 2018 ~ February 28, 2018
Place of Tests:	HCT Co., Ltd. 74, Seoicheon-ro 578beon-gil, Majang-myeon, Icheon-si, Gyeonggi-do, 17383, Rep. of KOREA

2. EUT DESCRIPTION

EUT Type	UHF DIGITAL TRANSCEIVER
FCC Model Name	NX-P500-K
ISED Model Name	NX-P500-P
Power Supply Voltage	DC 3.8 V
Output Power	2 W (Power output continuously variable to 1 W)
Battery type	KNB-81L (Li-ion Battery Pack)
Channel Bandwidth	25 kHz / 6.25 kHz / 12.5 kHz
Operating Temperature	-30 °C ~ +60 °C
Frequency Range	450 MHz – 470 MHz
Test Frequency	450.05 MHz/ 460.05 MHz/ 469.95MHz

3. TEST METHODOLOGY

TIA-603-E dated March 2016 entitled "Land Mobile FM or PM Communications Equipment Measurement and Performance Standards" were used in the measurement.

3.1 EUT CONFIGURATION

The EUT configuration for testing is installed on RF field strength measurement to meet the Commissions requirement and operating in a manner that intends to maximize its emission characteristics in a continuous normal application.

3.2 EUT EXERCISE

The EUT was operated in the engineering mode to fix the Tx frequency that was for the purpose of the measurements. According to its specifications, the EUT must comply with the requirements of the FCC Rules Part 2 and Part 90.

3.3 GENERAL TEST PROCEDURES

Radiated Emissions

Radiated emission measurements are performed in the Fully-anechoic chamber. The equipment under test is placed on a non-conductive table 3-meters away from the receive antenna in accordance with ANSI/TIA-603-E-2016. The turntable is rotated through 360 degrees, and the receiving antenna scans in order to determine the level of the maximized emission. The level and position of the maximized emission is recorded with the spectrum analyzer using a positive peak detector.

A half wave dipole is then substituted in place of the EUT. For emissions above 1GHz, a horn antenna is substituted in place of the EUT. The substitute antenna is driven by a signal generator and the previously recorded signal was duplicated.

The power is calculated by the following formula;

$$P_{d(\text{dBm})} = P_{g(\text{dBm})} - \text{cable loss (dB)} + \text{antenna gain (dB)}$$

Where: P_d is the dipole equivalent power and P_g is the generator output power into the substitution antenna.

The maximum EIRP is calculated by adding the forward power to the calibrated source plus its appropriate gain value. These steps are repeated with the receiving antenna in both vertical and horizontal polarization. the difference between the gain of the horn and an isotropic antenna are taken into consideration

3.4 DESCRIPTION OF TEST MODES

The EUT has been tested under operating condition. Test program used to control the EUT for staying in continuous transmitting is programmed.

3.5 TYPE OF EMISSION

11K0F3E	(Analogue)
16K0F3E	(Analogue)
8K30F1E, 8K30F1D, 8K30F7W	(NXDN)
4K00F1E, 4K00F1D, 4K00F7W	(NXDN)
4K00F2D	(CWID)

4. INSTRUMENT CALIBRATION

The measuring equipment, which was utilized in performing the tests documented herein, has been calibrated in accordance with the manufacturer's recommendations for utilizing calibration equipments, which is traceable to recognized national standards.

5. FACILITIES AND ACCREDITATIONS

5.1 FACILITIES

The Fully-anechoic chamber and conducted measurement facility used to collect the radiated data are located at the 74, Seoicheon-ro 578beon-gil, Majang-myeon, Icheon-si, Gyeonggi-do, Korea.

5.2 EQUIPMENT

Radiated emissions are measured with one or more of the following types of Linearly polarized antennas: tuned dipole, bi-conical, log periodic, bi-log, and/or ridged waveguide, horn. Spectrum analyzers with pre-selectors and quasi-peak detectors are used to perform radiated measurements.

Conducted emissions are measured with Line Impedance Stabilization Networks and EMI Test Receivers. Calibrated wideband preamplifiers, coaxial cables, and coaxial attenuators are also used for making measurements.

All receiving equipment conforms to CISPR Publication 16-1, "Radio Interference Measuring Apparatus and Measurement Methods."

6. SUMMARY TEST OF RESULTS

Test Description	FCC Part Section(s)	ISED Part Section(s)	Test Limit	Test Condition	Test Result
Carrier RF Output Power	§90.205(i) §2.1046(a)	RSS119 (5.4)	Varies	CONDUCTED	PASS
Unwanted Emissions	§2.1051 §90.210	RSS119 (5.8)	6.25 kHz: 55+ 10 log (P)dB 12.5 kHz: 50 + 10 log (P)dB 25 kHz: 43 + 10 log (P)dB		PASS
99% Bandwidth(ISED)	NA	RSS119 (5.5)	6.25 kHz: 6 kHz 12.5 kHz: 11.25kHz 25 kHz: 20 kHz		PASS
Carrier Frequency Stability	§90.213(a), §2.1055	RSS119 (5.3)	6.25 kHz = 2 ppm 12.5 kHz = 5 ppm 25 kHz = 5 ppm		PASS
Audio Frequency Response	§2.1047(a)	RSS119 (5.8.1)	Varies		PASS
Audio Low Pass Filter	§2.1047(a)	RSS119 (5.8.1)			PASS
Modulation Limiting	§2.1047(b)	RSS119 (5.8.1)	12.5 kHz = 2.5 kHz 25 kHz = 5 kHz		PASS
Transient Frequency Behavior	§90.214	RSS119 (5.2)	Varies		PASS
Emission Mask	§90.210, §2.1049(c)(1)	RSS119 (5.5)	<u>See Note2</u>		PASS
Adjacent Channel Power	§90.221	RSS119 (5.8.9.1)	<u>See Note3</u>		PASS
Field Strength of Spurious Radiation	§2.1053 §90.210	RSS119 (5.8)	6.25 kHz: 55+ 10 log (P)dB 12.5 kHz: 50 + 10 log (P)dB 25 kHz: 43 + 10 log (P)dB	RADIATED	PASS
Receiver Spurious Emissions	NA	RSS-Gen(7)	<u>See Note1</u>		PASS
Necessary Bandwidth	§2.202(g)	-	-	-	-

Note:

1. Receiver Spurious Emissions Limit :

Frequency (MHz)	Field Strength ($\mu\text{v/m}$ at 3 meters)
30 – 88	100
88 - 216	150
216 – 960	200
Above 960	500

2. Emission Mask Limit :

Displacement Frequency (% of Authorized Bandwidth)	Minimum Attenuation (dB)
50 to 100	25 dB
100 to 250	35 dB
>250	$43 + 10 \log_{10}(COP)$

Channel Spacing (kHz)	Displacement Frequency Range	Minimum Attenuation (dB)
12.5 & 15	>5.625 kHz to 12.5 kHz	$7.27(f_d - 2.88)$
	>12.5 kHz	Whichever is less attenuation; 70 or $50 + 10 \log_{10}(COP)$

Channel Spacing (kHz)	Displacement Frequency Range	Minimum Attenuation (dB)
6.25 & 7.5	>3.0 kHz to 4.6 kHz	Whichever is less attenuation; 65 or $30 + 16.67(f_d - 3)$ or $55 + 10 \log_{10}(COP)$
	Greater than 4.6 kHz	Whichever is less attenuation; 65 or $55 + 10 \log_{10}(COP)$

3. Adjacent Channel Power:

Frequency offset(kHz)	Maximum ACP(dBc) for devices 1 watt and less	Maximum ACP(dBc) for devices above 1 watt
25	-55	-60
50	-70	-70
75	-70	-70

7. TEST RESULT

7.1 Carrier Output Power

■ Definition

The conducted carrier power output rating for a transmitter is the power available at the output terminals of the transmitter when the output terminals are connected to the standard transmitter load.

■ TEST CONFIGURATION

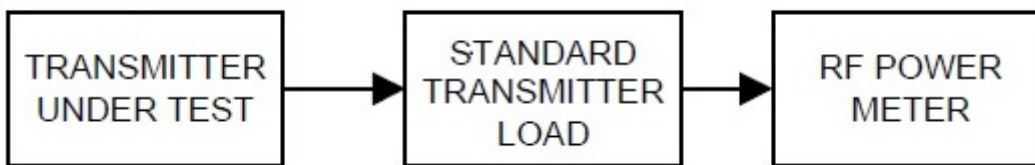

■ TEST PROCEDURE

According to 2.2.1 in TIA-603-E Standard.

- a) Connect the equipment as illustrated.
- b) Measure the transmitter output power during the defined duty cycle(see 1.3.2).
Correct for all losses in the RF path.
- c) The value recorded in step b) is the conducted carrier output power rating.

■ **TEST RESULTS**

FCC

Type of Emission	Freq.(MHz)	Carrier Output Power			
		High		Low	
		dBm	W	dBm	W
11K0F3E	450.05	33.160	2.070	30.169	1.040
	460.05	33.289	2.133	30.332	1.079
	469.95	32.970	1.982	30.198	1.047
16K0F3E	450.05	33.267	2.122	30.103	1.024
	460.05	33.236	2.107	30.309	1.074
	469.95	32.907	1.953	30.273	1.065
8K30F1E, 8K30F1D, 8K30F7W	450.05	33.260	2.118	30.258	1.061
	460.05	33.270	2.123	30.328	1.078
	469.95	32.950	1.972	30.126	1.029
4K00F1E, 4K00F1D, 4K00F7W	450.05	33.223	2.100	30.008	1.002
	460.05	33.016	2.003	30.062	1.014
	469.95	32.890	1.945	29.998	1.000
4K00F2D	450.05	32.957	1.976	30.283	1.067
	460.05	32.910	1.954	30.092	1.021
	469.95	32.502	1.779	31.221	1.325

ISED

Type of Emission	Freq.(MHz)	Carrier Output Power			
		High		Low	
		dBm	W	dBm	W
11K0F3E	450.05	33.177	2.078	30.201	1.047
	460.05	33.242	2.110	30.444	1.108
	469.95	32.923	1.960	30.059	1.014
16K0F3E	450.05	33.197	2.088	30.047	1.011
	460.05	33.283	2.130	30.285	1.068
	469.95	32.896	1.948	30.421	1.102
8K30F1E, 8K30F1D, 8K30F7W	450.05	33.237	2.107	30.353	1.085
	460.05	33.184	2.082	30.399	1.096
	469.95	32.909	1.954	30.082	1.019
4K00F1E, 4K00F1D, 4K00F7W	450.05	33.229	2.103	30.248	1.059
	460.05	33.075	2.030	30.293	1.070
	469.95	32.862	1.933	30.171	1.040
4K00F2D	450.05	32.698	1.861	30.067	1.015
	460.05	32.750	1.884	30.417	1.101
	469.95	32.406	1.740	30.030	1.007

7.2 Carrier Frequency Stability

■ Definition

The carrier frequency stability is the ability of the transmitter to maintain an assigned carrier frequency.

■ TEST CONFIGURATION

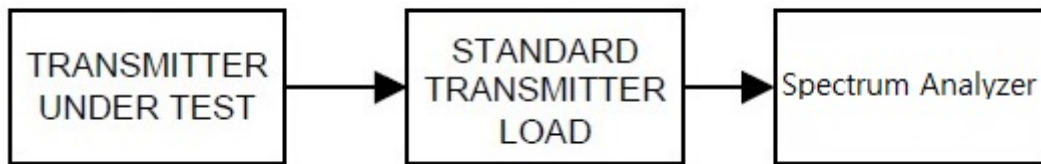

■ TEST PROCEDURE

According to 2.2.2 in TIA-603-E Standard.

- a) Connect the equipment as illustrated.
- b) Operate the equipment in standby conditions for 15 minutes before proceeding.
- c) Record the carrier frequency of the transmitter as MCF_{MHz}
- d) Calculate the ppm frequency error by the following:

$$\text{ppm error} = ((MCF_{MHz} / ACF_{MHz}) - 1) * 10^6$$

where

MCF_{MHz} is the Measured Carrier Frequency in MHz

ACF_{MHz} is the Assigned Carrier Frequency in MHz

- e) The value recorded in step d) is the carrier frequency stability.

Note

In order to simplify the report, attached data were only the worst case frequency stability.

■ TEST RESULTS**(1) Frequency Stability (Temperature Variation)**

450.05 MHz (High Power)

Temperature (Degree C)	Frequency (MHz)	Frequency stability (ppm)
-30	450.050105379	0.234150
-20	450.050021760	0.048350
-10	450.050049753	0.110550
0	450.050127581	0.283482
10	450.049902275	-0.217144
20	450.049995951	-0.008997
30	450.049921096	-0.175323
40	450.050214161	0.475862
50	450.050173439	0.385377

460.05 MHz (High Power)

Temperature (Degree C)	Frequency (MHz)	Frequency stability (ppm)
-30	460.050117535	0.255483
-20	460.050112273	0.244044
-10	460.050163812	0.356075
0	460.050067666	0.147083
10	460.049911499	-0.192374
20	460.049908282	-0.199364
30	460.049926371	-0.160047
40	460.050158777	0.345131
50	460.050207449	0.450927

469.95 MHz (High Power)

Temperature (Degree C)	Frequency (MHz)	Frequency stability (ppm)
-30	469.950121762	0.259096
-20	469.950045264	0.096317
-10	469.950058790	0.125098
0	469.950171163	0.364215
10	469.949943246	-0.120766
20	469.949901305	-0.210011
30	469.949912624	-0.185927
40	469.950158690	0.337673
50	469.950186339	0.396508

450.05 MHz (Low Power)

Temperature (Degree C)	Frequency (MHz)	Frequency stability (ppm)
-30	450.050006209	0.013797
-20	450.050104985	0.233273
-10	450.050060144	0.133638
0	450.050098949	0.219862
10	450.049989744	-0.022789
20	450.049940447	-0.132325
30	450.049959258	-0.090528
40	450.050009473	0.021049
50	450.049950718	-0.109502

460.05 MHz (Low Power)

Temperature (Degree C)	Frequency (MHz)	Frequency stability (ppm)
-30	460.050091544	0.198987
-20	460.050020924	0.045482
-10	460.049848139	-0.330096
0	460.049949175	-0.110477
10	460.050017108	0.037188
20	460.049941819	-0.126467
30	460.049990009	-0.021718
40	460.050036874	0.080153
50	460.050064617	0.140456

469.95 MHz (Low Power)

Temperature (Degree C)	Frequency (MHz)	Frequency stability (ppm)
-30	469.950089875	0.191244
-20	469.950081838	0.174141
-10	469.949897507	-0.218092
0	469.950026497	0.056383
10	469.950032408	0.068960
20	469.949952135	-0.101851
30	469.949911583	-0.188140
40	469.950067559	0.143757
50	469.950022313	0.047479

(2) Frequency Stability (Voltage Variation)

450.05 MHz (High Power)

Temperature (Degree C)	Voltage (V)	Frequency (MHz)	Frequency stability (ppm)
25+/-5	3.40	450.049990592	-0.020904
25+/-5	3.80	450.049980541	-0.043238
25+/-5	4.20	450.049985831	-0.031484

460.05 MHz (High Power)

Temperature (Degree C)	Voltage (V)	Frequency (MHz)	Frequency stability (ppm)
25+/-5	3.40	460.049907781	-0.200453
25+/-5	3.80	460.049909453	-0.196820
25+/-5	4.20	460.049909020	-0.197761

469.95 MHz (High Power)

Temperature (Degree C)	Voltage (V)	Frequency (MHz)	Frequency stability (ppm)
25+/-5	3.40	469.949900313	-0.212123
25+/-5	3.80	469.949901539	-0.209513
25+/-5	4.20	469.949899899	-0.213003

450.05 MHz (Low Power)

Temperature (Degree C)	Voltage (V)	Frequency (MHz)	Frequency stability (ppm)
25+/-5	3.40	450.049941194	-0.130666
25+/-5	3.80	450.049940869	-0.131389
25+/-5	4.20	450.049940330	-0.132584

460.05 MHz (Low Power)

Temperature (Degree C)	Voltage (V)	Frequency (MHz)	Frequency stability (ppm)
25+/-5	3.40	460.049941775	-0.126563
25+/-5	3.80	460.049943378	-0.123078
25+/-5	4.20	460.049942804	-0.124325

469.95 MHz (Low Power)

Temperature (Degree C)	Voltage (V)	Frequency (MHz)	Frequency stability (ppm)
25+/-5	3.40	469.949954691	-0.096412
25+/-5	3.80	469.949955619	-0.094437
25+/-5	4.20	469.949954410	-0.097010

7.3 Occupied Bandwidth

■ Definition

The transmitter sideband spectrum denotes the sideband power produced at a discrete frequency separation from the carrier up to the test bandwidth (see TIA-603-E Section 1.3.4.4) due to all sources of unwanted noise within the transmitter in a modulated condition.

■ TEST CONFIGURATION

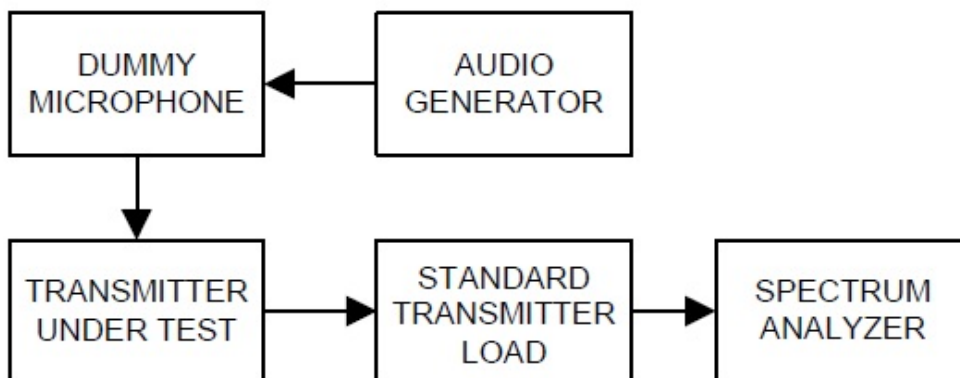

■ TEST PROCEDURE

According to TIA-603-E Section 2.2.11.2 / RSS-119 Section 5.5

- a) For EUT supporting audio modulation, the audio signal generator was adjusted to the frequency of maximum response and with output level set for +/- 2.5 kHz deviation (or 50 % modulation). (FM modulation).
- b) With level constant, the signal level was increased 16 dB.
- c) For EUT supporting digital modulation, the digital modulation mode was operated to its maximum extent.
- d) Adjust the spectrum analyzer for the following setting:
 - 1) RBW : 100Hz (Authorized Band 6 kHz),
100Hz (Authorized Band 11.25 kHz),
300Hz (Authorized Band 20 kHz)
 - 2) VBW : Video Bandwidth at least 10 times the resolution bandwidth.
 - 4) Sweep Speed : Sweep Speed slow enough to maintain measurement calibration.
 - 5) Sampling Time : 10 times
 - 6) Detector Mode = Positive Peak.
- e) The occupied Bandwidth was measured with the Spectrum Analyzer controls set as shown on the test results.

■ **TEST RESULTS**

Conducted 99% Bandwidth Measurements for 11K0F3E

11K0F3E Mode		Measured Bandwidth [kHz]	Setting
Frequency [MHz]	Channel bandwidth		
450.05	12.5 kHz	9.917	High Power
460.05		9.926	
469.95		9.924	
450.05	12.5 kHz	9.924	Low Power
460.05		9.924	
469.95		9.924	

Conducted 99% Bandwidth Measurements for 16K0F3E

16K0F3E Mode		Measured Bandwidth [kHz]	Setting
Frequency [MHz]	Channel bandwidth		
450.05	25.0 kHz	14.684	High Power
460.05		14.679	
469.95		14.686	
450.05	25.0 kHz	14.682	Low Power
460.05		14.676	
469.95		14.678	

Conducted 99% Bandwidth Measurements for 8K30F1E, 8K30F1D, 8K30F7W

8K30F1E, 8K30F1D, 8K30F7W Mode		Measured Bandwidth [kHz]	Setting
Frequency [MHz]	Channel bandwidth		
450.05	12.5 kHz	7.689	High Power
460.05		7.699	
469.95		7.714	
450.05	12.5 kHz	7.720	Low Power
460.05		7.763	
469.95		7.761	

Conducted 99% Bandwidth Measurements for 4K00F1E, 4K00F1D, 4K00F7W

4K00F1E, 4K00F1D, 4K00F7W Mode		Measured Bandwidth [kHz]	Setting
Frequency [MHz]	Channel bandwidth		
450.05	6.25 kHz	3.553	High Power
460.05		3.469	
469.95		3.656	
450.05	6.25 kHz	3.577	Low Power
460.05		3.659	
469.95		3.557	

Conducted 99% Bandwidth Measurements for 4K00F2D

4K00F2D Mode		Measured Bandwidth [kHz]	Setting
Frequency [MHz]	Channel bandwidth		
450.05	6.25 kHz	3.264	High Power
460.05		3.264	
469.95		3.265	
450.05	6.25 kHz	3.265	Low Power
460.05		3.263	
469.95		3.262	

■ Plots of 99% Bandwidth

(11K0F3E _ 450.05 MHz)_High

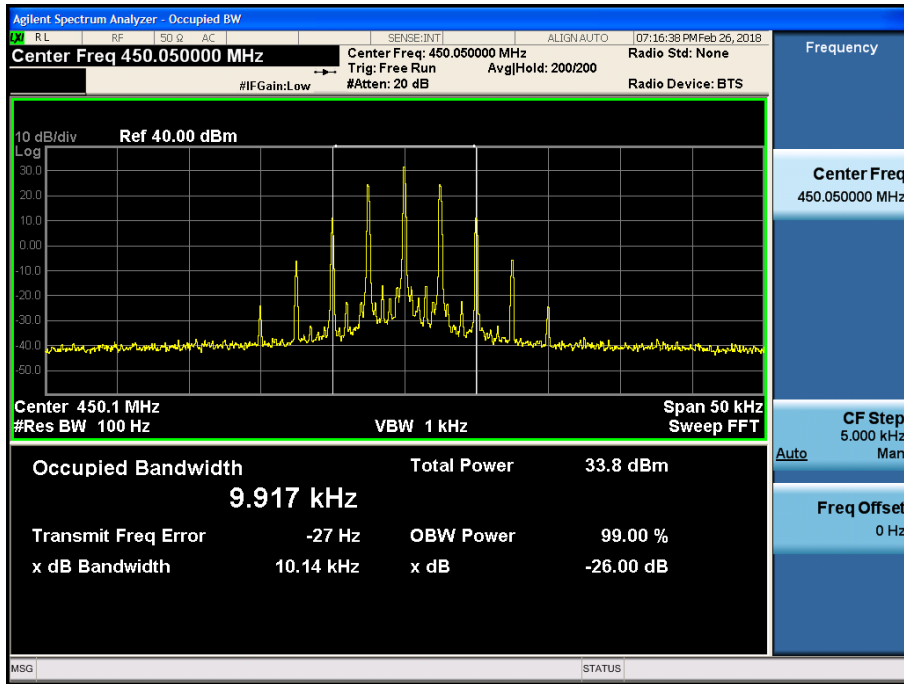

(11K0F3E _ 460.05 MHz)_High

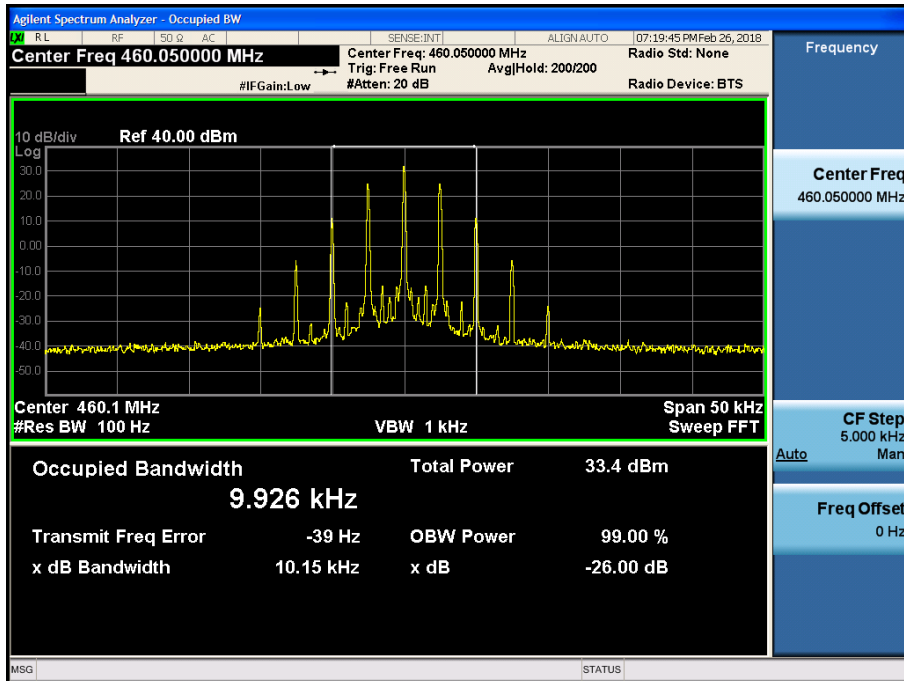

(11K0F3E _ 469.95 MHz)_High

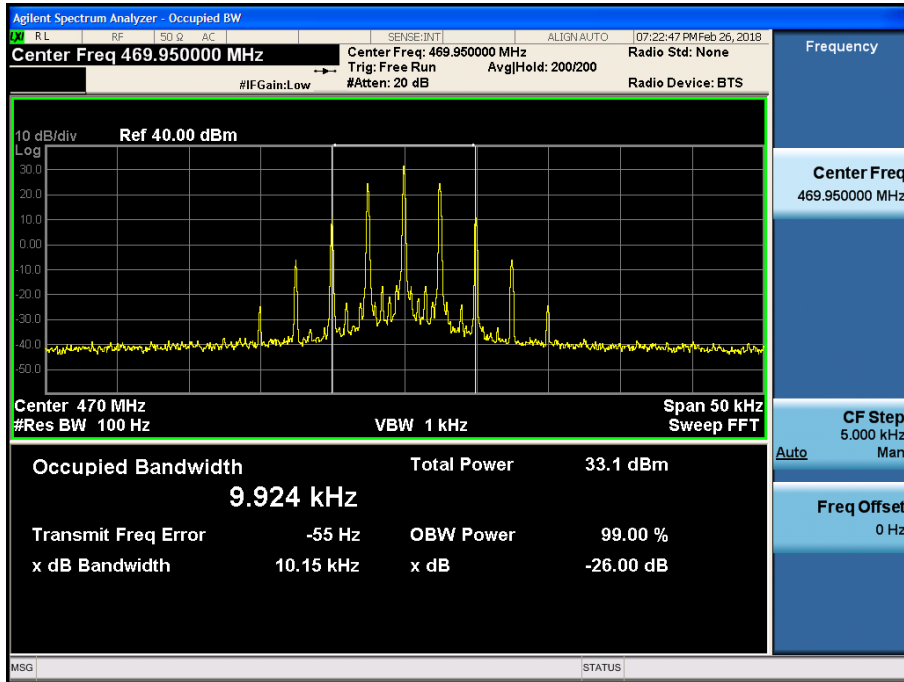

(11K0F3E _ 450.05 MHz)_Low

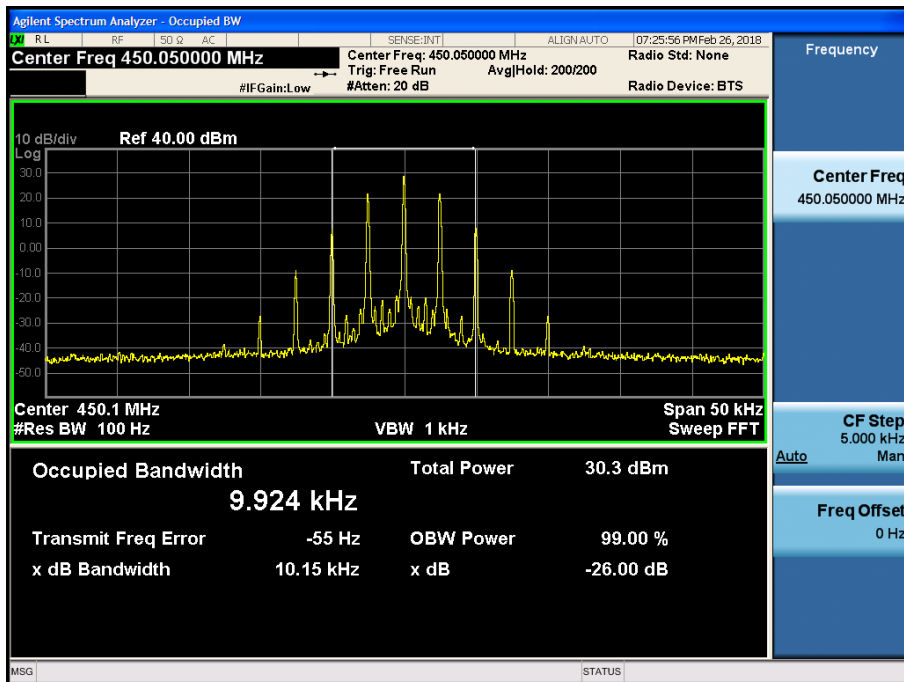

(11K0F3E _ 460.05 MHz)_Low

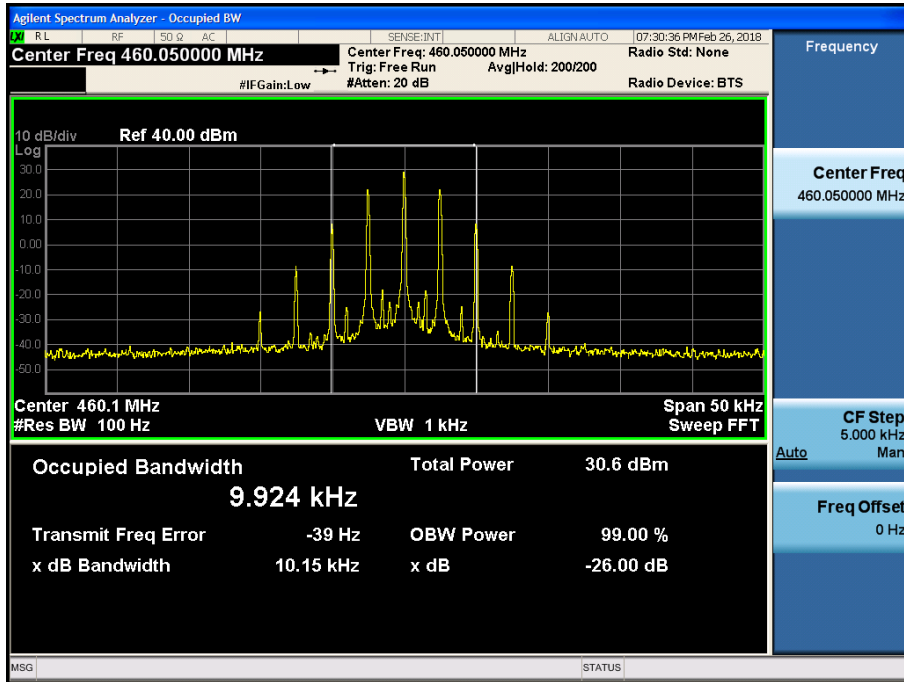

(11K0F3E _ 469.95 MHz)_Low

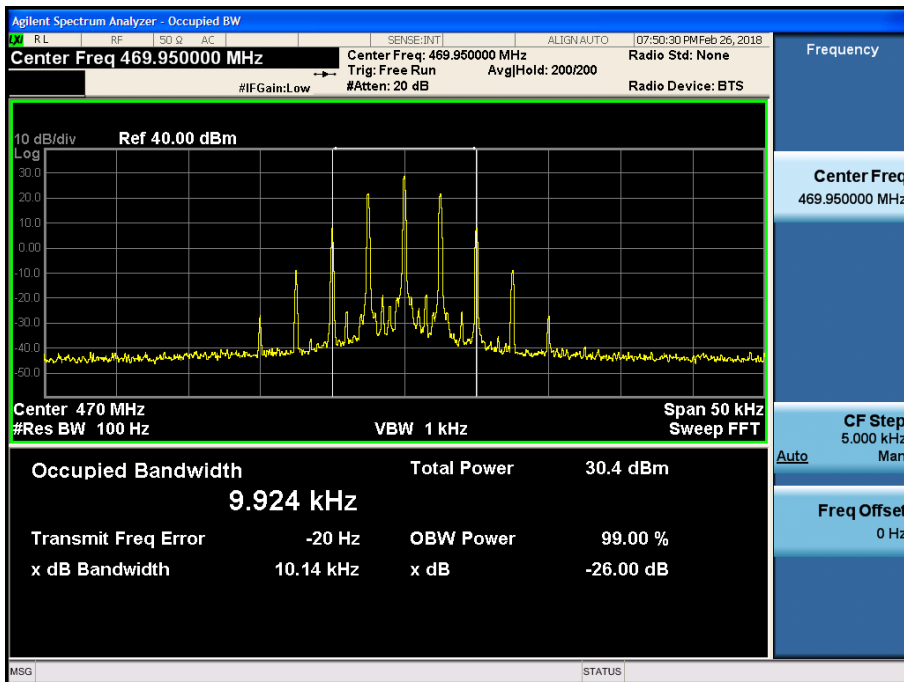

(16K0F3E _ 450.05 MHz)_High

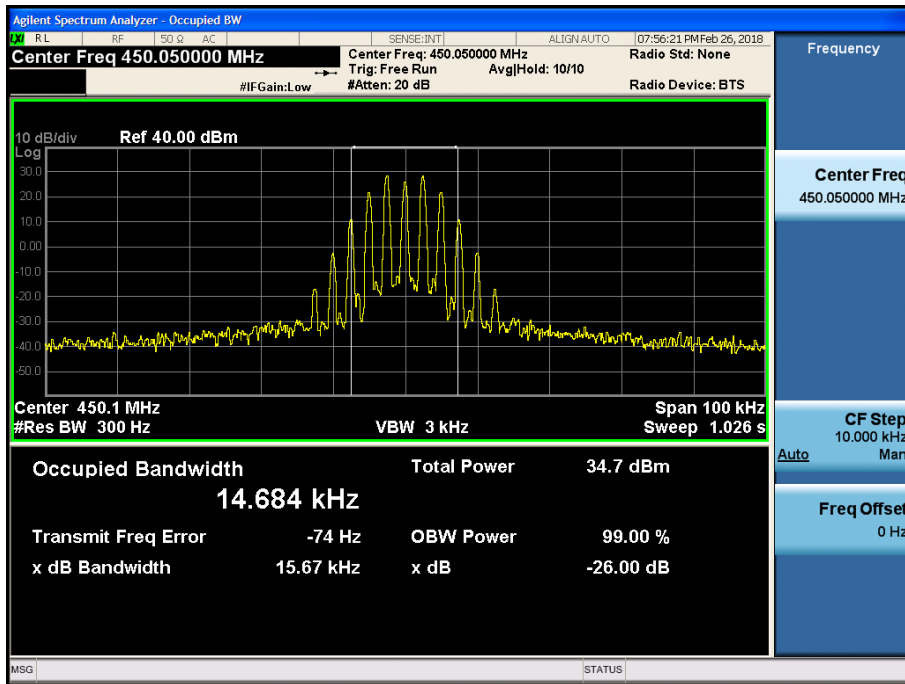

(16K0F3E _ 460.05 MHz)_High

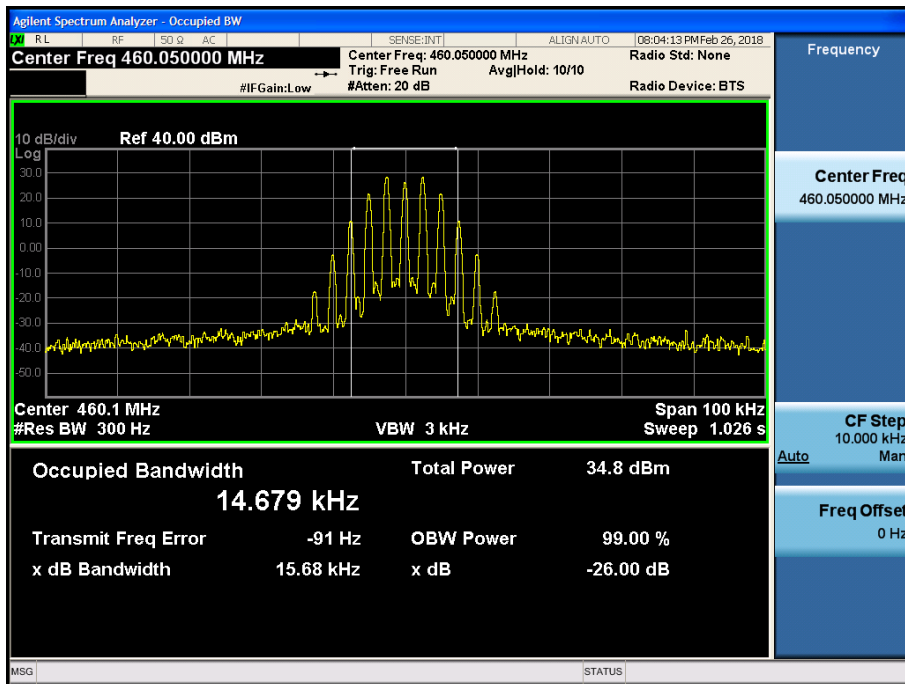

(16K0F3E _ 469.95 MHz)_High

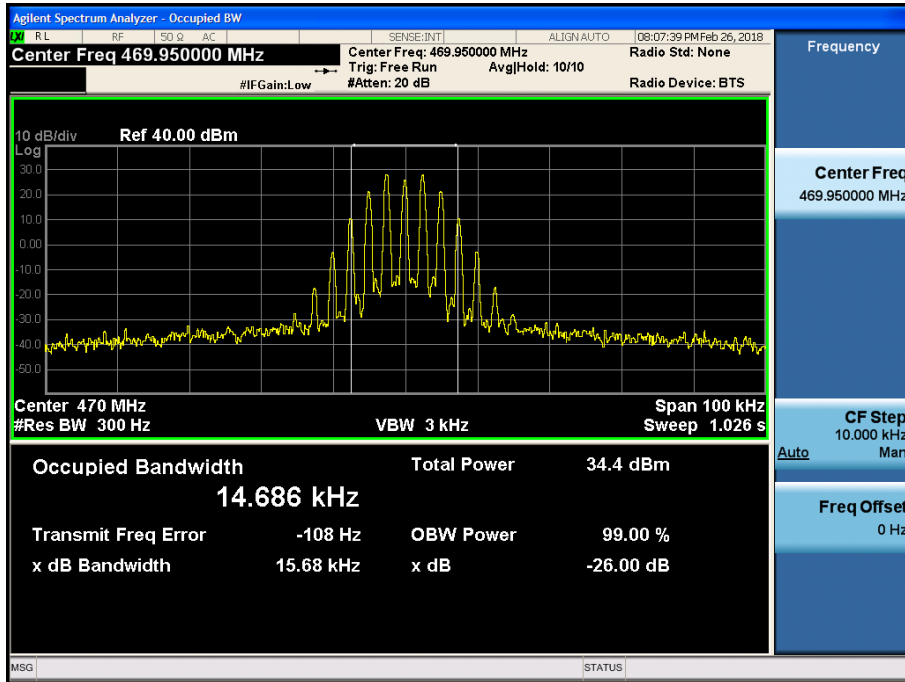

(16K0F3E _ 450.05 MHz)_Low

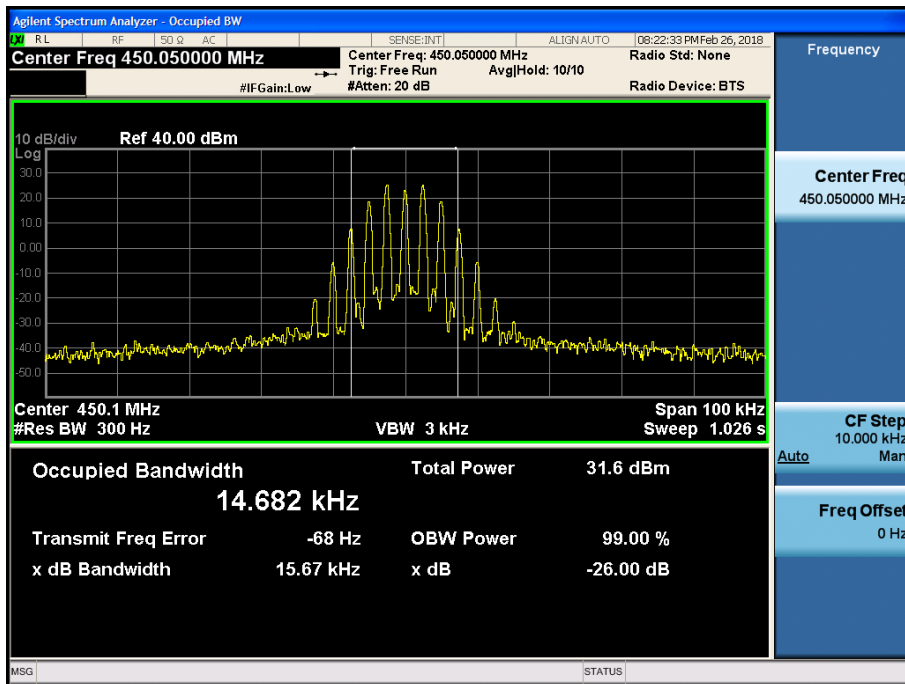

(16K0F3E _ 460.05 MHz)_Low

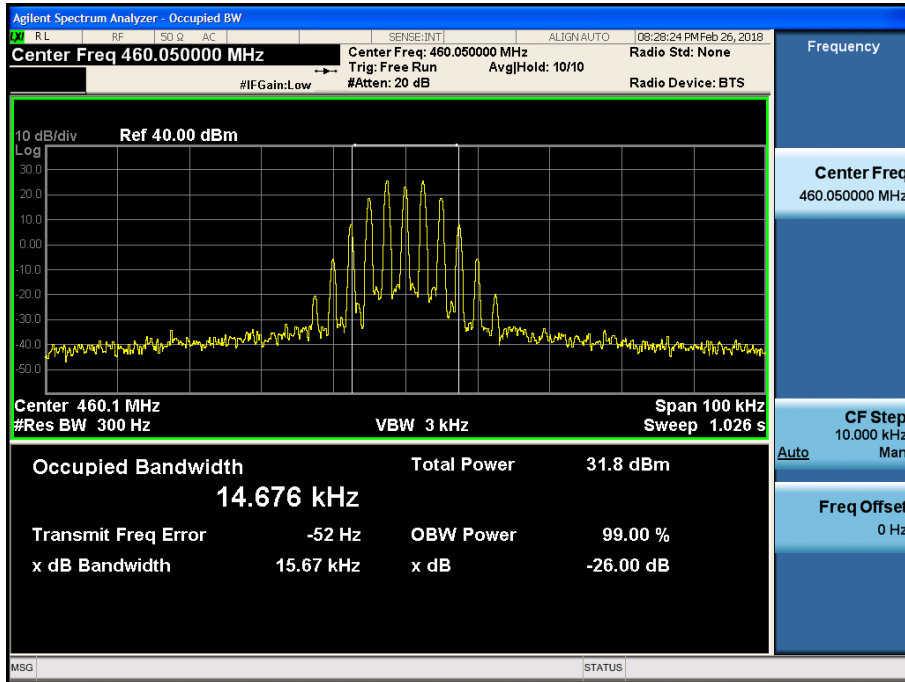

(16K0F3E _ 469.95 MHz)_Low

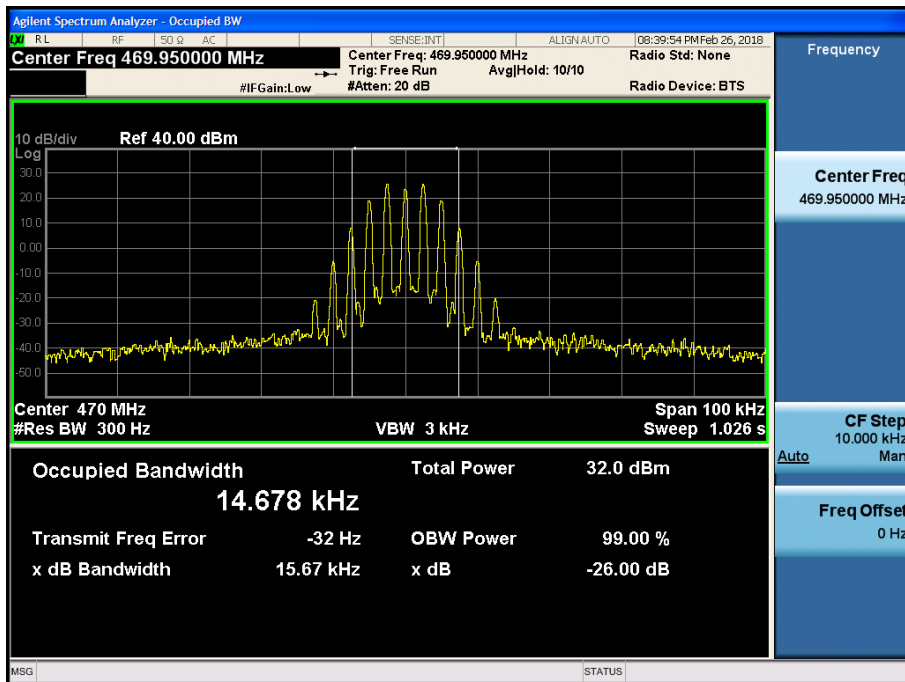

(8K30F1E, 8K30F1D, 8K30F7W _ 450.05 MHz)_High

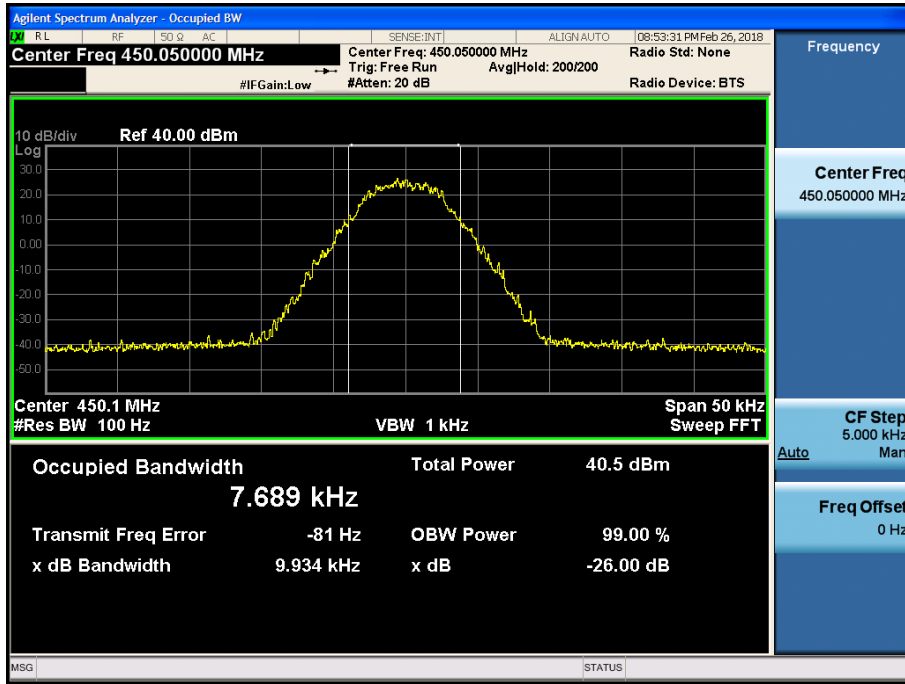

(8K30F1E, 8K30F1D, 8K30F7W _ 460.05 MHz)_High

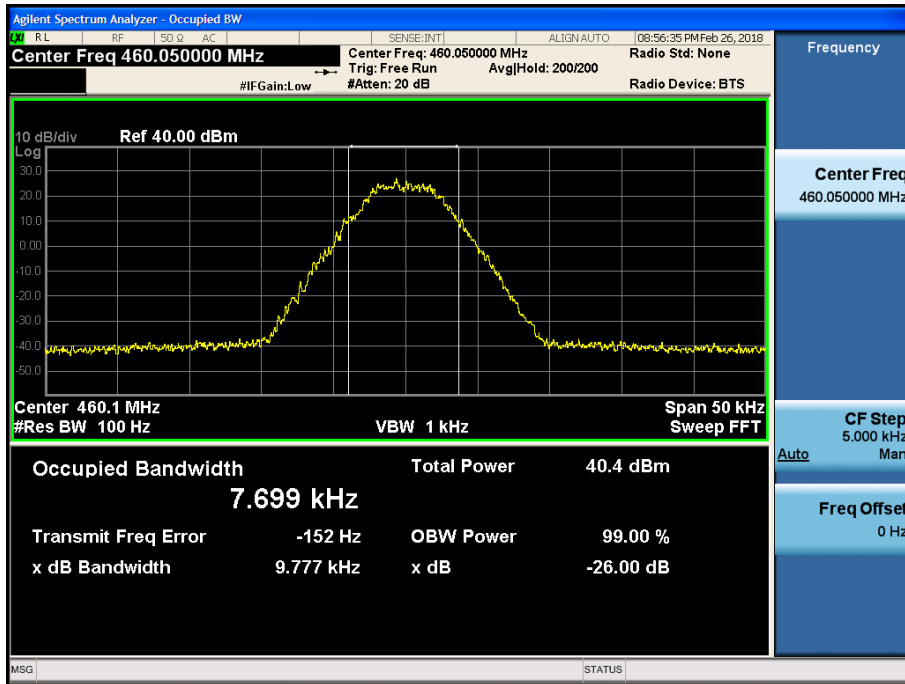

(8K30F1E, 8K30F1D, 8K30F7W _ 469.95 MHz)_High

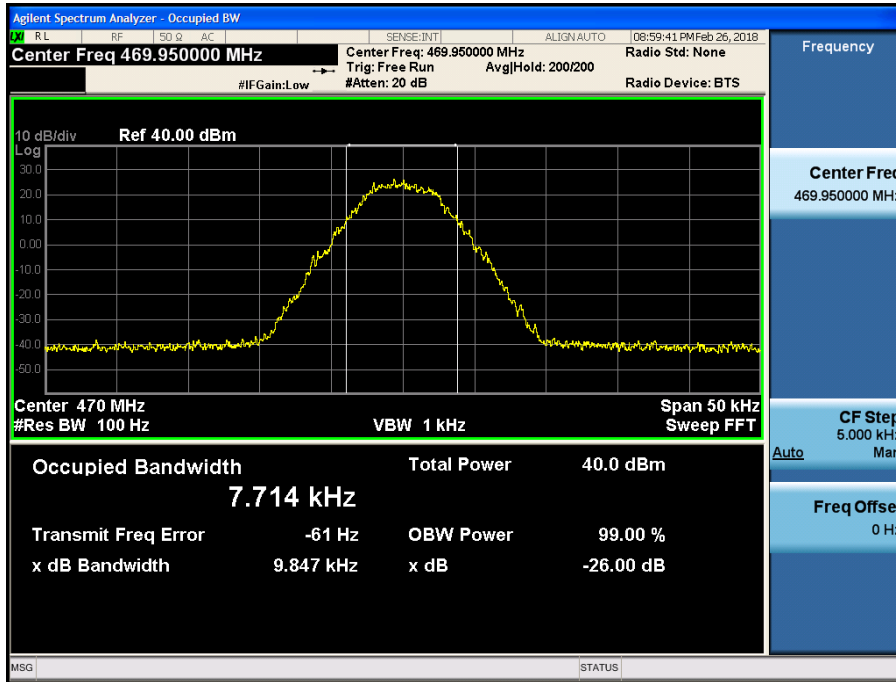

(8K30F1E, 8K30F1D, 8K30F7W _ 450.05 MHz)_Low

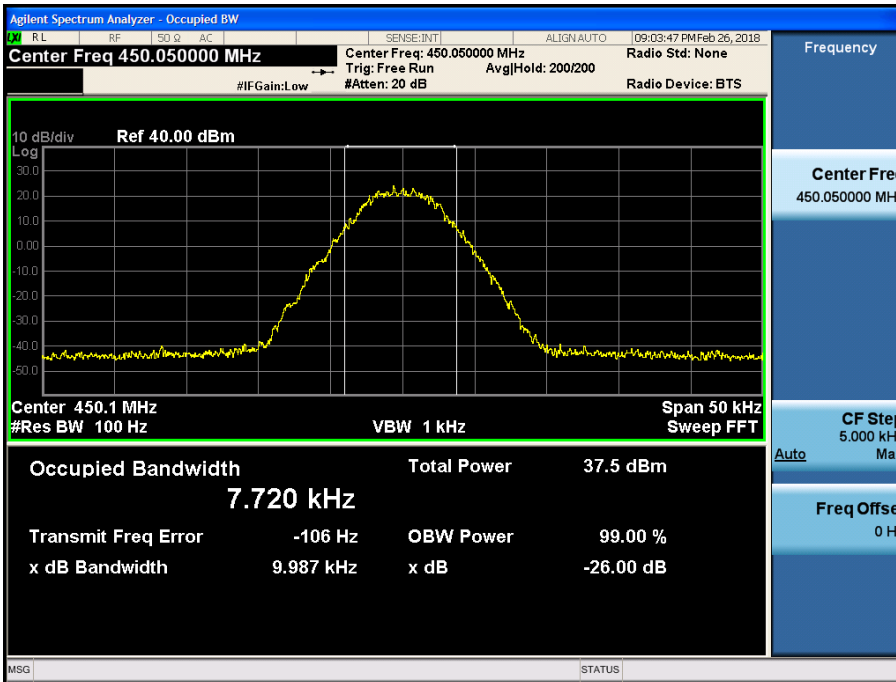

(8K30F1E, 8K30F1D, 8K30F7W _ 460.05 MHz)_Low

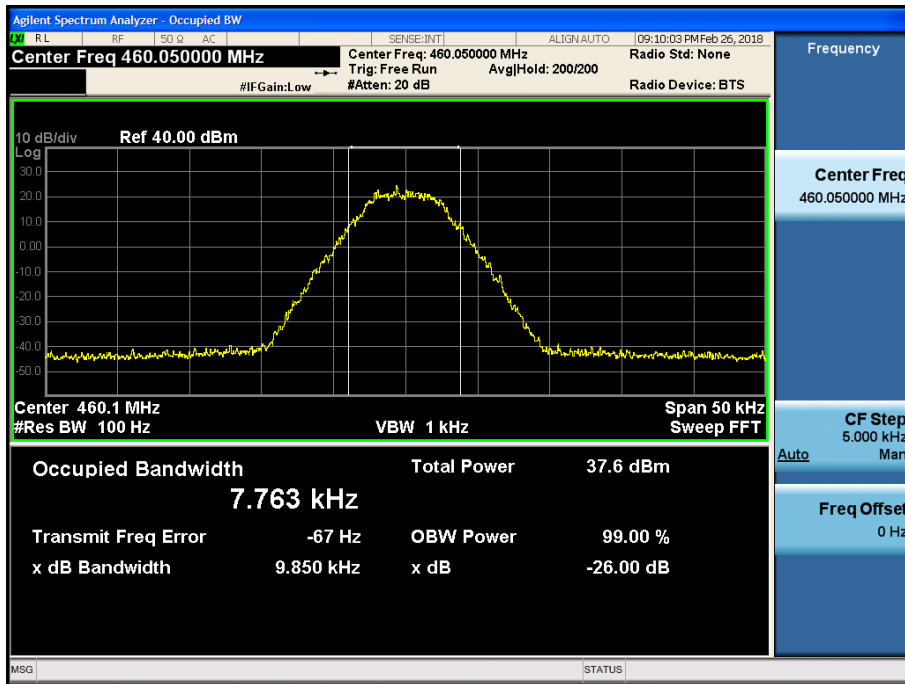

(8K30F1E, 8K30F1D, 8K30F7W _ 469.95 MHz)_Low

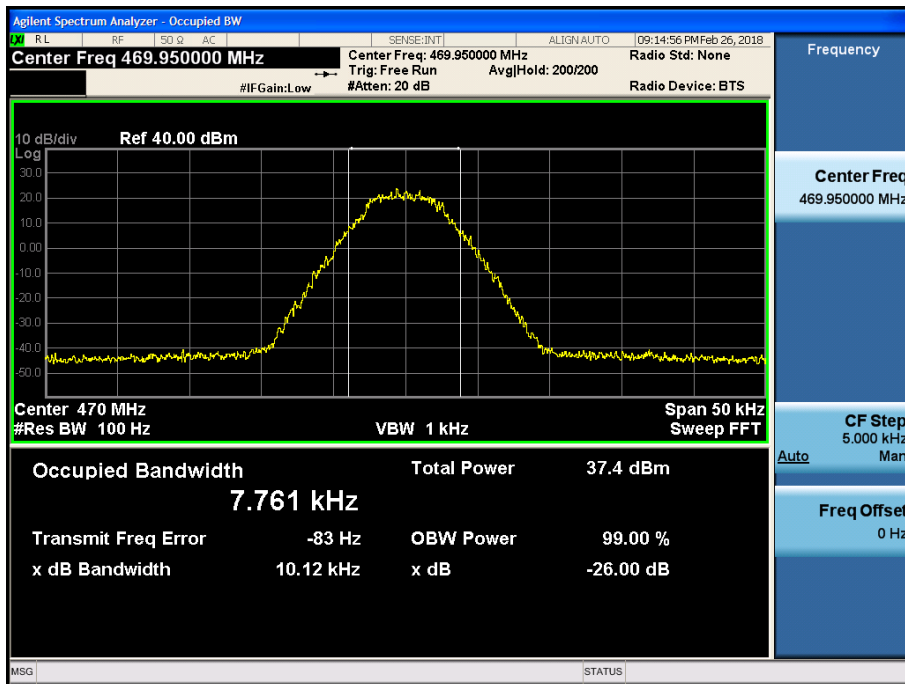

(4K00F1E, 4K00F1D, 4K00F7W _ 450.05 MHz)_High

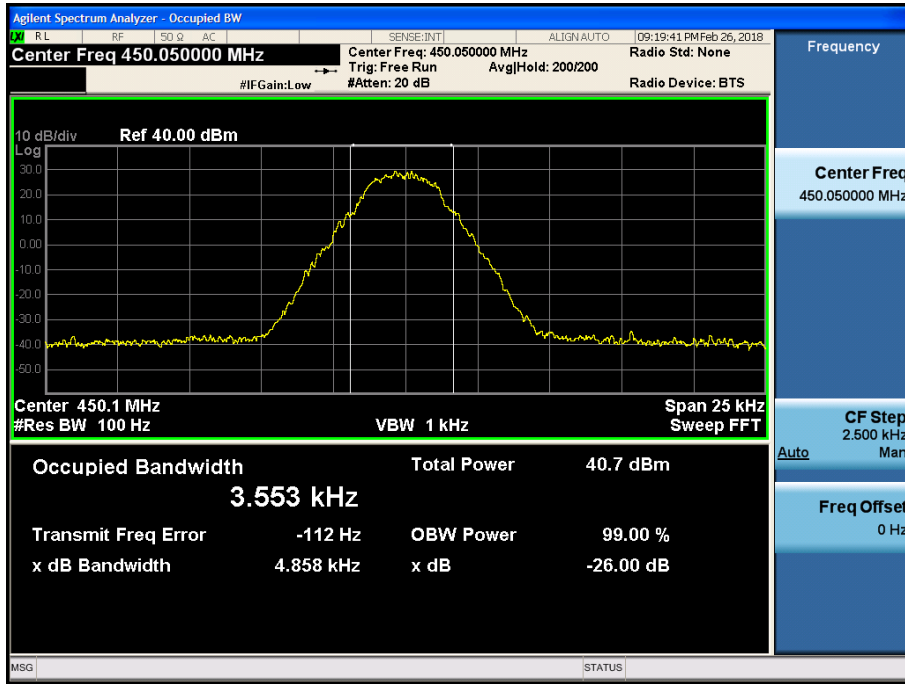

(4K00F1E, 4K00F1D, 4K00F7W _ 460.05 MHz)_High

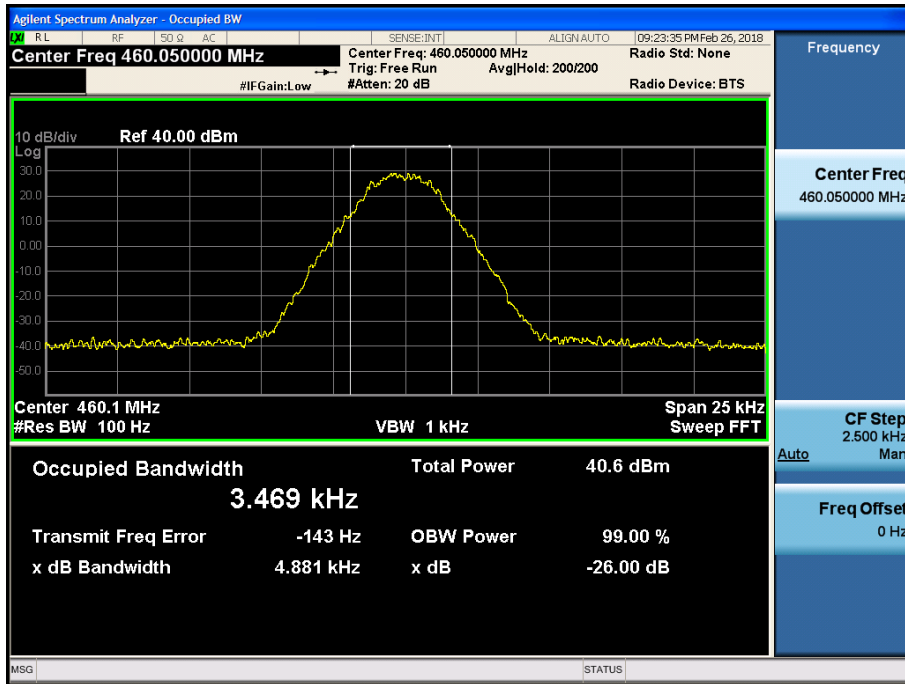

(4K00F1E, 4K00F1D, 4K00F7W _ 469.95 MHz)_High

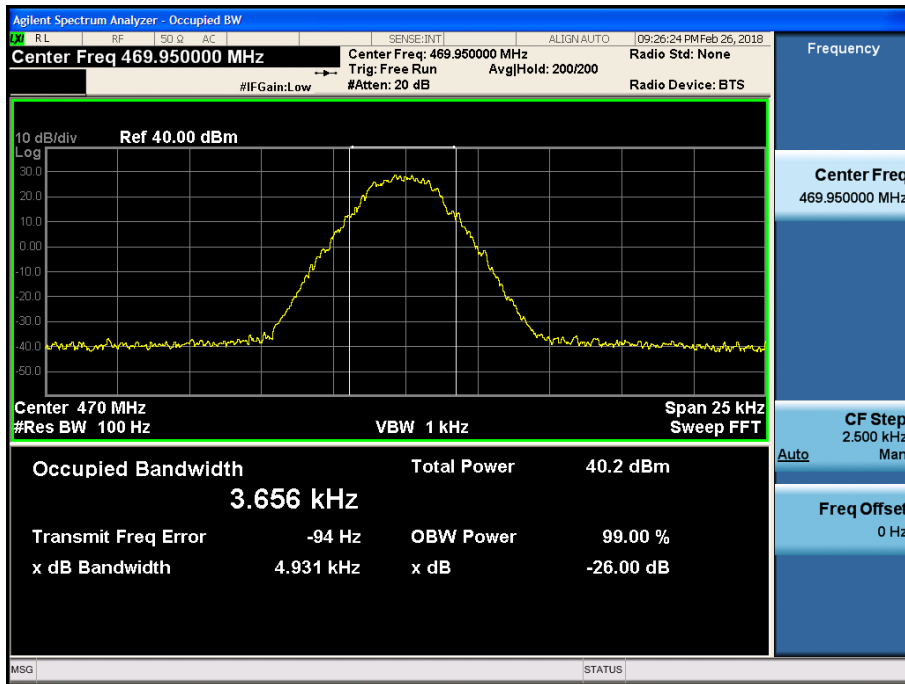

(4K00F1E, 4K00F1D, 4K00F7W _ 450.05 MHz)_Low

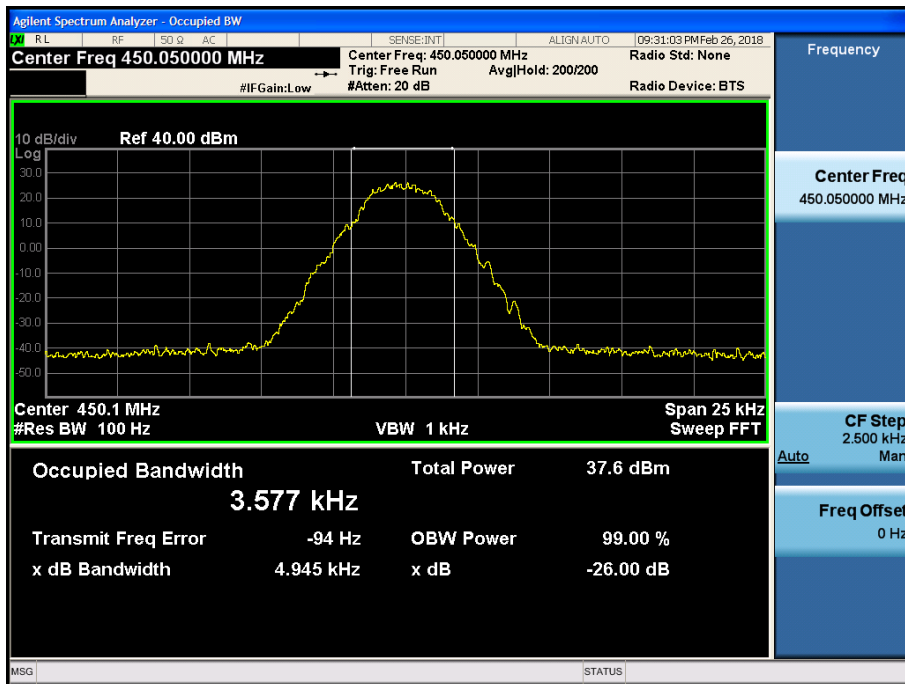

(4K00F1E, 4K00F1D, 4K00F7W _ 460.05 MHz)_Low

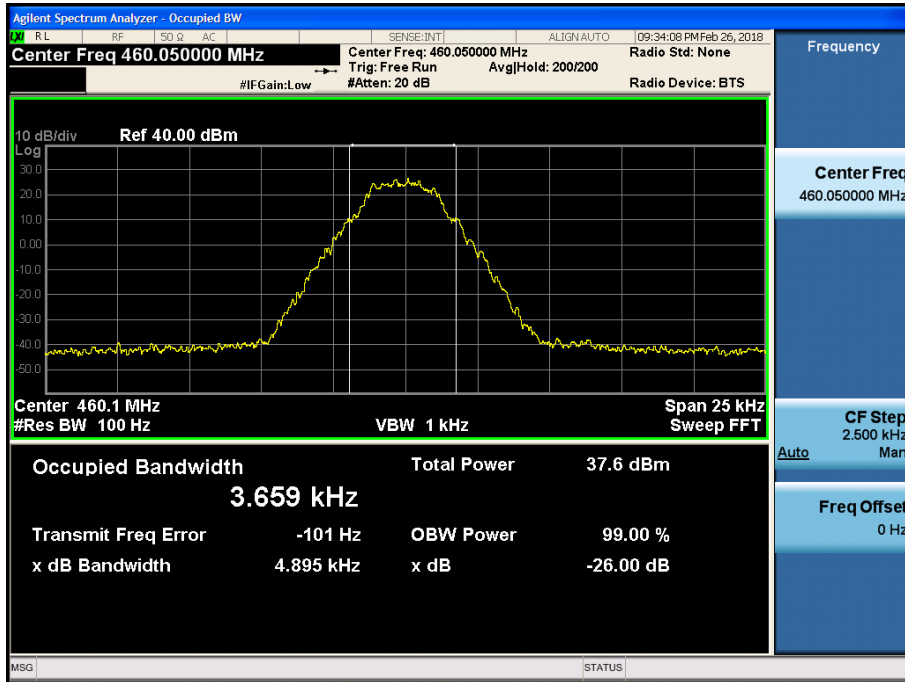

(4K00F1E, 4K00F1D, 4K00F7W _ 469.95 MHz)_Low

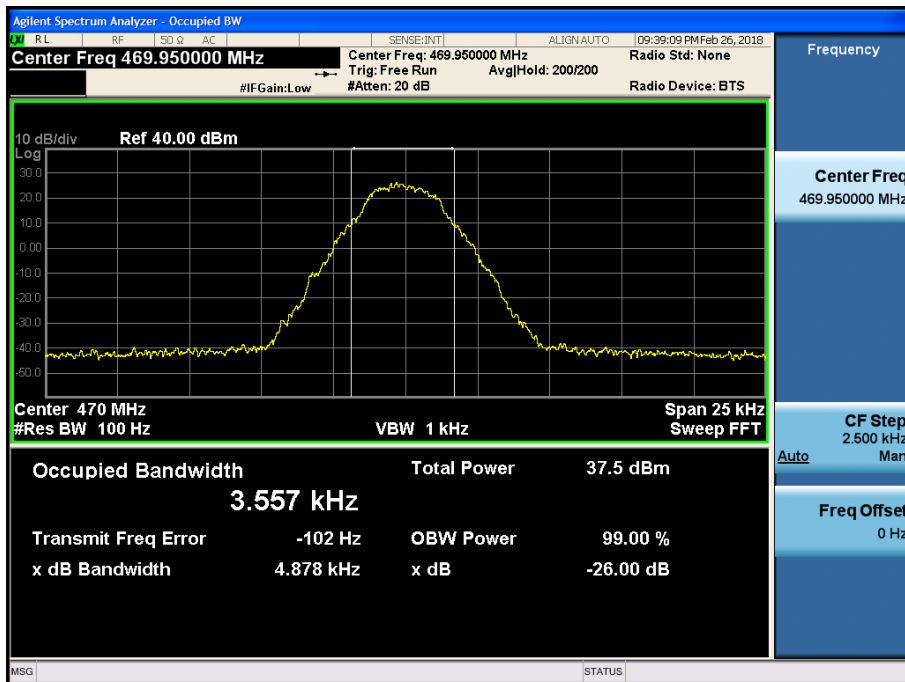

(4K00F2D _ 450.05 MHz)_High

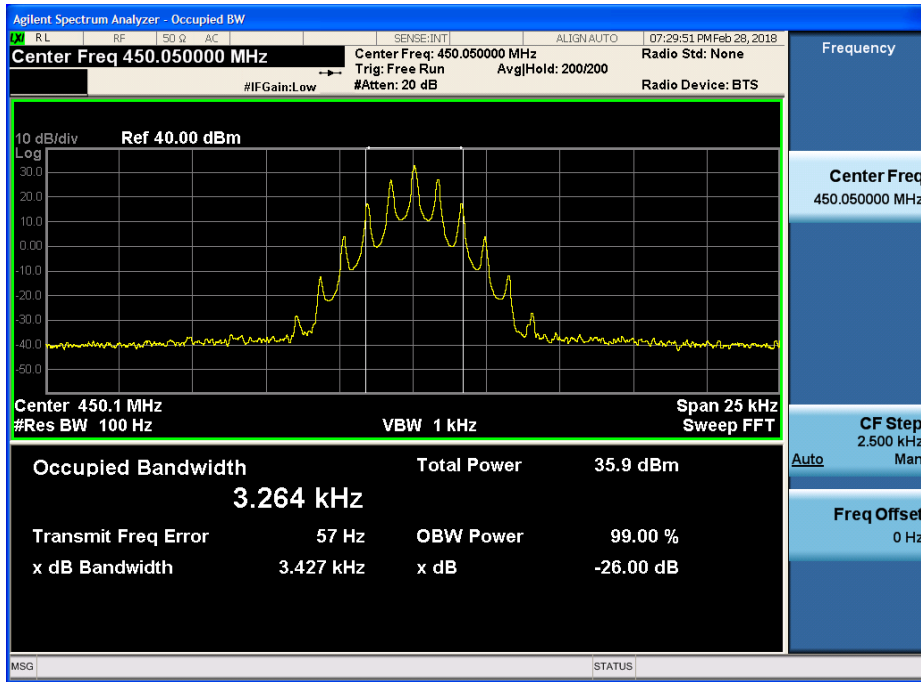

(4K00F2D _ 460.05 MHz)_High

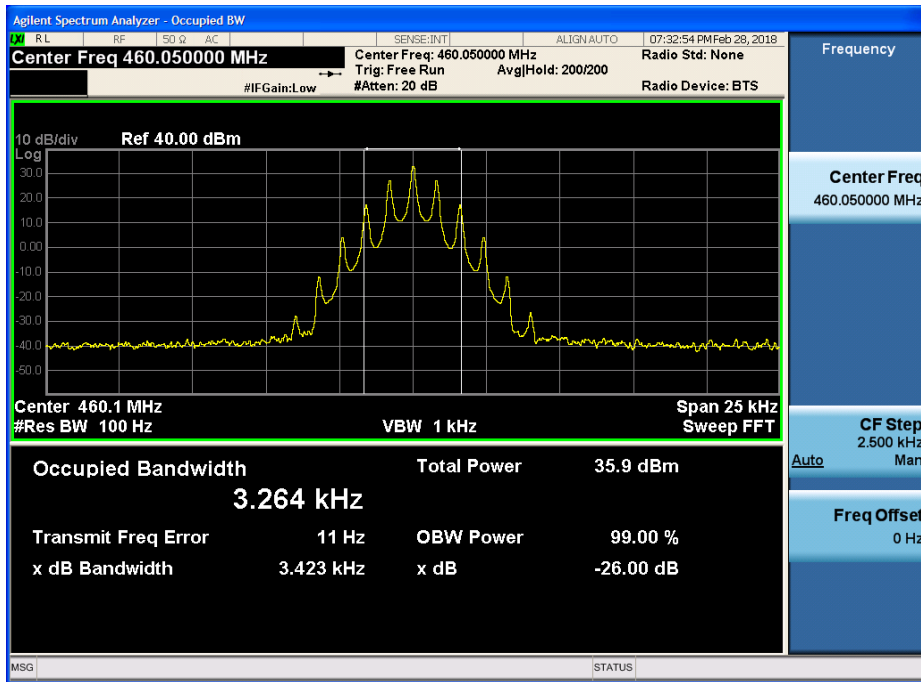

(4K00F2D _ 469.95 MHz)_High

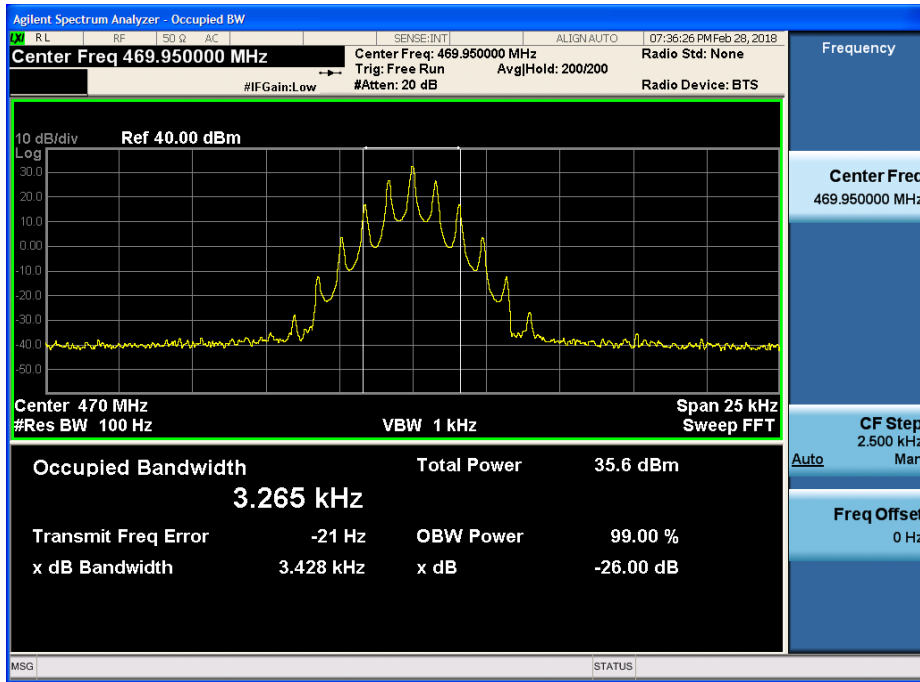

(4K00F2D _ 450.05 MHz)_Low

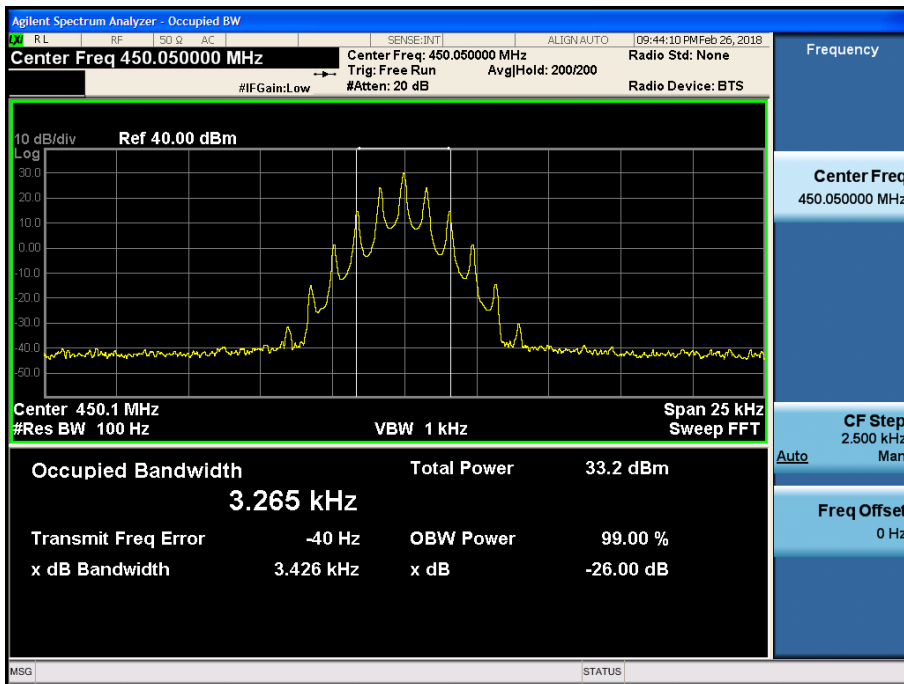

(4K00F2D _ 460.05 MHz)_Low

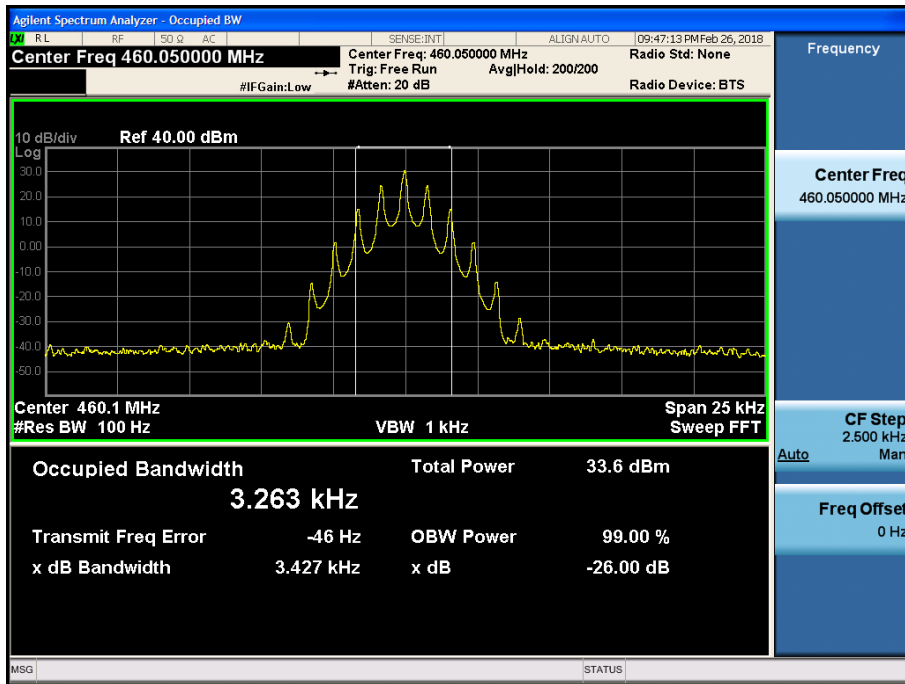

(4K00F2D _ 469.95 MHz)_Low

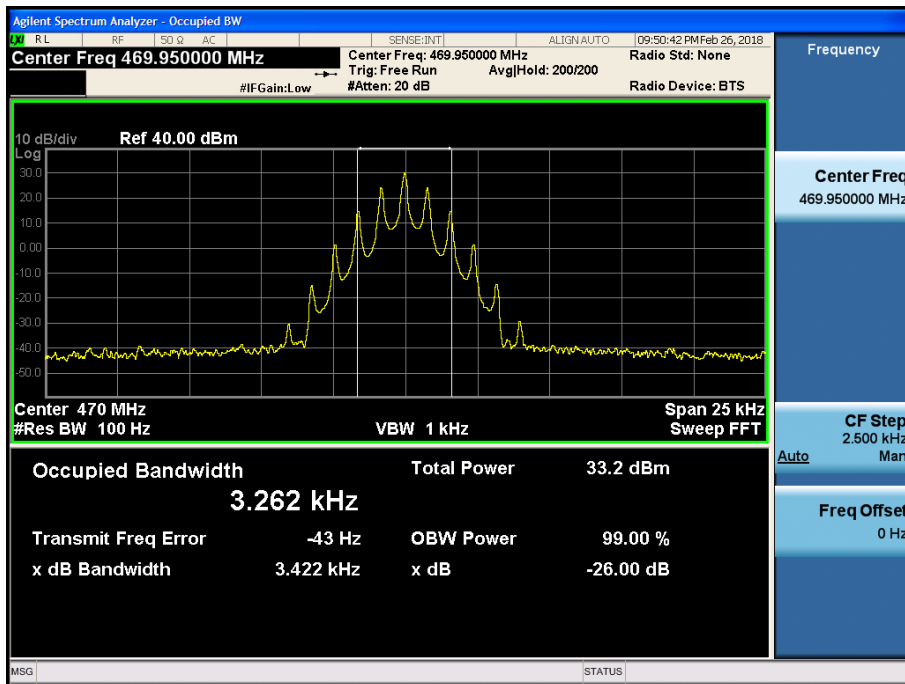

7.4 Modulation Limiting

■ Definition

Modulation limiting is the transmitter circuit's ability to limit the transmitter from producing deviations in excess of a rated system deviation.

■ TEST CONFIGURATION

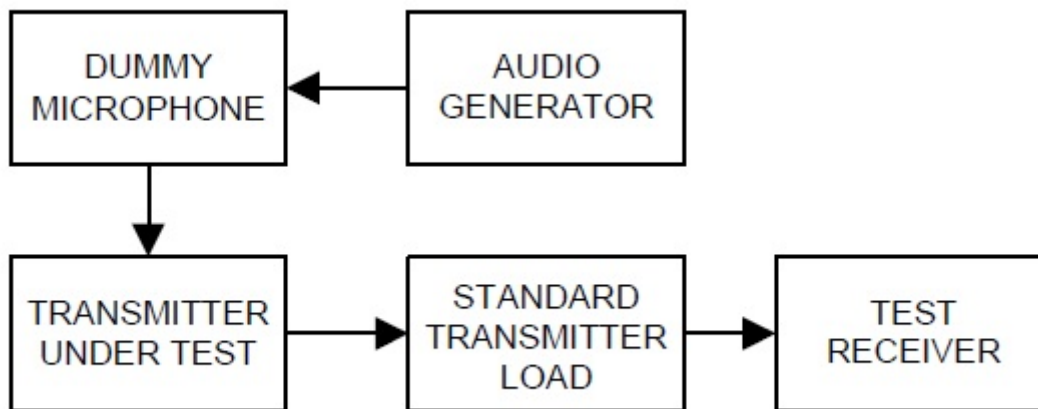

■ TEST PROCEDURE

According to 2.2.3 in TIA-603-E Standard.

- a) Connect the equipment as illustrated.
- b) Adjust the transmitter per the manufacturer's procedure for full rated system deviation.
- c) Set the test receiver to measure peak positive deviation.
Set the audio bandwidth for ≤ 0.25 Hz to $\geq 15,000$ Hz.
Turn the de-emphasis function off.
- d) Apply a 1000 Hz modulating signal to the transmitter from the audio frequency generator, and adjust the level obtain 60% of full rated system deviation.
- e) Increase the level form the audio frequency generator by 20 dB in one step(rise time between the 10% and 90% points shall be 0.1 second maximum).
- f) Measure both the instantaneous and steady-state deviation at and after the time of increasing the audio input level.
- g) With the level from the audio frequency generator held constant at the level obtained in step e), Slowly vary the audio frequency from 300 Hz to 3000 Hz and observe the steady-state deviation. Record the maximum deviation.
- h) Set the test receiver to measure peak negative deviation and repeat steps d) through g).
- i) The values recorded in steps g) and h) are the modulation limiting.

■ TEST RESULTS (11K0F3E)

Positive Peaks

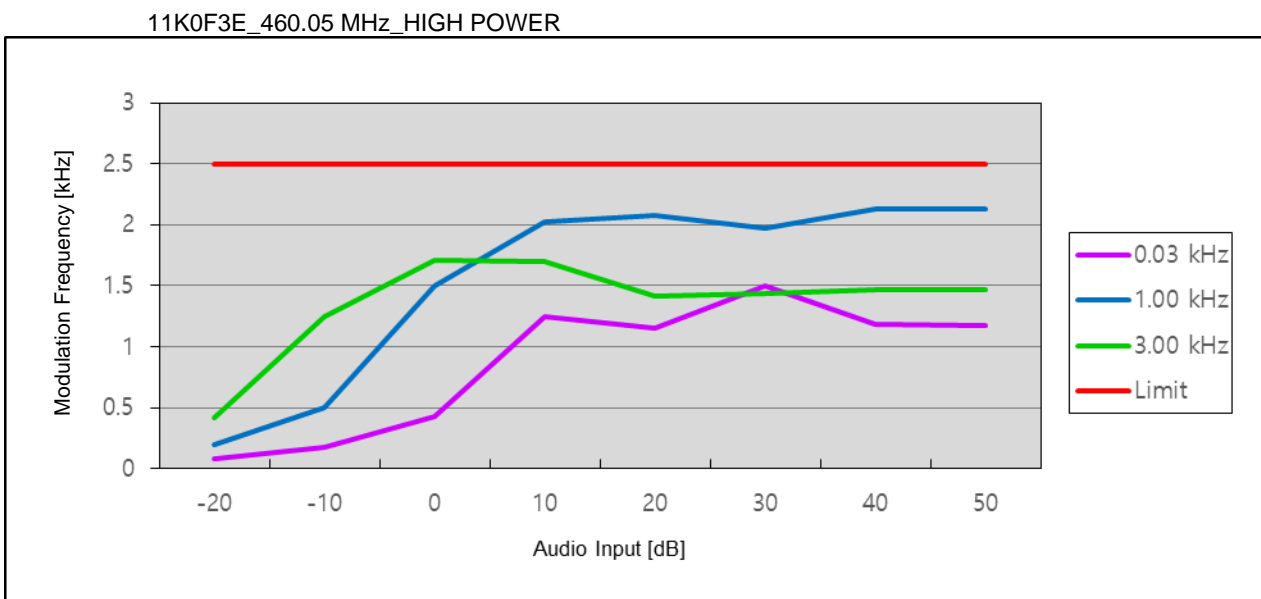
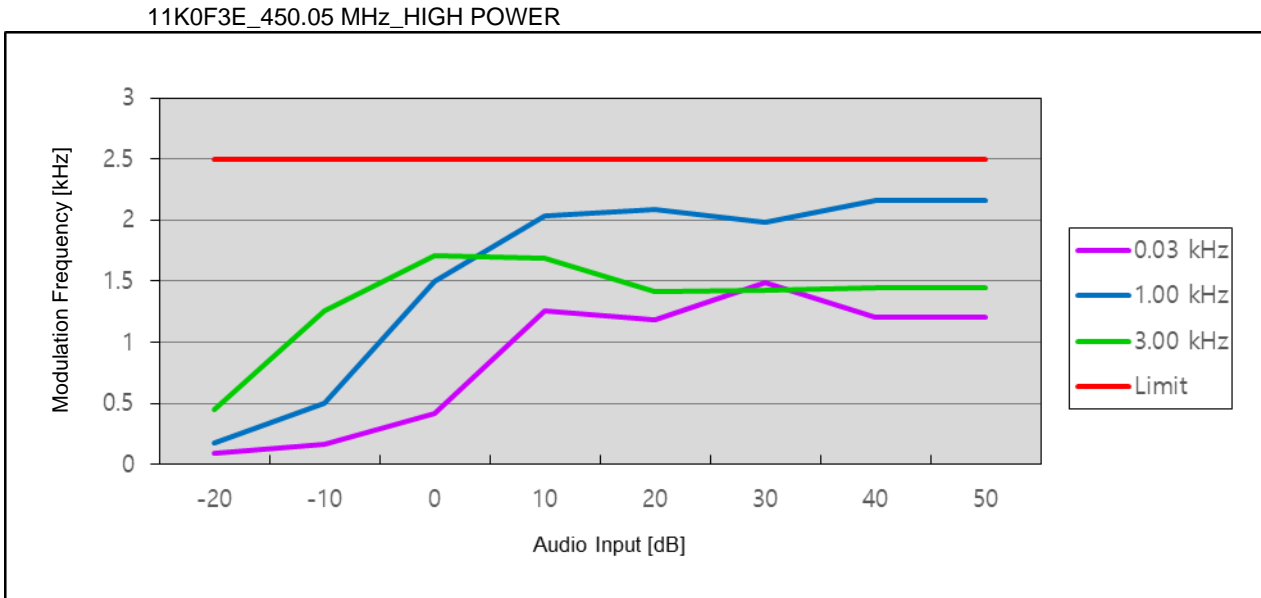

11K0F3E_469.95 MHz_HIGH POWER

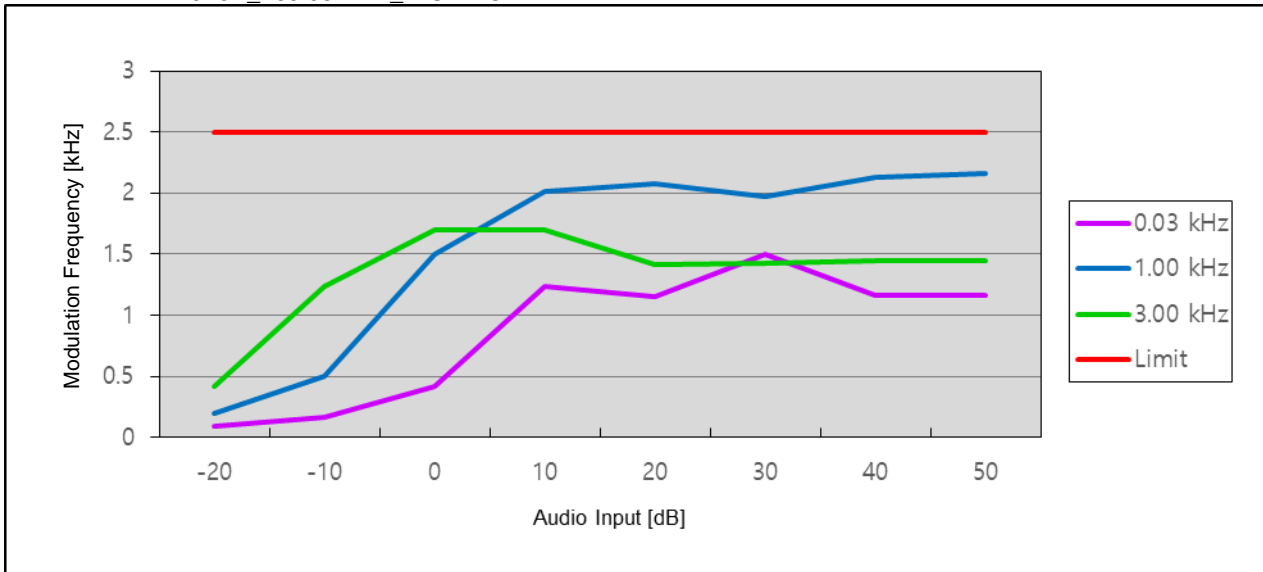

11K0F3E_450.05 MHz_LOW POWER

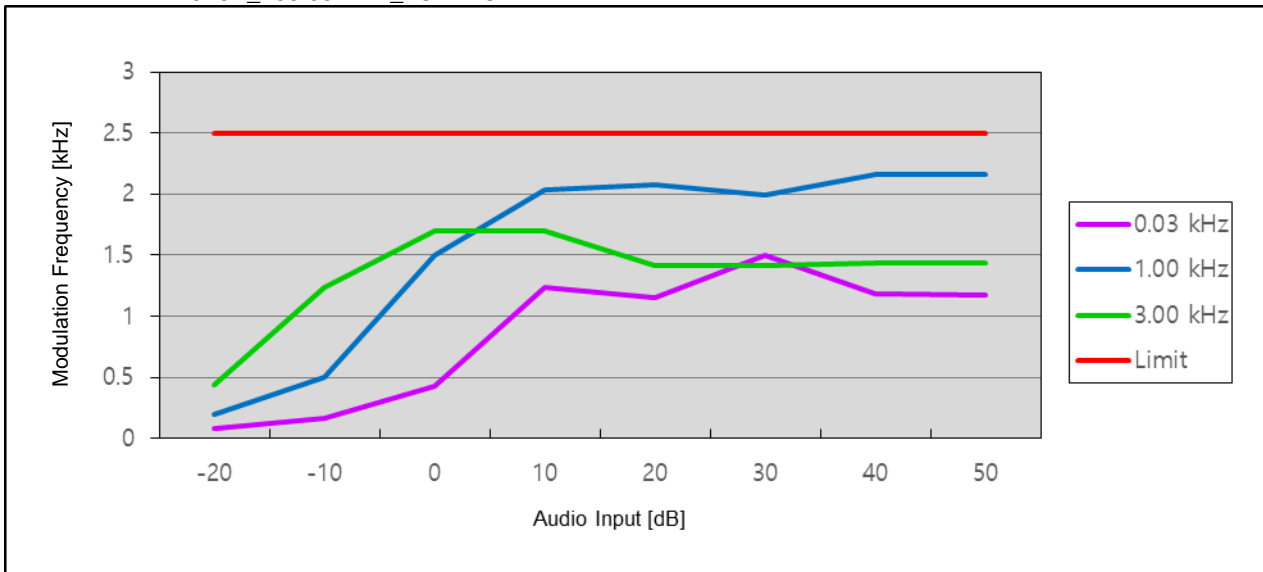

11K0F3E_460.05 MHz_ LOW POWER

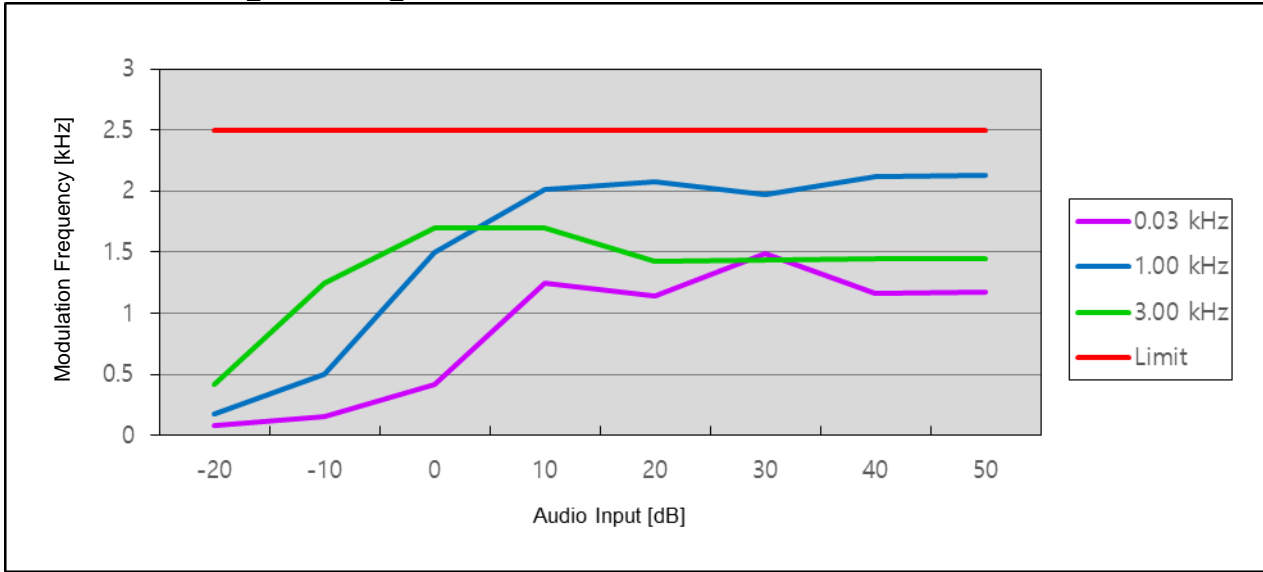

11K0F3E_469.95 MHz_ LOW POWER

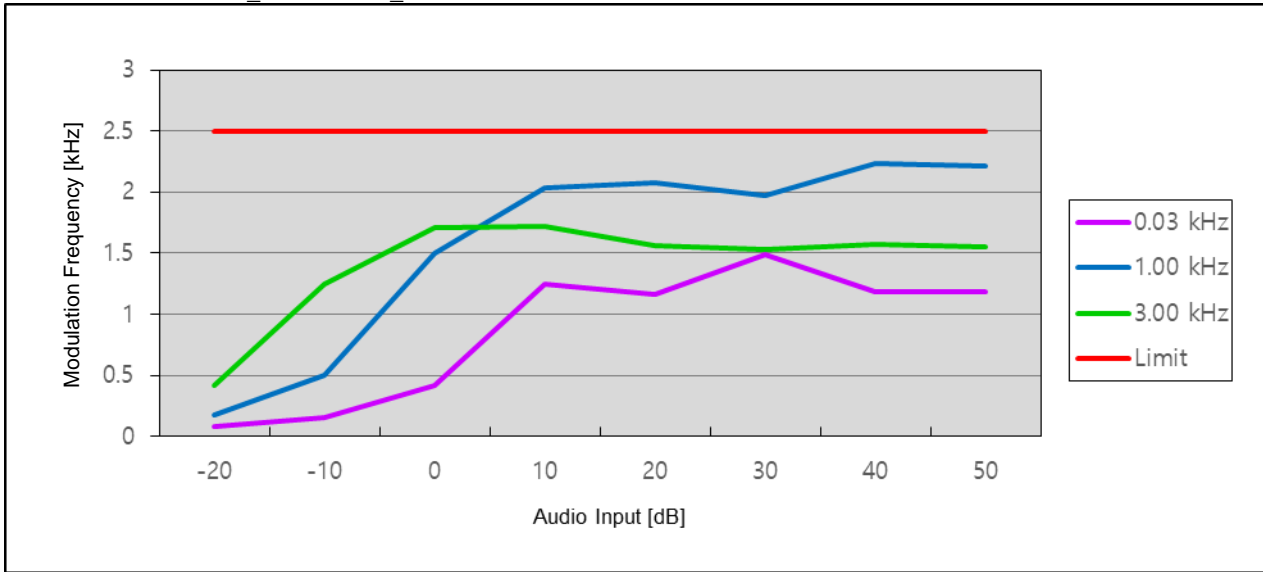

Negative Peaks

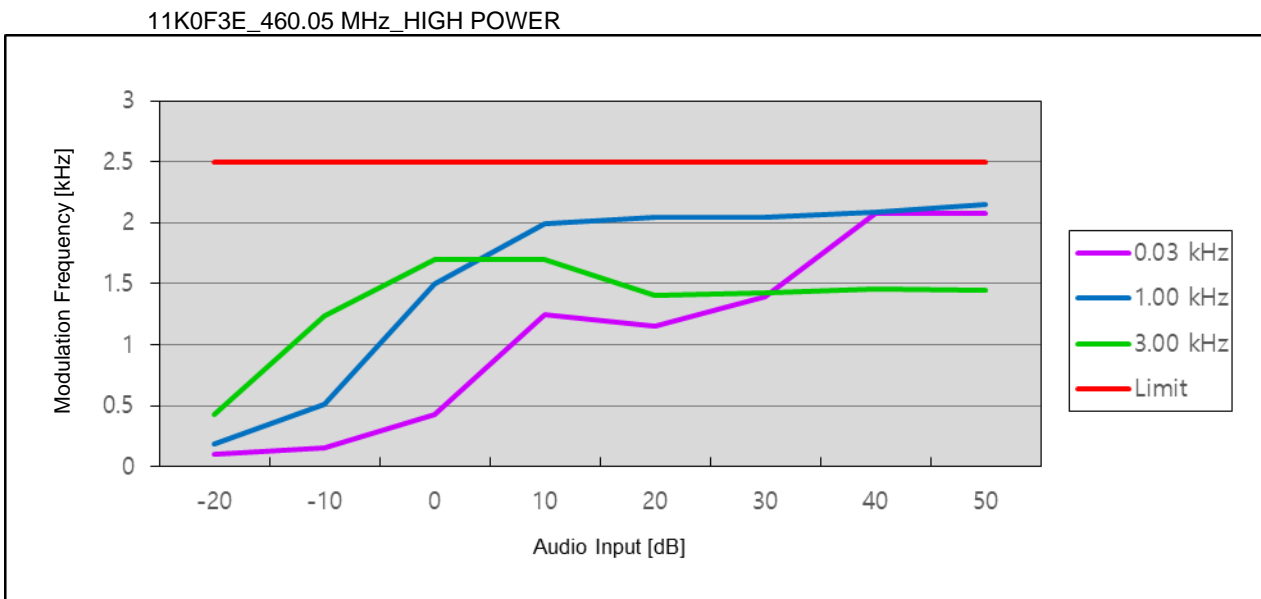
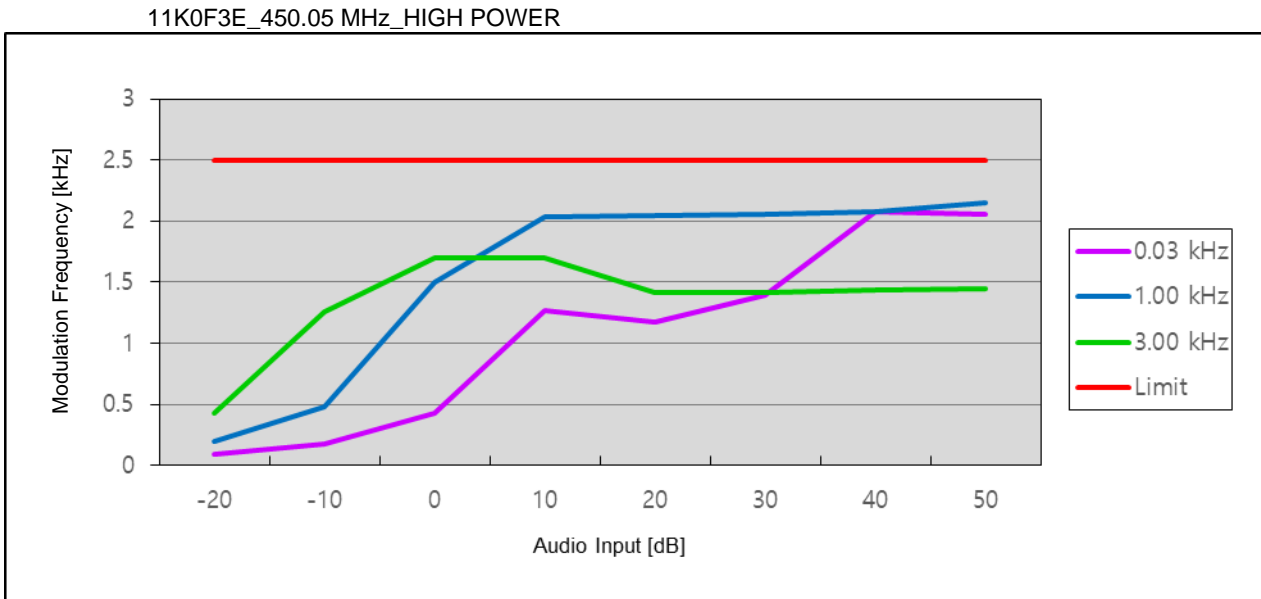

11K0F3E_469.95 MHz_HIGH POWER

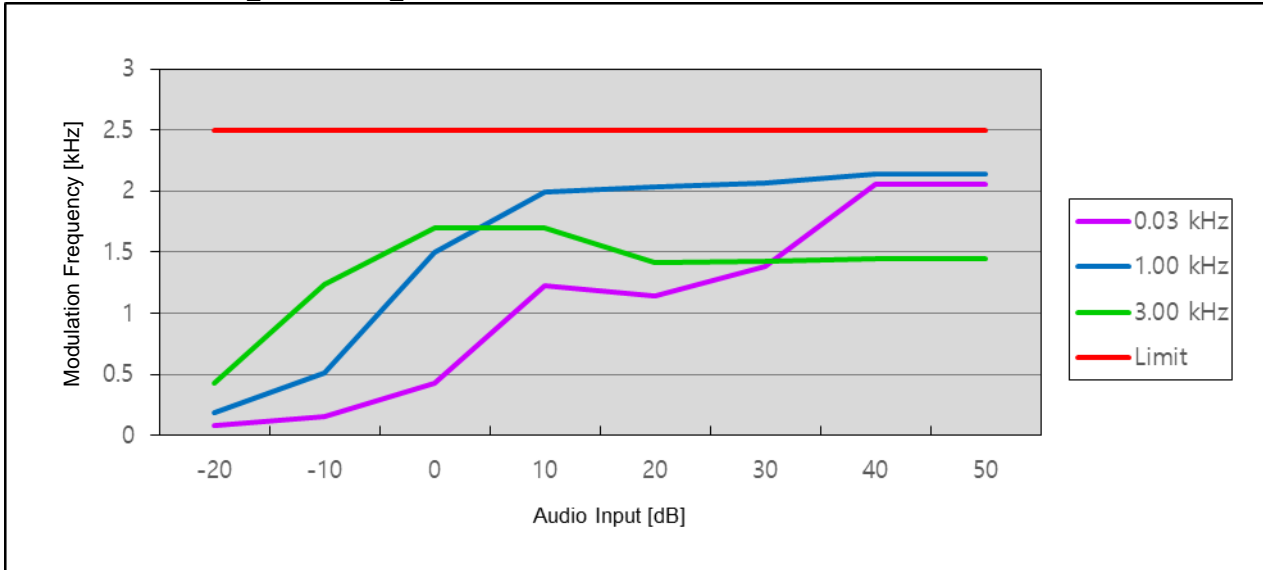

11K0F3E_450.05 MHz_LOW POWER

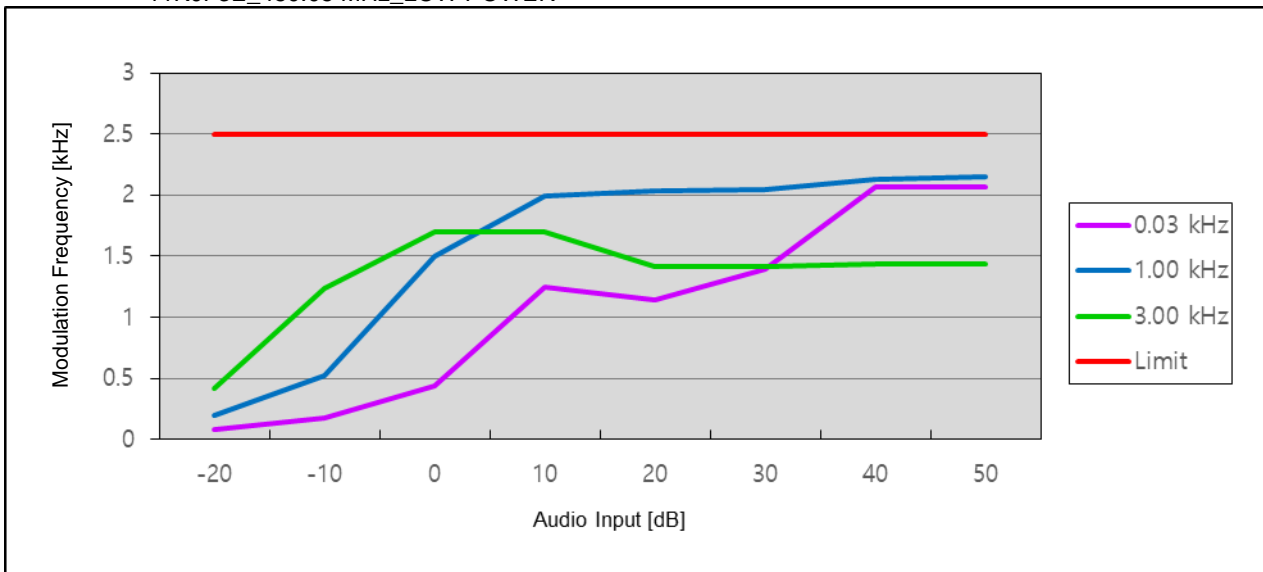

11K0F3E_460.05 MHz_ LOW POWER

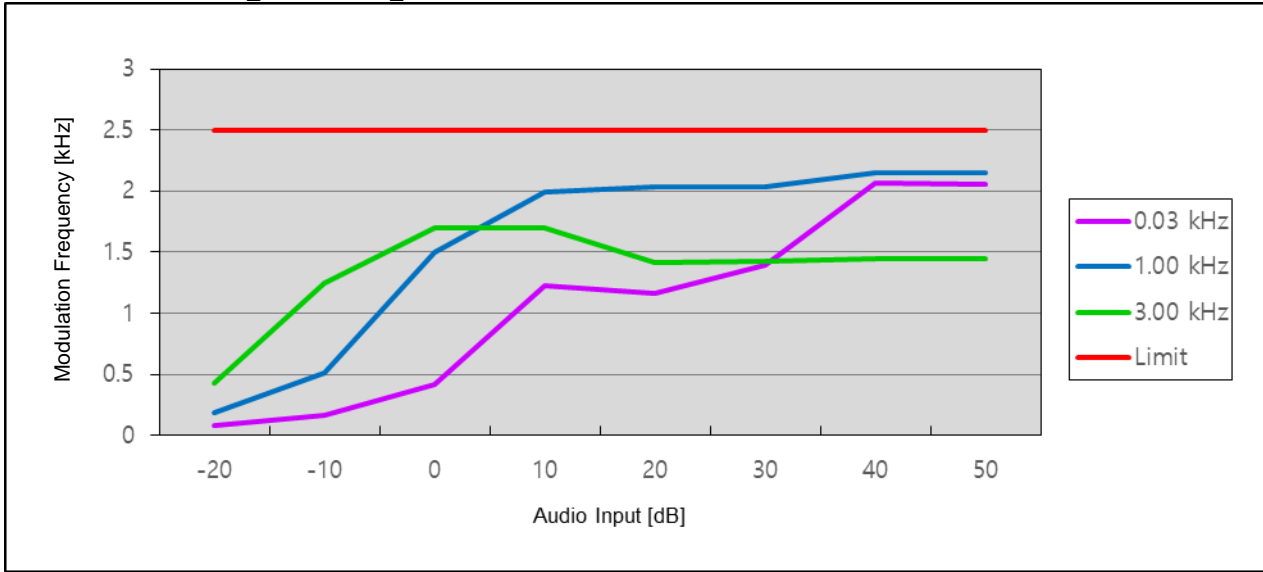

11K0F3E_469.95 MHz_ LOW POWER

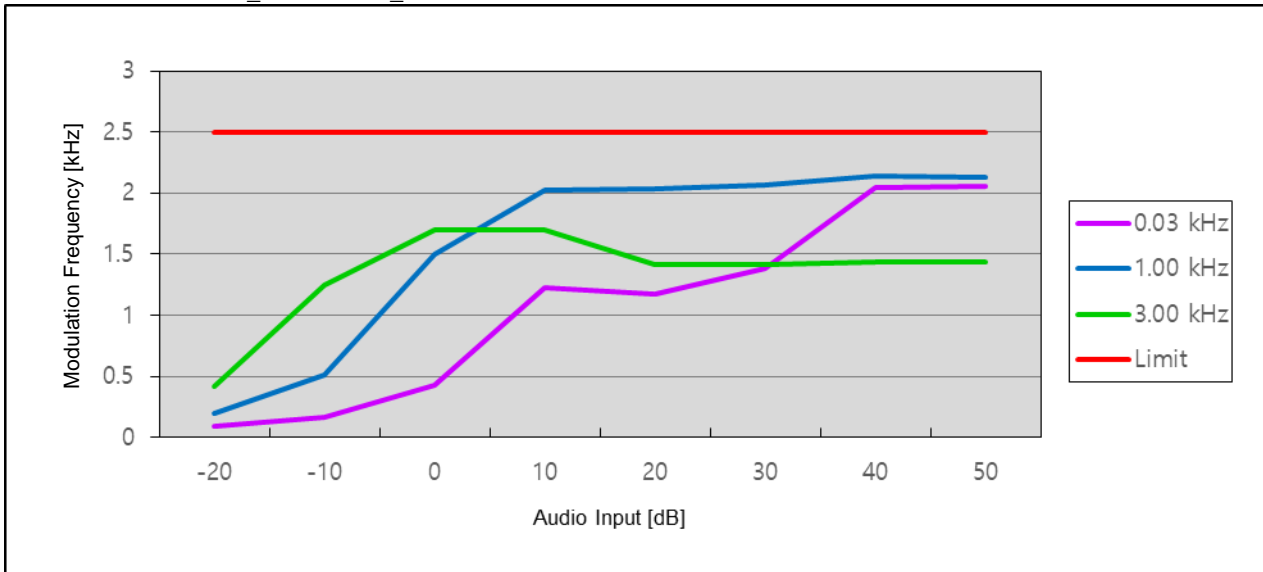

■ TEST RESULTS(16K0F3E)

Positive Peaks

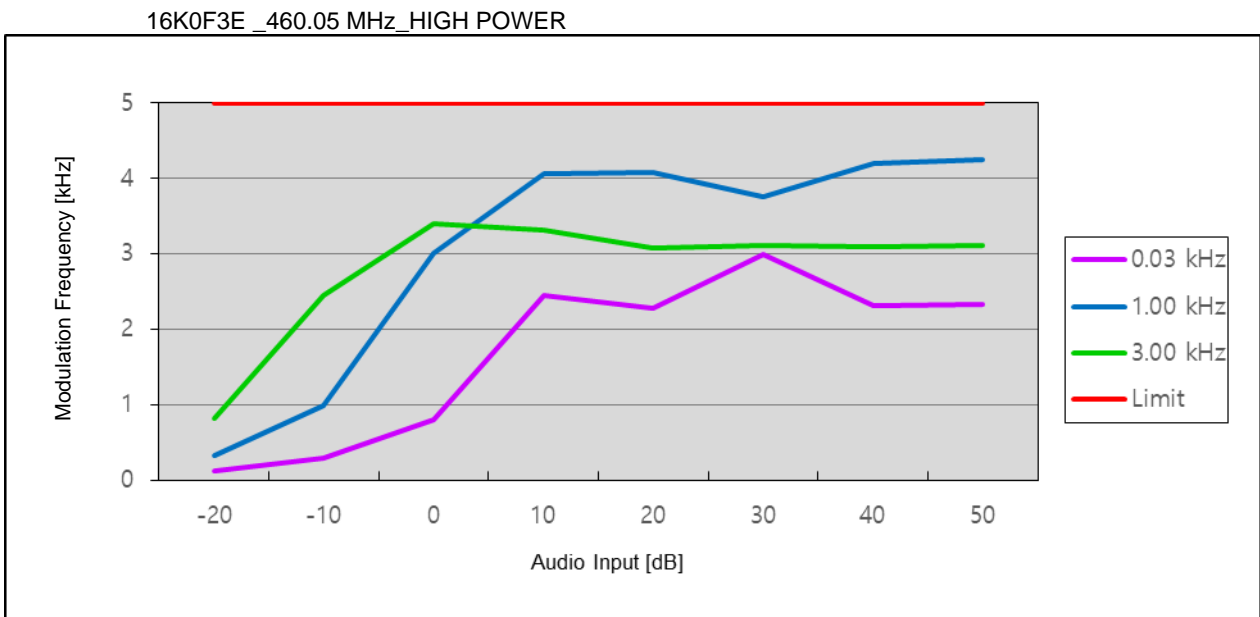
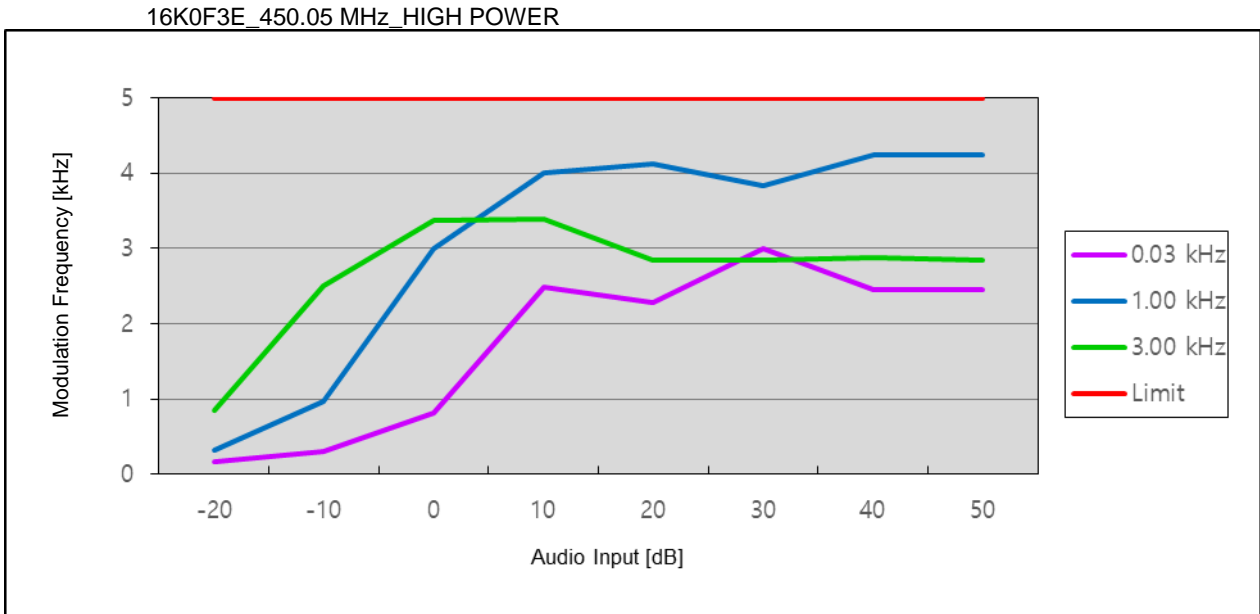

16K0F3E _469.95 MHz_HIGH POWER

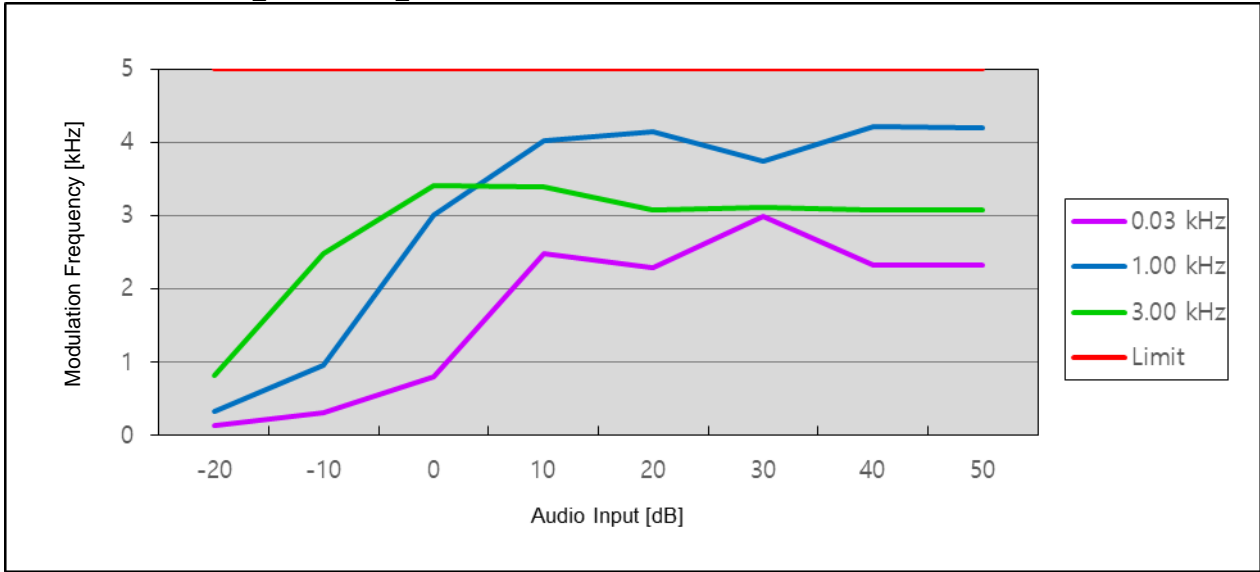

16K0F3E _450.05 MHz_LOW POWER

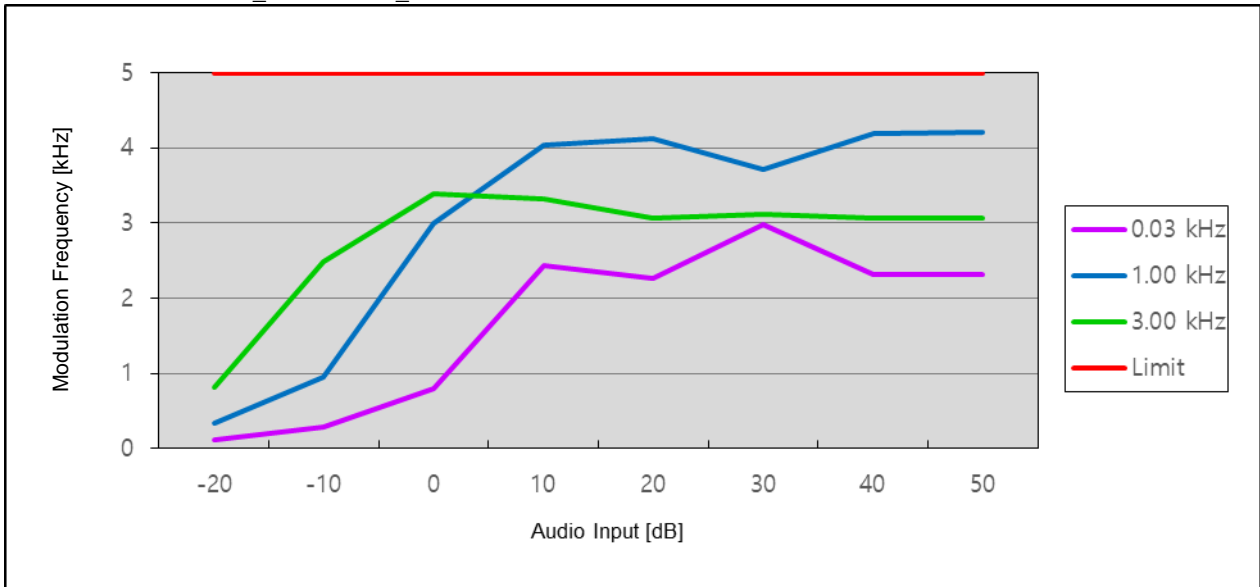

16K0F3E _460.05 MHz_ LOW POWER

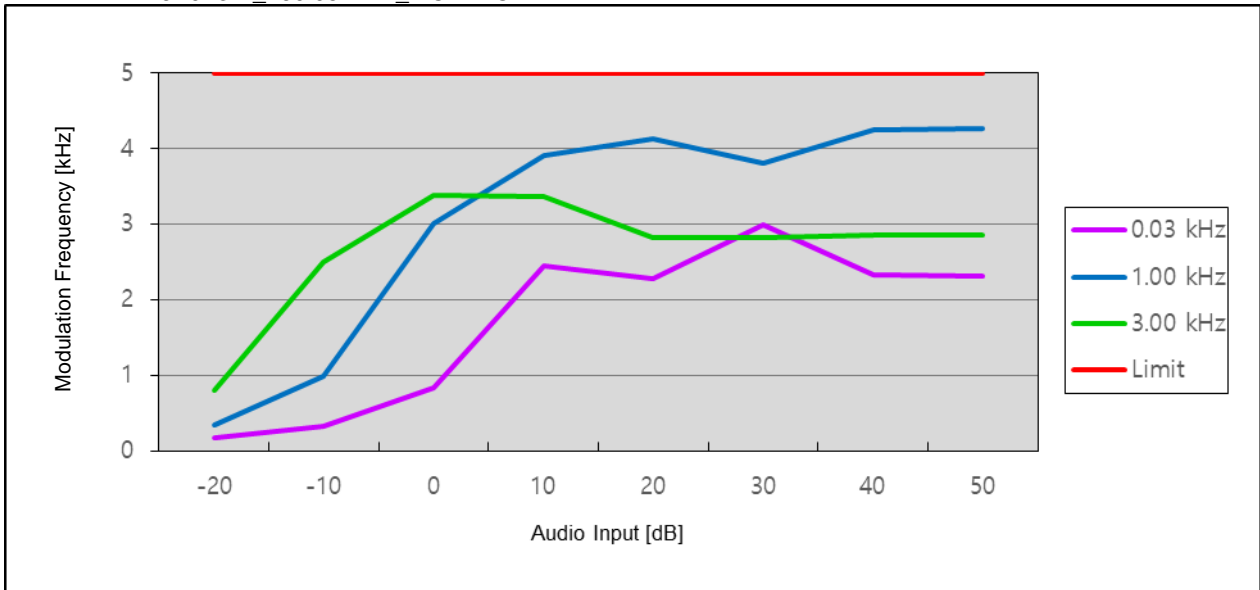

16K0F3E _469.95 MHz_ LOW POWER

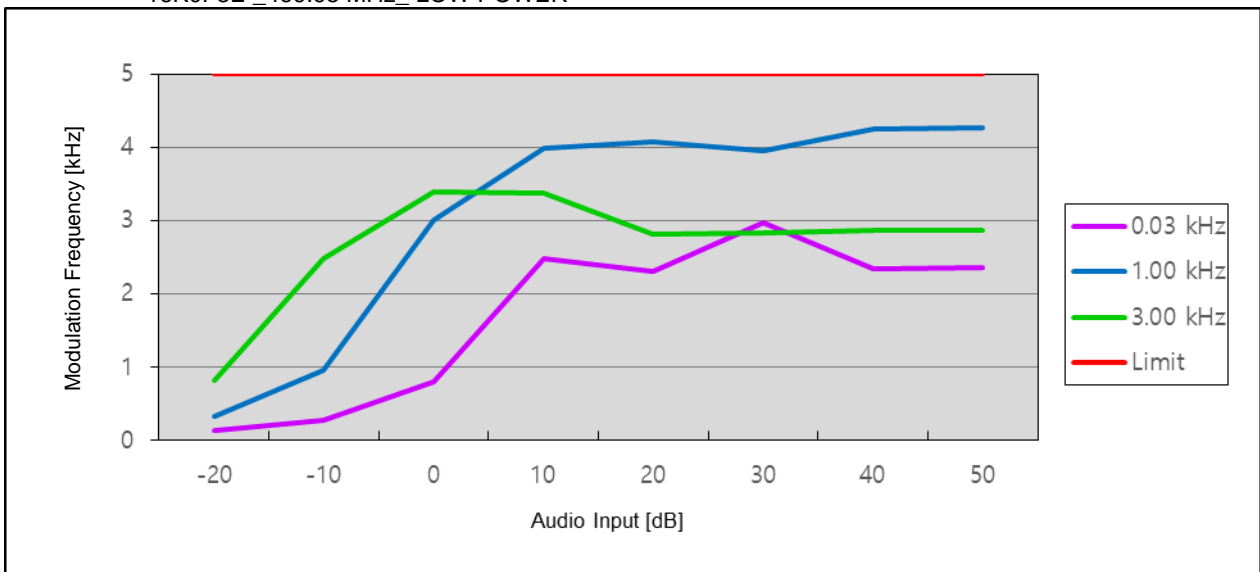

Negative Peaks

16K0F3E_450.05 MHz_HIGH POWER

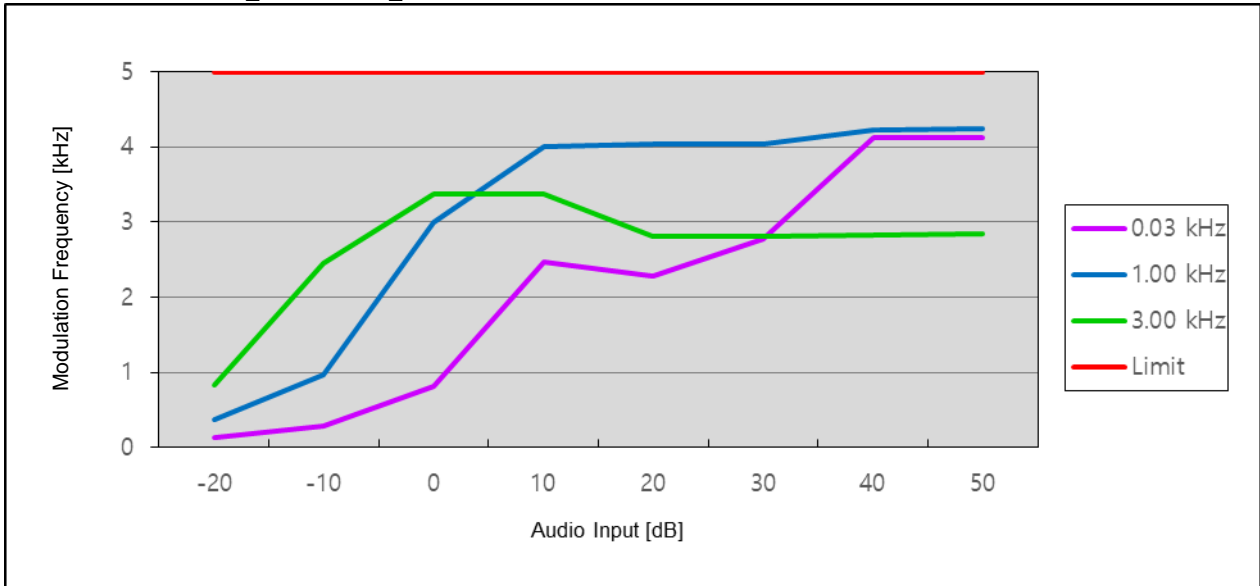

16K0F3E_460.05 MHz_HIGH POWER

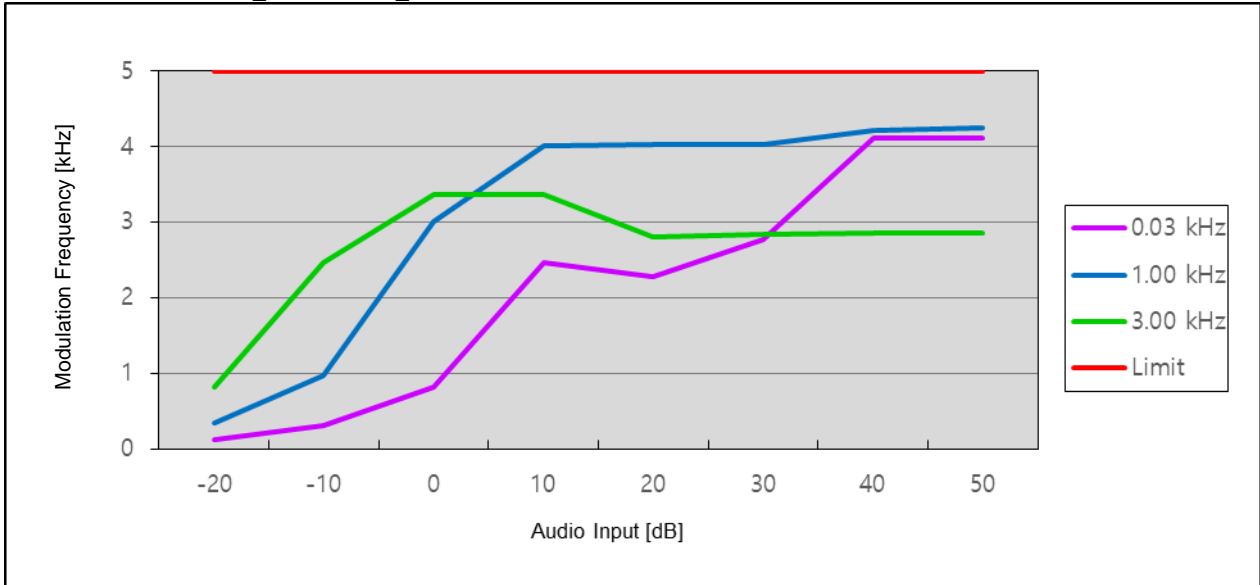

16K0F3E _469.95 MHz_HIGH POWER

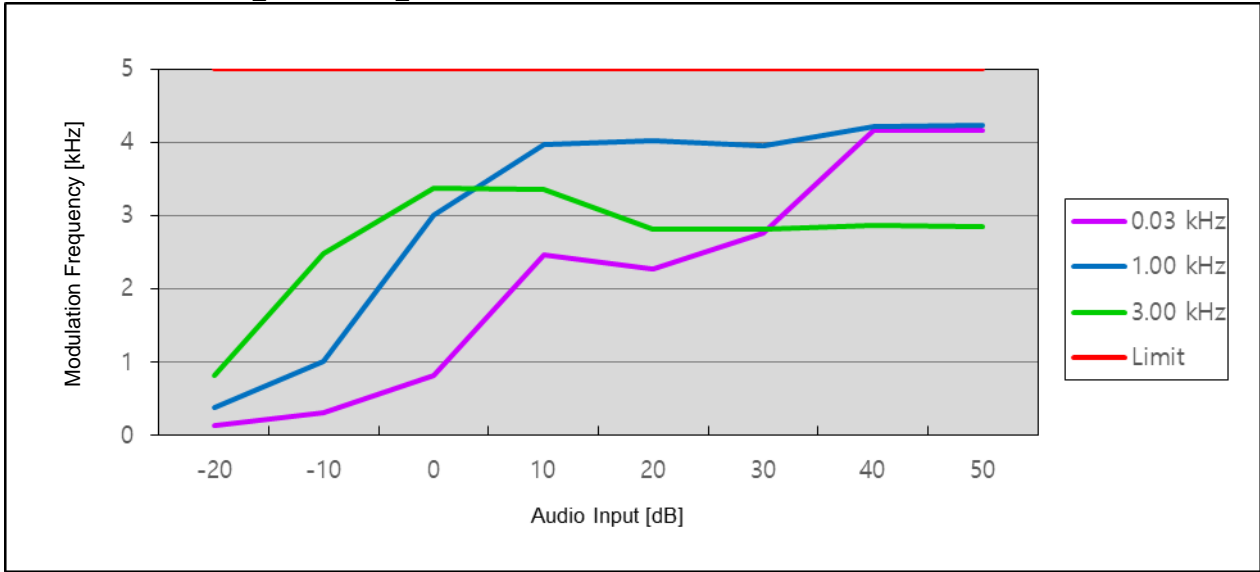

16K0F3E _450.05 MHz_LOW POWER

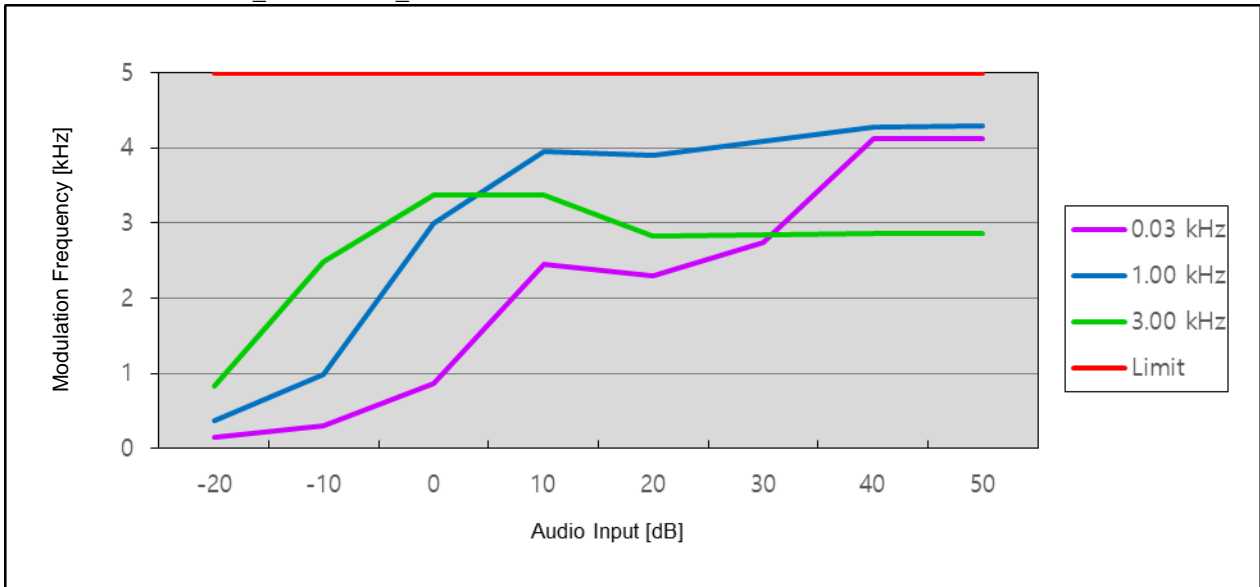

16K0F3E _460.05 MHz_ LOW POWER

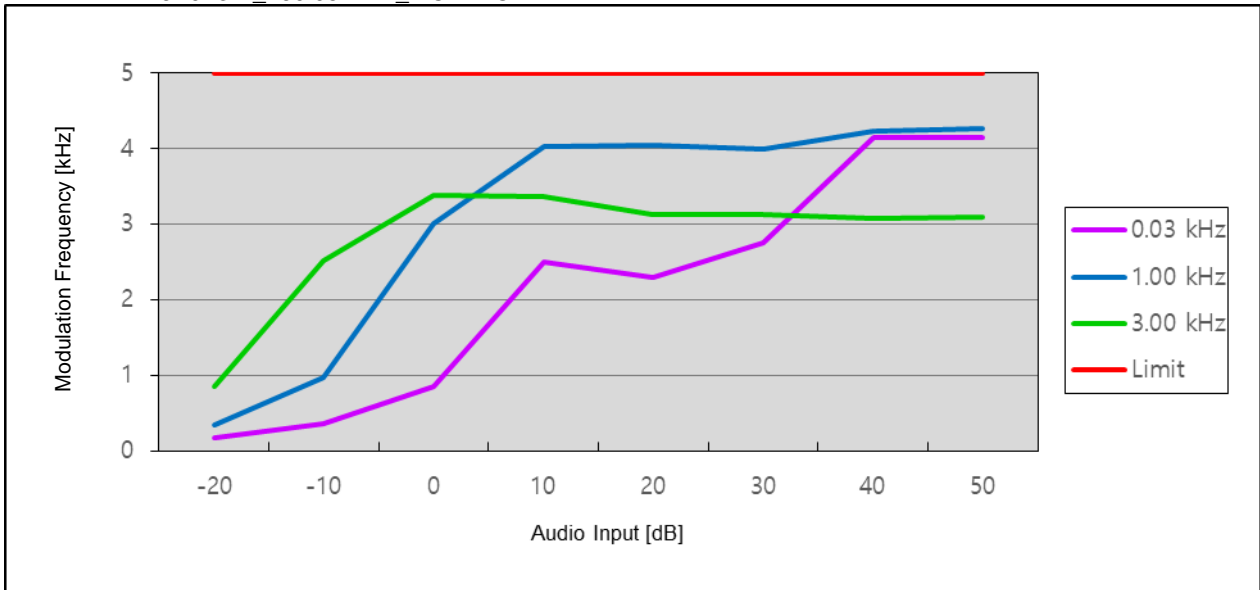

16K0F3E _469.95 MHz_ LOW POWER

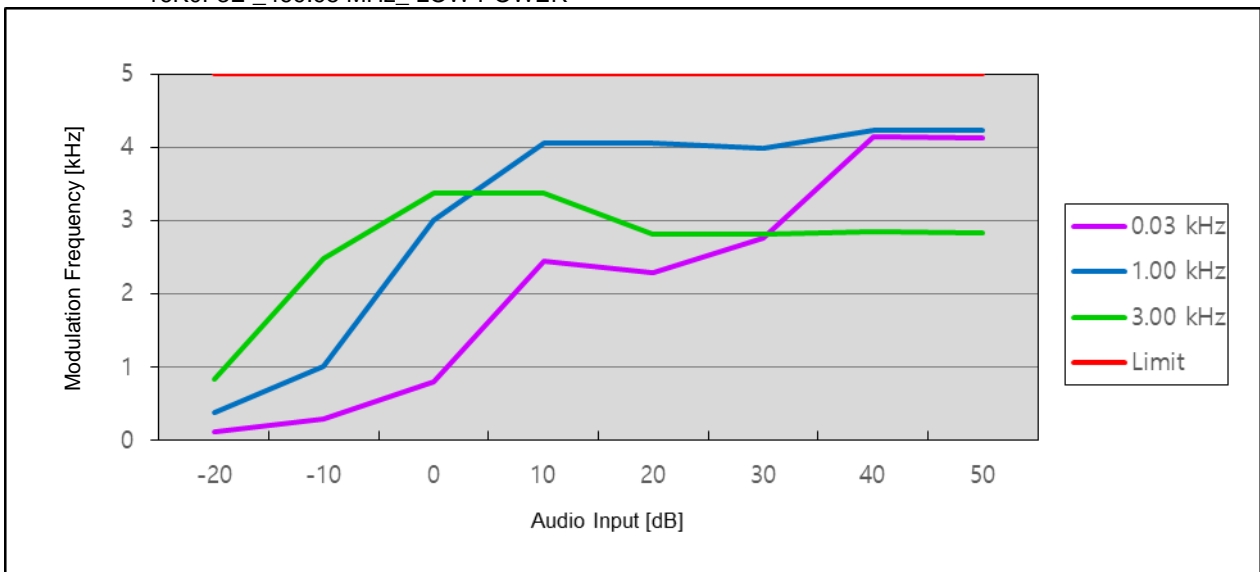

7.5 Audio Frequency Response / Audio Low Pass Filter Response

■ Definition

The audio frequency response is the degree of closeness to which the frequency deviation of the transmitter follows a prescribed characteristic.

■ TEST CONFIGURATION

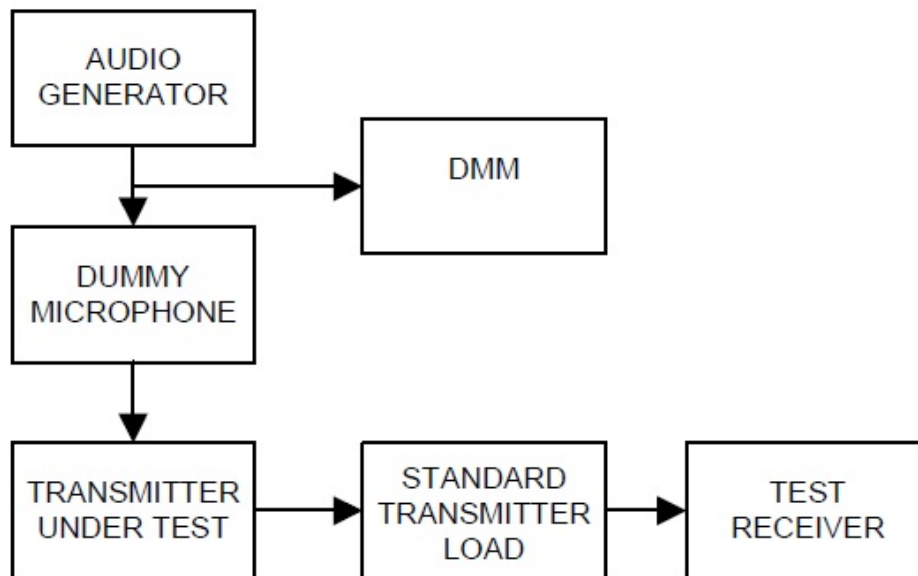

■ TEST PROCEDURE

According to 2.2.6 in TIA-603-E Standard.

- Connect the equipment as illustrated.
- Set the test receiver to measure peak positive deviation. Set the audio bandwidth for ≤ 50 Hz to $\geq 15,000$ Hz. Turn the de-emphasis function off.
- Set the DMM to measure rms voltage.
- Adjust the transmitter per the manufacturer's procedure for full rated system deviation.
- Apply a 1000 Hz tone and adjust the audio frequency generator to produce 20% of the rated system deviation.
- Set the test receiver to measure rms deviation and record the deviation reading.
- Record the DMM reading as V_{REF} .
- Set the audio frequency generator to the desired test frequency between 300 Hz and 3000 Hz.
- Vary the audio frequency generator output level until the deviation reading that was recorded in step f) is obtained.
- Record the DMM reading as V_{FREQ} .
- Calculate the audio frequency response at the present frequency as:

audio frequency response = $20 * \log_{10}(V_{\text{FREQ}}/V_{\text{REF}})$

- l) Repeat steps h) through k) for all the desired test frequencies.

Note

Audio Filter of the above result is substituted with the same structure as Audio Frequency Response.

On the transmission condition below 3kHz, Transceiver shows pre-emphasis condition of transmission function.

On the transmission condition above 3kHz, Transceiver shows Audio Low Pass Filter.

■ **TEST RESULTS (11K0F3E)**

Frequency (Hz)	Attenuation Rel. to 1kHz (dB)	Upper limit (dB)	Lower limit (dB)
100	-28.22	-18.93	-42.86
125	-29.19	-17.00	-39.00
300	-11.60	-9.42	-23.84
500	-6.29	-5.00	-9.00
750	-2.52	-1.49	-5.49
1000	0.00	1.00	-3.00
1250	1.80	2.93	-1.07
1500	3.19	4.51	0.51
2000	5.23	7.00	3.00
2500	7.20	8.93	4.93
3000	8.18	10.51	4.93
4000	-16.90	-	-
5000	-17.10	-	-
6000	-17.07	-	-
7000	-17.03	-	-
8000	-17.07	-	-
9000	-17.21	-	-
10000	-17.01	-	-
20000	-17.07	-	-
30000	-17.15	-	-
40000	-17.03	-	-

11K0F3E_450.05 MHz_HIGH POWER

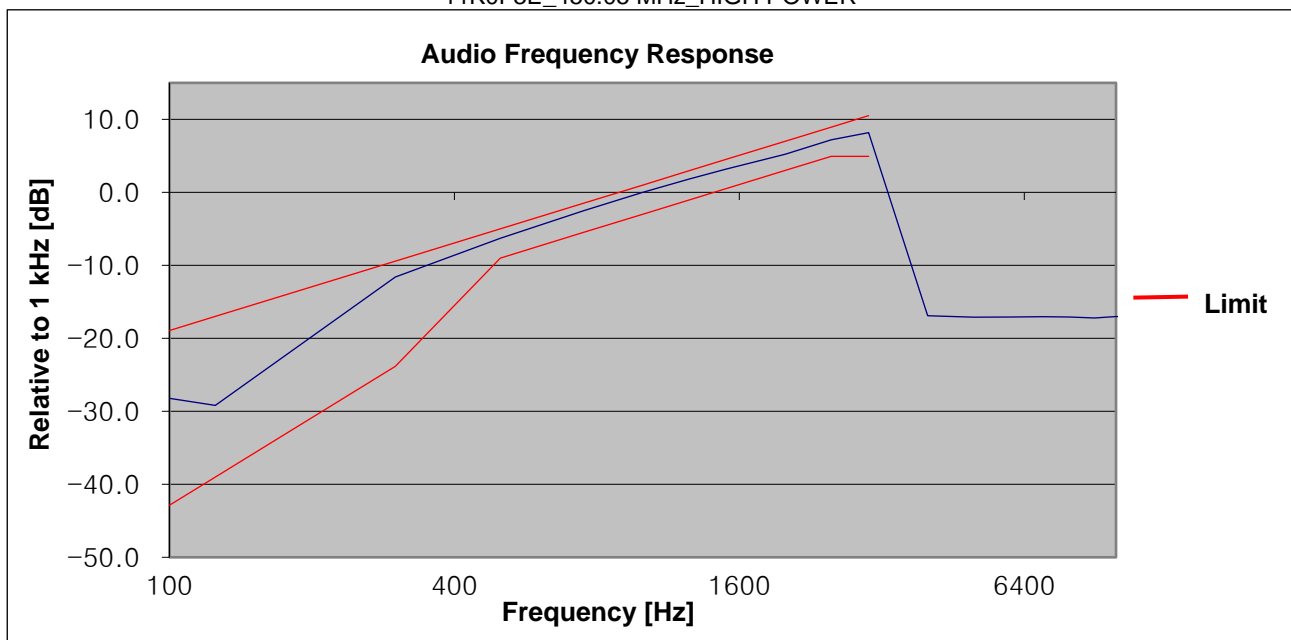

Frequency (Hz)	Attenuation Rel. to 1kHz (dB)	Upper limit (dB)	Lower limit (dB)
100	-27.45	-18.93	-42.86
125	-27.96	-17.00	-39.00
300	-11.61	-9.42	-23.84
500	-6.25	-5.00	-9.00
750	-2.50	-1.49	-5.49
1000	0.00	1.00	-3.00
1250	1.83	2.93	-1.07
1500	3.23	4.51	0.51
2000	5.26	7.00	3.00
2500	7.26	8.93	4.93
3000	8.23	10.51	4.93
4000	-15.29	-	-
5000	-15.47	-	-
6000	-15.50	-	-
7000	-15.41	-	-
8000	-15.38	-	-
9000	-15.41	-	-
10000	-15.50	-	-
20000	-15.48	-	-
30000	-15.53	-	-
40000	-15.42	-	-

11K0F3E_460.05 MHz_HIGH POWER

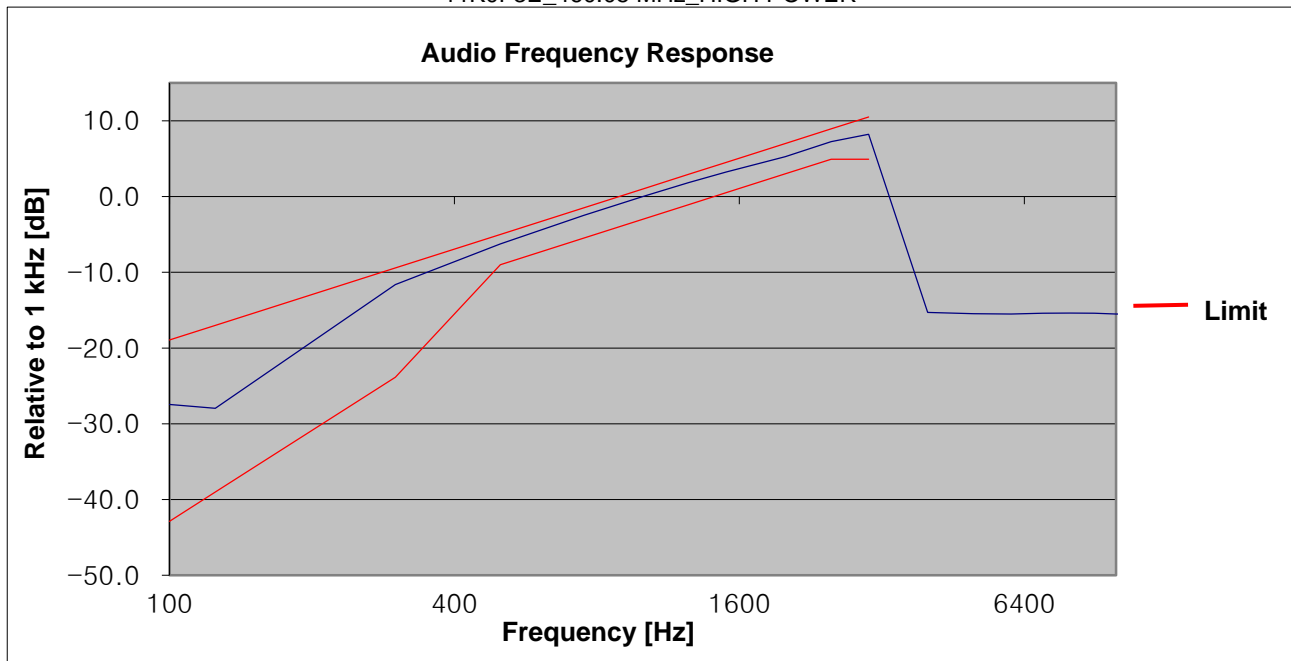

Frequency (Hz)	Attenuation Rel. to 1kHz (dB)	Upper limit (dB)	Lower limit (dB)
100	-25.90	-18.93	-42.86
125	-25.65	-17.00	-39.00
300	-11.53	-9.42	-23.84
500	-6.29	-5.00	-9.00
750	-2.53	-1.49	-5.49
1000	0.00	1.00	-3.00
1250	1.78	2.93	-1.07
1500	3.20	4.51	0.51
2000	5.23	7.00	3.00
2500	7.20	8.93	4.93
3000	8.13	10.51	4.93
4000	-16.48	-	-
5000	-16.74	-	-
6000	-16.69	-	-
7000	-16.76	-	-
8000	-16.92	-	-
9000	-16.78	-	-
10000	-16.87	-	-
20000	-16.89	-	-
30000	-16.76	-	-
40000	-16.71	-	-

11K0F3E_469.95 MHz_HIGH POWER

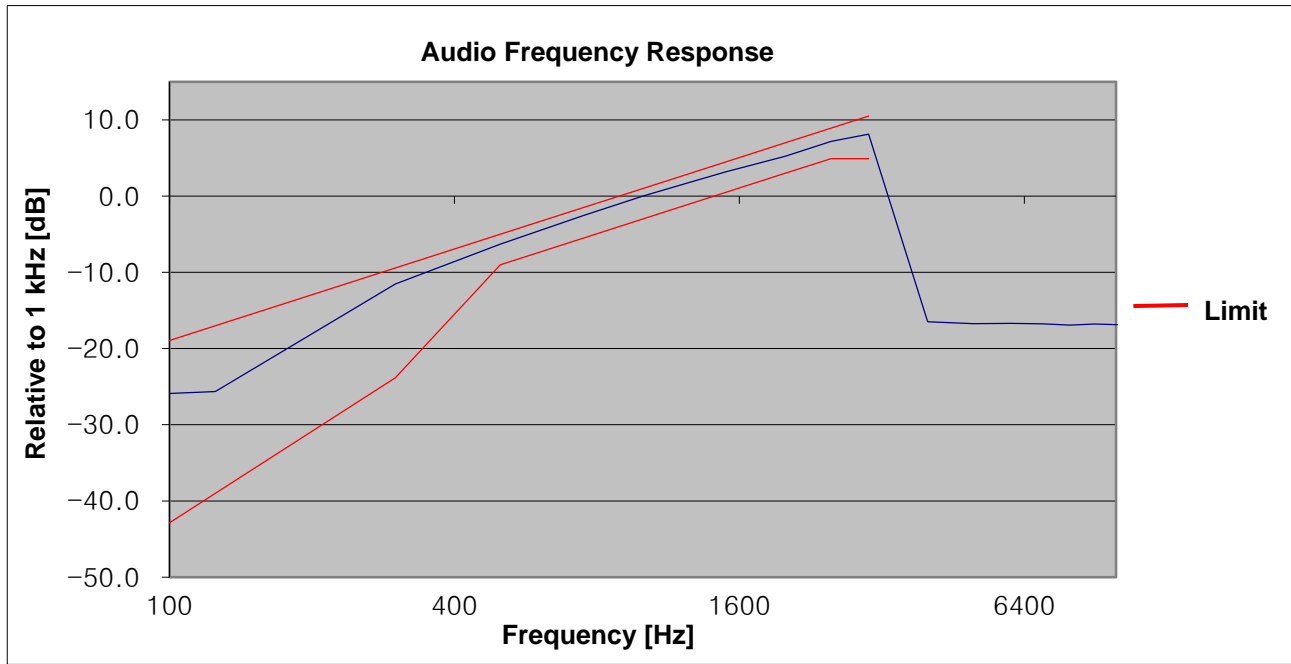

Frequency (Hz)	Attenuation Rel. to 1kHz (dB)	Upper limit (dB)	Lower limit (dB)
100	-30.34	-18.93	-42.86
125	-30.09	-17.00	-39.00
300	-11.57	-9.42	-23.84
500	-6.28	-5.00	-9.00
750	-2.52	-1.49	-5.49
1000	0.00	1.00	-3.00
1250	1.81	2.93	-1.07
1500	3.23	4.51	0.51
2000	5.28	7.00	3.00
2500	7.23	8.93	4.93
3000	8.17	10.51	4.93
4000	-16.91	-	-
5000	-17.00	-	-
6000	-16.99	-	-
7000	-16.95	-	-
8000	-16.89	-	-
9000	-17.04	-	-
10000	-17.00	-	-
20000	-16.99	-	-
30000	-16.91	-	-
40000	-17.00	-	-

11K0F3E_450.05 MHz_ LOW POWER

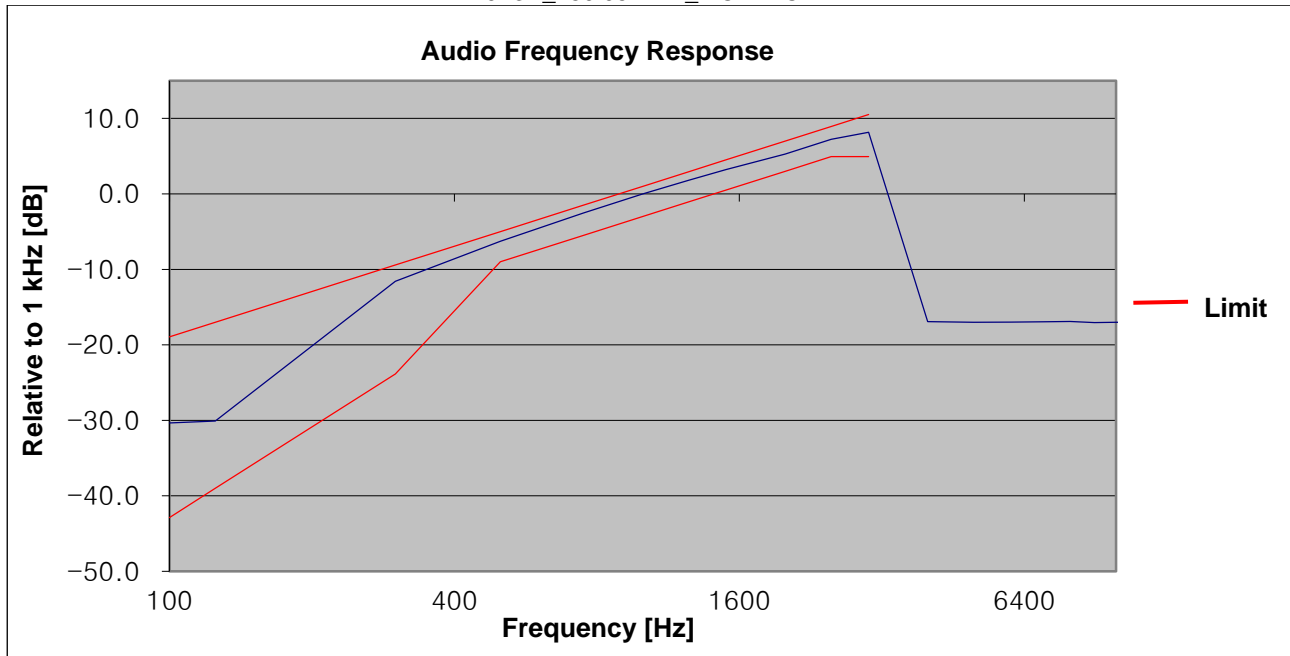

Frequency (Hz)	Attenuation Rel. to 1kHz (dB)	Upper limit (dB)	Lower limit (dB)
100	-27.43	-18.93	-42.86
125	-27.25	-17.00	-39.00
300	-11.48	-9.42	-23.84
500	-6.20	-5.00	-9.00
750	-2.46	-1.49	-5.49
1000	0.00	1.00	-3.00
1250	1.86	2.93	-1.07
1500	3.29	4.51	0.51
2000	5.33	7.00	3.00
2500	7.30	8.93	4.93
3000	8.26	10.51	4.93
4000	-15.19	-	-
5000	-15.37	-	-
6000	-15.37	-	-
7000	-15.46	-	-
8000	-15.31	-	-
9000	-15.35	-	-
10000	-15.29	-	-
20000	-15.41	-	-
30000	-15.40	-	-
40000	-15.27	-	-

11K0F3E_460.05 MHz_ LOW POWER

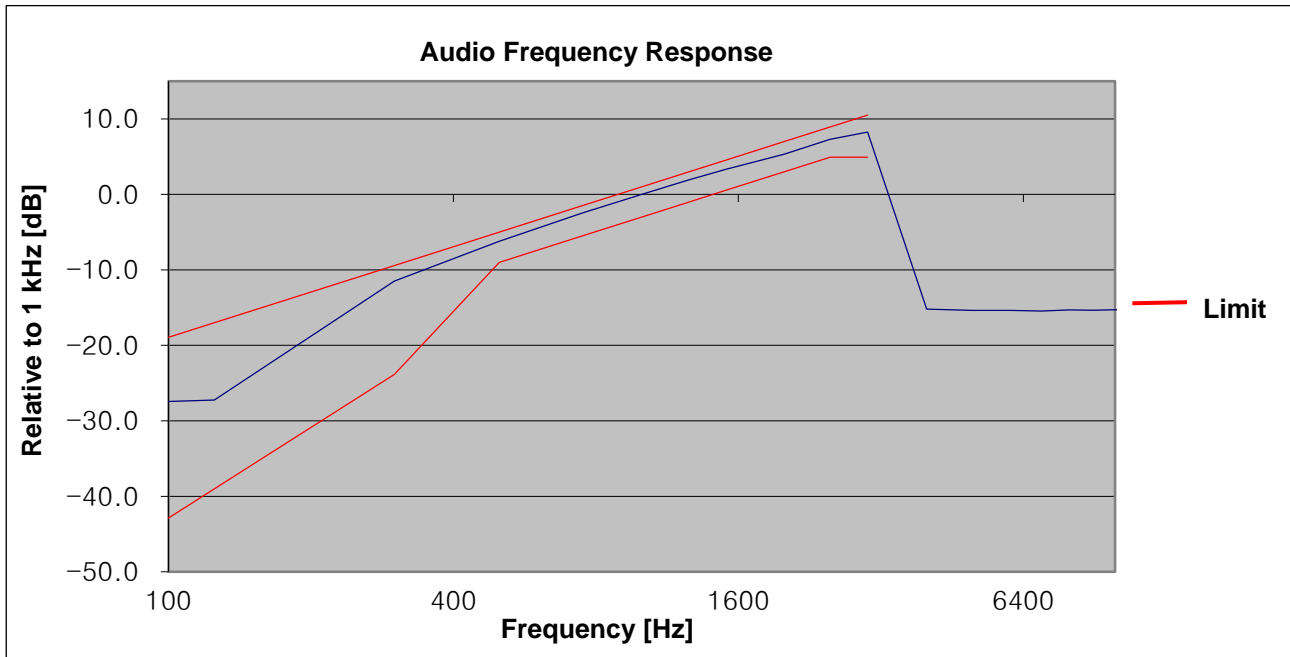

Frequency (Hz)	Attenuation Rel. to 1kHz (dB)	Upper limit (dB)	Lower limit (dB)
100	-27.98	-18.93	-42.86
125	-28.64	-17.00	-39.00
300	-11.49	-9.42	-23.84
500	-6.24	-5.00	-9.00
750	-2.49	-1.49	-5.49
1000	0.00	1.00	-3.00
1250	1.82	2.93	-1.07
1500	3.22	4.51	0.51
2000	5.32	7.00	3.00
2500	7.25	8.93	4.93
3000	8.25	10.51	4.93
4000	-16.59	-	-
5000	-16.76	-	-
6000	-16.68	-	-
7000	-16.64	-	-
8000	-16.64	-	-
9000	-16.66	-	-
10000	-16.68	-	-
20000	-16.68	-	-
30000	-16.66	-	-
40000	-16.71	-	-

11K0F3E_469.95 MHz_ LOW POWER

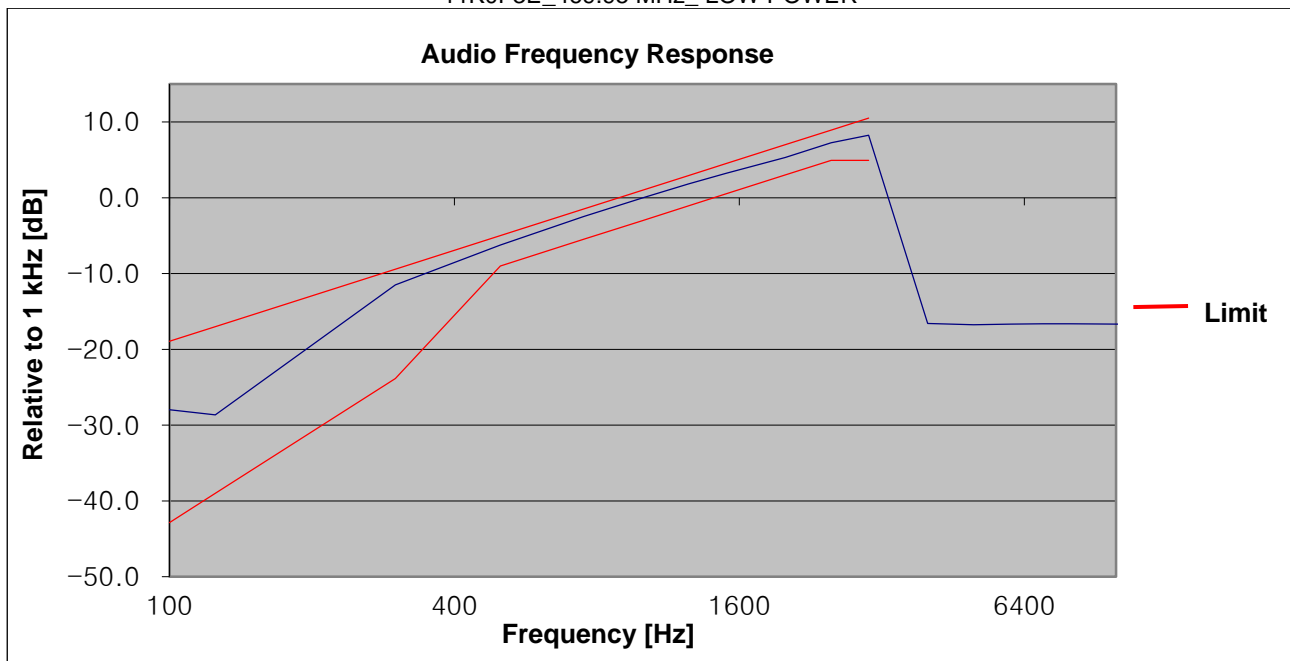

■ **TEST RESULTS (16K0F3E)**

Frequency (Hz)	Attenuation Rel. to 1kHz (dB)	Upper limit (dB)	Lower limit (dB)
100	-25.71	-18.93	-42.86
125	-26.04	-17.00	-39.00
300	-11.29	-9.42	-23.84
500	-6.20	-5.00	-9.00
750	-2.42	-1.49	-5.49
1000	0.00	1.00	-3.00
1250	1.91	2.93	-1.07
1500	3.32	4.51	0.51
2000	5.49	7.00	3.00
2500	7.41	8.93	4.93
3000	8.46	10.51	4.93
4000	-21.39	-	-
5000	-22.94	-	-
6000	-22.99	-	-
7000	-22.94	-	-
8000	-22.93	-	-
9000	-22.93	-	-
10000	-22.94	-	-
20000	-23.03	-	-
30000	-23.05	-	-
40000	-23.01	-	-

16K0F3E_450.05 MHz_HIGH POWER

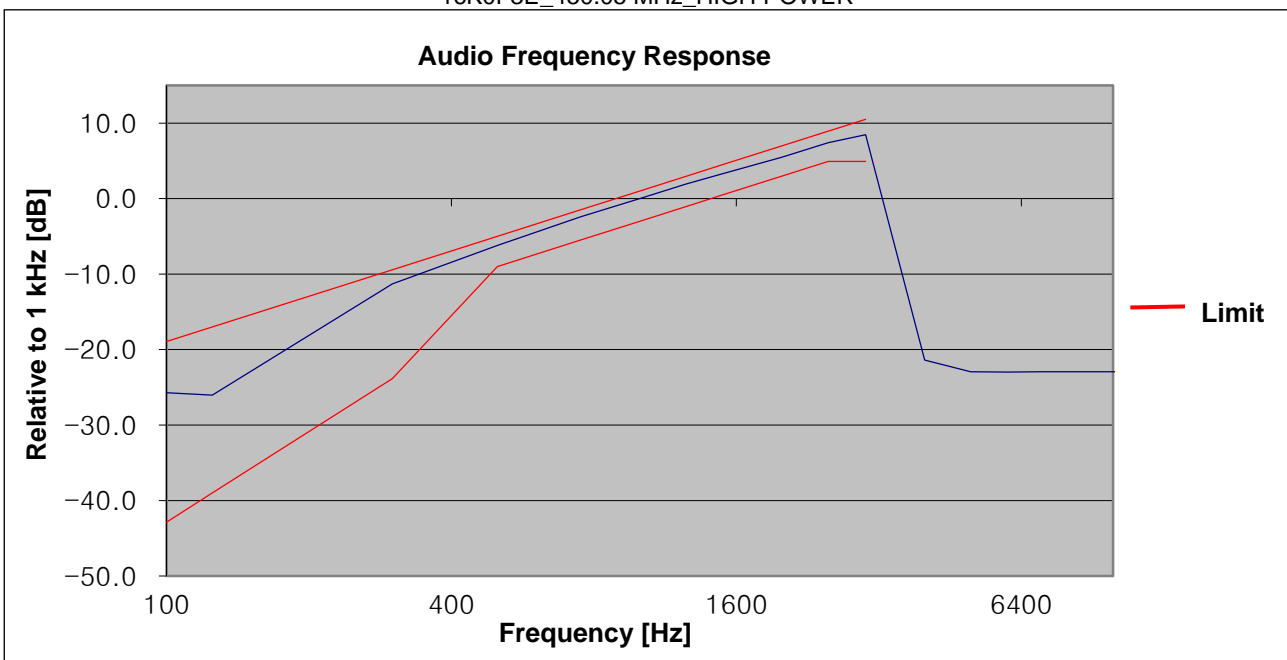

Frequency (Hz)	Attenuation Rel. to 1kHz (dB)	Upper limit (dB)	Lower limit (dB)
100	-31.25	-18.93	-42.86
125	-31.15	-17.00	-39.00
300	-11.60	-9.42	-23.84
500	-6.30	-5.00	-9.00
750	-2.52	-1.49	-5.49
1000	0.00	1.00	-3.00
1250	1.83	2.93	-1.07
1500	3.26	4.51	0.51
2000	5.34	7.00	3.00
2500	7.31	8.93	4.93
3000	8.31	10.51	4.93
4000	-21.18	-	-
5000	-21.48	-	-
6000	-21.51	-	-
7000	-21.38	-	-
8000	-21.38	-	-
9000	-21.47	-	-
10000	-21.44	-	-
20000	-21.50	-	-
30000	-21.44	-	-
40000	-21.38	-	-

16K0F3E_460.05 MHz_HIGH POWER

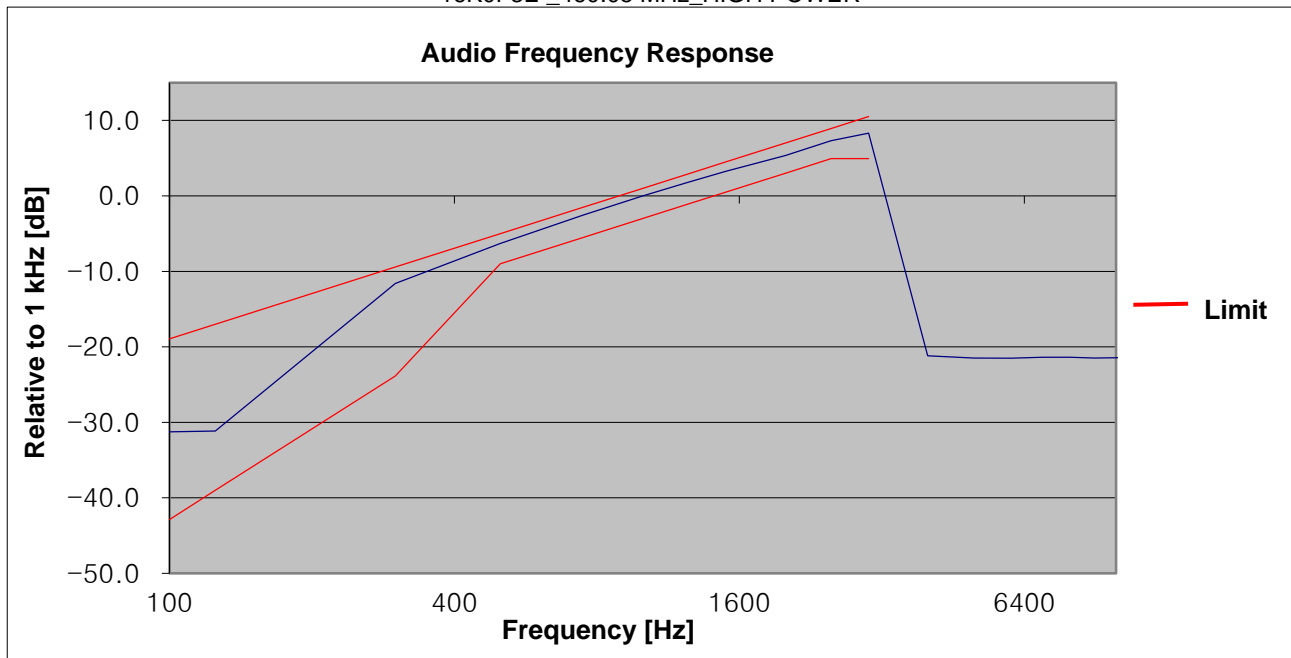

Frequency (Hz)	Attenuation Rel. to 1kHz (dB)	Upper limit (dB)	Lower limit (dB)
100	-29.10	-18.93	-42.86
125	-29.85	-17.00	-39.00
300	-11.52	-9.42	-23.84
500	-6.29	-5.00	-9.00
750	-2.51	-1.49	-5.49
1000	0.00	1.00	-3.00
1250	1.86	2.93	-1.07
1500	3.28	4.51	0.51
2000	5.42	7.00	3.00
2500	7.33	8.93	4.93
3000	8.30	10.51	4.93
4000	-22.20	-	-
5000	-22.66	-	-
6000	-22.68	-	-
7000	-22.59	-	-
8000	-22.62	-	-
9000	-22.71	-	-
10000	-22.58	-	-
20000	-22.71	-	-
30000	-22.70	-	-
40000	-22.66	-	-

16K0F3E _469.95 MHz_HIGH POWER

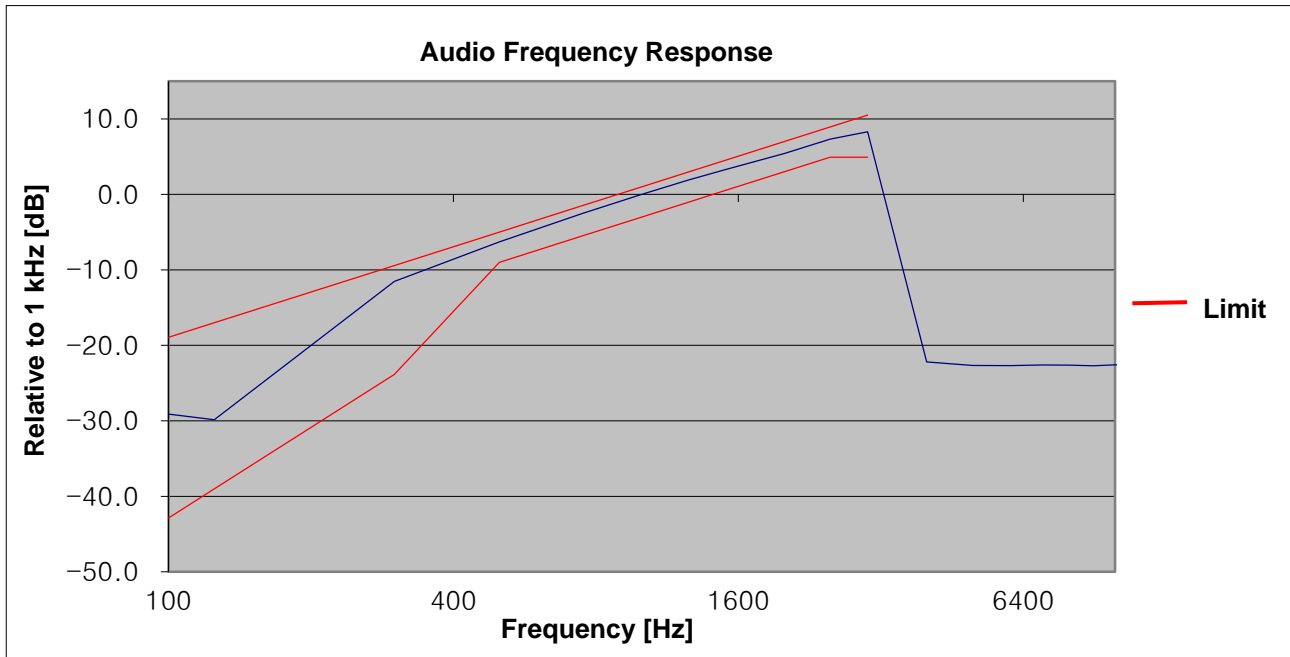

Frequency (Hz)	Attenuation Rel. to 1kHz (dB)	Upper limit (dB)	Lower limit (dB)
100	-30.90	-18.93	-42.86
125	-29.76	-17.00	-39.00
300	-11.57	-9.42	-23.84
500	-6.27	-5.00	-9.00
750	-2.50	-1.49	-5.49
1000	0.00	1.00	-3.00
1250	1.86	2.93	-1.07
1500	3.28	4.51	0.51
2000	5.34	7.00	3.00
2500	7.36	8.93	4.93
3000	8.30	10.51	4.93
4000	-22.27	-	-
5000	-22.90	-	-
6000	-22.83	-	-
7000	-22.90	-	-
8000	-22.94	-	-
9000	-22.94	-	-
10000	-22.90	-	-
20000	-22.92	-	-
30000	-22.88	-	-
40000	-23.03	-	-

16K0F3E _450.05 MHz_LOW POWER

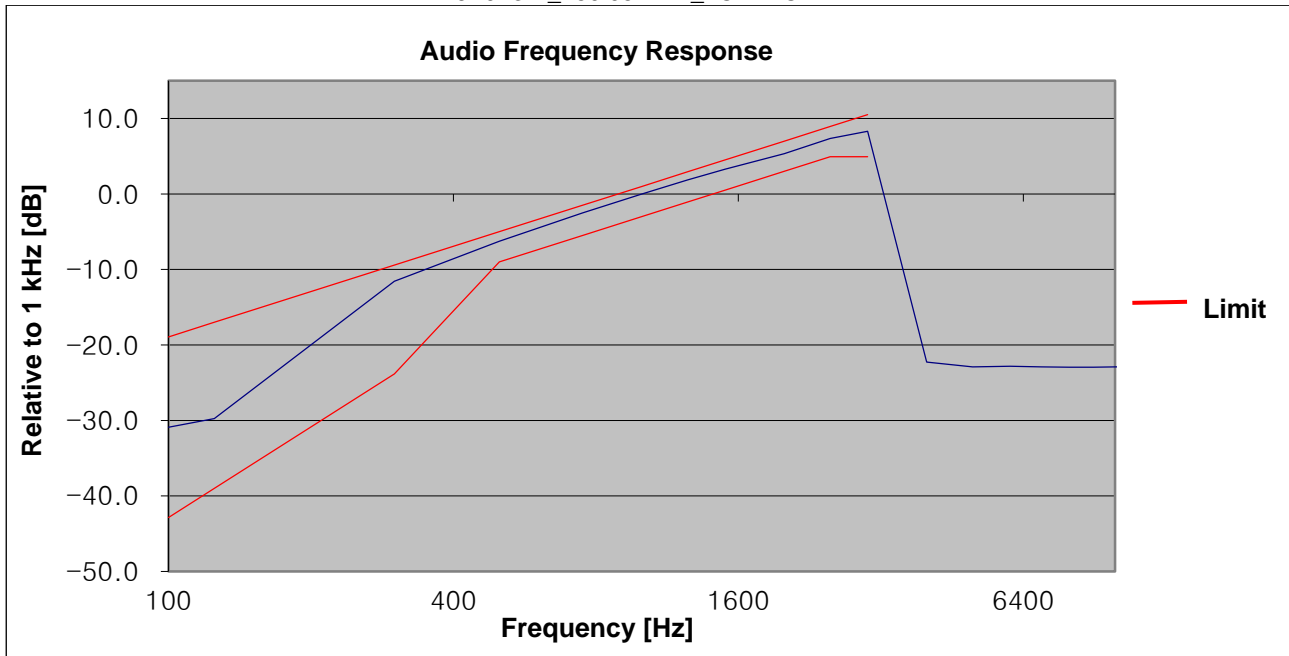

Frequency (Hz)	Attenuation Rel. to 1kHz (dB)	Upper limit (dB)	Lower limit (dB)
100	-34.61	-18.93	-42.86
125	-33.64	-17.00	-39.00
300	-11.62	-9.42	-23.84
500	-6.34	-5.00	-9.00
750	-2.53	-1.49	-5.49
1000	0.00	1.00	-3.00
1250	1.82	2.93	-1.07
1500	3.27	4.51	0.51
2000	5.36	7.00	3.00
2500	7.29	8.93	4.93
3000	8.28	10.51	4.93
4000	-21.38	-	-
5000	-21.35	-	-
6000	-21.43	-	-
7000	-21.48	-	-
8000	-21.37	-	-
9000	-21.32	-	-
10000	-21.40	-	-
20000	-21.40	-	-
30000	-21.26	-	-
40000	-21.35	-	-

16K0F3E _460.05 MHz_ LOW POWER

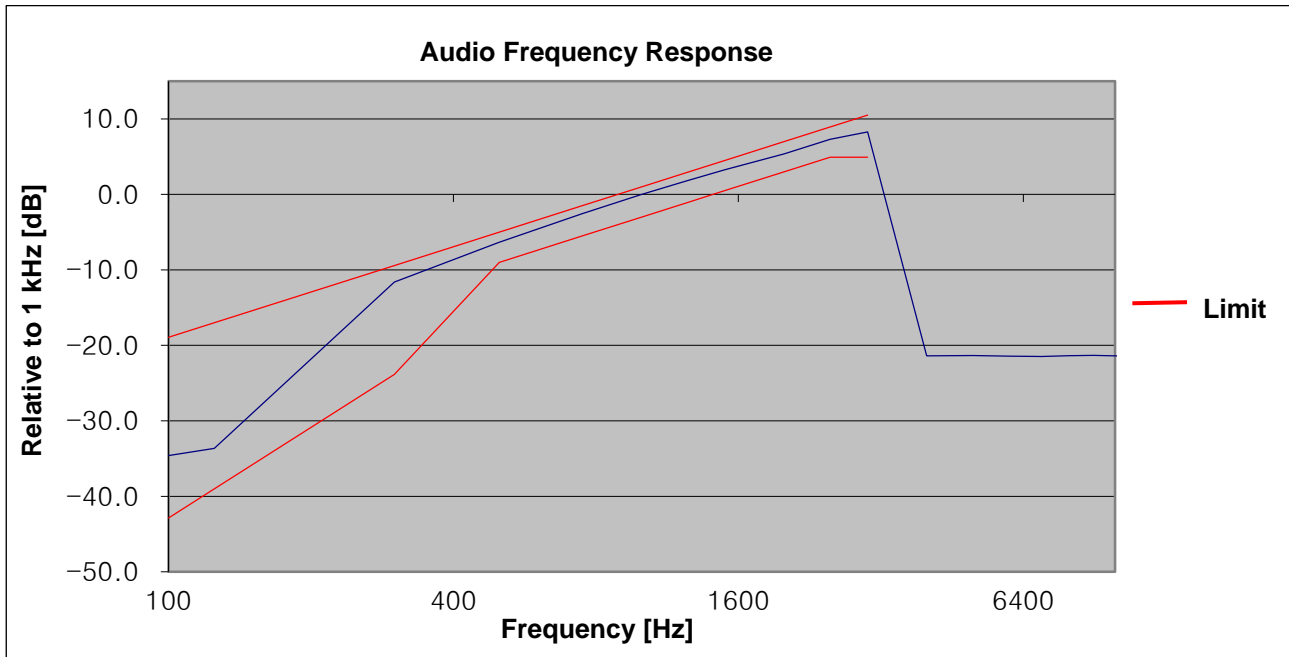

Frequency (Hz)	Attenuation Rel. to 1kHz (dB)	Upper limit (dB)	Lower limit (dB)
100	-27.43	-18.93	-42.86
125	-27.74	-17.00	-39.00
300	-11.51	-9.42	-23.84
500	-6.21	-5.00	-9.00
750	-2.46	-1.49	-5.49
1000	0.00	1.00	-3.00
1250	1.88	2.93	-1.07
1500	3.28	4.51	0.51
2000	5.40	7.00	3.00
2500	7.39	8.93	4.93
3000	8.35	10.51	4.93
4000	-21.41	-	-
5000	-22.53	-	-
6000	-22.43	-	-
7000	-22.46	-	-
8000	-22.52	-	-
9000	-22.53	-	-
10000	-22.43	-	-
20000	-22.49	-	-
30000	-22.60	-	-
40000	-22.56	-	-

16K0F3E_469.95 MHz_ LOW POWER

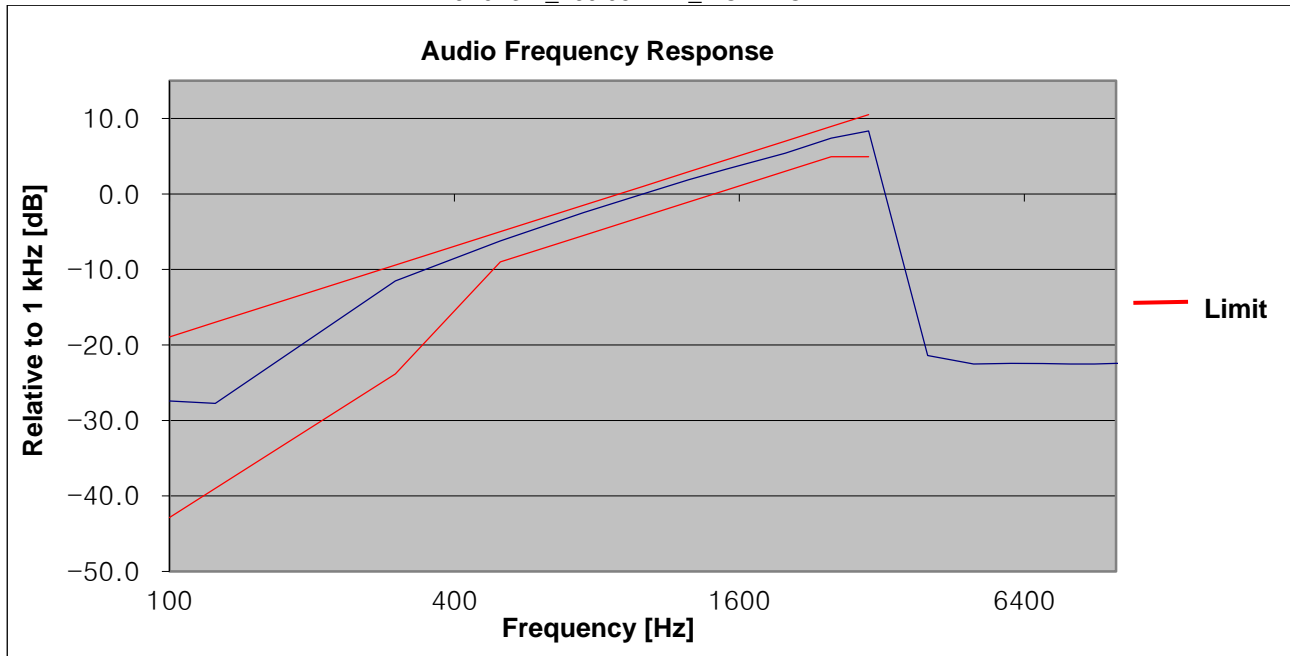

7.6 Emission Mask

■ Definition

The transmitter sideband spectrum denotes the sideband power produced at a discrete frequency separation from the carrier up to the test bandwidth (see 1.3.4.4) due to all sources of unwanted noise within the transmitter in a modulated condition.

■ TEST CONFIGURATION

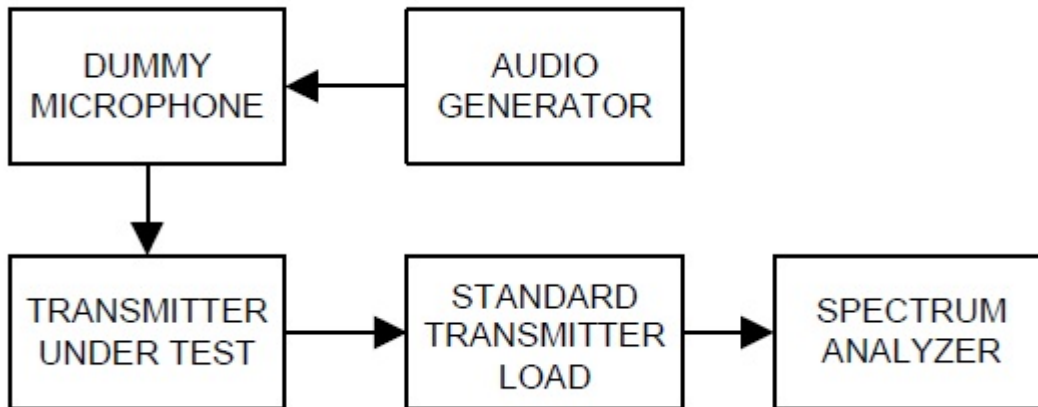

■ TEST PROCEDURE

According to 2.2.11 in TIA-603-E Standard.

- a) Connect the equipment as illustrated. Use the table to determine the spectrum analyzer resolution bandwidth:

Frequency Band (MHz)	Mask for Equipment with Audio Low Pass Filter	Mask for Equipment without Low Pass Filter	Spectrum Analyzer Resolution Bandwidth (Hz)
25-50	B	C	300
72-76	B	C	300
138-174	NTIA	NTIA	300
150-174	B	C	300
150-174	D or E	D or E	100
406-420	NTIA	NTIA	300
421-512	B	C	300
421-512	D or E	D or E	100
806-821/851-866	B or EA	G or EA	300
821-824/866-869	B	H	300
896-901/935-940	I	J	300

- b) Adjust the spectrum analyzer for the following settings:
 - 1) Resolution Bandwidth per the above table
 - 2) Video Bandwidth at least 10 times the resolution bandwidth.
 - 3) Sweep Speed slow enough to maintain measurement calibration.
 - 4) Detector Mode = Positive Peak.
 - 5) Span that will allow proper viewing of the test bandwidth (see 1.3.4.4).
- c) Set the center frequency of the spectrum analyzer to the assigned transmitter frequency. Key the transmitter, and set the level of the unmodulated carrier to a full scale reference line.
This is the 0 dB reference for the measurement.
- d) Modulate the transmitter with a 2500 Hz sine wave at an input level 16 dB greater than that necessary to produce 50% of rated system deviation. The input level shall be established at the frequency of maximum response of the audio modulating circuit. Transmitters employing digital modulation techniques that bypass the limiter and the audio low-pass filter shall be modulated as specified by the manufacturer.
- e) Record the resulting spectrum analyzer presentation of the emission level with an on-line recording device or in a photograph. It is recommended that the emission limit (as given in 3.2.11) be drawn on the plotted graph or photograph. The spectrum analyzer presentation is the sideband spectrum.

■ Plots of Emission Mask

(11K0F3E _ 450.05 MHz)_High

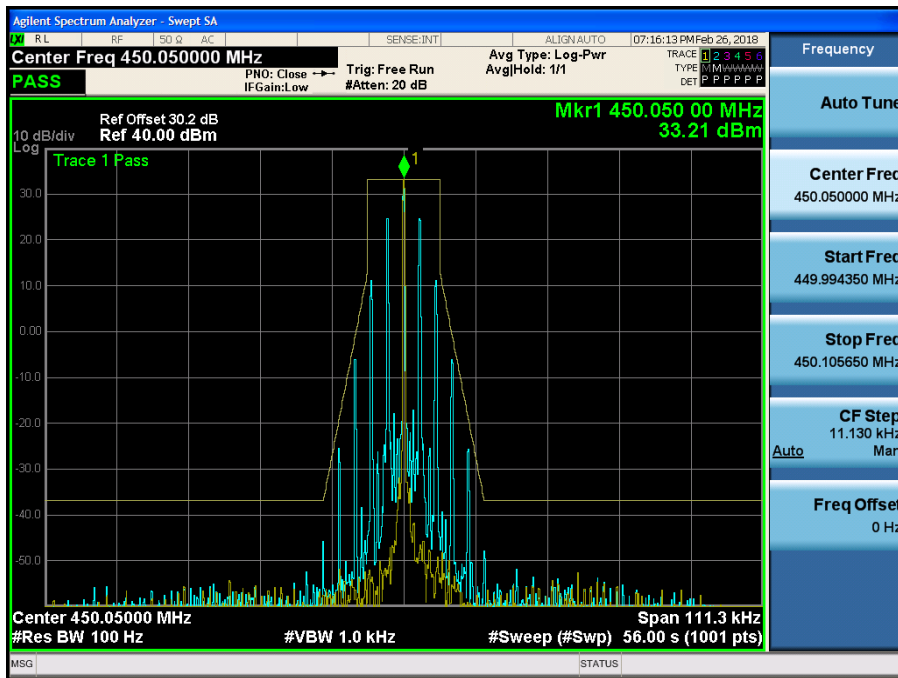

(11K0F3E _ 460.05 MHz)_High

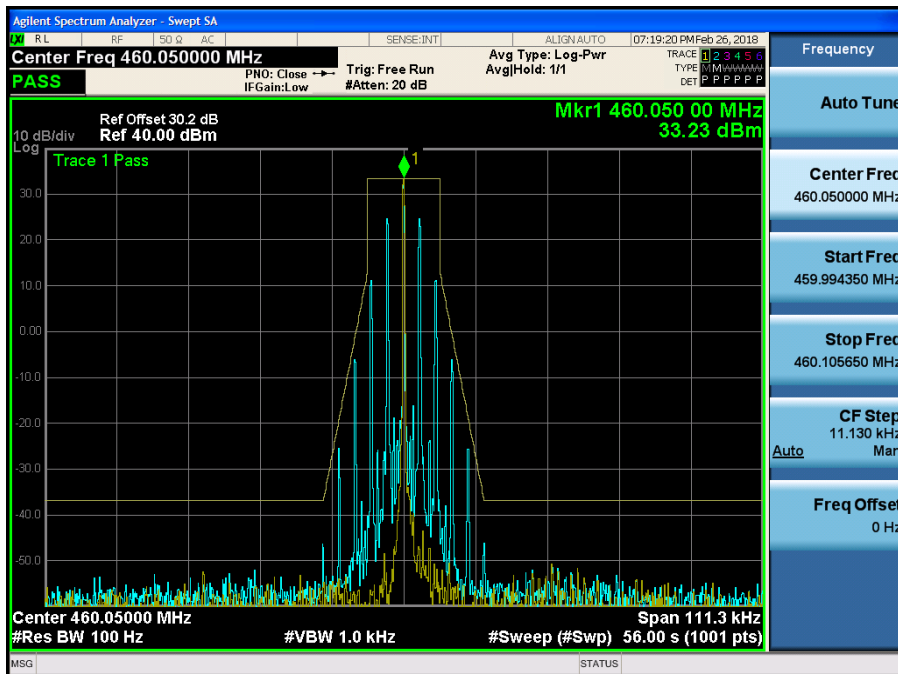

(11K0F3E _ 469.95 MHz)_High

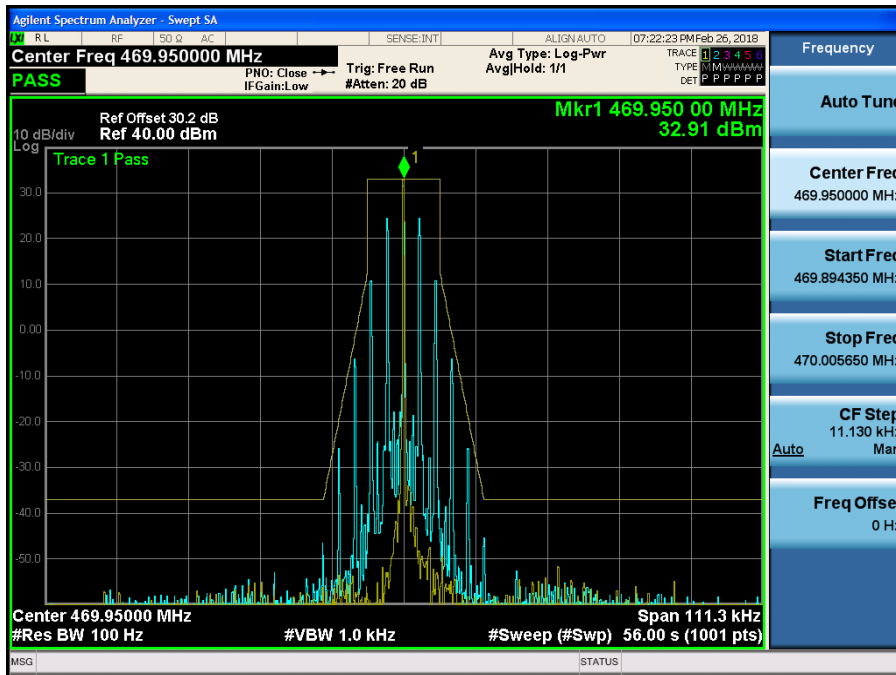

(11K0F3E _ 450.05 MHz)_Low

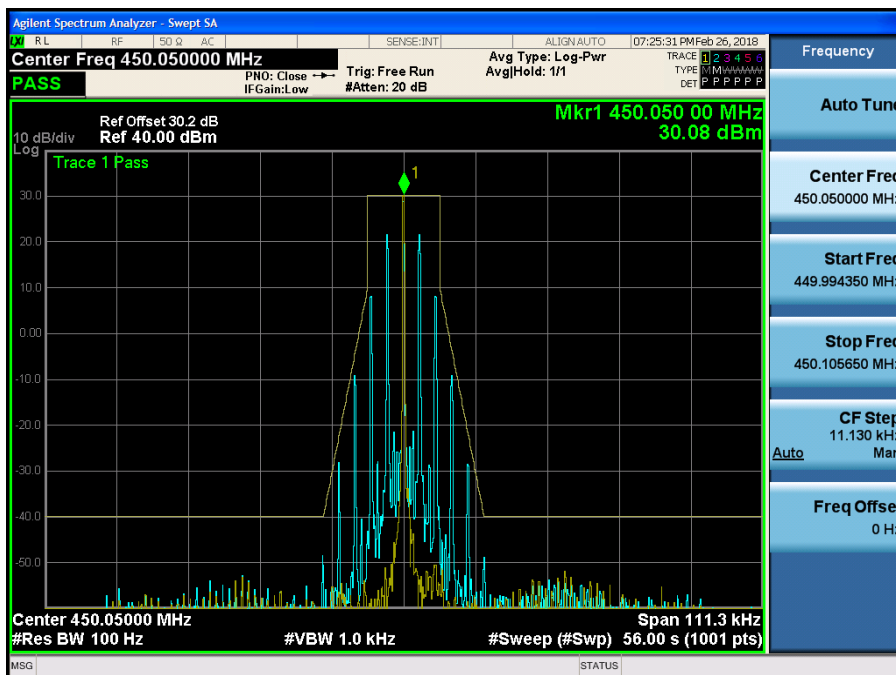

(11K0F3E _ 460.05 MHz)_Low

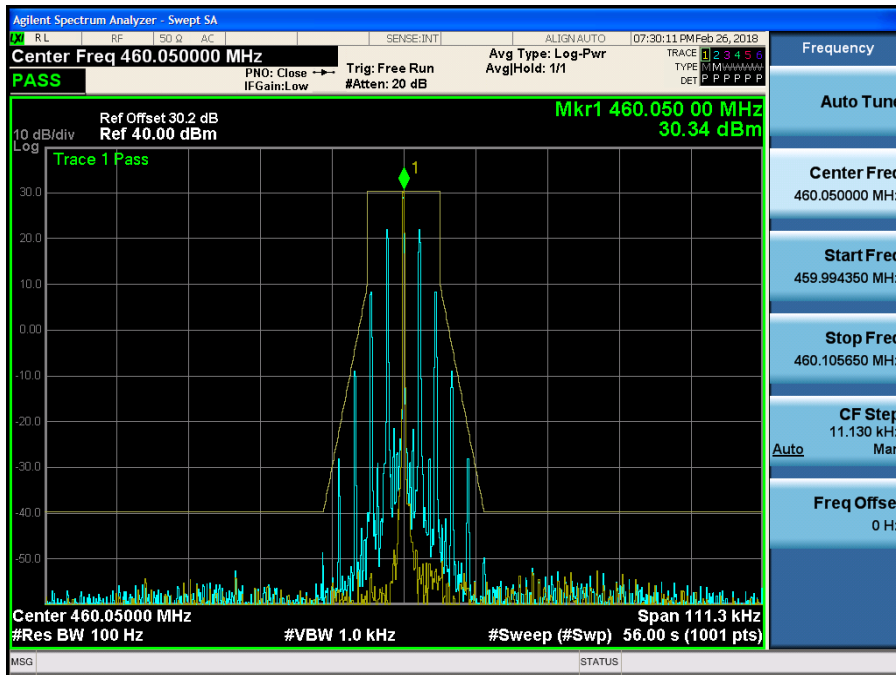

(11K0F3E _ 469.95 MHz)_Low

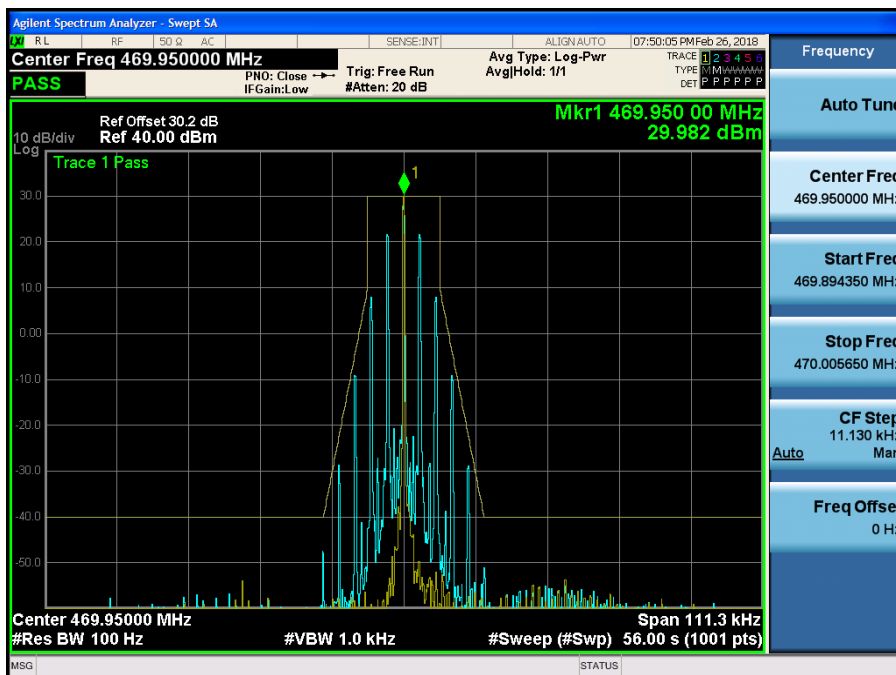

(16K0F3E _ 450.05 MHz)_High

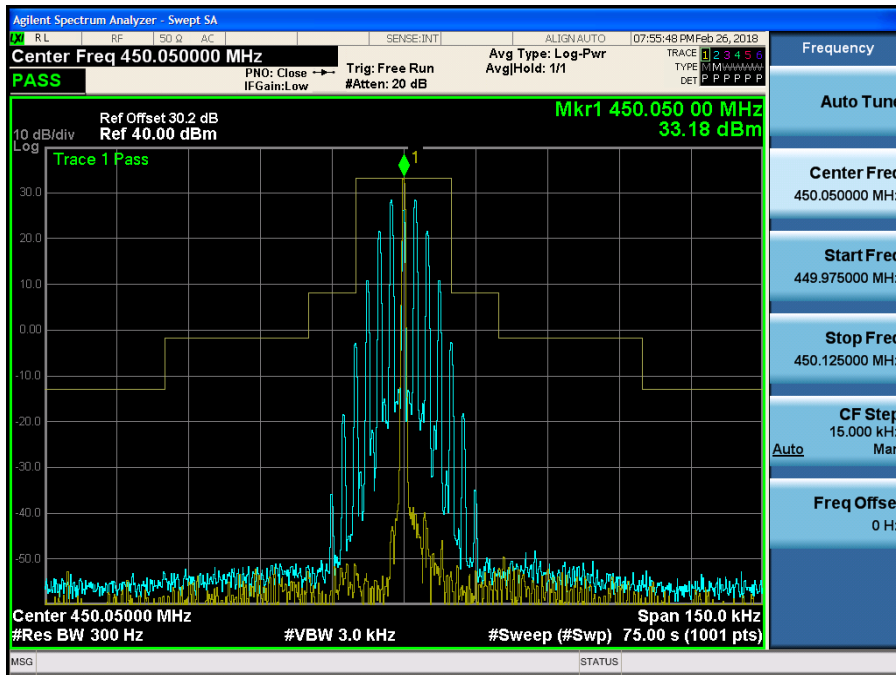

(16K0F3E _ 460.05 MHz)_High

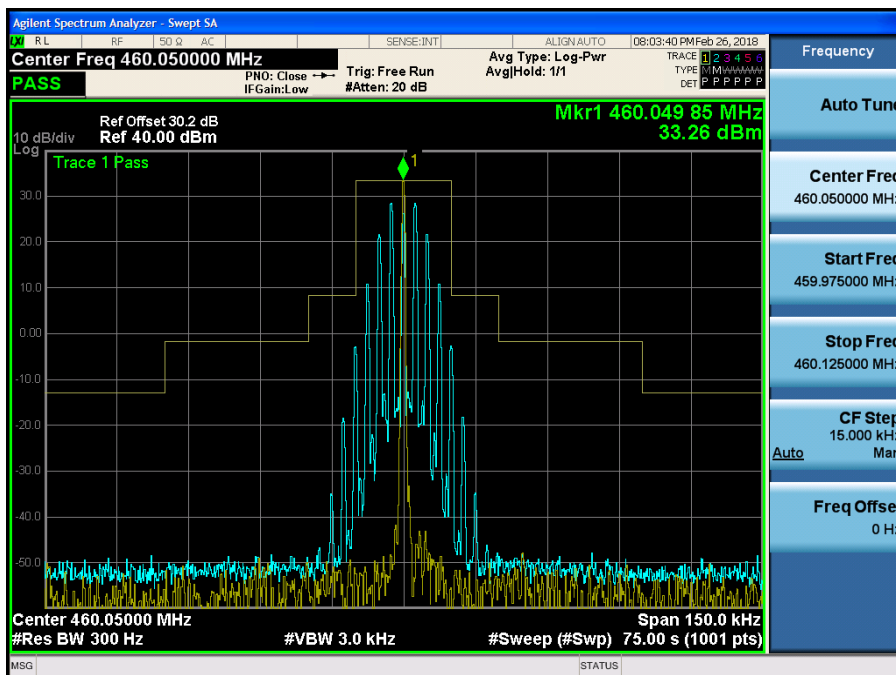

(16K0F3E _ 469.95 MHz)_High

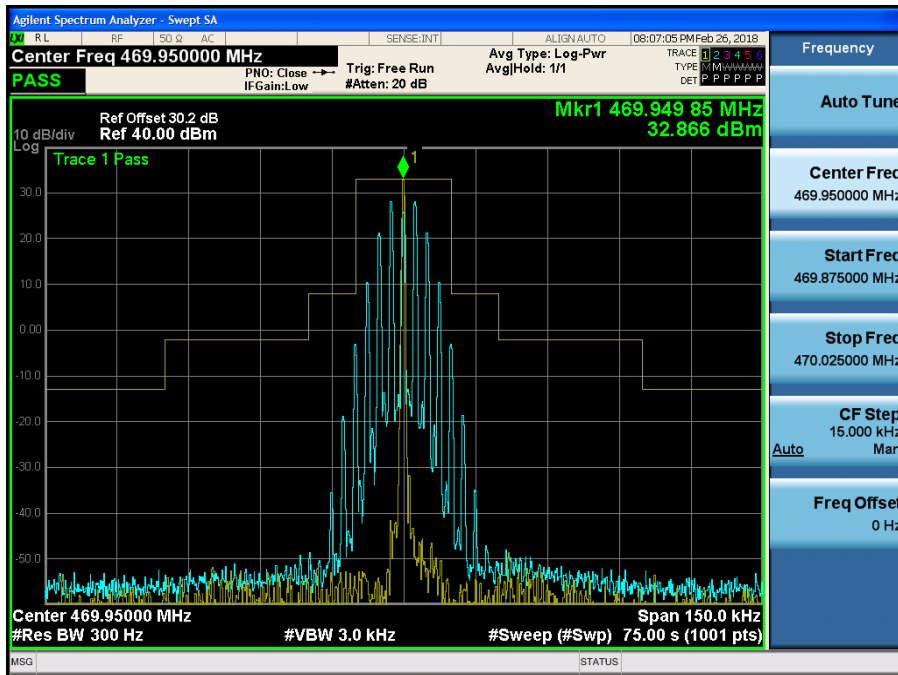

(16K0F3E _ 450.05 MHz)_Low

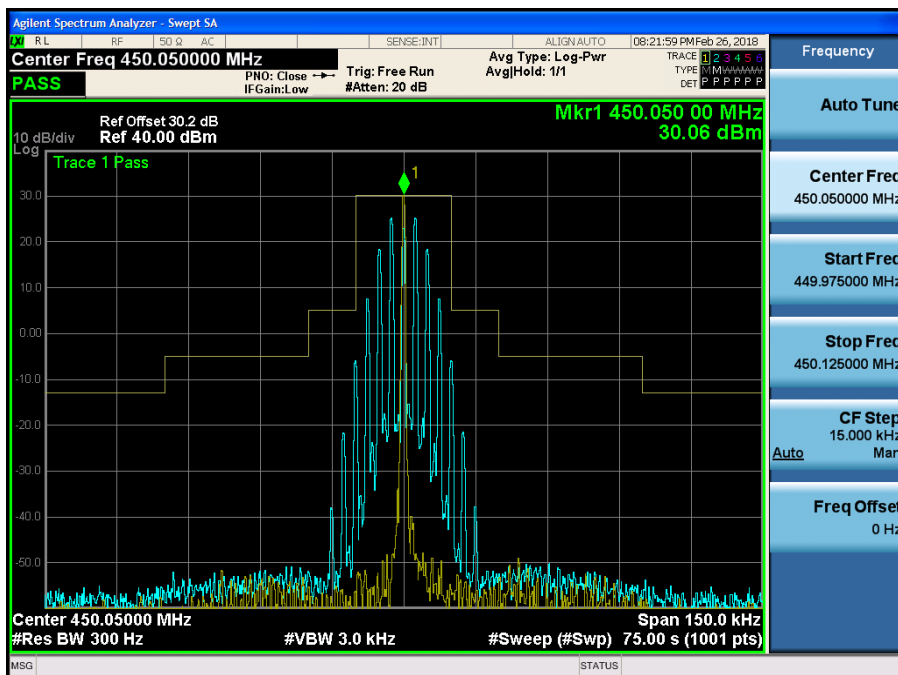

(16K0F3E _ 460.05 MHz)_Low

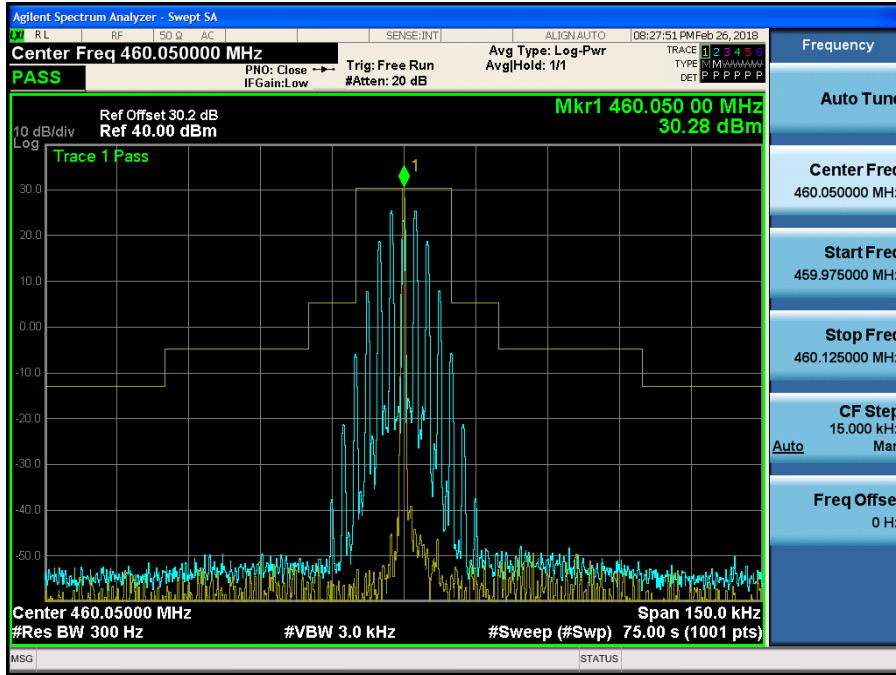

(16K0F3E _ 469.95 MHz)_Low

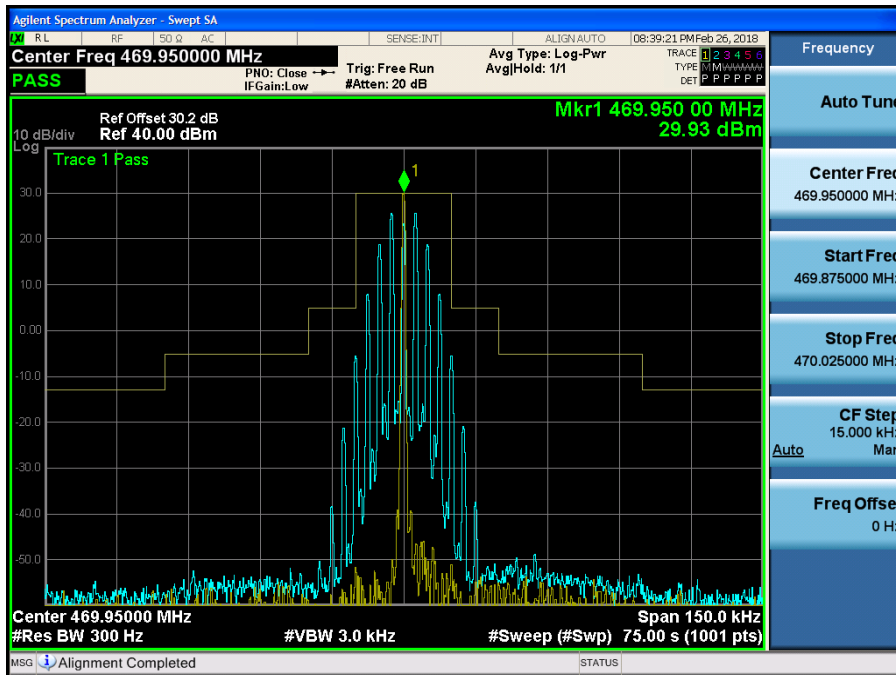

(8K30F1E, 8K30F1D, 8K30F7W _ 450.05 MHz)_High

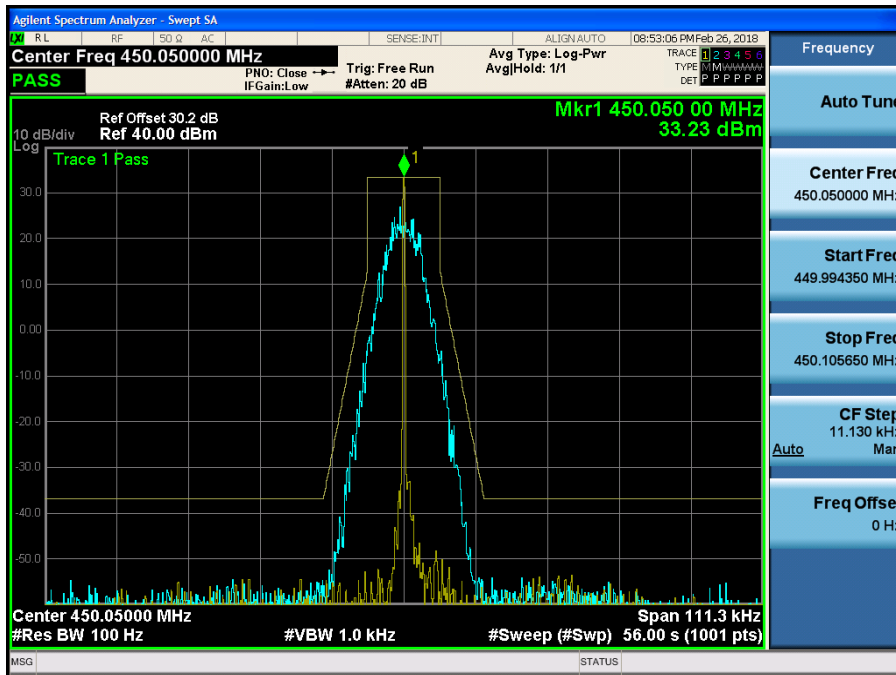

(8K30F1E, 8K30F1D, 8K30F7W _ 460.05 MHz)_High

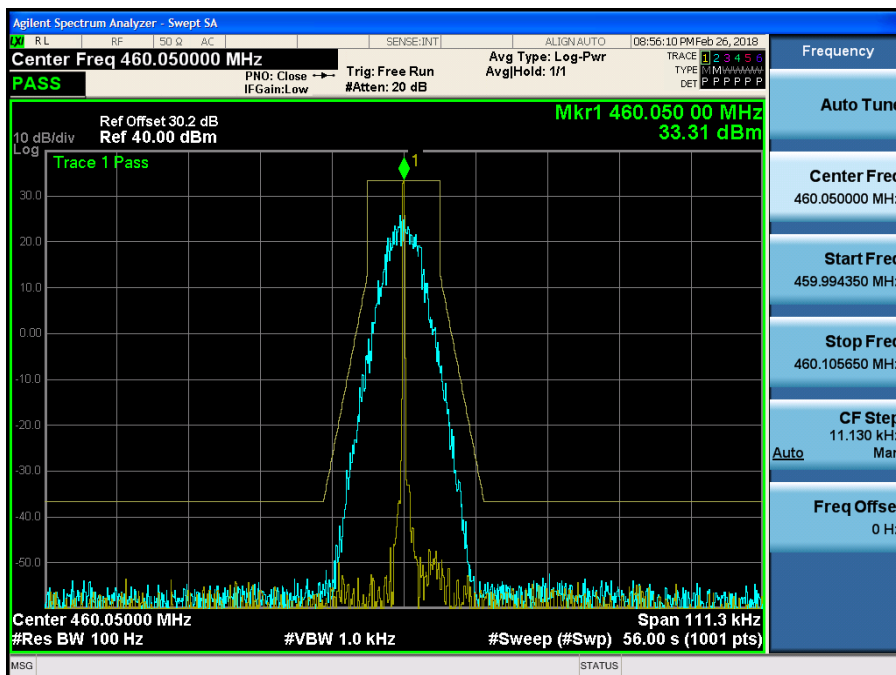

(8K30F1E, 8K30F1D, 8K30F7W _ 469.95 MHz)_High

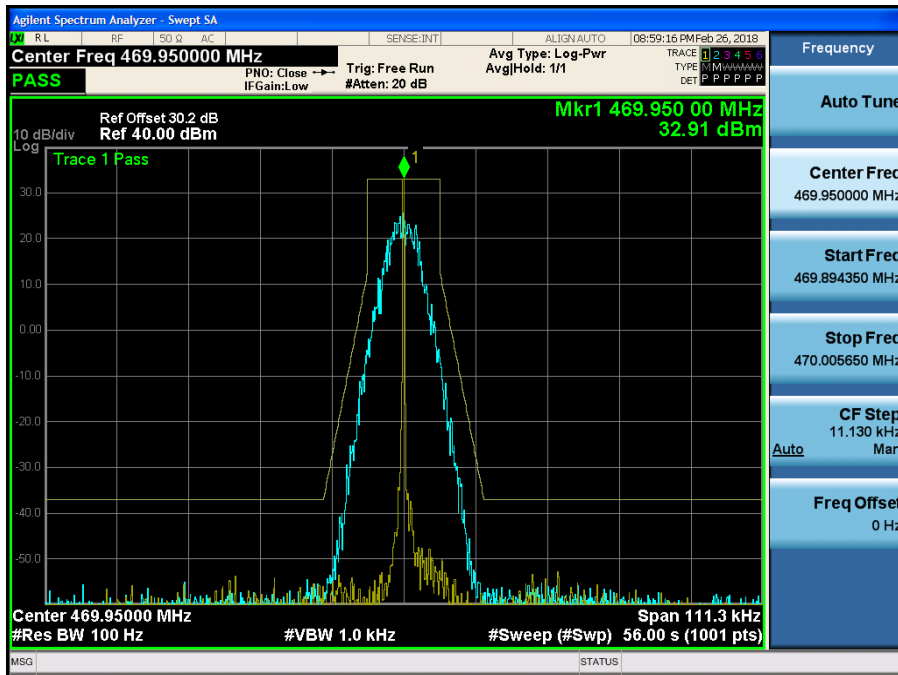

(8K30F1E, 8K30F1D, 8K30F7W _ 450.05 MHz)_Low

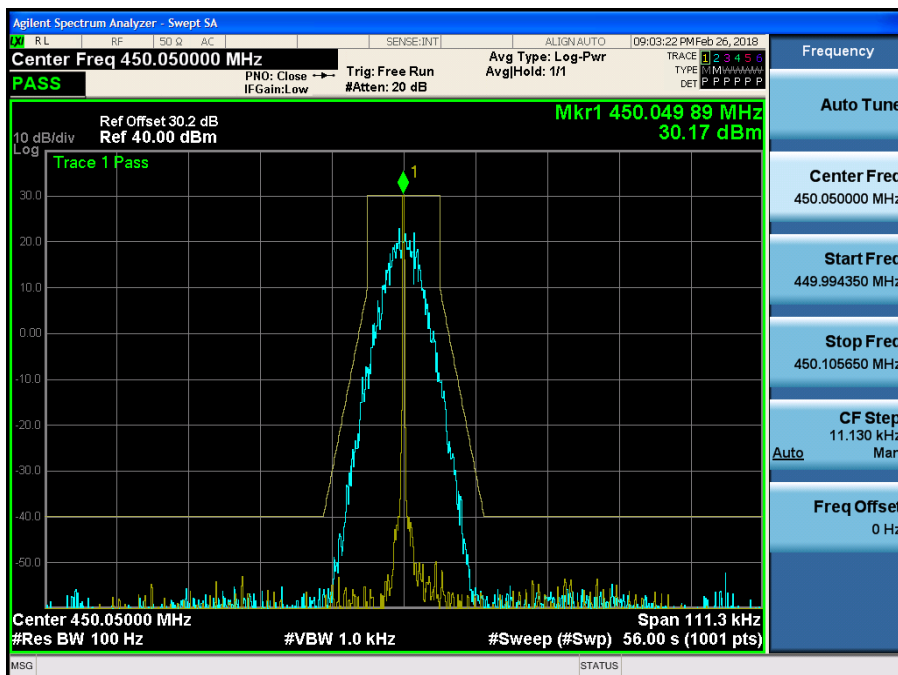

(8K30F1E, 8K30F1D, 8K30F7W _ 460.05 MHz)_Low

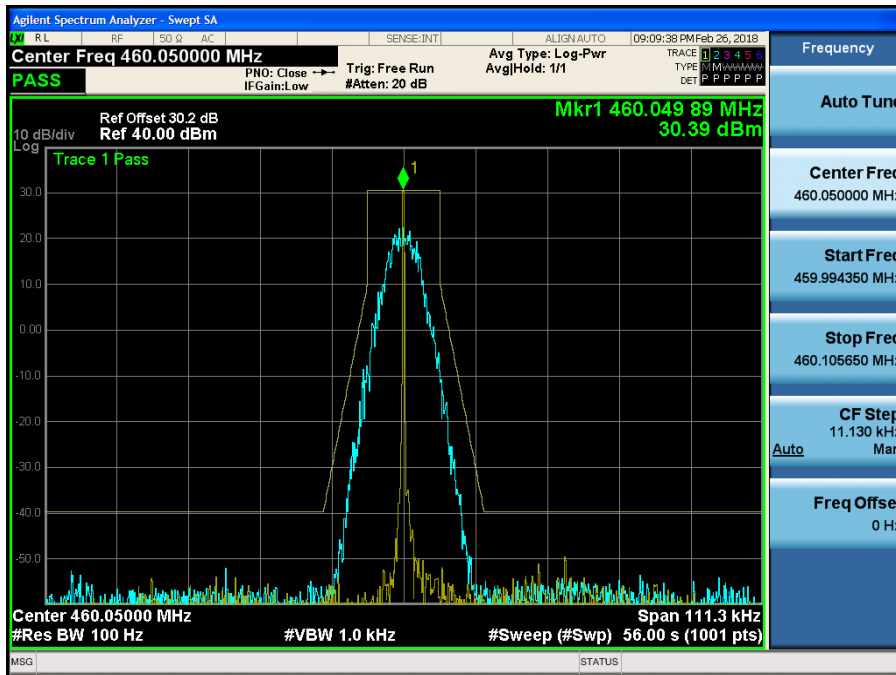

(8K30F1E, 8K30F1D, 8K30F7W _ 469.95 MHz)_Low

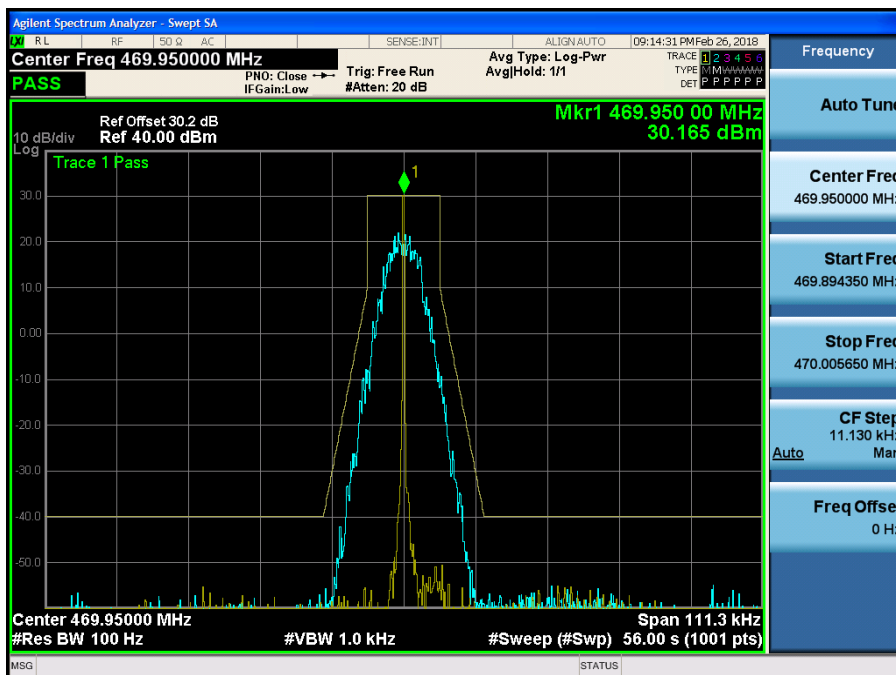

(4K00F1E, 4K00F1D, 4K00F7W _ 450.05 MHz)_High

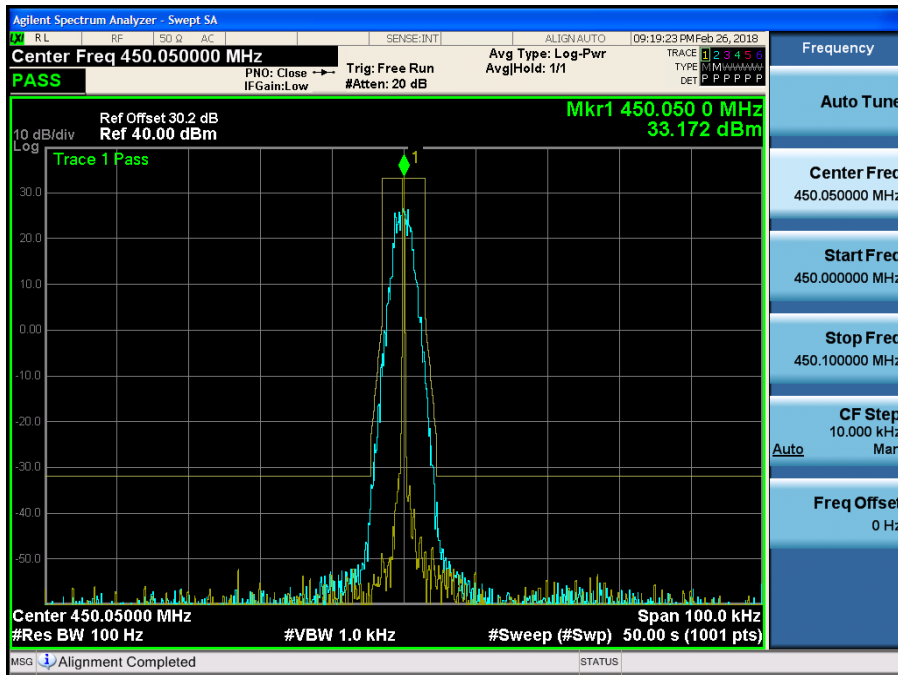

(4K00F1E, 4K00F1D, 4K00F7W _ 460.05 MHz)_High

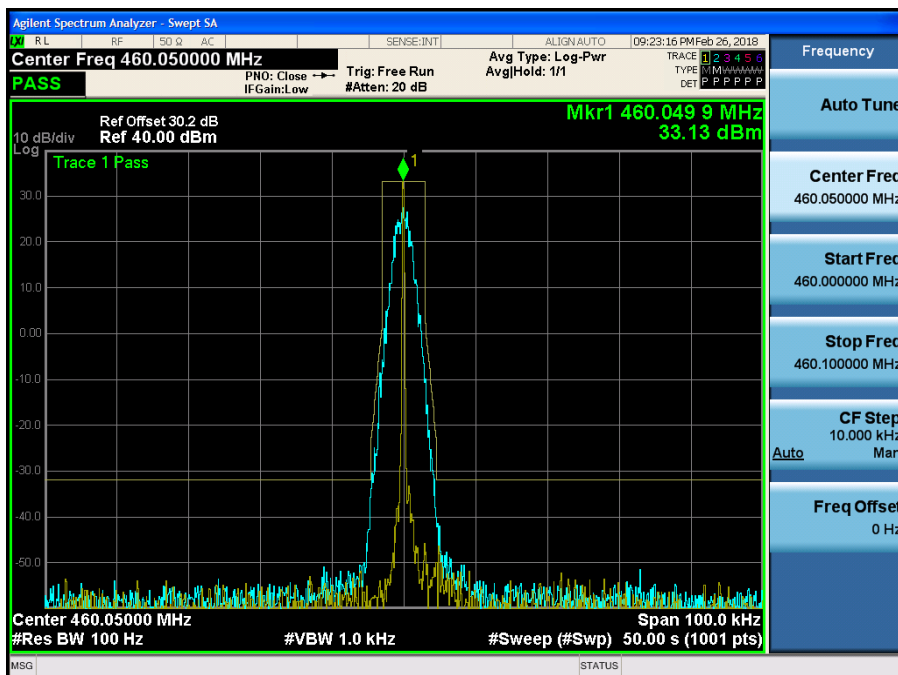

(4K00F1E, 4K00F1D, 4K00F7W _ 469.95 MHz)_High

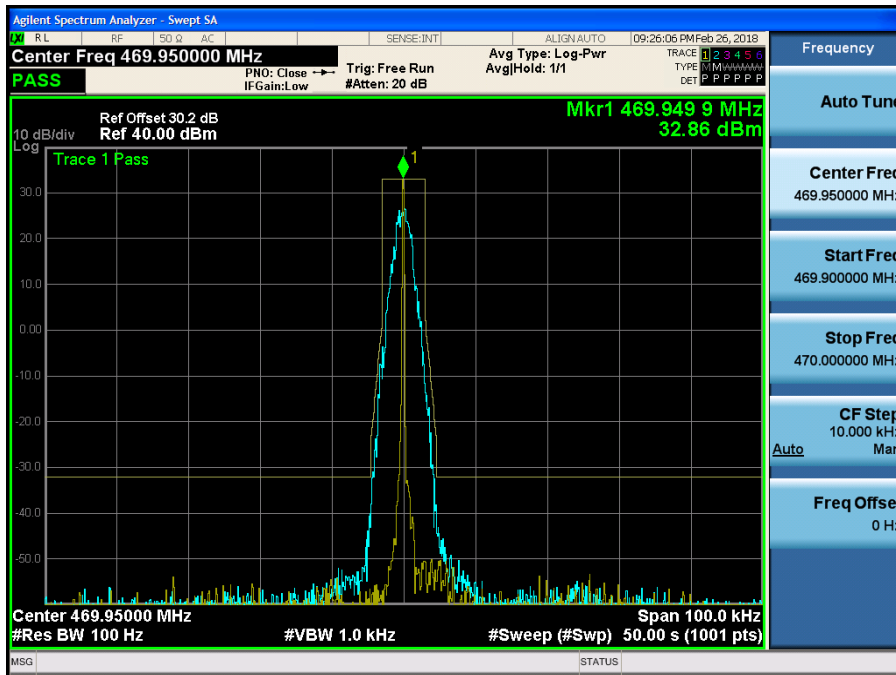

(4K00F1E, 4K00F1D, 4K00F7W _ 450.05 MHz)_Low

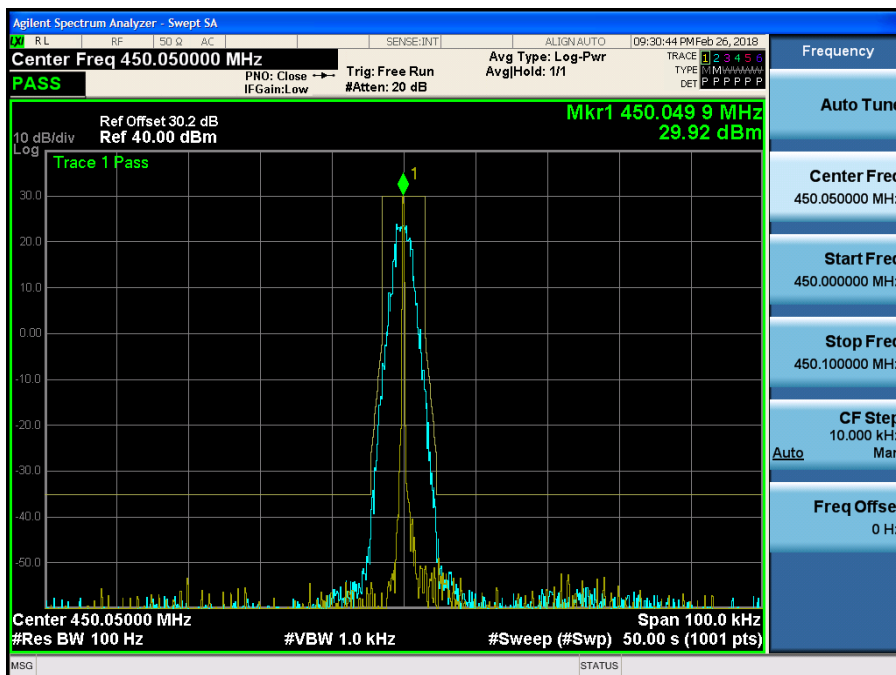

(4K00F1E, 4K00F1D, 4K00F7W _ 460.05 MHz)_Low

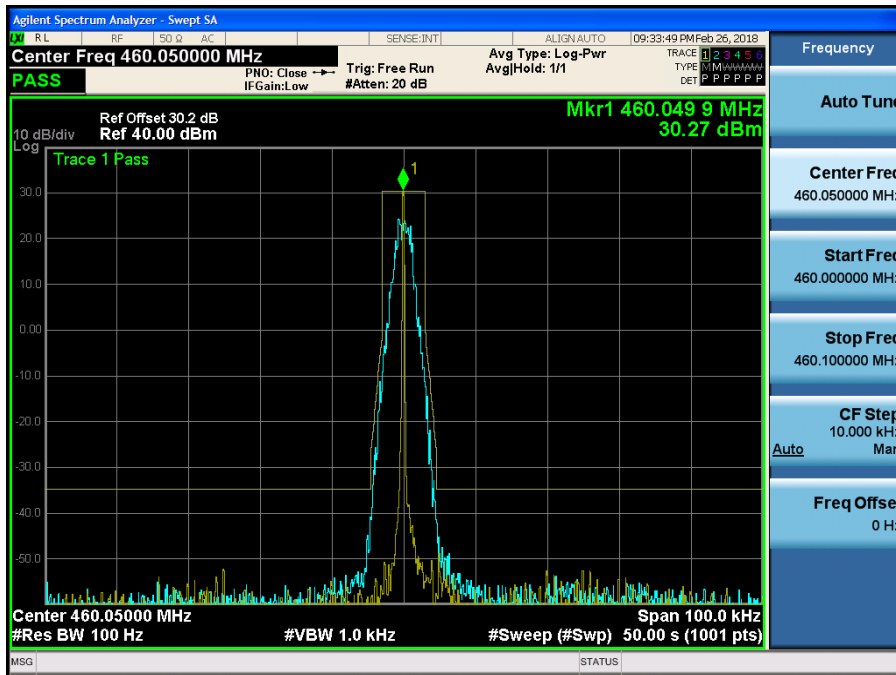

(4K00F1E, 4K00F1D, 4K00F7W _ 469.95 MHz)_Low

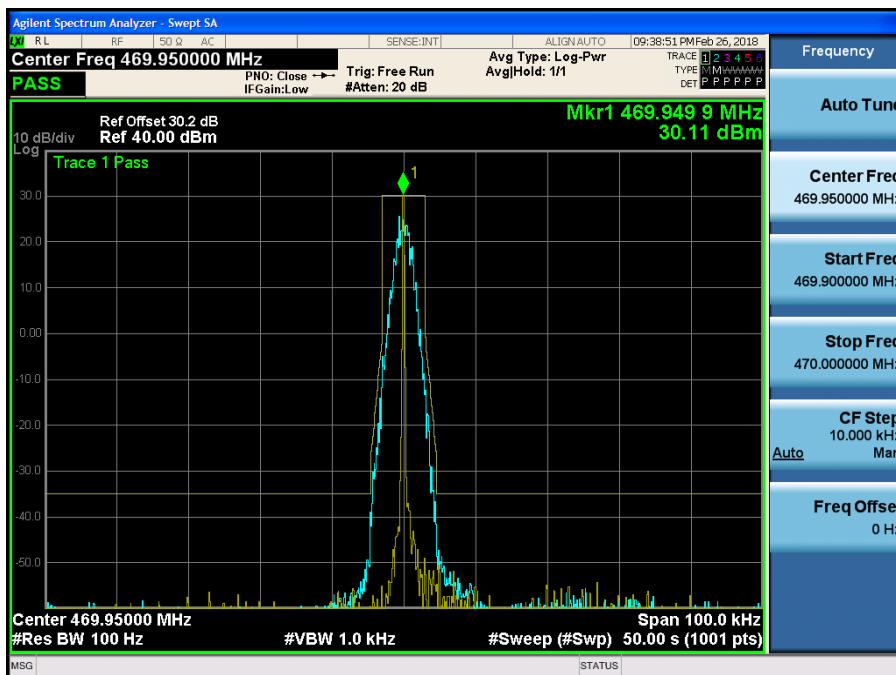

(4K00F2D _ 450.05 MHz)_High

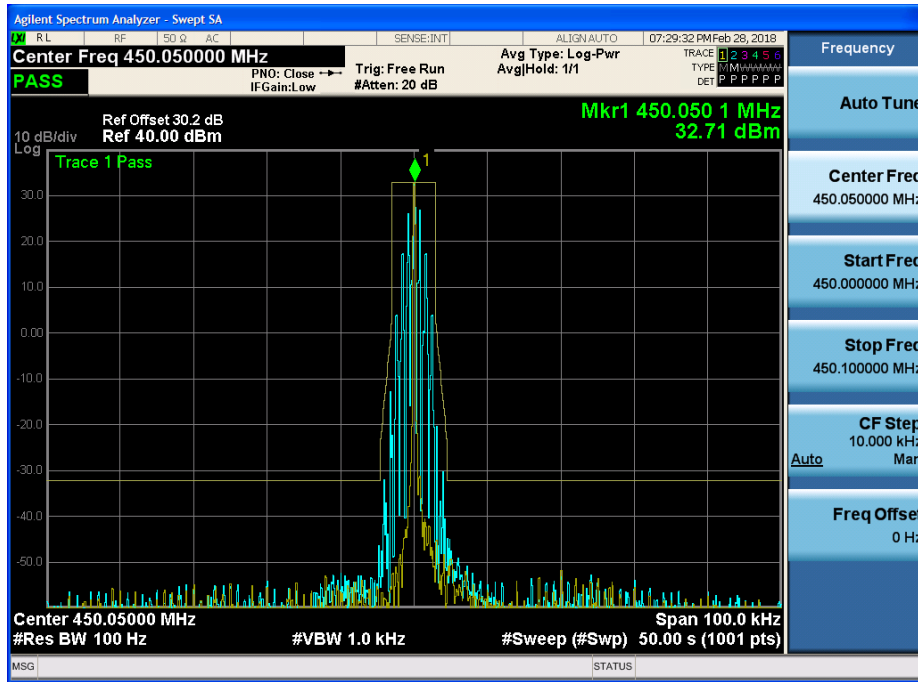

(4K00F2D _ 460.05 MHz)_High

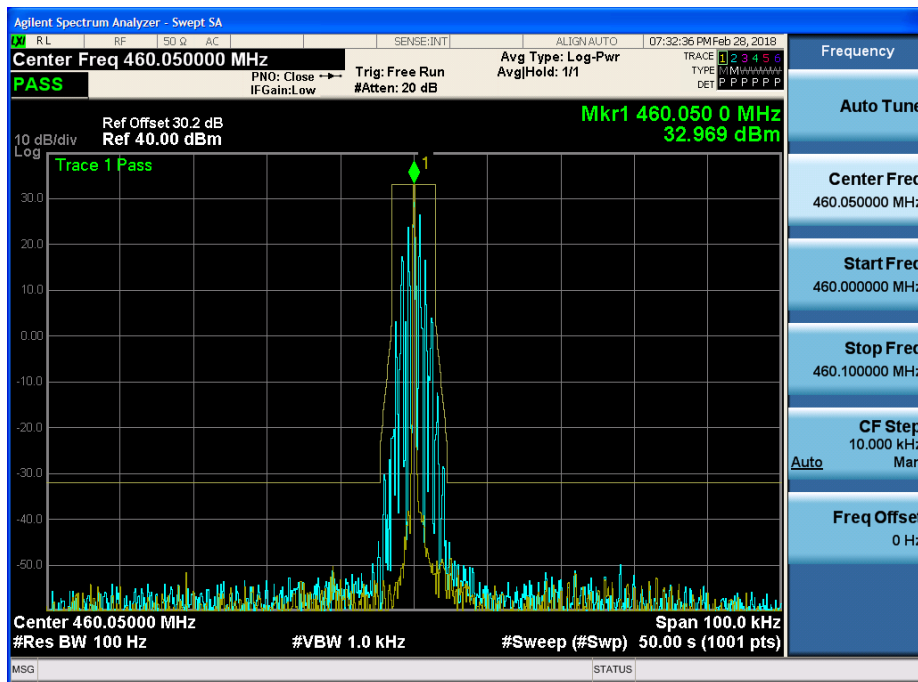

(4K00F2D _ 469.95 MHz)_High

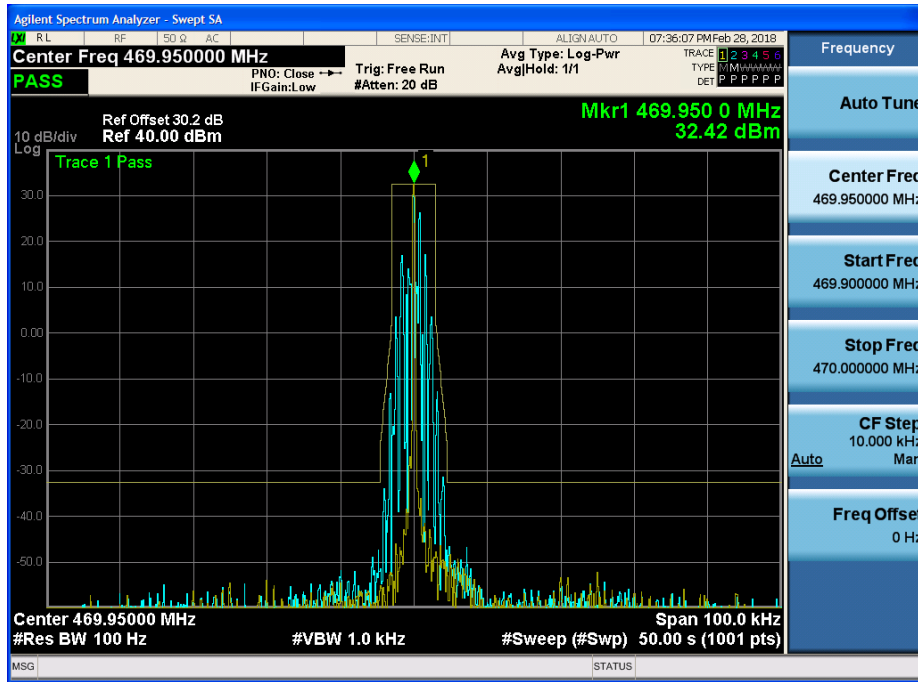

(4K00F2D _ 450.05 MHz)_Low

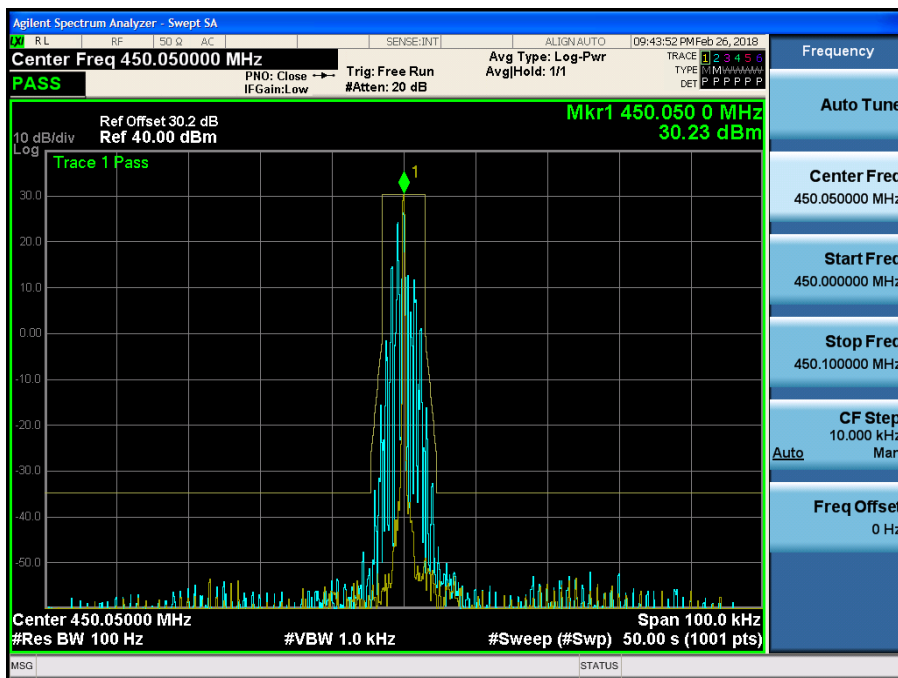

(4K00F2D _ 460.05 MHz)_Low

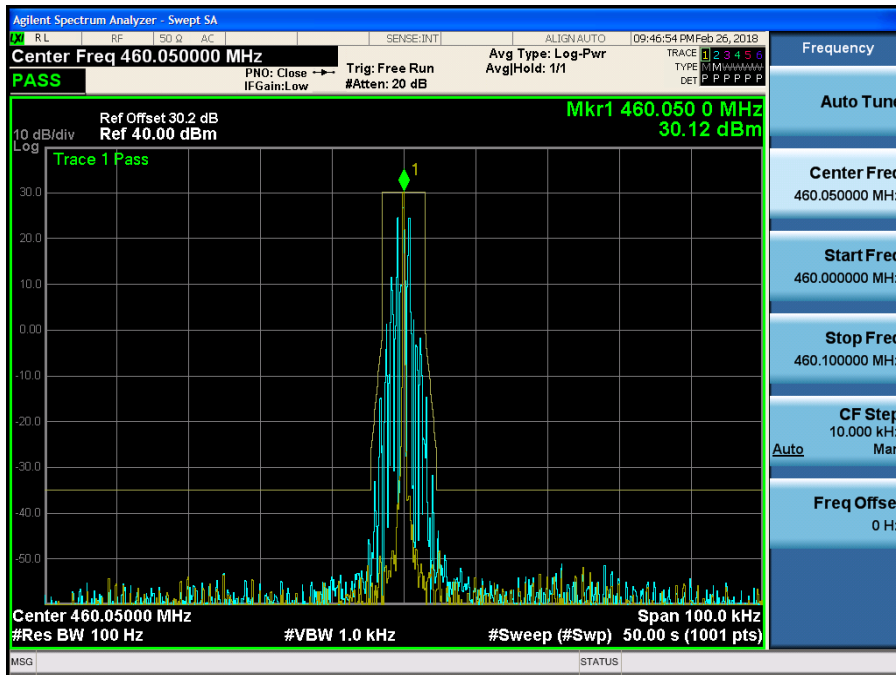

(4K00F2D _ 469.95 MHz)_Low

