

# TEST REPORT

**REGULATIONS :**      **FCC Part15 C §15.247**  
    **RSS-247 Issue 2**

Applicant	Testing Laboratory
JVC KENWOOD Corporation  1-16-2, Hakusan, Midori-ku, Yokohama-shi Kanagawa, 226-8525 Japan Tel.: +81 45 939 6254 / Fax.: +81 45 939 6261	Intertek Japan K.K.      Matsuda Laboratory (Open area test site) 1283 Yadoriki, Matsuda-machi, Ashigarakami-gun, Kanagawa-ken, 258-0001 Japan Tel.: +81 465 89 2316      Fax.: +81 465 89 2160 URL: <a href="http://www.japan.intertek-etlsemko.com">http://www.japan.intertek-etlsemko.com</a>

<b>Equipment Type</b>	Bluetooth Module
<b>Trademark</b>	KENWOOD
<b>Model(s)</b>	J7C-0037
<b>Serial No.</b>	6X140404 (for Radiated testing) 6X140403 (for Antenna Port Conductive testing)
<b>FCC ID</b>	K44479250
<b>ISED CN and UPN</b>	282F-479250
<b>Test Result</b>	Complied
<b>Report Number</b>	18040322JMA-001
<b>Original Issue Date</b>	July 11, 2018

This report is for the exclusive use of Intertek's Client and is provided pursuant to the agreement between Intertek and its Client. Intertek's responsibility and liability are limited to the terms and conditions of the agreement. Intertek assumes no liability to any party, other than to the Client in accordance with the agreement, for any loss, expense or damage occasioned by the use of this report. Only the Client is authorized to permit copying or distribution of this report and then only in its entirety. Any use of the Intertek name or one of its marks for the sale or advertisement of the tested material, product or service must first be approved in writing by Intertek. The observations and test results in this report are relevant only to the sample tested. This report by itself does not imply that the material, product, or service is or has ever been under an Intertek certification program.

Approved by   
 Hideaki Kosemura  
 [ Reviewer ]

Tested by   
 Naohei Murakami  
 [ Engineer ]



Responsible Party of Test Item (Product)

Responsible Party	:
Add.	:
Tel.	:
Fax.	:
Contact Person	:

## **TABLE OF CONTENTS**

---

	Page
<b>SECTION 1. GENERAL INFORMATION .....</b>	<b>3</b>
<b>SECTION 2. SUMMARY OF TEST RESULTS .....</b>	<b>4</b>
<b>SECTION 3. EQUIPMENT UNDER TEST .....</b>	<b>5</b>
<b>SECTION 4. SUPPORT EQUIPMENT .....</b>	<b>6</b>
<b>SECTION 5. USED CABLE(S) .....</b>	<b>7</b>
<b>SECTION 6. TEST CONFIGURATION .....</b>	<b>8</b>
<b>SECTION 7. OPERATING CONDITION .....</b>	<b>9</b>
<b>SECTION 8. UNCERTAINTY .....</b>	<b>10</b>
<b>SECTION 9. TEST DATA .....</b>	<b>11</b>
9.1 6 dB Bandwidth and 99 % Occupied Bandwidth .....	11
9.2 Maximum Peak Output Power .....	12
9.3 Radiated Spurious Emissions and Band Edge of Restrict Band .....	13
9.4 Band Edge of Authorized Frequency Band .....	17
9.5 Spurious RF Conducted Emissions .....	19
9.6 Power Density .....	20
9.7 AC Conducted Emissions .....	21
9.8 Receiver Spurious Emissions .....	24
<b>SECTION 10. LIST AND DIAGRAM OF MEASURING INSTRUMENTS .....</b>	<b>25</b>
<b>ANNEX .....</b>	<b>31</b>
A. HARD COPY OF SPECTRUM PLOTS .....	32
B. PHOTOGRAPHS OF EMISSION SET-UP .....	48
C. PHOTOGRAPHS OF EUT Axis .....	53

---

## SECTION 1. GENERAL INFORMATION

### Test Performed

<b>EUT Received</b>	May 15, 2018	
<b>Date of Test</b>	From May 16, 2018 to July 9, 2018	
<b>Standard Applied</b>	FCC	ISED
	FCC Part15 C §15.247	RSS-247 Issue 2
<b>Test methods</b>	KDB 558074 D01 DTS Meas Guidance v04	RSS-Gen Issue 5 ANSI C63.10-2013
<b>Deviation from Standard(s)</b>	None	

### Qualifications of Testing Laboratory (Matsuda Lab.)

Accreditation	Scope	Lab. Code	Remarks
VLAC	EMC Testing	VLAC-008-3	JAPAN
BSMI	EMC Testing	SL2-IN-E-6009	TAIWAN
<b>Filing</b>			
VCCI	EMC Testing	A-0127	JAPAN
FCC	EMC Testing	Designation Number : JP0009	USA
ISED	EMC Testing	2042S-1, 2042S-2, 2042S-3	Canada
CB-Scheme	EMC Testing	TL223	IECEE
SAUDI ARABIA	EMC Testing	N/A	

### Abbreviations

EUT	Equipment Under Test	DoC	Declaration of Conformity
AMN	Artificial Mains Network	ISN	Impedance Stabilization Network
LISN	Line Impedance Stabilization Network	Q-P	Quasi-peak
AMP	Amplifier	AVG	Average
ATT	Attenuator	PK	Peak
ANT	Antenna	Cal	Calibration
BBA	Broadband Antenna	N/A	Not applicable or Not available
DIP	Dipole Antenna	LCD	Liquid-Crystal Display
AE	Associated Equipment	HDMI	High-Definition Multimedia Interface
AFH	Adaptive Hopping Frequency		

## SECTION 2. SUMMARY OF TEST RESULTS

Test Item	Specification	Results	Detail
6 dB Bandwidth and 99 % Occupied Bandwidth	FCC Part15C §15.247 (a) (2) RSS-247 5.2 (a) RSS-Gen 6.7	PASS	Section 9.1
Maximum Peak Output Power	FCC Part15C §15.247 (b) RSS-247 5.4 (d)	PASS	Section 9.2
Radiated Spurious Emissions and Restrict Band edge	FCC Part15C §15.209, §15.205 RSS-247 5.5 RSS-Gen 8.9	PASS	Section 9.3
Band Edge of Authorized Frequency Band	FCC Part15C §15.247 (d) RSS-247 5.5	PASS	Section 9.4
Spurious RF Conducted Emissions	FCC Part15C §15.247 (d) RSS-247 5.5	PASS	Section 9.5
Power Density	FCC Part15C §15.247 (e) RSS-247 5.2	PASS	Section 9.6
AC Conducted Emissions	FCC Part15C §15.207 RSS-Gen 8.8	PASS	Section 9.7
Receiver Spurious Emissions	RSS-Gen 7	PASS	Section 9.8

### Limitation on Results

The test result of this report is effective equipment under test itself and under the test configuration described on the report.

This test report does not assure that whether the test result taken in other testing laboratory is compatible or reproducible to the test result on this report or not.

### SECTION 3. EQUIPMENT UNDER TEST

The equipment under test (EUT) consisted of the following apparatus.

#### 3.1 System Configuration

Symbol	Item	Model No.	Serial No.	Manufacturer
A	Bluetooth Module	J7C-0037	6X140404 (for Radiated testing) 6X140403 (for Antenna Port Conductive testing)	JVC KENWOOD Corporation
<b>Rated Power</b> : DC5.4 V $\pm$ 10% (Supply from Support Equipment)				
<b>Supplied Power</b> : DC13.6 V (for Support Equipment)				
<b>Condition of Equipment</b>		Prototype		
<b>Type</b>		Built-in type		
<b>Suppression Devices</b>		No Modifications by the laboratory were made to the device		

#### 3.2 Port(s)/Connector(s)

Port Name	Connector Type	Connector Pin	Remarks
-	-	-	-

#### 3.3 Highest Frequency Generated / Used

Operating Frequency	Board Name	Remarks
4960 MHz	Generated / Bluetooth	-

#### 3.4 Over View of EUT

<b>Access method</b>	Bluetooth Version 4.0 LE
<b>Rated Output Power</b>	2.5 mW
<b>Frequency Range of Operating</b>	2402 – 2480 MHz
<b>Number of Channels</b>	40 ch, 2 MHz step
<b>Modulation Method</b>	GFSK
<b>Antenna Type and Gain</b>	Integrated Printed Antenna, 1.43 dBi See Note 1
<b>Antenna Connector</b>	None

Note:

1. The EUT comply with the requirement of FCC Part15C §15.203, because
  - (1) The antenna was built in the EUT and permanently attached.
  - (2) There were no other antenna connectors.

#### SECTION 4. SUPPORT EQUIPMENT

The EUT was supported by the following equipment during the test.

Symbol	Item	Model No.	Serial No.	Manufacturer	FCC/IC ID
<b>B</b>	UHF DIGITAL TRANSCEIVER	NX-3820HG-K	00000012	JVC KENWOOD	K44478500
<b>C</b>	DC Power Supply	PS-60	11/01 00142	KENWOOD	N/A
<b>D</b>	DC Power Supply	PAD55-3L	28091953	KIKUSUI	N/A
<b>Supplied Power:</b>					
<b>B</b>	DC13.6 V				
<b>C, D</b>	AC120 V, 60 Hz				

## SECTION 5. USED CABLE(S)

The following cable(s) was used for the test.

No.	Name	Length (m)	Shield	Metal Connector	Ferrite Core
1	FLEXIBLE PRINTED CIRCUITS CABLE	0.20	No	No	-
2	DC CABLE	0.25	No	No	-
3	DC CABLE	2.80	No	No	-
4	Power cable for DC Power Supply (C)	2.20	No	No	-
5	Power cable for DC Power Supply (E)	2.00	No	No	-

## SECTION 6. TEST CONFIGURATION

### 6.1 Radiated Spurious Emissions (Below 30 MHz) and AC Conducted Emissions

\* : EUT

□ : Joint

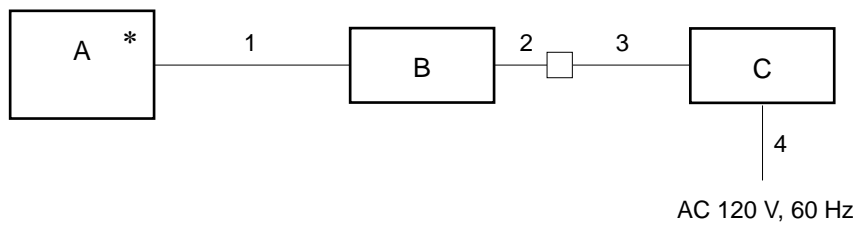

### 6.2 Radiated Spurious Emissions (30 -1000 MHz and above 1 GHz)

\* : EUT

□ : Joint

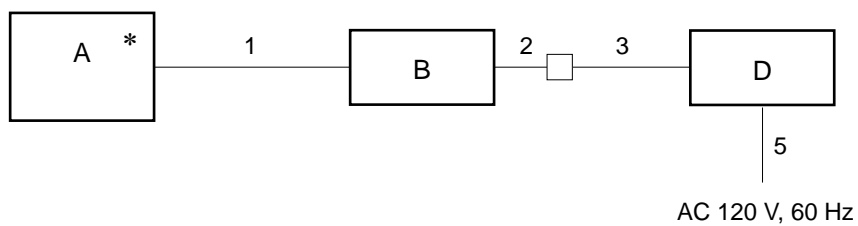

The symbols and numbers assigned to the equipment and cables on this diagram correspond to the ones in Sections 3 to 5.



## SECTION 7. OPERATING CONDITION

The test was carried out under the following mode.

Test program used to control the EUT for staying in continuous transmitting and receiving mode is programmed.

### 7.1 Test Channel

In accordance with Section 15.31 (m), all test items was conducted in the following three channels:

Test Channel	Frequency [MHz]
Low	2402
Middle	2440
High	2480

### 7.2 Test modes

Test Item	Operating modes
6dB Bandwidth and 99 % Occupied Bandwidth	2402MHz, 2440MHz, 2480MHz
Maximum Peak Output Power	2402MHz, 2440MHz, 2480MHz
Radiated Spurious Emissions and Restrict Band edge	2402MHz, 2440MHz, 2480MHz
Band Edge of Authorized Frequency Band	2402MHz, 2440MHz, 2480MHz
Spurious RF Conducted Emissions	2402MHz, 2440MHz, 2480MHz
Power Density	2402MHz, 2440MHz, 2480MHz
AC Conducted Emissions	2402MHz, 2440MHz, 2480MHz
Receiver Spurious Emissions	Transmit OFF, Receive mode

Note: The Test modes were configured in typical fashion as a customer would normally use it.

## SECTION 8. UNCERTAINTY

The following uncertainty represents the expanded uncertainty expressed at approximately the 95% confidence level using a coverage factor of  $k = 2$ .

Traceability to national standard in SI units is ensured with these values.

Compliance with the limits in this standard are determined without in consideration of the measurement uncertainty of the measurement instrumentation.

### 8.1 Emission tests

Test items	$U_{lab} [k = 2]$	$U_{cispr}$
<b>Radiated Spurious Emissions at 3m</b>		
30 MHz – 1000 MHz	+/- 3.96 dB	6.3 dB
Above 1 GHz	+/- 4.91 dB	5.2 dB
<b>AC Conducted Emissions</b>		
150 kHz – 30 MHz	+/- 2.80 dB	3.4 dB

The above expanded instrumentation uncertainty,  $U_{lab}$ , is estimated in accordance with CISPR 16-4-2:2011.

### 8.2 RF Conducted tests

Test Items	$U_{lab} [k = 2]$
Bandwidth	+/- 1.42 %
Maximum Output Power	+/- 1.96 dB
Conducted Emissions	+/- 1.82 dB

## SECTION 9. TEST DATA

### 9.1 6 dB Bandwidth and 99 % Occupied Bandwidth

<b>Regulations</b>	FCC Part15C §15.247 (a) (2) RSS-247 5.2 (a) RSS-Gen 6.7
<b>Test Method/Guide</b>	KDB 558074 D01 DTS Meas Guidance v04 Clause 8.0 ANSI C63.10-2013 clause 6.9.2

#### Test Procedure

- The EUT and test instrument were set up as shown on section 10.1.
- Adjust the test instrument for the following setting:
 

RBW	:	100 kHz
VBW	:	≥ 3 x RBW
Detector	:	Peak
Sweep Time	:	Auto
Trace mode	:	Max Hold
- Allow trace to fully stabilize.
- Use "Occupied Bandwidth Measurement" function to measure the 20 dB bandwidth.

#### Test Result

<b>Location</b>	Matsuda No.1 Test Site
<b>Test date</b>	May 25, 2018
<b>Temperature</b>	27.0 [degree C]
<b>Humidity variation</b>	39 [%]
<b>Test Engineer</b>	Naohei Murakami

Operating modes	Frequency [MHz]	6 dB Bandwidth [MHz]	99 % Bandwidth [MHz]
Bluetooth Low Energy	2402	0.507	1.055
	2440	0.505	1.055
	2480	0.505	1.053

#### Spectrum Plots

See ANNEX A.1.

## 9.2 Maximum Peak Output Power

<b>Regulations</b>	FCC Part15C §15.247 (b) RSS-247 5.4 (d)
<b>Test Method/Guide</b>	KDB 558074 D01 DTS Meas Guidance v04 Clause 9.1 ANSI C63.10-2013 clause 7.8.5

### Test Procedure

1. The EUT and test instrument were set up as shown on section 10.1.

2. Adjust the test instrument for the following setting:

RBW	:	≥ the 6 dB bandwidth (DTS bandwidth)
VBW	:	≥ 3 x RBW
Span	:	≥ 3 x RBW
Detector	:	Peak
Sweep Time	:	Auto
Trace mode	:	Max Hold

Note: The value of the "6 dB bandwidth", from the result of section 9.1.

3. Allow trace to fully stabilize.

4. Use the peak search function to measure the peak of the emission.

5. Measurement data correction;

$$\text{Measured Value [dBm]} = \text{Reading [dBm]} + \text{Factor [dB]}$$

$$*\text{Factor} = \text{Cable Loss [dB]} + \text{Attenuator [dB]}$$

$$\text{Margin [dB]} = \text{Limit [dBm]} - \text{Measured Value [dBm]}$$

### Test Result

<b>Location</b>	Matsuda No.1 Test Site
<b>Test date</b>	May 25, 2018
<b>Temperature</b>	27.0 [degree C]
<b>Humidity variation</b>	39 [%]
<b>Test Engineer</b>	Naohei Murakami

Operating modes	Freq. [MHz]	Reading [dBm]	Factor [dB]	Measured Value [dBm]	Limit		Margin [dB]
					[mW]	[dBm]	
Bluetooth Low Energy	2402	-11.86	12.26	0.40	1000	30	29.60
	2440	-12.02	12.26	0.24			29.76
	2480	-11.16	12.26	1.10			28.90

### Spectrum Plots

See ANNEX A.2

### 9.3 Radiated Spurious Emissions and Band Edge of Restrict Band

<b>Regulations</b>	FCC Part15C §15.209, §15.205 RSS-247 5.5 RSS-Gen 8.9
<b>Test Method/Guide</b>	KDB 558074 D01 DTS Meas Guidance v04 Clause 11.0 and 12.0 ANSI C63.10-2013 clause 6.4, 6.5 and 6.6

#### Test Procedure

1. The EUT and test instrument were set up as shown on section 10.2.
2. The measurement antenna was placed at a distance of 3 m from the EUT.
3. The turntable azimuth (EUT direction, 0 – 360 degree) and antenna height (1 – 4 m) are adjusted the position so that maximum field strength is obtained for each frequency spectrum to be measured.  
(Blow 30 MHz: 1.0 m Fixed)

The equipment and cables are arranged or manipulated within the range of the test standard in the above condition. At least six highest spectrums are measured by the test receiver (below 1 GHz) and spectrum analyzer (above 1 GHz).

For measurements above 1GHz, the emission signal shall be kept within the illumination area of the 3 dB beamwidth of the antenna so that the maximum emission from the EUT is measured.

And the antenna angle toward the source of the emission.

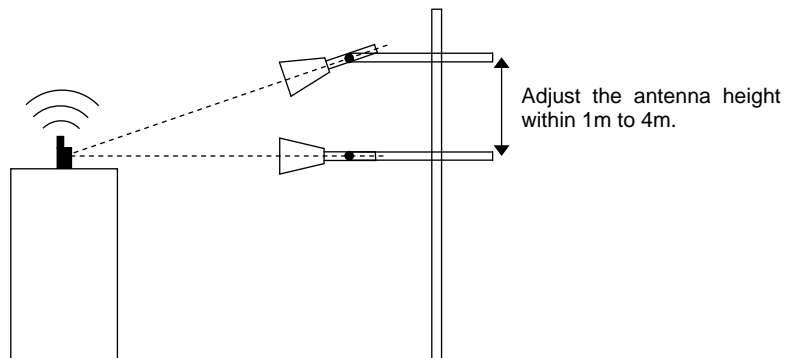

5. Adjust the test instrument for the following setting:

Frequency	Instruments	Detector	RBW	VBW	Remarks
Blow 30 MHz	CISPR Receiver	QP	200 Hz	N/A	0.009 - 0.15 MHz
			9 kHz	N/A	0.15 – 30 MHz
30 – 1000 MHz	CISPR Receiver	QP	120 kHz	N/A	-
Above 1000 MHz	Spectrum Analyzer	Peak	1 MHz	3 MHz	for Peak
				10 Hz	for Average

6. Measurement data correction;

$$\text{Emission Level [dBuV/m]} = \text{Reading [dBuV]} + \text{Factor [dB/m]}$$

$$\text{Margin [dB]} = \text{Limit [dBuV/m]} - \text{Emission Level [dBuV/m]}$$

$$\begin{aligned} * \text{Factor} &= \text{Antenna Factor} + \text{Amplifier gain} + \text{Cable loss} + \text{Attenuator (+ Filter)} \\ &+ \text{Distance Conversion Factor} * \end{aligned}$$

\* For other than Standard distance:

$$\text{Distance Conversion Factor} = 20 \log (\text{Measurement distance} / \text{Standard distance})$$

**Test Result**

<b>Operating mode</b>	Bluetooth Low Energy, 2402 MHz, EUT axis: X			
<b>Location</b>	Matsuda No.2 Test Site,		Matsuda No.1 Test Site,	
<b>Frequency</b>	Blow 30 MHz	30–1000 MHz,	1-18 GHz,	18–25 GHz
<b>Test date</b>	July 9, 2018	May 22, 2018	May 18, 2018	May 16, 2018
<b>Temperature</b>	26.5	26.0	25.0	26.5 [degree C]
<b>Humidity variation</b>	52	38	44	43 [%]
<b>Test Engineer</b>	Naohei Murakami			

No.	Freq. [MHz]	Detector	Reading [dBuV]		Factor [dB/m]	Emission Level [dBuV/m]		Limit [dBuV/m]	Margin [dB]	
			Hori	Vert		Hori	Vert		Hori	Vert
1	55.680	QuasiPeak	28.90	36.40	-5.8	23.1	30.6	40	16.9	9.4
2	240.000	QuasiPeak	39.40	31.90	-4.8	34.6	27.1	46	11.4	18.9
3	268.800	QuasiPeak	38.20	32.80	-3.3	34.9	29.5	46	11.1	16.5
4	1940.000	Peak	41.00	43.30	3.9	44.9	47.2	74	29.1	26.8
5	1940.000	Average	31.10	35.79	3.9	35.0	39.7	54	19.0	14.3
6	2390.000	Peak	39.67	40.49	4.7	44.4	45.2	74	29.6	28.8
7	2390.000	Average	27.16	27.19	4.7	31.9	31.9	54	22.1	22.1
8	2910.000	Peak	40.70	42.83	6.2	46.9	49.0	74	27.1	24.9
9	2910.000	Average	29.31	34.17	6.2	35.5	40.4	54	18.5	13.6
10	3557.000	Peak	43.30	48.40	8.5	51.8	56.9	74	22.2	17.1
11	3557.000	Average	35.00	42.40	8.5	43.5	50.9	54	10.5	3.1
12	4203.760	Peak	42.10	43.30	10.5	52.6	53.8	74	21.4	20.2
13	4203.760	Average	30.90	33.10	10.5	41.4	43.6	54	12.6	10.4
14	4804.000	Peak	40.28	40.62	11.1	51.4	51.7	74	22.6	22.3
15	4804.000	Average	27.59	27.37	11.1	38.7	38.5	54	15.3	15.5
16	7206.000	Peak	42.42	42.14	16.4	58.8	58.5	74	15.2	15.4
17	7206.000	Average	29.50	29.48	16.4	45.9	45.9	54	8.1	8.1
18	9608.000	Peak	43.16	43.59	19.3	62.5	62.9	74	11.5	11.1
19	9608.000	Average	30.00	30.00	19.3	49.3	49.3	54	4.7	4.7

No.	Freq. [MHz]	Detector	Reading [dBuV]		Factor [dB]		Result [dBuV/m]		Limit [dBuV/m]		Margin [dB]	
			Hor	Ver	Loss, Gain	Dist. Factor	Hor	Ver	Hor	Ver	Hor	Ver
1	2402.000	Peak	90.4	85.5	4.7	0.0	95.1	90.2	-	-	-	-
2*	2400.000	Peak	46.1	43.3	4.7	0.0	50.8	48.0	75.1	70.2	24.3	22.2

**Note.**

\* : Band Edge of Restrict Band

- : Measurement limit

The limit value is -20dBc from the detected the carrier power.

Below 30 MHz: Spurious emission was not detected.

Any Spurious emissions higher than the frequency reported in the table above were not detected during the measurement.

<b>Operating mode</b>	Bluetooth Low Energy, 2440 MHz, EUT axis: X			
<b>Location</b>	Matsuda No.2 Test Site,		Matsuda No.1 Test Site,	
<b>Frequency</b>	Blow 30 MHz	30–1000 MHz,	1-18 GHz,	18–25 GHz
<b>Test date</b>	July 9, 2018	May 22, 2018	May 18, 2018	May 16, 2018
<b>Temperature</b>	26.5	26.0	25.0	26.5 [degree C]
<b>Humidity variation</b>	52	38	44	43 [%]
<b>Test Engineer</b>	Naohei Murakami			

No.	Freq. [MHz]	Detector	Reading [dBuV]		Factor [dB/m]	Emission Level [dBuV/m]		Limit [dBuV/m]	Margin [dB]	
			Hori	Vert		Hori	Vert		Hori	Vert
1	55.680	QuasiPeak	28.60	36.30	-5.8	22.8	30.5	40	17.2	9.5
2	240.000	QuasiPeak	39.20	31.90	-4.8	34.4	27.1	46	11.6	18.9
3	268.800	QuasiPeak	38.20	34.10	-3.3	34.9	30.8	46	11.1	15.2
4	1940.000	Peak	41.60	43.40	3.9	45.5	47.3	74	28.5	26.7
5	1940.000	Average	31.10	35.80	3.9	35.0	39.7	54	19.0	14.3
6	2910.000	Peak	41.30	42.60	6.2	47.5	48.8	74	26.5	25.2
7	2910.000	Average	29.40	34.30	6.2	35.6	40.5	54	18.4	13.5
8	3557.000	Peak	43.40	48.30	8.5	51.9	56.8	74	22.1	17.2
9	3557.000	Average	34.90	42.42	8.5	43.4	50.9	54	10.6	3.1
10	4203.760	Peak	42.70	43.40	10.5	53.2	53.9	74	20.8	20.1
11	4203.760	Average	30.90	33.10	10.5	41.4	43.6	54	12.6	10.4
12	4880.000	Peak	39.64	39.70	11.3	50.9	51.0	74	23.0	23.0
13	4880.000	Average	26.23	26.13	11.3	37.5	37.4	54	16.4	16.5
14	7320.000	Peak	42.50	42.77	16.7	59.2	59.5	74	14.8	14.5
15	7320.000	Average	29.66	29.64	16.7	46.4	46.3	54	7.6	7.6
16	9760.000	Peak	42.79	43.42	19.7	62.5	63.1	74	11.5	10.9
17	9760.000	Average	30.30	30.30	19.7	50.0	50.0	54	4.0	4.0

Note.

Below 30 MHz: Spurious emission was not detected.  
 Any Spurious emissions higher than the frequency reported in the table above were not detected during the measurement.

<b>Operating mode</b>	Bluetooth Low Energy, 2480 MHz, EUT axis: X			
<b>Location</b>	Matsuda No.2 Test Site,		Matsuda No.1 Test Site,	
<b>Frequency</b>	Blow 30 MHz	30–1000 MHz,	1-18 GHz,	18–25 GHz
<b>Test date</b>	July 9, 2018	May 22, 2018	May 18, 2018	May 16, 2018
<b>Temperature</b>	26.5	26.0	25.0	26.5 [degree C]
<b>Humidity variation</b>	52	38	44	43 [%]
<b>Test Engineer</b>	Naohei Murakami			

No.	Freq. [MHz]	Detector	Reading [dBuV]		Factor [dB/m]	Emission Level [dBuV/m]		Limit [dBuV/m]	Margin [dB]	
			Hori	Vert		Hori	Vert		Hori	Vert
1	55.680	QuasiPeak	28.60	36.30	-5.8	22.8	30.5	40	17.2	9.5
2	240.000	QuasiPeak	39.20	31.90	-4.8	34.4	27.1	46	11.6	18.9
3	268.800	QuasiPeak	38.30	34.10	-3.3	35.0	30.8	46	11.0	15.2
4	1940.000	Peak	41.70	43.60	3.9	45.6	47.5	74	28.4	26.5
5	1940.000	Average	31.10	35.80	3.9	35.0	39.7	54	19.0	14.3
6	2483.500	Peak	50.49	54.55	4.9	55.4	59.5	74	18.6	14.5
7	2483.500	Average	27.61	27.53	4.9	32.5	32.4	54	21.5	21.5
8	2910.000	Peak	40.72	43.43	6.2	46.9	49.6	74	27.1	24.3
9	2910.000	Average	29.36	34.26	6.2	35.6	40.5	54	18.4	13.5
10	3557.000	Peak	43.39	48.20	8.5	51.9	56.7	74	22.1	17.3
11	3557.000	Average	34.90	42.49	8.5	43.4	51.0	54	10.6	3.0
12	4203.760	Peak	42.10	43.00	10.5	52.6	53.5	74	21.4	20.5
13	4203.760	Average	30.90	33.10	10.5	41.4	43.6	54	12.6	10.4
14	4960.000	Peak	39.66	39.45	11.4	51.1	50.9	74	22.9	23.1
15	4960.000	Average	26.56	26.54	11.4	38.0	37.9	54	16.0	16.0
16	7440.000	Peak	43.81	43.31	17.3	61.1	60.6	74	12.9	13.4
17	7440.000	Average	30.32	30.33	17.3	47.6	47.6	54	6.4	6.3
18	9920.000	Peak	43.63	43.18	20.2	63.8	63.4	74	10.1	10.6
19	9920.000	Average	30.34	30.33	20.2	50.5	50.5	54	3.4	3.4

Note.

Below 30 MHz: Spurious emission was not detected.

Any Spurious emissions higher than the frequency reported in the table above were not detected during the measurement.



#### 9.4 Band Edge of Authorized Frequency Band

<b>Regulations</b>	FCC Part15C §15.247 (d) RSS-247 5.5
<b>Test Method/Guide</b>	KDB 558074 D01 DTS Meas Guidance v04 Clause 11.0 ANSI C63.10-2013 clause 6.10.4

#### Test Procedure

1. The EUT and test instrument were set up as shown on section 10.1.
2. Adjust the measurement instrument for the following setting:
  - RBW : 100 kHz
  - VBW : 300 kHz
  - Span : 20 MHz
  - Detector : Peak
  - Sweep Time : Auto
  - Correction Factor : Input Cable loss and Attenuator
  - Trace mode : Max Hold
3. Allow trace to fully stabilize.
4. Use the peak marker function to determine the maximum power level in any 100 kHz band segment within in-band emission.
5. Use the marker function to ensure that the band edge level of the authorized frequency band was attenuated by at least the minimum requirements specified.
6. Band Edge Measurement data correction;
  - Limit [dBm] = Peak level within in-band emission [dBm] - 20 [dB]
  - Margin [dB] = Limit [dBm] – Band edge Level [dBm]

**Test Result**

<b>Location</b>	Matsuda No.1 Test Site
<b>Test date</b>	May 25, 2018
<b>Temperature</b>	27.0 [degree C]
<b>Humidity variation</b>	39 [%]
<b>Test Engineer</b>	Naohei Murakami

<b>Freq. [MHz]</b>	<b>Peak level within in-band emission [dBm]</b>	<b>Limit [dBm]</b>	<b>Band edge level [dBm]</b>	<b>Margin [dB]</b>
2390	0.481	-19.519	-70.015	50.496
2400	0.481	-19.519	-61.508	41.989
2483.5	1.173	-18.878	-65.721	46.843
2499.17	1.173	-18.878	-70.075	51.197

**Spectrum Plots**

See ANNEX A.6

### 9.5 Spurious RF Conducted Emissions

<b>Regulations</b>	FCC Part15C §15.247 (d) RSS-247 5.5
<b>Test Method/Guide</b>	ANSI C63.10-2013 clause 7.8.8

#### Test Procedure

- The EUT and test instrument were set up as shown on section 10.1.
- Adjust the measurement instrument for the following setting:
  - RBW : 100 kHz
  - VBW : 300 kHz
  - Span : Set span to encompass the spectrum to be examined
  - Detector : Peak
  - Sweep Time : Auto
  - Correction Factor : Input Cable loss and Attenuator
  - Trace mode : Max Hold, Allow trace to fully stabilize.
- Use the marker function to ensure that the amplitude of all unwanted emissions outside of the authorized frequency band is attenuated by at least the minimum requirements specified.

#### Spectrum Plots

See ANNEX A.7

<b>Location</b>	Matsuda No.1 Test Site
<b>Test date</b>	May 25, 2018
<b>Temperature</b>	27.0 [degree C]
<b>Humidity variation</b>	39 [%]
<b>Test Engineer</b>	Naohei Murakami

### 9.6 Power Density

<b>Regulations</b>	FCC Part15C §15.247 (e) RSS-247 5.2 (b)
<b>Test Method/Guide</b>	KDB 558074 D01 DTS Meas Guidance v04 Clause 10.2 ANSI C63.10-2013 clause 7.8.5

#### Test Procedure

1. The EUT and test instrument were set up as shown on section 10.1.
2. Adjust the test instrument for the following setting:

RBW	:	3 kHz
VBW	:	9 kHz
Span	:	1.5 times the 6 dB bandwidth (DTS bandwidth)
Detector	:	Peak
Sweep Time	:	Auto
Trace mode	:	Max Hold

Note: The value of the "6 dB bandwidth", from the result of section 9.1.

3. Allow trace to fully stabilize.
4. Use the peak search function to measure the peak of the emission.
5. Measurement data correction;

$$\text{Measured Value [dBm]} = \text{Reading [dBm]} + \text{Factor [dB]}$$

$$*\text{Factor} = \text{Cable Loss [dB]} + \text{Attenuator [dB]}$$

$$\text{Margin [dB]} = \text{Limit [dBm]} - \text{Measured Value [dBm]}$$

#### Test Result

<b>Location</b>	Matsuda No.1 Test Site
<b>Test date</b>	May 25, 2018
<b>Temperature</b>	27.0 [degree C]
<b>Humidity variation</b>	39 [%]
<b>Test Engineer</b>	Naohei Murakami

Operating modes	Freq. [MHz]	Reading [dBm]	Factor [dB]	Result [dBm]	Limit [dBm]	Margin [dB]
Bluetooth Low Energy	2402	-28.146	12.260	-15.886	8.000	23.886
	2440	-28.459	12.260	-16.199	8.000	24.199
	2480	-27.474	12.260	-15.214	8.000	23.214

### 9.7 AC Conducted Emissions

<b>Regulations</b>	FCC Part15C §15.207 RSS-Gen 8.8
<b>Test Method/Guide</b>	ANSI C63.10-2013 clause 6.2

#### Test Procedure

- The EUT and test instrument were set up as shown on section 10.3.
- The spectrum analyzer is controlled by the computer program to sweep the frequency range to be measured, then spectrum chart is plotted out to find the worst emission.  
At least six highest spectrum are measured in quasi-peak and average (if necessary) using the CISPR Receiver.
- Adjust the test instrument for the following setting:

Frequency	Instruments	Detector	RBW	VBW
0.15 – 30 MHz	CISPR Receiver	QP	9 kHz	N/A
		AVG		

- Measurement data correction;

$$\text{Emission Level [dBuV]} = \text{Reading [dBuV]} + \text{Factor [dB]}$$

$$\text{Margin [dB]} = \text{Limit [dBuV]} - \text{Emission Level [dBuV]}$$

$$* \text{Factor} = \text{LISN Factor} + \text{Cable loss} + \text{Attenuator}$$

**Test Result**

<b>Test date</b>	July 7, 2018
<b>Location</b>	Matsuda No.2 Test Site
<b>Temperature</b>	25.5 [degree C]
<b>Humidity variation</b>	58 [%]
<b>Test Engineer</b>	Naohei Murakami

Operating mode			Bluetooth Low Energy, 2402 MHz								
No.	Freq [MHz]	Detector	Reading [dBuV]		Factor [dB]		Emission Level [dBuV]		Limit [dBuV]	Margin [dB]	
			L1	L2	L1	L2	L1	L2		L1	L2
1	0.2296	QuasiPeak	21.50	24.50	10.20	10.20	31.70	34.70	62.50	30.80	27.80
2	0.3430	QuasiPeak	18.80	24.60	10.10	10.20	28.90	34.80	59.10	30.20	24.30
3	0.5730	QuasiPeak	7.40	11.00	10.20	10.20	17.60	21.20	56.00	38.40	34.80
4	14.2457	QuasiPeak	25.50	25.20	11.10	11.20	36.60	36.40	60.00	23.40	23.60
5	21.1176	QuasiPeak	21.40	21.50	11.30	11.60	32.70	33.10	60.00	27.30	26.90
6	24.9550	QuasiPeak	20.90	21.00	11.30	11.60	32.20	32.60	60.00	27.80	27.40
7	28.7982	QuasiPeak	16.60	16.50	11.20	11.60	27.80	28.10	60.00	32.20	31.90

Operating mode			Bluetooth Low Energy, 2440 MHz								
No.	Freq [MHz]	Detector	Reading [dBuV]		Factor [dB]		Emission Level [dBuV]		Limit [dBuV]	Margin [dB]	
			L1	L2	L1	L2	L1	L2		L1	L2
1	0.2296	QuasiPeak	21.30	24.40	10.20	10.20	31.50	34.60	62.50	31.00	27.90
2	0.3430	QuasiPeak	18.70	24.60	10.10	10.20	28.80	34.80	59.10	30.30	24.30
3	0.5730	QuasiPeak	7.30	11.00	10.20	10.20	17.50	21.20	56.00	38.50	34.80
4	14.2457	QuasiPeak	26.00	25.60	11.10	11.20	37.10	36.80	60.00	22.90	23.20
5	21.1176	QuasiPeak	21.70	21.90	11.30	11.60	33.00	33.50	60.00	27.00	26.50
6	24.9550	QuasiPeak	20.80	21.00	11.30	11.60	32.10	32.60	60.00	27.90	27.40
7	28.7982	QuasiPeak	16.40	16.50	11.20	11.60	27.60	28.10	60.00	32.40	31.90

Operating mode			Bluetooth Low Energy, 2480 MHz									
No.	Freq [MHz]	Detector	Reading [dBuV]		Factor [dB]		Emission Level [dBuV]		Limit [dBuV]	Margin [dB]		
			L1	L2	L1	L2	L1	L2		L1	L2	
1	0.2296	QuasiPeak	21.50	24.50	10.20	10.20	31.70	34.70	62.50	30.80	27.80	
2	0.3430	QuasiPeak	18.20	24.00	10.10	10.20	28.30	34.20	59.10	30.80	24.90	
3	0.5730	QuasiPeak	7.60	11.00	10.20	10.20	17.80	21.20	56.00	38.20	34.80	
4	14.2457	QuasiPeak	25.80	25.50	11.10	11.20	36.90	36.70	60.00	23.10	23.30	
5	21.1176	QuasiPeak	21.70	21.80	11.30	11.60	33.00	33.40	60.00	27.00	26.60	
6	24.9550	QuasiPeak	21.00	21.10	11.30	11.60	32.30	32.70	60.00	27.70	27.30	
7	28.7982	QuasiPeak	16.40	16.30	11.20	11.60	27.60	27.90	60.00	32.40	32.10	

### 9.8 Receiver Spurious Emissions

<b>Regulations</b>	RSS-Gen 7
<b>Test Method/Guide</b>	ANSI C63.10-2013 clause 6.4, 6.5 and 6.6

#### Test Procedure

See section 9.6

#### Test Result

<b>Operating mode</b>	Bluetooth Low Energy Receiving mode, EUT Axis: X				
<b>Location</b>	Matsuda No.2 Test Site,		Matsuda No.1 Test Site,		
<b>Frequency</b>	Blow 30 MHz	30 – 1000 MHz,	1-18 GHz,	18–26.5 GHz,	
<b>Test date</b>	July 9, 2018	May 23, 2018	May 28, 2018	May 16, 2018	
<b>Temperature</b>	26.5	26.0	24.0	26.5	[degree C]
<b>Humidity variation</b>	52	38	56	43	[%]
<b>Test Engineer</b>	Naohei Murakami				

No.	Freq. [MHz]	Detector	Reading [dBuV]		Factor [dB/m]	Emission Level [dBuV/m]		Limit [dBuV/m]	Margin [dB]	
			Hori	Vert		Hori	Vert		Hori	Vert
1	55.680	QuasiPeak	27.50	36.70	-5.8	21.7	30.9	40	18.3	9.1
2	240.000	QuasiPeak	38.90	32.60	-4.8	34.1	27.8	46	11.9	18.2
3	268.800	QuasiPeak	37.90	34.70	-3.3	34.6	31.4	46	11.4	14.6
4	1940.000	Peak	41.20	42.10	3.9	45.1	46.0	74	28.9	28.0
5	1940.000	Average	31.10	33.30	3.9	35.0	37.2	54	19.0	16.8
6	2440.000	Peak	45.70	45.10	4.7	50.4	49.8	74	23.6	24.2
7	2440.000	Average	28.00	27.90	4.7	32.7	32.6	54	21.3	21.4
8	2910.000	Peak	41.00	41.80	6.2	47.2	48.0	74	26.8	26.0
9	2910.000	Average	28.50	31.60	6.2	34.7	37.8	54	19.3	16.2
10	3557.000	Peak	42.80	46.30	8.5	51.3	54.8	74	22.7	19.2
11	3557.000	Average	33.30	41.20	8.5	41.8	49.7	54	12.2	4.3
12	4203.760	Peak	41.60	42.70	10.5	52.1	53.2	74	21.9	20.8
13	4203.760	Average	29.30	31.80	10.5	39.8	42.3	54	14.2	11.7
14	4880.000	Peak	39.60	41.80	11.3	50.9	53.1	74	23.1	20.9
15	4880.000	Average	25.80	28.50	11.3	37.1	39.8	54	16.9	14.2
16	7320.000	Peak	42.50	42.50	16.7	59.2	59.2	74	14.8	14.8
17	7320.000	Average	29.60	29.60	16.7	46.3	46.3	54	7.7	7.7
18	9760.000	Peak	42.60	43.10	19.7	62.3	62.8	74	11.7	11.2
19	9760.000	Average	30.10	30.10	19.7	49.8	49.8	54	4.2	4.2

#### Note.

Below 30 MHz: Spurious emission was not detected.

Any Spurious emissions higher than the frequency reported in the table above were not detected during the measurement.



## SECTION 10. LIST AND DIAGRAM OF MEASURING INSTRUMENTS

Test instruments are calibrated according to Quality Manual and Calibration Rules of Intertek Japan K.K.

### 10.1 RF Conducted

#### Measurement Instruments

Instrument	Model No.	Serial No.	Manufacturer	Cal. Interval	Effective period
Spectrum Analyzer	N9030A	MY52350520	Agilent	1 Y	Nov. 30, 2018
20 dB Attenuator	8493C	02678	Hewlett Packard	1 Y	Apr. 30, 2019
Coaxial Cable	5B-048-98-98-1000	ECE0084	CANDOX Systems	1 Y	Apr. 30, 2019

#### Measurement Equipment Configuration

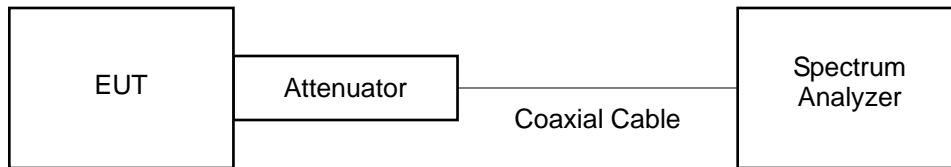

## 10.2 Radiated Emission

### Measurement Instruments

Instrument	Model No.	Serial No.	Manufacturer	Cal. Interval	Effective period
<b>Radiated disturbance :Below 30 MHz</b>					
Test Receiver	ESR26 (Firmware: 3.36 SP2)	101629	Rohde & Schwarz	1 Y	Feb. 2019
Loop Antenna	HFH2-Z2	882964/28	Rohde & Schwarz	1 Y	Dec. 2018
Coaxial Cable (M1)	5D-2W(8.0m)	EM0CS012	SUHNER	1 Y	Jan. 2019
6dB Attenuator	MP721B	M87938	ANRITSU	1 Y	Jan. 2019
<b>Radiated disturbance :30 MHz – 1000 MHz</b>					
Test Receiver	ESR26 (Firmware: 3.36 SP2)	101629	Rohde & Schwarz	1 Y	Feb. 2019
Broad Band Antenna	VULB9168	124	Schwarzbeck	1 Y	Aug. 2018
Amplifier	8447D	2727A05809	Hewlett Packard	1 Y	Jan. 2019
Step Attenuator	8494B	2805A14576	Hewlett Packard	1 Y	Jan. 2019
6dB Attenuator	MP721B	M87938	ANRITSU	1 Y	Jan. 2019
Coaxial Cable (R1)	RG214HF(8.0m)	MTS02R3-1	SUHNER	1 Y	Jan. 2019
Coaxial Cable (R2)	12D-SFA(28.0m)	MTS02R3-2	Intertek	1 Y	Jan. 2019
Coaxial Cable (R3)	RG214HF(2.0m)	MTS02R3-3	SUHNER	1 Y	Jan. 2019
Coaxial Cable (R4)	RG214HF(0.4m)	MTS02R3-4	SUHNER	1 Y	Jan. 2019
Coaxial Cable (R5)	RG214HF(0.4m)	MTS02R3-5	SUHNER	1 Y	Jan. 2019
Coaxial Cable (R6)	RG214HF(1.5m)	MTS02R3-6	SUHNER	1 Y	Jan. 2019
Coaxial Cable (R7)	RG214HF(1.5m)	MTS02R3-7	SUHNER	1 Y	Jan. 2019
Coaxial Cable (R8)	RG214HF(1.5m)	MTS02R3-8	SUHNER	1 Y	Jan. 2019
Coaxial Cable (R9)	5D-2W(8.0m)	MTS02R3-9	SUHNER	1 Y	Jan. 2019
Site Attenuation	-	-	-	1 Y	Apr. 2019
RF Switch(1)	MP59B	M28942	ANRITSU	1 Y	Jan. 2019
RF Switch(2)	ACX-150-1	E02301501	Intertek	1 Y	Jan. 2019

<b>Radiated disturbance :Above 1000 MHz</b>					
Spectrum Analyzer	ESR26 (Firmware: 3.36 SP2)	101629	Rohde & Schwarz	1 Y	Feb. 2019
Double Ridged Antenna	3115	2568	EMCO	1 Y	Jan. 2019
Amplifier	TPA0118-30	950186	TOYO Corporation	1 Y	Apr. 2019
3dB Attenuator	6803.17.B	E00AT3GA	SUNNER	1 Y	Apr. 2019
Notch Filter	BRM50702	111	Micro-Ttronics	1 Y	Apr. 2019
Coaxial Cable (R11)	SUCOFLEX 104(6.0m)	65566/4PE	SUNNER	1 Y	Apr. 2019
Coaxial Cable (R12)	SUCOFLEX 104(1.0m)	64587/4PE	SUNNER	1 Y	Apr. 2019
Horn Antenna with Preampfier	MLA-18265-B03-30	1694440	TSJ	1 Y	Mar. 2019
Coaxial cable	5B-048-98-98-6000	120315	Candox	1 Y	May 2019
SVSWR(1 – 18GHz)	-	-	-	1 Y	Sep. 2018
<b>Common</b>					
RF Switch(1)	MP59B	M28942	ANRITSU	1 Y	Jan. 2019
RF Switch(2)	ACX-150-1	E02301501	Intertek	1 Y	Jan. 2019

### Measurement Instruments Configurations

Diagram of the measuring instruments ( Below 30MHz )



Diagram of the measurement instruments ( 30-1000 MHz )

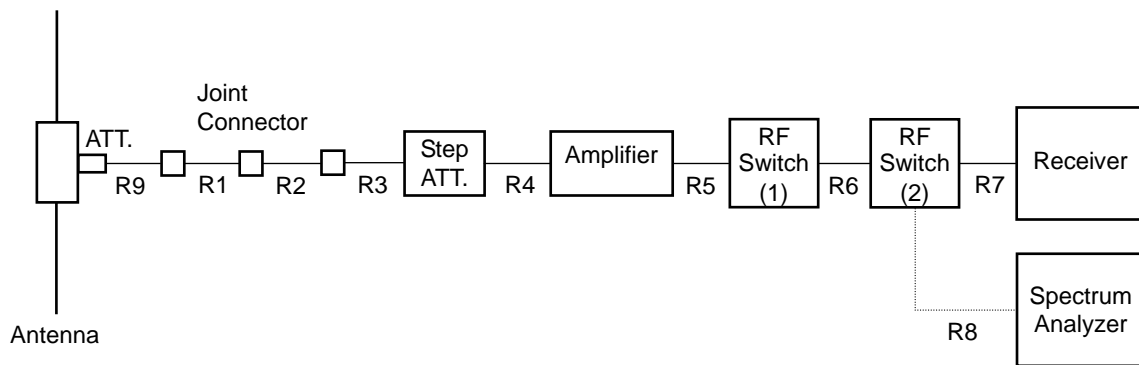

Diagram of the measurement instruments ( 1000 - 1800 MHz)

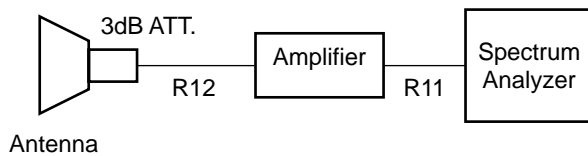

Diagram of the measurement instruments ( 1000- 18000 MHz)

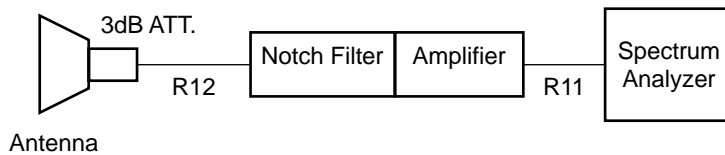
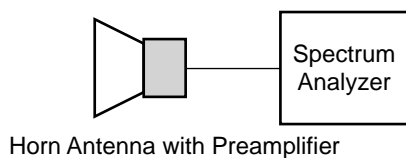
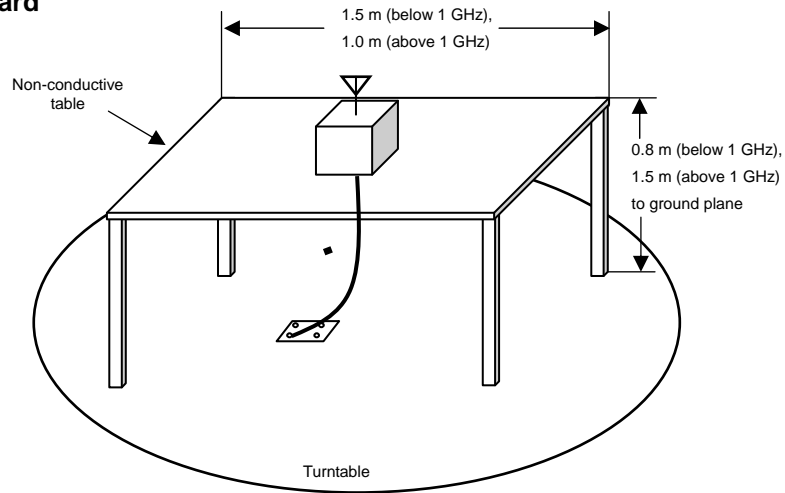

Diagram of the measurement instruments ( 18000 - 25000 MHz)



**EUT set-up as per standard**



**Absorber placement and Receive Antenna location in Radiated disturbance above 1 GHz**

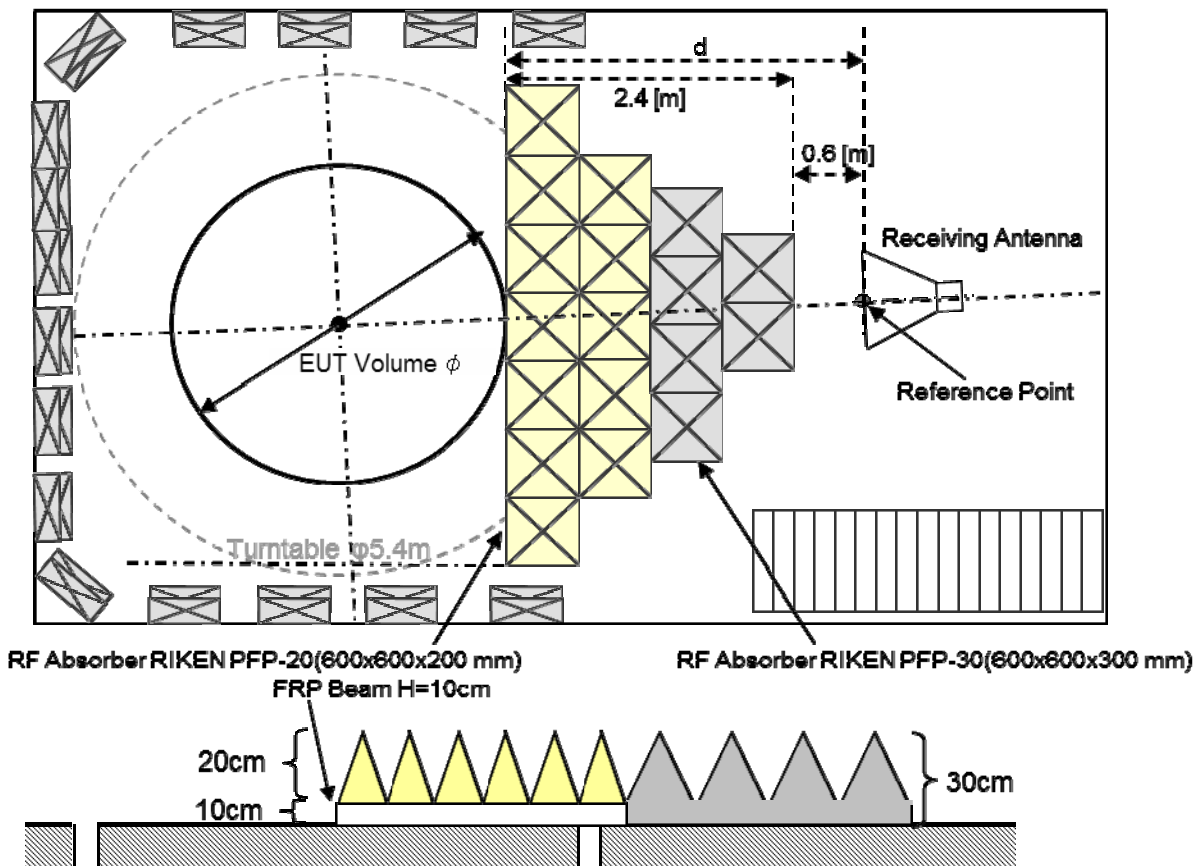

### 10.3 AC Line Conducted Emission

#### Measurement Instrument

Instrument	Model No.	Serial No.	Manufacturer	Cal. Interval	Effective period
Test Receiver	ESR26 (Firmware: 3.36 SP2)	101629	Rohde & Schwarz	1 Y	Feb. 2019
LISN(EUT)	ESH2-Z5	882395/021	Rohde & Schwarz	1 Y	Jun. 2018
10dB LISN Pad	6801.01.A	E00AT10C	HUBER+SUHNER	1 Y	Jun. 2018
Coaxial Cable (C1)	3D-2W(7.8m)	MTS02CSR-1	Intertek	1 Y	Jan. 2019
Coaxial Cable (C2)	RG-5A/U(12.0m)	MTS02CSR-2	Intertek	1 Y	Jan. 2019
Coaxial Cable (C3)	RG214HF(1.5m)	MTS02CSR-3	SUHNER	1 Y	Jan. 2019
Coaxial Cable (C4)	RG214HF(1.5m)	MTS02CSR-4	SUHNER	1 Y	Jan. 2019
Coaxial Cable (C5)	RG214HF(1.5m)	MTS02CSR-5	SUHNER	1 Y	Jan. 2019
RF Switch(1)	MP59B	M28942	ANRITSU	1 Y	Jan. 2019
RF Switch(2)	ACX-150-1	E02301501	Intertek	1 Y	Jan. 2019
Testing Software	emiT (3,0,0,0)	-	-	N/A	N/A

#### Measurement Instruments Configurations

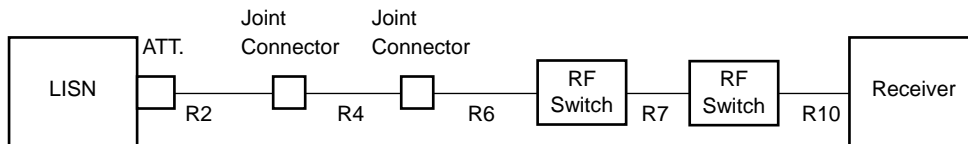

#### Test setup as per standard

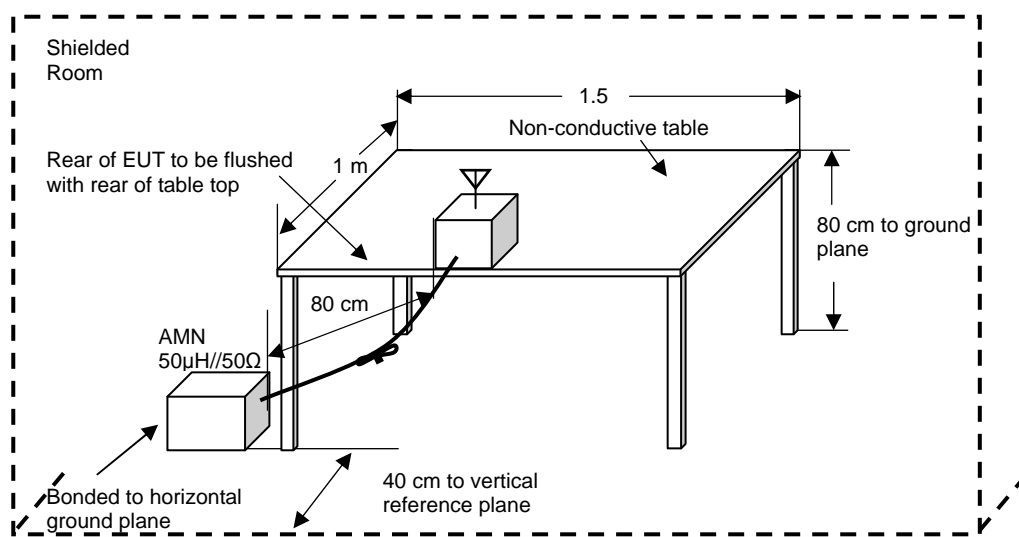

\* Reference Ground plane : greater than 2 x 2m

# **ANNEX**

## **A. HARD COPY OF SPECTRUM PLOTS**



## **A.1 6 dB Bandwidth and 99 % Occupied Bandwidth**

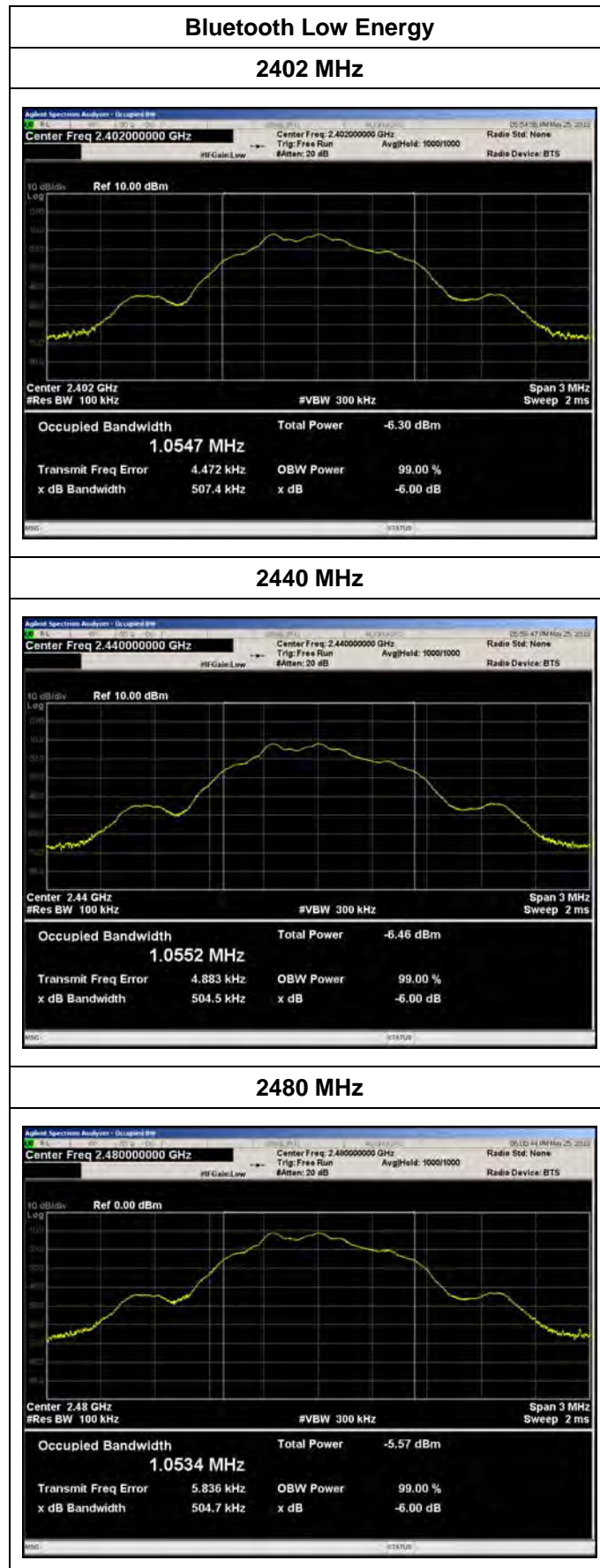

## **A.2 Maximum Peak Output Power**

### Bluetooth Low Energy

#### 2402 MHz

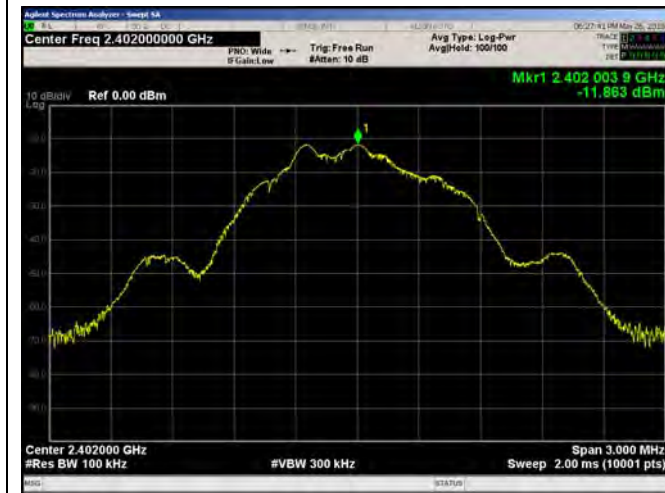

#### 2440 MHz

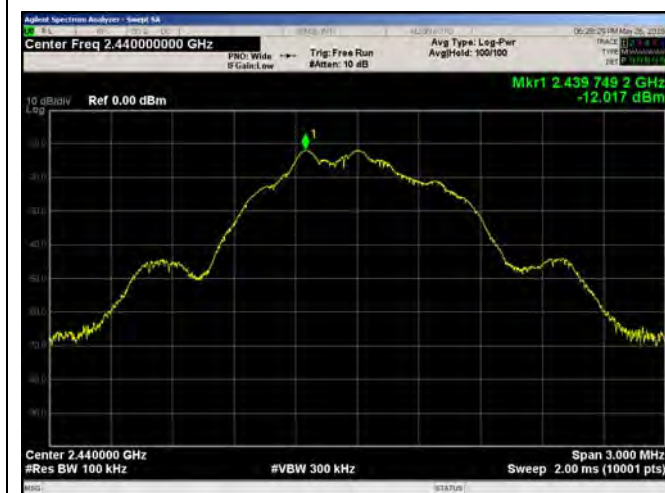

#### 2480 MHz

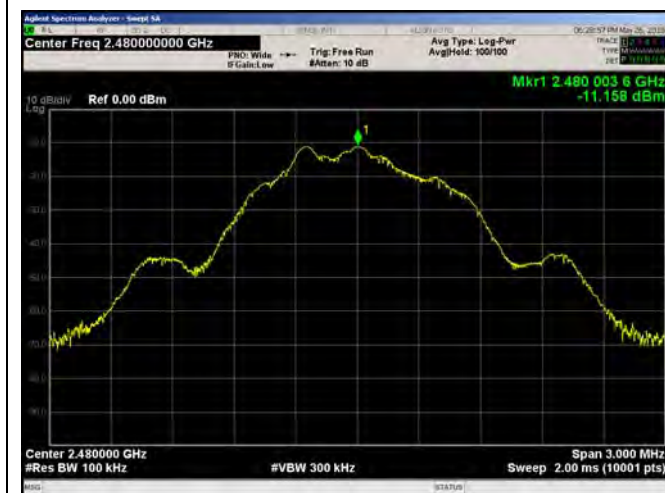

## **A.3 Band Edge of Authorized Frequency Band**

Bluetooth Low Energy

2400 MHz

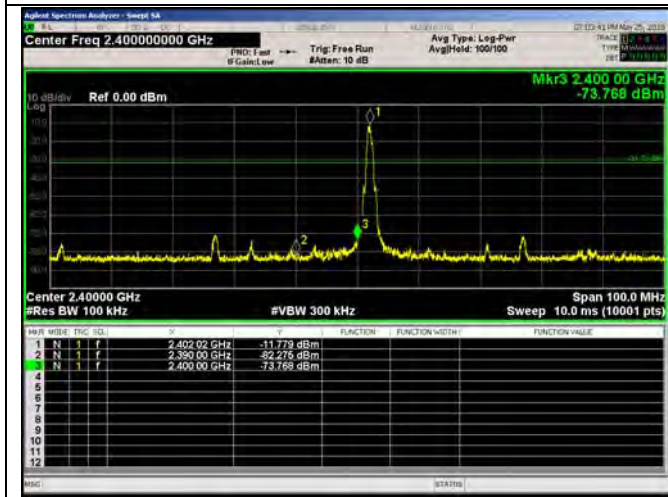

2483.5 MHz

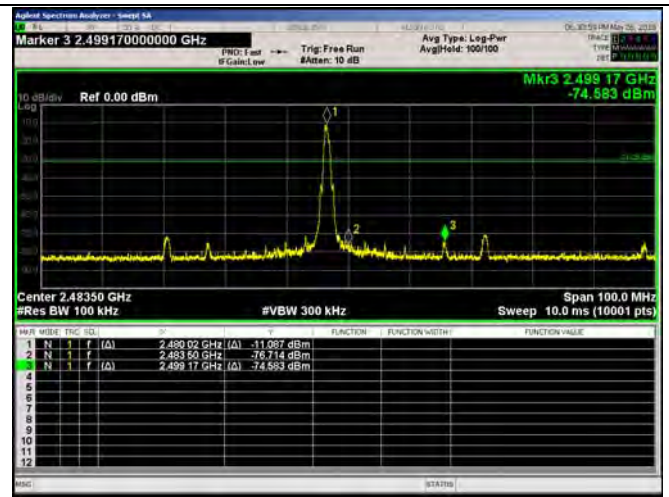

## **A.4 Spurious RF Conducted Emissions**

Bluetooth Low Energy, 2402MHz

0.009 – 0.15 MHz

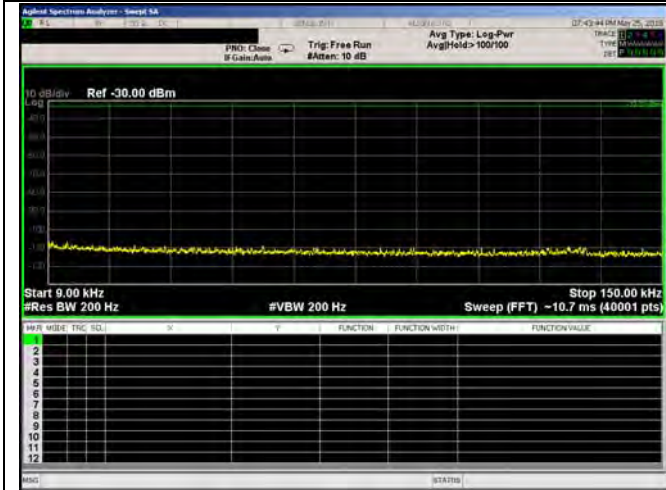

0.15 – 30 MHz

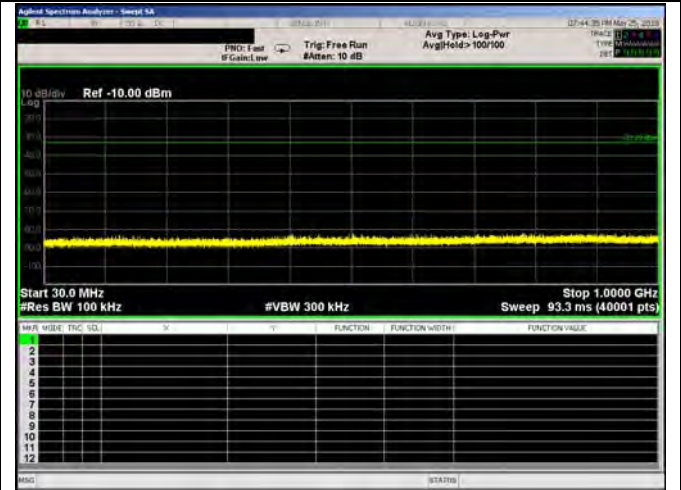

30 – 1000 MHz

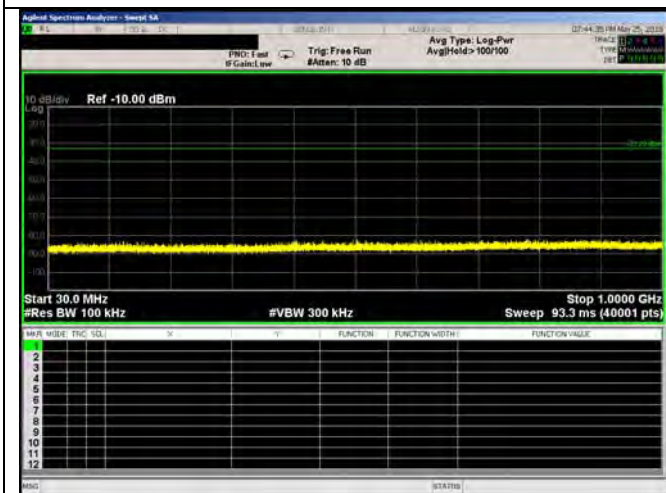

1 - 5 GHz

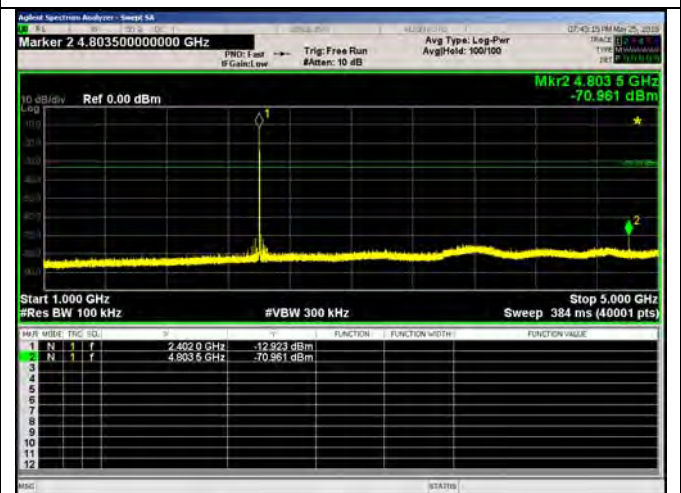

5 – 9 GHz

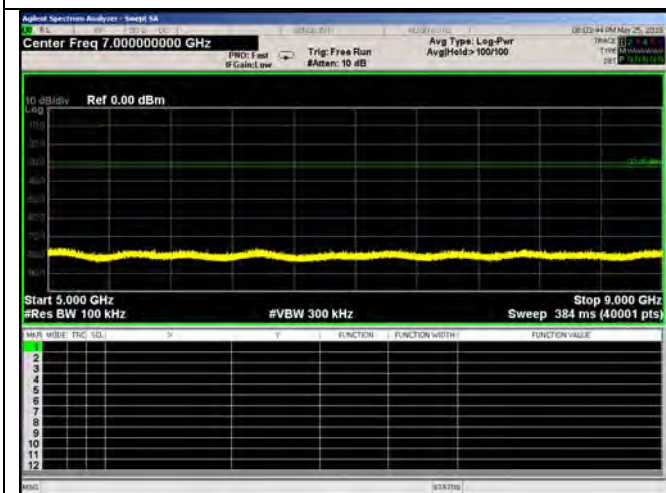

9 – 13 GHz

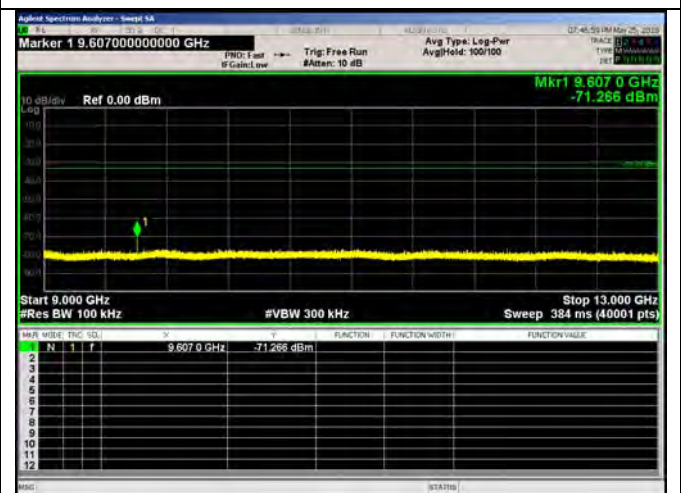



13 – 17 GHz

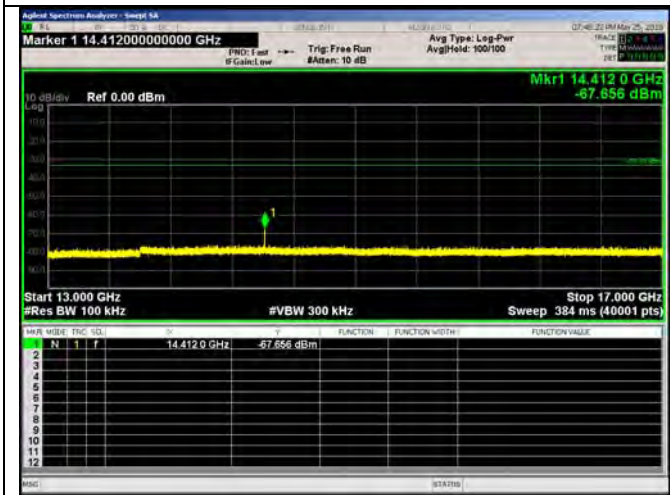

17 – 21 GHz

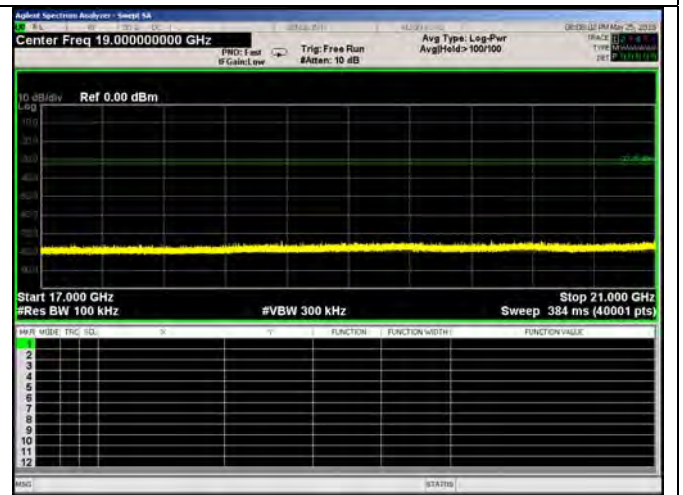

21 – 25 GHz

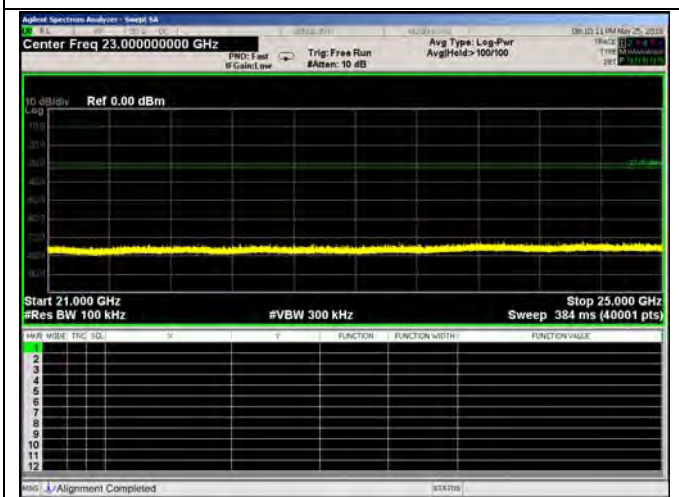

Bluetooth Low Energy, 2440MHz

0.009 – 0.15 MHz

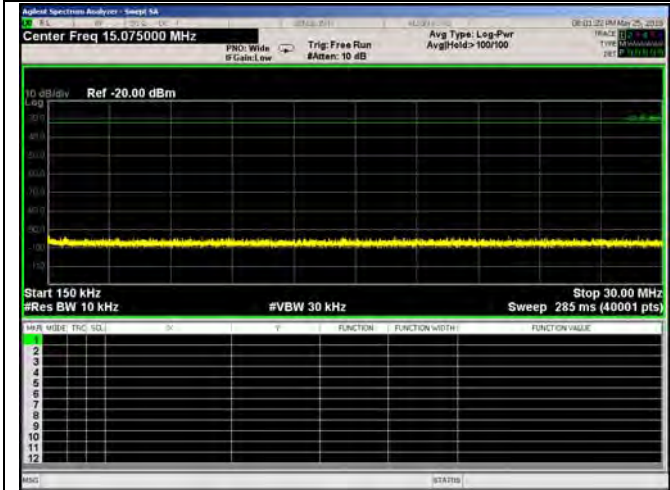

0.15 – 30 MHz

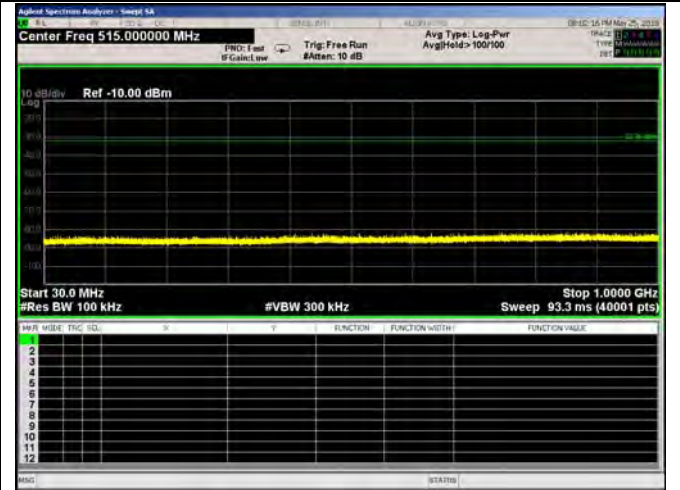

30 – 1000 MHz

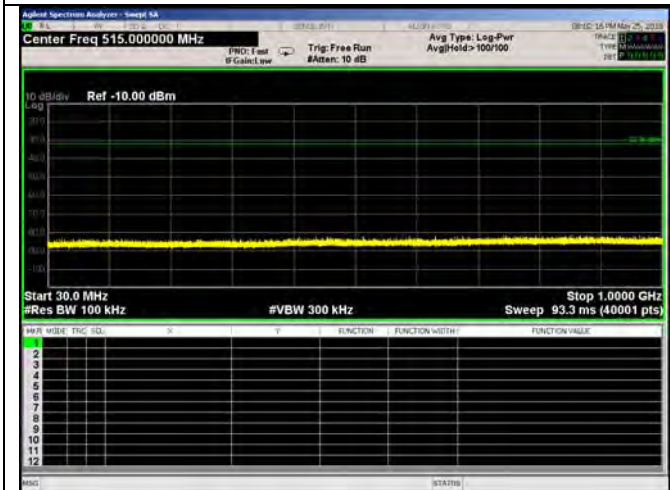

1 - 5 GHz

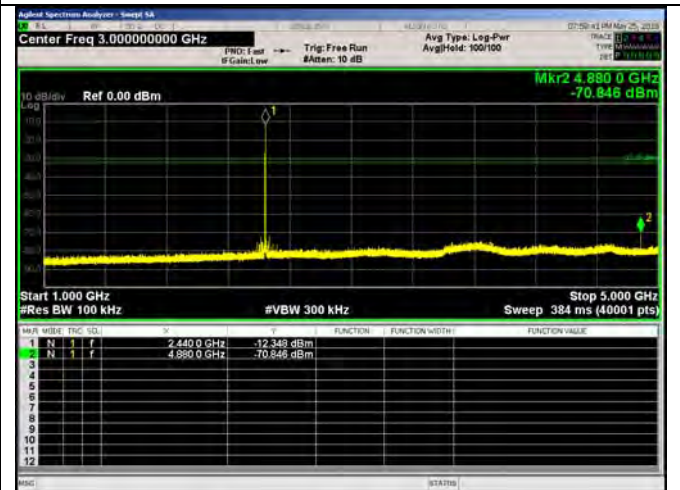

5 – 9 GHz

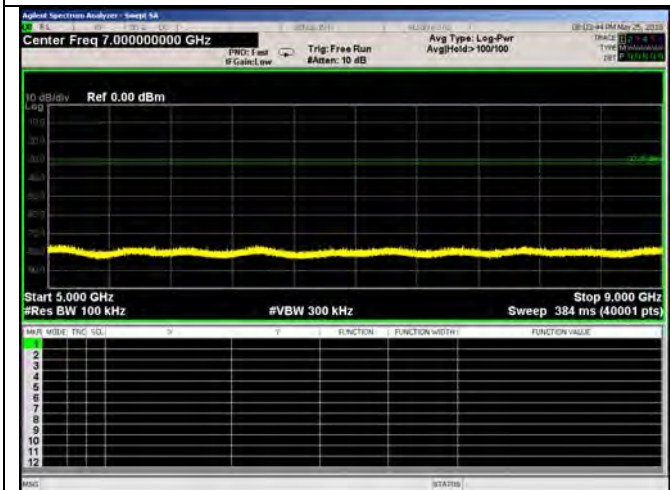

9 – 13 GHz

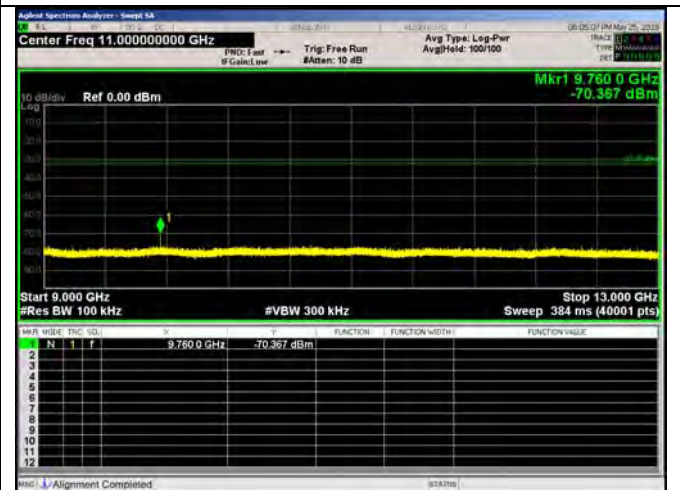

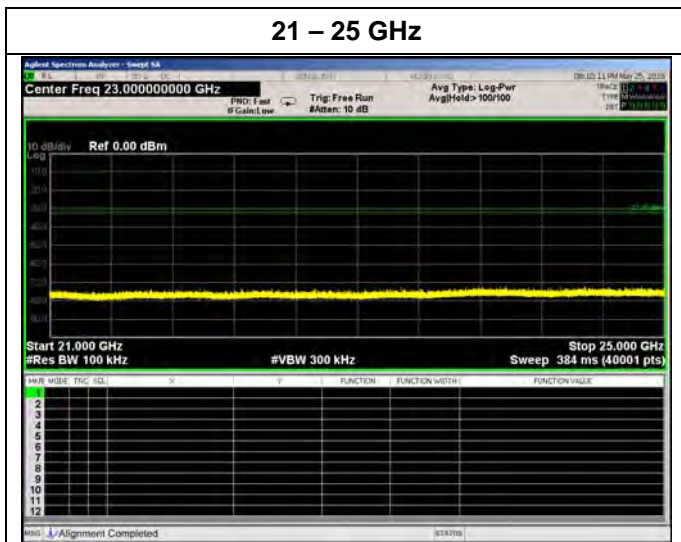
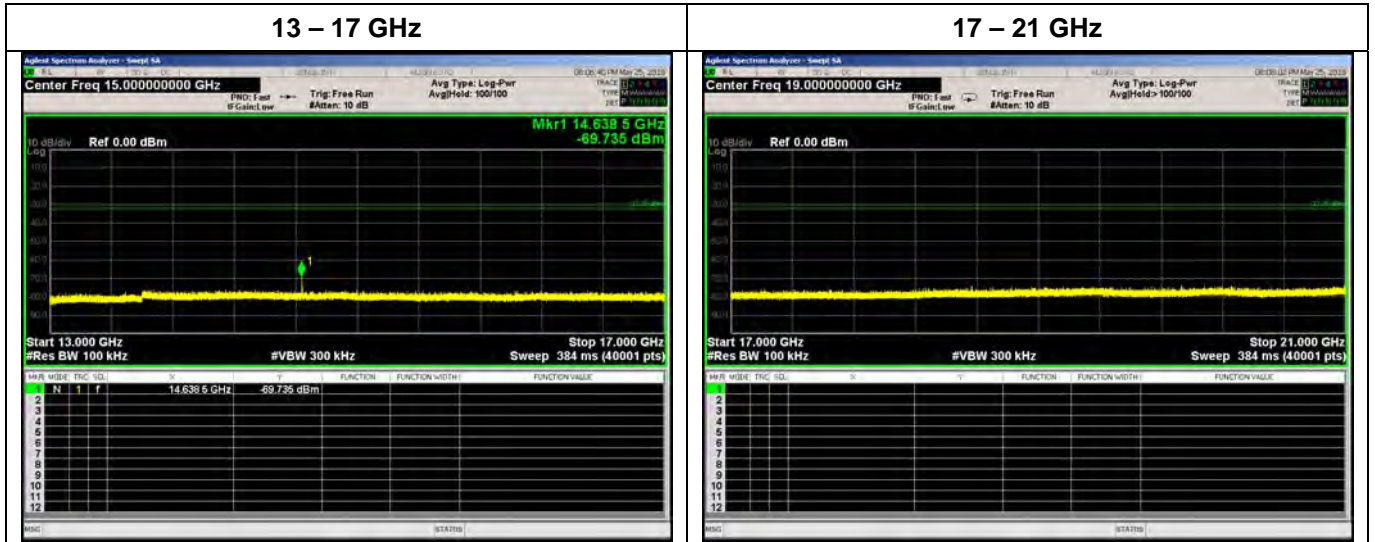



Bluetooth Low Energy, 2480MHz

0.009 – 0.15 MHz

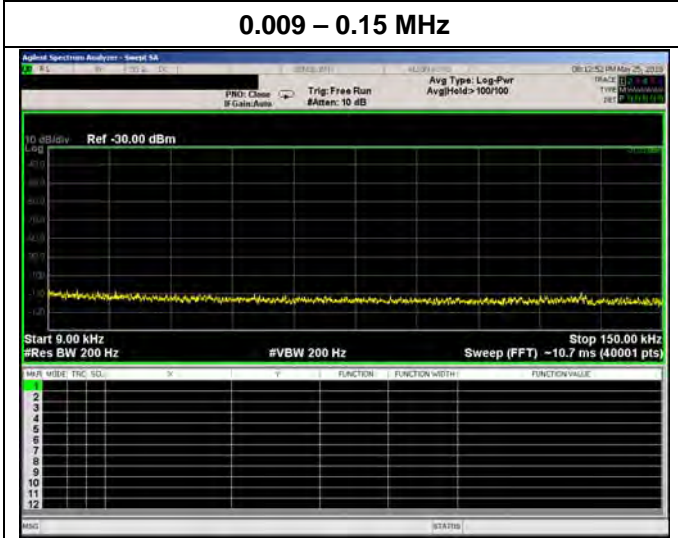

0.15 – 30 MHz

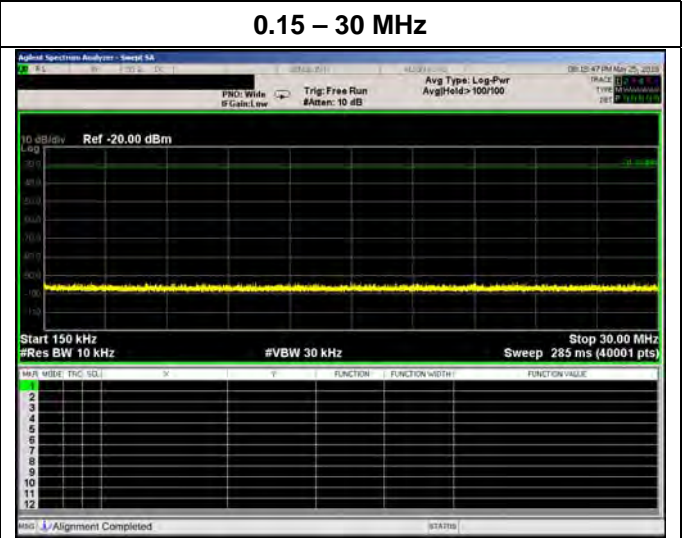

30 – 1000 MHz

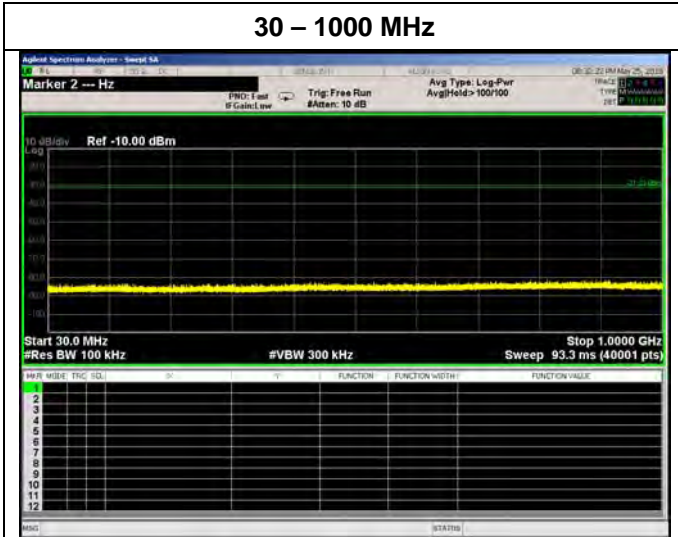

1 - 5 GHz

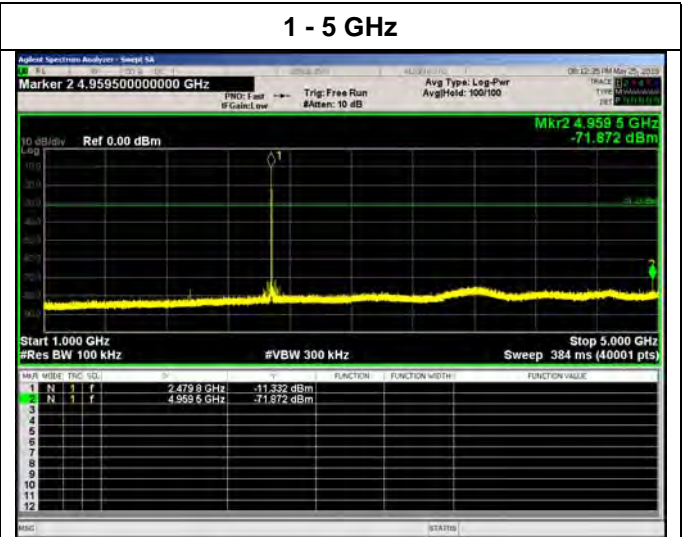

5 – 9 GHz

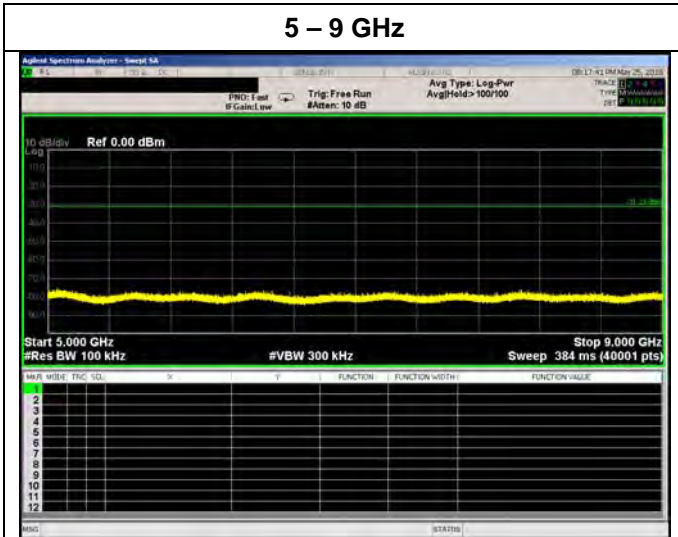

9 – 13 GHz

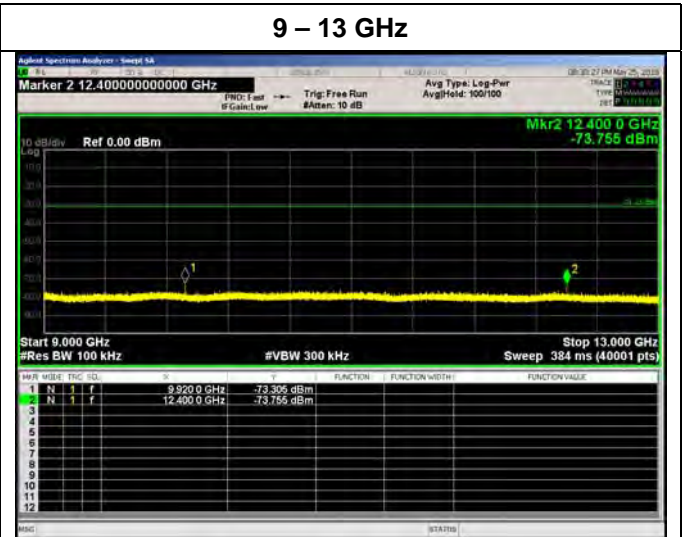

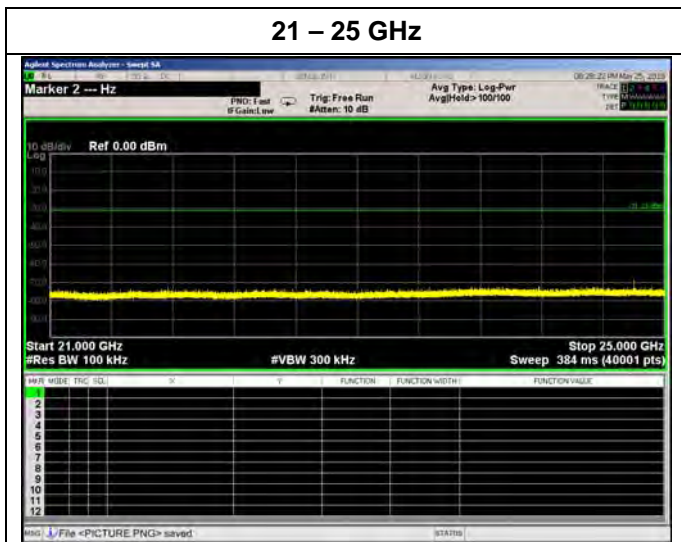
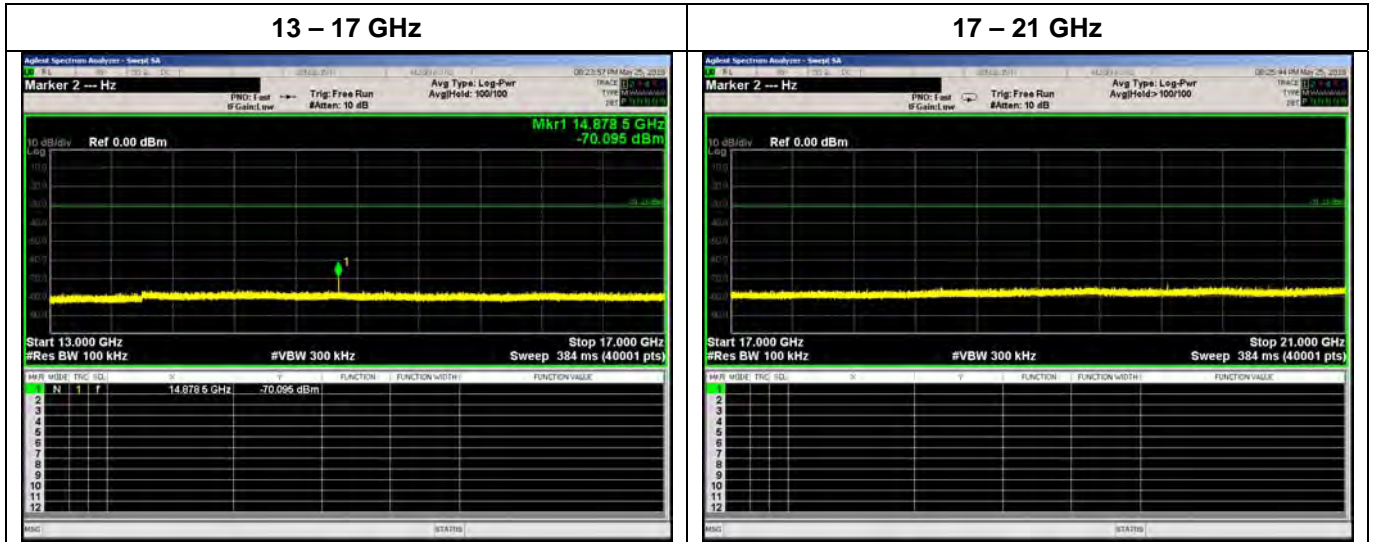

## **A.4 Power Density**

### Bluetooth Low Energy

#### 2402 MHz



#### 2440 MHz

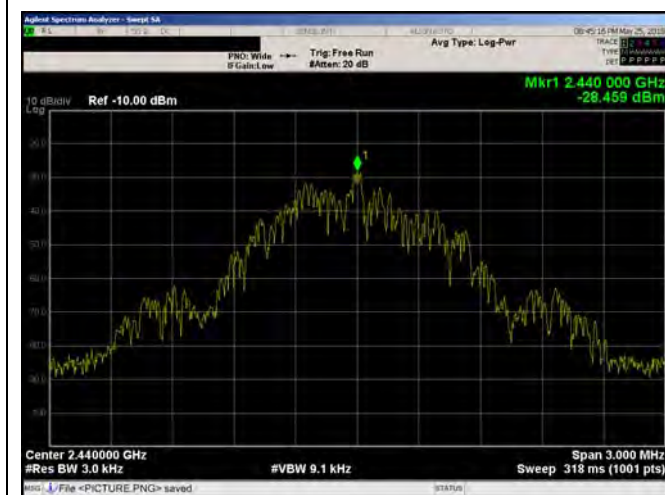

#### 2480 MHz

