



TEST REPORT

REGULATION : FCC Part 2, 90
 RSS-119 Issue 12

Applicant	Testing Laboratory
JVC KENWOOD Corporation 1-16-2, Hakusan, Midori-ku, Yokohama-shi Kanagawa, 226-8525 Japan Tel.: +81 45 939 6254 Fax.: +81 45 939 6261	Intertek Japan K.K. Kashima Laboratory URL: http://www.japan.intertek-etlsemko.com (Anechoic chamber) 298-6 Sada, Kashima, Ibaraki 314-0027 Japan Tel. +81 299 82 8464 (Open area test site) 3-2 Sunayama, Kamisu, Ibaraki 314-0255 Japan Tel. +81 479 40 1097

Equipment type	700/800MHz DIGITAL TRANSCEIVER
Trademark	KENWOOD
FCC Model(s)	NX-5900-K, NX-5900-F
IC Model(s)	NX-5900-K
Serial No.	90-No.1
FCC ID	K44478500
IC CN and UPN	282F-478500
Test Result	Complied
Report Number	15060364JKA-003
Original Issue Date	July 31, 2015

This report is for the exclusive use of Intertek's Client and is provided pursuant to the agreement between Intertek and its Client. Intertek's responsibility and liability are limited to the terms and conditions of the agreement. Intertek assumes no liability to any party, other than to the Client in accordance with the agreement, for any loss, expense or damage occasioned by the use of this report. Only the Client is authorized to permit copying or distribution of this report and then only in its entirety. Any use of the Intertek name or one of its marks for the sale or advertisement of the tested material, product or service must first be approved in writing by Intertek. The observations and test results in this report are relevant only to the sample tested. This report by itself does not imply that the material, product, or service is or has ever been under an Intertek certification program.

Approved by

Hideaki Kosemura

[Technical Dept. Manager]

Tested by

Koichi Wagatsuma

[Engineer]

Katsuya Uchida

[Engineer]

In Accordance with FCC Rules and Regulations, Volume II, Part 2 and 90

Sub-part 2.1033

Applicant and Manufacture Information	
APPLICANT	
Company	: JVC KENWOOD Corporation
Address	: 1-16-2, Hakusan, Midori-ku, Yokohama-shi Kanagawa, 226-8525 Japan
Contact Person	: Tamaki Shimamura Manager, Communications Systems Business Operation
MANUFACTURER	
Company	: JVC KENWOOD Corporation
Address	: 1-16-2, Hakusan, Midori-ku, Yokohama-shi Kanagawa, 226-8525 Japan
(c)(2) FCC ID	
FCC ID	: K44478500
Model number	: NX-5900-K, NX-5900-F
Serial number	: 90-No.1
Instruction Manual(S)	
Instruction manual(s)	: Please refer to attached Exhibits F
Type of Emission	
Emission Designation	: 16K0F3E(Wide), 14K0F3E(Wide) 11K0F3E(Narrow) 8K10F1E(Narrow) / 8K10F1D(Narrow) / 8K10F1W(Narrow) 8K30F1E(Narrow) / 8K30F1D(Narrow) / 8K30F7W(Narrow) 4K00F1E(Very Narrow) / 4K00F1D(Very Narrow) / 4K00F7W(Very Narrow) 4K00F2D(Very Narrow)
Frequency range	
Frequency Range	: FCC: 769 to 775 MHz, 799 to 805 MHz, 806 to 824 MHz and 851 to 869 MHz IC: 768 to 776 MHz, 798 to 806 MHz, 806 to 824 MHz and 851 to 869 MHz
Power Rating	
Output Power	: 2 to 30 W (768 to 806MHz), 2 to 35 W (806 to 869MHz)
Type	: Continuously Variable
Maximum Power Rating	
Output Power	: 30 W (768 to 806MHz), 35 W (806 to 869MHz)
Voltages & currents in all elements in final RF stage, including final transistor or solid-state device	
Collector Current, A	: 13.0 A Maximum
Collector Voltage, Vdc	: 13.6 Vdc
Supply Voltage, Vdc	: 13.6 Vdc
Other Information	
Number of Channel	: Zone 128max. Cannels 512 max.(per Zone)
Maximum Deviation	: ± 5 kHz (16K0F3E), ± 4 kHz (14K0F3E), ± 2.5 kHz (11K0F3E)
Frequency Stability	: 1 ppm (768 to 776 MHz, 798 to 806 MHz) / 0.4 ppm with AFC (798 to 806 MHz)
	: 1 ppm (806 to 824 MHz, 851 to 869 MHz)
Antenna Impedance	: 50 Ω Norminal
Note	

TABLE OF CONTENTS

	Page
SECTION 1. GENERAL INFORMATION	4
SECTION 2. SUMMARY OF TEST RESULT	5
SECTION 3. TEST AND MEASUREMENT DATA	6
SECTION 4. INFORMATION ABOUT EUT AND SUPPORT EQUIPMENT(S)	7
SECTION 5. SUPPORT EQUIPMENT	8
SECTION 6. USED CABLE(S)	9
SECTION 7. TEST CONFIGURATION	10
SECTION 8. OPERATING CONDITION	11
SECTION 9. MEASUREMENT UNCERTAINTY	12
SECTION 10. TEST DATA	
10.1 Carrier Output Power (Conducted)	13
10.2 Unwanted Emissions (Transmitter Conducted)	16
10.3 Field Strength of Spurious Radiation	19
10.4 Emission Masks (Occupied Bandwidth)	25
10.5 Audio Frequency Response / Audio Low Pass Filter (Voice Input)	59
10.6 Modulation Limiting	68
10.7 Frequency Stability (Temperature Variation)	82
10.8 Frequency Stability (Voltage Variation)	88
10.9 Frequency Stability (Temperature Variation) AFC	90
10.10 Frequency Stability (Voltage Variation) AFC	93
10.11 Emission Limitations	95
10.12 Receiver Spurious Emissions(Radiated)	125
10.13 Necessary Bandwidth and Emission Bandwidth	129
10.14 99% Occupied Bandwidth	130
APPENDIX PHOTOGRAPHS	

SECTION 1. GENERAL INFORMATION

TEST PERFORMED

Location	Kashima No.1 Test Site and No.12 Test Site		
EUT Received	June 26, 2015		
Date of Test	June 30, 2015	to	July 24, 2015
Standard Applied	FCC Part 2, 90 RSS-119 Issue 12		
Measurement Method	ANSI/TIA-603-D-2010 / RSS-119 Issue 12(2015), RSS-Gen Issue 4(2014)		
Deviation from Standard(s)	Not applicable		

QUALIFICATIONS OF TESTING LABORATORY (Kashima Lab.)

ACCREDITATION	SCOPE	LAB. CODE	Remarks
VLAC	EMC Testing	VLAC-008-1	JAPAN
BSMI	EMC Testing	SL2-IN-E-6008	TAIWAN
FILING			
VCCI	EMC Testing	A-0126	JAPAN
FCC	EMC Testing	JP0008	
IC	EMC Testing	IC-2042K-3, IC-2042Q-12	CANADA
CB-Scheme	EMC Testing	TL222	IECEE

ABBREVIATIONS

EUT	Equipment Under Test	DoC	Declaration of Conformity
AMN	Artificial Mains Network	ISN	Impedance Stabilization Network
LISN	Line Impedance Stabilization Network	Q-P	Quasi-peak
AMP	Amplifier	AVG	Average
ATT	Attenuator	PK	Peak
ANT	Antenna	Cal	Calibration
BBA	Broadband Antenna	N/A	Not applicable or Not available
DIP	Dipole Antenna	LCD	Liquid-Crystal Display
AE	Associated Equipment	4LEVEL FSK	4LEVEL Frequency Shift Key
GMSK	Gaussian Maximum Shift Key	CW ID	Continuously Repeating bit stream
FM	Frequency Modulation	C4FM	Constant envelope 4 Level FM
PTT	Push to Talk	AFC	Automatic frequency control

Revision Summary

Revised Date	Section	Description of Changes

SECTION 2. SUMMARY OF TEST RESULT

FCC Part2	Part90	IC RSS-119	TEST ITEM	RESULTS	Comments
2.1046 (a)	-	5.4	Carrier Output Power (Conducted)	PASS	
2.1051	90.210 90.691	5.8	Unwanted Emissions (Transmitter Conducted)	PASS	
2.1053 (a)	90.210 90.691	5.8	Field Strength of Spurious Radiation	PASS	
2.1049 (c) (1)	90.210 90.691	5.5	Emission Masks (Occupied Bandwidth)	PASS	
-	90.214	5.9	Transient Frequency Behavior	PASS	
2.1047 (a)	-	-	Audio Low Pass Filter (Voice Input)	PASS	
2.1047 (a)	-	-	Audio Frequency Response	PASS	
2.1047 (b)	-	-	Modulation Limiting	PASS	
2.1055 (a) (1)	90.213 (a)	5.3	Frequency Stability (Temperature Variation)	PASS	
2.1055 (d) (1)	90.213 (a)	5.3	Frequency Stability (Voltage Variation)	PASS	
-	-	RSS-Gen 7.1	Receiver Spurious Emissions	PASS	
-	90.203 (i)	-	Certification required (FCC Part 90.203(i))	Complied	
-	90.203 (e)	-	Certification required (FCC Part 90.203(e))	Complied	
-	-	5.5	99% Occupied Bandwidth	PASS	
2.1049	90.543	5.5	Emission limitations	PASS	

Limitation on Results

The test result of this report is effective equipment under test itself and under the test configuration described on the report. This test report does not assure that whether the test result taken in other testing laboratory is compatible or reproducible to the test result on this report or not.

Note:

As for the FCC Part 15 Subpart B-Unintentional Radiators, the EUT has been measured and declared as Verification by JVC Kenwood Corporation.

SECTION 3. TEST AND MEASUREMENT DATA

All test and measurements indicated in this document were performed in accordance with the Code of Federal Regulations Title 47 Part 2, Sub-part J and Industry Canada as the following individual parts:

FCC Rule	Test Item	Tested
Part 21	Domestic Public Fixed radio Services	N.A.
Part 22	Non Cellular	N.A.
Part 22	Public Mobile Services	N.A.
Part 22	Subpart H - Cellular Radiotelephone Service	N.A.
Part 22	Alternative technologies and auxiliary service	N.A.
Part 23	International Fixed Public Radiocommunication service	N.A.
Part 24	Personal Communications Services	N.A.
Part 74	Experimental Radio Auxiliary , Special Broadcast and Other Program Distributional Services	N.A.
Part 80	Stations in the Maritime Services	N.A.
Part 80	Subpart E - general Technical Standards	N.A.
Part 80	Subpart F - Equipment Authorization for Compulsory Ships	N.A.
Part 80	Subpart K - Private Coast Stations and Marine Utility Stations	N.A.
Part 80	Subpart S - Compulsory radiotelephone Installations for Small Passenger Boats	N.A.
Part 80	Subpart T - Radiotelephone Installation Required for Vessels on the Great Lakes	N.A.
Part 80	Subpart U - Radiotelephone Installations Required by the Bridge-to- Bridge Act	N.A.
Part 80	Subpart V - Emergency Position Indicating Radiobeacons (EPIRB'S)	N.A.
Part 80	Subpart W - Global Maritime Distress and Safety System (GMDSS)	N.A.
Part 80	Subpart X - Voluntary Radio Installations	N.A.
Part 87	Aviation Services	N.A.
Part 90	Private Land Mobile radio Services	YES
Part 94	Private Operational - Fixed Microwave Service	N.A.
Part 95	Subpart A - General Mobile radio Service	N.A.
Part 95	Subpart C - Radio Control (R/C) radio Service	N.A.
Part 95	Subpart D - Citizens Band (CB) Radio Service	N.A.
Part 95	Subpart E -Family radio Service	N.A.
Part 95	Subpart F -Interactive Video and Data Service (IVDS)	N.A.
Part 97	Amateur Radio Service	N.A.
Part 101	Fixed Microwave Service	N.A.

IC Rule	Test Item	Tested
RSS-119	Radio Ttansmitters and Receivers Operating in the Land Mobile and Fixed Services in the Frequency Range 27.4-960 MHz	YES
RSS-134	900MHz Narrowband Personal Communication Service	N.A.
RSS-Gen	General Requirements for Compliance of Radio Apparatus	YES

SECTION 4. INFORMATION ABOUT EUT AND SUPPORT EQUIPMENT(S)

4.1 List of System Configuration

Symbol	Item	Model No.	Serial No.	Manufacture	Remarks
A	700/800MHz DIGITAL TRANSCEIVER	NX-5900-K NX-5900-F	90-No.1	JVC KENWOOD Corporation	EUT
Power Ratings of EUT :		DC 13.6 V \pm 15%		13.0 A Maximum	
Power Supply :		DC 13.6 V			
Condition of Equipment		Proto type			
Type		Mobile type			
Suppression Devices		No Modifications by the laboratory were made to the device			

4.2 Port(s)/Connector(s)

Port Name	Connector Type	Connector Pin	Remarks
ACC	D-sub	25 pin	
External Speaker	3.5 ϕ	2 pin	
RF Antenna	M	2 pin	
Microphone	RJ-45	8 pin	
GPS Antenna	SMA	2 pin	
Ignition sense	Original	2 pin	

4.3 Highest Frequency Oscillator(s)/Crystal(s)

Operating Frequency	Board Name	Remarks
869 MHz	TXRX UNIT	
4960 MHz	Bluetooth UNIT	

SECTION 5. SUPPORT EQUIPMENT

The EUT was supported by the following equipment during the test.

Symbol	Item	Model No.	Serial No.	Manufacture	FCC ID
B	PANEL SEPARATE KIT	KRK-15B	001	JVC KENWOOD Corporation	N/A
C	PANEL SEPARATE KIT	KRK-14H	001	JVC KENWOOD Corporation	N/A
D	Keypad Microphone	KMC-36	None	JVC KENWOOD Corporation	N/A
E	Dummy Load	CT-150NP	1138693	TME	N/A
F	GPS Antenna	KRA-40	None	JVC KENWOOD Corporation	N/A
G	SECURE CRYPTOGRAPHIC MODULE	KWD-AE30	None	JVC KENWOOD Corporation	N/A
H	REMOTE CONTROL HEAD	KCH-19	001	JVC KENWOOD Corporation	N/A
I	External Speaker	KES-3	None	JVC KENWOOD Corporation	N/A
J	DC Power Supply (1)	PMC35-3A	LE000716	KIKUSUI	N/A
K	DC Power Supply (2)	GZV4000	90290932	Daiichi Denpa Kogyo	N/A

Supplied Power:

J, K	AC	100V,60Hz
------	----	-----------

SECTION 6. USED CABLE(S)

The following cable(s) was used for the test.

No.	Name	Length (m)	Shield	Connector	Ferrite core
1	Speaker cable	2.90	No	Plastic	
2	Antenna cable	1.00	Yes	Metal	
3	Microphone cable	0.55	No	Plastic	
4	Ignition sense cable	0.12	No	Metal	
5	GPS Antenna cable	5.00	Yes	Metal	
6	DC cable	0.25	No	-	
7	KCT-71 (REMOTE CONTROL CABLE)	7.60	Yes	Plastic	
8	ACC cable	1.70	Yes	Metal	
9	KCT-46 (Ignition sense cable)	3.10	No	Metal	
10	DC cable	3.40	No	-	
11	Power cable for DC Power Supply (1)	2.00	No	-	
12	Power cable for DC Power Supply (2)	1.80	No	-	

SECTION 7. TEST CONFIGURATION

Details of Configuration and Connection

Example: Case of Section 10.10Test

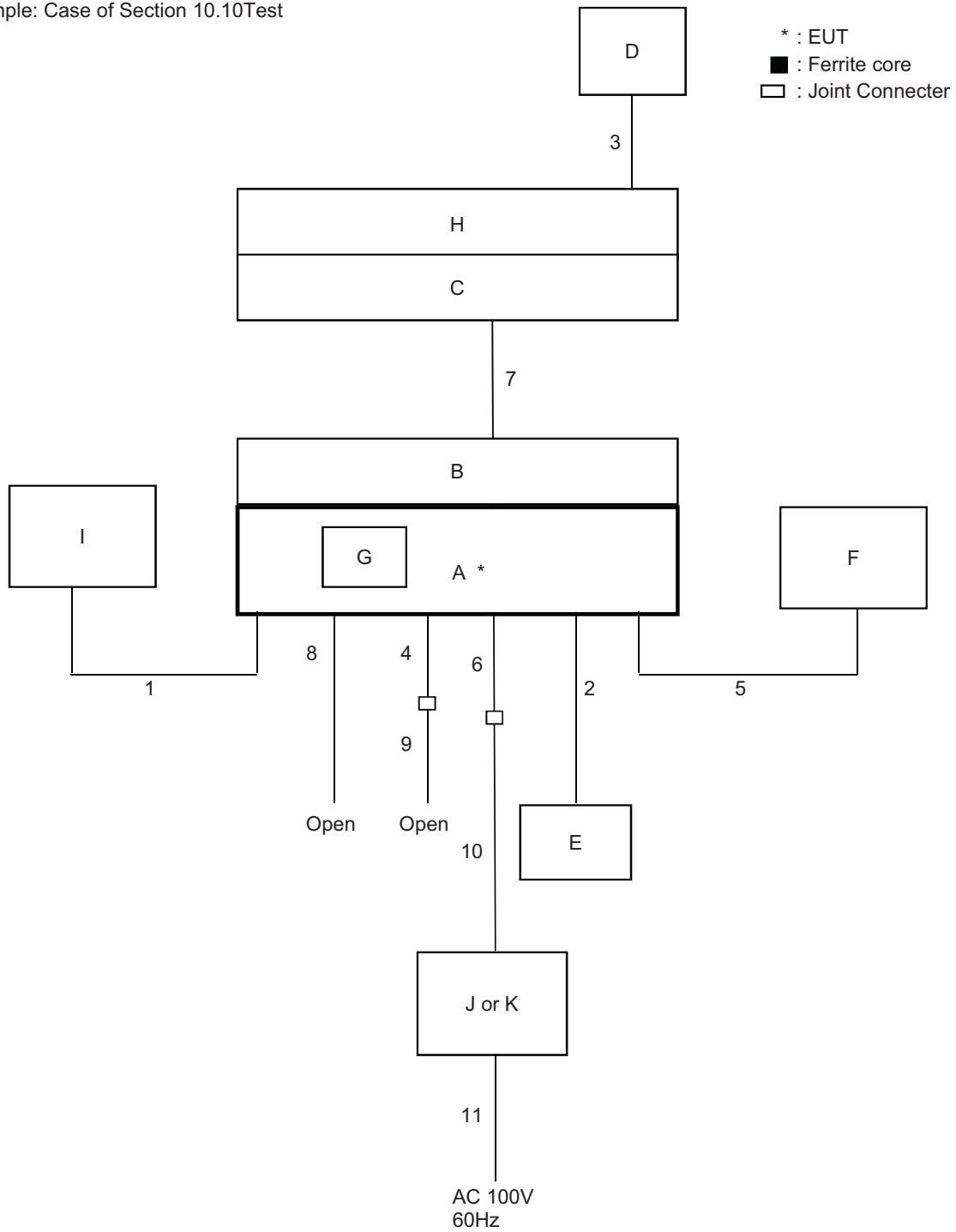

SECTION 8. OPERATING CONDITION

The EUT was operated under the following condition during the test.

8.1 Operating Condition

The test was carried out under Transmit mode.

(FCC/RSS 769.05MHz, 774.95MHz, 799.05MHz, 804.95MHz,
806.05MHz, 815.05MHz, 823.95MHz, 851.05MHz, 860.05MHz, 868.95MHz)

(High Power : 30W, Low Power : 2 W
: 769.05MHz, 774.95MHz, 799.05MHz, 804.95MHz)

(High Power : 35W, Low Power : 2 W
: 806.05MHz, 815.05MHz, 823.95MHz, 851.05MHz, 860.05MHz, 868.95MHz)

The test was carried out under Receive mode.

(769.05MHz, 774.95MHz, 851.05MHz, 860.05MHz, 868.95MHz)

EUT was examined in the operating conditions that had maximum emissions.

8.2 Operating Flow [Transmit mode]

Following operations were performed continuously.

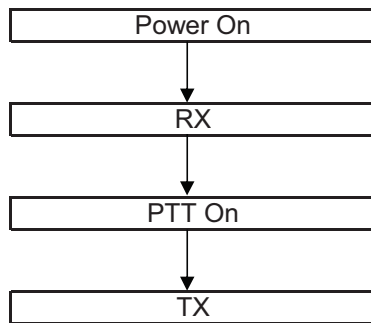

8.3 Operating Flow [Receive mode]

Following operations were performed continuously.

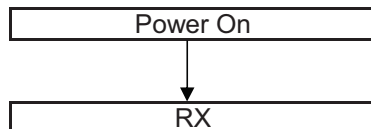

SECTION 9. MEASUREMENT UNCERTAINTY

Carrier Output Power (Conducted)	U _{lab}	Utia-603-d
	+/- 0.29dB (k = 2)	+/- 0.59 dB
Unwanted Emissions (Transmitter Conducted)		
	+/- 2.19 dB (k = 2)	+/- 1.1 dB
Field Strength of Spurious Radiation		
	+/- 2.78dB (k = 2)	+/- 3.3 dB
Emission Masks (Occupied Bandwidth)		
	+/- 0.5dB (k = 2)	+/- 2.1 dB
Transient Frequency Behavior		
	+/- 1.10% (k = 2)	+/- 21.6 %
Audio Low Pass Filter (Voice Input)		
	+/- 0.1dB (k = 2)	+/- 1.2 dB
Audio Frequency Response		
	+/- 0.1dB (k = 2)	+/- 1.2 dB
Modulation Limiting		
	+/- 1% (k = 2)	+/- 1 %
Frequency Stability (Temperature Variation)		
	+/- 10.1Hz (k=2)	+/-34.2 Hz
Frequency Stability (Voltage Variation)		
	+/- 10.1Hz (k=2)	+/-34.2 Hz
Emission Limitations § 90.543 (b) : ACP Measurements		
	+/- 0.59dB (k = 2)	+/- 1.2 dB
Emission Limitations § 90.543 (c) : Out-of-band emission limit :Conducted		
	+/- 2.19 dB (k = 2)	+/- 1.1 dB
Emission Limitations § 90.543 (c) : Out-of-band emission limit : Radiated		
	+/- 2.78dB (k = 2)	+/- 3.3 dB
Emission Limitations § 90.543 (f) : EIRP in GNSS Band:1559-1610MHz (Conducted)		
	+/- 2.19 dB (k = 2)	+/- 1.1 dB
Receiver Spurious Emissions	U _{lab}	Ucisp
30-1000MHz	+/- 4.83dB (k = 2)	+/- 6.3 dB
abobe 1GHz	+/- 4.90dB (k = 2)	

SECTION 10. TEST DATA

10.1 Carrier Output Power (Conducted)

REGULATIONS	: FCC Part 2 Section 1046 (a) / RSS-119 Section 5.4
TEST METHOD/GUIDE	: ANSI/TIA-603-D Section 2.2.1.2 / RSS-119 Section 4.1

Test Procedure

- 1 The EUT and test equipment were set up as shown on the following page.
- 2 The EUT was conducted to a resistive coaxial attenuator of normal load impedance.
 $RF\ Power\ (dBm) = Power\ Meter\ reading\ (dBm) + Attenuator\ Loss\ (dB) + Cable\ Loss\ (dB)$
 $RF\ Power\ (W) = 10^{(RF\ Power\ (dBm)/10)}/1000$
- 3 Modulate the transmitter with a 2.5 kHz sine wave at an input Level of 16 dB greater than that necessary to produce 50 % of rated system deviation.(Only as for the test of RSS)

Measuring Equipments

No.	Equipment	Manufacture	Model No.	Serial No.	Cal Date	Cal Exp.
1	Power Meter	Hewlett Packard	E4418B	GB38410265	Jun. 09, 15	Jun. 30, 16
2	Power Sensor	Hewlett Packard	8482A	US37292237	Jun. 09, 15	Jun. 30, 16
3	Attenuator (20dB)	Aeroflex/Wenshel	66-20-34	BY4357	Jun. 01, 15	Jun. 30, 16
4	Attenuator (30dB)	Weinschel	WA-29-30-34	8923	Jun. 01, 15	Jun. 30, 16
5	Modulation Analyzer	Hewlett Packard	8901B	2806A01669	Oct. 13, 14	Oct. 31, 15
6	Audio Generator	Anritsu	MG443B	M70150	Jun. 18, 15	Jun. 30, 16
7	DC Power Supply	Daiichi denpa kogyo	GZV4000	90290931	None	None

Measuring Cables

No.	Cable	Manufacturer	Model No.	Serial No.	Cal Date	Cal Exp.
W2	Balance Cable	Nicoon	3D-2V	KSR00092	Jan. 23, 15	Jan. 31, 16
W3	Coaxial Cable	Pacific custom	RG-58 C/U	AM90C04	Jun. 09, 15	Jun. 30, 16
W1	Coaxial Cable	Suhner	SUCOFLEX104	F0000017	Jan. 23, 15	Jan. 31, 16

Measuring Equipment Configuration

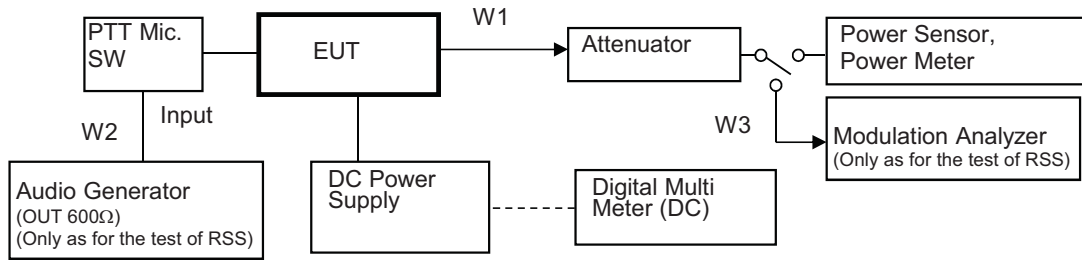

Test Results

Test date	Jun 30, 2015	
Location	Kashima No.1 Test Site	
temperature	23.0	[degree C]
Humidity Variation	50.0	[%]
Atmospheric Pressure	100.6	[kPa]
Test Engineer	Koichi Wagatsuma	

Test was carried out for all the Authorized Bandwidth.
 State the worst case (below).

No.	Frequency (MHz)	Band	Setting	RF Power (W)
1	769.05	Low Band 1	High Power	30
2	774.95	High Band 1	High Power	30
3	799.05	Low Band 2	High Power	30
4	804.95	High Band 2	High Power	30
5	806.05	Low Band 3	High Power	35
6	815.05	Middle Band 3	High Power	35
7	823.95	High Band 3	High Power	35
8	851.05	Low Band 4	High Power	35
9	860.05	Middle Band 4	High Power	35
10	868.95	High Band 4	High Power	35
11	769.05	Low Band 1	Low Power	2
12	774.95	High Band 1	Low Power	2
13	799.05	Low Band 2	Low Power	2
14	804.95	High Band 2	Low Power	2
15	806.05	Low Band 3	Low Power	2
16	815.05	Middle Band 3	Low Power	2
17	823.95	High Band 3	Low Power	2
18	851.05	Low Band 4	Low Power	2
19	860.05	Middle Band 4	Low Power	2
20	868.95	High Band 4	Low Power	2

RF Power: Peak reading

10.2 Unwanted Emissions (Transmitter Conducted)

REGULATIONS	: FCC Part 2 Section 1051, Part 90 Section 210 / RSS-119 Section 5.8
TEST METHOD/GUIDE	: RSS-119 Section 4.2, RSS-Gen Section 4.9

Test Procedure

- 1 The EUT and test equipment were set up as shown on the following page.
- 2 Modulate the transmitter with a 2.5 kHz sine wave at an input Level of 16 dB greater than that than that necessary to produce 50 % of rated system deviation.
- 3 Adjust the spectrum analyzer for the following setting:
 - a) RBW : 100 kHz (< 1 GHz), 1 MHz (> 1 GHz).
 - b) Detector mode : Average power (FM Modulation) , Positive peak with peak hold (Digital Modulation)
- 4 The emissions were measured for the worst case as follows:
 - a) : within a band of frequencies defined by the carrier frequency plus and minus one channel.
 - b) : from the lowest frequency generated in the EUT and to at least the 10th harmonic of the carrier frequency, or 40 GHz, whichever is lower.

Measuring Equipments

No.	Equipment	Manufacture	Model No.	Serial No.	Cal Date	Cal Exp.
1	Attenuator (20dB)	Aeroflex/Wenshel	66-20-34	BY4357	Jun. 01, 15	Jun. 30, 16
2	Attenuator (30dB)	Weinschel	WA-29-30-34	8923	Jun. 01, 15	Jun. 30, 16
3	Highpass Filter	TME	UHP-127	1511798E	Jun. 01, 15	Jun. 30, 16
4	Modulation Analyzer	Hewlett Packard	8901B	2806A01669	Oct. 13, 14	Oct. 31, 15
5	Signal Generator	Rohde&Schwarz	SMP02	845275/007	Feb. 17, 15	Feb. 29, 16
6	Audio Generator	Anritsu	MG443B	M70150	Jun. 18, 15	Jun. 30, 16
7	Spectrum Analyzer	Agilent	N9030A	US51350220	Jul. 03, 14	Jul. 31, 15
8	DC Power Supply	Daiichi denpa kogyo	GZV4000	90290931	None	None
9	Digital Multi Meter	Agilent	34401A	US36043517	Jul. 01, 14	Jul. 31, 15

Measuring Cables

No.	Cable	Manufacture	Model No.	Serial No.	Cal Date	Cal Exp.
W3	Balance Cable	Nicoon	3D-2V	KSR00092	Jan. 23, 15	Jan. 31, 16
W4	Coaxial Cable	Pacific custom	RG-58 C/U	AM90C04	Jun. 09, 15	Jun. 30, 16
W1	Coaxial Cable	Suhner	SUCOFLEX104	F0000017	Jan. 23, 15	Jan. 31, 16
W2	Coaxial Cable	Suhner	SUCOFLEX104	F0000018	Jan. 23, 15	Jan. 31, 16

Measuring Equipment Configuration

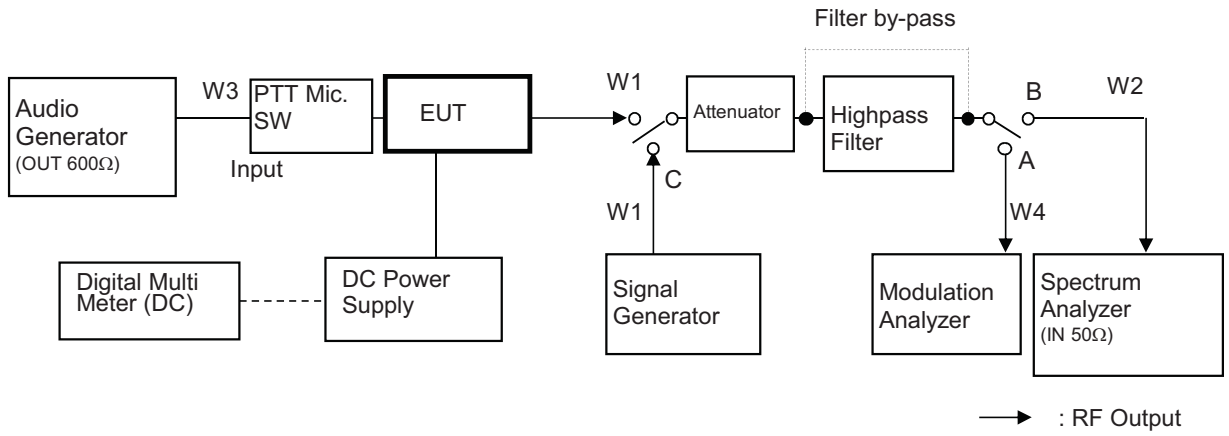

Test Results

Test date	Jul 09, 2015
Location	Kashima No.1 Test Site
temperature	22 [degree C]
Humidity Variation	60 [%]
Atmospheric Pressure	101.4 [kPa]
Test Engineer	Koichi Wagatsuma

Test was carried out for all the frequency band of section 10.1
 State the worst case (below).

State : High Power / Authorized Bandwidth 12.5 kHz

No.	Tuned Frequency (MHz)	Band	Spurious Frequency (MHz)	Correct Level (dBm)	Emission Level (dBc)	Mask D Limit (dBc)	Margin (dB)
1	806.05 (Band 3)	Low	1612.10	-35.50	-80.94	-65.4	15.5
2	815.05 (Band 3)	Middle	1630.10	-34.10	-79.54	-65.4	14.1
3	823.95 (Band 3)	High	1647.90	-35.30	-80.74	-65.4	15.3
4	851.05 (Band 4)	Low	1702.10	-34.75	-80.19	-65.4	14.8
5	860.05 (Band 4)	Middle	1720.10	-34.01	-79.45	-65.4	14.1
6	868.95 (Band 4)	High	1737.90	-33.75	-79.19	-65.4	13.8

There is the margin of 20dB over except for the above points.

Mask D Limit (dBc) = $-(50+10\log(P))$
 Correct Level (dBm) = Substitute SG Level (dBm)
 Emission Level (dBc) = Correct Level (dBm) - $10\log(P*1000)$
 P = Carrier Level (W)
 " - " = Measurement Limit

State : Low Power / Authorized Bandwidth 6 kHz

No.	Tuned Frequency (MHz)	Band	Spurious Frequency (MHz)	Correct Level (dBm)	Emission Level (dBc)	Mask E Limit (dBc)	Margin (dB)
1	806.05 (Band 3)	Low	No Point detected	-	-	-58.0	-
2	815.05 (Band 3)	Middle	No Point detected	-	-	-58.0	-
3	823.95 (Band 3)	High	No Point detected	-	-	-58.0	-
4	851.05 (Band 4)	Low	No Point detected	-	-	-58.0	-
5	860.05 (Band 4)	Middle	No Point detected	-	-	-58.0	-
6	868.95 (Band 4)	High	No Point detected	-	-	-58.0	-

There is the margin of 20dB over except for the above points.

Mask E Limit (dBc) = whichever is the lesser attenuation ; $-(55+10\log(P))$ or -65
 Correct Level (dBm) = Substitute SG Level (dBm)
 Emission Level (dBc) = Correct Level (dBm) - $10\log(P*1000)$
 P = Carrier Level (W)
 " - " = Measurement Limit

10.3 Field Strength of Spurious Radiation

REGULATIONS	:	FCC Part 2 Section 1053 (a), Part 90 Section 210 / RSS-119 Section 5.8
TEST METHOD/GUIDE	:	ANSI/TIA-603-D Section 2.2.12.2 / RSS-119 Section 4.2

Test Procedure

- 1 The EUT and test equipment were set up as shown on the following page.
- 2 Adjust the spectrum analyzer for the following setting:
 - a) RBW : 100 kHz (< 1 GHz), 1 MHz (> 1 GHz).
 - b) Detector mode : Positive Peak
- 3 The transmitter was placed on a wooden turntable, and it was transmitting into non-radiating load which was also placed on the turntable.
- 4 The measurement antenna was placed at a distance of 3 meters from the EUT. During the tests, the antenna height and polarization as well as EUT azimuth were varied in order to identify the maximum level of emissions from the EUT. The test was performed by placing the EUT on 3-orthogonal axis.
- 5 The frequency range up to tenth harmonic of the fundamental frequency was investigated.
- 6 Remove the EUT and replace it with substitution antenna. A signal generator was connected to the substitution antenna by a non-radiating cable. The absolute levels of the spurious emissions were measured by the substitution.
- 7 Spurious emissions in dB = 10 Log (TX power in Watts/0.001) – the absolute level

Measuring Equipments

No.	Equipment	Manufacture	Model No.	Serial No.	Cal Date	Cal Exp.
1	Attenuator(6dB)	HUBER+SUHNER	6806.17B	4962	Jan. 23, 15	Jan. 31, 16
2	Attenuator(10dB)	HUBER+SUHNER	6810.17B	5061	Jun. 01, 15	Jun. 30, 16
3	Dummy Load	TME	CT-150NP	1138693	Jan. 20, 15	Jan. 31, 16
4	Signal Generator	Rohde&Schwarz	SMB 100A	105709	Mar. 18, 15	Mar. 31, 16
5	Signal Generator	Rohde&Schwarz	SMP02	845275/007	Feb. 17, 15	Feb. 29, 16
6	Spectrum Analyzer	Agilent	N9030A	US51350170	Mar. 12, 15	Mar. 31, 16
7	D.R.G Antenna(RX)	Schwarzbeck	3115	5044	Jul. 16, 14	Jul. 31, 15
8	D.R.G Antenna(TX)	Schwarzbeck	3115	5045	Apr. 15, 15	Apr. 30, 16
9	Dipole Antenna(TX)	Schwarzbeck	UHA9105	AM0082002	Jul. 31, 14	Jul. 31, 15
10	Dipole Antenna(TX)	Schwarzbeck	VHA9103	C01082007	Jul. 31, 14	Jul. 31, 15
11	Tri-log Antenna(RX)	Schwarzbeck	VULB9168WP	288	Jul. 14, 14	Jul. 31, 15
12	DC Power Supply	Daiichi denpa kogyo	GZV4000	90290931	None	None
13	Digital Multi Meter	Agilent	34401A	US36043517	Jul. 01, 14	Jul. 31, 15
14	Amplifier	Intertek Japan	ZFL-1200GH+L	2013075-2	Jul. 11, 14	Jul. 31, 15
15	Amplifier	TOYO	TPA0118-30	0402	Feb. 23, 15	Feb. 29, 16
16	Attenuator	HUBER + SUHNER	6803.17.B	5111	Feb. 23, 15	Feb. 29, 16

Measuring Cables

No.	Cable	Manufacturer	Model No.	Serial No.	Cal Date	Cal Exp.
R2	Coaxial Cable	Suhner	SUCOFLEX104	F0000017	Jan. 23, 15	Jan. 31, 16
W1	Coaxial Cable	Suhner	SUCOFLEX104	KSR00091	Jun. 09, 15	Jun. 30, 16
R12	Coaxial Cable	SUHNER	SUCOFLEX 104	229603	Feb. 23, 15	Feb. 29, 16
R11	Coaxial Cable	Candox	5B-048-98-98-5000	111130	Feb. 23, 15	Feb. 29, 16
R1	Coaxial Cable	FUJIKURA	5D-2W	KSR00312	Jun. 09, 15	Jun. 30, 16
W13	Coaxial Cable	Suhner	SUCOFLEX106	KSR00207	Jun. 09, 15	Jun. 30, 16

Measuring Equipment Configuration

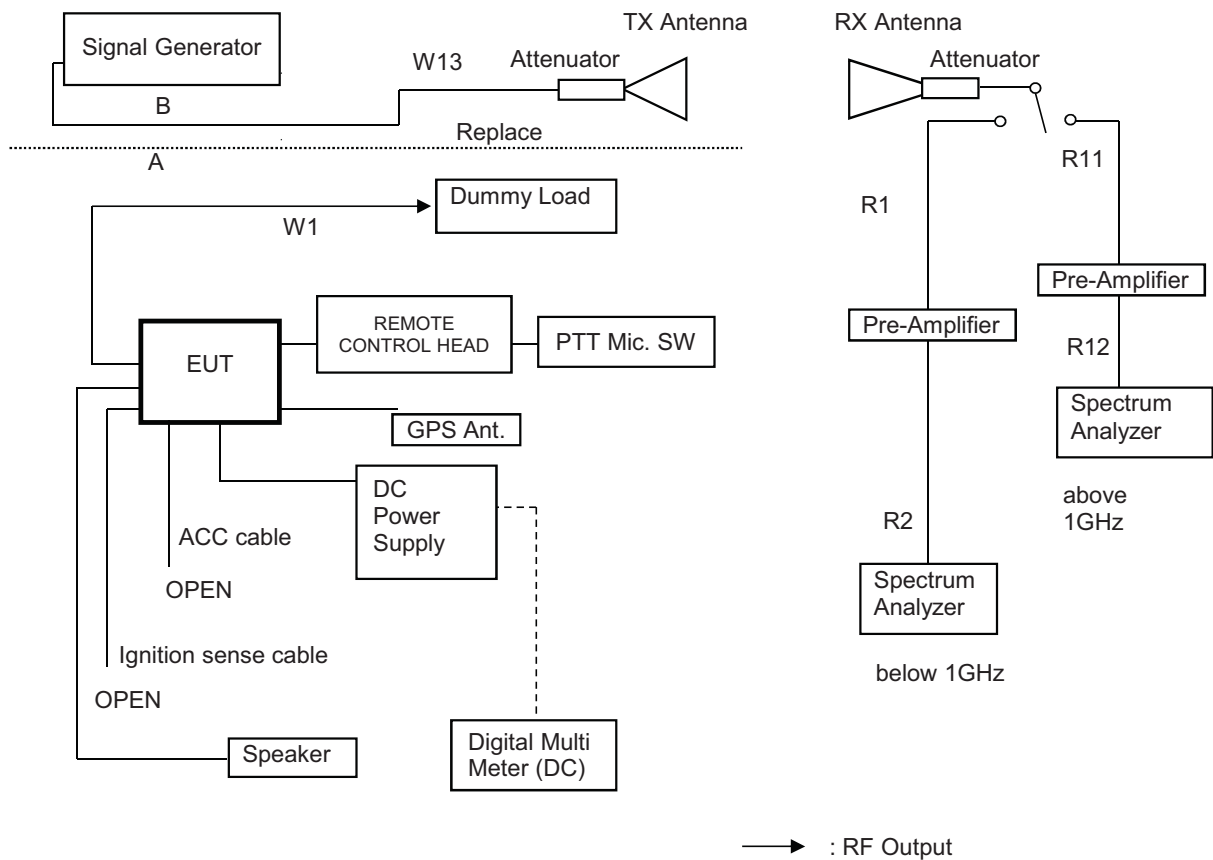

Test Results

Test date	Jul 07, 2015 to Jul 08, 2015
Location	Kashima No.12 Test Site
temperature	21 to 25 [degree C]
Humidity Variation	50 to 60 [%]
Atmospheric Pressure	101.0 to 102.3 [kPa]
Test Engineer	Koichi Wagatsuma

Test was carried out for all the frequency band of section 10.1
 State the worst case (below).

State : High Power / Authorized Bandwidth 11.25 kHz / 806.05MHz(Band3)

No	Frequency (MHz)	Pol	Reading Level (dBm)	SG Out Level (dBm)	Antenna Gain (dBi)	Loss (dB)	Correct Level (dBm)	Emission Level (dBc)	MASK D Limit Level (dBc)	Margin (dB)
1	1612.10	Hor.	-58.50	-49.00	8.42	13.14	-53.7	-99.2	-65.4	33.8
		Ver.	-57.00	-46.80	8.42	13.14	-51.5	-97.0	-65.4	31.6
2	2418.15	Hor.	-62.00	-49.20	9.41	13.92	-53.7	-99.2	-65.4	33.8
		Ver.	-62.50	-48.50	9.41	13.92	-53.0	-98.5	-65.4	33.1
3	3224.20	Hor.	-	-	9.89	14.59	-	-	-65.4	-
		Ver.	-	-	9.89	14.59	-	-	-65.4	-
4	4030.25	Hor.	-	-	9.69	15.17	-	-	-65.4	-
		Ver.	-	-	9.69	15.17	-	-	-65.4	-
5	4836.30	Hor.	-	-	10.96	15.70	-	-	-65.4	-
		Ver.	-	-	10.96	15.70	-	-	-65.4	-
6	5642.35	Hor.	-63.50	-41.10	10.95	16.18	-46.3	-91.8	-65.4	26.4
		Ver.	-59.20	-39.10	10.95	16.18	-44.3	-89.8	-65.4	24.4
7	6448.40	Hor.	-	-	11.91	16.60	-	-	-65.4	-
		Ver.	-	-	11.91	16.60	-	-	-65.4	-
8	7254.45	Hor.	-	-	11.35	17.00	-	-	-65.4	-
		Ver.	-	-	11.35	17.00	-	-	-65.4	-
9	8060.50	Hor.	-	-	11.53	17.40	-	-	-65.4	-
		Ver.	-	-	11.53	17.40	-	-	-65.4	-

There is the margin of 20dB over except for the above points.

Mask D Limit (dBc) = whichever is the lesser attenuation ; $-(50+10\log(P))$ or 70

Correct Level (dBm) = Substitute SG Level (dBm) + ANT Gain (dBi) - Loss (Cable, Attenuator) (dB)

Emission Level (dBc) = Correct Level (dBm) - $10\log(P*1000)$

P = Carrier Level (W)

" - " = Measurement Limit

State : Low Power / Authorized Bandwidth 6 kHz / 815.05MHz(Band3)

No	Frequency (MHz)	Pol	Reading Level (dBm)	SG Out Level (dBm)	Antenna Gain (dBi)	Loss (dB)	Correct Level (dBm)	Emission Level (dBc)	MASK E Limit Level (dBc)	Margin (dB)
1	1630.10	Hor.	-60.30	-50.60	8.43	13.16	-55.3	-88.3	-58.0	30.3
		Ver.	-63.30	-53.90	8.43	13.16	-58.6	-91.6	-58.0	33.6
2	2445.15	Hor.	-	-	9.46	13.95	-	-	-58.0	-
		Ver.	-	-	9.46	13.95	-	-	-58.0	-
3	3260.20	Hor.	-	-	9.91	14.62	-	-	-58.0	-
		Ver.	-	-	9.91	14.62	-	-	-58.0	-
4	4075.25	Hor.	-	-	9.83	15.20	-	-	-58.0	-
		Ver.	-	-	9.83	15.20	-	-	-58.0	-
5	4890.30	Hor.	-	-	10.93	15.73	-	-	-58.0	-
		Ver.	-	-	10.93	15.73	-	-	-58.0	-
6	5705.35	Hor.	-	-	11.01	16.21	-	-	-58.0	-
		Ver.	-	-	11.01	16.21	-	-	-58.0	-
7	6520.40	Hor.	-	-	12.09	16.64	-	-	-58.0	-
		Ver.	-	-	12.09	16.64	-	-	-58.0	-
8	7335.45	Hor.	-	-	11.12	17.04	-	-	-58.0	-
		Ver.	-	-	11.12	17.04	-	-	-58.0	-
9	8150.50	Hor.	-	-	11.51	17.45	-	-	-58.0	-
		Ver.	-	-	11.51	17.45	-	-	-58.0	-

There is the margin of 20dB over except for the above points.

Mask E Limit (dBc) = whichever is the lesser attenuation ; $-(55+10\log(P))$ or -65

Correct Level (dBm) = Substitute SG Level (dBm) + ANT Gain (dBi) - Loss (Cable, Attenuator) (dB)

Emission Level (dBc) = Correct Level (dBm) - $10\log(P*1000)$

P = Carrier Level (W)

" - " = Measurement Limit

State : High Power / Authorized Bandwidth 11.25 kHz / 851.05MHz(Band4)

No	Frequency (MHz)	Pol	Reading Level (dBm)	SG Out Level (dBm)	Antenna Gain (dBi)	Loss (dB)	Correct Level (dBm)	Emission Level (dBc)	MASK E Limit Level (dBc)	Margin (dB)
1	1702.10	Hor.	-57.30	-47.60	8.47	13.24	-52.4	-97.8	-65.0	32.8
		Ver.	-57.50	-46.80	8.47	13.24	-51.6	-97.0	-65.0	32.0
2	2553.15	Hor.	-62.50	-49.30	9.60	14.04	-53.7	-99.2	-65.0	34.2
		Ver.	-60.50	-46.80	9.60	14.04	-51.2	-96.7	-65.0	31.7
3	3404.20	Hor.	-	-	9.97	14.72	-	-	-65.0	-
		Ver.	-	-	9.97	14.72	-	-	-65.0	-
4	4255.25	Hor.	-	-	10.39	15.31	-	-	-65.0	-
		Ver.	-	-	10.39	15.31	-	-	-65.0	-
5	5106.30	Hor.	-	-	10.86	15.87	-	-	-65.0	-
		Ver.	-64.30	-44.40	10.86	15.87	-49.4	-94.8	-65.0	29.8
6	5957.35	Hor.	-68.00	-44.90	11.22	16.36	-50.0	-95.5	-65.0	30.5
		Ver.	-65.00	-42.70	11.22	16.36	-47.8	-93.3	-65.0	28.3
7	6808.40	Hor.	-	-	11.50	16.78	-	-	-65.0	-
		Ver.	-66.50	-40.90	11.50	16.78	-46.2	-91.6	-65.0	26.6
8	7659.45	Hor.	-	-	11.57	17.20	-	-	-65.0	-
		Ver.	-	-	11.57	17.20	-	-	-65.0	-
9	8510.50	Hor.	-	-	11.40	17.63	-	-	-65.0	-
		Ver.	-	-	11.40	17.63	-	-	-65.0	-

There is the margin of 20dB over except for the above points.

Mask E Limit (dBc) = whichever is the lesser attenuation ; $-(55+10\log(P))$ or -65

Correct Level (dBm) = Substitute SG Level (dBm) + ANT Gain (dB) - Loss (Cable, Attenuator) (dB)

Emission Level (dBc) = Correct Level (dBm) - $10\log(P*1000)$

P = Carrier Level (W)

" - " = Measurement Limit

State : Low Power / Authorized Bandwidth 6 kHz / 851.05MHz(Band4)

No	Frequency (MHz)	Pol	Reading Level (dBm)	SG Out Level (dBm)	Antenna Gain (dBi)	Loss (dB)	Correct Level (dBm)	Emission Level (dBc)	MASK E Limit Level (dBc)	Margin (dB)
1	1702.10	Hor.	-61.40	-51.70	8.47	13.24	-56.5	-89.5	-52.0	37.5
		Ver.	-63.50	-52.80	8.47	13.24	-57.6	-90.6	-52.0	38.6
2	2553.15	Hor.	-	-	9.60	14.04	-	-	-52.0	-
		Ver.	-	-	9.60	14.04	-	-	-52.0	-
3	3404.20	Hor.	-	-	9.97	14.72	-	-	-52.0	-
		Ver.	-	-	9.97	14.72	-	-	-52.0	-
4	4255.25	Hor.	-	-	10.39	15.31	-	-	-52.0	-
		Ver.	-	-	10.39	15.31	-	-	-52.0	-
5	5106.30	Hor.	-	-	10.86	15.87	-	-	-52.0	-
		Ver.	-	-	10.86	15.87	-	-	-52.0	-
6	5957.35	Hor.	-	-	11.22	16.36	-	-	-52.0	-
		Ver.	-	-	11.22	16.36	-	-	-52.0	-
7	6808.40	Hor.	-	-	11.50	16.78	-	-	-52.0	-
		Ver.	-	-	11.50	16.78	-	-	-52.0	-
8	7659.45	Hor.	-	-	11.57	17.20	-	-	-52.0	-
		Ver.	-	-	11.57	17.20	-	-	-52.0	-
9	8510.50	Hor.	-	-	11.40	17.63	-	-	-52.0	-
		Ver.	-	-	11.40	17.63	-	-	-52.0	-

There is the margin of 20dB over except for the above points.

Mask E Limit (dBc) = whichever is the lesser attenuation ; $-(55+10\log(P))$ or -65

Correct Level (dBm) = Substitute SG Level (dBm) + ANT Gain (dB) - Loss (Cable, Attenuator) (dB)

Emission Level (dBc) = Correct Level (dBm) - $10\log(P*1000)$

P = Carrier Level (W)

" - " = Measurement Limit

10.4 Emission Masks (Occupied Bandwidth)

REGULATIONS	: FCC Part 2 Section 1049 (c) (1), Part 90 Section 210 / RSS-119 Section 5.5
TEST METHOD/GUIDE	: ANSI/TIA-603-D Section 2.2.11.2 / RSS-119 Section 5.5

Test Procedure

- 1 The EUT and test equipment were set up as shown on the following page.
- 2 For EUT supporting audio modulation, the audio signal generator was adjusted to the frequency of maximum response and with output level set for +/- 2.5 kHz deviation (or 50 % modulation). (FM modulation).
- 3 With level constant, the signal level was increased 16 dB.
- 4 For EUT supporting digital modulation, the digital modulation mode was operated to its maximum extent.
- 5 Adjust the spectrum analyzer for the following setting:
 - a) RBW : 100Hz (Non modulation and Authorized Band 6 kHz),
 100Hz (Non modulation and Authorized Band 11.25 kHz)(Mask D),
 100Hz (Non modulation and Authorized Band 11.25 kHz)(Mask B, H, G)
 300Hz (Non modulation and Authorized Band 20 kHz).
 - b) VBW : 10times the RBW (Non modulation , Authorized Band 11.25 kHz and Authorized Band 20 kHz).
 - c) RBW and VBW : 30 kHz (Non Modulation / Digital Modulation).
- 6 The occupied Bandwidth was measured with the Spectrum Analyzer controls set as shown on the test results.

Measuring Equipments

No.	Equipment	Manufacture	Model No.	Serial No.	Cal Date	Cal Exp.
1	Attenuator (20dB)	Aeroflex/Wenshel	66-20-34	BY4357	Jun. 01, 15	Jun. 30, 16
2	Attenuator (30dB)	Weinschel	WA-29-30-34	8923	Jun. 01, 15	Jun. 30, 16
3	Modulation Analyzer	Hewlett Packard	8901B	2806A01669	Oct. 13, 14	Oct. 31, 15
4	Audio Generator	Anritsu	MG443B	M70150	Jun. 18, 15	Jun. 30, 16
5	Spectrum Analyzer	Agilent	N9030A	US51350220	Jul. 03, 14	Jul. 31, 15
6	DC Power Supply	Daiichi denpa kogyo	GZV4000	90290931	None	None
7	Digital Multi Meter	Agilent	34401A	US36043517	Jul. 01, 14	Jul. 31, 15

Measuring Cables

No.	Cable	Manufacture	Model No.	Serial No.	Cal Date	Cal Exp.
W3	Balance Cable	Nicoon	3D-2V	KSR00092	Jan. 23, 15	Jan. 31, 16
W4	Coaxial Cable	Pacific custom	RG-58 C/U	AM90C04	Jun. 09, 15	Jun. 30, 16
W1	Coaxial Cable	Suhner	SUCOFLEX104	F0000017	Jan. 23, 15	Jan. 31, 16
W2	Coaxial Cable	Suhner	SUCOFLEX104	F0000018	Jan. 23, 15	Jan. 31, 16

Measuring Equipment Configuration

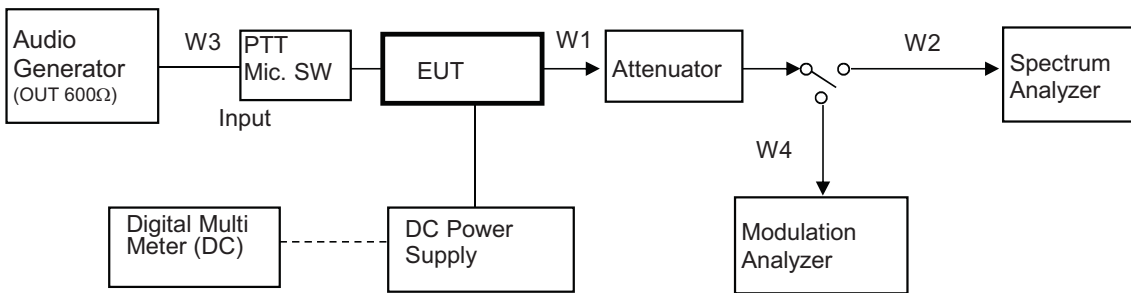

Note: Configuration of other Modulation test is composed without the Audio Generator.

→ : RF Output

Test Results

Test date	Jul 11, 2015	
Location	Kashima No.1 Test Site	
temperature	23	[degree C]
Humidity Variation	60	[%]
Atmospheric Pressure	101.1	[kPa]
Test Engineer	Koichi Wagatsuma	

Test was carried out for all the frequency band of section 10.1
 State the worst case (below).

State : High Power / Authorized Bandwidth 20 kHz/ 16K0F3E / 823.95 MHz(Band 3)
 Limit : FCC Mask B, EA / RSS Mask B

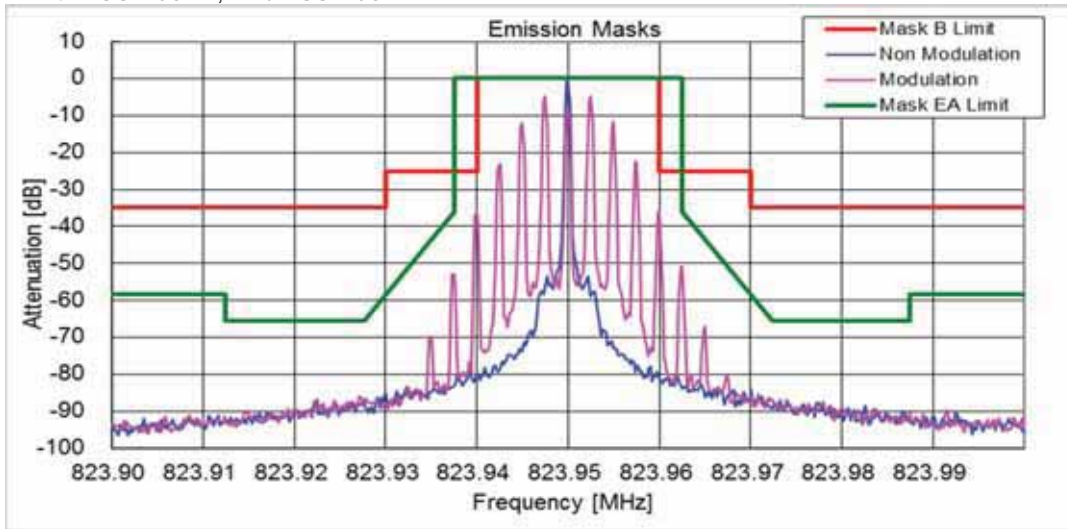

State : High Power / Authorized Bandwidth 20 kHz/ 16K0F3E / 860.05 MHz(Band 4)
 Limit : FCC Mask B, EA / RSS Mask B

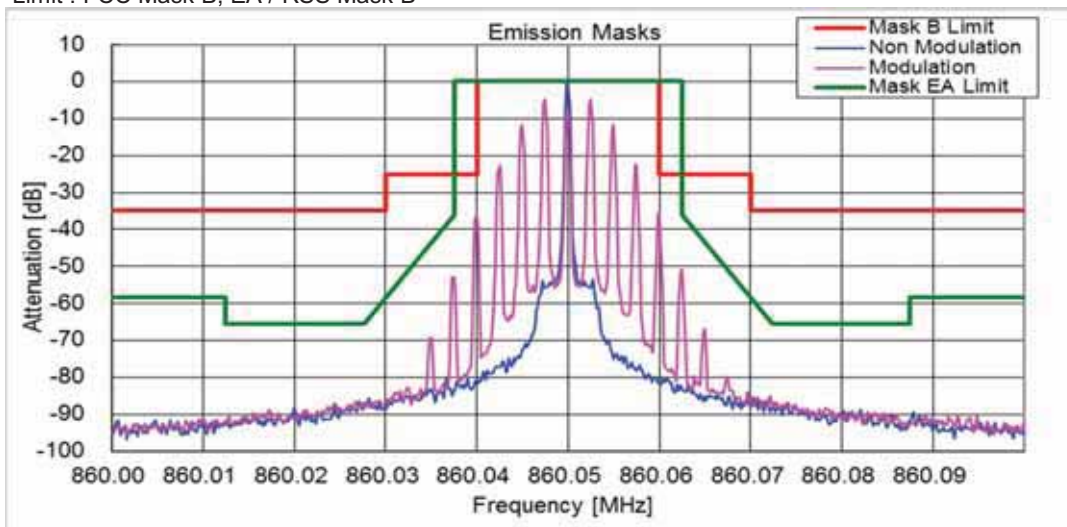

State : High Power / Authorized Bandwidth 20 kHz/ 14K0F3E / 815.05 MHz(Band 3)
Limit : FCC Mask B, EA / RSS Mask B

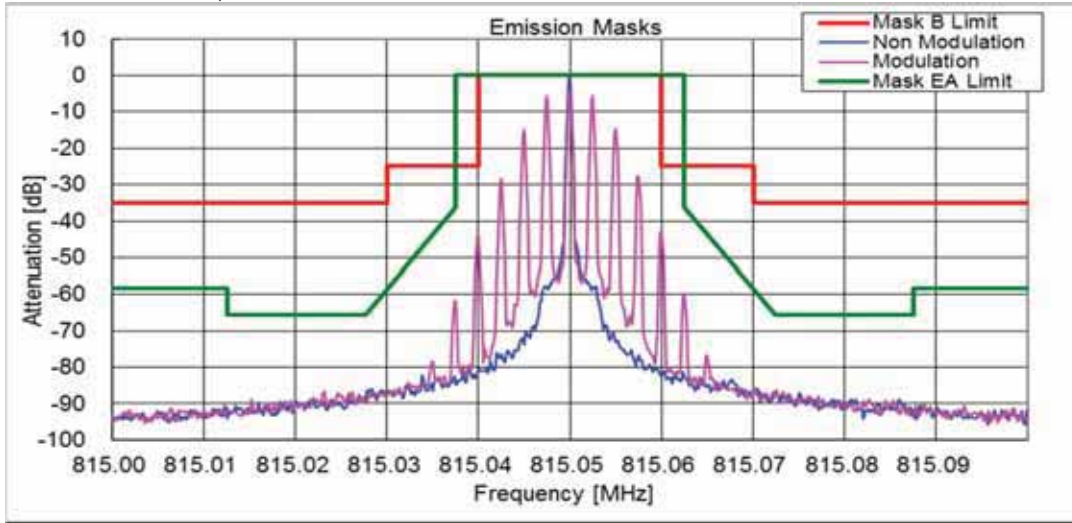

State : High Power / Authorized Bandwidth 20 kHz/ 14K0F3E / 868.95 MHz(Band 4)
Limit : FCC Mask B, EA / RSS Mask B

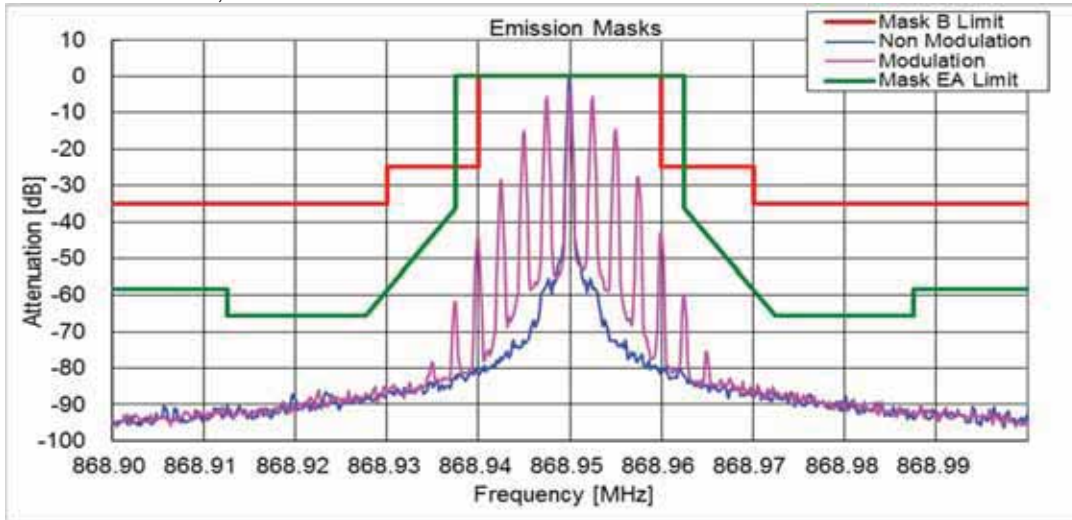

State : High Power / Authorized Bandwidth 11.25 kHz/ 11K0F3E / 815.05 MHz(Band 3)
Limit : FCC Mask B

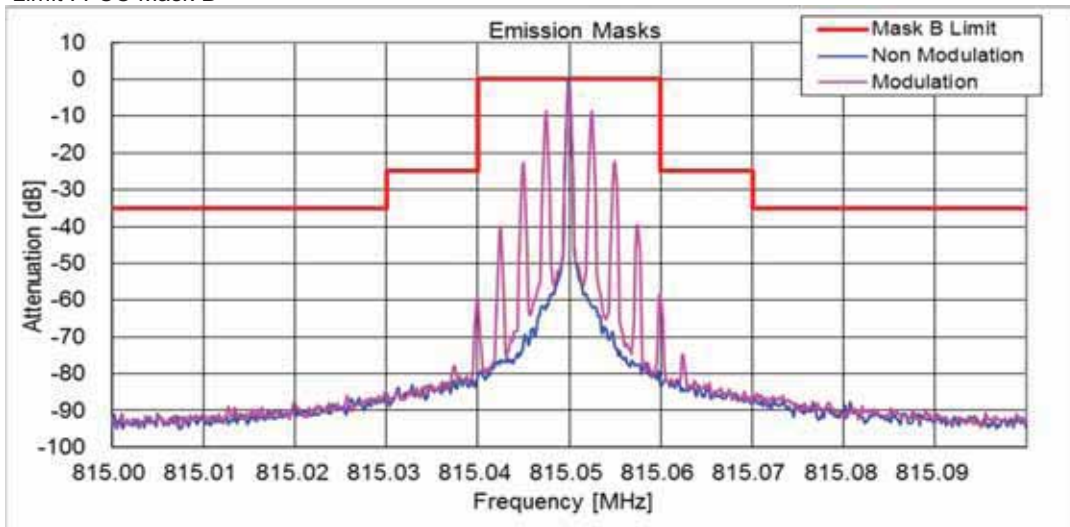

State : High Power / Authorized Bandwidth 11.25 kHz/ 11K0F3E / 806.05 MHz(Band 3)
Limit : RSS Mask D

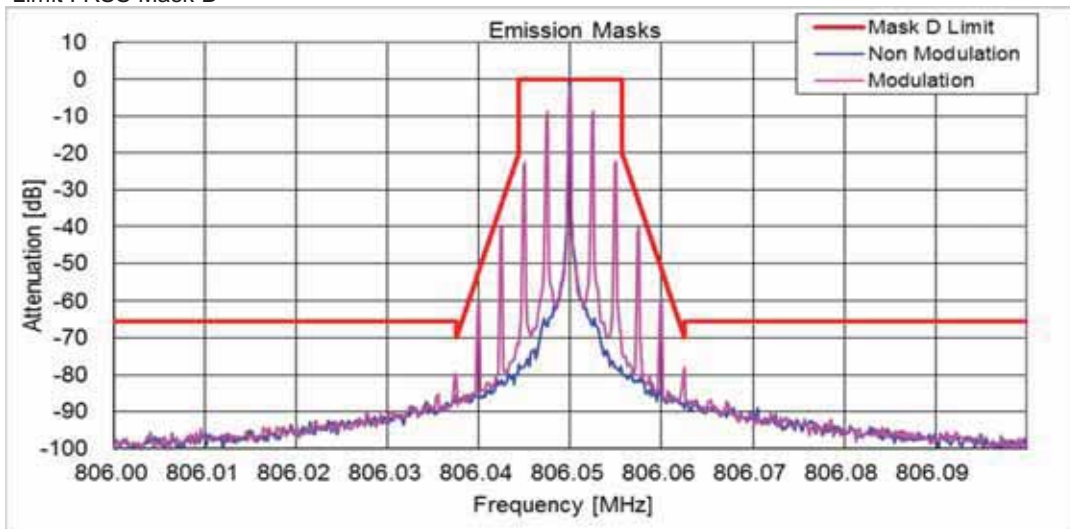

State : High Power / Authorized Bandwidth 11.25 kHz/ 11K0F3E / 860.05 MHz(Band 4)
Limit : FCC Mask B

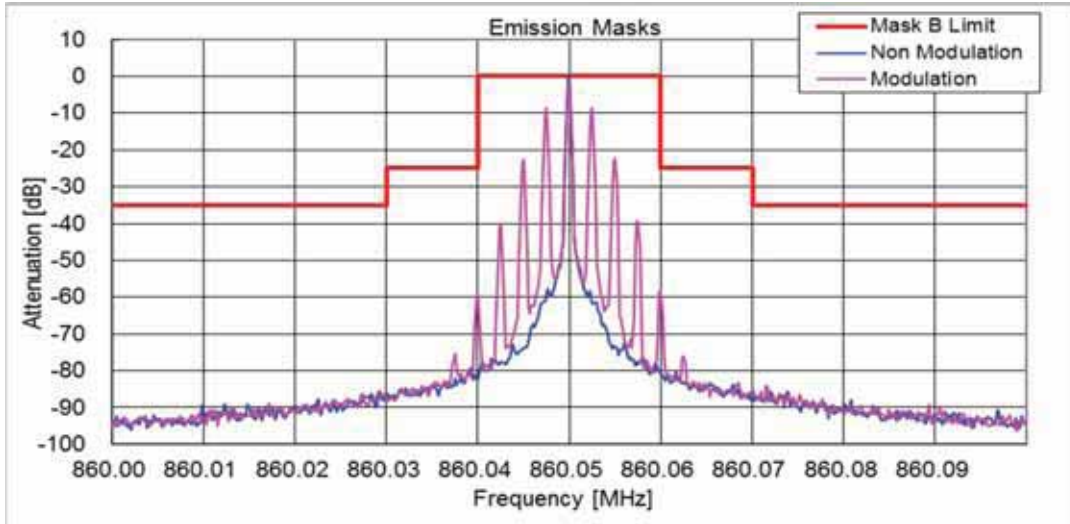

State : High Power / Authorized Bandwidth 11.25 kHz/ 11K0F3E / 868.95 MHz(Band 4)
Limit : RSS Mask D

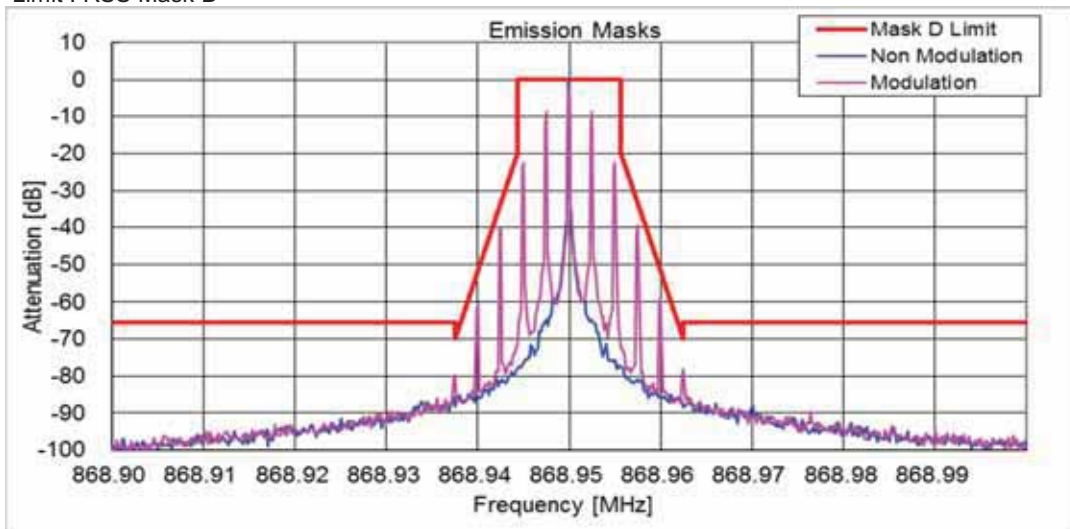

State : High Power / Authorized Bandwidth 11.25 kHz/ 8K10F1E / F1D / F1W / 806.05 MHz(Band 3)
Limit : FCC Mask H

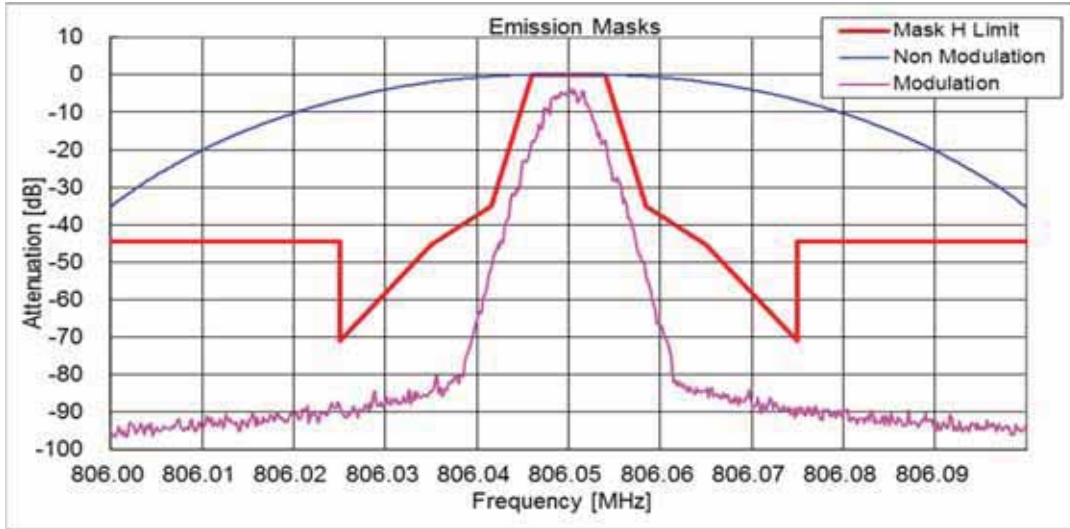

State : High Power / Authorized Bandwidth 11.25 kHz/ 8K10F1E / F1D / F1W / 815.05 MHz(Band 3)
Limit : FCC Mask G

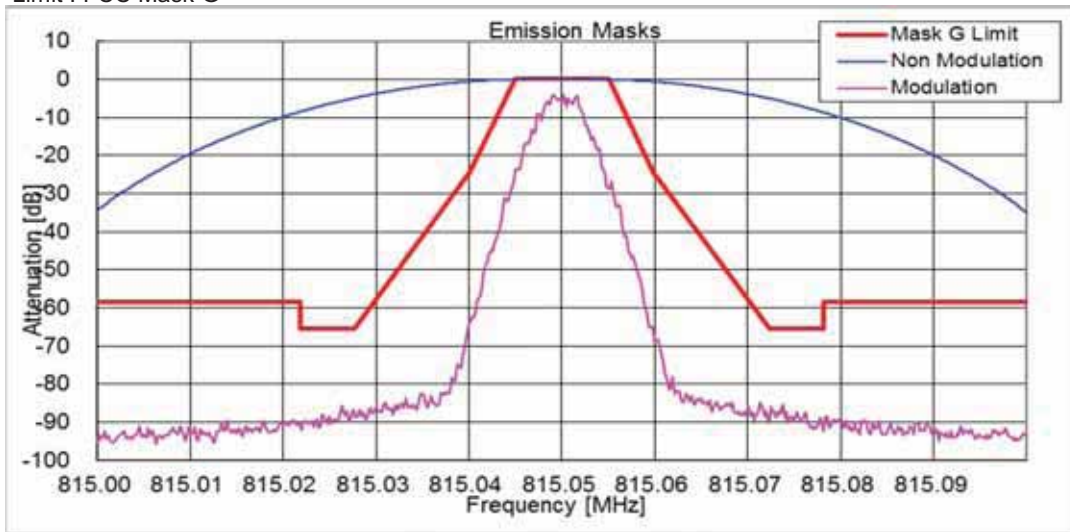

State : High Power / Authorized Bandwidth 11.25 kHz/ 8K10F1E / F1D / F1W / 823.95 MHz(Band 3)
Limit : RSS Mask D

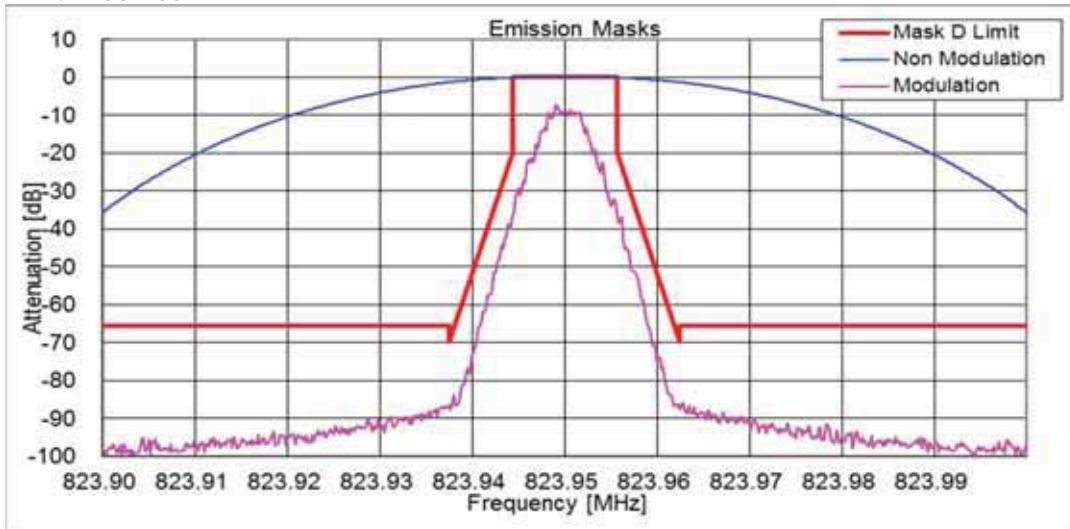

State : High Power / Authorized Bandwidth 11.25 kHz/ 8K10F1E / F1D / F1W / 851.05 MHz(Band 4)
Limit : FCC Mask H

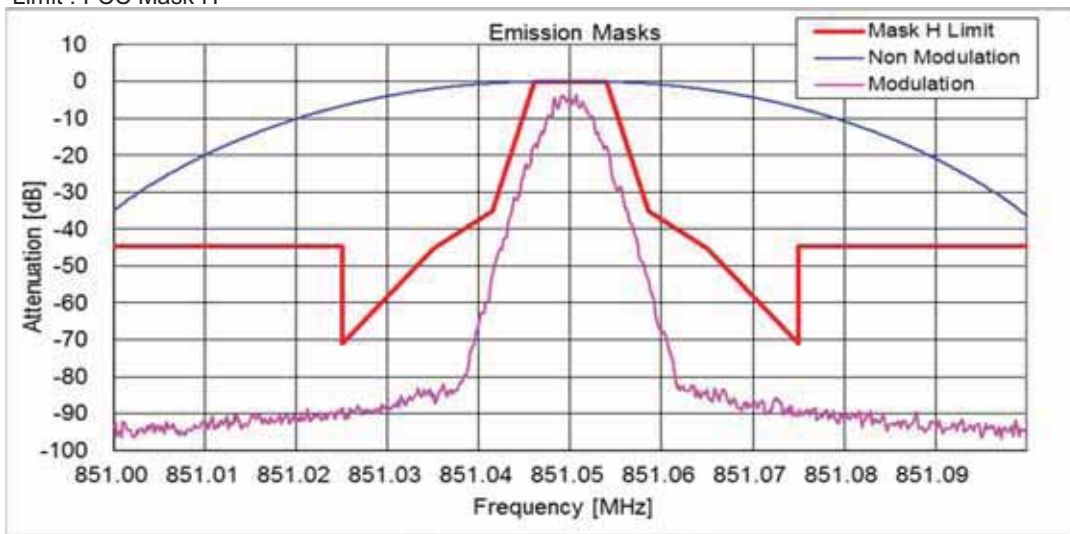

State : High Power / Authorized Bandwidth 11.25 kHz/ 8K10F1E / F1D / F1W / 860.05 MHz(Band 4)
Limit : FCC Mask G

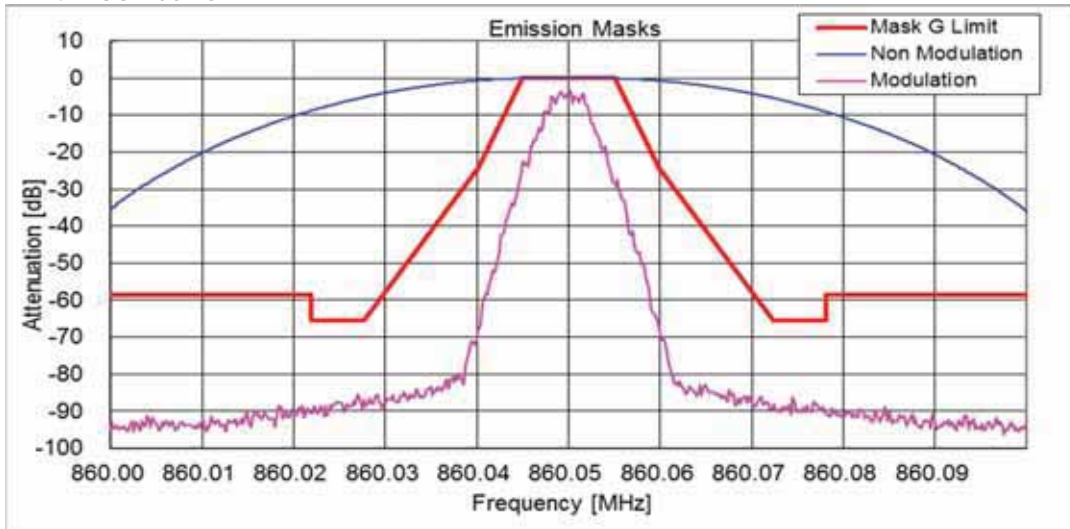

State : High Power / Authorized Bandwidth 11.25 kHz/ 8K10F1E / F1D / F1W / 860.05 MHz(Band 4)
Limit : RSS Mask D

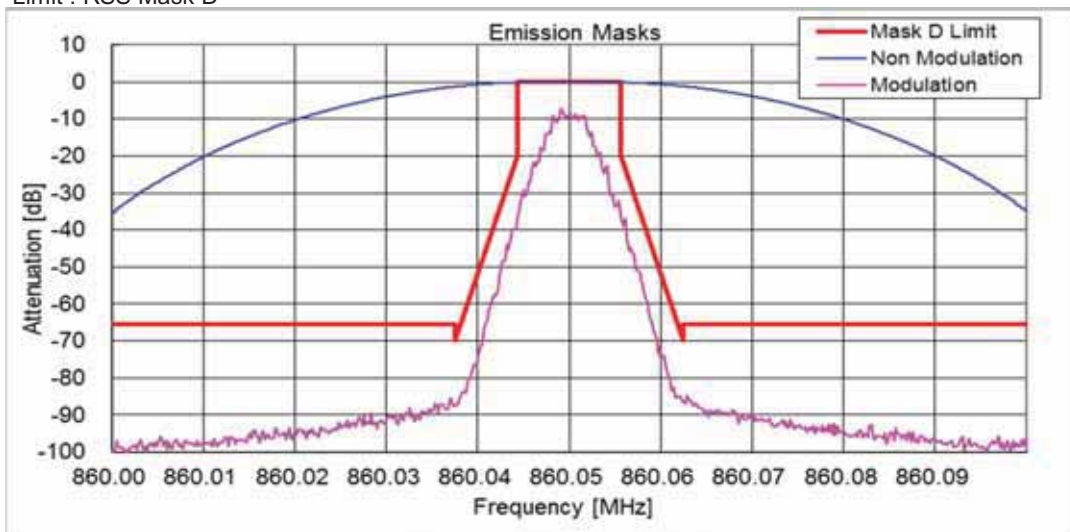

State : High Power / Authorized Bandwidth 11.25 kHz/ 8K30F1E/F1D/F7W / 806.05 MHz(Band 3)
Limit : FCC Mask H

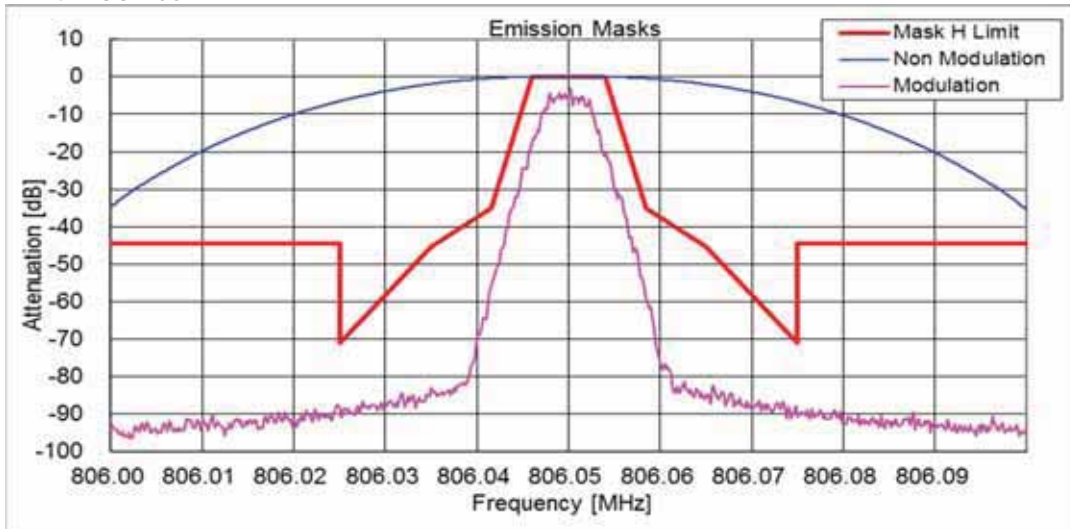

State : High Power / Authorized Bandwidth 11.25 kHz/ 8K30F1E/F1D/F7W / 823.95 MHz(Band 3)
Limit : FCC Mask G

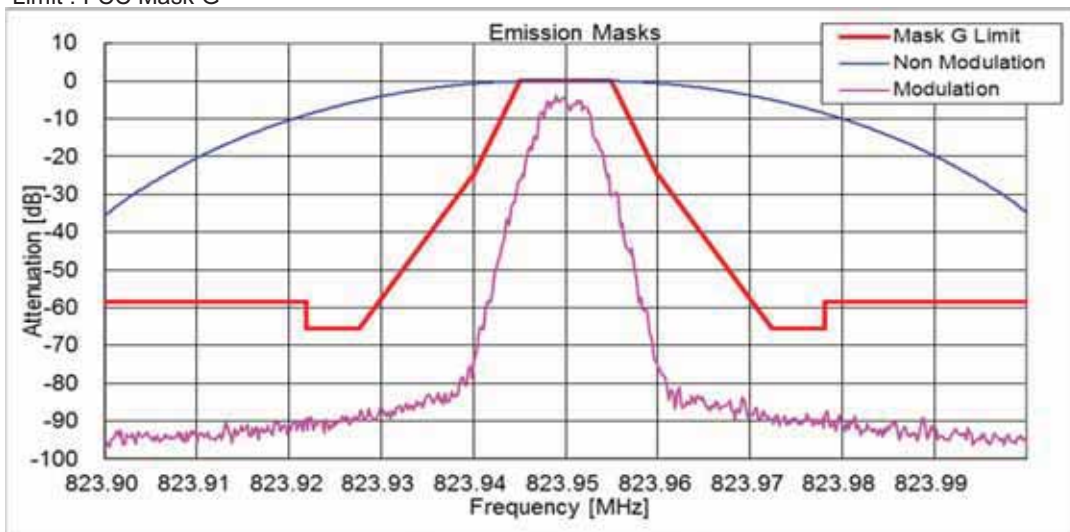

State : High Power / Authorized Bandwidth 11.25 kHz/ 8K30F1E/F1D/F7W / 823.95 MHz(Band 3)
Limit : RSS Mask D

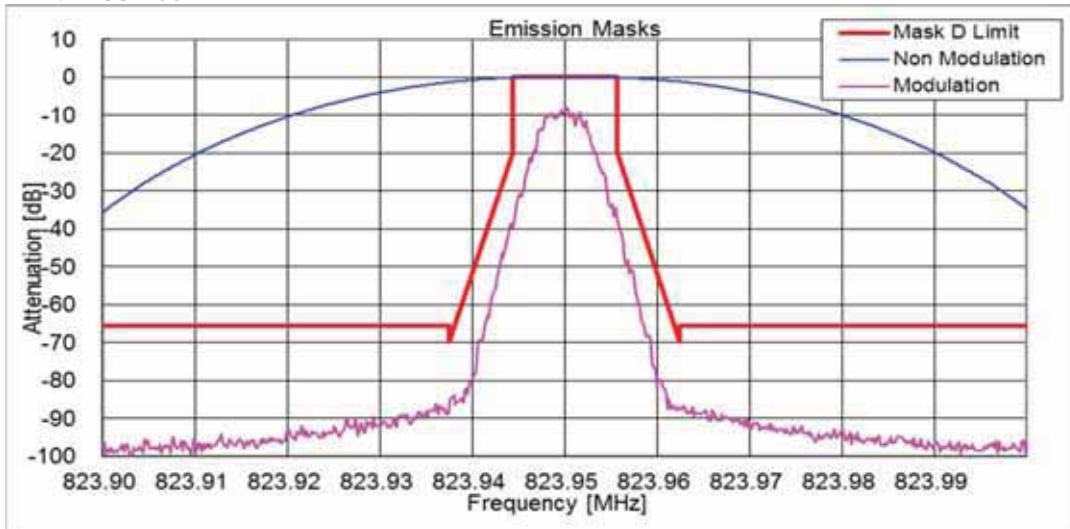

State : High Power / Authorized Bandwidth 11.25 kHz/ 8K30F1E/F1D/F7W / 851.05 MHz(Band 4)
Limit : FCC Mask H

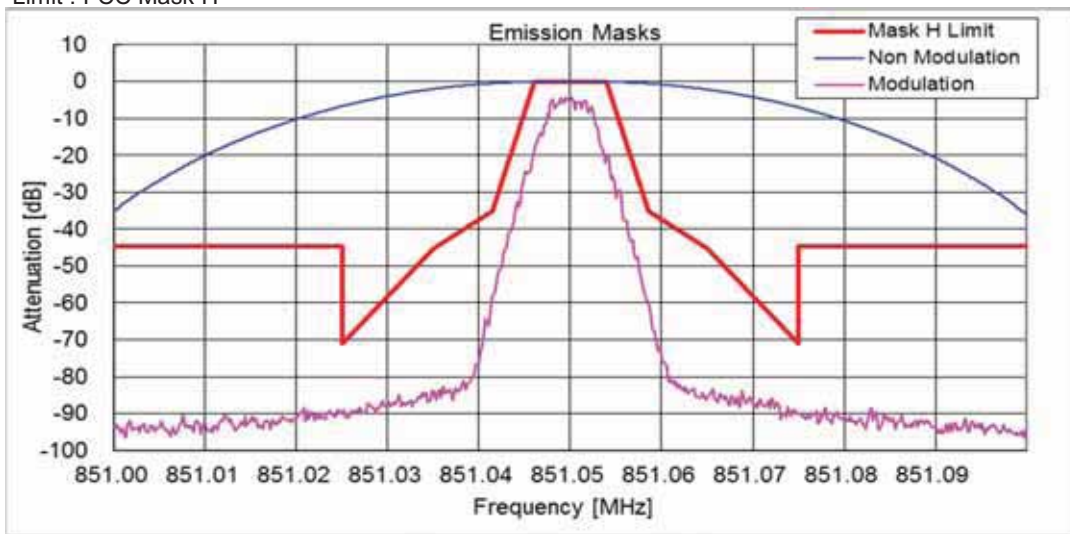

State : High Power / Authorized Bandwidth 11.25 kHz/ 8K30F1E/F1D/F7W / 868.95 MHz(Band 4)
Limit : FCC Mask G

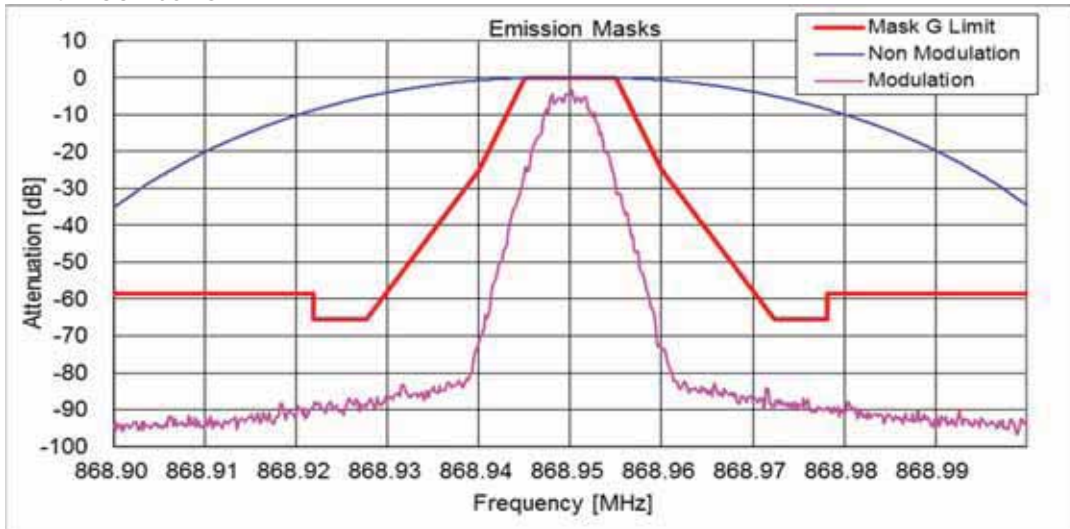

State : High Power / Authorized Bandwidth 11.25 kHz/ 8K30F1E/F1D/F7W / 868.95 MHz(Band 4)
Limit : RSS Mask D

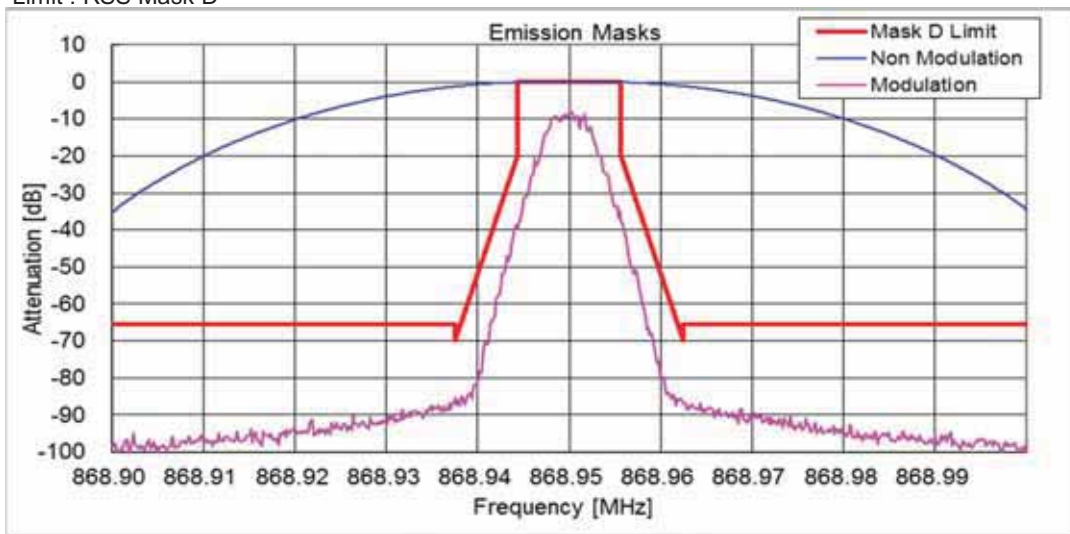

State : High Power / Authorized Bandwidth 6 kHz/ 4K00F1E / F1D / F7W / 806.05 MHz(Band 3)
Limit : FCC Mask H

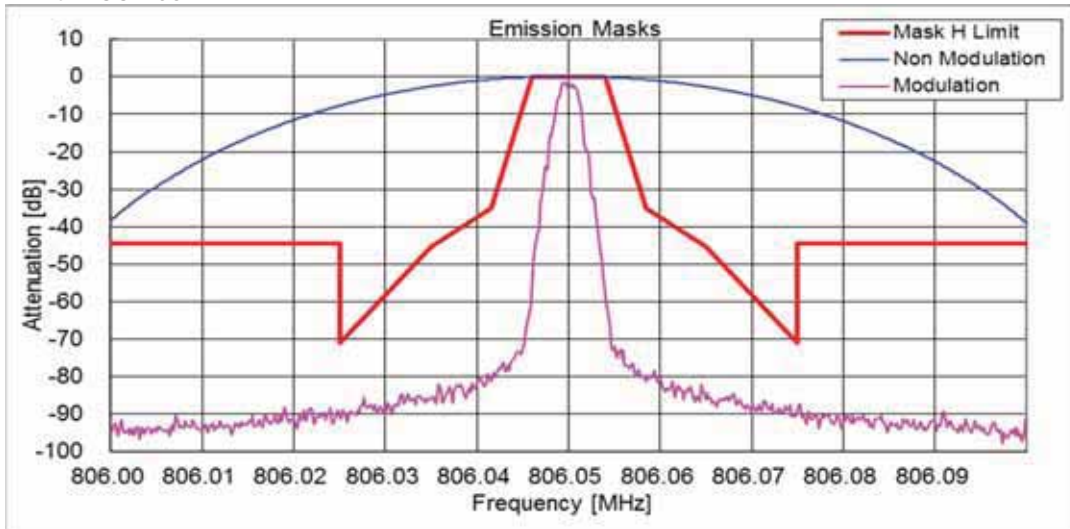

State : High Power / Authorized Bandwidth 6 kHz/ 4K00F1E / F1D / F7W / 815.05 MHz(Band 3)
Limit : FCC Mask G

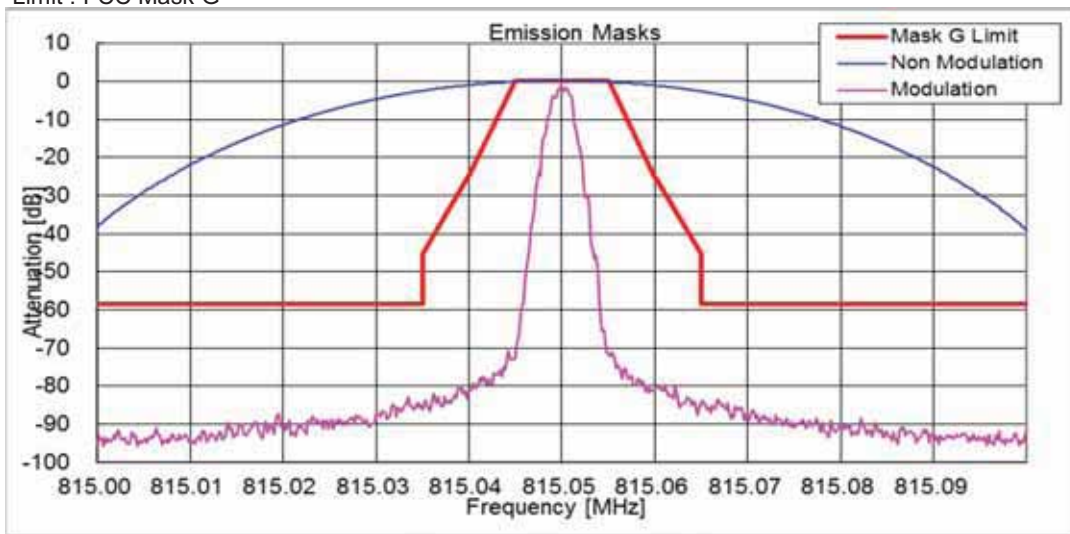

State : High Power / Authorized Bandwidth 6 kHz/ 4K00F1E / F1D / F7W / 815.05 MHz(Band 3)
Limit : RSS Mask E

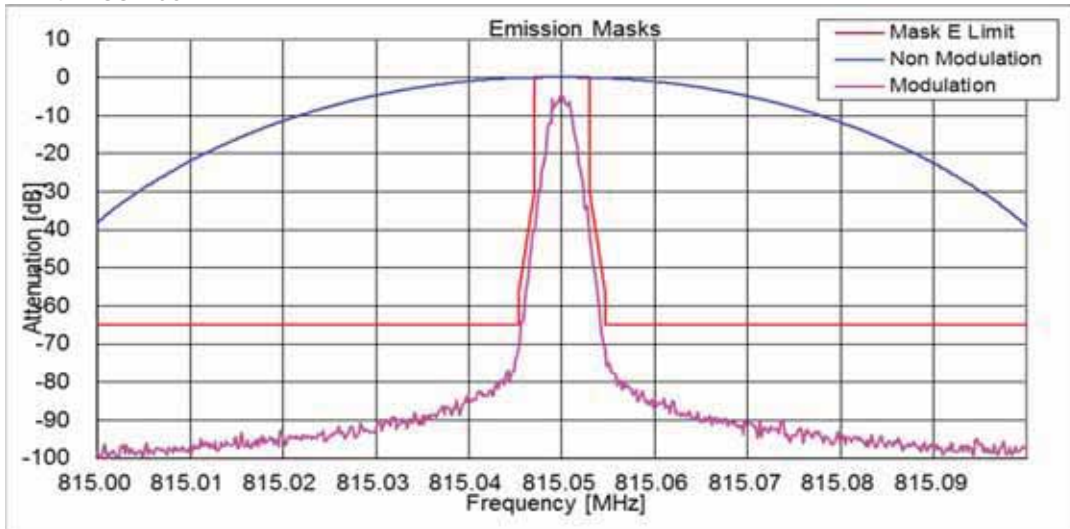

State : High Power / Authorized Bandwidth 6 kHz/ 4K00F1E / F1D / F7W / 851.05 MHz(Band 4)
Limit : FCC Mask H

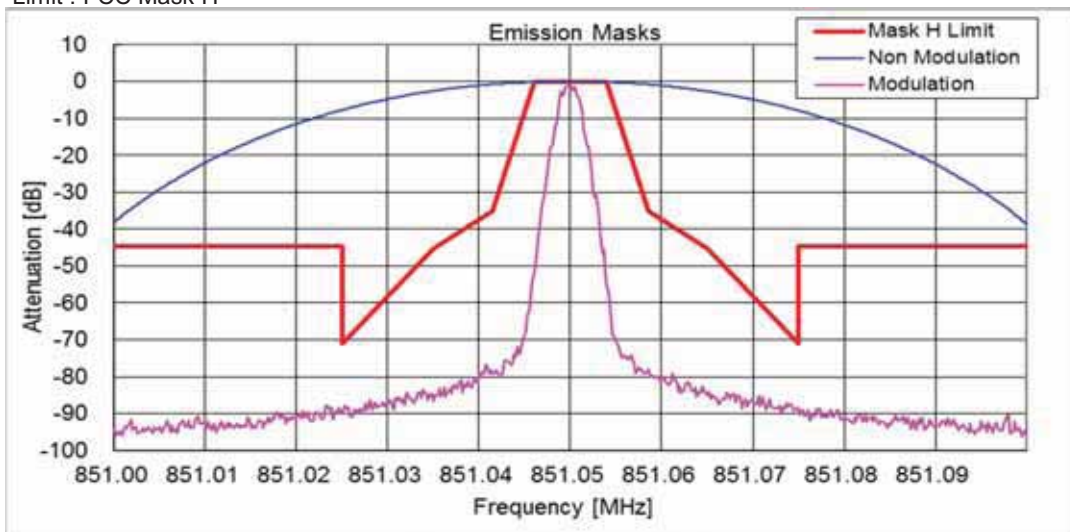

State : High Power / Authorized Bandwidth 6 kHz/ 4K00F1E / F1D / F7W / 868.95 MHz(Band 4)
Limit : FCC Mask G

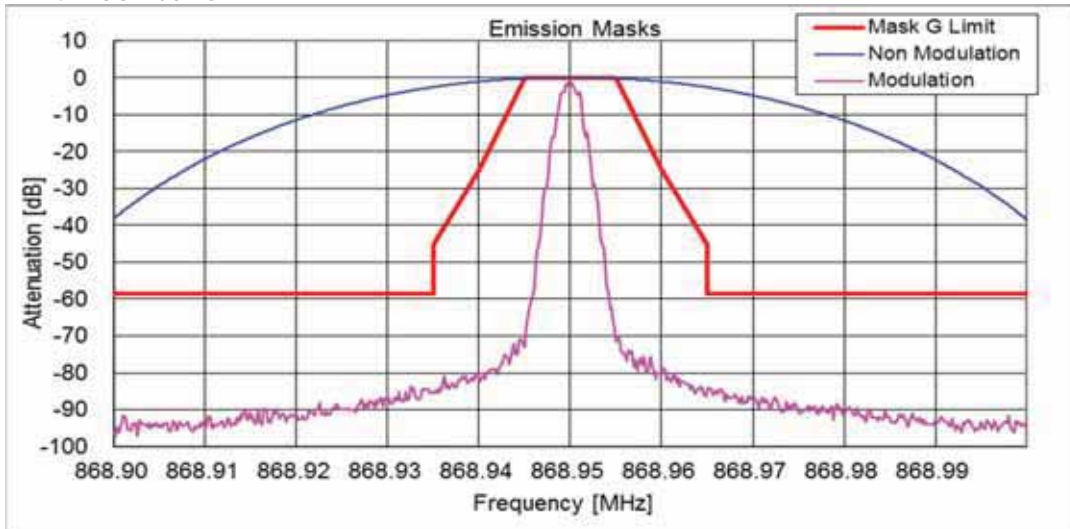

State : High Power / Authorized Bandwidth 6 kHz/ 4K00F1E / F1D / F7W / 851.05 MHz(Band 4)
Limit : RSS Mask E

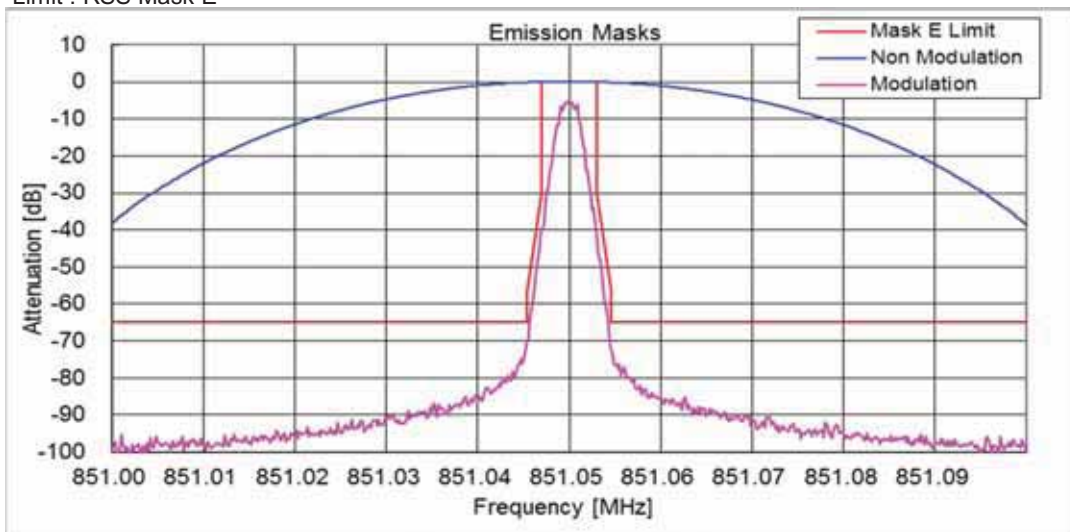

State : High Power / Authorized Bandwidth 6 kHz/ 4K00F2D / 806.05 MHz(Band 3)
Limit : FCC Mask H

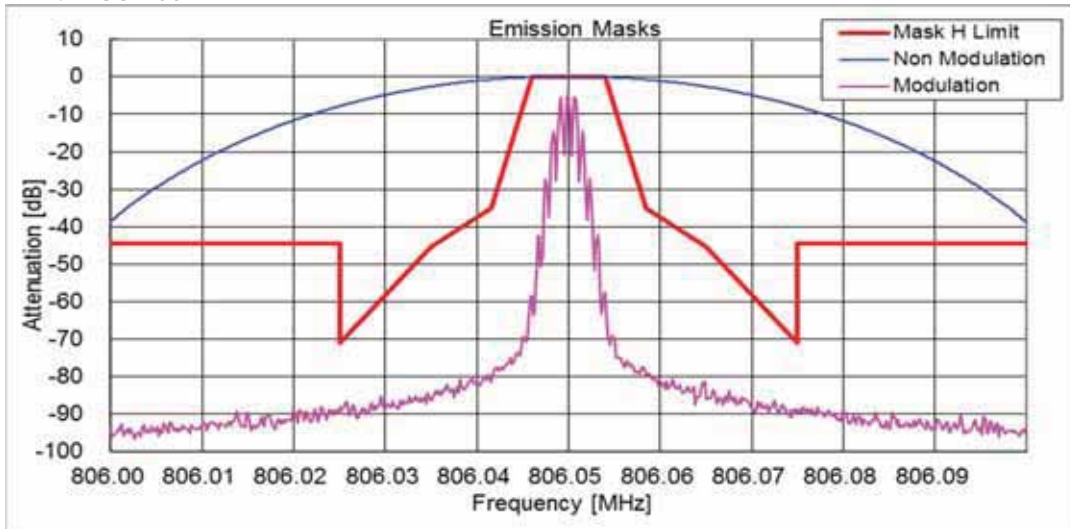

State : High Power / Authorized Bandwidth 6 kHz/ 4K00F2D / 815.05 MHz(Band 3)
Limit : FCC Mask G

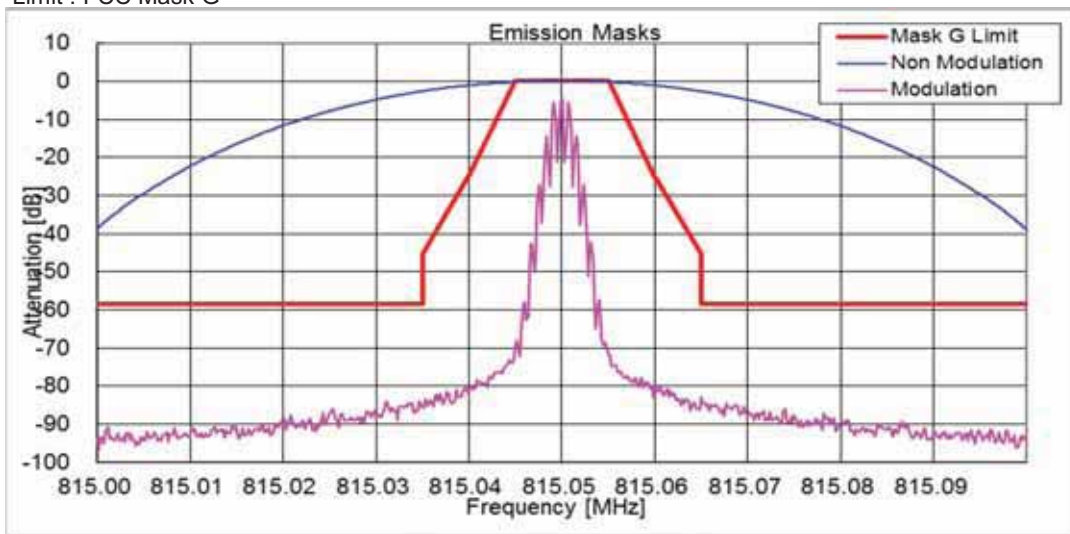

State : High Power / Authorized Bandwidth 6 kHz/ 4K00F2D / 815.05 MHz(Band 3)
Limit : RSS Mask E

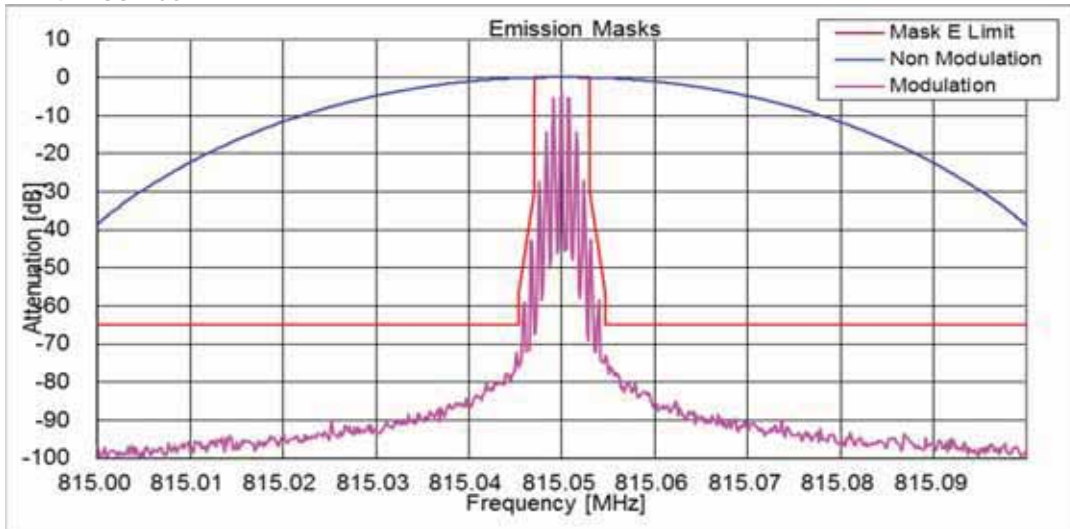

State : High Power / Authorized Bandwidth 6 kHz/ 4K00F2D / 851.05 MHz(Band 4)
Limit : FCC Mask H

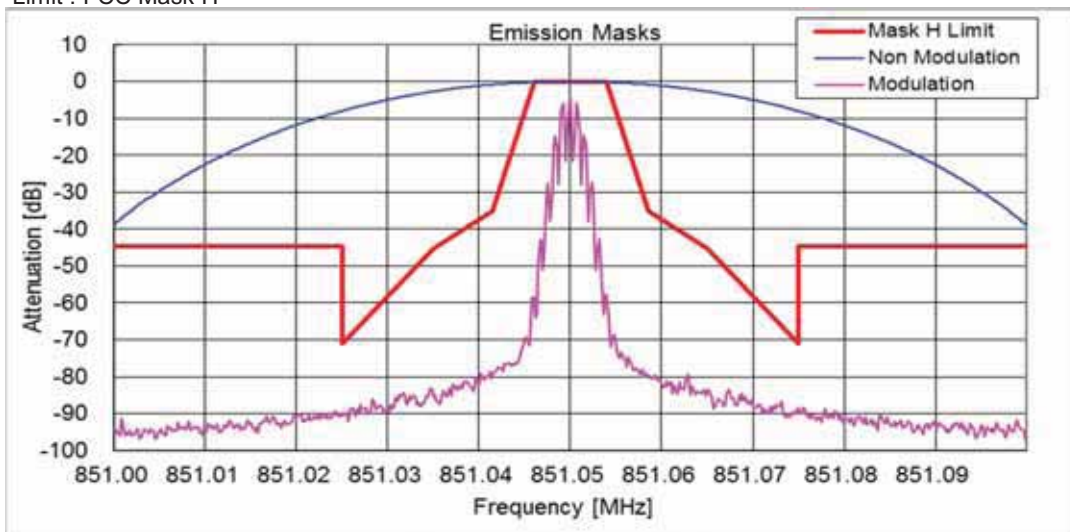

State : High Power / Authorized Bandwidth 6 kHz/ 4K00F2D / 860.05 MHz(Band 4)
Limit : FCC Mask G

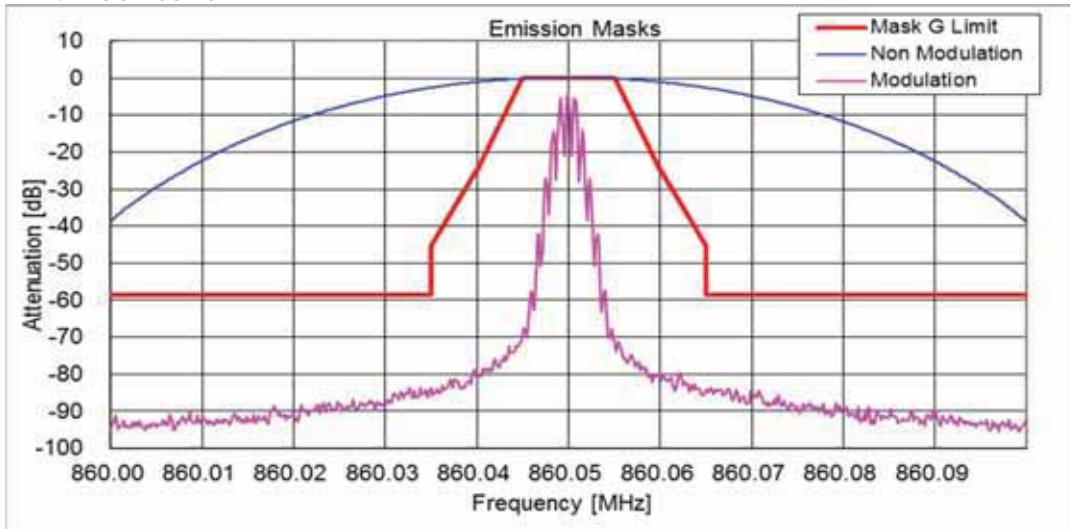

State : High Power / Authorized Bandwidth 6 kHz/ 4K00F2D / 868.95 MHz(Band 4)
Limit : RSS Mask E

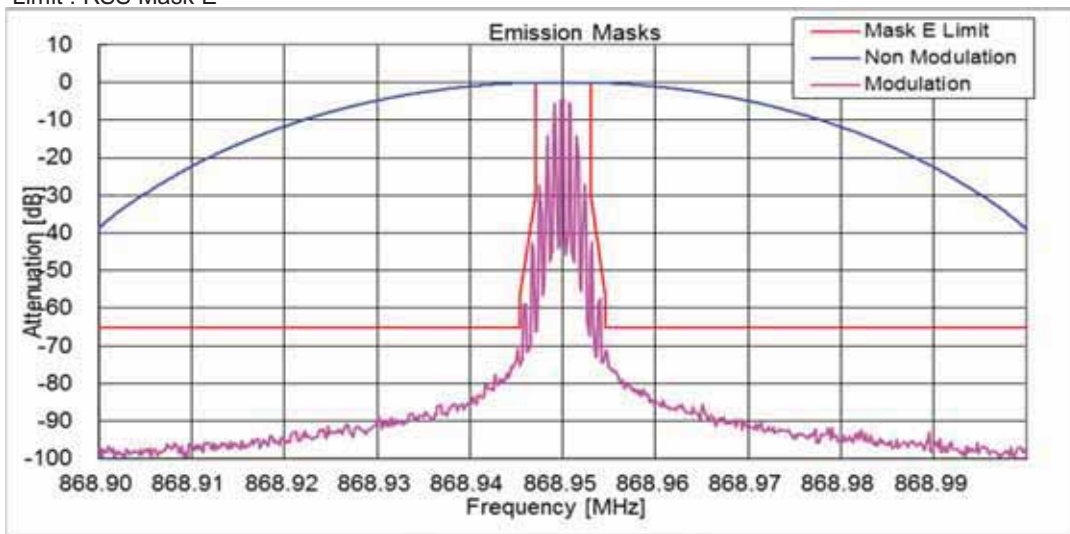

State : Low Power / Authorized Bandwidth 20 kHz/ 16K0F3E / 823.95 MHz(Band 3)
Limit : FCC Mask B, EA / RSS Mask B

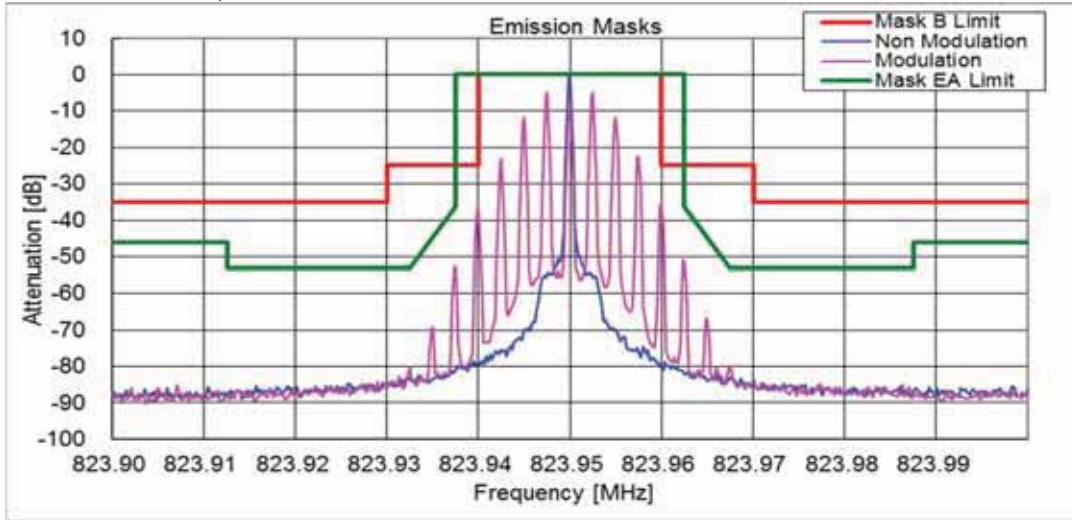

State : Low Power / Authorized Bandwidth 20 kHz/ 16K0F3E / 860.05 MHz(Band 4)
Limit : FCC Mask B, EA / RSS Mask B

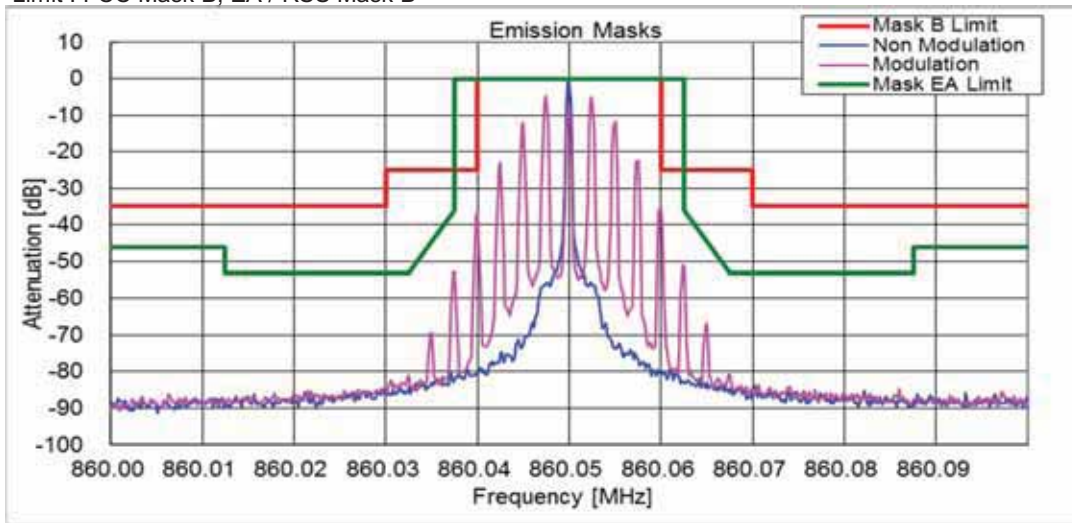

State : Low Power / Authorized Bandwidth 20 kHz/ 14K0F3E / 823.95 MHz(Band 3)
Limit : FCC Mask B, EA / RSS Mask B

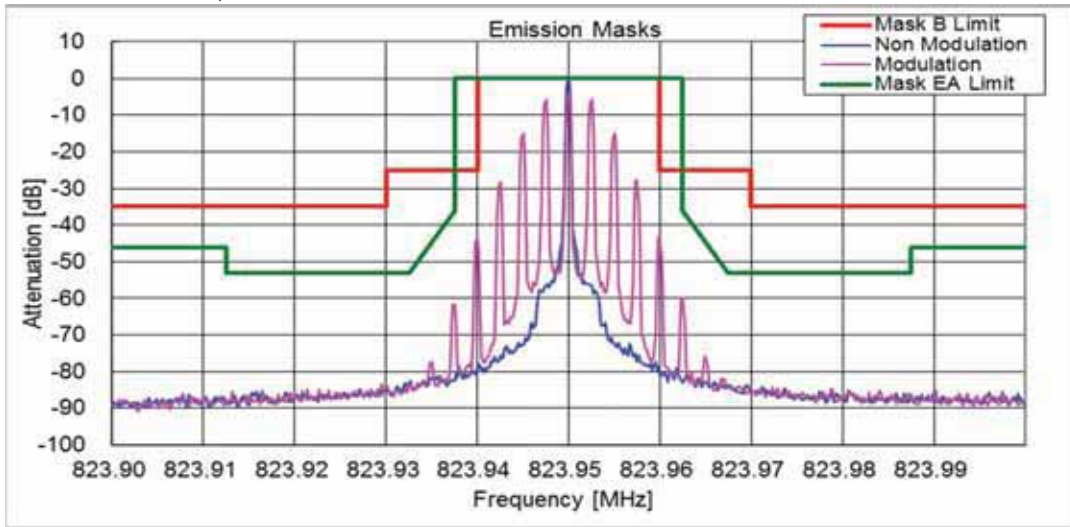

State : Low Power / Authorized Bandwidth 20 kHz/ 14K0F3E / 860.05 MHz(Band 4)
Limit : FCC Mask B, EA / RSS Mask B

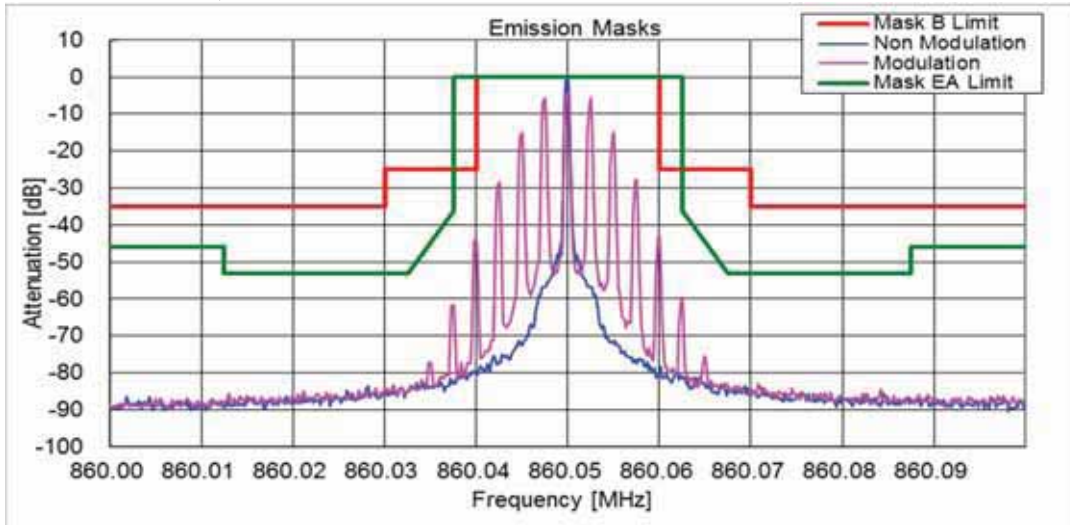

State : Low Power / Authorized Bandwidth 11.25 kHz/ 11K0F3E / 806.05 MHz(Band 3)
Limit : FCC Mask B

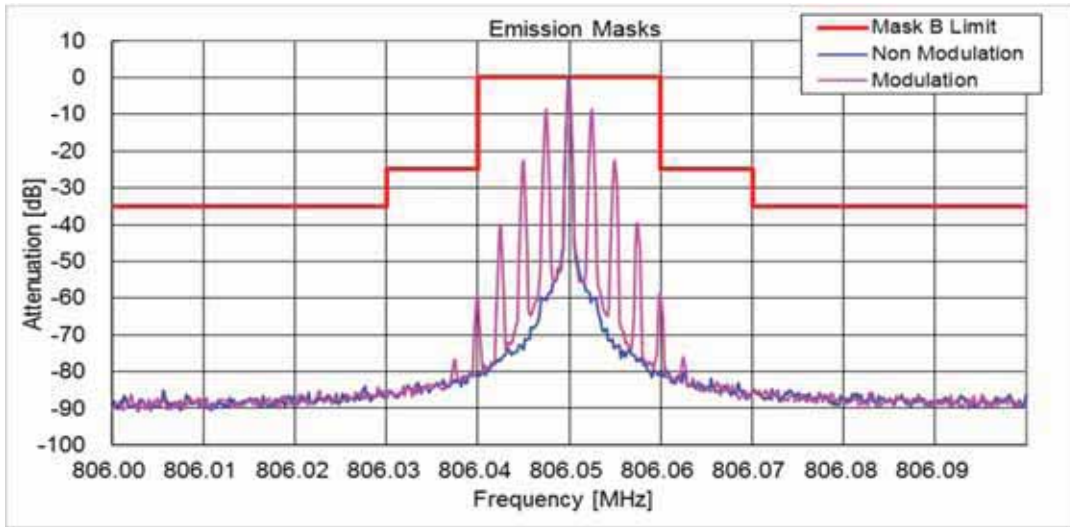

State : Low Power / Authorized Bandwidth 11.25 kHz/ 11K0F3E / 806.05 MHz(Band 3)
Limit : RSS Mask D

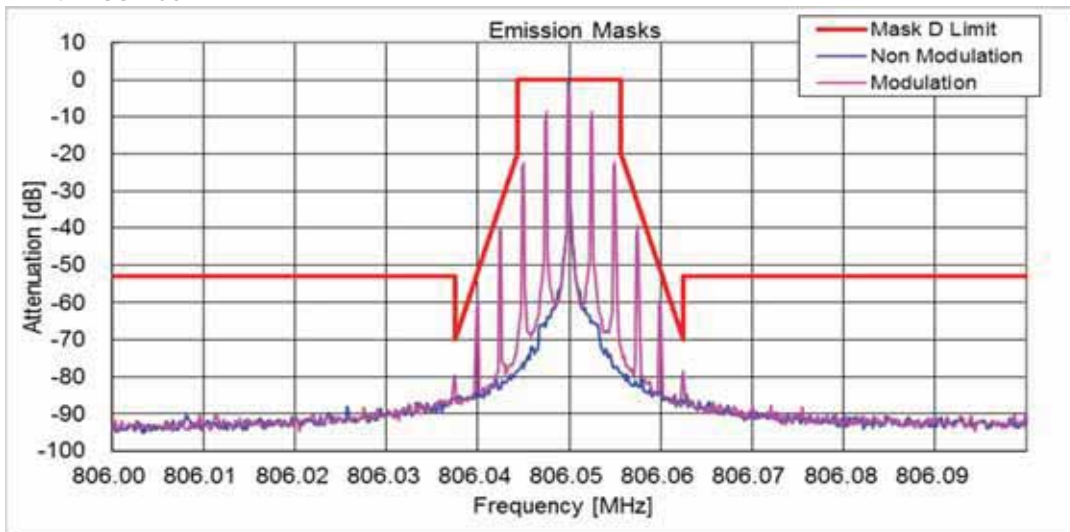

State : Low Power / Authorized Bandwidth 11.25 kHz/ 11K0F3E / 860.05 MHz(Band 4)
Limit : FCC Mask B

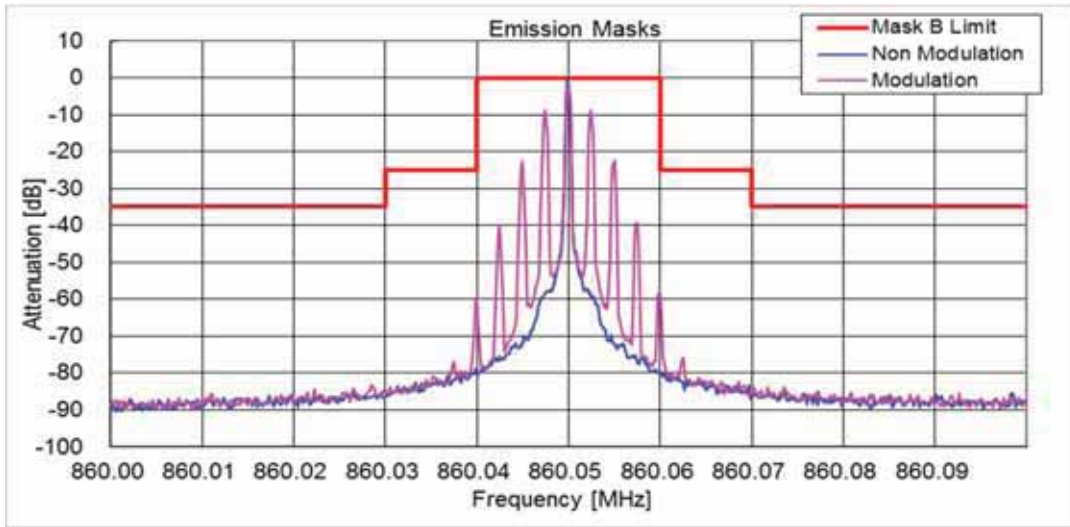

State : Low Power / Authorized Bandwidth 11.25 kHz/ 11K0F3E / 868.95 MHz(Band 4)
Limit : RSS Mask D

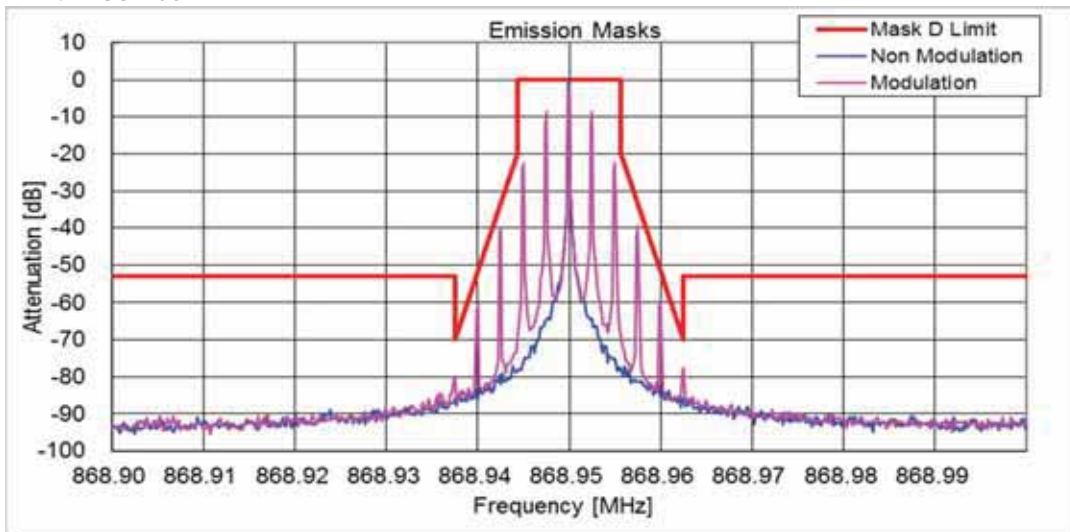

State : Low Power / Authorized Bandwidth 11.25 kHz/ 8K10F1E / F1D / F1W / 806.05 MHz(Band 3)
Limit : FCC Mask H

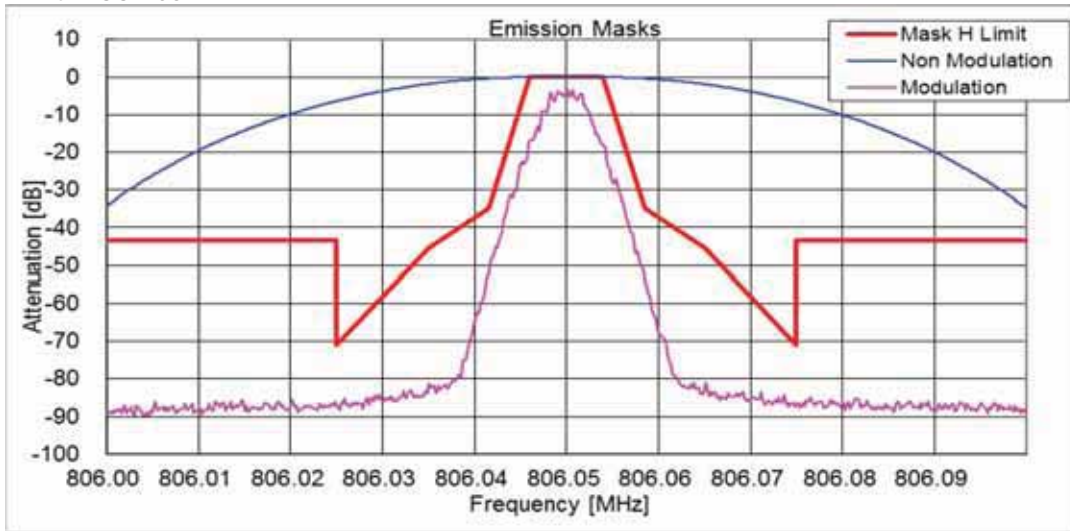

State : Low Power / Authorized Bandwidth 11.25 kHz/ 8K10F1E / F1D / F1W / 823.95 MHz(Band 3)
Limit : FCC Mask G

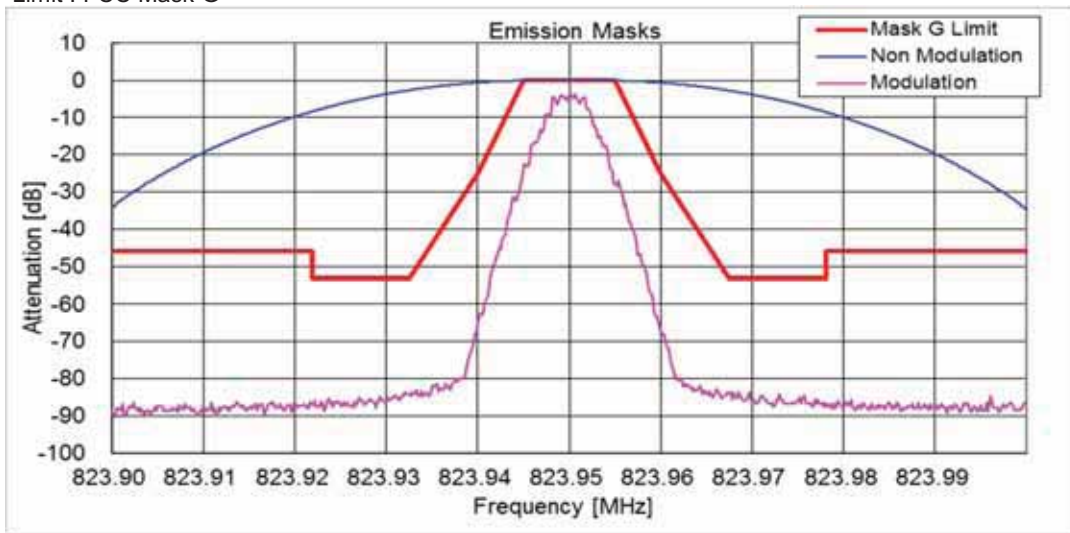

State : Low Power / Authorized Bandwidth 11.25 kHz/ 8K10F1E / F1D / F1W / 806.05 MHz(Band 3)
Limit : RSS Mask D

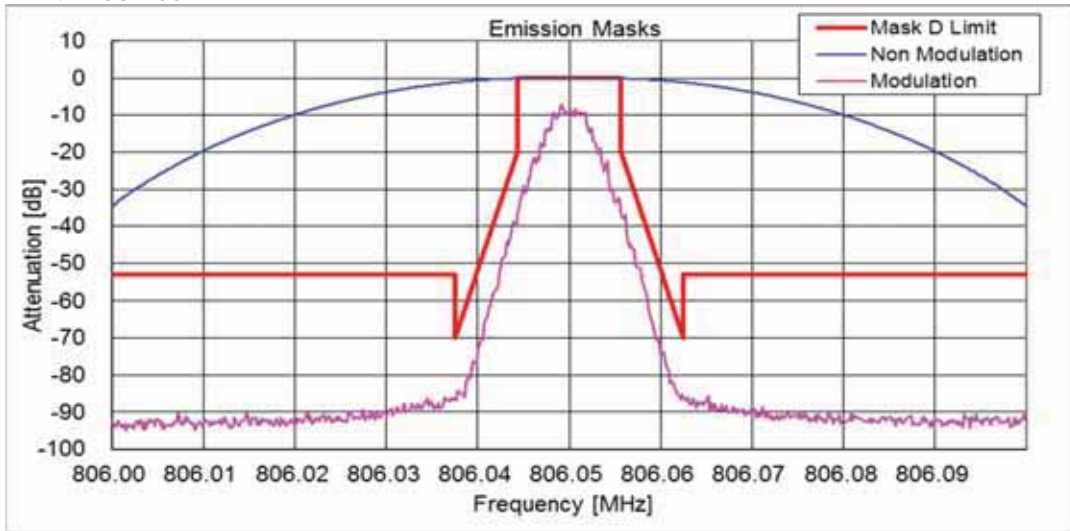

State : Low Power / Authorized Bandwidth 11.25 kHz/ 4K00F1E / F1D / F7W / 851.05 MHz(Band 4)
Limit : FCC Mask H

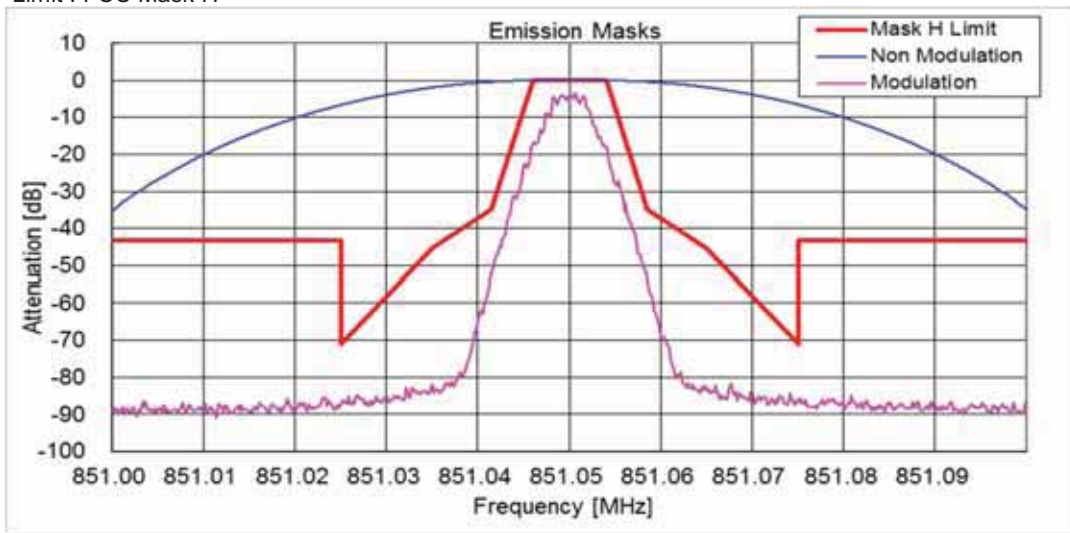

State : Low Power / Authorized Bandwidth 11.25 kHz/ 8K10F1E / F1D / F1W / 860.05 MHz(Band 4)
Limit : FCC Mask G

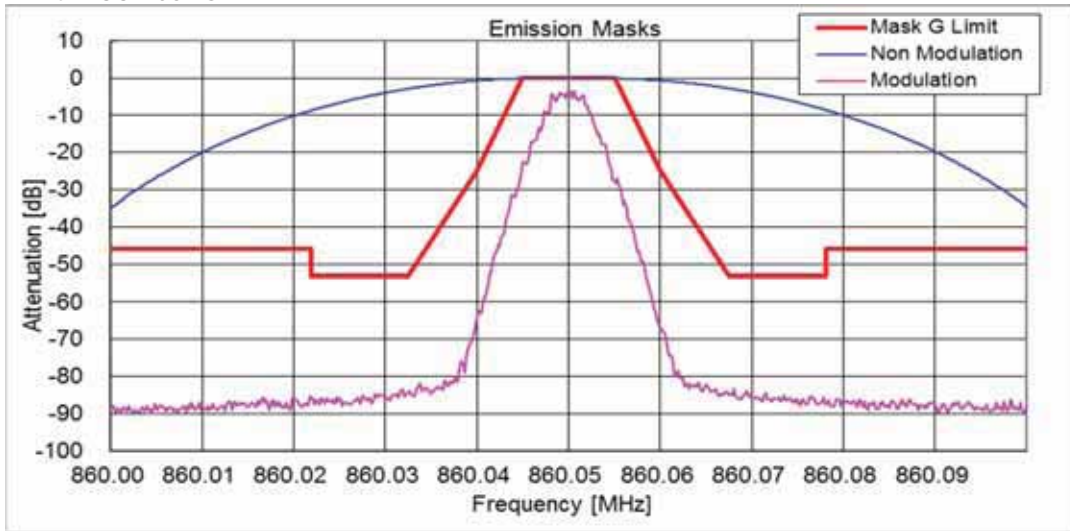

State : Low Power / Authorized Bandwidth 11.25 kHz/ 8K10F1E / F1D / F1W / 851.05 MHz(Band 4)
Limit : RSS Mask D

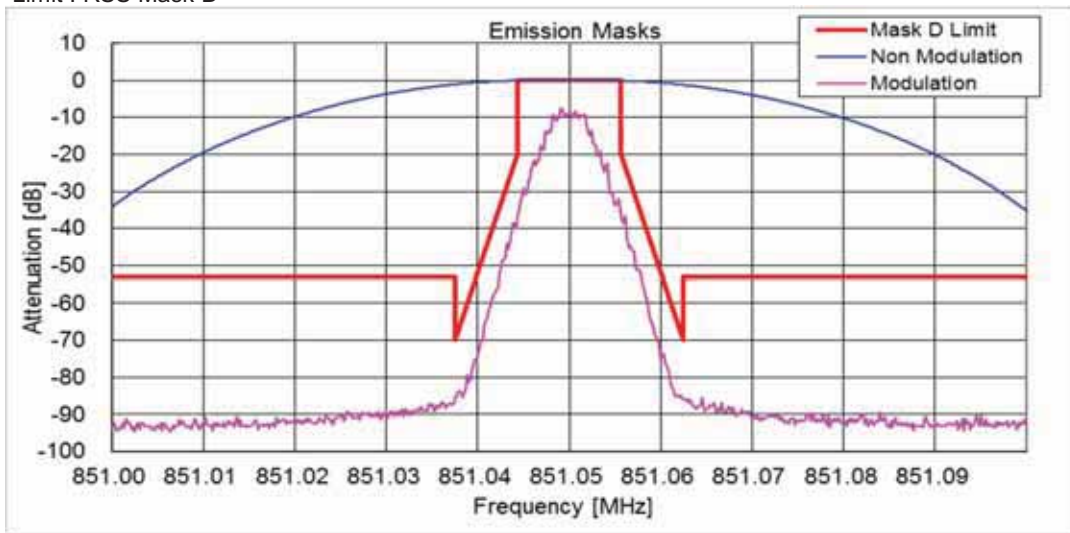

State : Low Power / Authorized Bandwidth 11.25 kHz/ 8K30F1E/F1D/F7W / 806.05 MHz(Band 3)
Limit : FCC Mask H

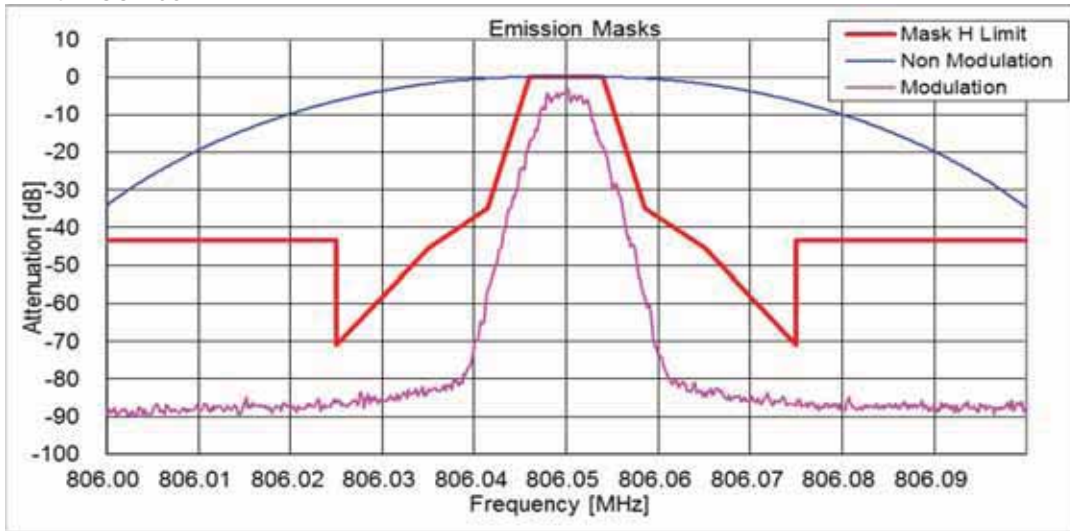

State : Low Power / Authorized Bandwidth 11.25 kHz/ 8K30F1E/F1D/F7W / 823.95 MHz(Band 3)
Limit : FCC Mask G

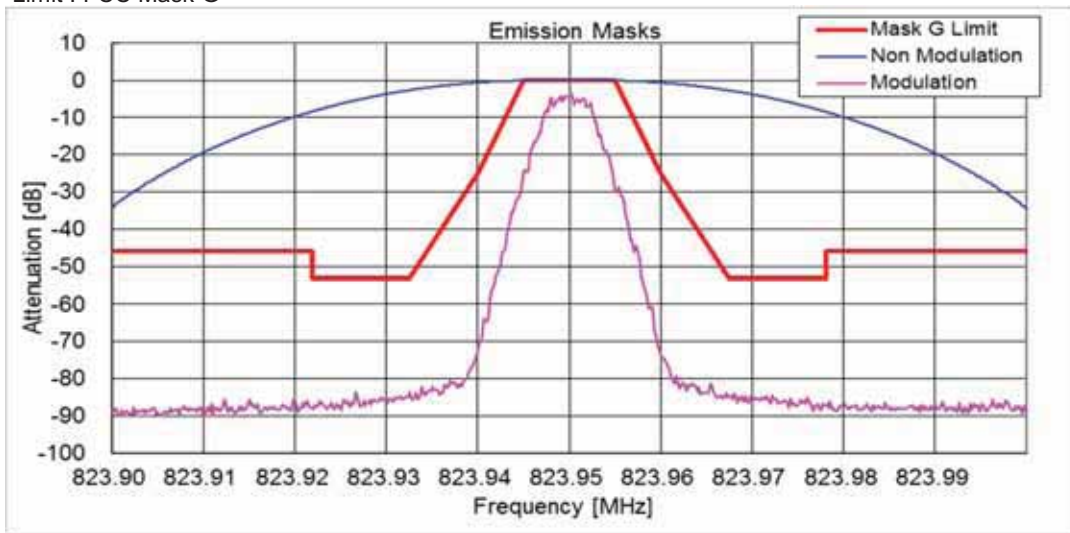

State : Low Power / Authorized Bandwidth 11.25 kHz/ 8K30F1E/F1D/F7W / 806.05 MHz(Band 3)
Limit : RSS Mask D

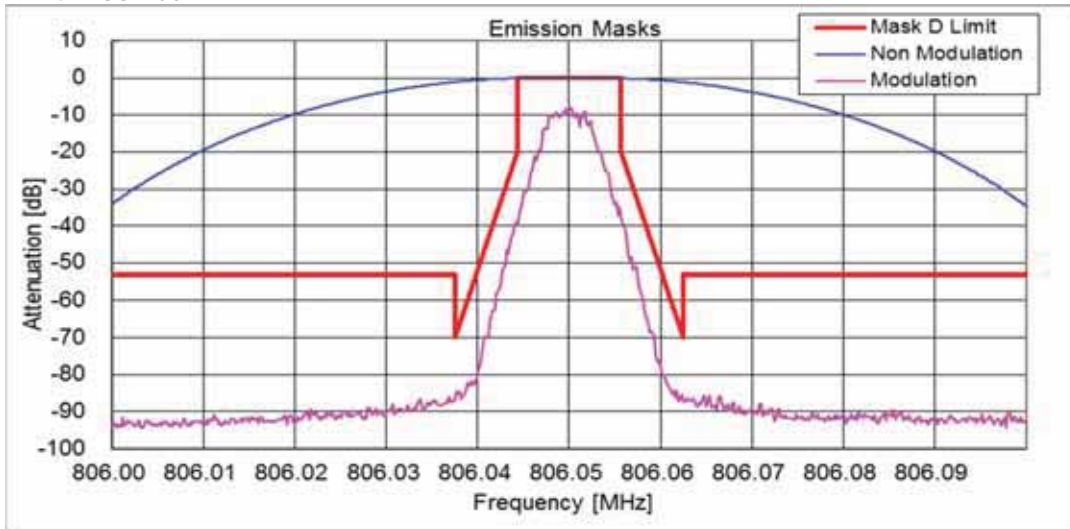

State : Low Power / Authorized Bandwidth 11.25 kHz/ 8K30F1E/F1D/F7W / 851.05 MHz(Band 4)
Limit : FCC Mask H

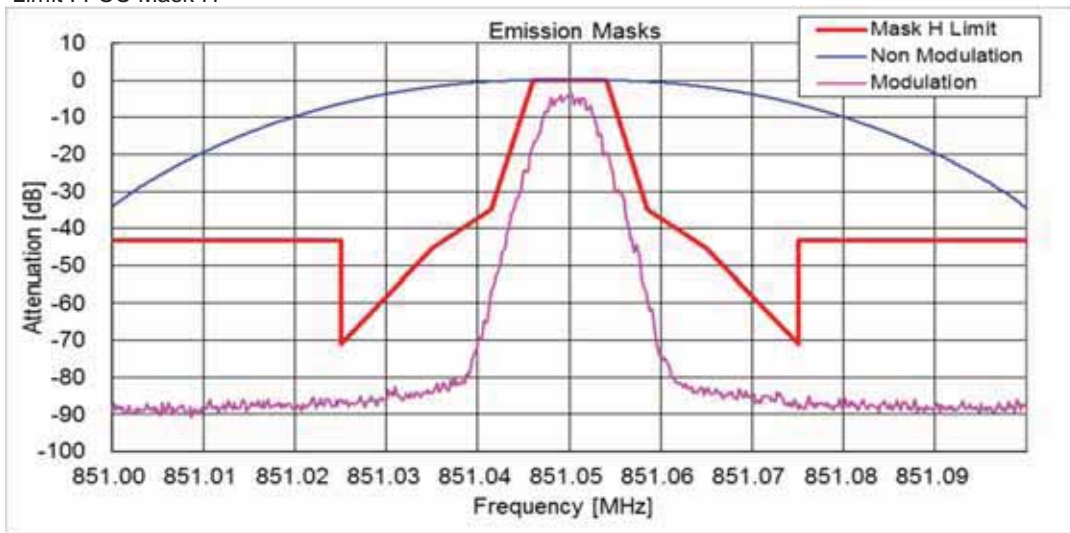

State : Low Power / Authorized Bandwidth 11.25 kHz/ 8K30F1E/F1D/F7W / 868.95 MHz(Band 4)
Limit : FCC Mask G

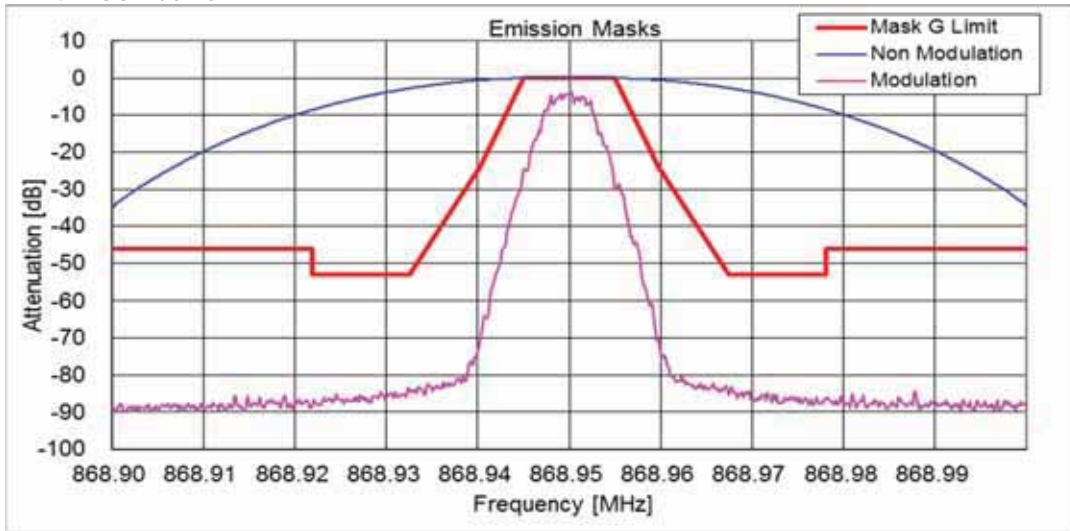

State : Low Power / Authorized Bandwidth 11.25 kHz/ 8K30F1E/F1D/F7W / 860.05 MHz(Band 4)
Limit : RSS Mask D

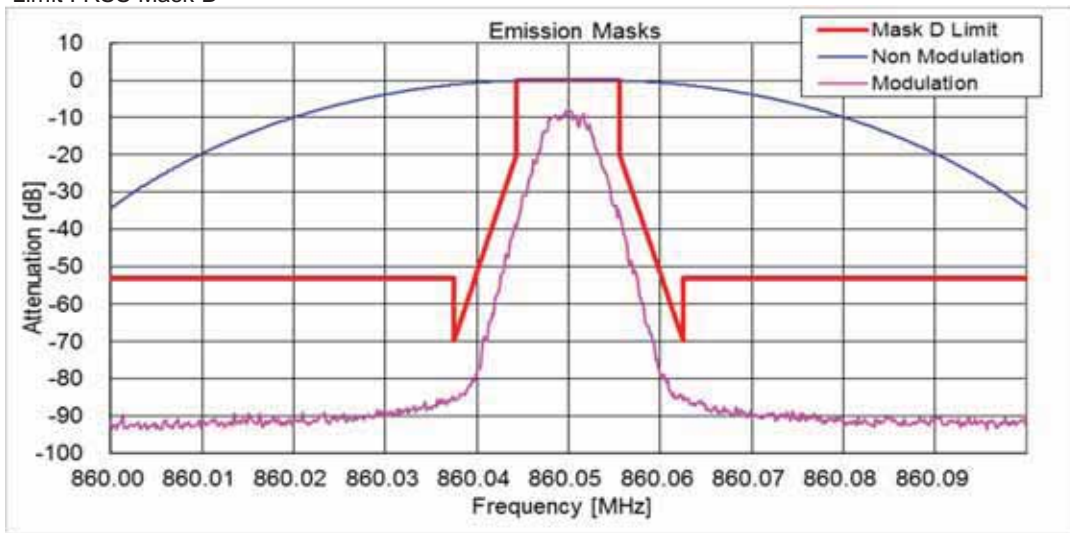

State : Low Power / Authorized Bandwidth 6 kHz/ 4K00F1E / F1D / F7W / 806.05 MHz(Band 3)
Limit : FCC Mask H

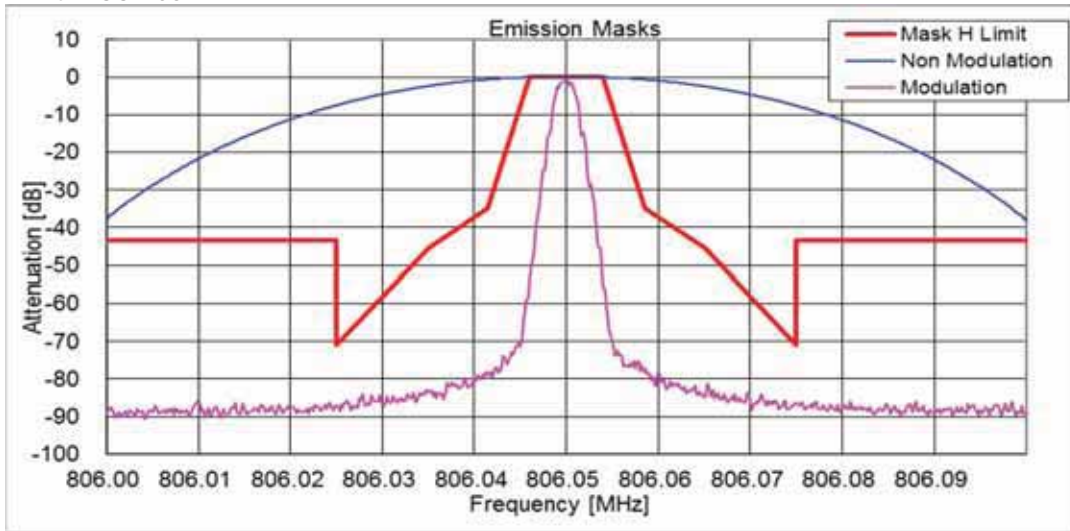

State : Low Power / Authorized Bandwidth 6 kHz/ 4K00F1E / F1D / F7W / 823.95 MHz(Band 3)
Limit : FCC Mask G

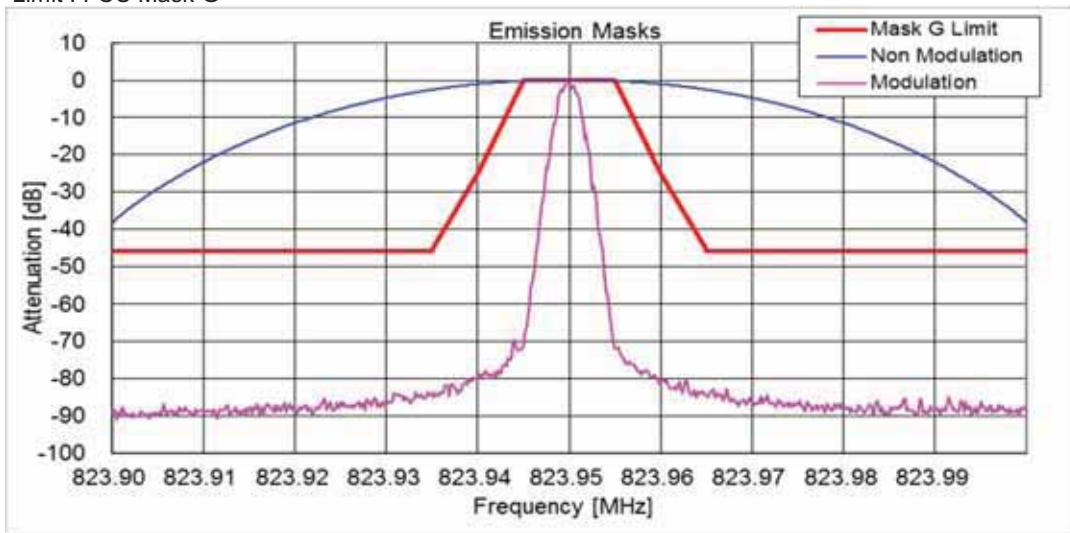

State : Low Power / Authorized Bandwidth 6 kHz/ 4K00F1E / F1D / F7W / 806.05 MHz(Band 3)
Limit : RSS Mask E

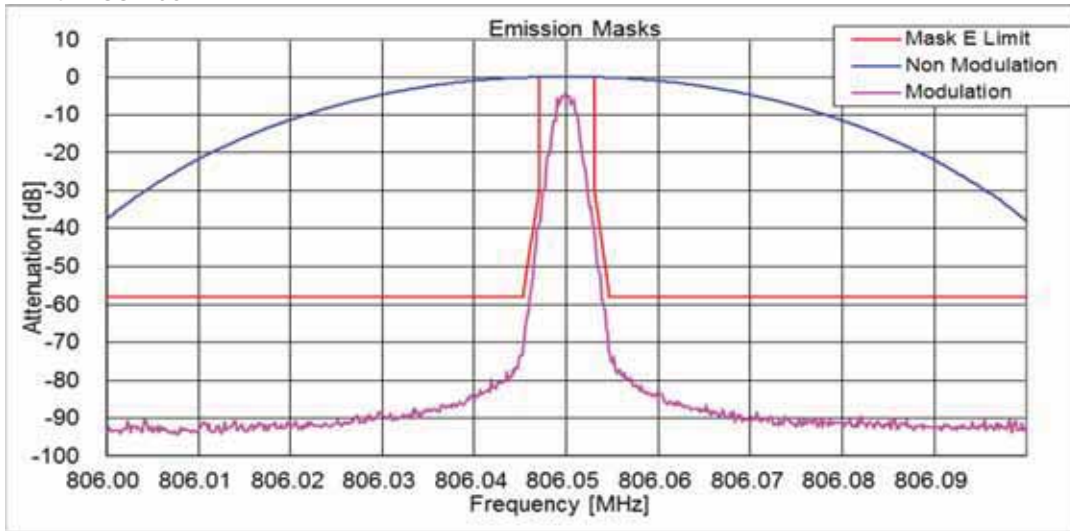

State : Low Power / Authorized Bandwidth 6 kHz/ 4K00F1E / F1D / F7W / 851.05 MHz(Band 4)
Limit : FCC Mask H

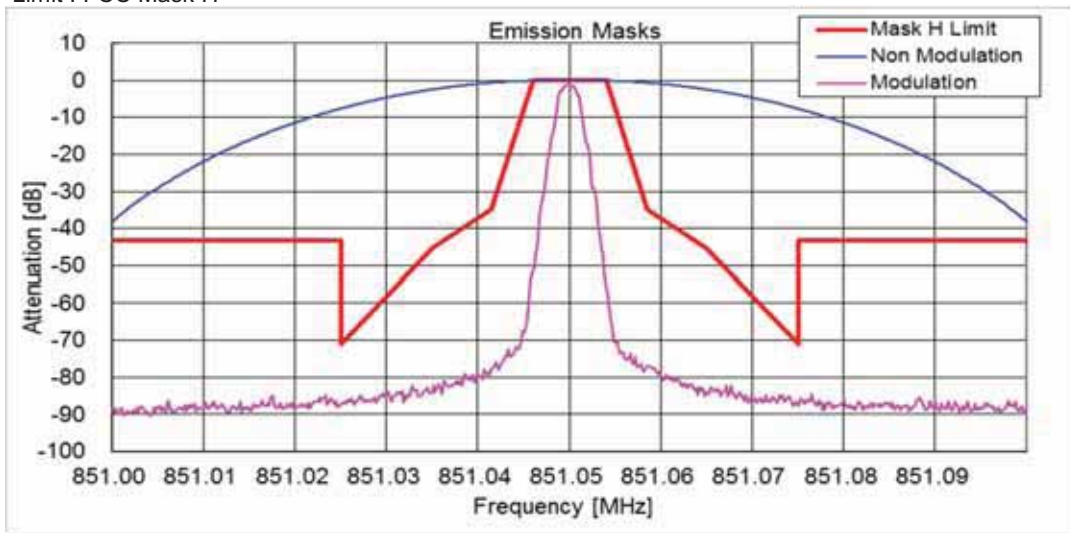

State : Low Power / Authorized Bandwidth 6 kHz/ 4K00F1E / F1D / F7W / 868.95 MHz(Band 4)
Limit : FCC Mask G

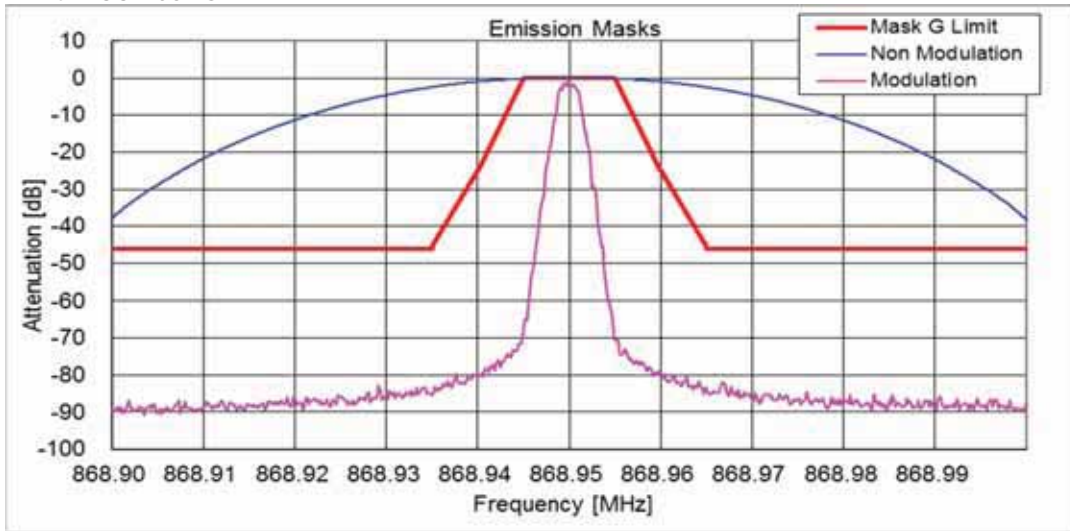

State : Low Power / Authorized Bandwidth 6 kHz/ 4K00F1E / F1D / F7W / 851.05 MHz(Band 4)
Limit : RSS Mask E

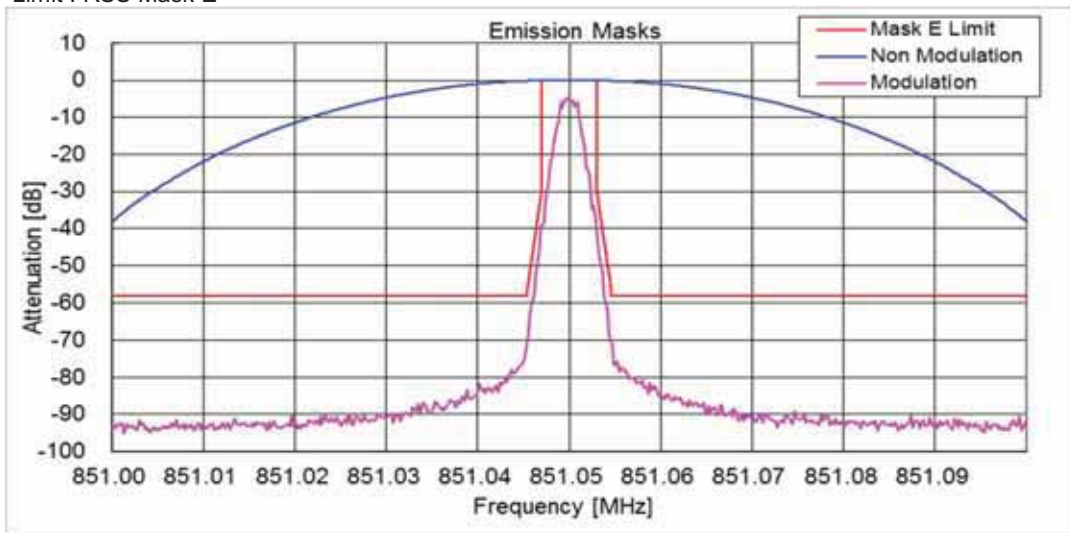

State : Low Power / Authorized Bandwidth 6 kHz/ 4K00F2D / 806.05 MHz(Band 3)
Limit : FCC Mask H

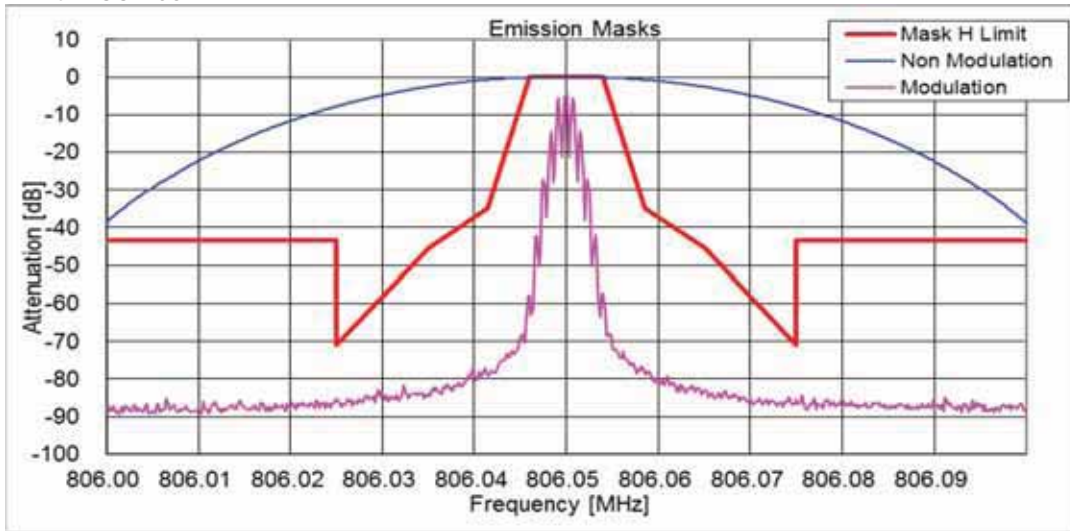

State : Low Power / Authorized Bandwidth 6 kHz/ 4K00F2D / 823.95 MHz(Band 3)
Limit : FCC Mask G

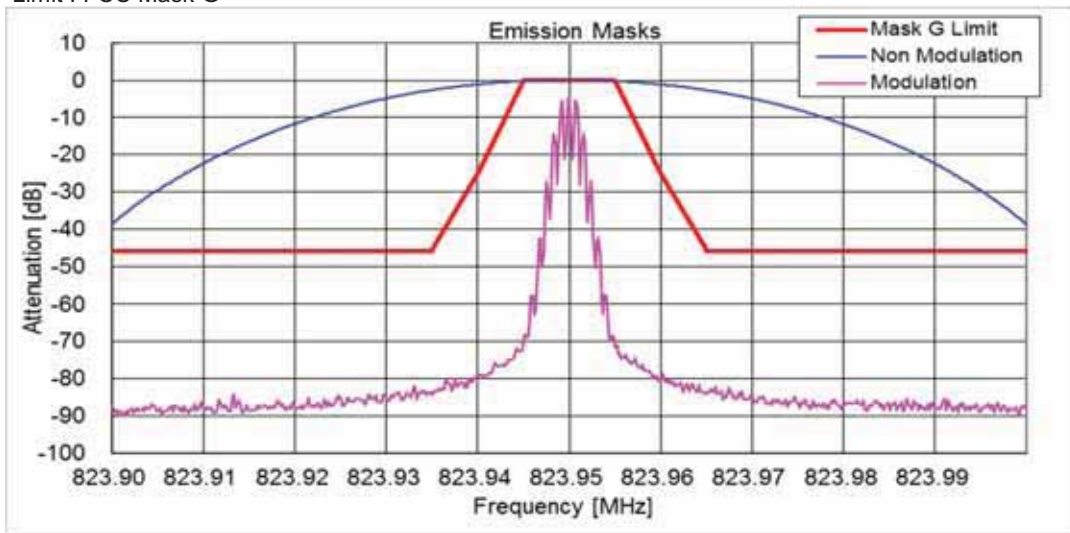

State : Low Power / Authorized Bandwidth 6 kHz/ 4K00F2D / 806.05 MHz(Band 3)
Limit : RSS Mask E

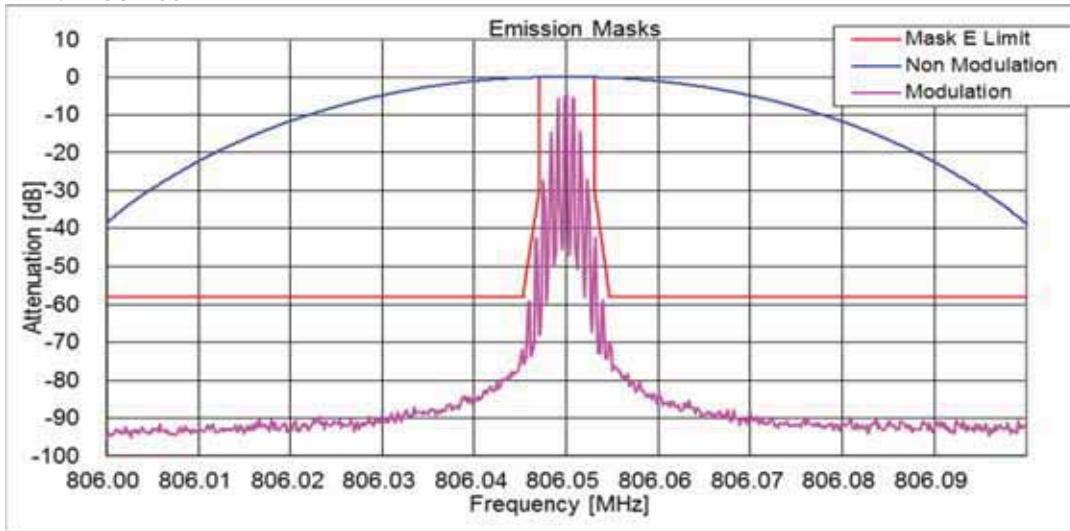

State : Low Power / Authorized Bandwidth 6 kHz/ 4K00F2D / 851.05 MHz(Band 4)
Limit : FCC Mask H

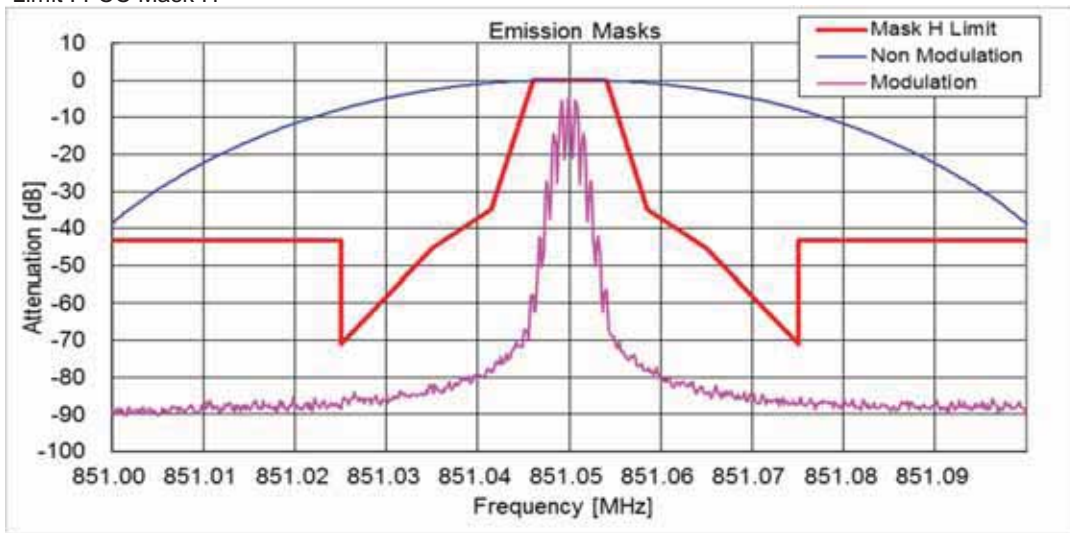

State : Low Power / Authorized Bandwidth 6 kHz/ 4K00F2D / 860.05 MHz(Band 4)
Limit : FCC Mask G

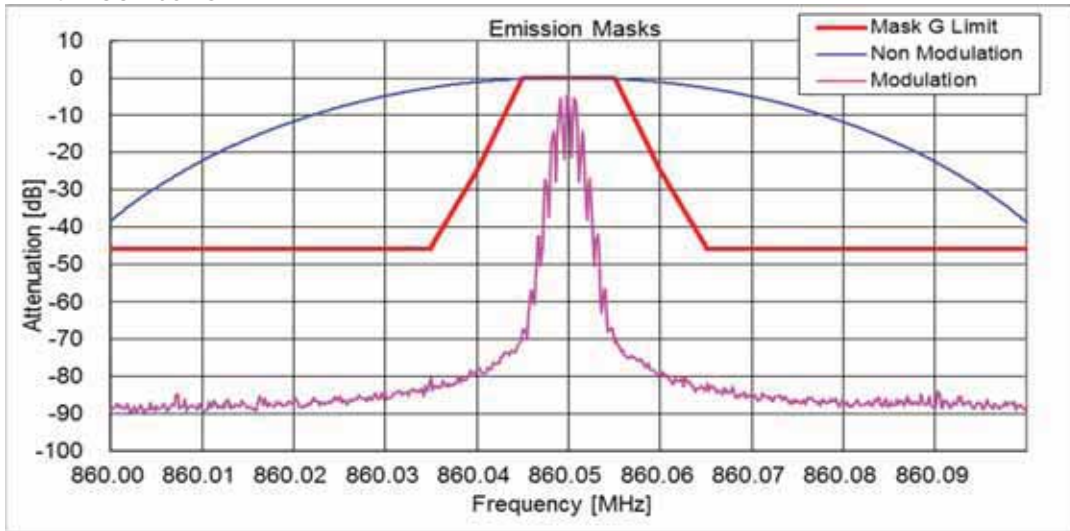

State : Low Power / Authorized Bandwidth 6 kHz/ 4K00F2D / 860.05 MHz(Band 4)
Limit : RSS Mask E

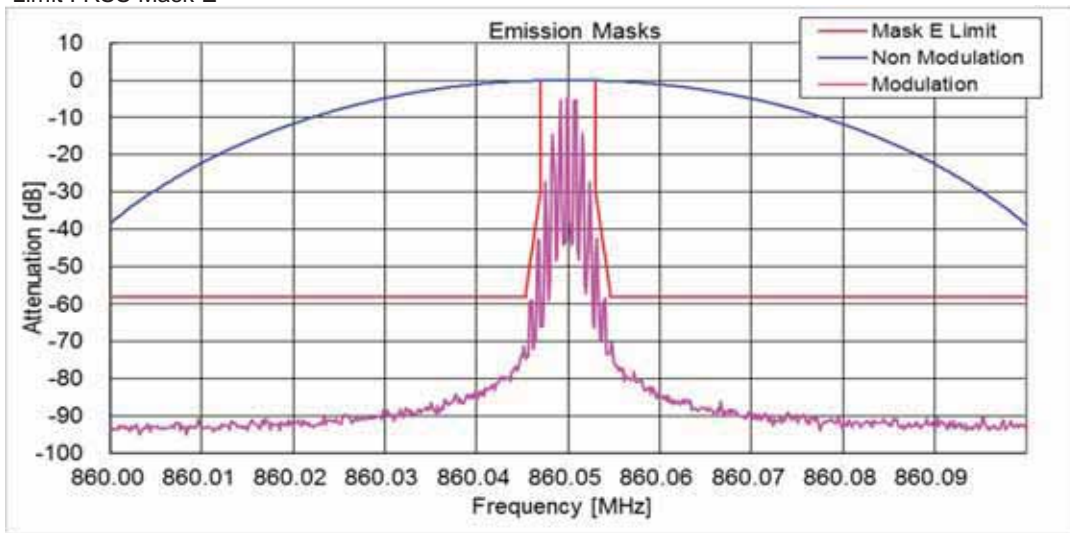

10.5 Audio Frequency Response / Audio Low Pass Filter (Voice Input)

REGULATIONS	: FCC Part 2 Section 1047 (a)
TEST METHOD/GUIDE	: ANSI/TIA-603-D Section 2.2.6.2.2, 3.2.6.2

Test Procedure

- 1 The EUT and test equipment were set up as shown on the following page.
- 2 Adjust the Modulation Analyzer for the following setting:
 - a) High-pass filter : 50 Hz
 - b) Low-pass filter : 15 kHz
 - c) Detector : positive peak
 - d) Function : FM
- 3 The audio signal input was adjusted to obtain 20 % modulation at 1 kHz, and this point was taken as the 0 dB reference level.
- 4 With input levels held constant and below limiting at all frequencies, the audio signal generator was varied from 300 Hz to 5 kHz.
- 5 The response in dB relative to 1 kHz was then measured, using the Modulation Analyzer.

Measuring Equipments

No.	Equipment	Manufacture	Model No.	Serial No.	Cal Date	Cal Exp.
1	Attenuator (20dB)	Aeroflex/Wenshel	66-20-34	BY4357	Jun. 01, 15	Jun. 30, 16
2	Attenuator (30dB)	Weinschel	WA-29-30-34	8923	Jun. 01, 15	Jun. 30, 16
3	Modulation Analyzer	Hewlett Packard	8901B	2806A01669	Oct. 13, 14	Oct. 31, 15
4	Audio Generator	Anritsu	MG443B	M70150	Jun. 18, 15	Jun. 30, 16
5	Audio Analyzer	Hewlett Packard	8903B	2818A04372	Jul. 19, 14	Jul. 31, 15
6	DC Power Supply	Daiichi denpa kogyo	GZV4000	90290931	None	None
7	Digital Multi Meter	FLUKE	8846A	9642018	Jun. 04, 14	Jun. 30, 15

Measuring Cables

No.	Cable	Manufacture	Model No.	Serial No.	Cal Date	Cal Exp.
W2	Balance Cable	Nicoon	3D-2V	KSR00092	Jan. 23, 15	Jan. 31, 16
W4	Coaxial Cable	Pacific custom	RG-58 C/U	KSR00096	Jan. 23, 15	Jan. 31, 16
W3	Coaxial Cable	Pacific custom	RG-58 C/U	AM90C04	Jun. 09, 15	Jun. 30, 16
W1	Coaxial Cable	Suhner	SUCOFLEX104	F0000017	Jan. 23, 15	Jan. 31, 16

Measuring Equipment Configuration

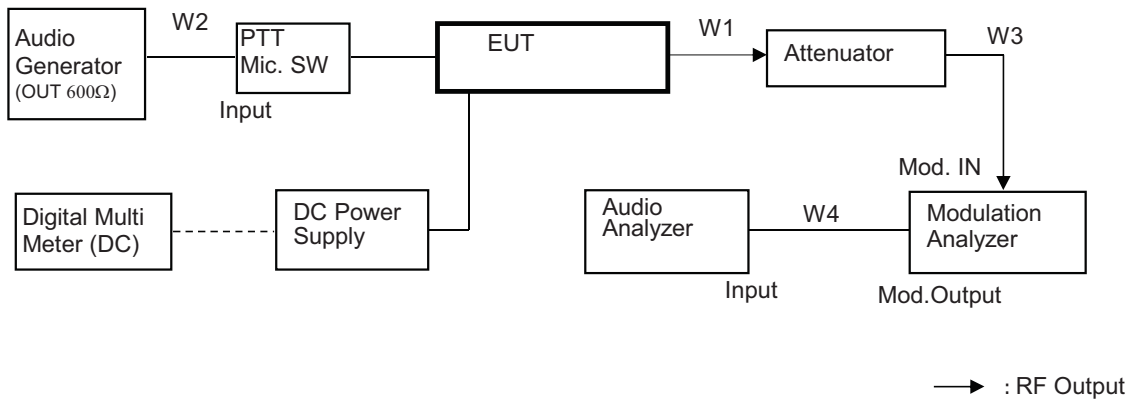

Test Results

Test date	Jun 30, 2015	
Location	Kashima No.1 Test Site	
temperature	25	[degree C]
Humidity Variation	50	[%]
Atmospheric Pressure	101	[kPa]
Test Engineer	Koichi Wagatsuma	

Test was carried out for all the frequency band of section 10.1
 State the worst case (below).

State : High Power / Authorized Bandwidth 20 kHz / 16K0F3E / 769.05 MHz(Band 1)

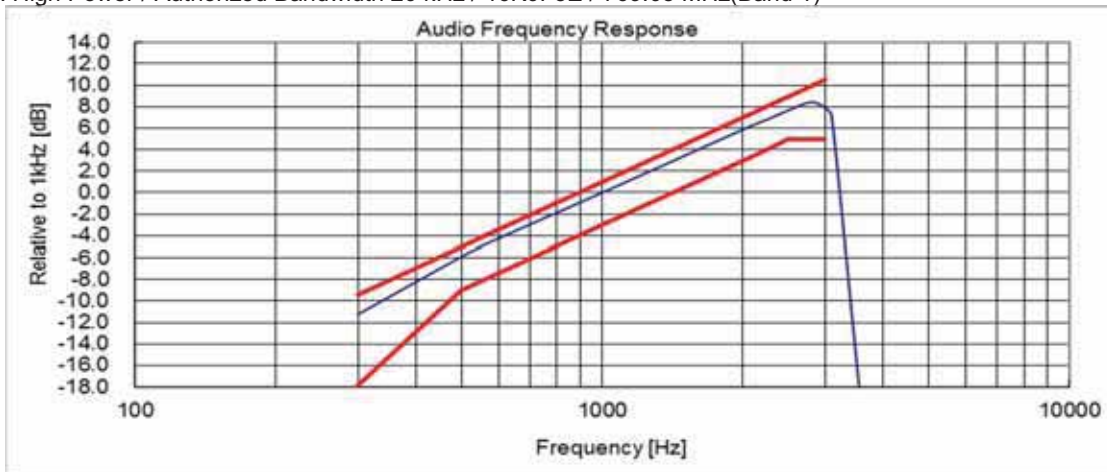

Note:

Audio Filter of the above result is substituted with the same structure as Audio Frequency Response.
 On the transmission condition below 3kHz,
 Transceiver shows pre-emphasis condition of transmission function.
 On the transmission condition above 3kHz, Transceiver shows Audio Low Pass Filter.

State : High Power / Authorized Bandwidth 20 kHz / 16K0F3E / 804.95 MHz(Band 2)

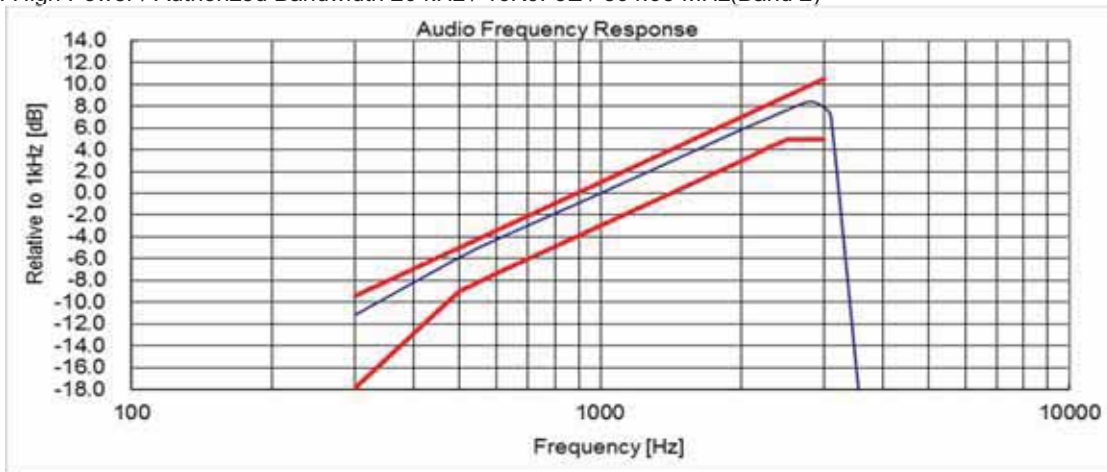

Note:

Audio Filter of the above result is substituted with the same structure as Audio Frequency Response.
On the transmission condition below 3kHz,
Transceiver shows pre-emphasis condition of transmission function.
On the transmission condition above 3kHz, Transceiver shows Audio Low Pass Filter.

State : High Power / Authorized Bandwidth 20 kHz / 11K0F3E / 823.95 MHz(Band 3)

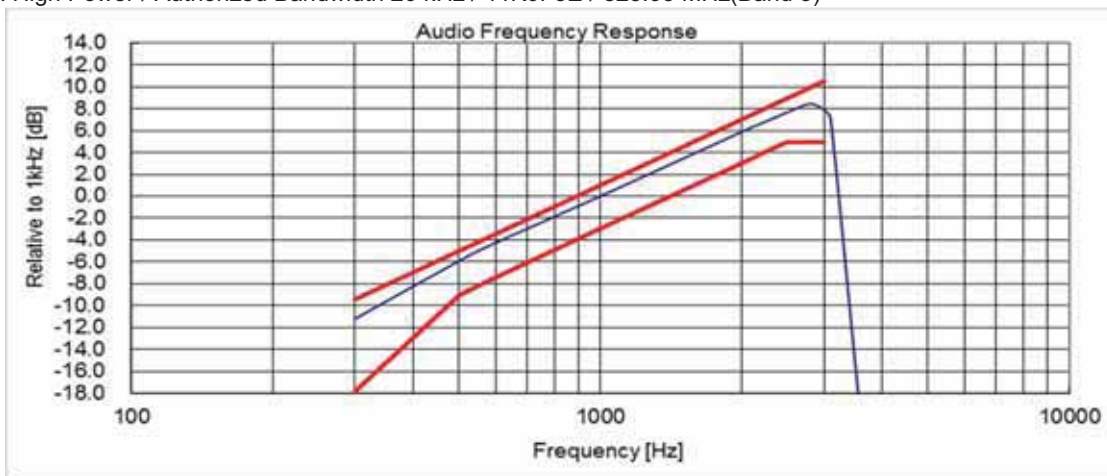

Note:

Audio Filter of the above result is substituted with the same structure as Audio Frequency Response.
On the transmission condition below 3kHz,
Transceiver shows pre-emphasis condition of transmission function.
On the transmission condition above 3kHz, Transceiver shows Audio Low Pass Filter.

State : High Power / Authorized Bandwidth 20 kHz / 11K0F3E / 851.05 MHz(Band 4)

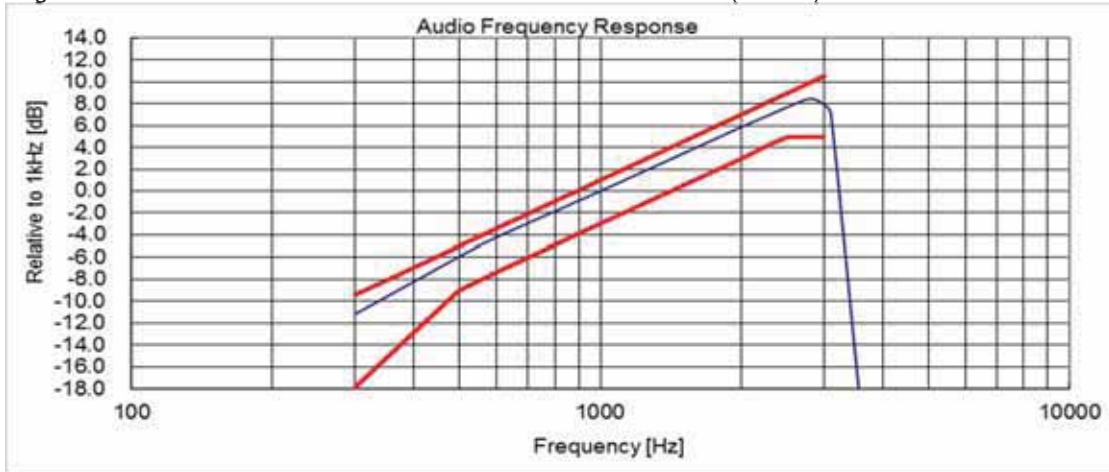

Note:

Audio Filter of the above result is substituted with the same structure as Audio Frequency Response.

On the transmission condition below 3kHz,

Transceiver shows pre-emphasis condition of transmission function.

On the transmission condition above 3kHz, Transceiver shows Audio Low Pass Filter.

State : High Power / Authorized Bandwidth 20 kHz / 14K0F3E / 774.95 MHz(Band 1)

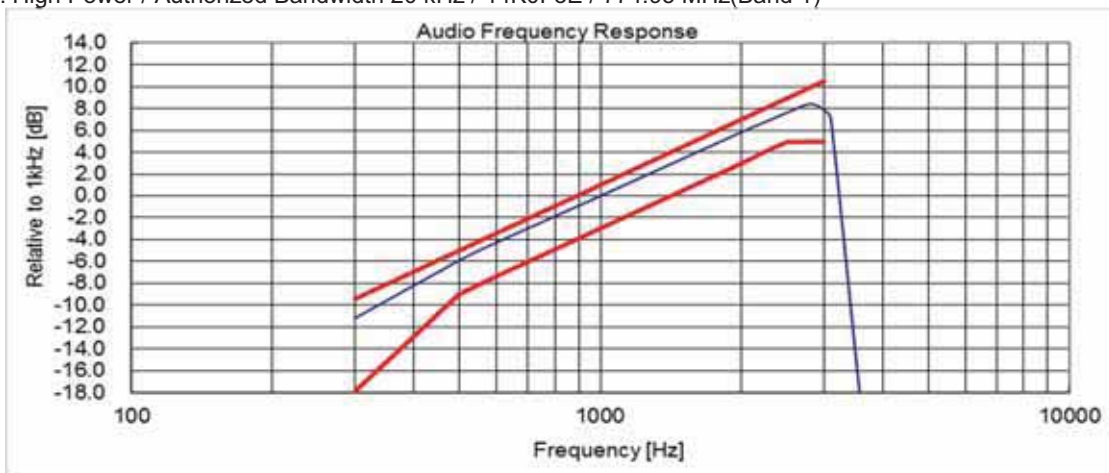

Note:

Audio Filter of the above result is substituted with the same structure as Audio Frequency Response.

On the transmission condition below 3kHz,

Transceiver shows pre-emphasis condition of transmission function.

On the transmission condition above 3kHz, Transceiver shows Audio Low Pass Filter.

State : High Power / Authorized Bandwidth 20 kHz / 14K0F3E / 804.95 MHz(Band 2)

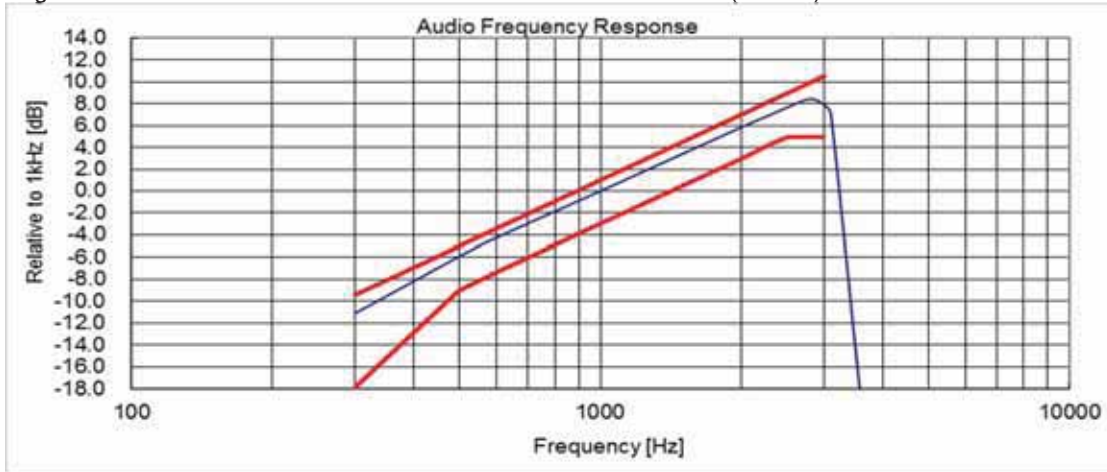

Note:

Audio Filter of the above result is substituted with the same structure as Audio Frequency Response.

On the transmission condition below 3kHz,

Transceiver shows pre-emphasis condition of transmission function.

On the transmission condition above 3kHz, Transceiver shows Audio Low Pass Filter.

State : High Power / Authorized Bandwidth 20 kHz / 14K0F3E / 823.95 MHz(Band 3)

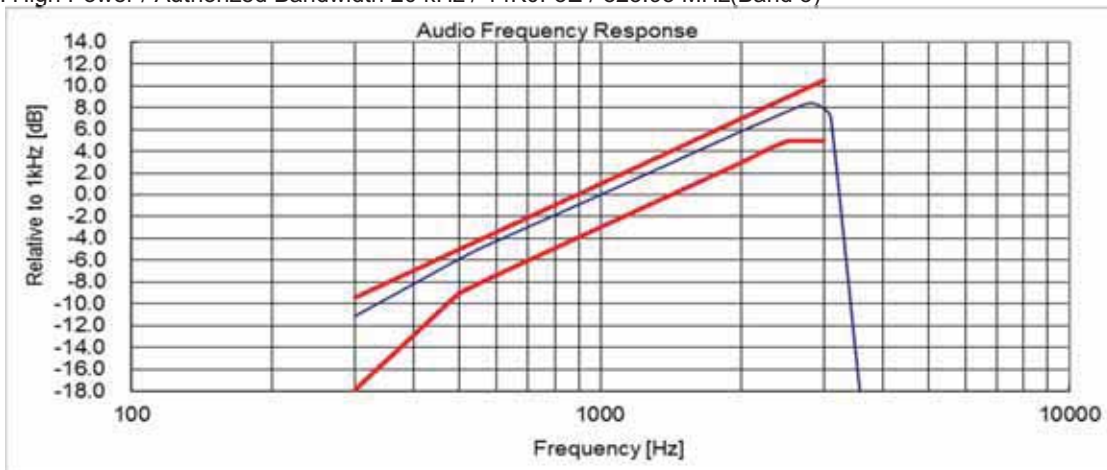

Note:

Audio Filter of the above result is substituted with the same structure as Audio Frequency Response.

On the transmission condition below 3kHz,

Transceiver shows pre-emphasis condition of transmission function.

On the transmission condition above 3kHz, Transceiver shows Audio Low Pass Filter.

State : High Power / Authorized Bandwidth 20 kHz / 14K0F3E / 860.05 MHz(Band 4)

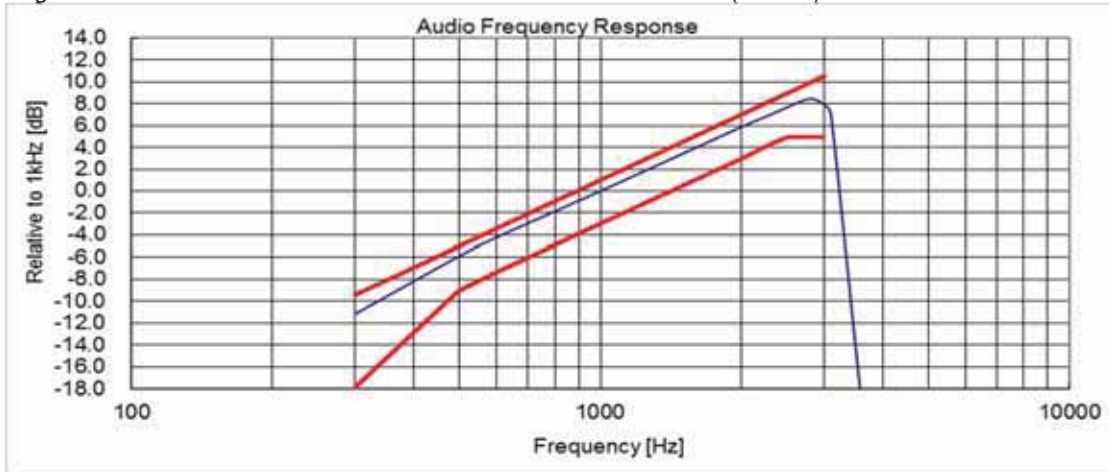

Note:

Audio Filter of the above result is substituted with the same structure as Audio Frequency Response.

On the transmission condition below 3kHz,

Transceiver shows pre-emphasis condition of transmission function.

On the transmission condition above 3kHz, Transceiver shows Audio Low Pass Filter.

State : High Power / Authorized Bandwidth 11.25 kHz / 11K0F3E / 769.05 MHz(Band 1)

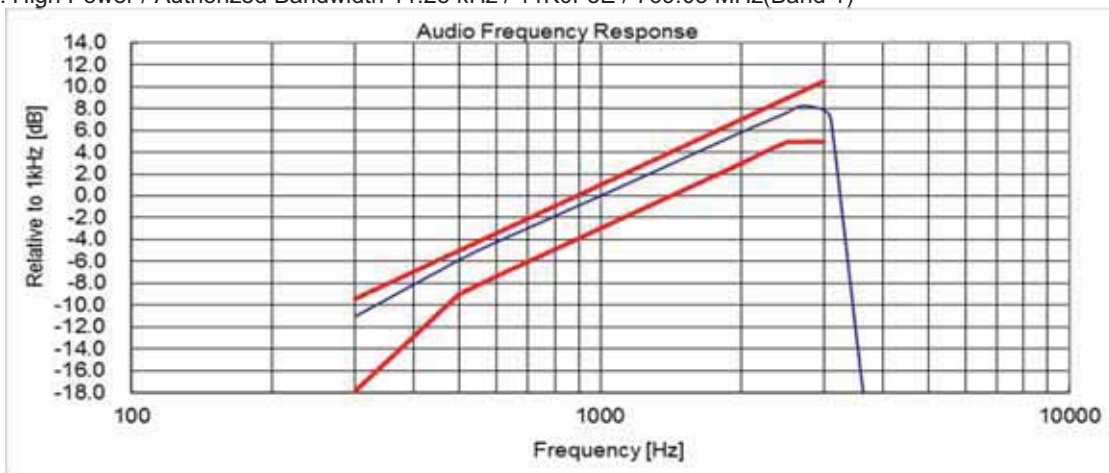

Note:

Audio Filter of the above result is substituted with the same structure as Audio Frequency Response.

On the transmission condition below 3kHz,

Transceiver shows pre-emphasis condition of transmission function.

On the transmission condition above 3kHz, Transceiver shows Audio Low Pass Filter.

State : High Power / Authorized Bandwidth 11.25 kHz / 11K0F3E / 799.05 MHz(Band 2)

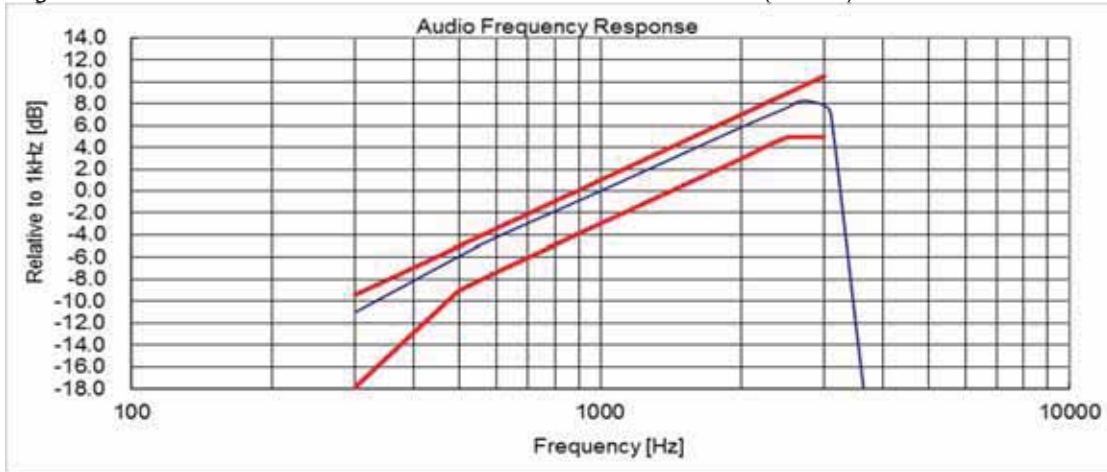

Note:

Audio Filter of the above result is substituted with the same structure as Audio Frequency Response.

On the transmission condition below 3kHz,

Transceiver shows pre-emphasis condition of transmission function.

On the transmission condition above 3kHz, Transceiver shows Audio Low Pass Filter.

State : High Power / Authorized Bandwidth 11.25 kHz / 11K0F3E / 823.95 MHz(Band 3)

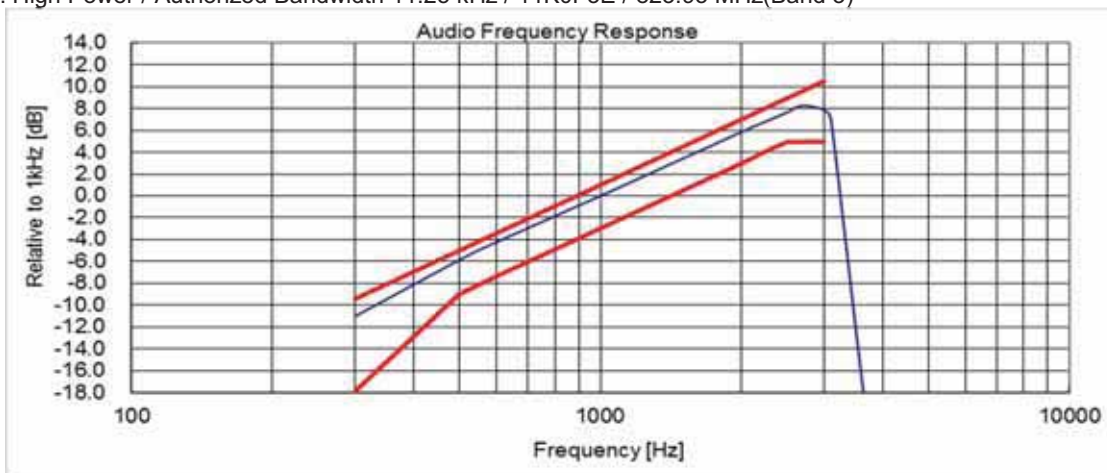

Note:

Audio Filter of the above result is substituted with the same structure as Audio Frequency Response.

On the transmission condition below 3kHz,

Transceiver shows pre-emphasis condition of transmission function.

On the transmission condition above 3kHz, Transceiver shows Audio Low Pass Filter.

State : High Power / Authorized Bandwidth 11.25 kHz / 11K0F3E / 868.95 MHz(Band 4)

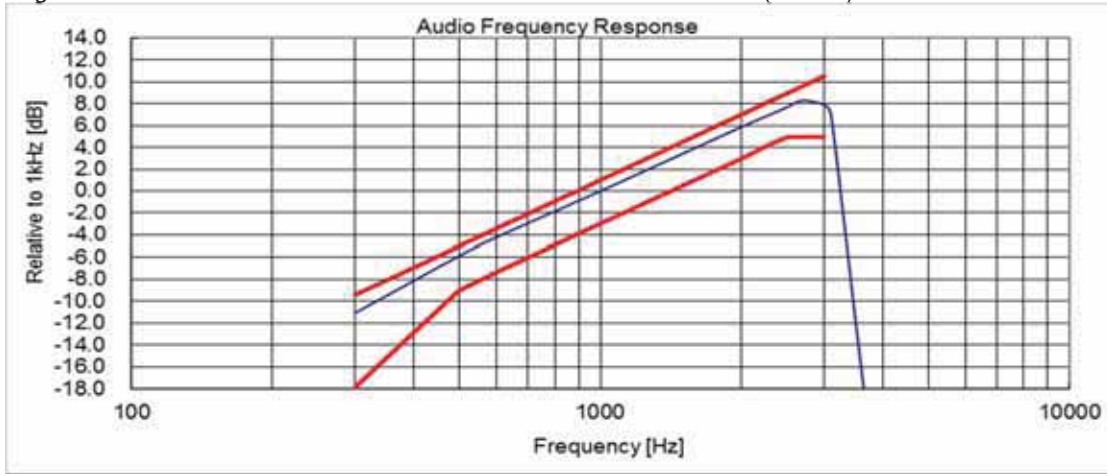

Note:

Audio Filter of the above result is substituted with the same structure as Audio Frequency Response.

On the transmission condition below 3kHz,

Transceiver shows pre-emphasis condition of transmission function.

On the transmission condition above 3kHz, Transceiver shows Audio Low Pass Filter.

10.6 Modulation Limiting

REGULATIONS	: FCC Part 2 Section 1047 (b)
TEST METHOD/GUIDE	: ANSI/TIA-603-D Section 2.2.3.2, 1.3.4.4

Test Procedure

- 1 The EUT and test equipment were set up as shown on the following page.
- 2 Adjust the Modulation Analyzer for the following setting:
 - a) High-pass filter : off
 - b) Low-pass filter : 15 kHz
 - c) Detector : positive peak
 - d) Function : FM
- 3 Apply a 1kHz modulation signal to the transmitter from the audio generator, and adjust the level to obtain 60% of full rated system deviation.
- 4 Measure the modulation frequency that was showed on the Modulation Analyzer when the output levels of the Audio Generator were changed from -20 dB to +50 dB by 10 dB.
- 5 Set the output frequencies of the Audio Generator 300 Hz and 3 kHz, and repeat test procedure 4.
- 6 Set the Detector of the Modulation Analyzer Negative Peak.
- 7 Repeat test procedure 4 and 5.

Measuring Equipments

No.	Equipment	Manufacture	Model No.	Serial No.	Cal Date	Cal Exp.
1	Attenuator (20dB)	Aeroflex/Wenshel	66-20-34	BY4357	Jun. 01, 15	Jun. 30, 16
2	Attenuator (30dB)	Weinschel	WA-29-30-34	8923	Jun. 01, 15	Jun. 30, 16
3	Modulation Analyzer	Hewlett Packard	8901B	2806A01669	Oct. 13, 14	Oct. 31, 15
4	Audio Generator	Anritsu	MG443B	M70150	Jun. 18, 15	Jun. 30, 16
5	DC Power Supply	Daiichi denpa kogyo	GZV4000	90290931	None	None
4	Digital Multi Meter	FLUKE	8846A	9642018	Jun. 04, 14	Jun. 30, 15

Measuring Cables

No.	Cable	Manufacture	Model No.	Serial No.	Cal Date	Cal Exp.
W2	Balance Cable	Nicoon	3D-2V	KSR00092	Jan. 23, 15	Jan. 31, 16
W3	Coaxial Cable	Pacific custom	RG-58 C/U	AM90C04	Jun. 09, 15	Jun. 30, 16
W1	Coaxial Cable	Suhner	SUCOFLEX104	F0000017	Jan. 23, 15	Jan. 31, 16

Measuring Equipment Configuration

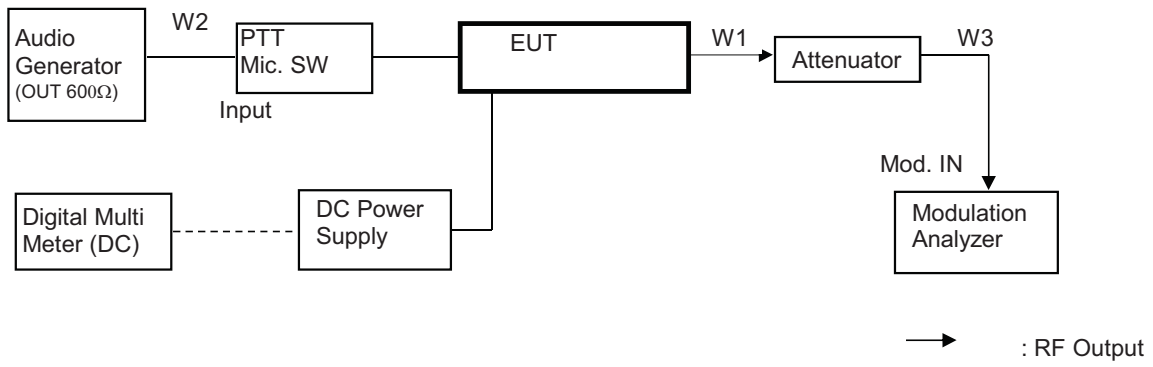

Test Results

Test date	Jun 30, 2015	
Location	Kashima No.1 Test Site	
temperature	26	[degree C]
Humidity Variation	50	[%]
Atmospheric Pressure	101	[kPa]
Test Engineer	Koichi Wagatsuma	

Test was carried out for all the frequency band of section 10.1
 State the worst case (below).

State : High Power / Authorized Bandwidth 20 kHz / 16K0F3E / 769.05 MHz(Band 1)

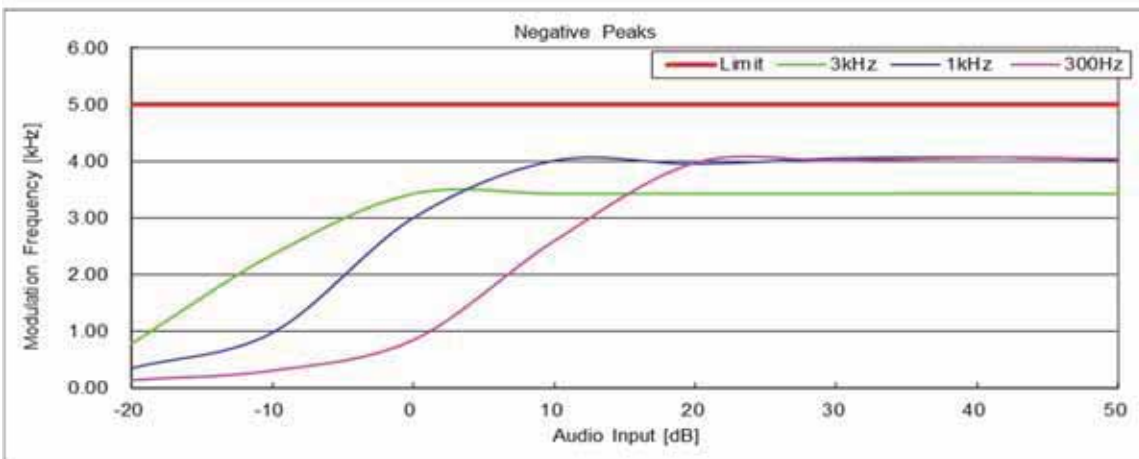
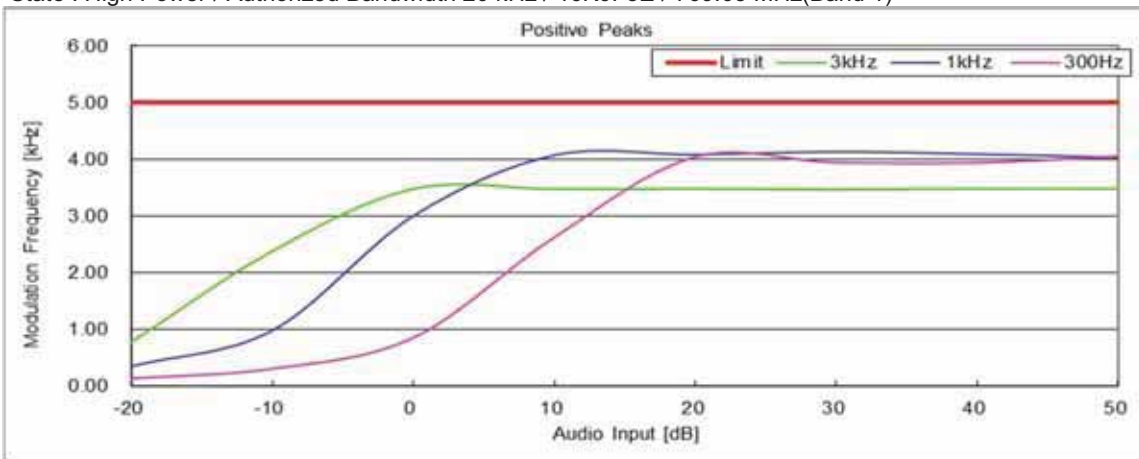

State : High Power / Authorized Bandwidth 20 kHz / 16K0F3E / 799.05 MHz(Band 2)

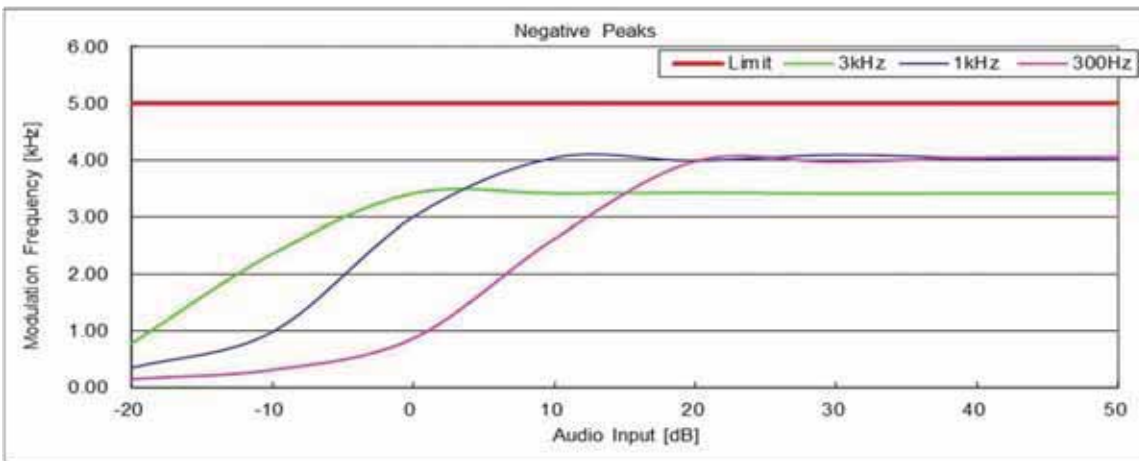
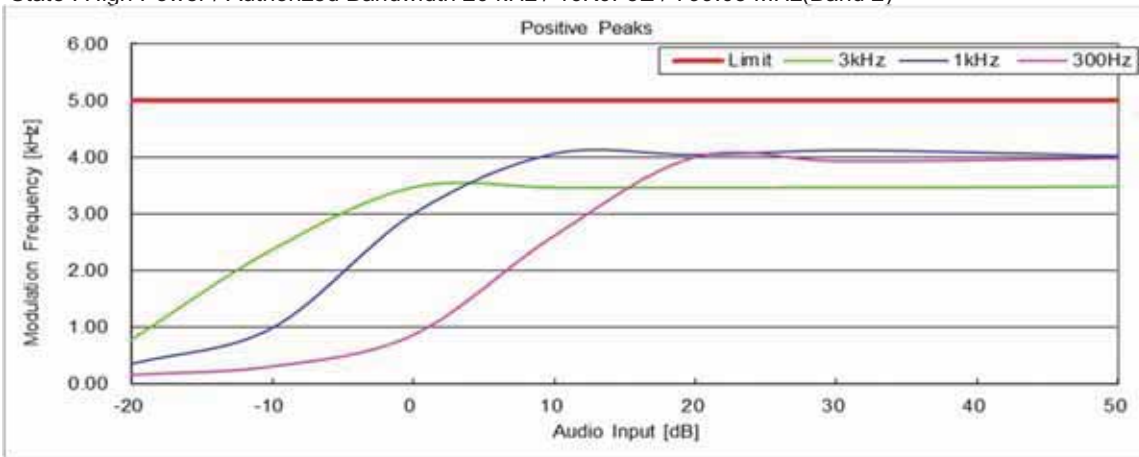

State : High Power / Authorized Bandwidth 20 kHz / 16K0F3E / 815.05 MHz(Band 3)

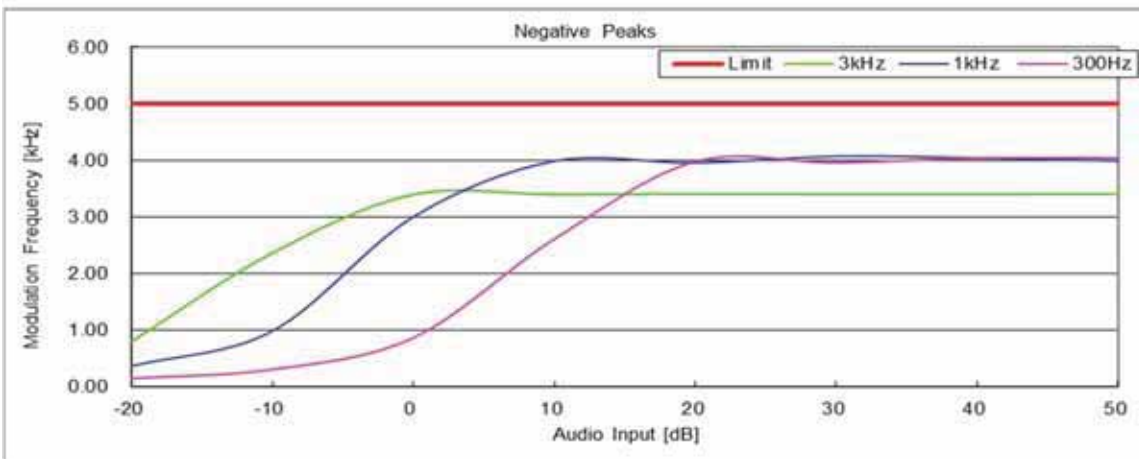
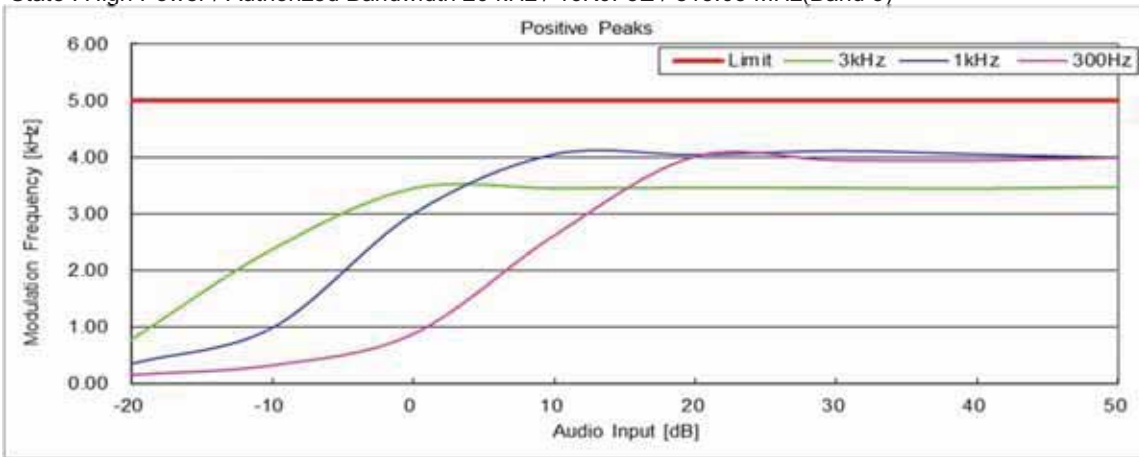

State : High Power / Authorized Bandwidth 20 kHz / 16K0F3E / 868.95 MHz(Band 4)

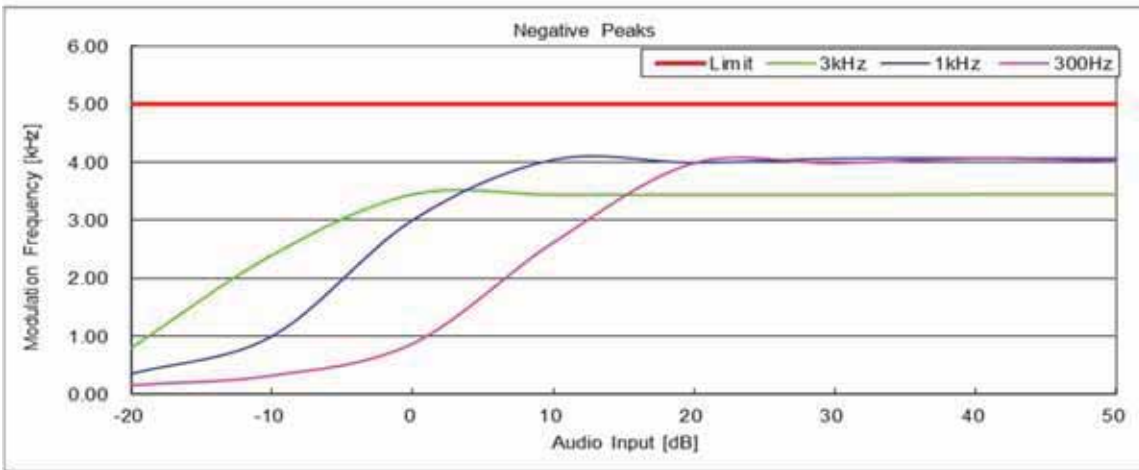
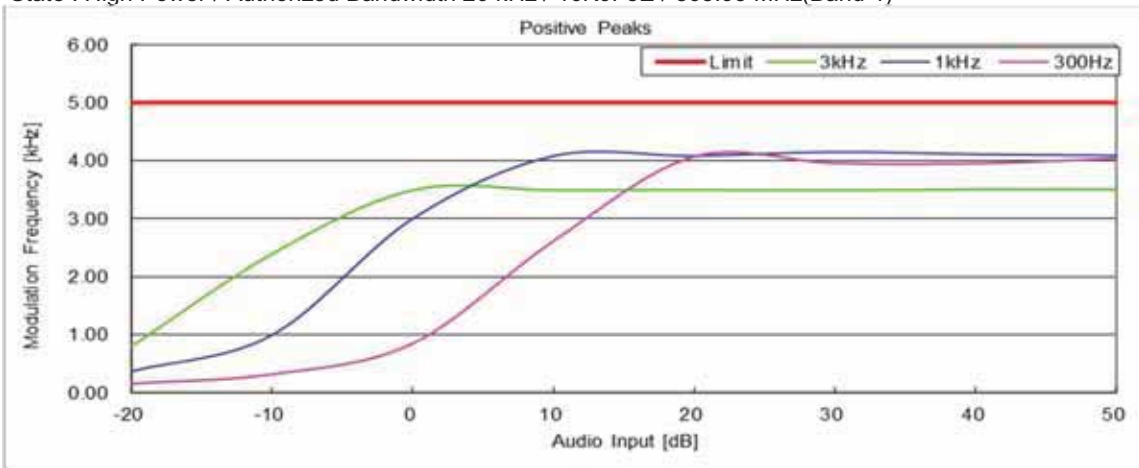

State : High Power / Authorized Bandwidth 20 kHz / 14K0F3E / 769.05 MHz(Band 1)

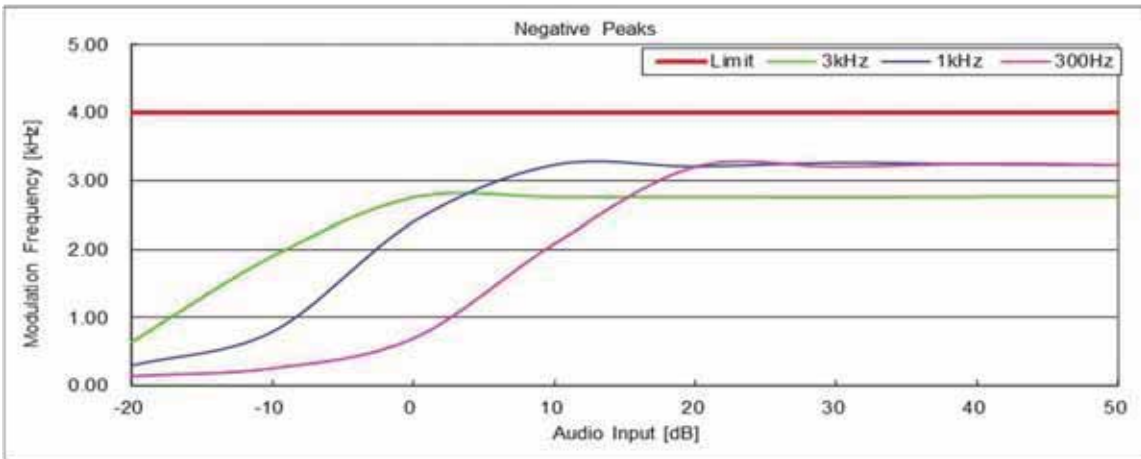
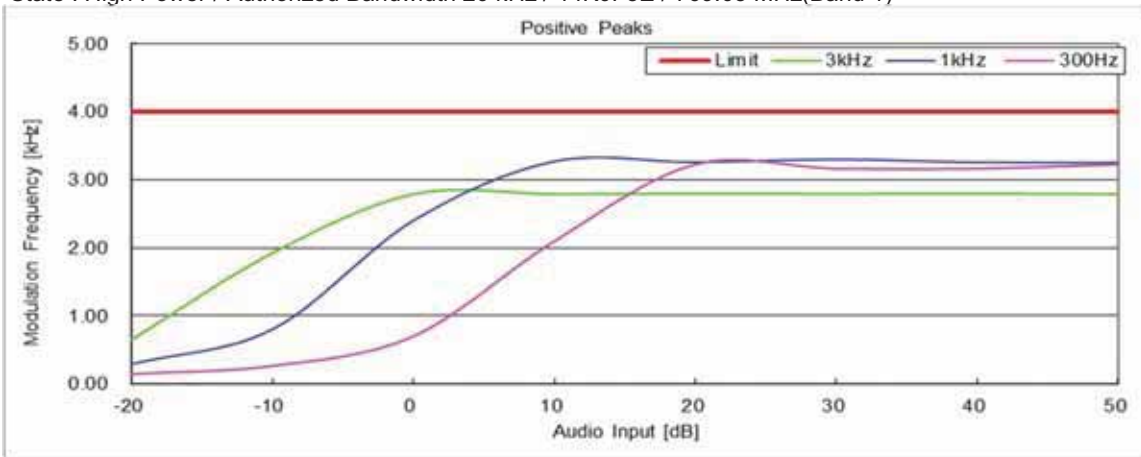

State : High Power / Authorized Bandwidth 20 kHz / 14K0F3E / 799.05 MHz(Band 2)

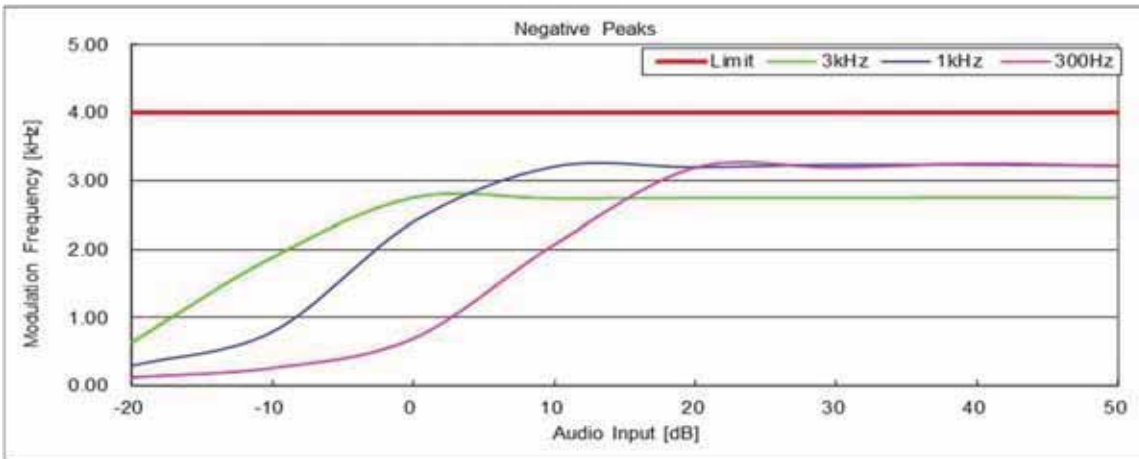
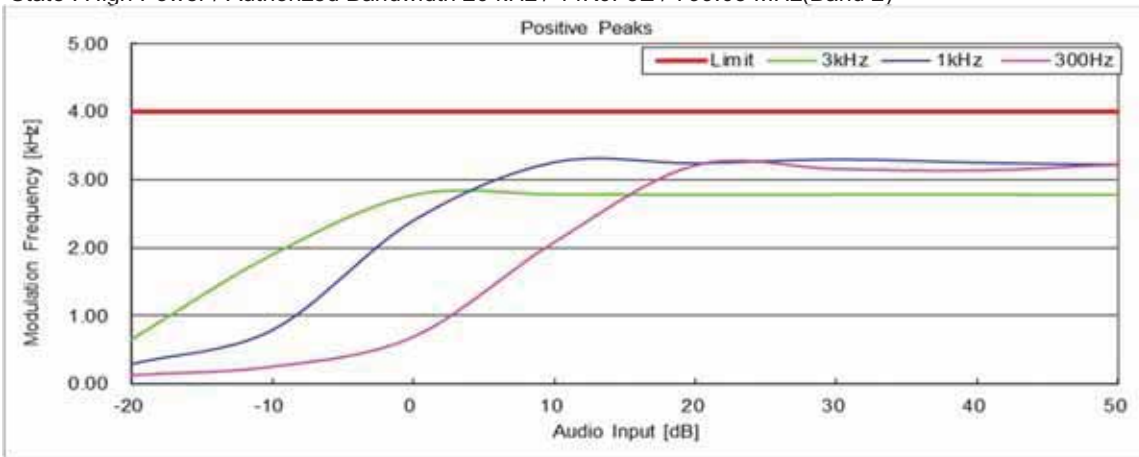

State : High Power / Authorized Bandwidth 20 kHz / 14K0F3E / 815.05 MHz(Band 3)

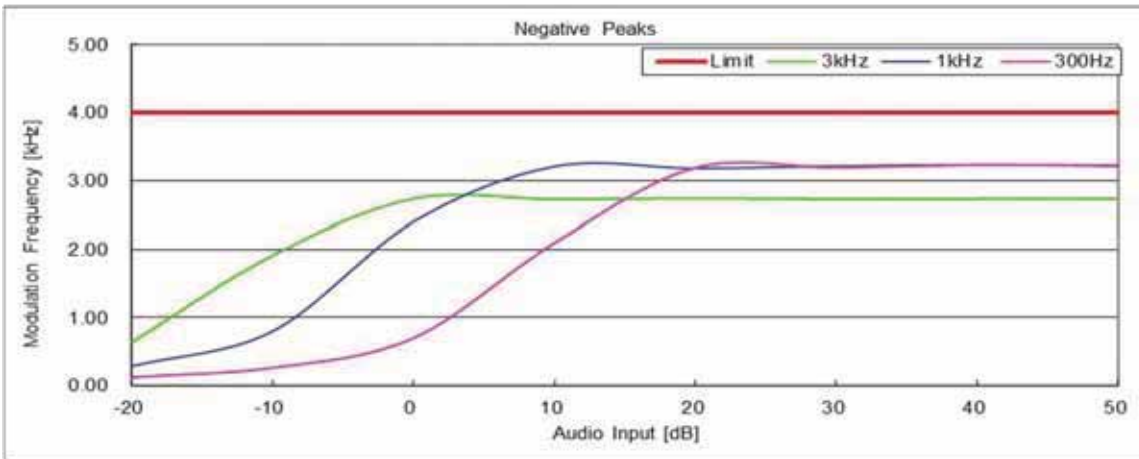
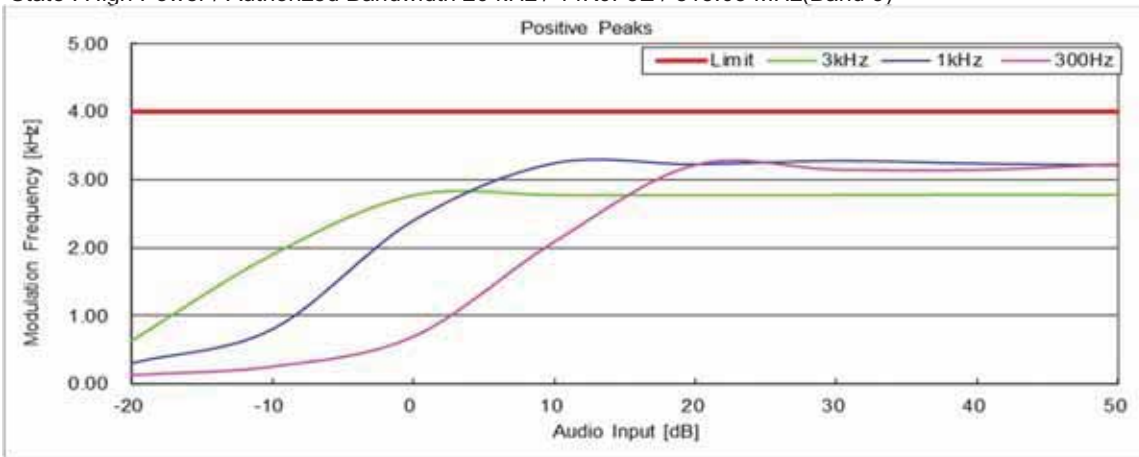

State : High Power / Authorized Bandwidth 20 kHz / 14K0F3E / 868.95 MHz(Band 4)

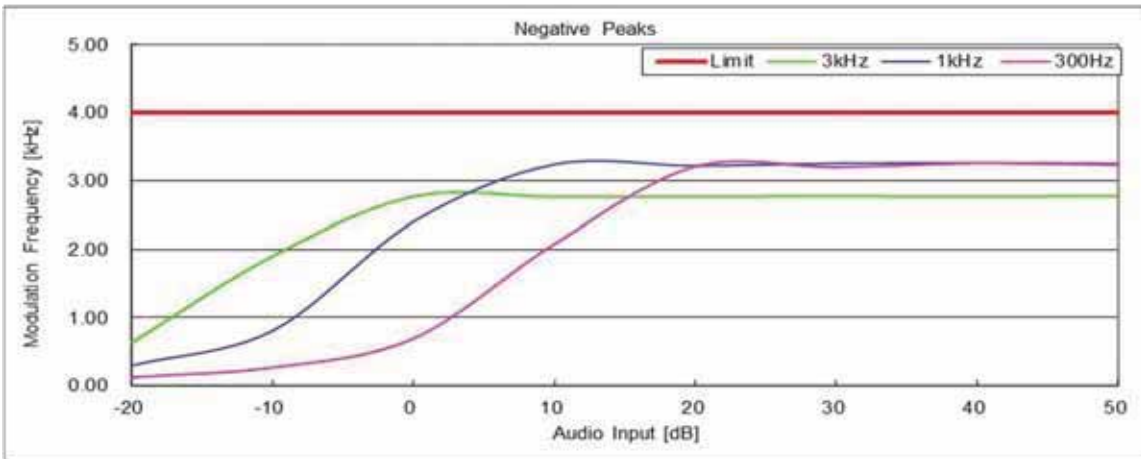
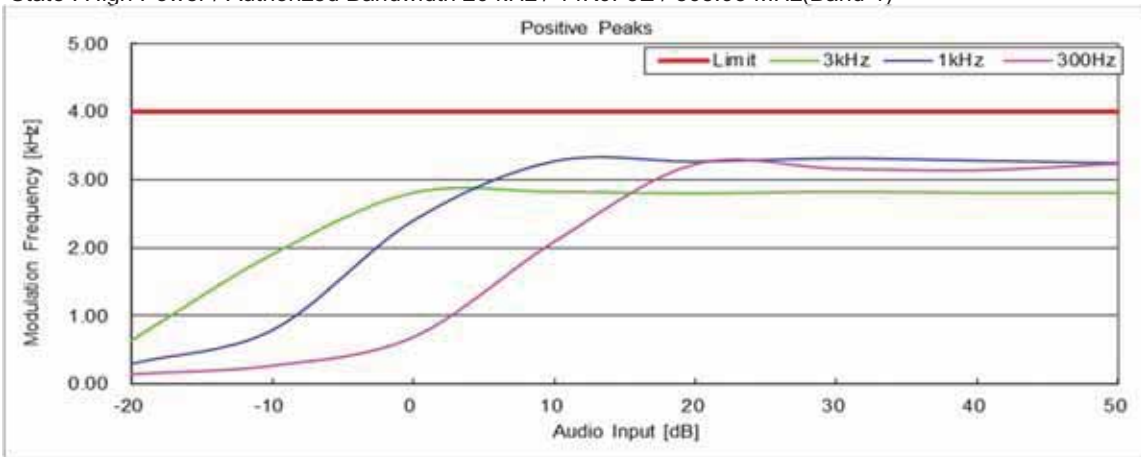

State : High Power / Authorized Bandwidth 11.25 kHz / 11K0F3E / 774.95 MHz(Band 1)

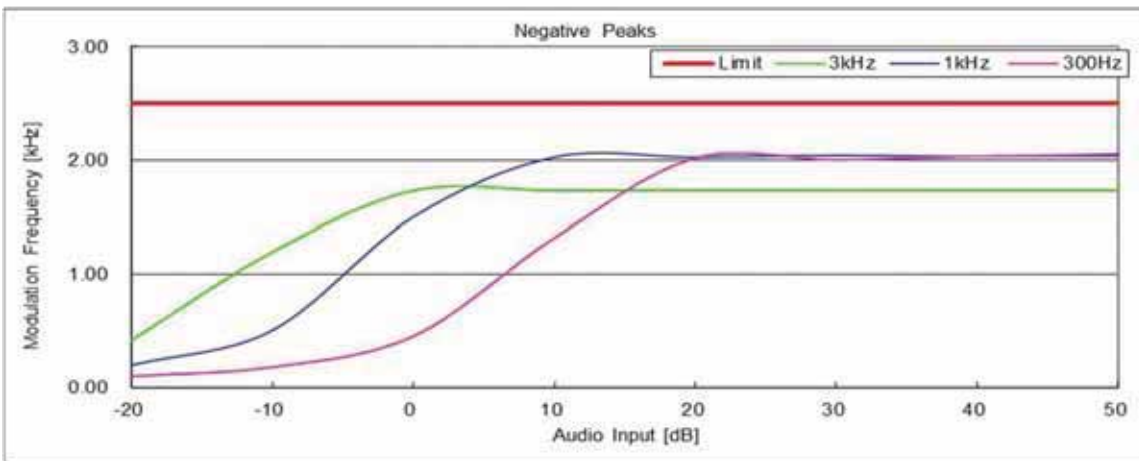
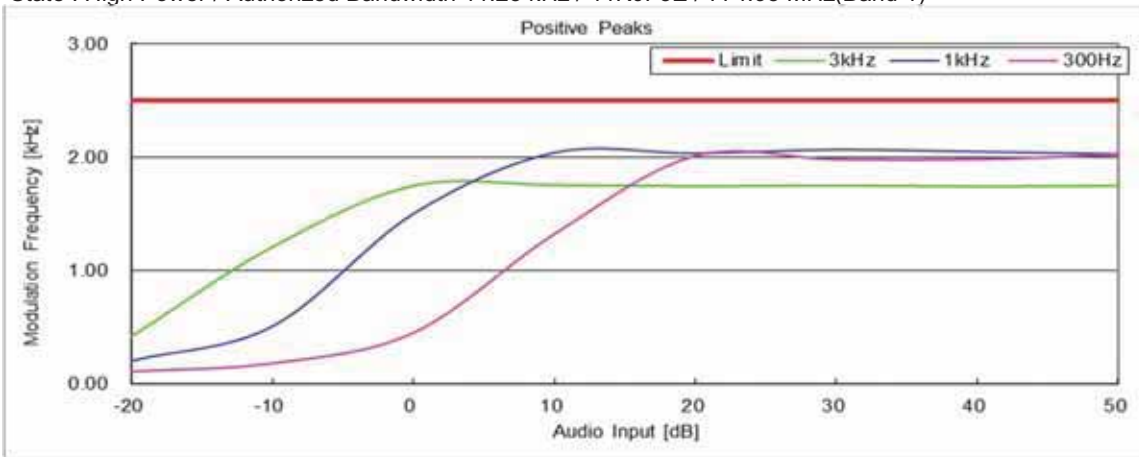

State : High Power / Authorized Bandwidth 11.25 kHz / 11K0F3E / 799.05 MHz(Band 2)

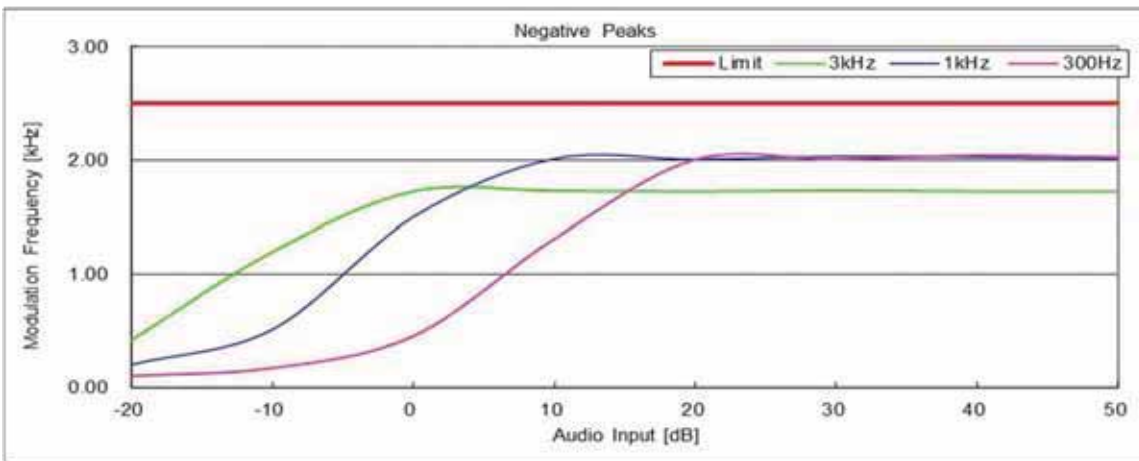
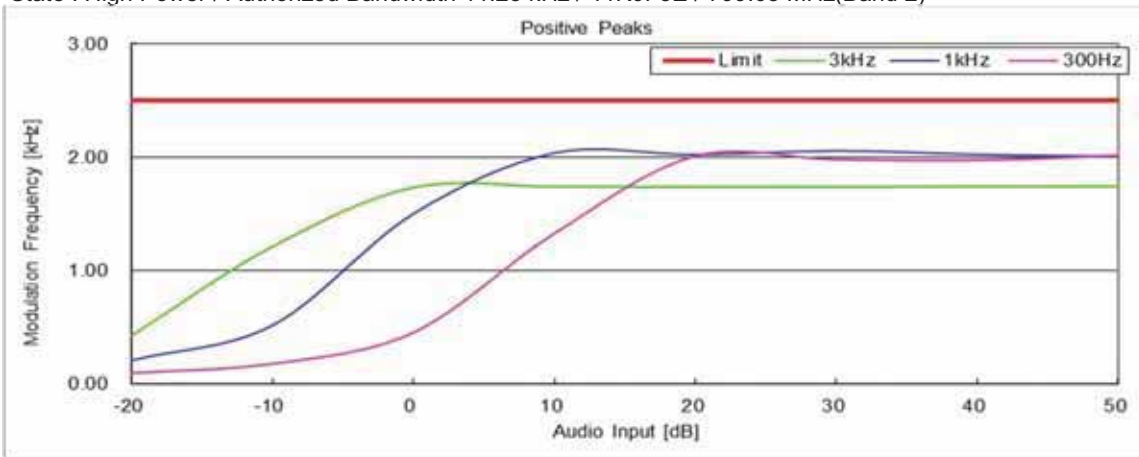

State : High Power / Authorized Bandwidth 11.25 kHz / 11K0F3E / 806.05 MHz(Band 3)

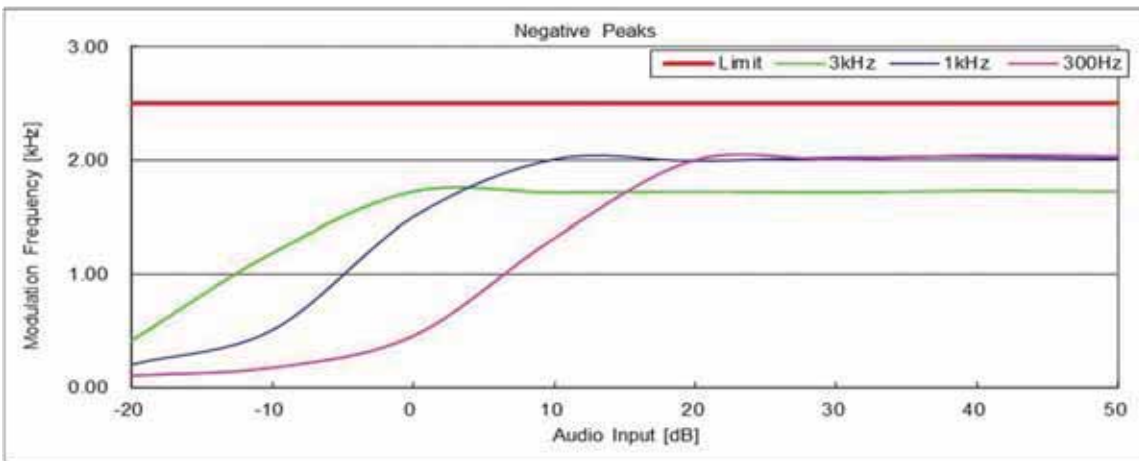
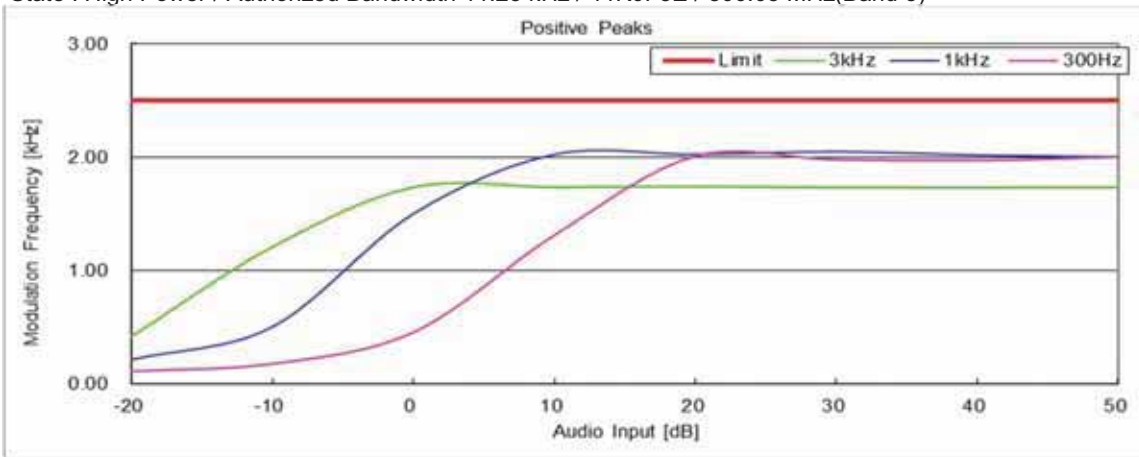

State : High Power / Authorized Bandwidth 11.25 kHz / 11K0F3E / 868.95 MHz(Band 4)

