

FCC REPORT

FCC Certification

Applicant Name:

JVC KENWOOD Corporation

Date of Issue:

December 01, 2015

Address:1-16-2, Hakusan, Midori-ku, Yokohama-shi,
Kanagawa, 226-8525 Japan**Location:**HCT CO., LTD.,
74, Seoicheon-ro 578beon-gil, Majang-myeon,
Icheon-si, Gyeonggi-do, 17383, Rep. of KOREA**Report No.:** HCT-R-1511-F011-2**HCT FRN:** 0005866421**FCC ID:** K44475501**APPLICANT:** JVC KENWOOD Corporation**FCC Model(s):** TK-D340-K, TK-D340-M, TK-D340U-K**EUT Type:** UHF DIGITAL TRANSCEIVER**FCC Rule Part(s):** Part 90 and Part 2

The measurements shown in this report were made in accordance with the procedures specified in CFR47 section §2.947. I assume full responsibility for the accuracy and completeness of these measurements, and for the qualifications of all persons taking them.

HCT CO., LTD. Certifies that no party to this application has subject to a denial of Federal benefits that includes FCC benefits pursuant to section 5301 of the Anti-Drug Abuse Act of 1998, 21 U.S. C. 853(a)



Report prepared by
: Jong Seok Lee
Test engineer of RF Team



Approved by
: Sang Jun Lee
Manager of RF Team

This report only responds to the tested sample and may not be reproduced, except in full, without written approval of the HCT Co., Ltd.

Report Revision

TEST REPORT NO.	DATE	DESCRIPTION
HCT-R-1511-F011	November 20, 2015	- First Approval Report
HCT-R-1511-F011-1	November 26, 2015	- Revised the sentence in section 2. EUT DESCRIPTION (Poweroutputcontinuouslyvariableto1 W) ->(Power output continuously variable to 1 W)
HCT-R-1511-F011-2	December 01, 2015	-Retest the High output power on page 8.

Table of Contents

1. GENERAL INFORMATION	4
2. EUT DESCRIPTION	4
3. TEST METHODOLOGY	5
3.1 EUT CONFIGURATION	5
3.2 EUT EXERCISE	5
3.3 GENERAL TEST PROCEDURES	5
3.4 DESCRIPTION OF TEST MODES	5
3.5 Type of Emission.....	6
4. INSTRUMENT CALIBRATION.....	6
5. FACILITIES AND ACCREDITATIONS	6
5.1. TEST FACILITY	6
5.2 EQUIPMENT	6
6. SUMMARY TEST OF RESULTS	7
7. TEST RESULT	8
7.1 Carrier Output Power	8
7.2 Carrier Frequency Stability	9
7.3 Occupied Bandwidth.....	25
7.4 Modulation Limiting	37
7.5 Audio Frequency Response / Audio Low Pass Filter Response.....	50
7.6 Emission Mask.....	58
7.7 Transient Frequency Behavior.....	69
7.8 Unwanted Emissions : Conducted Spurious Emission	89
7.9 Unwanted Emissions : Radiated SpuriousEmission	130
7.10 Necessary Bandwidth Calculations	140
8. LIST OF TEST EQUIPMENT	141

MEASUREMENT REPORT

1. GENERAL INFORMATION

Applicant Name: JVC KENWOOD Corporation
Address: 1-16-2, Hakusan, Midori-ku, Yokohama-shi, Kanagawa, 226-8525 Japan
FCC ID: K44475501
EUT Type: UHF DIGITAL TRANSCEIVER
FCC Model(s): TK-D340-K, TK-D340-M, TK-D340U-K
Date(s) of Tests: November 06, 2015 ~ November 12, 2015
Place of Tests: HCT Co., Ltd.
74, Seoicheon-ro 578beon-gil, Majang-myeon, Icheon-si, Gyeonggi-do,
17383, Rep. of KOREA (IC Recognition No. : 5944A-5)

2. EUT DESCRIPTION

EUT Type	UHF DIGITAL TRANSCEIVER
FCC Model Name	TK-D340-K, TK-D340-M, TK-D340U-K
Power Supply	DC 7.5 V
Output Power	4W (Power output continuously variable to 1 W)
Battery type	Li-ion Battery (KNB-45L, KNB-69L, KNB-29N, KNB-53N)
Channel Bandwidth	12.5 kHz / 25 kHz
Operating Temperature	-30 °C ~ +60 °C
Modulation	16K0F3E (25kHz bandwidth) 11K0F3E (12.5kHz bandwidth) 7K60FXD, 7K60FXE(12.5kHz bandwidth)
Frequency Range	450MHz ~ 512 MHz (12.5kHz bandwidth) 470MHz ~ 512 MHz (25kHz bandwidth)
Test Frequency	450.05MHz, 481.05MHz, 511.95MHz (12.5kHz bandwidth) 470.05MHz, 491.05MHz, 511.95MHz (25kHz bandwidth)

3. TEST METHODOLOGY

TIA-603-D dated June 24, 2010 entitled "Land Mobile FM or PM Communications Equipment Measurement and Performance Standards" were used in the measurement.

3.1 EUT CONFIGURATION

The EUT configuration for testing is installed on RF field strength measurement to meet the Commissions requirement and operating in a manner that intends to maximize its emission characteristics in a continuous normal application.

3.2 EUT EXERCISE

The EUT was operated in the engineering mode to fix the Tx frequency that was for the purpose of the measurements. According to its specifications, the EUT must comply with the requirements of the FCC Rules Part 2 and Part 90.

3.3 GENERAL TEST PROCEDURES

Radiated Emissions

Radiated emission measurements are performed in the Fully-anechoic chamber. The equipment under test is placed on a non-conductive table 3-meters away from the receive antenna in accordance with ANSI/TIA-603-D-2010 Clause 2.2.17. The turntable is rotated through 360 degrees, and the receiving antenna scans in order to determine the level of the maximized emission. The level and position of the maximized emission is recorded with the spectrum analyzer using a positive peak detector.

A half wave dipole is then substituted in place of the EUT. For emissions above 1GHz, a horn antenna is substituted in place of the EUT. The substitute antenna is driven by a signal generator and the previously recorded signal was duplicated.

The power is calculated by the following formula;

$$P_{d(dBm)} = P_{g(dBm)} - \text{cable loss}_{(dB)} + \text{antenna gain}_{(dB)}$$

Where: P_d is the dipole equivalent power and P_g is the generator output power into the substitution antenna.

The maximum EIRP is calculated by adding the forward power to the calibrated source plus its appropriate gain value. These steps are repeated with the receiving antenna in both vertical and horizontal polarization. the difference between the gain of the horn and an isotropic antenna are taken into consideration

3.4 DESCRIPTION OF TEST MODES

The EUT has been tested under operating condition. Test program used to control the EUT for staying in continuous transmitting is programmed.

3.5 Type of Emission

16K0F3E	(Analogue)
11K0F3E	(Analogue)
7K60FXD, 7K60FXE	(Digital)

4. INSTRUMENT CALIBRATION

The measuring equipment, which was utilized in performing the tests documented herein, has been calibrated in accordance with the manufacturer's recommendations for utilizing calibration equipments, which is traceable to recognized national standards.

5. FACILITIES AND ACCREDITATIONS

5.1. TEST FACILITY

The Fully-anechoic chamber and conducted measurement facility used to collect the radiated data are located at the **74, Seoicheon-ro 578beon-gil, Majang-myeon, Icheon-si, Gyeonggi-do, 17383, Rep. of KOREA.**

5.2 EQUIPMENT

Radiated emissions are measured with one or more of the following types of Linearly polarized antennas: tuned dipole, bi-conical, log periodic, bi-log, and/or ridged waveguide, horn. Spectrum analyzers with pre-selectors and quasi-peak detectors are used to perform radiated measurements. Conducted emissions are measured with Line Impedance Stabilization Networks and EMI Test Receivers. Calibrated wideband preamplifiers, coaxial cables, and coaxial attenuators are also used for making measurements.

All receiving equipment conforms to CISPR Publication 16-1, "Radio Interference Measuring Apparatus and Measurement Methods."

6. SUMMARY TEST OF RESULTS

Test Description	FCC Part Section(s)	Test Limit	Test Condition	Test Result
Carrier Output Power	§90.205(i) §2.1046(a)	Varies	CONDUCTED	PASS
Unwanted Emissions	§2.1051			PASS
99% Bandwidth	NA	NA		PASS
Carrier Frequency Stability	§90.213(a), §2.1055	Channel Spacing : 12.5 kHz = 2.5 ppm Channel Spacing : 25 kHz = 5 ppm		PASS
Audio Frequency Response	§2.1047(a)	Varies		PASS
Audio Low Pass Filter	§2.1047(a)			PASS
Modulation Limiting	§2.1047(b)			PASS
Transient Frequency Behavior	§90.214			PASS
Emission Mask	§90.210, §2.1049(c)(1)	Varies		PASS
Field Strength of Spurious Radiation	§2.1053	Varies		RADIATED
Necessary Bandwidth	§2.202(g)		-	-

7. TEST RESULT

7.1 Carrier Output Power

■ Definition

The conducted carrier power output rating for a transmitter is the power available at the output terminals of the transmitter when the output terminals are connected to the standard transmitter load.

■ TEST CONFIGURATION

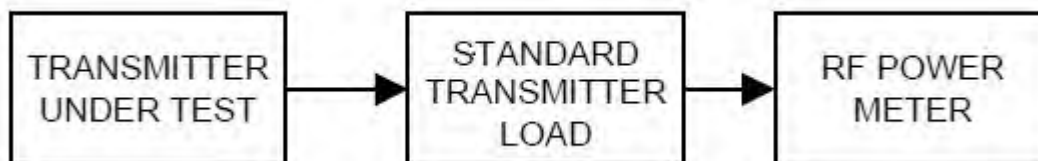

■ TEST PROCEDURE

According to 2.2.1 in TIA-603-D Standard.

- a) Connect the equipment as illustrated.
- b) Measure the transmitter output power during the defined duty cycle(see 1.3.2).
Correct for all losses in the RF path.
- c) The value recorded in step b) is the conducted carrier output power rating.

■ TEST RESULTS

Mode	Type of Emission	Channel Spacing	Freq.(MHz)	Carrier Output Power			
				Low		High	
				dBm	W	dBm	W
Analog	11K0F3E	12.5 kHz	450.05	30.247	1.059	35.895	3.886
			481.05	29.917	0.981	36.036	4.014
			511.95	29.272	0.846	35.911	3.900
	16K0F3E	25.0 kHz	470.05	30.347	1.083	36.179	4.166
			491.05	29.936	0.985	35.991	3.973
			511.95	29.449	0.881	36.004	3.985
Digital	7K60FXD, 7K60FXE	12.5 kHz	450.05	30.214	1.051	36.072	4.048
			481.05	30.035	1.008	36.025	4.004
			511.95	30.388	1.093	35.856	3.851

7.2 Carrier Frequency Stability

■ Definition

The carrier frequency stability is the ability of the transmitter to maintain an assigned carrier frequency.

■ TEST CONFIGURATION

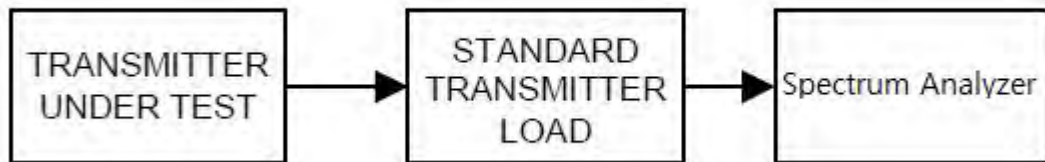

■ TEST PROCEDURE

According to 2.2.2 in TIA-603-D Standard.

- a) Connect the equipment as illustrated.
- b) Operate the equipment in standby conditions for 15 minutes before proceeding.
- c) Record the carrier frequency of the transmitter as MCF_{MHz}
- d) Calculate the ppm frequency error by the following:

$$\text{ppm error} = ((MCF_{\text{MHz}} / ACF_{\text{MHz}}) - 1) * 10^6$$

where

MCF_{MHz} is the Measured Carrier Frequency in MHz

ACF_{MHz} is the Assigned Carrier Frequency in MHz

- e) The value recorded in step d) is the carrier frequency stability.

*Note: In order to simplify the report, attached data were only the worst case frequency stability.

■TEST RESULTS - 11K0F3E**(1) Frequency Stability (Temperature Variation)**

450.05 MHz (High Power)

Temperature (Degree C)	Frequency (MHz)	Frequency stability (ppm)
-30	450.050009159	0.020
-20	450.050022615	0.050
-10	450.050058497	0.130
0	450.050059887	0.133
10	450.050076774	0.171
20	450.050169643	0.377
30	450.050098556	0.219
40	450.050099647	0.221
50	450.050102458	0.228

481.05 MHz (High Power)

Temperature (Degree C)	Frequency (MHz)	Frequency stability (ppm)
-30	481.050100128	0.208
-20	481.050121784	0.253
-10	481.050164121	0.341
0	481.050180616	0.375
10	481.050186549	0.388
20	481.050194015	0.403
30	481.050159612	0.332
40	481.050127513	0.265
50	481.050119648	0.249

511.95 MHz (High Power)

Temperature (Degree C)	Frequency (MHz)	Frequency stability (ppm)
-30	511.950017648	0.034
-20	511.950021485	0.042
-10	511.950092647	0.181
0	511.950099452	0.194
10	511.950099684	0.195
20	511.950212592	0.415
30	511.950118264	0.231
40	511.950158467	0.310
50	511.950182352	0.356

450.05 MHz (Low Power)

Temperature (Degree C)	Frequency (MHz)	Frequency stability (ppm)
-30	450.050014657	0.033
-20	450.050031552	0.070
-10	450.050062998	0.140
0	450.050099651	0.221
10	450.050099778	0.222
20	450.050187353	0.416
30	450.050099154	0.220
40	450.050143750	0.319
50	450.050150129	0.334

481.05 MHz (Low Power)

Temperature (Degree C)	Frequency (MHz)	Frequency stability (ppm)
-30	481.050015548	0.032
-20	481.050034268	0.071
-10	481.050067268	0.140
0	481.050091591	0.190
10	481.050092994	0.193
20	481.050201804	0.420
30	481.050102098	0.212
40	481.050153226	0.319
50	481.050166294	0.346

511.95 MHz (Low Power)

Temperature (Degree C)	Frequency (MHz)	Frequency stability (ppm)
-30	511.950018267	0.036
-20	511.950038645	0.075
-10	511.950081224	0.159
0	511.950082158	0.160
10	511.950082354	0.161
20	511.950214909	0.420
30	511.950112157	0.219
40	511.950168457	0.329
50	511.950187512	0.366

(2)Frequency Stability (Voltage Variation)

450.05 MHz (High Power)

Temperature (Degree C)	Diviation (%)	Voltage (V)	Frequency (MHz)	Frequency stability (ppm)
25	85	6.38	450.050171540	0.381
25	100	7.50	450.050171862	0.382
25	115	8.63	450.050171896	0.382

481.05 MHz (High Power)

Temperature (Degree C)	Diviation (%)	Voltage (V)	Frequency (MHz)	Frequency stability (ppm)
25	85	6.38	481.050195750	0.407
25	100	7.50	481.050194991	0.405
25	115	8.63	481.050196054	0.408

511.95 MHz (High Power)

Temperature (Degree C)	Diviation (%)	Voltage (V)	Frequency (MHz)	Frequency stability (ppm)
25	85	6.38	511.950212043	0.414
25	100	7.50	511.950213318	0.417
25	115	8.63	511.950213035	0.416

450.05 MHz (Low Power)

Temperature (Degree C)	Diviation (%)	Voltage (V)	Frequency (MHz)	Frequency stability (ppm)
25	85	6.38	450.050186233	0.414
25	100	7.50	450.050185589	0.412
25	115	8.63	450.050185770	0.413

481.05 MHz (Low Power)

Temperature (Degree C)	Diviation (%)	Voltage (V)	Frequency (MHz)	Frequency stability (ppm)
25	85	6.38	481.050198713	0.413
25	100	7.50	481.050198934	0.414
25	115	8.63	481.050199980	0.416

511.95 MHz (Low Power)

Temperature (Degree C)	Diviation (%)	Voltage (V)	Frequency (MHz)	Frequency stability (ppm)
25	85	6.38	511.950215445	0.421
25	100	7.50	511.950212349	0.415
25	115	8.63	511.950213020	0.416

■TEST RESULTS - 16K0F3E**(1) Frequency Stability (Temperature Variation)**

470.05 MHz (High Power)

Temperature (Degree C)	Frequency (MHz)	Frequency stability (ppm)
-30	470.050010267	0.022
-20	470.050029158	0.062
-10	470.050038642	0.082
0	470.050055784	0.119
10	470.050056845	0.121
20	470.050057972	0.123
30	470.050056841	0.121
40	470.050051267	0.109
50	470.050048128	0.102

491.05 MHz (High Power)

Temperature (Degree C)	Frequency (MHz)	Frequency stability (ppm)
-30	491.050028451	0.058
-20	491.050042519	0.087
-10	491.050051268	0.104
0	491.050059481	0.121
10	491.050075615	0.154
20	491.050094999	0.193
30	491.050090124	0.184
40	491.050072648	0.148
50	491.050042368	0.086

511.95 MHz (High Power)

Temperature (Degree C)	Frequency (MHz)	Frequency stability (ppm)
-30	511.950057954	0.113
-20	511.950084516	0.165
-10	511.950102647	0.201
0	511.950116487	0.228
10	511.950117645	0.230
20	511.950118458	0.231
30	511.950116457	0.227
40	511.950102157	0.200
50	511.950092549	0.181

470.05 MHz (Low Power)

Temperature (Degree C)	Frequency (MHz)	Frequency stability (ppm)
-30	470.050090218	0.192
-20	470.050101251	0.215
-10	470.050102684	0.218
0	470.050118547	0.252
10	470.050123487	0.263
20	470.050125992	0.268
30	470.050100648	0.214
40	470.050097513	0.207
50	470.050056841	0.121

491.05 MHz (Low Power)

Temperature (Degree C)	Frequency (MHz)	Frequency stability (ppm)
-30	491.050068154	0.139
-20	491.050075613	0.154
-10	491.050089514	0.182
0	491.050108562	0.221
10	491.050116847	0.238
20	491.050139247	0.284
30	491.050121648	0.248
40	491.050089615	0.182
50	491.050068512	0.140

511.95 MHz (Low Power)

Temperature (Degree C)	Frequency (MHz)	Frequency stability (ppm)
-30	511.950061267	0.120
-20	511.950080647	0.158
-10	511.950094516	0.185
0	511.950106487	0.208
10	511.950116847	0.228
20	511.950151351	0.296
30	511.950150645	0.294
40	511.950112647	0.220
50	511.950106487	0.208

(2)Frequency Stability (Voltage Variation)

470.05 MHz (High Power)

Temperature (Degree C)	Diviation (%)	Voltage (V)	Frequency (MHz)	Frequency stability (ppm)
25	85	6.38	470.050060964	0.130
25	100	7.50	470.050063870	0.136
25	115	8.63	470.050062768	0.134

491.05 MHz (High Power)

Temperature (Degree C)	Diviation (%)	Voltage (V)	Frequency (MHz)	Frequency stability (ppm)
25	85	6.38	491.050094830	0.193
25	100	7.50	491.050097112	0.198
25	115	8.63	491.050095699	0.195

511.95 MHz (High Power)

Temperature (Degree C)	Diviation (%)	Voltage (V)	Frequency (MHz)	Frequency stability (ppm)
25	85	6.38	511.950122445	0.239
25	100	7.50	511.950123698	0.242
25	115	8.63	511.950120646	0.236

470.05 MHz (Low Power)

Temperature (Degree C)	Diviation (%)	Voltage (V)	Frequency (MHz)	Frequency stability (ppm)
25	85	6.38	470.050125961	0.268
25	100	7.50	470.050127879	0.272
25	115	8.63	470.050127759	0.272

491.05 MHz (Low Power)

Temperature (Degree C)	Diviation (%)	Voltage (V)	Frequency (MHz)	Frequency stability (ppm)
25	85	6.38	491.050141058	0.287
25	100	7.50	491.050141358	0.288
25	115	8.63	491.050141983	0.289

511.95 MHz (Low Power)

Temperature (Degree C)	Diviation (%)	Voltage (V)	Frequency (MHz)	Frequency stability (ppm)
25	85	6.38	511.950152079	0.297
25	100	7.50	511.950151500	0.296
25	115	8.63	511.950150469	0.294

■TEST RESULTS - 7K60FXD, 7K60FXE**(1) Frequency Stability (Temperature Variation)**

450.05 MHz (High Power)

Temperature (Degree C)	Frequency (MHz)	Frequency stability (ppm)
-30	450.050016245	0.036
-20	450.050022225	0.049
-10	450.050054094	0.120
0	450.050069595	0.155
10	450.050076824	0.171
20	450.050277344	0.616
30	450.050099041	0.220
40	450.050133893	0.298
50	450.050152711	0.339

481.05 MHz (High Power)

Temperature (Degree C)	Frequency (MHz)	Frequency stability (ppm)
-30	481.050018399	0.038
-20	481.050026413	0.055
-10	481.050064079	0.133
0	481.050075201	0.156
10	481.050080199	0.167
20	481.050318764	0.663
30	481.050090176	0.187
40	481.050146293	0.304
50	481.050162676	0.338

511.95 MHz (High Power)

Temperature (Degree C)	Frequency (MHz)	Frequency stability (ppm)
-30	511.950018673	0.036
-20	511.950031589	0.062
-10	511.950070475	0.138
0	511.950082276	0.161
10	511.950086260	0.168
20	511.950340258	0.665
30	511.950102149	0.200
40	511.950157584	0.308
50	511.950174709	0.341

450.05 MHz (Low Power)

Temperature (Degree C)	Frequency (MHz)	Frequency stability (ppm)
-30	450.050014792	0.033
-20	450.050030140	0.067
-10	450.050063851	0.142
0	450.050076211	0.169
10	450.050077911	0.173
20	450.050300990	0.669
30	450.050092863	0.206
40	450.050142200	0.316
50	450.050154899	0.344

481.05 MHz (Low Power)

Temperature (Degree C)	Frequency (MHz)	Frequency stability (ppm)
-30	481.050014496	0.030
-20	481.050033622	0.070
-10	481.050070339	0.146
0	481.050081646	0.170
10	481.050085305	0.177
20	481.050320753	0.667
30	481.050101348	0.211
40	481.050153177	0.318
50	481.050164372	0.342

511.95 MHz (Low Power)

Temperature (Degree C)	Frequency (MHz)	Frequency stability (ppm)
-30	511.950016876	0.033
-20	511.950035370	0.069
-10	511.950073197	0.143
0	511.950088099	0.172
10	511.950090834	0.177
20	511.950339942	0.664
30	511.950112099	0.219
40	511.950165943	0.324
50	511.950174980	0.342

(2)Frequency Stability (Voltage Variation)

450.05 MHz (High Power)

Temperature (Degree C)	Diviation (%)	Voltage (V)	Frequency (MHz)	Frequency stability (ppm)
25	85	6.38	450.050279505	0.621
25	100	7.50	450.050284625	0.632
25	115	8.63	450.050281806	0.626

481.05 MHz (High Power)

Temperature (Degree C)	Diviation (%)	Voltage (V)	Frequency (MHz)	Frequency stability (ppm)
25	85	6.38	481.050317815	0.661
25	100	7.50	481.050320620	0.667
25	115	8.63	481.050318710	0.663

511.95 MHz (High Power)

Temperature (Degree C)	Diviation (%)	Voltage (V)	Frequency (MHz)	Frequency stability (ppm)
25	85	6.38	511.950339529	0.663
25	100	7.50	511.950339890	0.664
25	115	8.63	511.950338860	0.662

450.05 MHz (Low Power)

Temperature (Degree C)	Diviation (%)	Voltage (V)	Frequency (MHz)	Frequency stability (ppm)
25	85	6.38	450.050301248	0.669
25	100	7.50	450.050300505	0.668
25	115	8.63	450.050300770	0.668

481.05 MHz (Low Power)

Temperature (Degree C)	Diviation (%)	Voltage (V)	Frequency (MHz)	Frequency stability (ppm)
25	85	6.38	481.050320128	0.665
25	100	7.50	481.050322193	0.670
25	115	8.63	481.050322276	0.670

511.95 MHz (Low Power)

Temperature (Degree C)	Diviation (%)	Voltage (V)	Frequency (MHz)	Frequency stability (ppm)
25	85	6.38	511.950339067	0.662
25	100	7.50	511.950340541	0.665
25	115	8.63	511.950339352	0.663

7.3 Occupied Bandwidth

■ Definition

The transmitter sideband spectrum denotes the sideband power produced at a discrete frequency separation from the carrier up to the test bandwidth (see TIA-603-D Section 1.3.4.4) due to all sources of unwanted noise within the transmitter in a modulated condition.

■ TEST CONFIGURATION

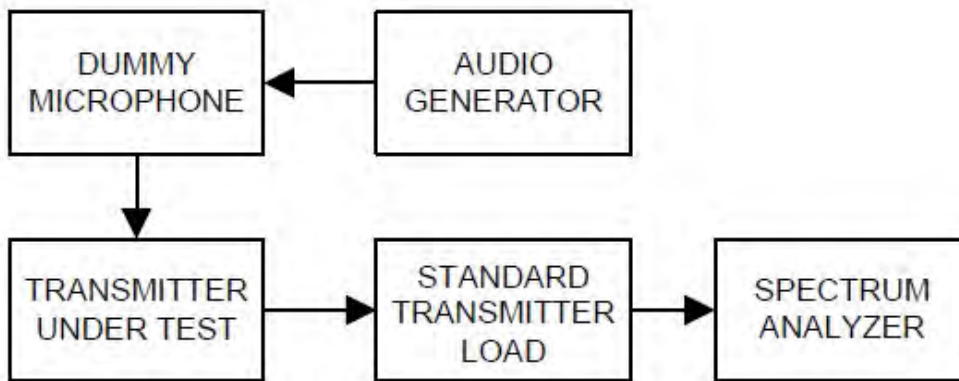

■ TEST PROCEDURE

According to TIA-603-D Section 2.2.11.2

- a) For EUT supporting audio modulation, the audio signal generator was adjusted to the frequency of maximum response and with output level set for +/- 2.5 kHz deviation (or 50 % modulation). (FM modulation).
- b) With level constant, the signal level was increased 16 dB..
- c) For EUT supporting digital modulation, the digital modulation mode was operated to its maximum extent.
- d) Adjust the spectrum analyzer for the following setting:
 - 1) RBW : 100Hz (Non modulation and Authorized Band 6 kHz),
100Hz (Non modulation and Authorized Band 11.25 kHz),
300Hz (Non modulation and Authorized Band 20 kHz).
 - 2) VBW : Video Bandwidth at least 10 times the resolution bandwidth.
 - 4) Sweep Speed : Sweep Speed slow enough to maintain measurement calibration.
 - 5) Sampling Time : 10 times
 - 6) Detector Mode = Positive Peak.
- e) The occupied Bandwidth was measured with the Spectrum Analyzer controls set as shown on the test results.

■LIMIT

Frequency Band (MHz)	Channel Spacing (kHz)	Authorized Bandwidth (kHz)
450 – 512 and	12.5	11.25
470 - 512	25	20

■TEST RESULTS

Conducted 99% Bandwidth Measurements for 11K0F3E

11K0F3E		Measured Bandwidth [kHz]	Setting
Frequency [MHz]	Channel Spacing		
450.05	12.5 kHz	5.235	High Power
481.05		5.243	
511.95		5.240	
450.05	12.5 kHz	5.236	Low Power
481.05		5.240	
511.95		5.242	

Conducted 99% Bandwidth Measurements for 16K0F3E

16K0F3E		Measured Bandwidth [kHz]	Setting
Frequency [MHz]	Channel Spacing		
470.05	25 kHz	10.521	High Power
491.05		10.548	
511.95		10.512	
470.05	25 kHz	10.533	Low Power
491.05		10.547	
511.95		10.536	

Conducted 99% Bandwidth Measurements for 7K60FXD, 7K60FXE

7K60FXD, 7K60FXE		Measured Bandwidth [kHz]	Setting
Frequency [MHz]	Channel Spacing		
450.05	12.5 kHz	7.574	High Power
481.05		7.563	
511.95		7.481	
450.05	12.5 kHz	7.569	Low Power
481.05		7.546	
511.95		7.460	

TEST RESULTS

11K0F3E

HIGH POWER_11K0F3E_450.05 MHz_Low

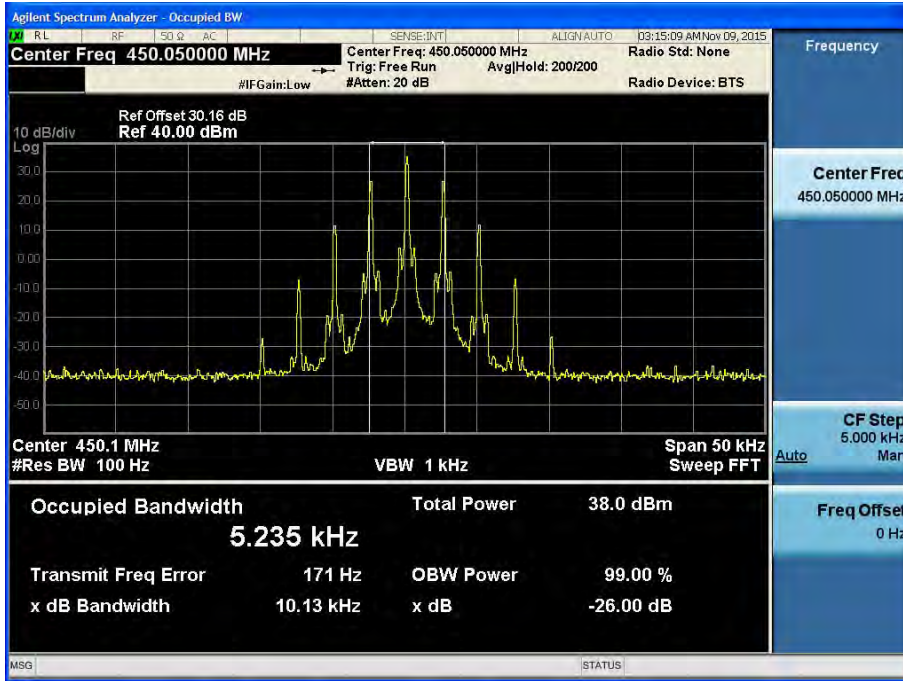

HIGH POWER_11K0F3E_481.05 MHz_Middle

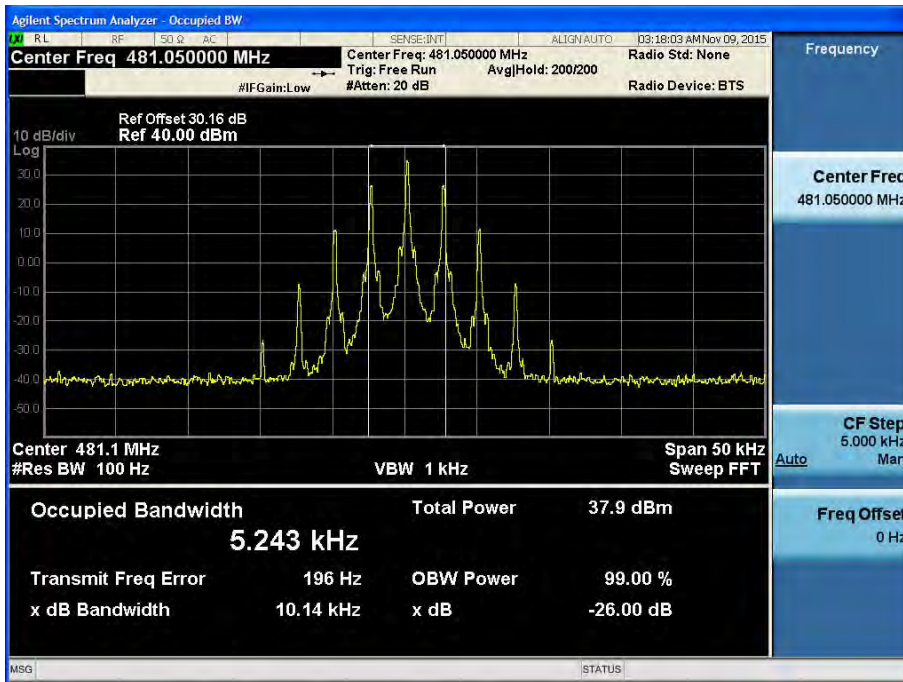

HIGH POWER_11K0F3E_511.95 MHz_High

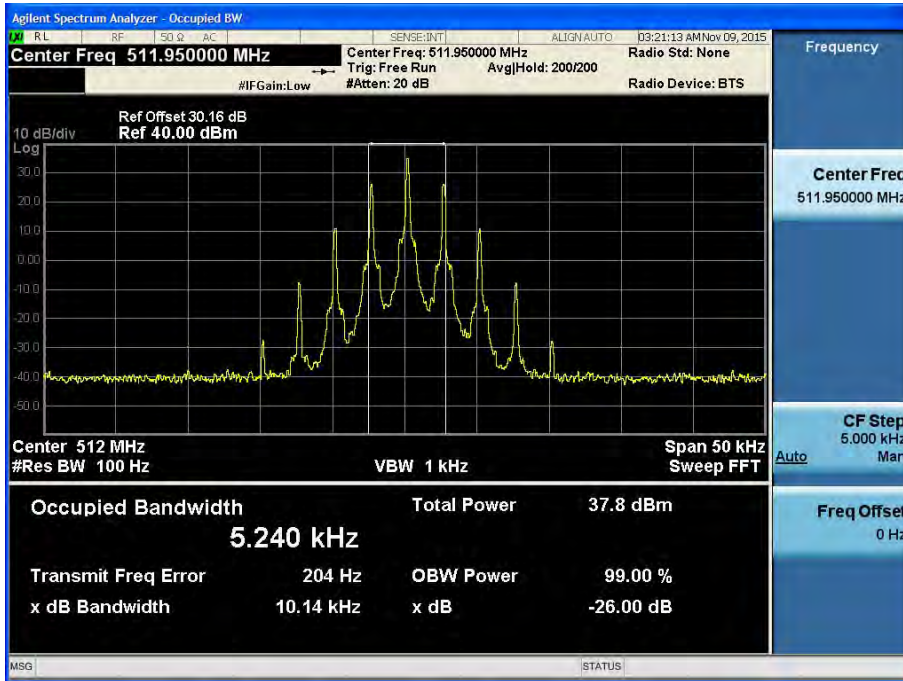

LOW POWER_11K0F3E_450.05 MHz_Low

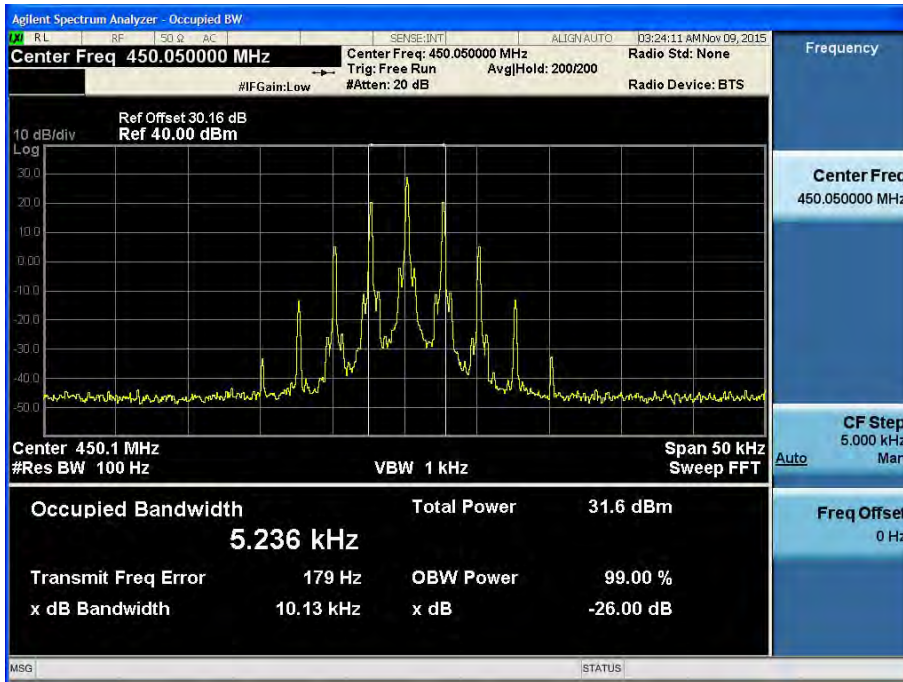

LOW POWER_11K0F3E_481.05 MHz_Middle

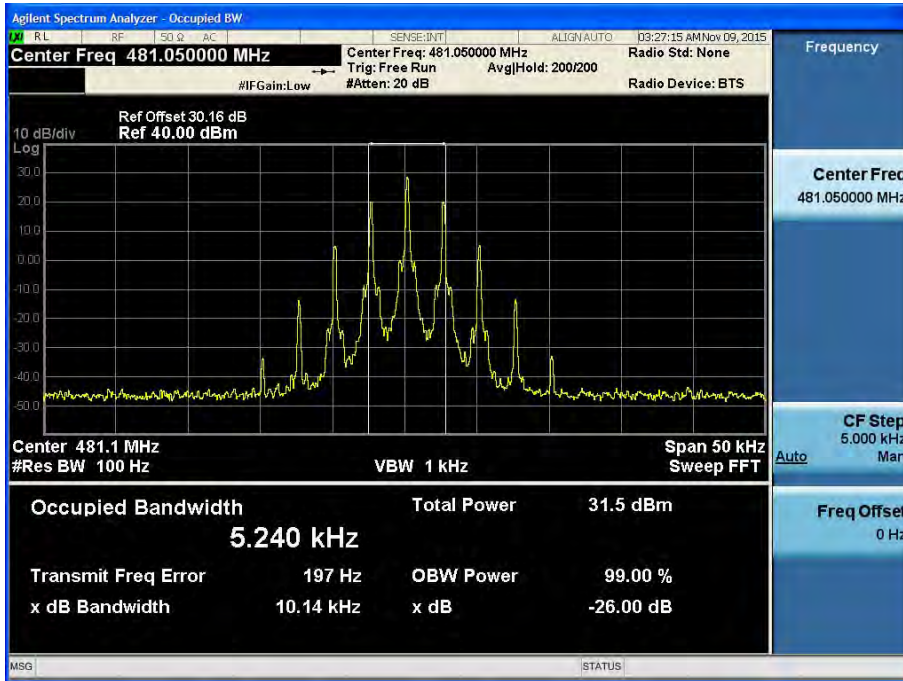

LOW POWER_11K0F3E_511.95 MHz_High

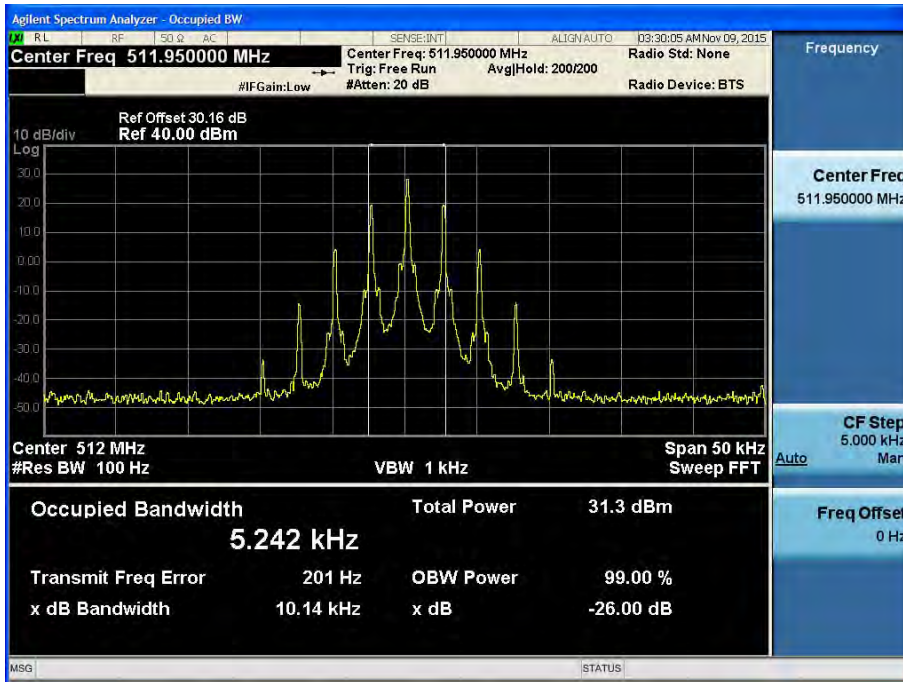

16K0F3E

HIGH POWER_16K0F3E _470.05 MHz_Low

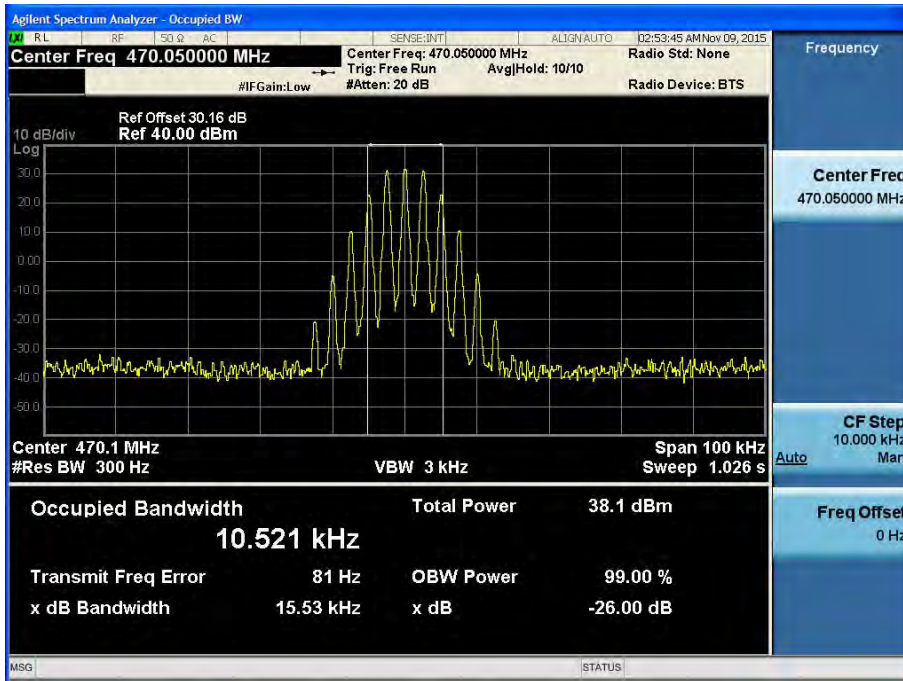

HIGH POWER_16K0F3E _491.05 MHz_Middle

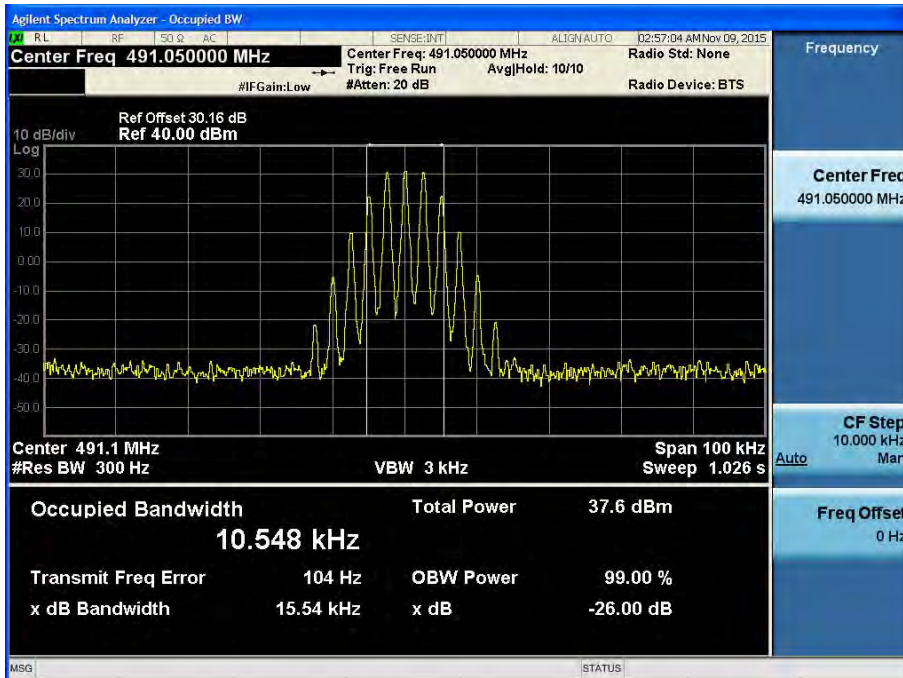

HIGH POWER_16K0F3E _511.95 MHz_High

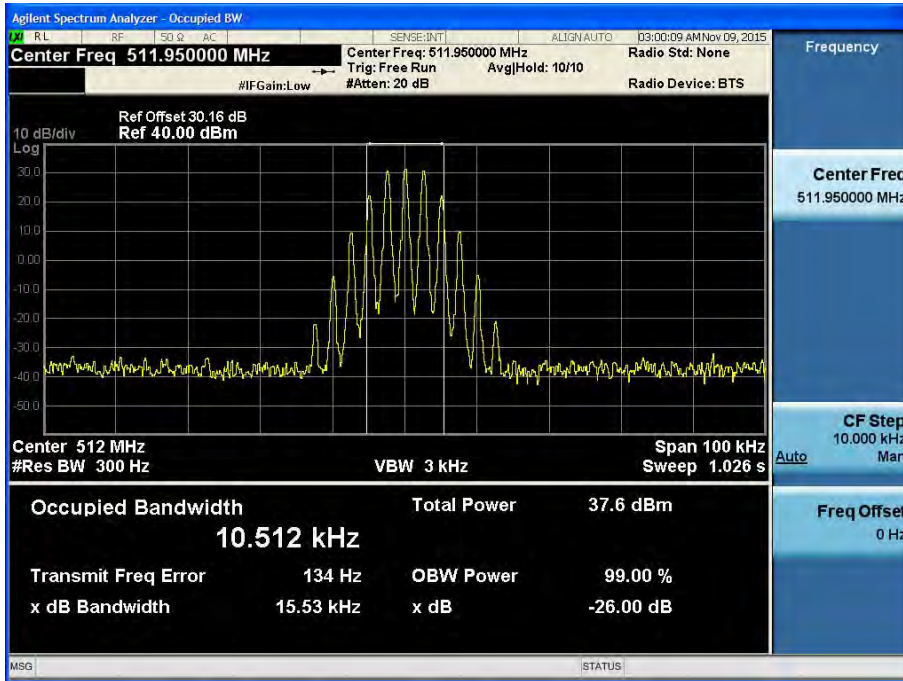

LOW POWER_16K0F3E _470.05 MHz_Low

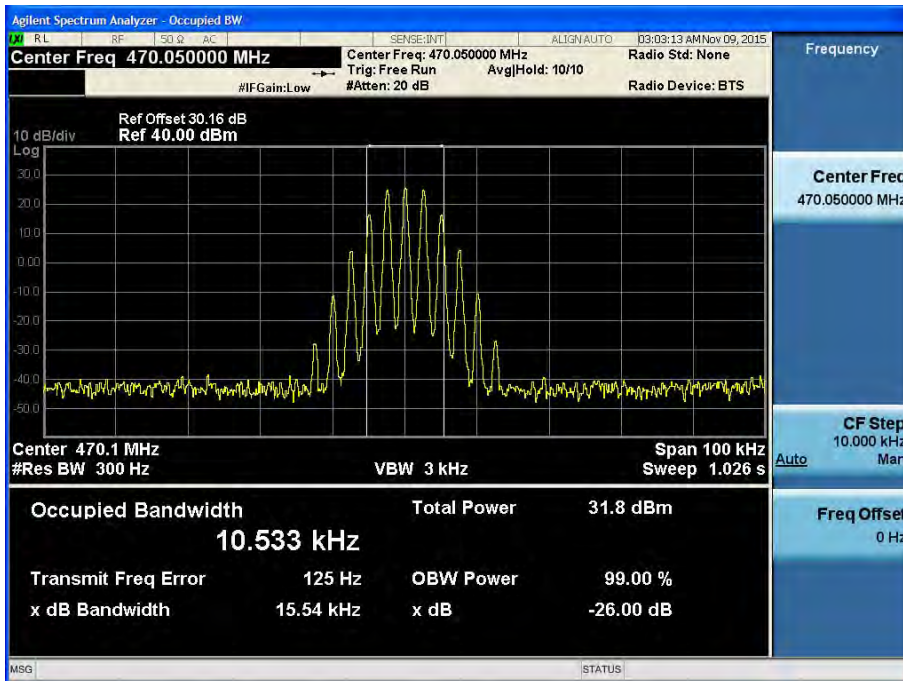

LOW POWER_16K0F3E_491.05 MHz_Middle

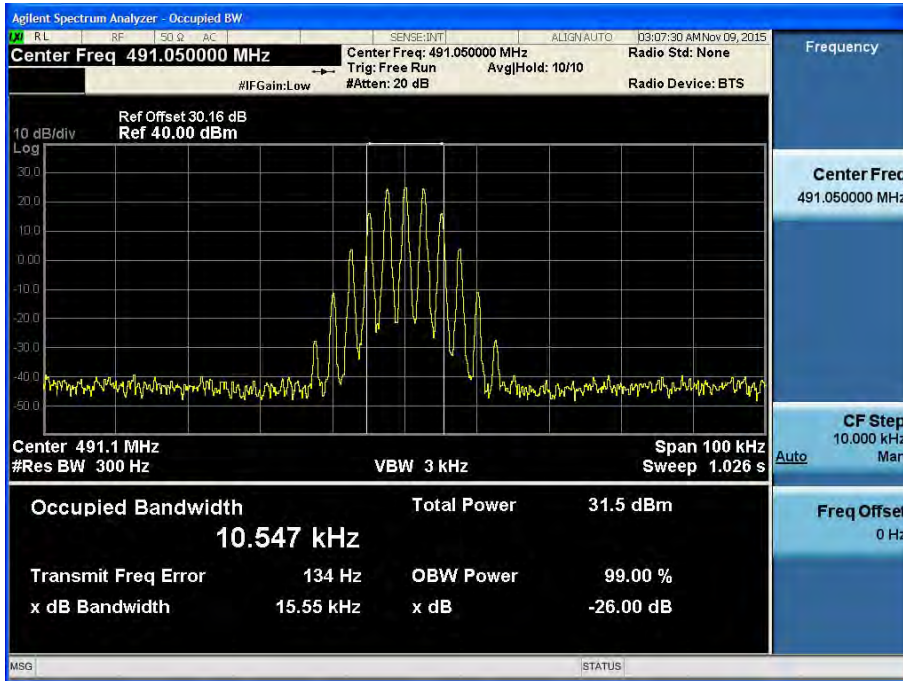

LOW POWER_16K0F3E_511.95 MHz_High

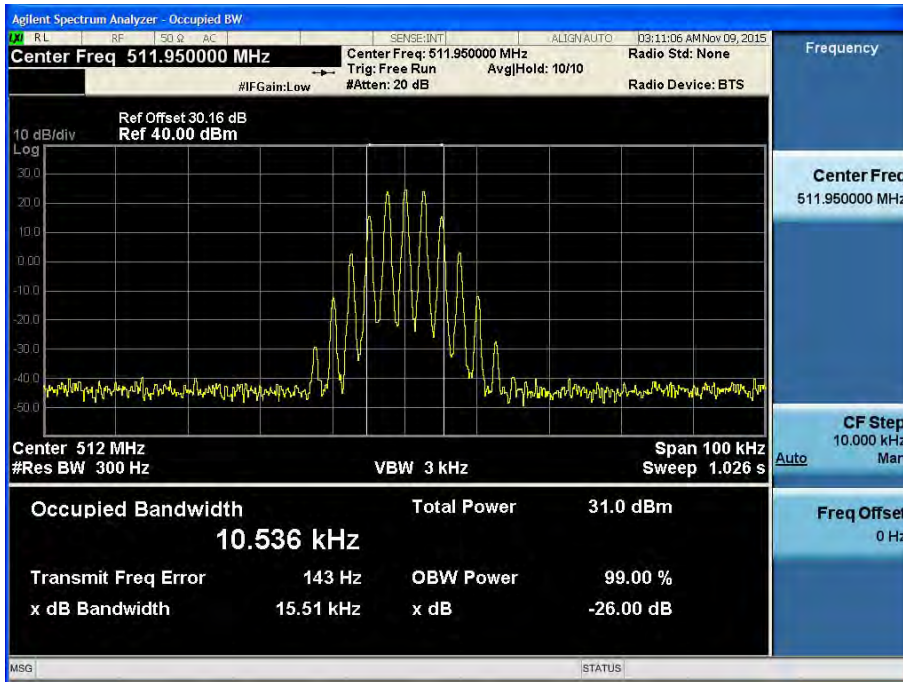

7K60FXD, 7K60FXE

HIGH POWER_7K60FXD, 7K60FXE _450.05 MHz_Low

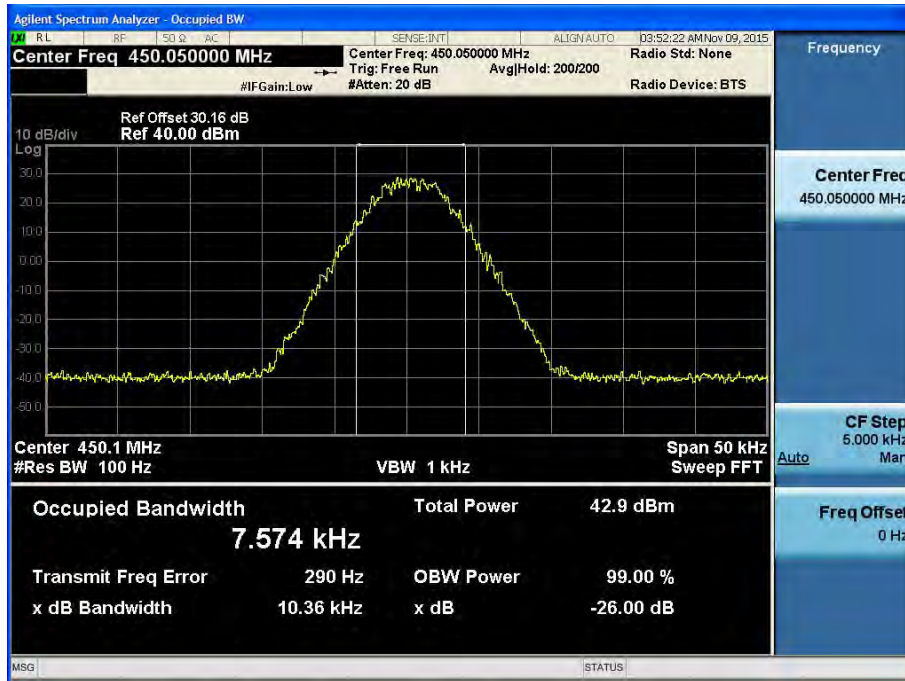

HIGH POWER_7K60FXD, 7K60FXE _481.05 MHz_Middle

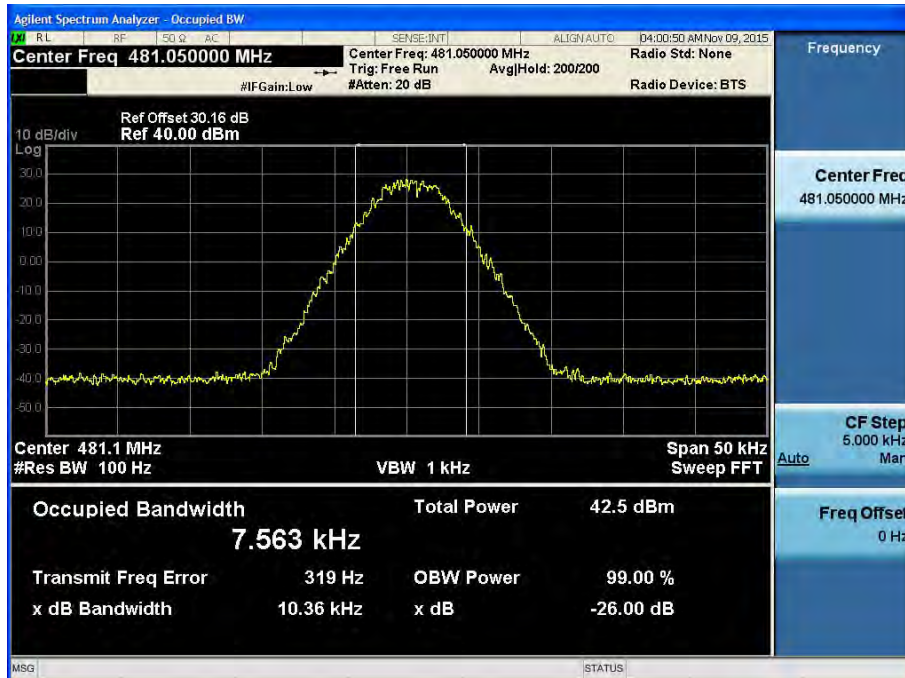

HIGH POWER_7K60FXD, 7K60FXE _511.95 MHz_High

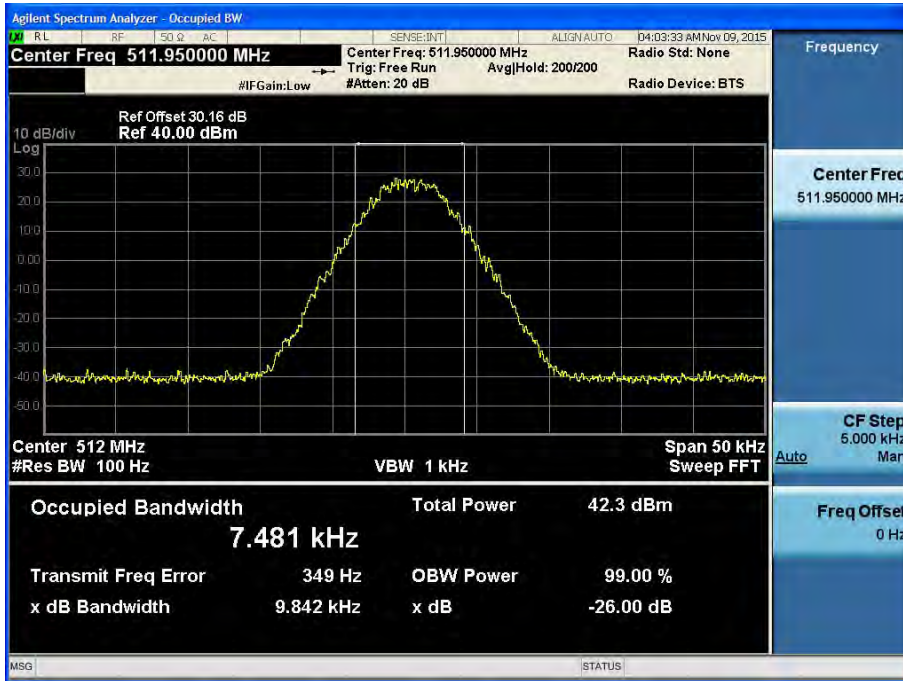

LOW POWER_7K60FXD, 7K60FXE _450.05 MHz_Low

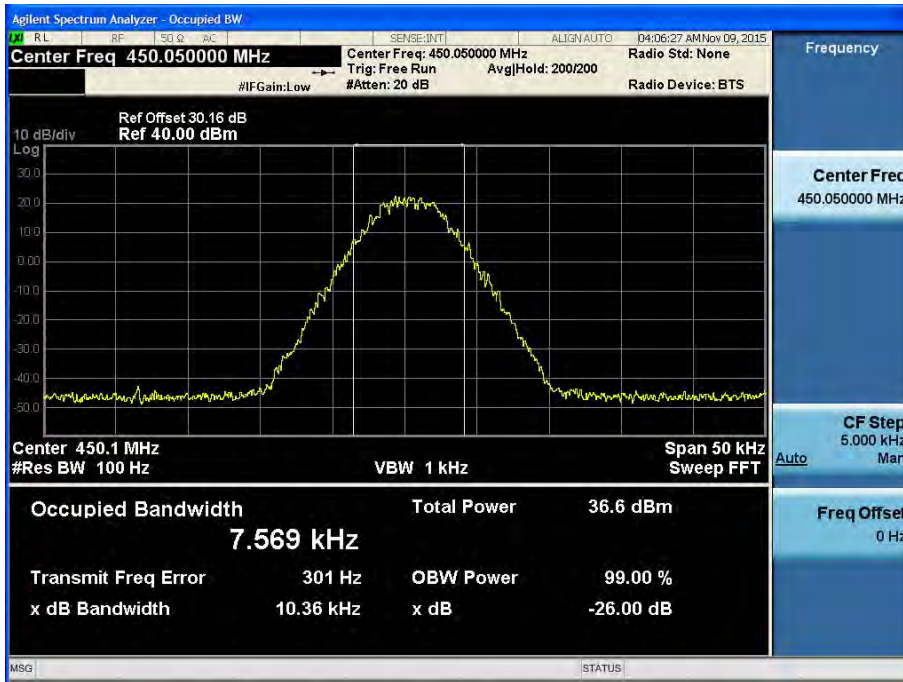

LOW POWER_7K60FXD, 7K60FXE _481.05 MHz_Middle

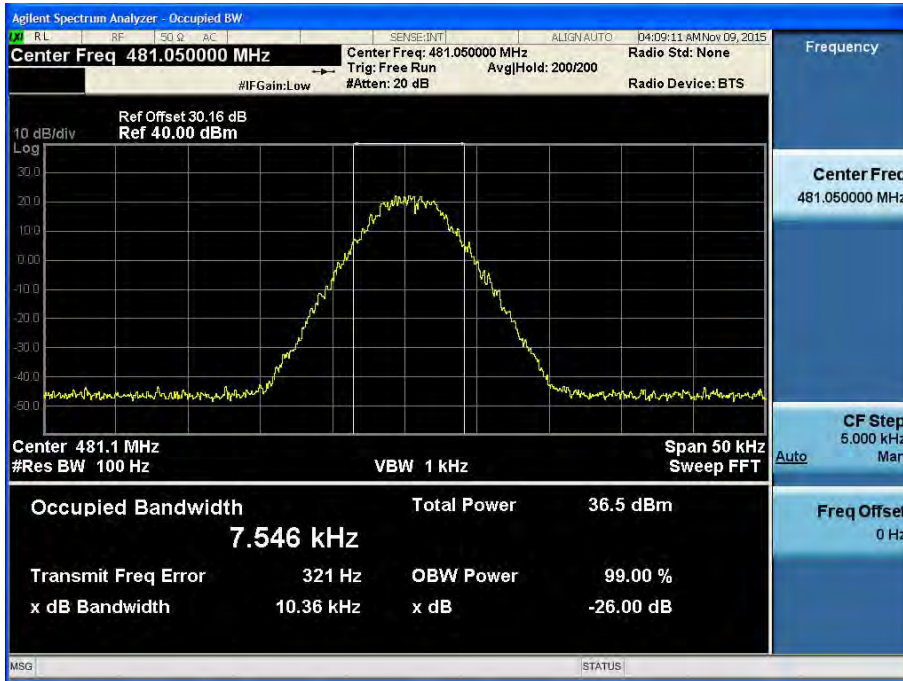

LOW POWER_7K60FXD, 7K60FXE _511.95 MHz_High

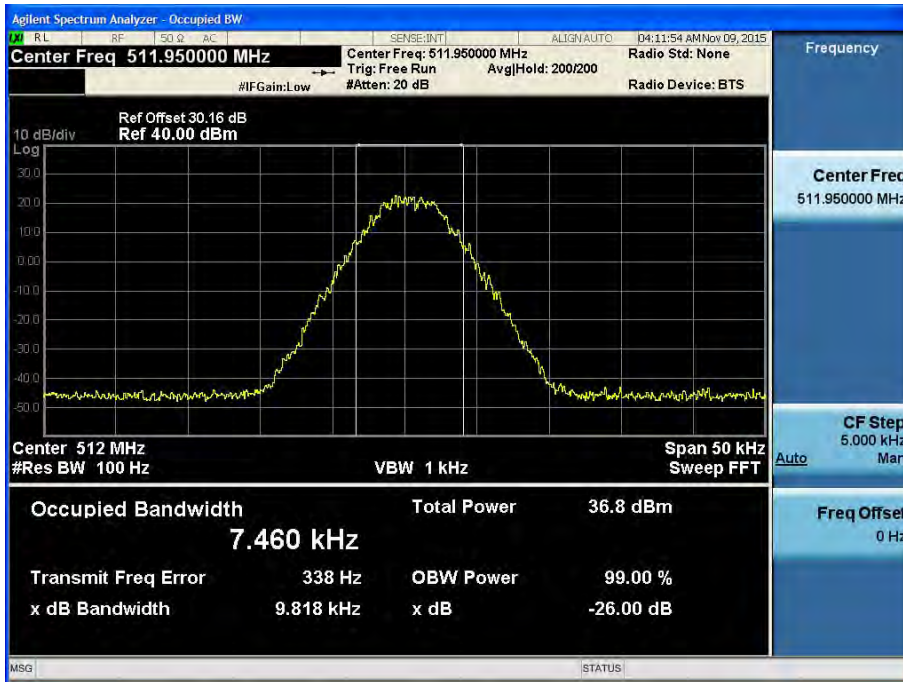

7.4 Modulation Limiting

■ Definition

Modulation limiting is the transmitter circuit's ability to limit the transmitter from producing deviations in excess of a rated system deviation.

■ TEST CONFIGURATION

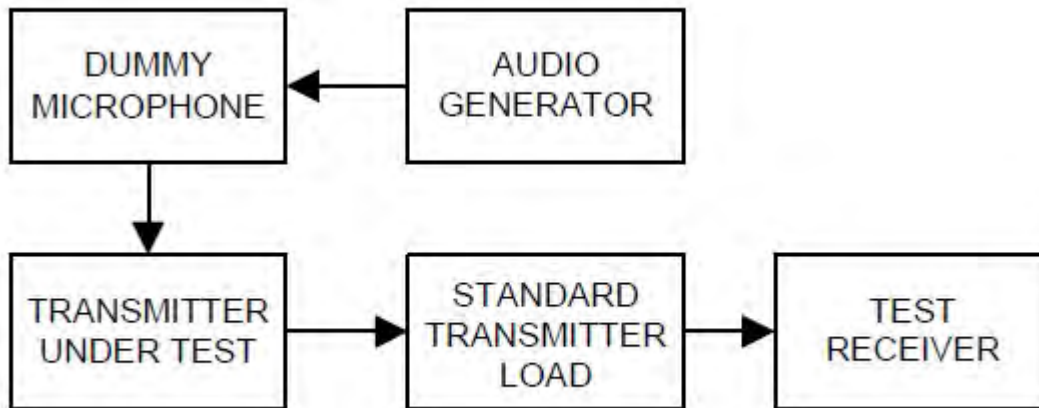

■ TEST PROCEDURE

According to 2.2.3 in TIA-603-D Standard.

- a) Connect the equipment as illustrated.
- b) Adjust the transmitter per the manufacturer's procedure for full rated system deviation.
- c) Set the test receiver to measure peak positive deviation.
Set the audio bandwidth for ≤ 0.25 Hz to $\geq 15,000$ Hz.
Turn the de-emphasis function off.
- d) Apply a 1000 Hz modulating signal to the transmitter from the audio frequency generator, and adjust the level obtain 60% of full rated system deviation.
- e) Increase the level form the audio frequency generator by 20 dB in one step(rise time between the 10% and 90% points shall be 0.1 second maximum).
- f) Measure both the instantaneous and steady-state deviation at and after the time of increasing the audio input level.
- g) With the level from the audio frequency generator held constant at the level obtained in step e), Slowly vary the audio frequency from 300 Hz to 3000 Hz and observe the steady-state deviation. Record the maximum deviation.
- h) Set the test receiver to measure peak negative deviation and repeat steps d) through g).
- i) The values recorded in steps g) and h) are the modulation limiting.

▣ TEST RESULTS

11K0F3E

Positive Peaks

11K0F3E_450.05MHz_HIGH POWER

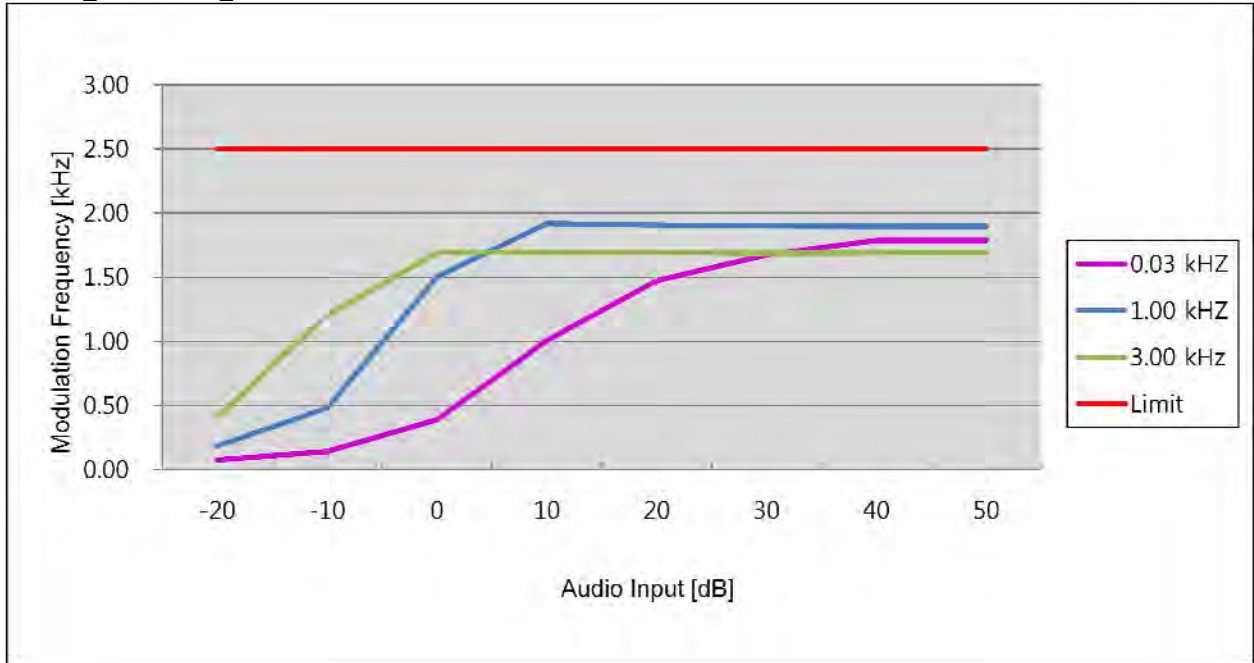

11K0F3E_481.05MHz_HIGH POWER

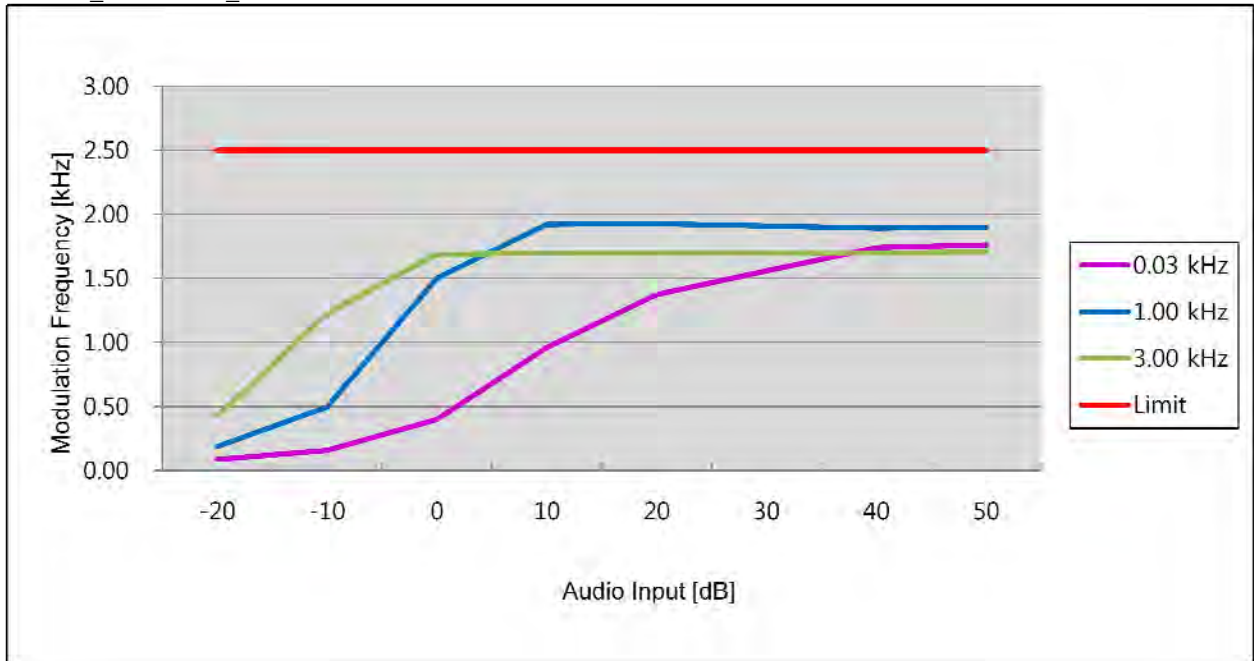

11K0F3E_511.95MHz_HIGH POWER

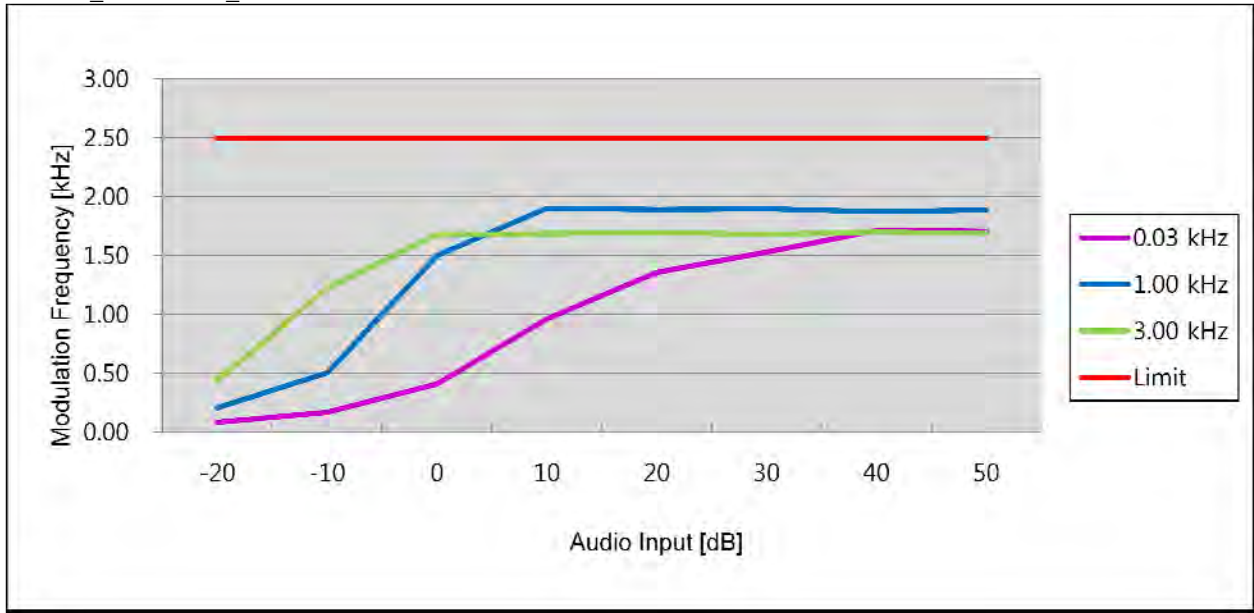

11K0F3E_450.05MHz_LOW POWER

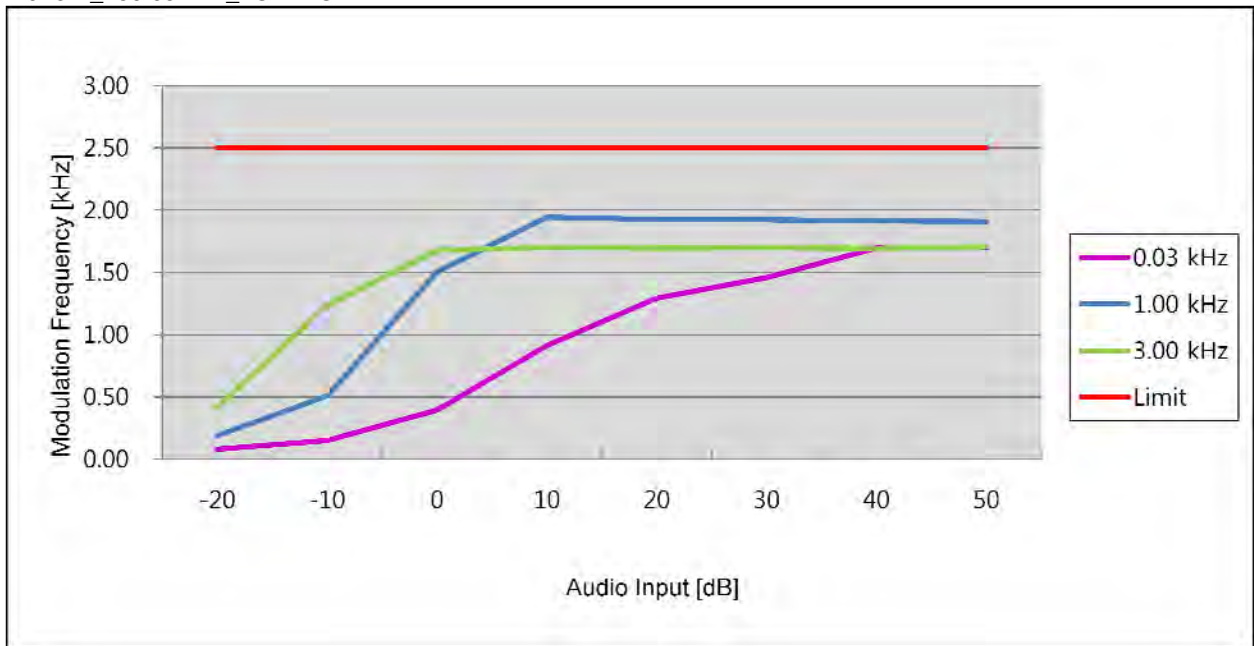

11K0F3E_481.05MHz_LOW POWER

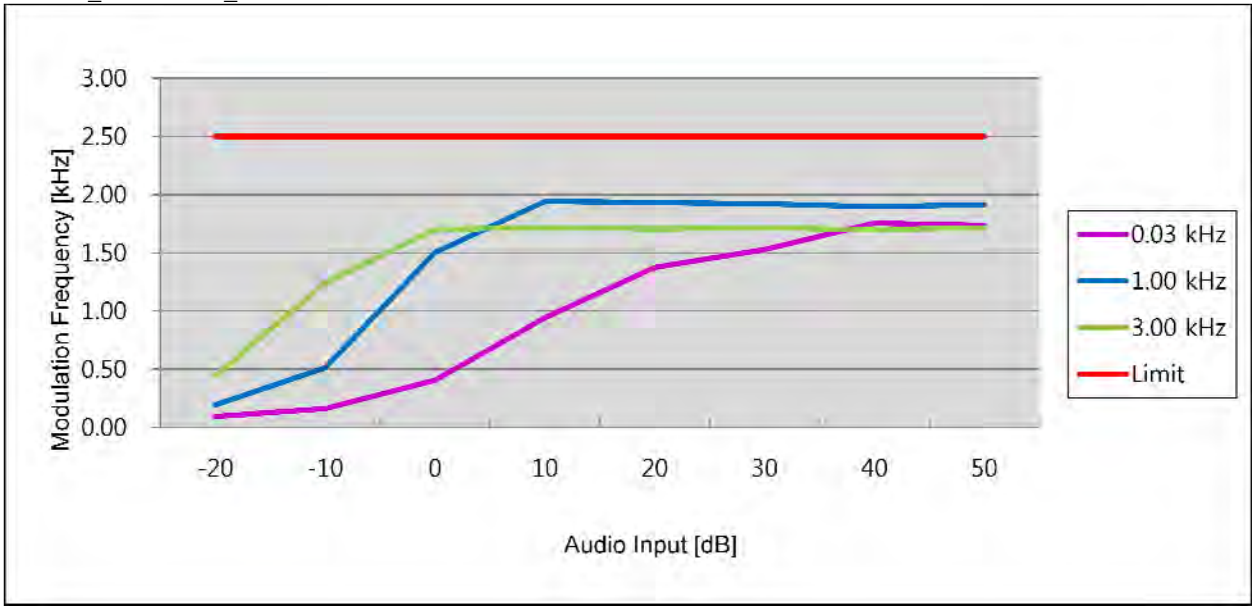

11K0F3E_511.95MHz_LOW POWER

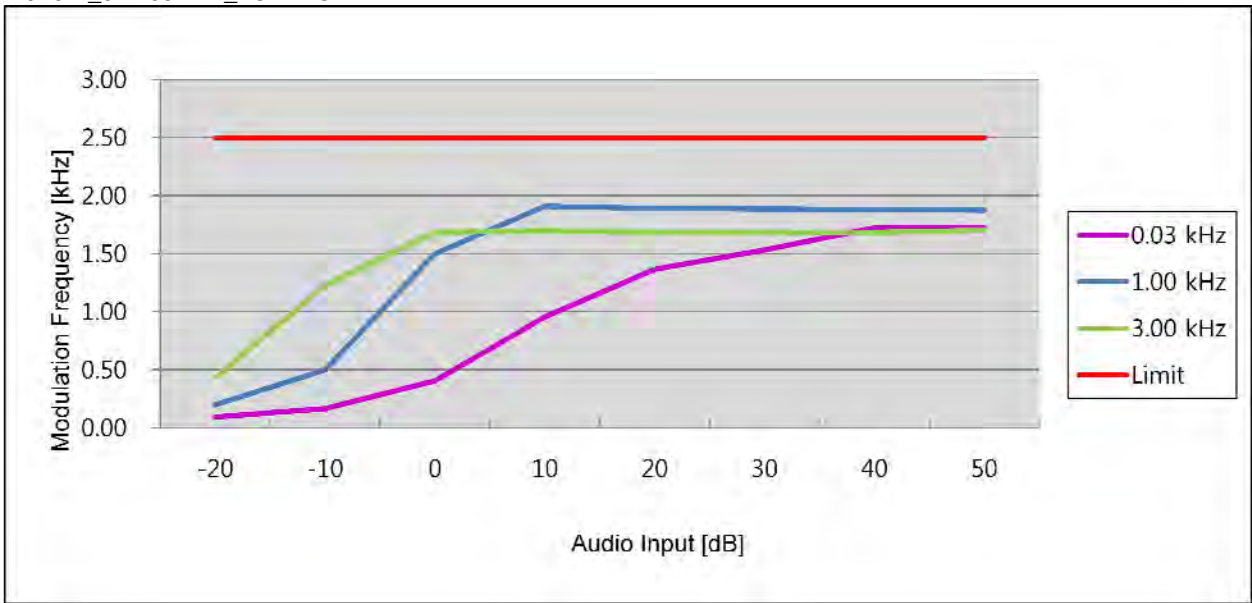

Negative Peaks

11K0F3E_450.05MHz_HIGH POWER

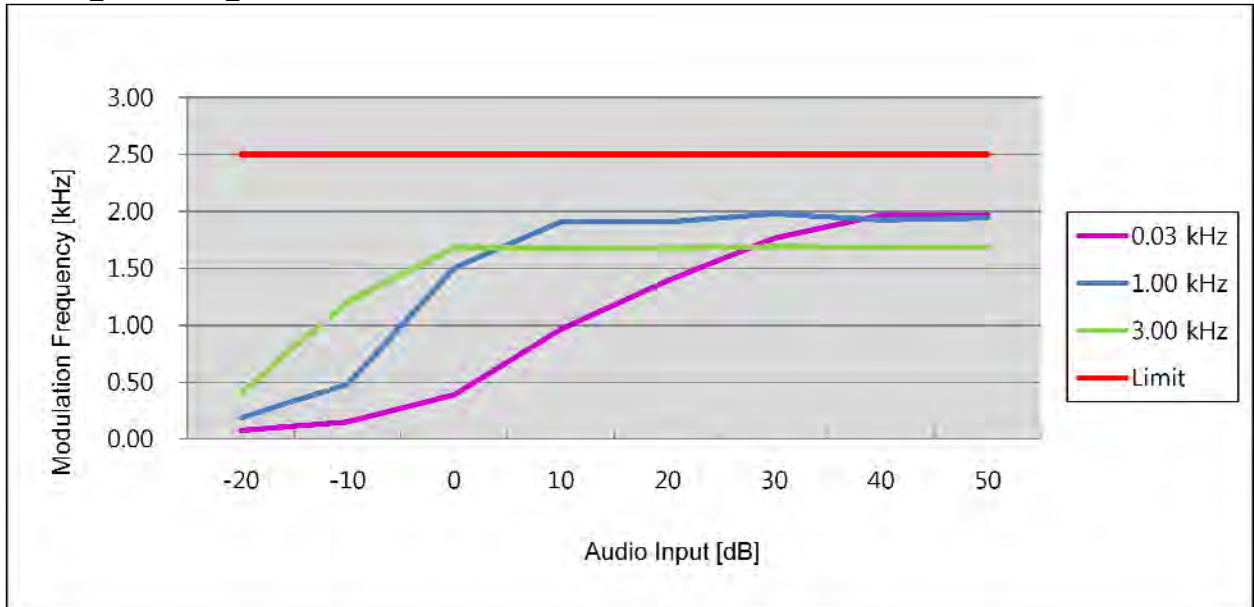

11K0F3E_481.05MHz_HIGH POWER

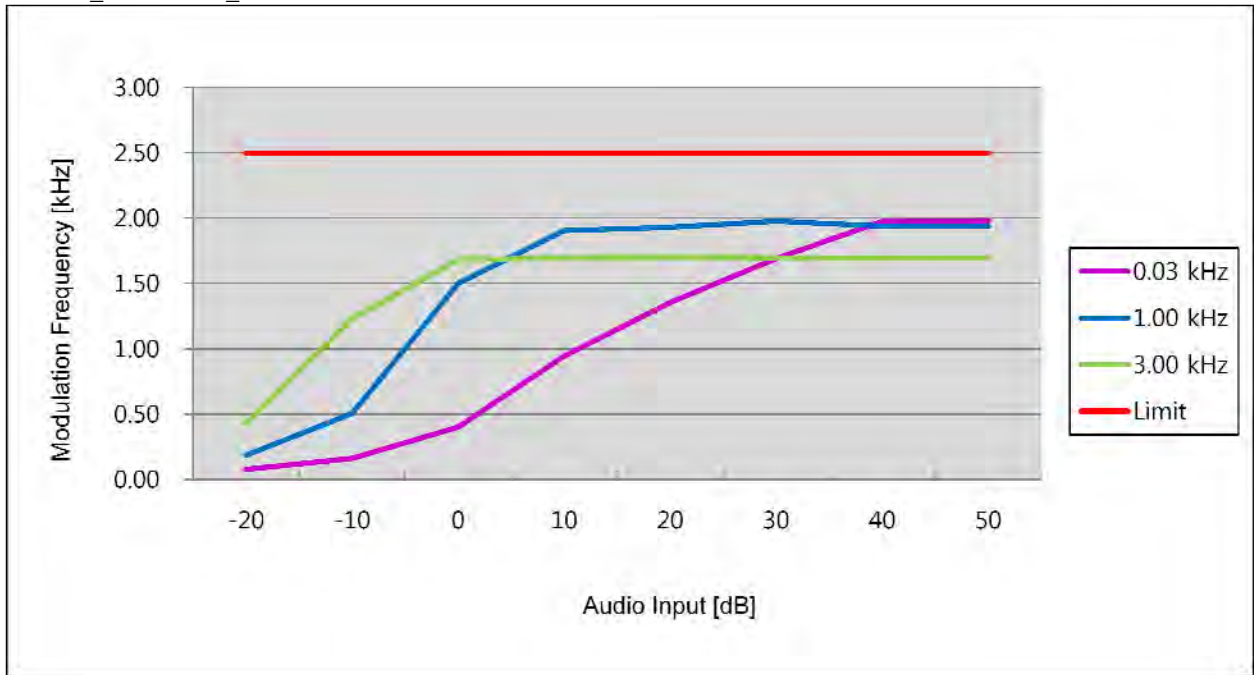

11K0F3E_511.95MHz_HIGH POWER

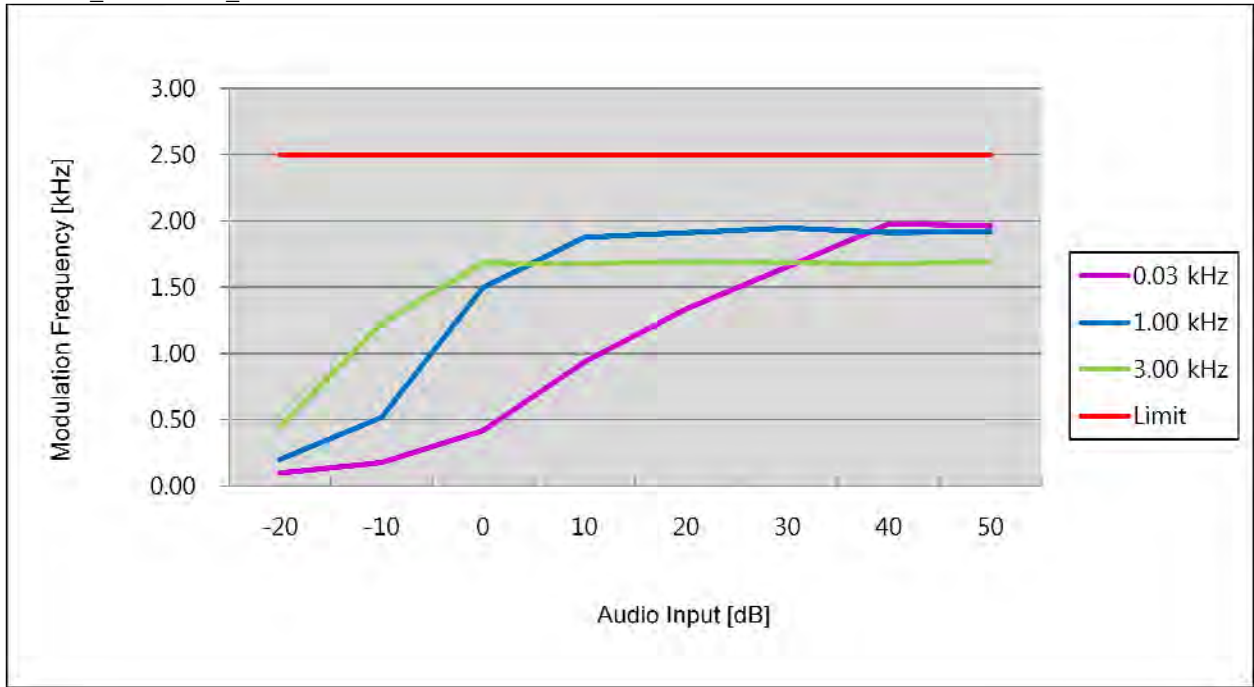

11K0F3E_450.05MHz_LOW POWER

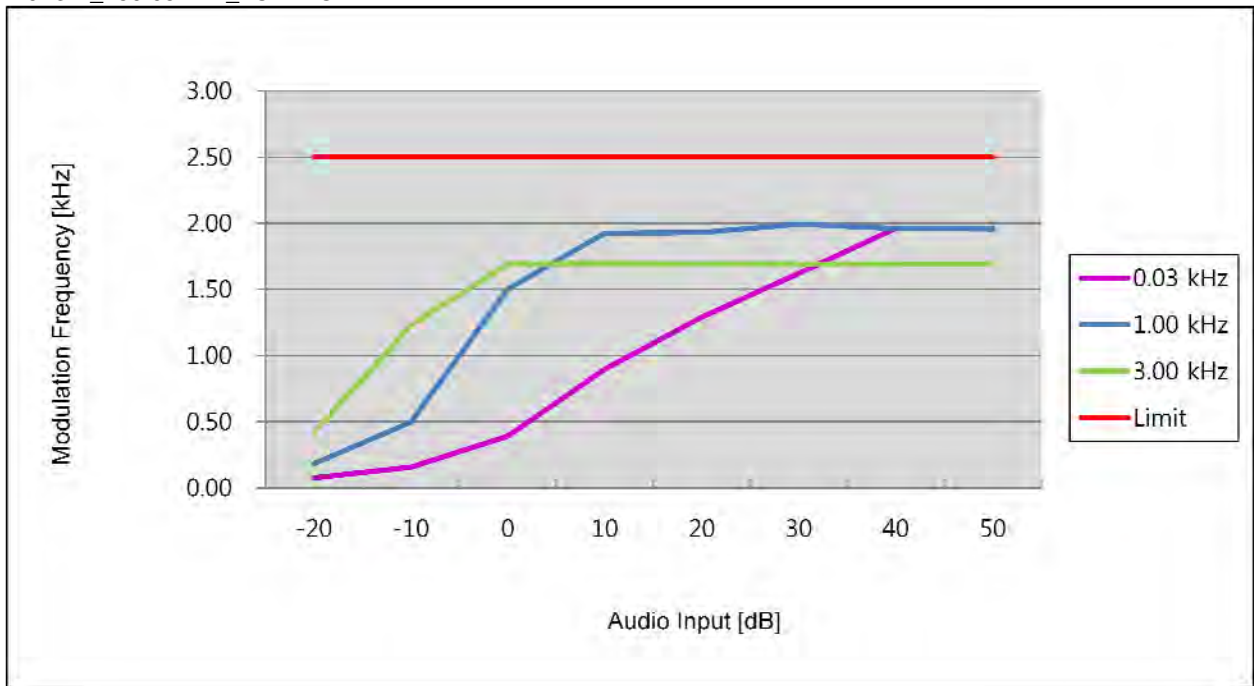

11K0F3E_481.05MHz_LOW POWER

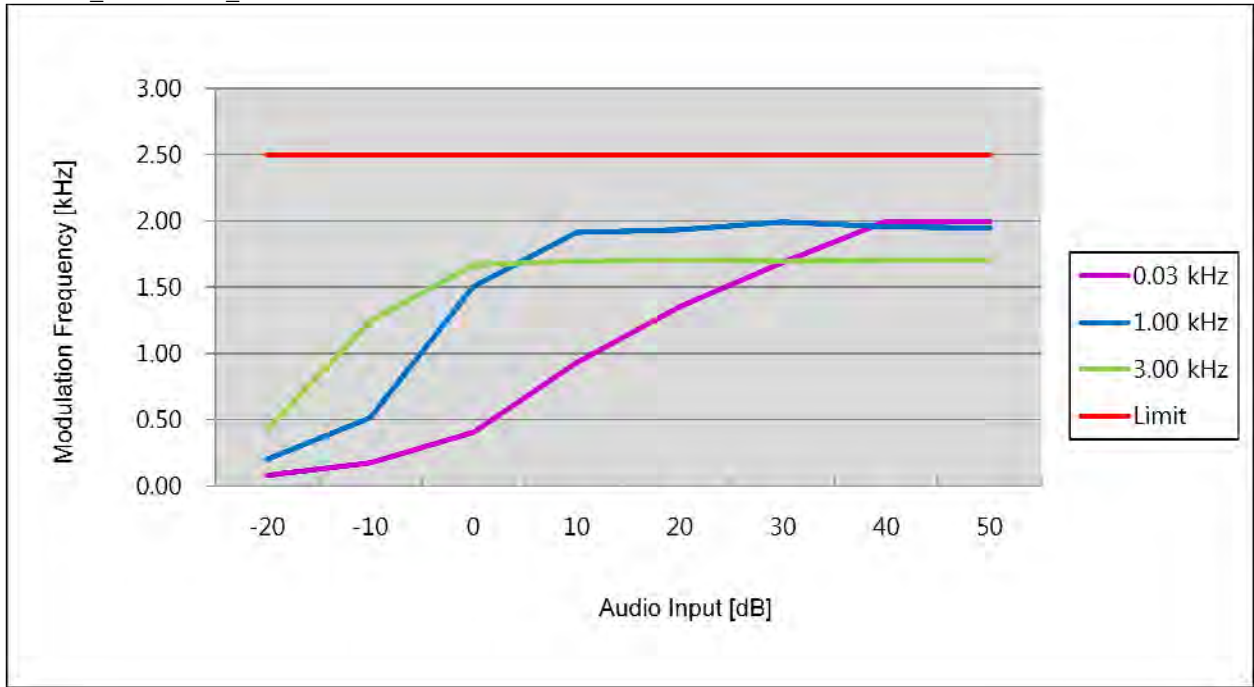

11K0F3E_511.95MHz_LOW POWER

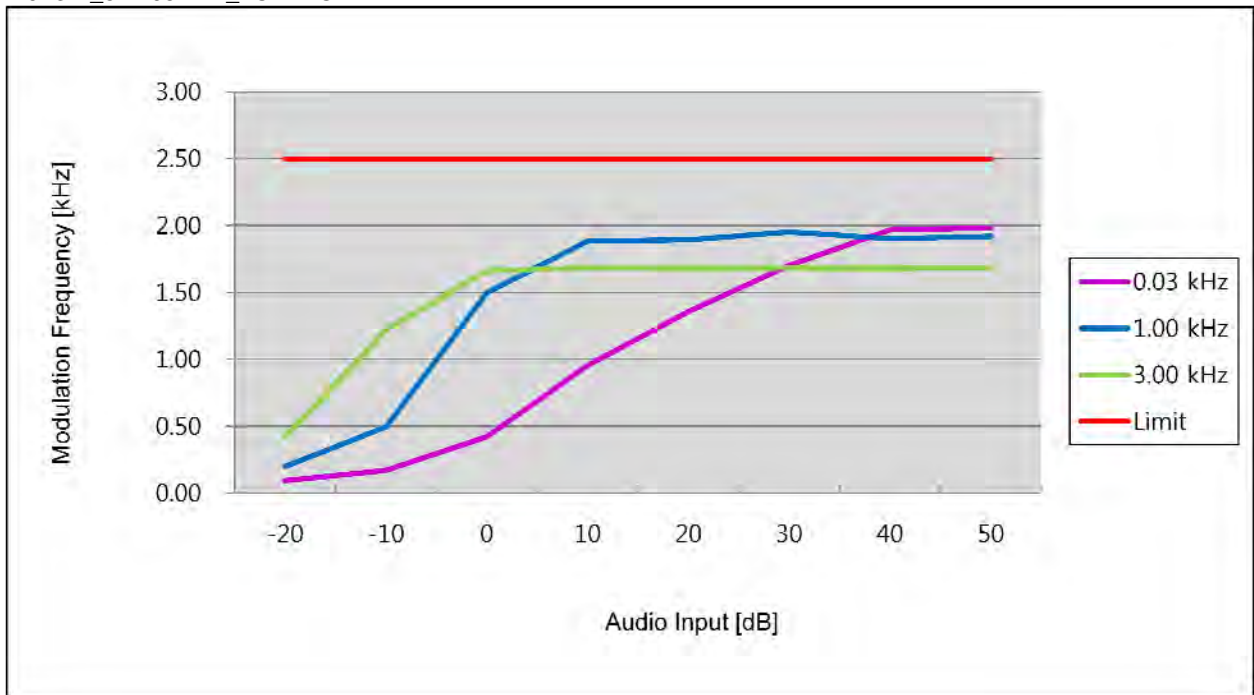

16K0F3E

Positive Peaks

16K0F3E_470.05MHz_HIGH POWER

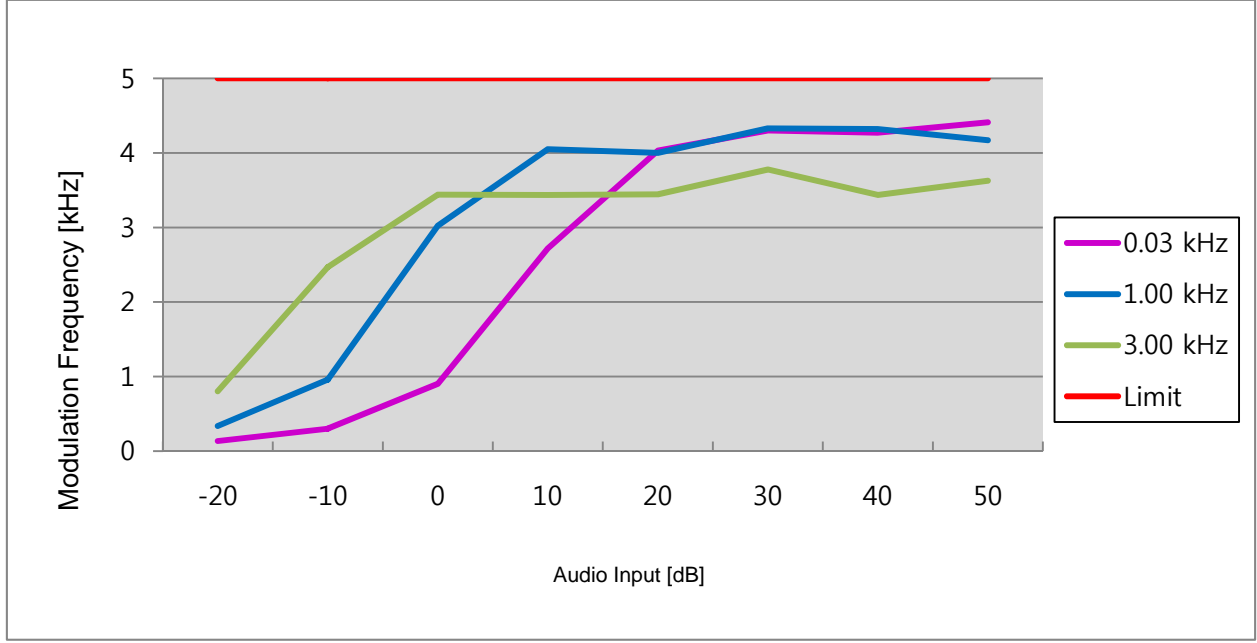

16K0F3E_491.05MHz_HIGH POWER

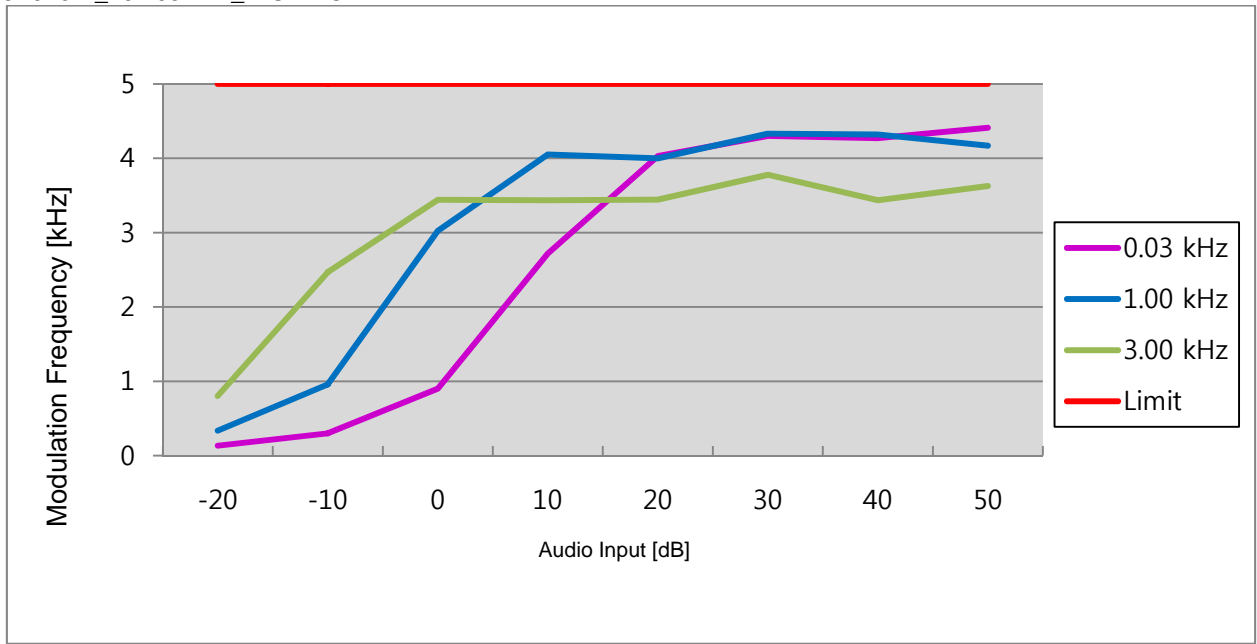

16K0F3E_511.95MHz_HIGH POWER

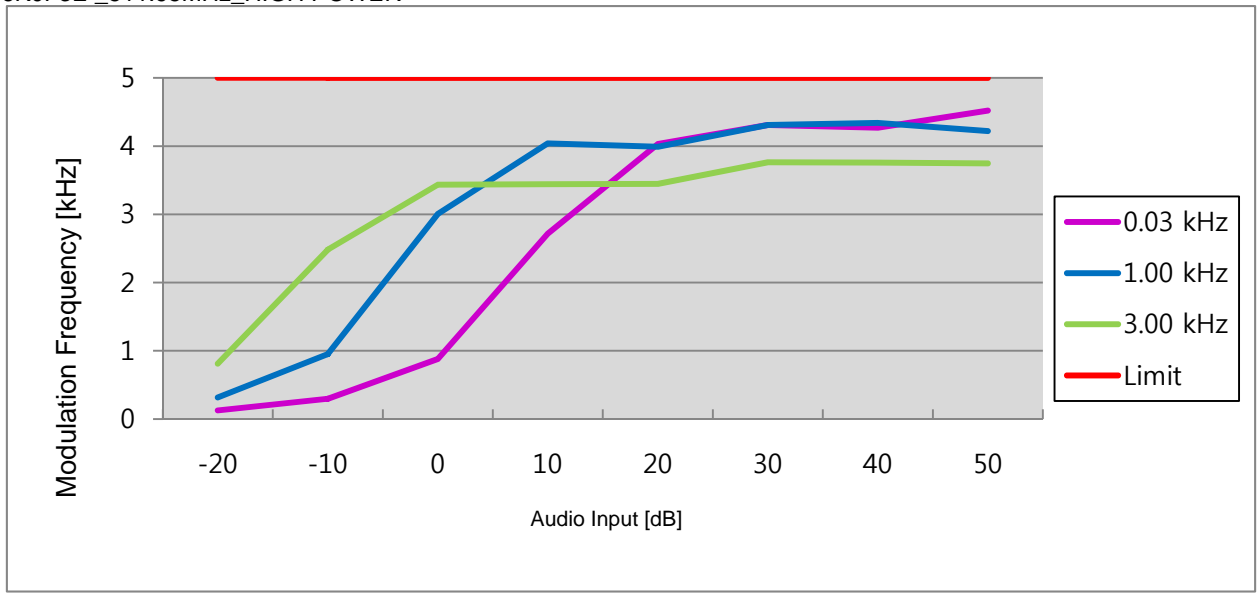

16K0F3E_470.05MHz_LOW POWER

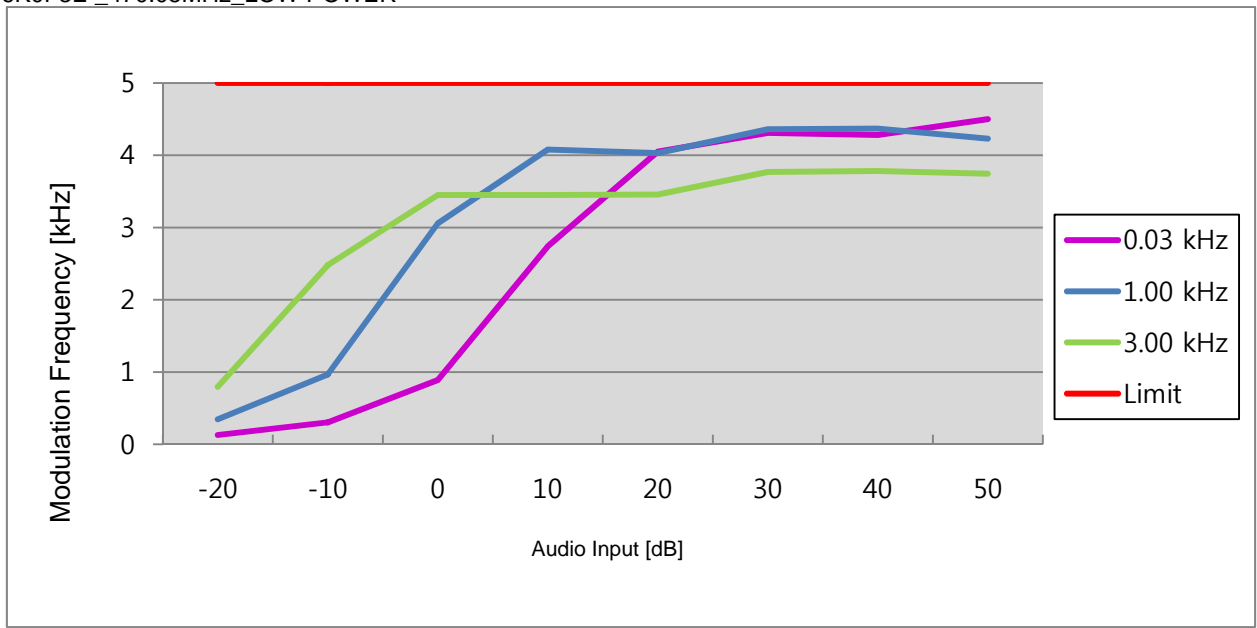

16K0F3E_491.05MHz_LOW POWER

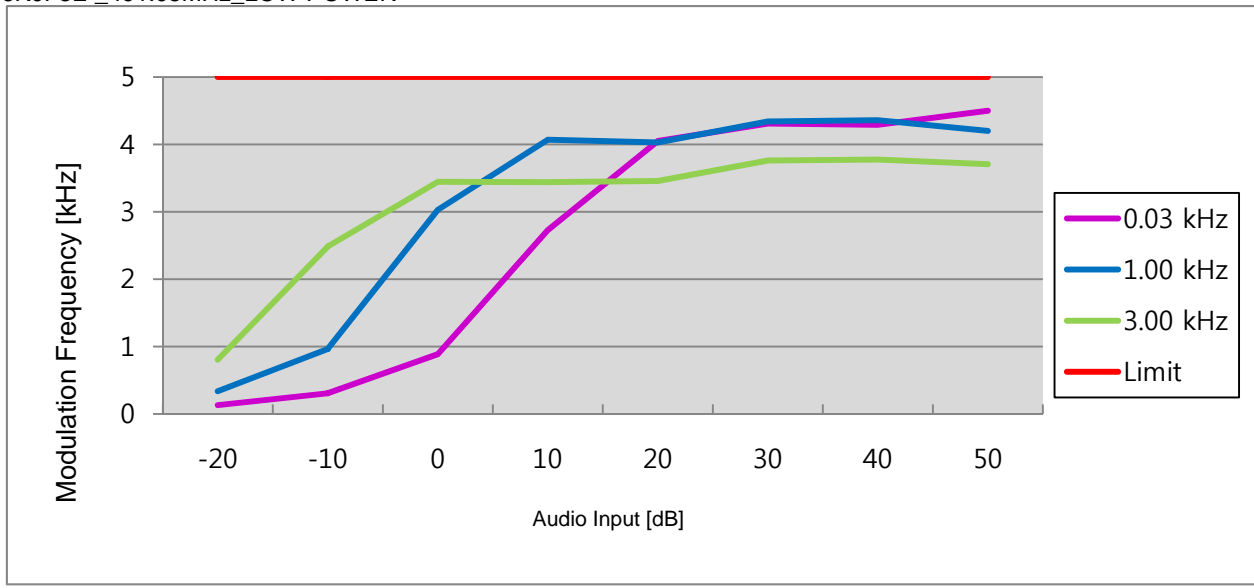

16K0F3E_511.95MHz_LOW POWER

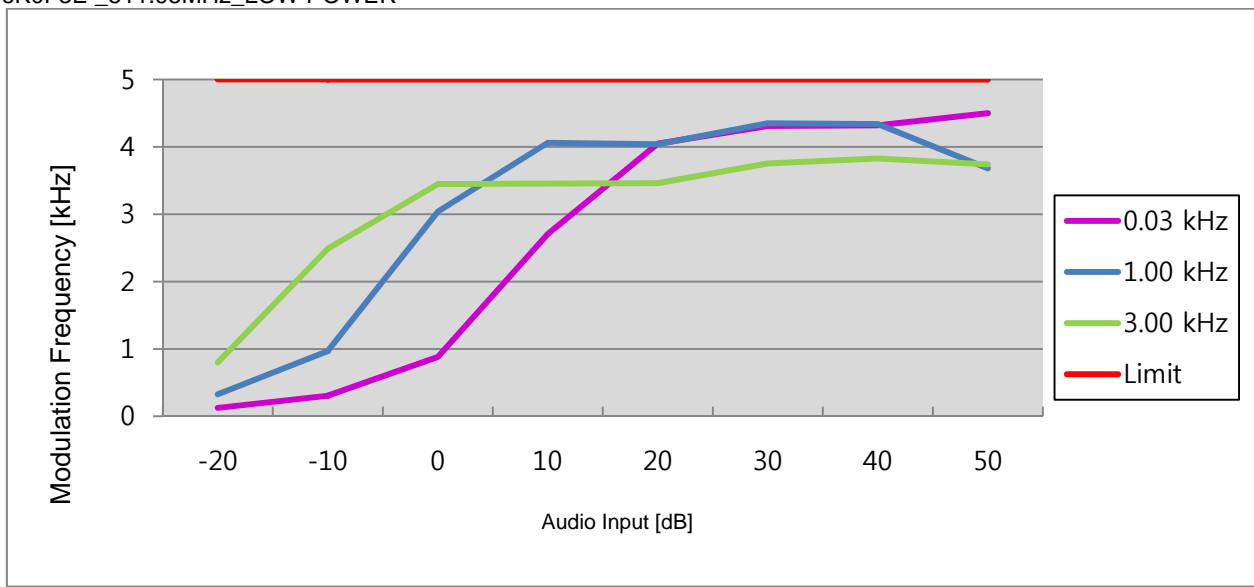

Negative Peaks

16K0F3E_470.05MHz_HIGH POWER

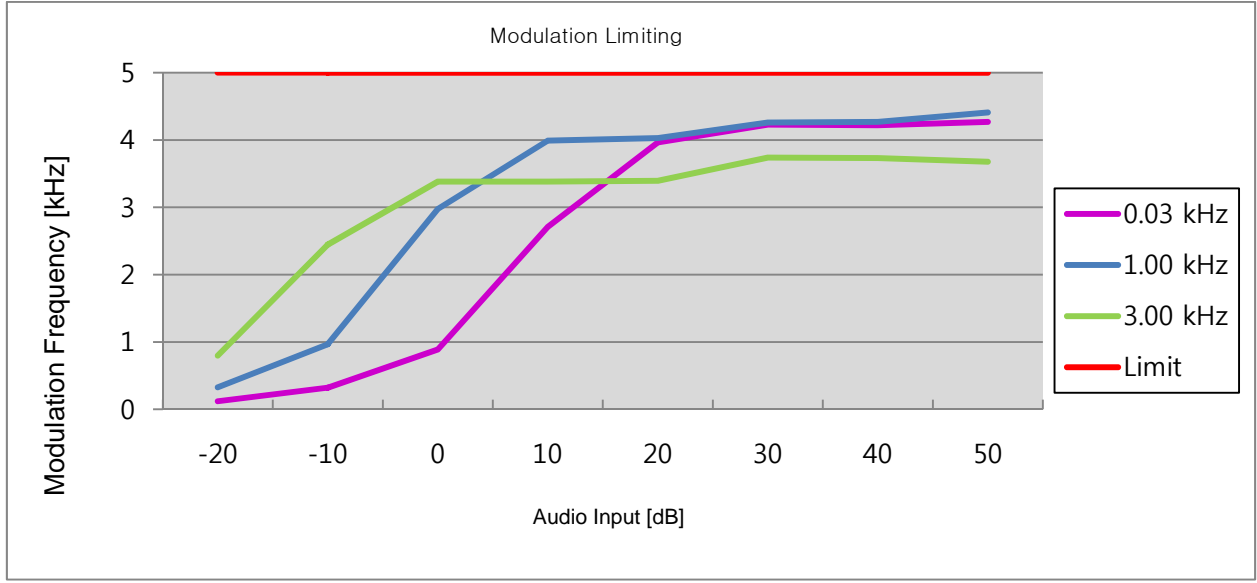

16K0F3E_491.05MHz_HIGH POWER

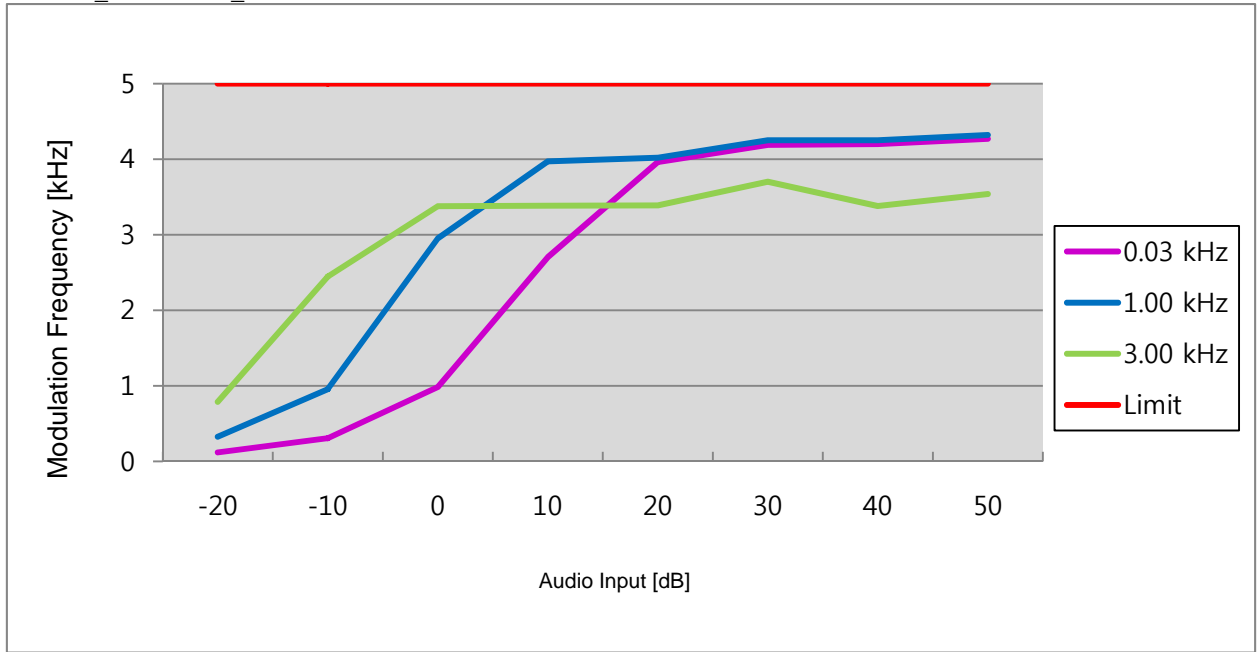

16K0F3E_511.95MHz_HIGH POWER

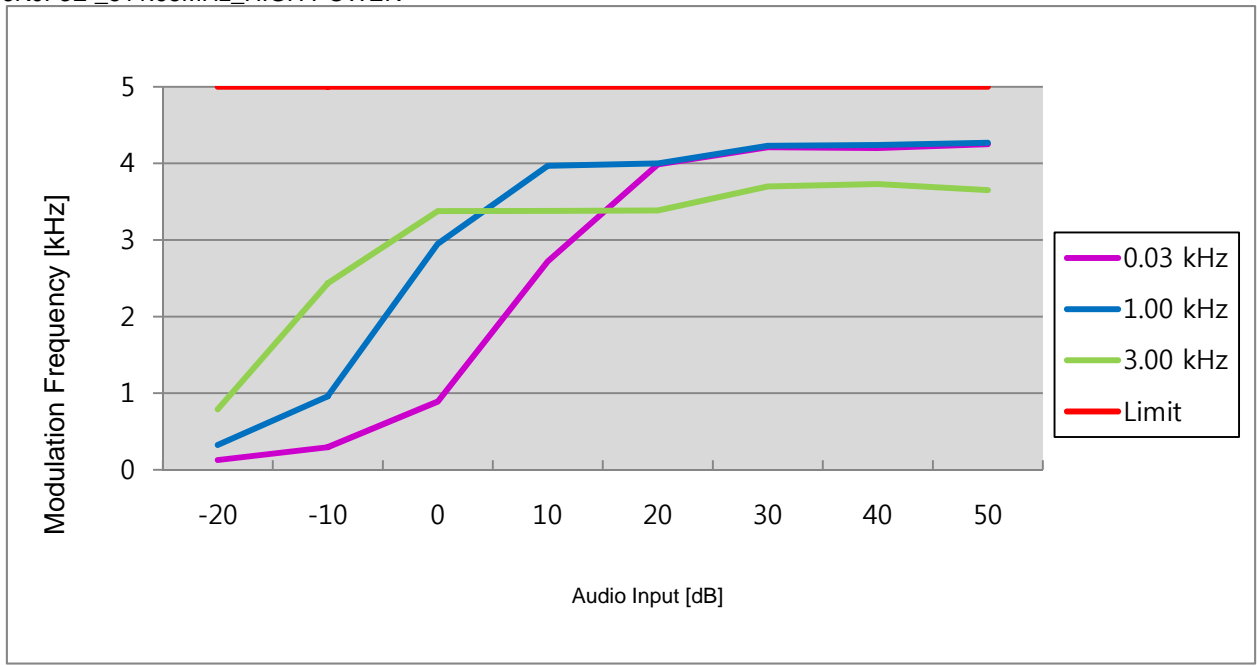

16K0F3E_470.05MHz_LOW POWER

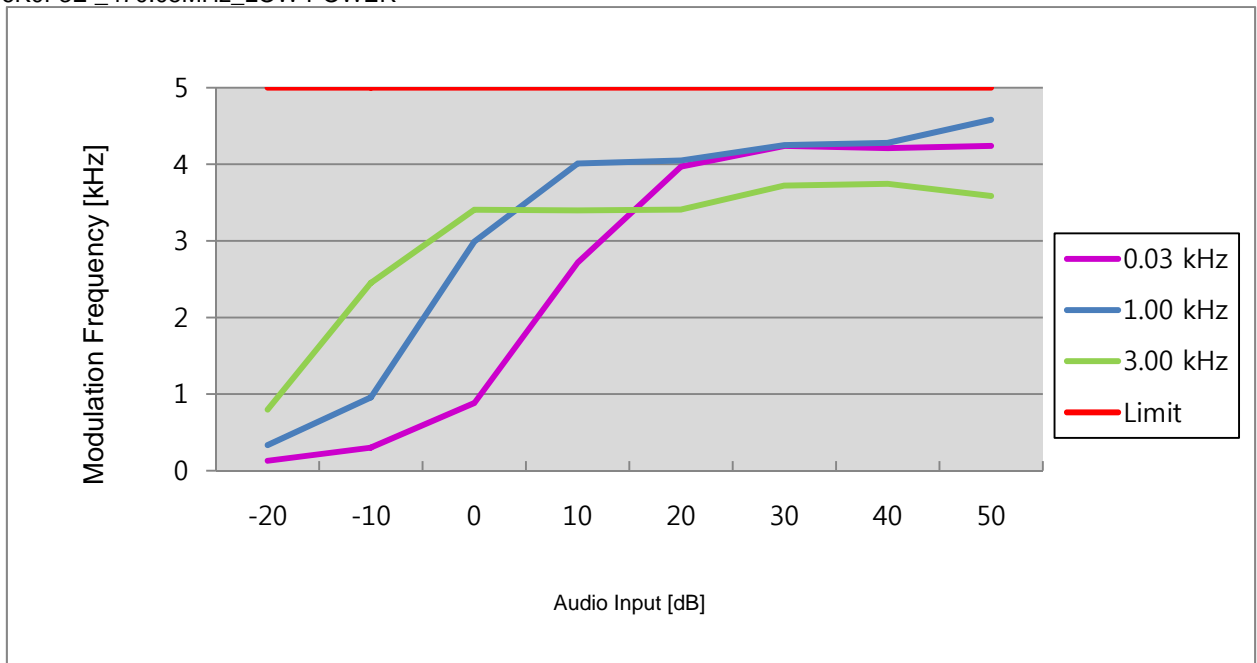

16K0F3E_491.05MHz_LOW POWER

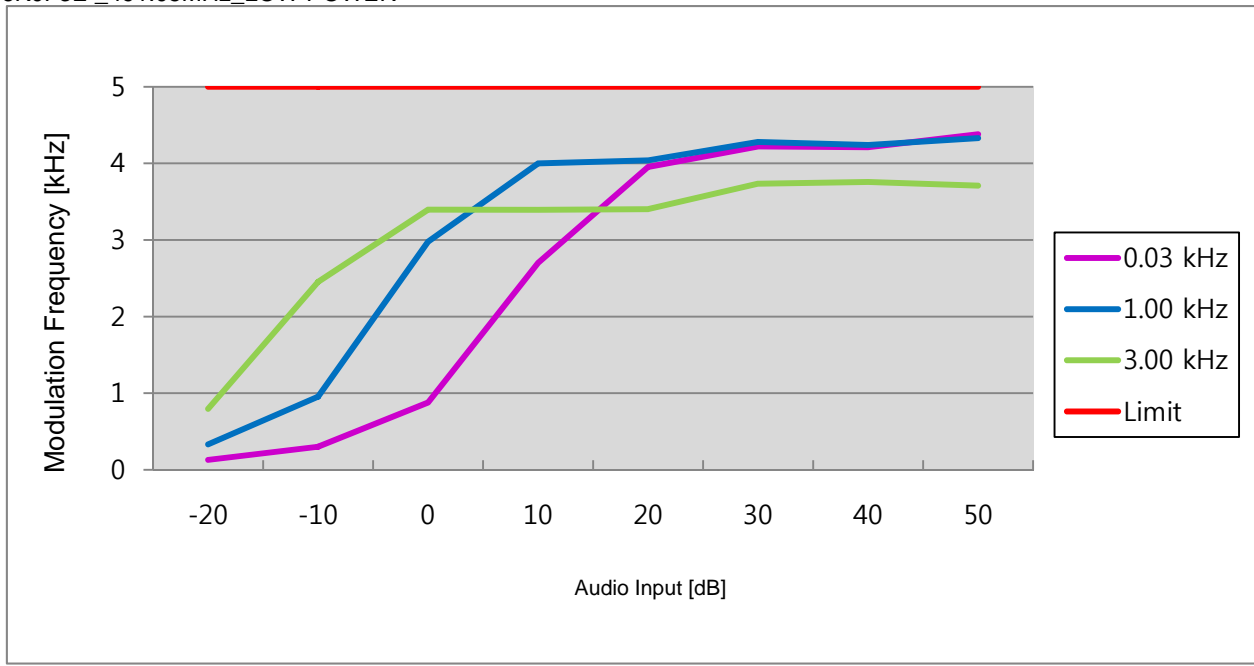

16K0F3E_511.95MHz_LOW POWER

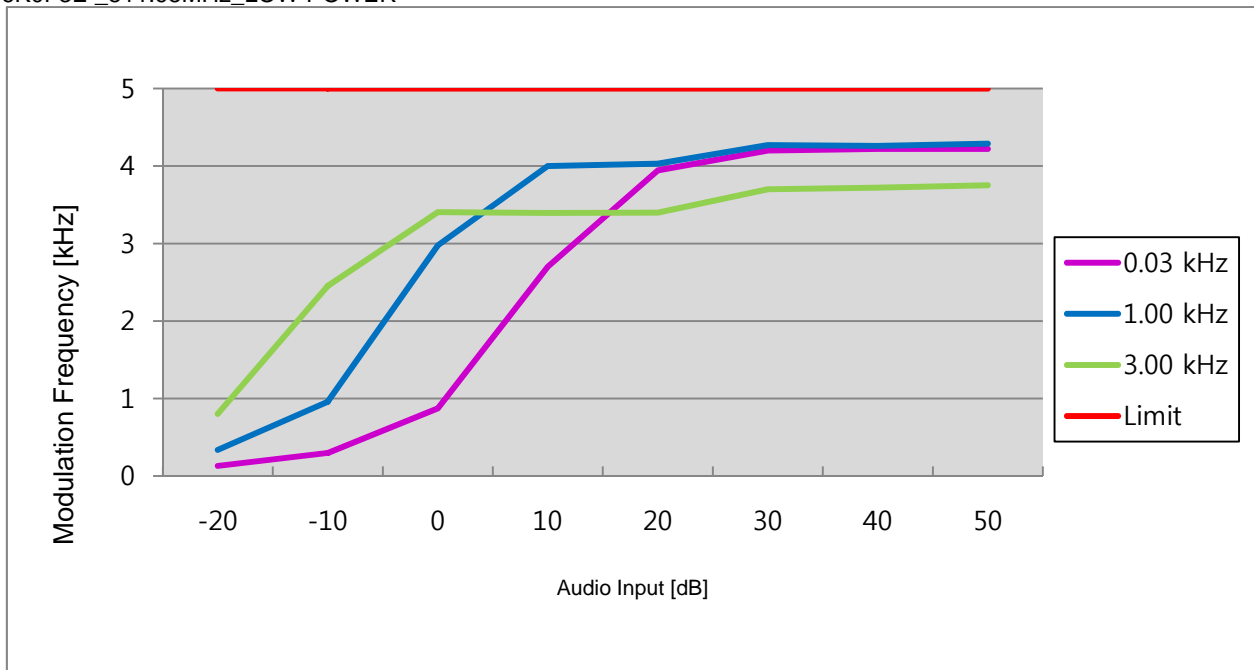

7.5 Audio Frequency Response / Audio Low Pass Filter Response

■ Definition

The audio frequency response is the degree of closeness to which the frequency deviation of the transmitter follows a prescribed characteristic.

■ TEST CONFIGURATION

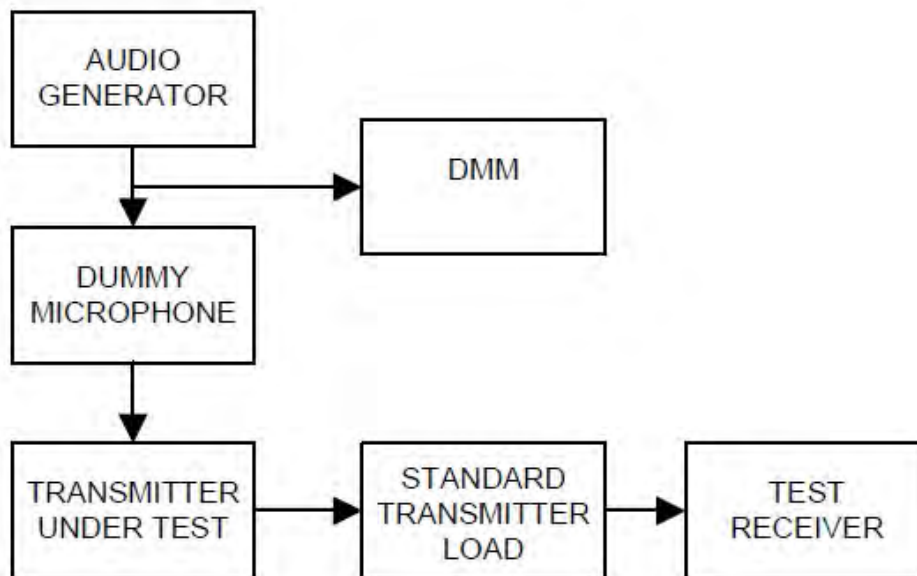

■ TEST PROCEDURE

According to 2.2.6 in TIA-603-D Standard.

- a) Connect the equipment as illustrated.
- b) Set the test receiver to measure peak positive deviation. Set the audio bandwidth for ≤ 50 Hz to $\geq 15,000$ Hz. Turn the de-emphasis function off.
- c) Set the DMM to measure rms voltage.
- d) Adjust the transmitter per the manufacturer's procedure for full rated system deviation.
- e) Apply a 1000 Hz tone and adjust the audio frequency generator to produce 20% of the rated system deviation.
- f) Set the test receiver to measure rms deviation and record the deviation reading.
- g) Record the DMM reading as V_{REF} .
- h) Set the audio frequency generator to the desired test frequency between 300 Hz and 3000 Hz.
- i) Vary the audio frequency generator output level until the deviation reading that was recorded in step f) is obtained.
- j) Record the DMM reading as V_{FREQ} .
- k) Calculate the audio frequency response at the present frequency as:
audio frequency response = $20 * \log_{10}(V_{FREQ}/V_{REF})$
- l) Repeat steps h) through k) for all the desired test frequencies.

*Note : Audio Filter of the above result is substituted with the same structure as Audio Frequency Response.

On the transmission condition below 3kHz, Transceiver shows pre-emphasis condition of transmission function.

On the transmission condition above 3kHz, Transceiver shows Audio Low Pass Filter.

▣ TEST RESULTS

11K0F3E

11K0F3E_450.05MHz_HIGH POWER

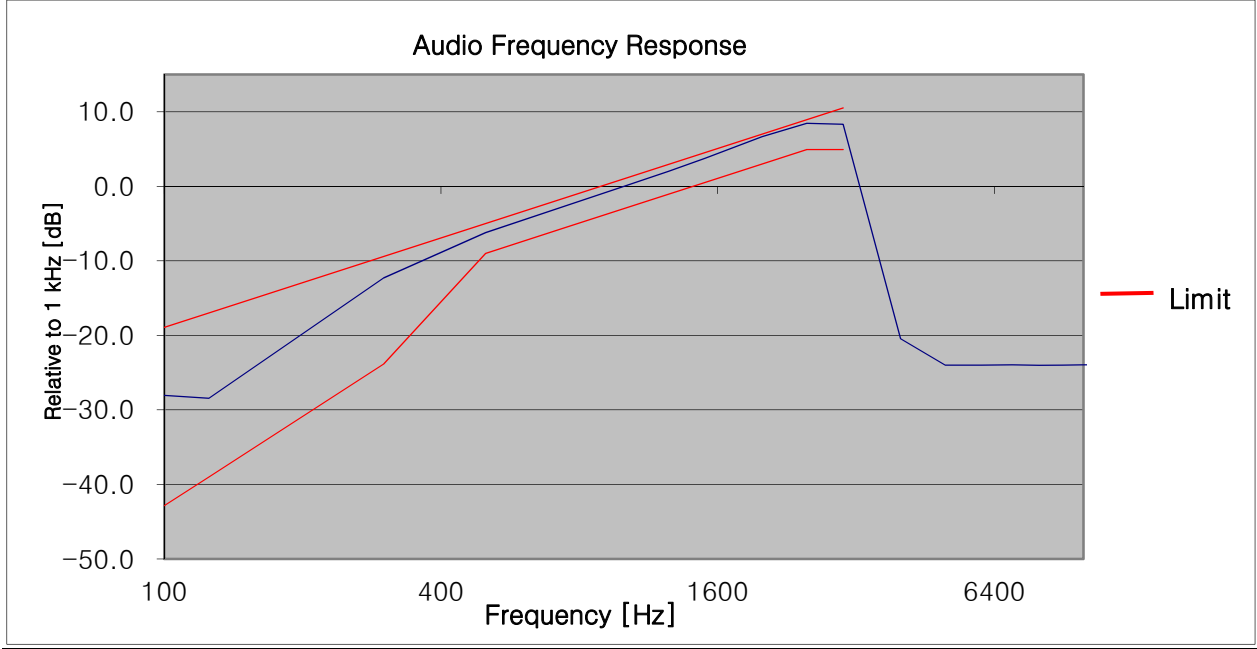

11K0F3E_481.05MHz_HIGH POWER

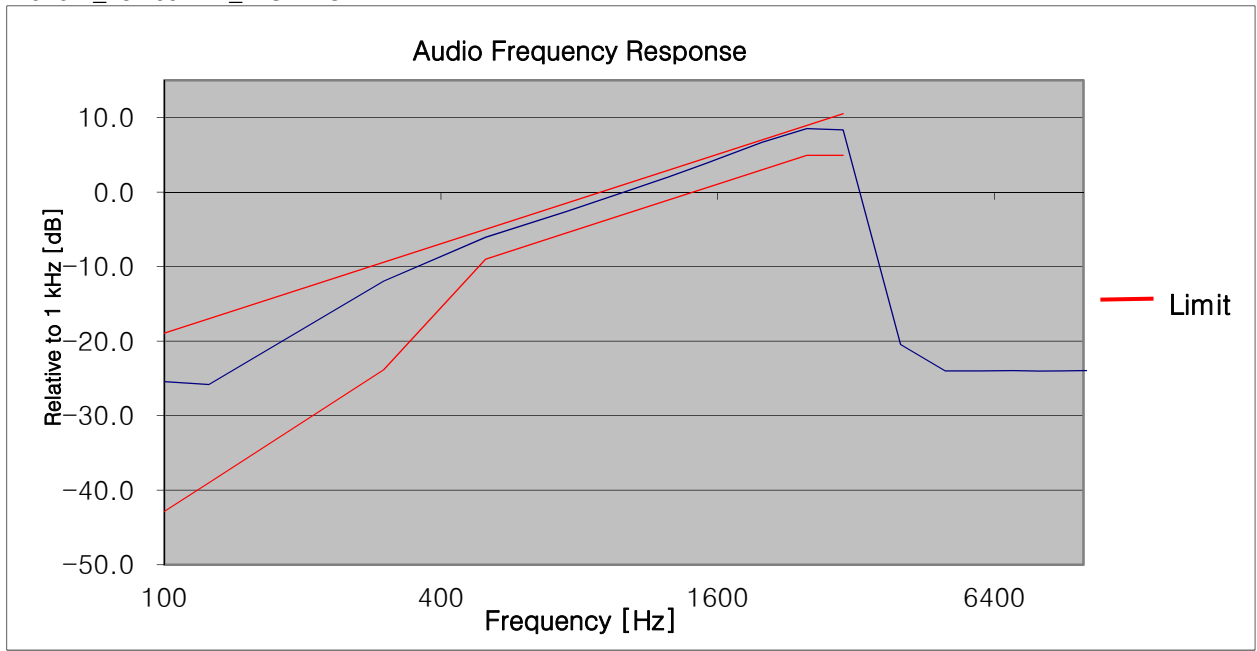

11K0F3E _511.95MHz_HIGH POWER

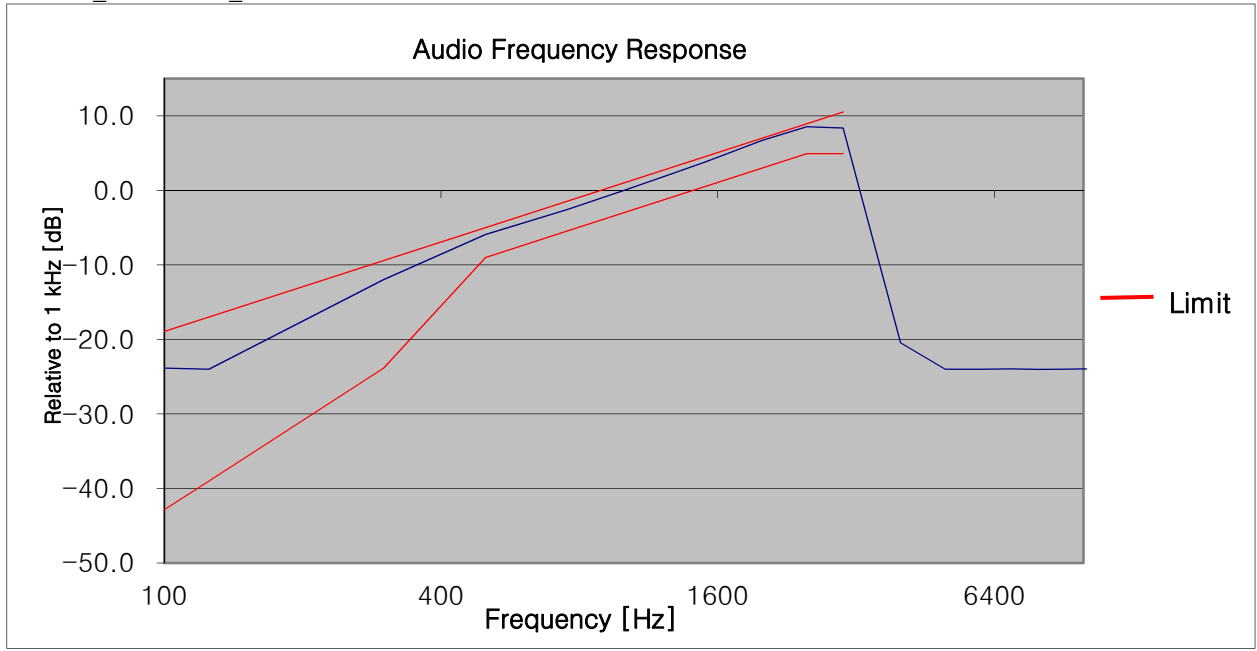

11K0F3E _450.05MHz_LOW POWER

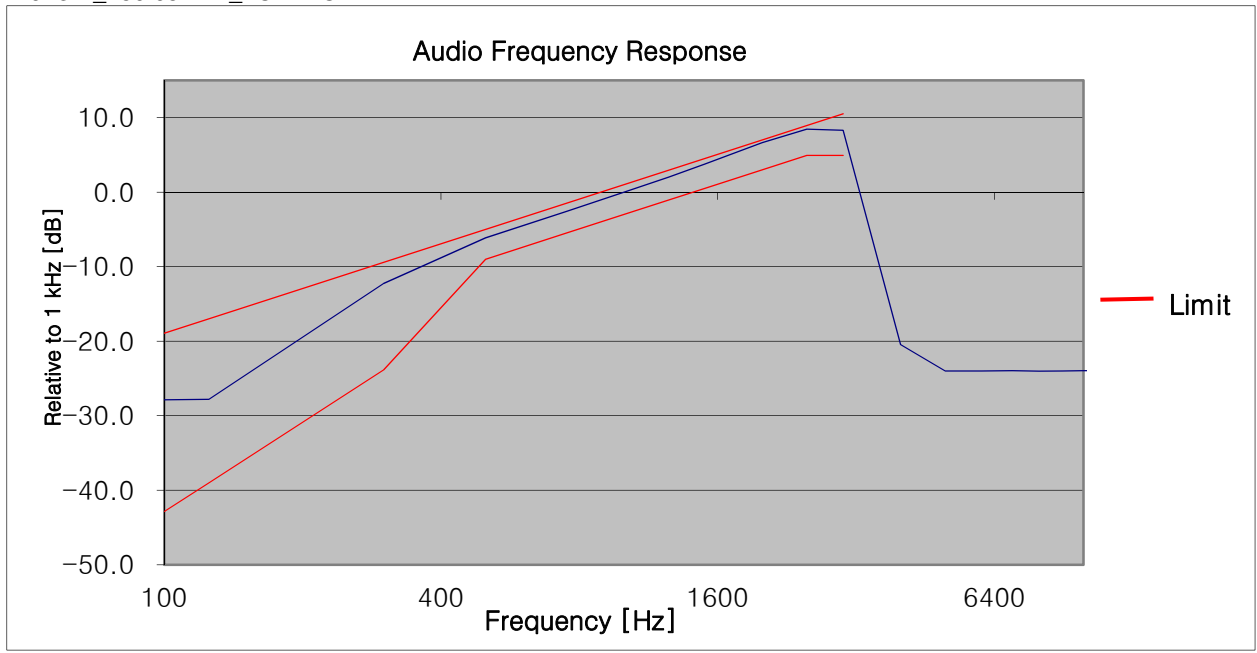

11K0F3E_481.05MHz_LOW POWER

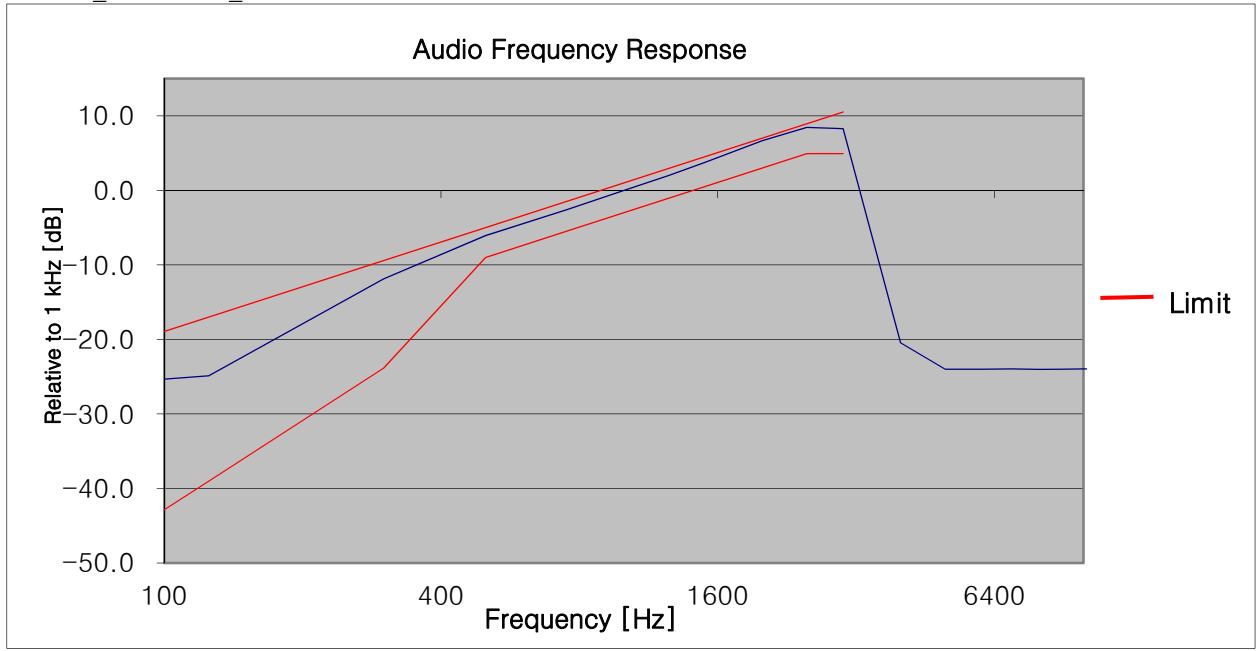

11K0F3E_511.95MHz_LOW POWER

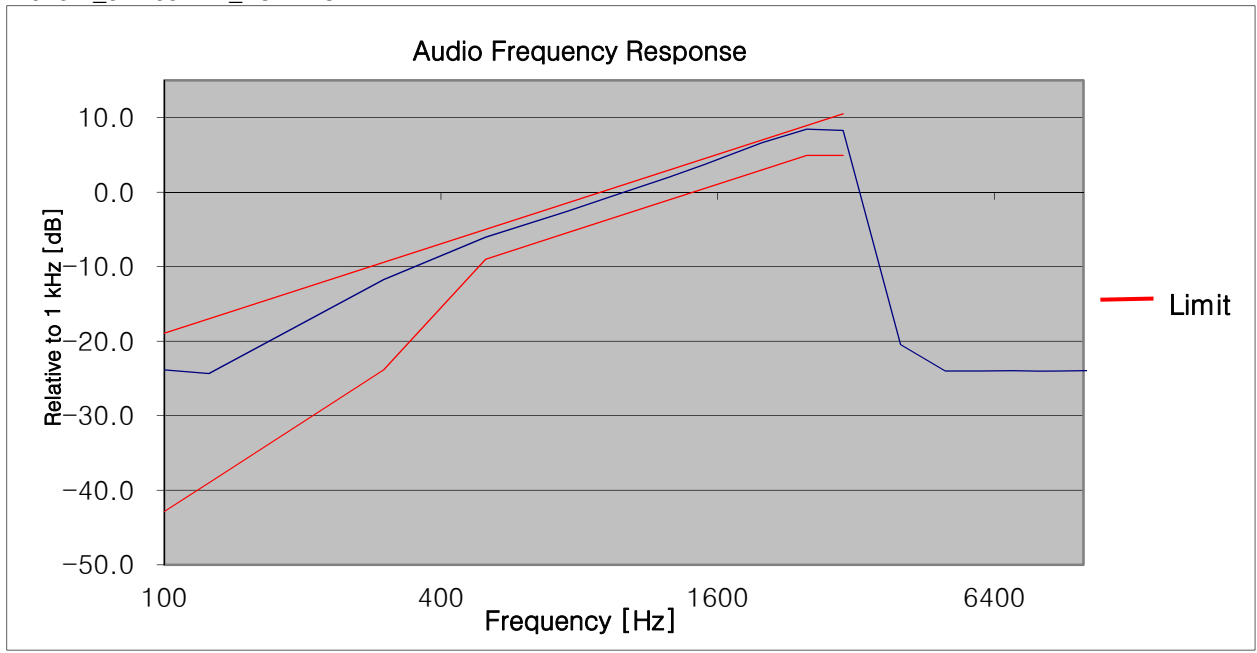

16K0F3E

16K0F3E_470.05MHz_HIGH POWER

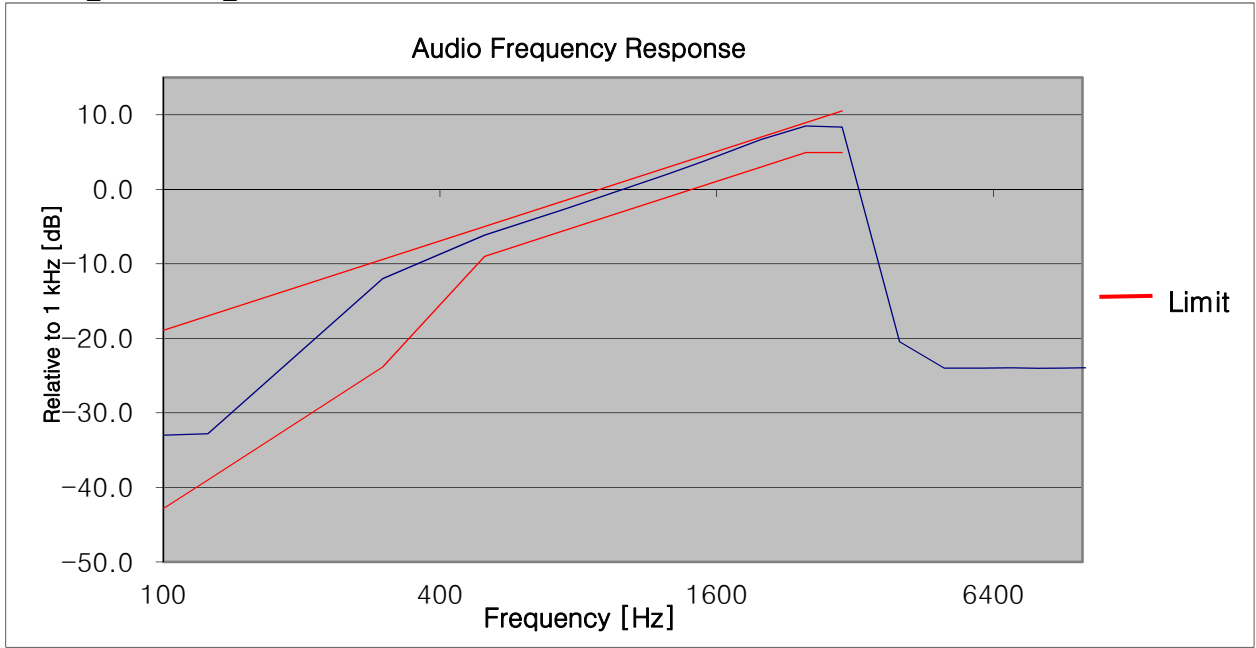

16K0F3E_491.05MHz_HIGH POWER

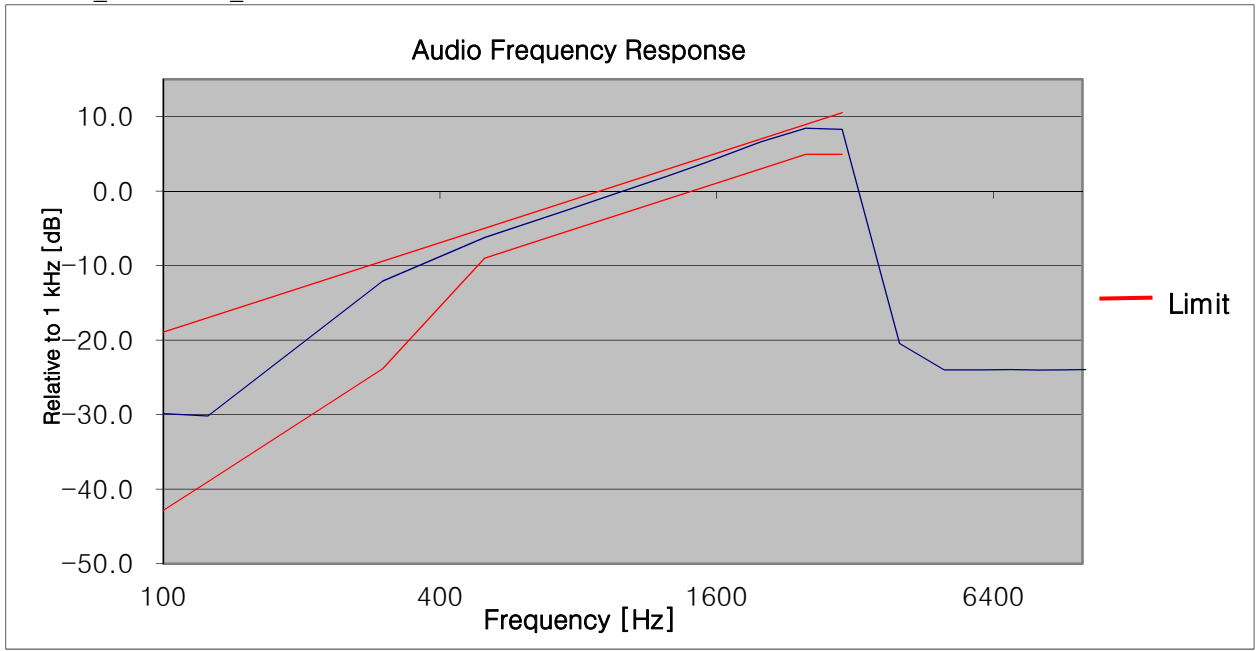

16K0F3E _511.95MHz_HIGH POWER

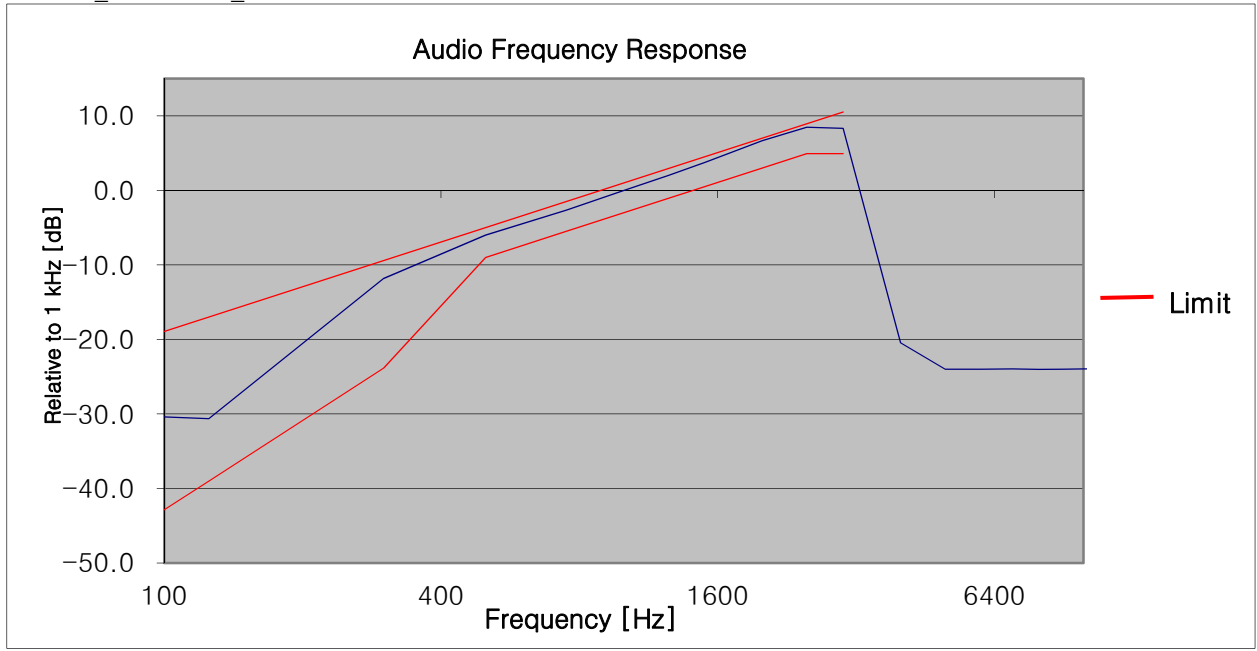

16K0F3E _470.05MHz_LOW POWER

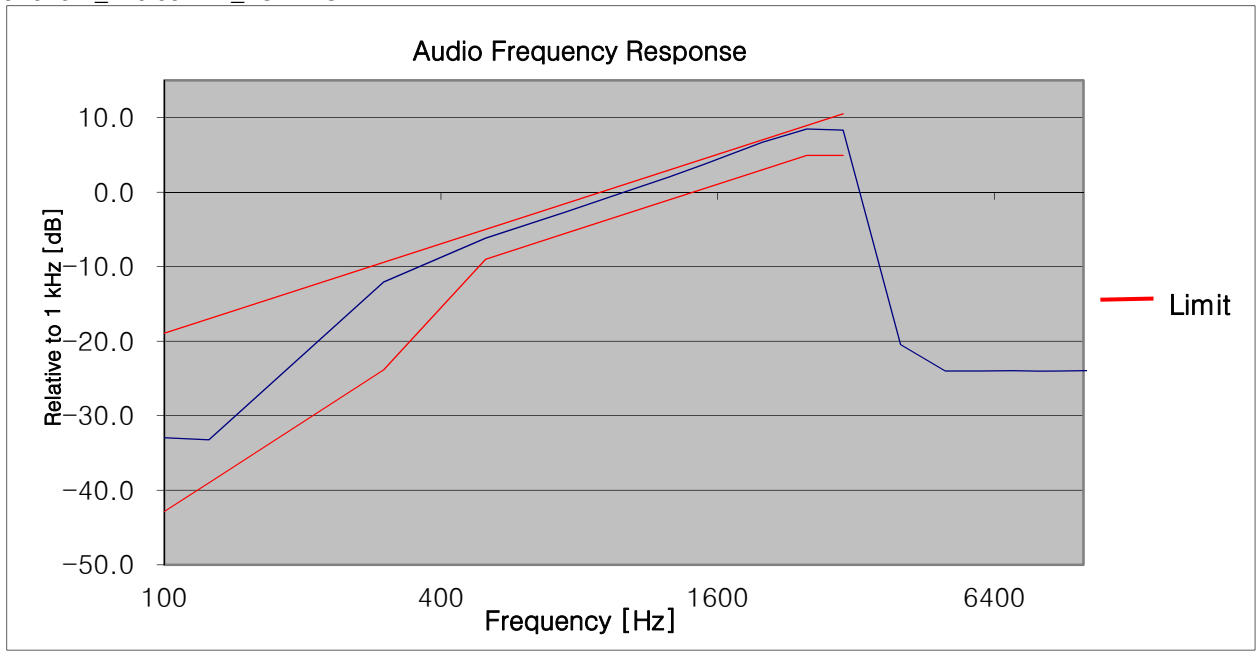

16K0F3E _491.05MHz_LOW POWER

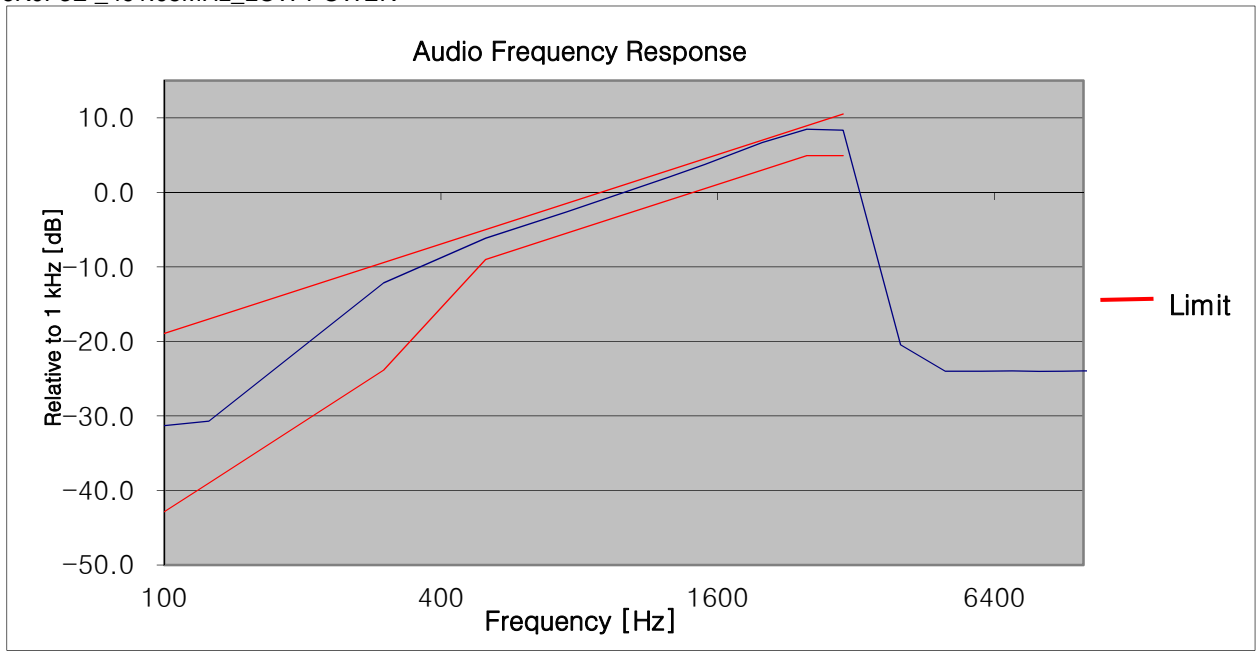

16K0F3E _511.95MHz_LOW POWER

