

TEST REPORT

REGULATIONS : **FCC Part15 C §15.247**
 RSS-247 Issue 2

Applicant	Testing Laboratory
JVC KENWOOD Corporation 1-16-2, Hakusan, Midori-ku, Yokohama-shi Kanagawa, 226-8525 Japan Tel.: +81 45 939 6254 / Fax.: +81 45 939 6261	Intertek Japan K.K. Matsuda Laboratory (Open area test site) 1283 Yadoriki, Matsuda-machi, Ashigarakami-gun, Kanagawa-ken, 258-0001 Japan Tel.: +81 465 89 2316 Fax.: +81 465 89 2160 URL: http://www.japan.intertek-etlsemko.com

Equipment Type	REMOTE CONTROL HEAD
Trademark	KENWOOD
Model(s)	KCH-20R-M
Serial No.	No.004 (for Radiated testing) No.029 (for Antenna Port Conductive testing)
FCC ID	K44473100
ISED CN and UPN	282F-473100
Test Result	Complied
Report Number	18040322JMA-002
Original Issue Date	July 11, 2018

This report is for the exclusive use of Intertek's Client and is provided pursuant to the agreement between Intertek and its Client. Intertek's responsibility and liability are limited to the terms and conditions of the agreement. Intertek assumes no liability to any party, other than to the Client in accordance with the agreement, for any loss, expense or damage occasioned by the use of this report. Only the Client is authorized to permit copying or distribution of this report and then only in its entirety. Any use of the Intertek name or one of its marks for the sale or advertisement of the tested material, product or service must first be approved in writing by Intertek. The observations and test results in this report are relevant only to the sample tested. This report by itself does not imply that the material, product, or service is or has ever been under an Intertek certification program.

Approved by 
Hideaki Kosemura
[Reviewer]

Tested by 
Naohei Murakami
[Engineer]



Responsible Party of Test Item (Product)

Responsible Party	:
Add.	:
Tel.	:
Fax.	:
Contact Person	:

TABLE OF CONTENTS

	Page
SECTION 1. GENERAL INFORMATION	3
SECTION 2. SUMMARY OF TEST RESULTS	4
SECTION 3. EQUIPMENT UNDER TEST	5
SECTION 4. SUPPORT EQUIPMENT	6
SECTION 5. USED CABLE(S)	7
SECTION 6. TEST CONFIGURATION	8
SECTION 7. OPERATING CONDITION	9
SECTION 8. UNCERTAINTY	11
SECTION 9. TEST DATA	12
9.1 6 dB Bandwidth and 99 % Occupied Bandwidth	12
9.2 Maximum Peak Output Power	13
9.3 Radiated Spurious Emissions and Band Edge of Restrict Band	14
9.4 Band Edge of Authorized Frequency Band	18
9.5 Spurious RF Conducted Emissions	20
9.6 Power Density	21
9.7 AC Conducted Emissions	22
9.8 Receiver Spurious Emissions	25
SECTION 10. LIST AND DIAGRAM OF MEASURING INSTRUMENTS	26
ANNEX	32
A. HARD COPY OF SPECTRUM PLOTS	33
B. PHOTOGRAPHS OF EMISSION SET-UP	49
C. PHOTOGRAPHS OF EUT Axis	54

SECTION 1. GENERAL INFORMATION

Test Performed

EUT Received	May 15, 2018	
Date of Test	From May 16, 2018 to July 9, 2018	
Standard Applied	FCC	ISED
	FCC Part15 C §15.247	RSS-247 Issue 2
Test methods	KDB 558074 D01 DTS Meas Guidance v04	RSS-Gen Issue 5 ANSI C63.10-2013
Deviation from Standard(s)	None	

Qualifications of Testing Laboratory (Matsuda Lab.)

Accreditation	Scope	Lab. Code	Remarks
VLAC	EMC Testing	VLAC-008-3	JAPAN
BSMI	EMC Testing	SL2-IN-E-6009	TAIWAN
Filing			
VCCI	EMC Testing	A-0127	JAPAN
FCC	EMC Testing	Designation Number : JP0009	USA
IC	EMC Testing	2042S-1, 2042S-2, 2042S-3, 2042S-4	Canada
CB-Scheme	EMC Testing	TL223	IECEE
SAUDI ARABIA	EMC Testing	N/A	

Abbreviations

EUT	Equipment Under Test	DoC	Declaration of Conformity
AMN	Artificial Mains Network	ISN	Impedance Stabilization Network
LISN	Line Impedance Stabilization Network	Q-P	Quasi-peak
AMP	Amplifier	AVG	Average
ATT	Attenuator	PK	Peak
ANT	Antenna	Cal	Calibration
BBA	Broadband Antenna	N/A	Not applicable or Not available
DIP	Dipole Antenna	LCD	Liquid-Crystal Display
AE	Associated Equipment	HDMI	High-Definition Multimedia Interface
AFH	Adaptive Hopping Frequency		

SECTION 2. SUMMARY OF TEST RESULTS

Test Item	Specification	Results	Detail
6 dB Bandwidth and 99 % Occupied Bandwidth	FCC Part15C §15.247 (a) (2) RSS-247 5.2 (a) RSS-Gen 6.7	PASS	Section 9.1
Maximum Peak Output Power	FCC Part15C §15.247 (b) RSS-247 5.4 (d)	PASS	Section 9.2
Radiated Spurious Emissions and Restrict Band edge	FCC Part15C §15.209, §15.205 RSS-247 5.5 RSS-Gen 8.9	PASS	Section 9.3
Band Edge of Authorized Frequency Band	FCC Part15C §15.247 (d) RSS-247 5.5	PASS	Section 9.4
Spurious RF Conducted Emissions	FCC Part15C §15.247 (d) RSS-247 5.5	PASS	Section 9.5
Power Density	FCC Part15C §15.247 (e) RSS-247 5.2	PASS	Section 9.6
AC Conducted Emissions	FCC Part15C §15.207 RSS-Gen 8.8	PASS	Section 9.7
Receiver Spurious Emissions	RSS-Gen 7	PASS	Section 9.8

The test result of this report is effective equipment under test itself and under the test configuration described on the report.

This test report does not assure that whether the test result taken in other testing laboratory is compatible or reproducible to the test result on this report or not.

SECTION 3. EQUIPMENT UNDER TEST

The equipment under test (EUT) consisted of the following apparatus.

3.1 System Configuration

Symbol	Item	Model No.	Serial No.	Manufacturer
A	REMOTE CONTROL HEAD	KCH-20R-M	No.004 (for Radiated testing) No.029 (for Antenna Port Conductive testing)	JVC KENWOOD Corporation
Rated Power : DC13.6 V +/- 15 %, 0.6 A				
Supplied Power : DC13.6 V				
Condition of Equipment		Prototype		
Type		Mobile type		
Suppression Devices		No Modifications by the laboratory were made to the device		

3.2 Port(s)/Connector(s)

Port Name	Connector Type	Connector Pin	Remarks
Separate I/F	W to B Connector	16 pin	-
Accessory I/F	W to B Connector	13 pin	-
Microphone	RJ-45	8 pin	-
SD Card Slot	Micro SD Card Slot	8 pin	-

3.3 Highest Frequency Generated / Used

Operating Frequency	Board Name	Remarks
4960 MHz	Generated / Bluetooth	-

3.4 Over View of EUT

Access method	Bluetooth Version 4.0 LE
Rated Output Power	2.5 mW
Frequency Range of Operating	2402 – 2480 MHz
Number of Channels	40 ch, 2 MHz step
Modulation Method	GFSK
Antenna Type and Gain	Integrated Printed Antenna, 4.24 dBi See Note 1
Antenna Connector	None

Note:

- The EUT comply with the requirement of FCC Part15C §15.203, because
 - The antenna was built in the EUT and permanently attached.
 - There were no other antenna connectors.

SECTION 4. SUPPORT EQUIPMENT

The EUT was supported by the following equipment during the test.

Symbol	Item	Model No.	Serial No.	Manufacturer	FCC/IC ID
B	Microphone with 12-Keypad	KMC-36	No.02	JVC KENWOOD Corporation	N/A
C	EXTERNAL MIC KIT	KCT-73MIC	12	JVC KENWOOD Corporation	N/A
D	EXTERNAL PTT KIT	KCT-74PTT	12	JVC KENWOOD Corporation	N/A
E	External Speaker	KES-5	No.1	JVC KENWOOD Corporation	N/A
F	Micro SD Card	MMG01GCCA	None	SAMSUNG	N/A
G	PANEL SEPARATE KIT	KRK-15B	No.58	JVC KENWOOD Corporation	N/A
H	VHF DIGITAL TRANSCEIVER	NX-5700-K	EX-4712	JVC KENWOOD Corporation	FCC ID: K44471100 IC: 282F-471100
I	DC Power Supply	PAD55-3L	28091953	KIKUSUI	N/A
J	DC Power Supply	PS-60	11/01 00142	KENWOOD	N/A
Supplied Power:					
H	DC13.6 V				
I, J	AC120 V, 60 Hz				

SECTION 5. USED CABLE(S)

The following cable(s) was used for the test.

No.	Name	Length (m)	Shield	Metal Connector	Ferrite Core
1	KCT-71 (REMOTE CONTROL CABLE)	7.60	Yes	No	-
2	KCT-72 (CONNECTION CABLE)	0.30	Yes	No	-
3	MIC (B) Cable	0.55	No	No	-
4	MIC (C) Cable	3.00	No	No	-
5	PTT Cable	2.80	No	No	-
6	Speaker Cable	2.80	No	No	-
7	DC cable	0.30	No	No	-
8	DC cable	3.40	No	No	-
9	Power cable for DC Power Supply (I)	2.00	No	No	-
10	Power cable for DC Power Supply (J)	2.20	No	No	-

SECTION 6. TEST CONFIGURATION

6.1 Radiated Spurious Emissions (Below 30 MHz) and AC Conducted Emissions

* : EUT
□ : Joint

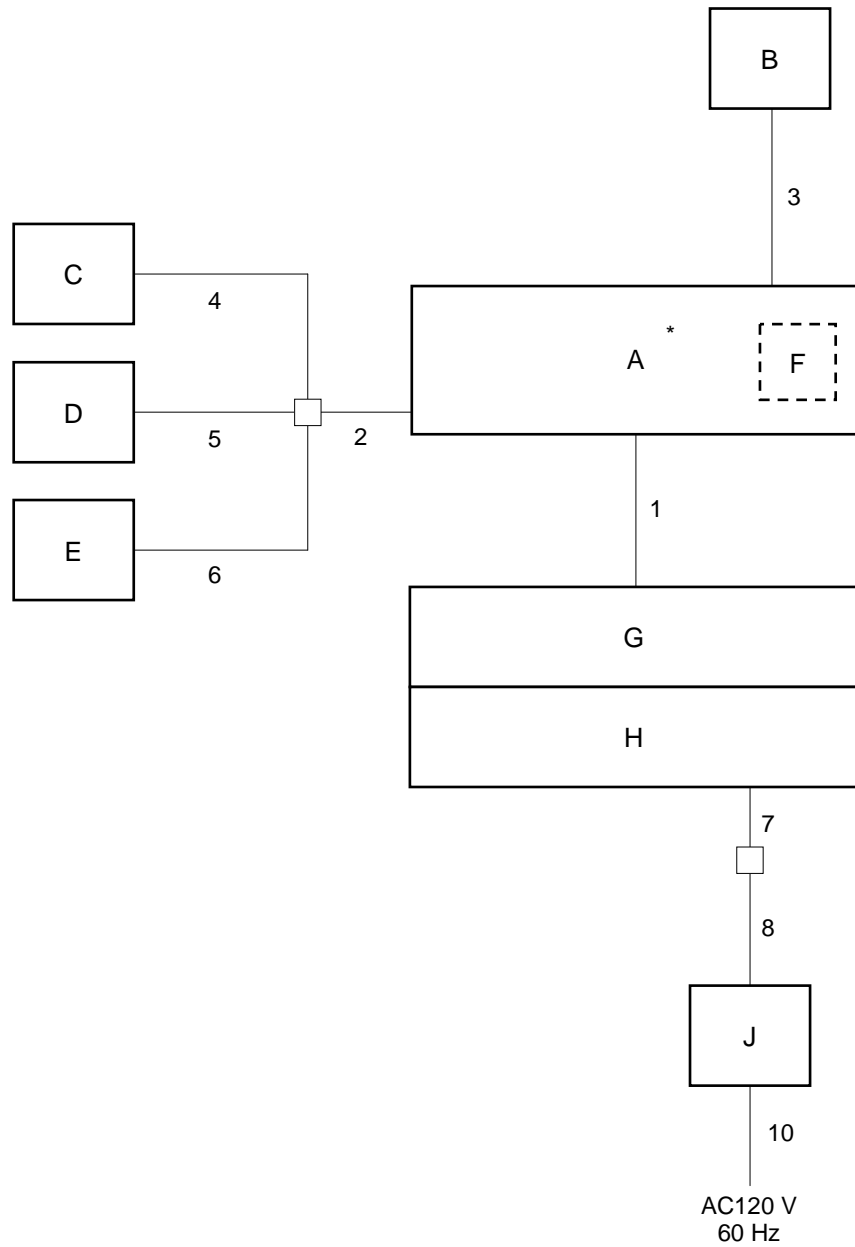

The symbols and numbers assigned to the equipment and cables on this diagram correspond to the ones in Sections 3 to 5.

6.2 Radiated Spurious Emissions (30 -1000 MHz and above 1 GHz)

* : EUT
□ : Joint

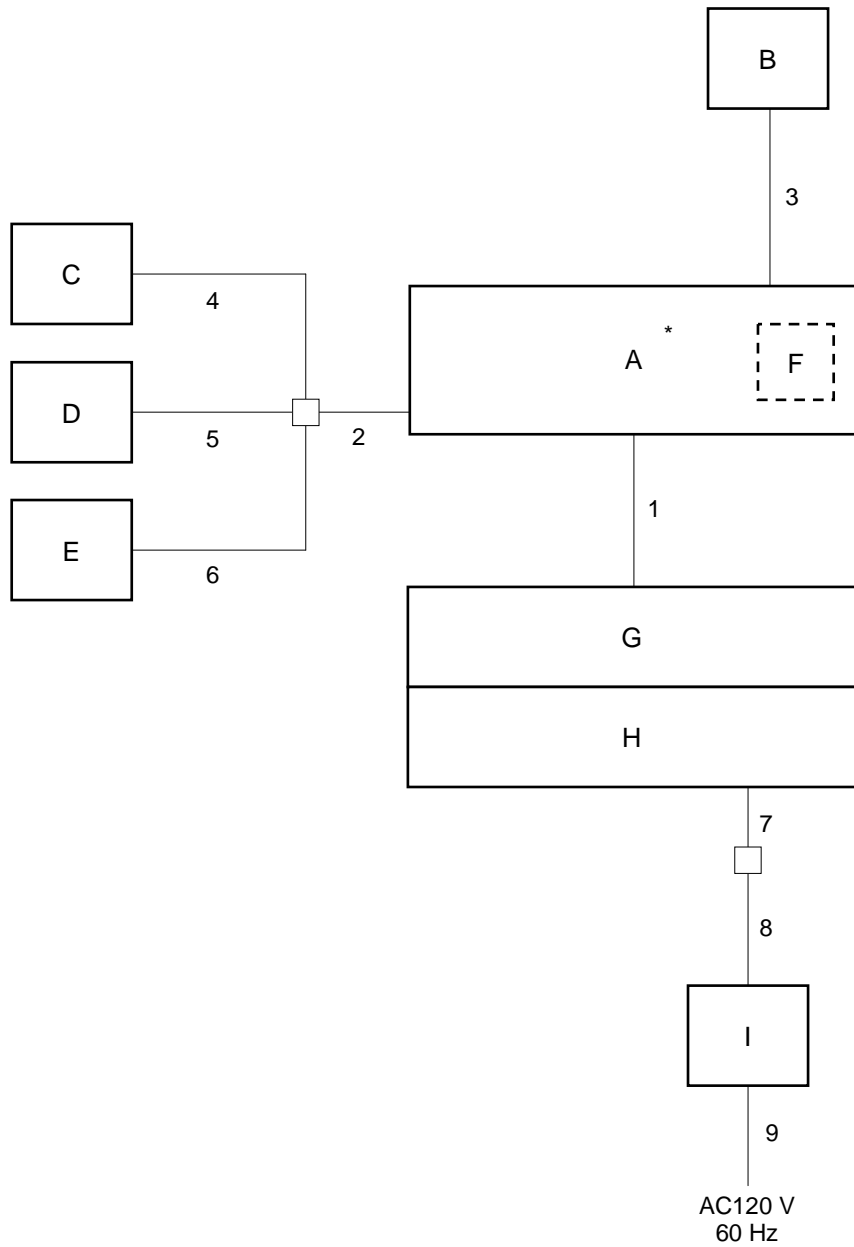

The symbols and numbers assigned to the equipment and cables on this diagram correspond to the ones in Sections 3 to 5.

SECTION 7. OPERATING CONDITION

The test was carried out under the following mode.

Test program used to control the EUT for staying in continuous transmitting and receiving mode is programmed.

7.1 Test Channel

In accordance with Section 15.31 (m), all test items was conducted in the following three channels:

Test Channel	Frequency [MHz]
Low	2402
Middle	2440
High	2480

7.2 Test modes

Test Item	Operating modes
6dB Bandwidth and 99 % Occupied Bandwidth	2402MHz, 2440MHz, 2480MHz
Maximum Peak Output Power	2402MHz, 2440MHz, 2480MHz
Radiated Spurious Emissions and Restrict Band edge	2402MHz, 2440MHz, 2480MHz
Band Edge of Authorized Frequency Band	2402MHz, 2440MHz, 2480MHz
Spurious RF Conducted Emissions	2402MHz, 2440MHz, 2480MHz
Power Density	2402MHz, 2440MHz, 2480MHz
AC Conducted Emissions	2402MHz, 2440MHz, 2480MHz
Receiver Spurious Emissions	Transmit OFF, Receive mode

Note: The Test modes were configured in typical fashion as a customer would normally use it.

SECTION 8. UNCERTAINTY

The following uncertainty represents the expanded uncertainty expressed at approximately the 95% confidence level using a coverage factor of $k = 2$.

Traceability to national standard in SI units is ensured with these values.

Compliance with the limits in this standard are determined without in consideration of the measurement uncertainty of the measurement instrumentation.

8.1 Emission tests

Test items	$U_{lab} [k = 2]$	U_{cispr}
Radiated Spurious Emissions at 3m		
30 MHz – 1000 MHz	+/- 3.96 dB	6.3 dB
Above 1 GHz	+/- 4.91 dB	5.2 dB
AC Conducted Emissions		
150 kHz – 30 MHz	+/- 2.80 dB	3.4 dB

The above expanded instrumentation uncertainty, U_{lab} , is estimated in accordance with CISPR 16-4-2:2011.

8.2 RF Conducted tests

Test Items	$U_{lab} [k = 2]$
Bandwidth	+/- 1.42 %
Maximum Output Power	+/- 1.96 dB
Conducted Emissions	+/- 1.82 dB

SECTION 9. TEST DATA

9.1 6 dB Bandwidth and 99 % Occupied Bandwidth

Regulations	FCC Part15C §15.247 (a) (2) RSS-247 5.2 (a) RSS-Gen 6.7
Test Method/Guide	KDB 558074 D01 DTS Meas Guidance v04 Clause 8.0 ANSI C63.10-2013 clause 6.9.2

Test Procedure

- The EUT and test instrument were set up as shown on section 10.1.
- Adjust the test instrument for the following setting:

RBW	:	100 kHz
VBW	:	≥ 3 x RBW
Detector	:	Peak
Sweep Time	:	Auto
Trace mode	:	Max Hold
- Allow trace to fully stabilize.
- Use "Occupied Bandwidth Measurement" function to measure the 20 dB bandwidth.

Test Result

Location	Matsuda No.1 Test Site
Test date	May 25, 2018
Temperature	27.0 [degree C]
Humidity variation	39 [%]
Test Engineer	Naohei Murakami

Operating modes	Frequency [MHz]	6 dB Bandwidth [MHz]	99 % Bandwidth [MHz]
Bluetooth Low Energy	2402	0.508	1.055
	2440	0.507	1.056
	2480	0.506	1.058

Spectrum Plots

See ANNEX A.1.

9.2 Maximum Peak Output Power

Regulations	FCC Part15C §15.247 (b) RSS-247 5.4 (d)
Test Method/Guide	KDB 558074 D01 DTS Meas Guidance v04 Clause 9.1 ANSI C63.10-2013 clause 7.8.5

Test Procedure

1. The EUT and test instrument were set up as shown on section 10.1.
2. Adjust the test instrument for the following setting:

RBW	:	≥ the 6 dB bandwidth (DTS bandwidth)
VBW	:	≥ 3 x RBW
Span	:	≥ 3 x RBW
Detector	:	Peak
Sweep Time	:	Auto
Trace mode	:	Max Hold

Note: The value of the "6 dB bandwidth", from the result of section 9.1.

3. Allow trace to fully stabilize.
4. Use the peak search function to measure the peak of the emission.
5. Measurement data correction;

$$\text{Measured Value [dBm]} = \text{Reading [dBm]} + \text{Factor [dB]}$$

$$*\text{Factor} = \text{Cable Loss [dB]} + \text{Attenuator [dB]}$$

$$\text{Margin [dB]} = \text{Limit [dBm]} - \text{Measured Value [dBm]}$$

Test Result

Location	Matsuda No.1 Test Site
Test date	May 25, 2018
Temperature	27.0 [degree C]
Humidity variation	39 [%]
Test Engineer	Naohei Murakami

Operating modes	Freq. [MHz]	Reading [dBm]	Factor [dB]	Measured Value [dBm]	Limit		Margin [dB]
					[mW]	[dBm]	
Bluetooth Low Energy	2402	-11.54	12.52	0.98	1000	30	29.02
	2440	-11.43	12.52	1.09			28.91
	2480	-11.31	12.52	1.21			28.79

Spectrum Plots

See ANNEX A.2

9.3 Radiated Spurious Emissions and Band Edge of Restrict Band

Regulations	FCC Part15C §15.209, §15.205 RSS-247 5.5 RSS-Gen 8.9
Test Method/Guide	KDB 558074 D01 DTS Meas Guidance v04 Clause 11.0 and 12.0 ANSI C63.10-2013 clause 6.4, 6.5 and 6.6

Test Procedure

1. The EUT and test instrument were set up as shown on section 10.2.
2. The measurement antenna was placed at a distance of 3 m from the EUT.
3. The turntable azimuth (EUT direction, 0 – 360 degree) and antenna height (1 – 4 m) are adjusted the position so that maximum field strength is obtained for each frequency spectrum to be measured.
(Blow 30 MHz: 1.0 m Fixed)

The equipment and cables are arranged or manipulated within the range of the test standard in the above condition. At least six highest spectrums are measured by the test receiver (below 1 GHz) and spectrum analyzer (above 1 GHz).

For measurements above 1GHz, the emission signal shall be kept within the illumination area of the 3 dB beamwidth of the antenna so that the maximum emission from the EUT is measured.

And the antenna angle toward the source of the emission.

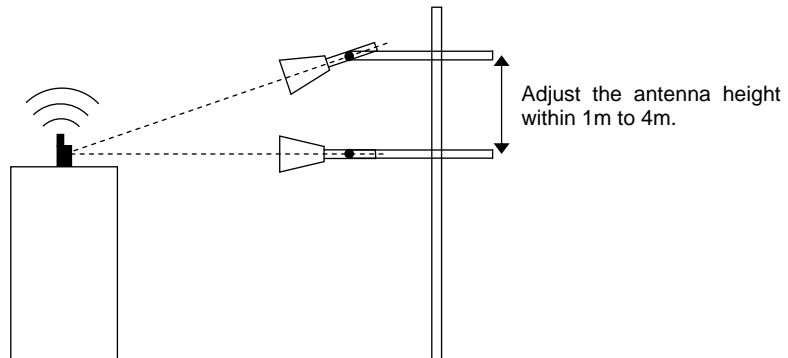

5. Adjust the test instrument for the following setting:

Frequency	Instruments	Detector	RBW	VBW	Remarks
Blow 30 MHz	CISPR Receiver	QP	200 Hz	N/A	0.009 - 0.15 MHz
			9 kHz	N/A	0.15 – 30 MHz
30 – 1000 MHz	CISPR Receiver	QP	120 kHz	N/A	-
Above 1000 MHz	Spectrum Analyzer	Peak	1 MHz	3 MHz	for Peak
				10 Hz	for Average

6. Measurement data correction;

$$\text{Emission Level [dBuV/m]} = \text{Reading [dBuV]} + \text{Factor [dB/m]}$$

$$\text{Margin [dB]} = \text{Limit [dBuV/m]} - \text{Emission Level [dBuV/m]}$$

$$\begin{aligned} * \text{Factor} &= \text{Antenna Factor} + \text{Amplifier gain} + \text{Cable loss} + \text{Attenuator (+ Filter)} \\ &+ \text{Distance Conversion Factor} * \end{aligned}$$

* For other than Standard distance:

$$\text{Distance Conversion Factor} = 20 \log (\text{Measurement distance} / \text{Standard distance})$$

Test Result

Operating mode	Bluetooth Low Energy, 2402 MHz, EUT axis: X				
Location	Matsuda No.2 Test Site,		Matsuda No.1 Test Site,		
Frequency	Blow 30 MHz	30-1000 MHz	1-18 GHz,	18-25 GHz	
Test date	July 9, 2018	May 21, 2018	May 18, 2018	May 16 2018	
Temperature	26.5	26.0	25.0	26.5	[degree C]
Humidity variation	52	24	44	43	[%]
Test Engineer	Naohei Murakami				

No.	Freq. [MHz]	Detector	Reading [dBuV]		Factor [dB/m]	Emission Level [dBuV/m]		Limit [dBuV/m]	Margin [dB]	
			Hori	Vert		Hori	Vert		Hori	Vert
1	288.000	QuasiPeak	27.60	24.20	-2.4	25.2	21.8	46	20.8	24.2
2	595.200	QuasiPeak	23.40	22.20	5.7	29.1	27.9	46	16.9	18.1
3	2390.000	Peak	39.80	41.20	4.7	44.5	45.9	74	29.5	28.1
4	2390.000	Average	27.10	27.30	4.7	31.8	32.0	54	22.2	22.0
5	4804.000	Peak	41.80	44.50	11.1	52.9	55.6	74	21.1	18.4
6	4804.000	Average	28.10	29.70	11.1	39.2	40.8	54	14.8	13.2
7	7206.000	Peak	42.10	41.90	16.4	58.5	58.3	74	15.5	15.7
8	7206.000	Average	29.50	29.50	16.4	45.9	45.9	54	8.1	8.1
9	9608.000	Peak	42.40	42.70	19.3	61.7	62.0	74	12.3	12.0
10	9608.000	Average	30.00	30.00	19.3	49.3	49.3	54	4.7	4.7

No.	Freq. [MHz]	Detector	Reading [dBuV]		Factor [dB]		Result [dBuV/m]		Limit [dBuV/m]		Margin [dB]	
			Hor	Ver	Loss, Gain	Dist. Factor	Hor	Ver	Hor	Ver	Hor	Ver
1	2402.000	Peak	93.1	96.2	4.7	0.0	97.8	100.9	-	-	-	-
2*	2400.000	Peak	48.6	52.0	4.7	0.0	53.3	56.7	77.8	80.9	24.5	24.2

Note.

* : Band Edge of Restrict Band

- : Measurement limit

The limit value is -20dBc from the detected the carrier power.

Below 30 MHz: Spurious emission was not detected.

Any Spurious emissions higher than the frequency reported in the table above were not detected during the measurement.

Operating mode	Bluetooth Low Energy, 2440 MHz, EUT axis: X				
Location	Matsuda No.2 Test Site,		Matsuda No.1 Test Site,		
Frequency	Blow 30 MHz	30–1000 MHz	1-18 GHz,	18–25 GHz	
Test date	July 9, 2018	May 21, 2018	May 18, 2018	May 16 2018	
Temperature	26.5	26.0	25.0	26.5	[degree C]
Humidity variation	52	24	44	43	[%]
Test Engineer	Naohei Murakami				

No.	Freq. [MHz]	Detector	Reading [dBuV]		Factor [dB/m]	Emission Level [dBuV/m]		Limit [dBuV/m]	Margin [dB]	
			Hori	Vert		Hori	Vert		Hori	Vert
1	288.000	QuasiPeak	27.60	24.10	-2.4	25.2	21.7	46	20.8	24.3
2	595.200	QuasiPeak	23.50	22.40	5.7	29.2	28.1	46	16.8	17.9
3	4880.000	Peak	40.20	43.50	11.3	51.5	54.8	74	22.5	19.2
4	4880.000	Average	26.80	28.30	11.3	38.1	39.6	54	15.9	14.4
5	7320.000	Peak	42.00	42.40	16.7	58.7	59.1	74	15.3	14.9
6	7320.000	Average	29.60	29.60	16.7	46.3	46.3	54	7.7	7.7
7	9760.000	Peak	43.70	43.90	19.7	63.4	63.6	74	10.6	10.4
8	9760.000	Average	30.30	30.30	19.7	50.0	50.0	54	4.0	4.0

Note.

Below 30 MHz: Spurious emission was not detected.

Any Spurious emissions higher than the frequency reported in the table above were not detected during the measurement.

Operating mode	Bluetooth Low Energy, 2480 MHz, EUT axis: X				
Location	Matsuda No.2 Test Site,		Matsuda No.1 Test Site,		
Frequency	Blow 30 MHz	30–1000 MHz	1-18 GHz,	18–25 GHz	
Test date	July 9, 2018	May 21, 2018	May 18, 2018	May 16 2018	
Temperature	26.5	26.0	25.0	26.5	[degree C]
Humidity variation	52	24	44	43	[%]
Test Engineer	Naohei Murakami				

No.	Freq. [MHz]	Detector	Reading [dBuV]		Factor [dB/m]	Emission Level [dBuV/m]		Limit [dBuV/m]	Margin [dB]	
			Hori	Vert		Hori	Vert		Hori	Vert
1	288.000	QuasiPeak	27.80	24.30	-2.4	25.4	21.9	46	20.6	24.1
2	595.200	QuasiPeak	23.10	22.40	5.7	28.8	28.1	46	17.2	17.9
3	2483.500	Peak	46.70	46.00	4.9	51.6	50.9	74	22.4	23.1
4	2483.500	Average	27.70	28.10	4.9	32.6	33.0	54	21.4	21.0
5	4960.000	Peak	40.20	43.40	11.4	51.6	54.8	74	22.4	19.2
6	4960.000	Average	29.90	28.70	11.4	41.3	40.1	54	12.7	13.9
7	7440.000	Peak	43.50	43.60	17.3	60.8	60.9	74	13.2	13.1
8	7440.000	Average	30.30	30.30	17.3	47.6	47.6	54	6.4	6.4
9	9920.000	Peak	43.50	43.30	20.2	63.7	63.5	74	10.3	10.5
10	9920.000	Average	30.30	30.30	20.2	50.5	50.5	54	3.5	3.5

Note.

Below 30 MHz: Spurious emission was not detected.

Any Spurious emissions higher than the frequency reported in the table above were not detected during the measurement.

9.4 Band Edge of Authorized Frequency Band

Regulations	FCC Part15C §15.247 (d) RSS-247 5.5
Test Method/Guide	KDB 558074 D01 DTS Meas Guidance v04 Clause 11.0 ANSI C63.10-2013 clause 6.10.4

Test Procedure

1. The EUT and test instrument were set up as shown on section 10.1.
2. Adjust the measurement instrument for the following setting:
 - RBW : 100 kHz
 - VBW : 300 kHz
 - Span : 20 MHz
 - Detector : Peak
 - Sweep Time : Auto
 - Correction Factor : Input Cable loss and Attenuator
 - Trace mode : Max Hold
3. Allow trace to fully stabilize.
4. Use the peak marker function to determine the maximum power level in any 100 kHz band segment within in-band emission.
5. Use the marker function to ensure that the band edge level of the authorized frequency band was attenuated by at least the minimum requirements specified.
6. Band Edge Measurement data correction;
 - Limit [dBm] = Peak level within in-band emission [dBm] - 20 [dB]
 - Margin [dB] = Limit [dBm] – Band edge Level [dBm]

Test Result

Location	Matsuda No.1 Test Site
Test date	May 25, 2018
Temperature	27.0 [degree C]
Humidity variation	39 [%]
Test Engineer	Naohei Murakami

Freq. [MHz]	Peak level within in-band emission [dBm]	Limit [dBm]	Band edge level [dBm]	Margin [dB]
2390	1.046	-18.954	-72.158	53.204
2400	1.046	-18.954	-62.493	43.539
2483.5	1.145	-18.855	-65.574	46.719
2498.99	1.145	-18.855	-60.446	41.591

Spectrum Plots

See ANNEX A.6

9.5 Spurious RF Conducted Emissions

Regulations	FCC Part15C §15.247 (d) RSS-247 5.5
Test Method/Guide	ANSI C63.10-2013 clause 7.8.8

Test Procedure

1. The EUT and test instrument were set up as shown on section 10.1.
2. Adjust the measurement instrument for the following setting:

RBW	:	100 kHz
VBW	:	300 kHz
Span	:	Set span to encompass the spectrum to be examined
Detector	:	Peak
Sweep Time	:	Auto
Correction Factor	:	Input Cable loss and Attenuator
Trace mode	:	Max Hold, Allow trace to fully stabilize.
3. Use the marker function to ensure that the amplitude of all unwanted emissions outside of the authorized frequency band is attenuated by at least the minimum requirements specified.

Spectrum Plots

See ANNEX A.7

Location	Matsuda No.1 Test Site
Test date	May 25, 2018
Temperature	27.0 [degree C]
Humidity variation	39 [%]
Test Engineer	Naohei Murakami

9.6 Power Density

Regulations	FCC Part15C §15.247 (e) RSS-247 5.2 (b)
Test Method/Guide	KDB 558074 D01 DTS Meas Guidance v04 Clause 10.2 ANSI C63.10-2013 clause 7.8.5

Test Procedure

1. The EUT and test instrument were set up as shown on section 10.1.
2. Adjust the test instrument for the following setting:

RBW	:	3 kHz
VBW	:	9 kHz
Span	:	1.5 times the 6 dB bandwidth
Detector	:	Peak
Sweep Time	:	Auto
Trace mode	:	Max Hold

Note: The value of the "6 dB bandwidth", from the result of section 9.1.

3. Allow trace to fully stabilize.
4. Use the peak search function to measure the peak of the emission.
5. Measurement data correction;

$$\text{Measured Value [dBm]} = \text{Reading [dBm]} + \text{Factor [dB]}$$

$$*\text{Factor} = \text{Cable Loss [dB]} + \text{Attenuator [dB]}$$

$$\text{Margin [dB]} = \text{Limit [dBm]} - \text{Measured Value [dBm]}$$

Test Result

Location	Matsuda No.1 Test Site
Test date	May 25, 2018
Temperature	27.0 [degree C]
Humidity variation	39 [%]
Test Engineer	Naohei Murakami

Operating modes	Freq. [MHz]	Reading [dBm]	Factor [dB]	Result [dBm]	Limit [dBm]	Margin [dB]
Bluetooth Low Energy	2402	-27.949	12.520	-15.429	8.000	23.429
	2440	-27.825	12.520	-15.305	8.000	23.305
	2480	-27.780	12.520	-15.260	8.000	23.260

9.7 AC Conducted Emissions

Regulations	FCC Part15C §15.207 RSS-Gen 8.8
Test Method/Guide	ANSI C63.10-2013 clause 6.2

Test Procedure

1. The EUT and test instrument were set up as shown on section 10.3.
2. The spectrum analyzer is controlled by the computer program to sweep the frequency range to be measured, then spectrum chart is plotted out to find the worst emission.

At least six highest spectrum are measured in quasi-peak and average (if necessary) using the CISPR Receiver.

3. Adjust the test instrument for the following setting:

Frequency	Instruments	Detector	RBW	VBW
0.15 – 30 MHz	CISPR Receiver	QP	9 kHz	N/A
		AVG		

6. Measurement data correction;

$$\text{Emission Level [dBuV]} = \text{Reading [dBuV]} + \text{Factor [dB]}$$

$$\text{Margin [dB]} = \text{Limit [dBuV]} - \text{Emission Level [dBuV]}$$

$$* \text{Factor} = \text{LISN Factor} + \text{Cable loss} + \text{Attenuator}$$

Test Result

Test date	July 7, 2018
Location	Matsuda No.2 Test Site
Temperature	25.5 [degree C]
Humidity variation	58 [%]
Test Engineer	Naohei Murakami

Operating mode			Bluetooth Low Energy, 2402MHz								
No.	Freq [MHz]	Detector	Reading [dBuV]		Factor [dB]		Emission Level [dBuV]		Limit [dBuV]	Margin [dB]	
			L1	L2	L1	L2	L1	L2		L1	L2
1	0.2226	QuasiPeak	25.10	27.50	10.20	10.20	35.30	37.70	62.70	27.40	25.00
2	0.3350	QuasiPeak	19.20	25.20	10.10	10.10	29.30	35.30	59.30	30.00	24.00
3	0.5585	QuasiPeak	7.30	11.50	10.10	10.20	17.40	21.70	56.00	38.60	34.30
4	6.0343	QuasiPeak	12.10	4.20	10.70	10.70	22.80	14.90	60.00	37.20	45.10
5	14.4771	QuasiPeak	28.20	27.90	11.00	11.20	39.20	39.10	60.00	20.80	20.90
6	20.0514	QuasiPeak	17.20	17.00	11.30	11.50	28.50	28.50	60.00	31.50	31.50

Operating mode			Bluetooth Low Energy, 2440MHz								
No.	Freq [MHz]	Detector	Reading [dBuV]		Factor [dB]		Emission Level [dBuV]		Limit [dBuV]	Margin [dB]	
			L1	L2	L1	L2	L1	L2		L1	L2
1	0.2226	QuasiPeak	25.00	27.30	10.20	10.20	35.20	37.50	62.70	27.50	25.20
2	0.3350	QuasiPeak	18.90	25.20	10.10	10.10	29.00	35.30	59.30	30.30	24.00
3	0.5585	QuasiPeak	7.60	11.80	10.10	10.20	17.70	22.00	56.00	38.30	34.00
4	6.0343	QuasiPeak	11.20	3.40	10.70	10.70	21.90	14.10	60.00	38.10	45.90
5	14.4771	QuasiPeak	27.70	27.20	11.00	11.20	38.70	38.40	60.00	21.30	21.60
6	20.0514	QuasiPeak	16.60	16.80	11.30	11.50	27.90	28.30	60.00	32.10	31.70

Operating mode			Bluetooth Low Energy, 2480MHz									
No.	Freq [MHz]	Detector	Reading [dBuV]		Factor [dB]		Emission Level [dBuV]		Limit [dBuV]	Margin [dB]		
			L1	L2	L1	L2	L1	L2		L1	L2	
1	0.2226	QuasiPeak	24.90	27.10	10.20	10.20	35.10	37.30	62.70	27.60	25.40	
2	0.3350	QuasiPeak	18.90	25.10	10.10	10.10	29.00	35.20	59.30	30.30	24.10	
3	0.5585	QuasiPeak	7.40	11.90	10.10	10.20	17.50	22.10	56.00	38.50	33.90	
4	6.0343	QuasiPeak	11.60	3.60	10.70	10.70	22.30	14.30	60.00	37.70	45.70	
5	14.4771	QuasiPeak	27.70	27.30	11.00	11.20	38.70	38.50	60.00	21.30	21.50	
6	20.0514	QuasiPeak	16.70	16.40	11.30	11.50	28.00	27.90	60.00	32.00	32.10	

9.8 Receiver Spurious Emissions

Regulations	RSS-Gen 7.1
Test Method/Guide	ANSI C63.10-2013 clause 6.4, 6.5 and 6.6

Test Procedure

See section 9.6

Test Result

Operating mode	Bluetooth Low Energy Receiving mode, EUT Axis: X				
Location	Matsuda No.2 Test Site,		Matsuda No.1 Test Site,		
Frequency	Blow 30 MHz	30 – 1000 MHz,	1-18 GHz,	18–26.5 GHz,	
Test date	July 9, 2018	May 21, 2018	May 18, 2018	May 16 2018	
Temperature	26.5	26.0	24.0	26.5	[degree C]
Humidity variation	52	24	56	43	[%]
Test Engineer	Naohei Murakami				

No.	Freq. [MHz]	Detector	Reading [dBuV]		Factor [dB/m]	Emission Level [dBuV/m]		Limit [dBuV/m]	Margin [dB]	
			Hori	Vert		Hori	Vert		Hori	Vert
1	288.000	QuasiPeak	27.70	24.30	-2.4	25.3	21.9	46	20.7	24.1
2	595.200	QuasiPeak	23.30	22.10	5.7	29.0	27.8	46	17.0	18.2
3	2440.000	Peak	46.20	44.70	4.7	50.9	49.4	74	23.1	24.6
4	2440.000	Average	28.50	28.20	4.7	33.2	32.9	54	20.8	21.1
5	4880.000	Peak	39.90	42.10	11.3	51.2	53.4	74	22.8	20.6
6	4880.000	Average	26.20	28.50	11.3	37.5	39.8	54	16.5	14.2
7	7320.000	Peak	41.80	42.60	16.7	58.5	59.3	74	15.5	14.7
8	7320.000	Average	29.60	29.50	16.7	46.3	46.2	54	7.7	7.8
9	9760.000	Peak	42.50	43.50	19.7	62.2	63.2	74	11.8	10.8
10	9760.000	Average	30.20	30.10	19.7	49.9	49.8	54	4.1	4.2

Note.

Below 30 MHz: Spurious emission was not detected.

Any Spurious emissions higher than the frequency reported in the table above were not detected during the measurement.

SECTION 10. LIST AND DIAGRAM OF MEASURING INSTRUMENTS

Test instruments are calibrated according to Quality Manual and Calibration Rules of Intertek Japan K.K.

10.1 RF Conducted

Measurement Instruments

Instrument	Model No.	Serial No.	Manufacturer	Cal. Interval	Effective period
Spectrum Analyzer	N9030A	MY52350520	Agilent	1 Y	Nov. 30, 2018
20 dB Attenuator	8493C	02678	Hewlett Packard	1 Y	Apr. 30, 2019
Coaxial Cable	5B-048-98-98-1000	ECE0084	CANDOX Systems	1 Y	Apr. 30, 2019

Measurement Equipment Configuration

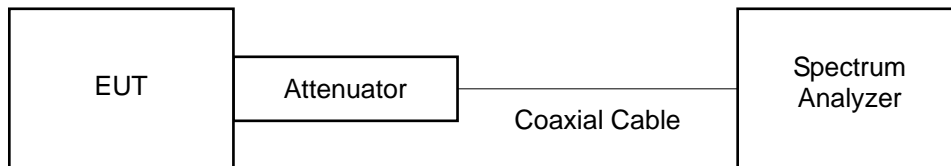

10.2 Radiated Emission

Measurement Instruments

Instrument	Model No.	Serial No.	Manufacturer	Cal. Interval	Effective period
Radiated disturbance :Below 30 MHz					
Test Receiver	ESR26 (Firmware: 3.36 SP2)	101629	Rohde & Schwarz	1 Y	Feb. 2019
Loop Antenna	HFH2-Z2	882964/28	Rohde & Schwarz	1 Y	Dec. 2018
Coaxial Cable (M1)	5D-2W(8.0m)	EM0CS012	SUHNER	1 Y	Jan. 2019
6dB Attenuator	MP721B	M87938	ANRITSU	1 Y	Jan. 2019
Radiated disturbance :30 MHz – 1000 MHz					
Test Receiver	ESR26 (Firmware: 3.36 SP2)	101629	Rohde & Schwarz	1 Y	Feb. 2019
Broad Band Antenna	VULB9168	124	Schwarzbeck	1 Y	Aug. 2018
Amplifier	8447D	2727A05809	Hewlett Packard	1 Y	Jan. 2019
Step Attenuator	8494B	2805A14576	Hewlett Packard	1 Y	Jan. 2019
6dB Attenuator	MP721B	M87938	ANRITSU	1 Y	Jan. 2019
Coaxial Cable (R1)	RG214HF(8.0m)	MTS02R3-1	SUHNER	1 Y	Jan. 2019
Coaxial Cable (R2)	12D-SFA(28.0m)	MTS02R3-2	Intertek	1 Y	Jan. 2019
Coaxial Cable (R3)	RG214HF(2.0m)	MTS02R3-3	SUHNER	1 Y	Jan. 2019
Coaxial Cable (R4)	RG214HF(0.4m)	MTS02R3-4	SUHNER	1 Y	Jan. 2019
Coaxial Cable (R5)	RG214HF(0.4m)	MTS02R3-5	SUHNER	1 Y	Jan. 2019
Coaxial Cable (R6)	RG214HF(1.5m)	MTS02R3-6	SUHNER	1 Y	Jan. 2019
Coaxial Cable (R7)	RG214HF(1.5m)	MTS02R3-7	SUHNER	1 Y	Jan. 2019
Coaxial Cable (R8)	RG214HF(1.5m)	MTS02R3-8	SUHNER	1 Y	Jan. 2019
Coaxial Cable (R9)	5D-2W(8.0m)	MTS02R3-9	SUHNER	1 Y	Jan. 2019
Site Attenuation	-	-	-	1 Y	Apr. 2019
RF Switch(1)	MP59B	M28942	ANRITSU	1 Y	Jan. 2019
RF Switch(2)	ACX-150-1	E02301501	Intertek	1 Y	Jan. 2019

Radiated disturbance :Above 1000 MHz					
Spectrum Analyzer	ESR26 (Firmware: 3.36 SP2)	101629	Rohde & Schwarz	1 Y	Feb. 2019
Double Ridged Antenna	3115	2568	EMCO	1 Y	Jan. 2019
Amplifier	TPA0118-30	950186	TOYO Corporation	1 Y	Apr. 2019
3dB Attenuator	6803.17.B	E00AT3GA	SUNNER	1 Y	Apr. 2019
Notch Filter	BRM50702	111	Micro-Ttronics	1 Y	Apr. 2019
Coaxial Cable (R11)	SUCOFLEX 104(6.0m)	65566/4PE	SUNNER	1 Y	Apr. 2019
Coaxial Cable (R12)	SUCOFLEX 104(1.0m)	64587/4PE	SUNNER	1 Y	Apr. 2019
Horn Antenna with Preampfier	MLA-18265-B03-30	1694440	TSJ	1 Y	Mar. 2019
Coaxial cable	5B-048-98-98-6000	120315	Candox	1 Y	May 2019
SVSWR(1 – 18GHz)	-	-	-	1 Y	Sep. 2018
Common					
RF Switch(1)	MP59B	M28942	ANRITSU	1 Y	Jan. 2019
RF Switch(2)	ACX-150-1	E02301501	Intertek	1 Y	Jan. 2019

Measurement Instruments Configurations

Diagram of the measuring instruments (Below 30MHz)



Diagram of the measurement instruments (30-1000 MHz)

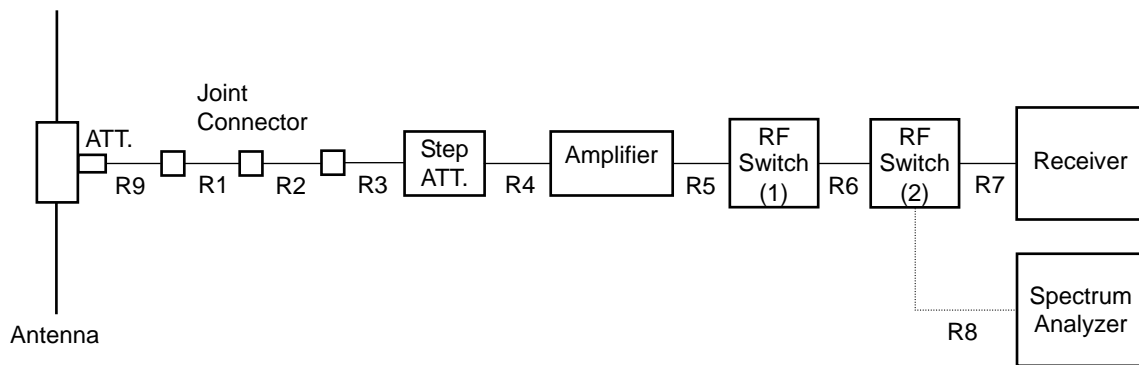

Diagram of the measurement instruments (1000 - 1800 MHz)

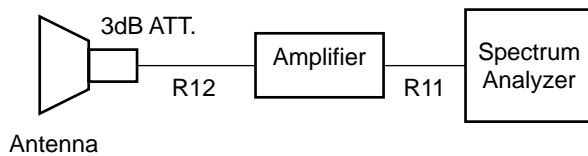

Diagram of the measurement instruments (1000- 18000 MHz)

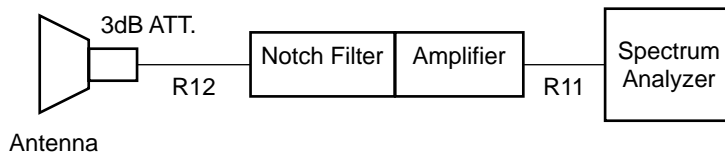
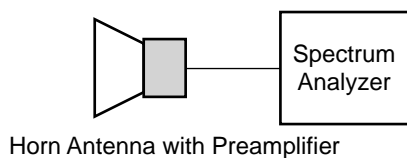
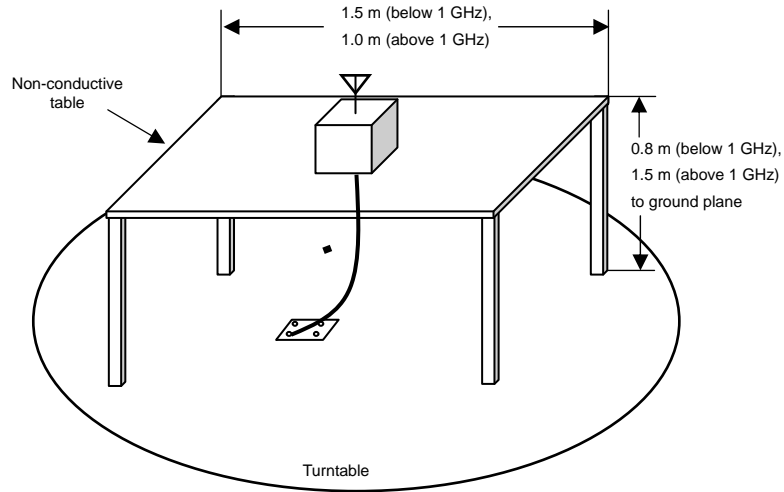

Diagram of the measurement instruments (18000 - 25000 MHz)



EUT set-up as per standard



Absorber placement and Receive Antenna location in Radiated disturbance above 1 GHz

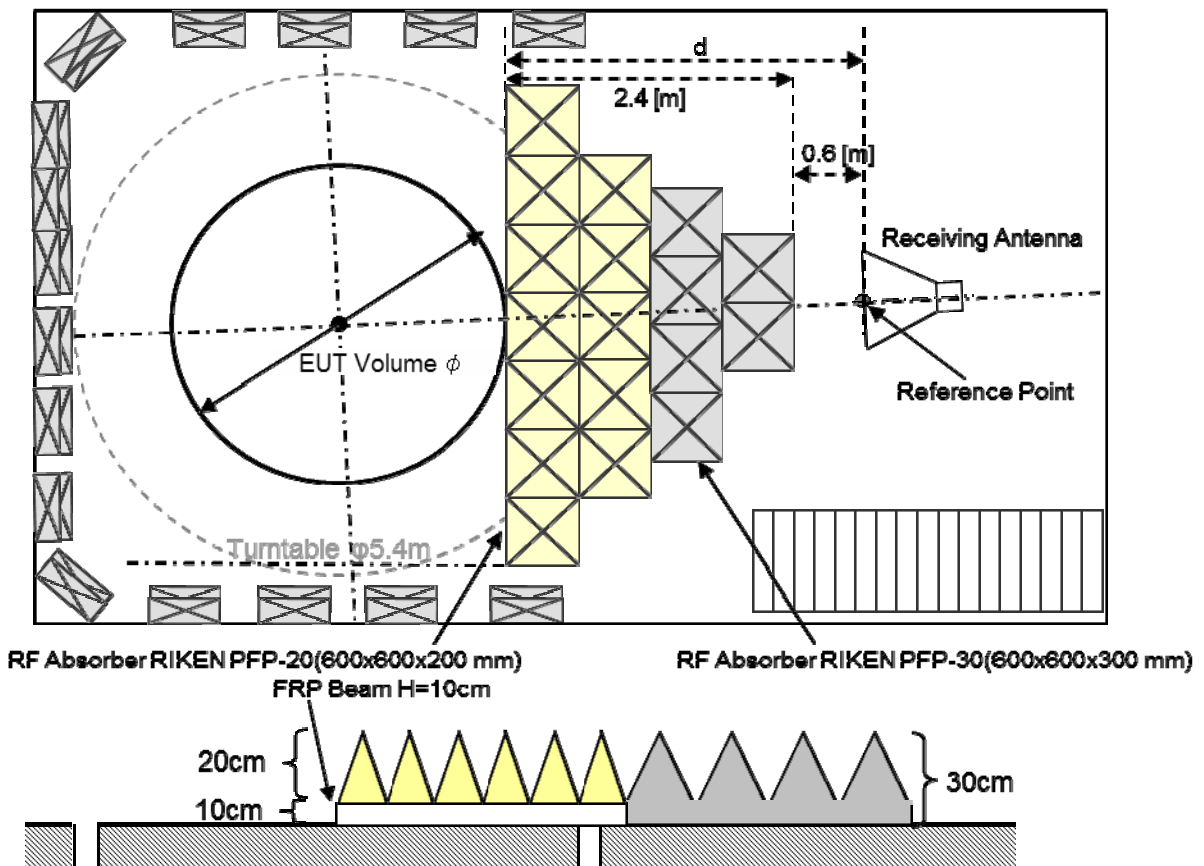

10.3 AC Line Conducted Emission

Measurement Instrument

Instrument	Model No.	Serial No.	Manufacturer	Cal. Interval	Effective period
Test Receiver	ESR26 (Firmware: 3.36 SP2)	101629	Rohde & Schwarz	1 Y	Feb. 2019
LISN(EUT)	ESH2-Z5	882395/021	Rohde & Schwarz	1 Y	Jun. 2018
10dB LISN Pad	6801.01.A	E00AT10C	HUBER+SUHNER	1 Y	Jun. 2018
Coaxial Cable (C1)	3D-2W(7.8m)	MTS02CSR-1	Intertek	1 Y	Jan. 2019
Coaxial Cable (C2)	RG-5A/U(12.0m)	MTS02CSR-2	Intertek	1 Y	Jan. 2019
Coaxial Cable (C3)	RG214HF(1.5m)	MTS02CSR-3	SUHNER	1 Y	Jan. 2019
Coaxial Cable (C4)	RG214HF(1.5m)	MTS02CSR-4	SUHNER	1 Y	Jan. 2019
Coaxial Cable (C5)	RG214HF(1.5m)	MTS02CSR-5	SUHNER	1 Y	Jan. 2019
RF Switch(1)	MP59B	M28942	ANRITSU	1 Y	Jan. 2019
RF Switch(2)	ACX-150-1	E02301501	Intertek	1 Y	Jan. 2019
Testing Software	emiT (3,0,0,0)			N/A	N/A

Measurement Instruments Configurations

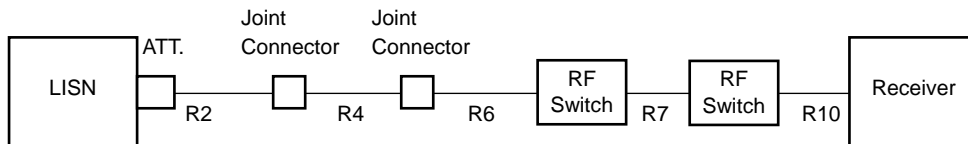

Test setup as per standard

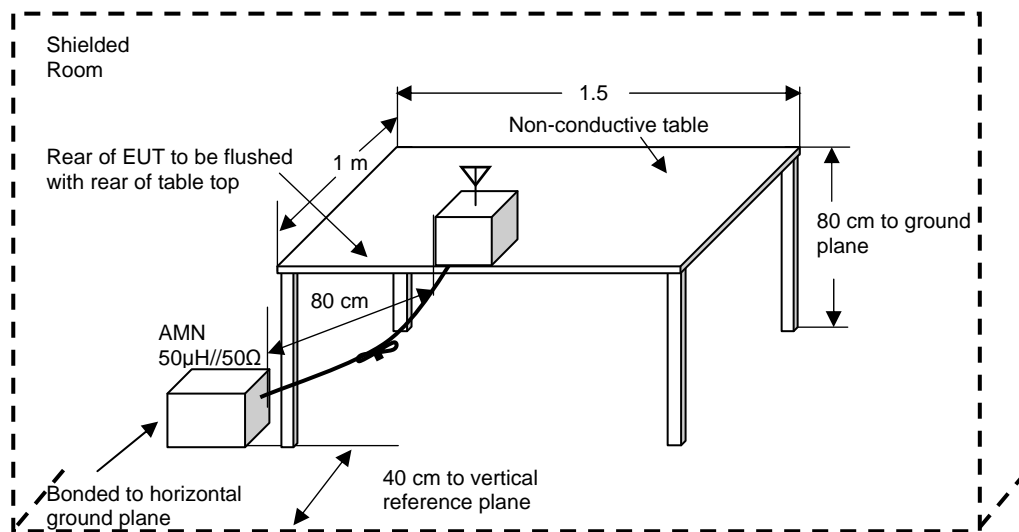

* Reference Ground plane : greater than 2 x 2m

ANNEX

A. HARD COPY OF SPECTRUM PLOTS

A.1 6 dB Bandwidth and 99 % Occupied Bandwidth

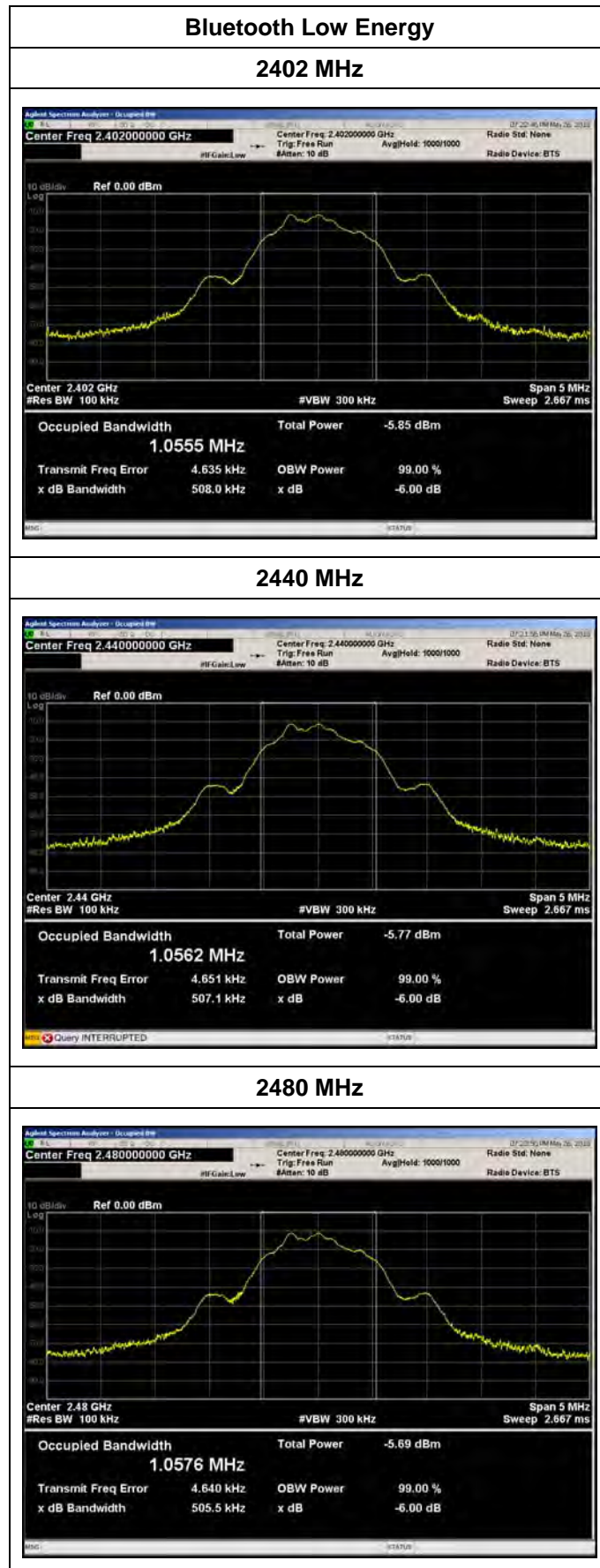

A.2 Maximum Peak Output Power

Bluetooth Low Energy

2402 MHz



2440 MHz

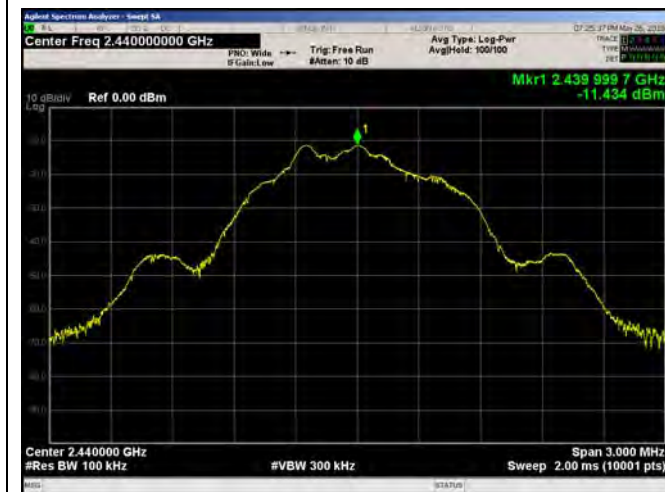

2480 MHz



A.3 Band Edge of Authorized Frequency Band

Bluetooth Low Energy

2400 MHz

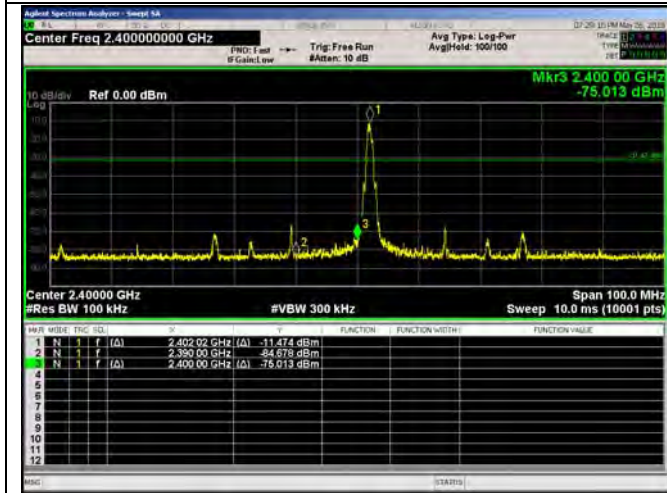

2483.5 MHz

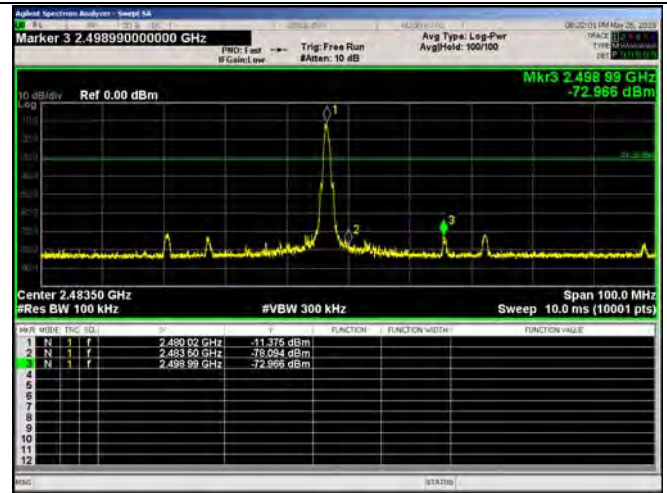

A.4 Spurious RF Conducted Emissions

Bluetooth Low Energy, 2402MHz

0.009 – 0.15 MHz

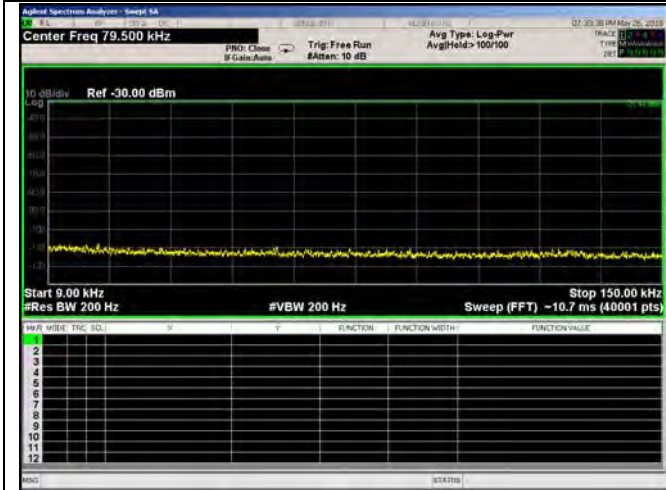

0.15 – 30 MHz

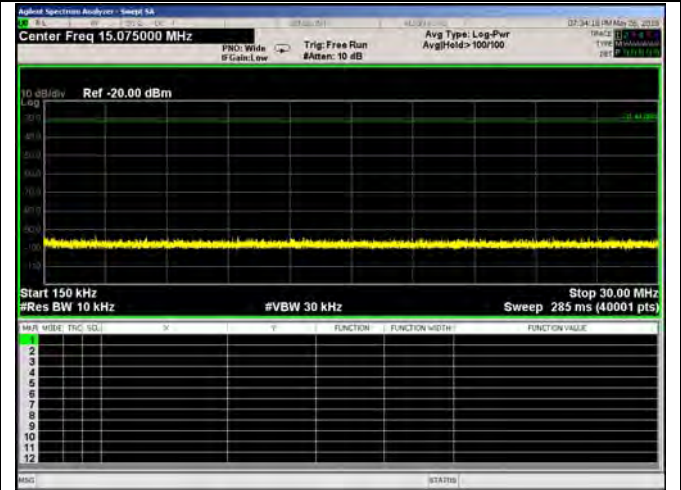

30 – 1000 MHz

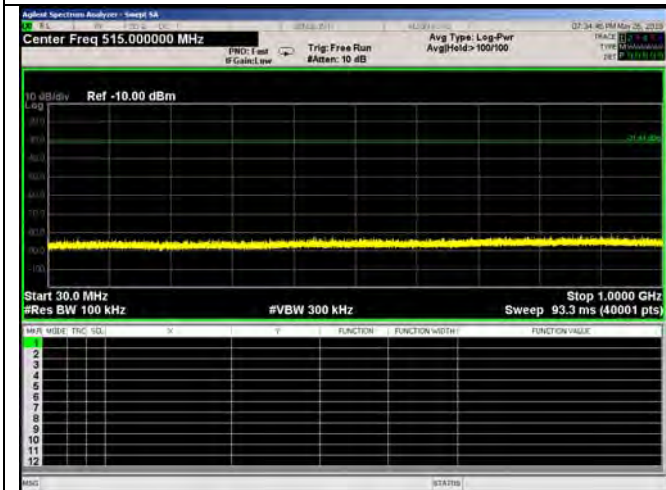

1 - 5 GHz

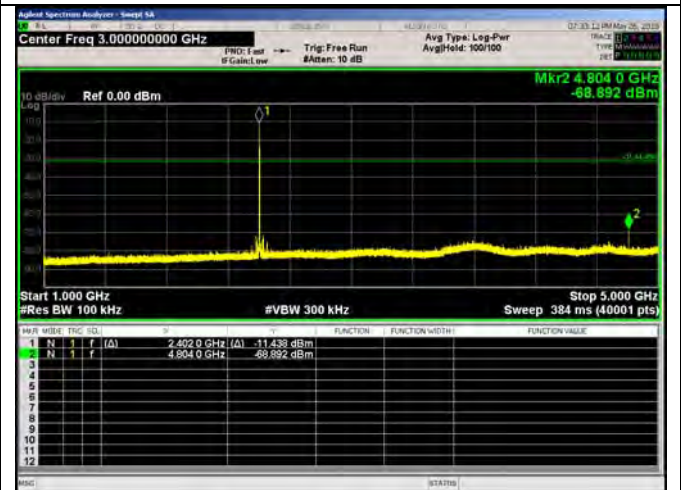

5 – 9 GHz

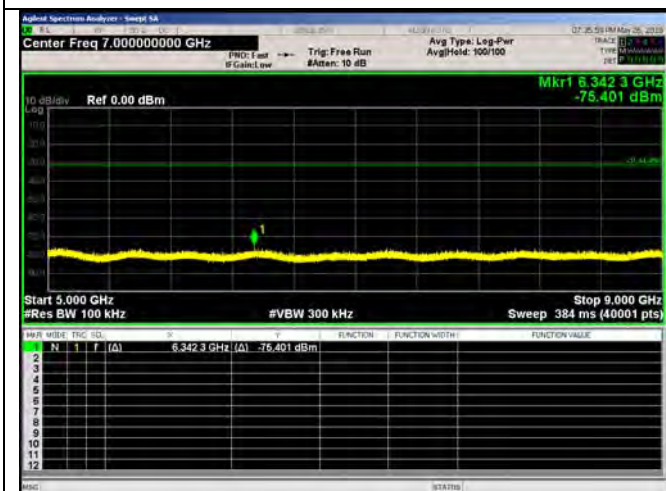

9 – 13 GHz

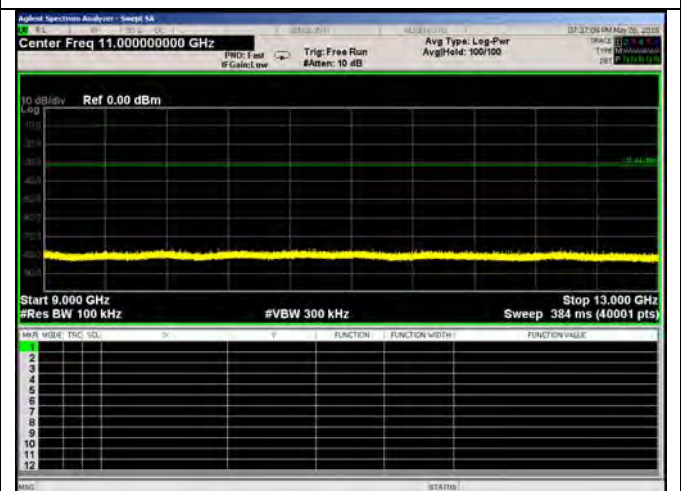

13 – 17 GHz

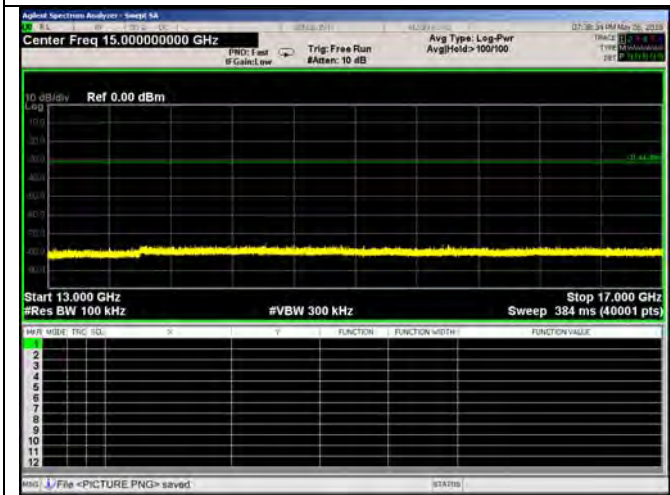

17 – 21 GHz

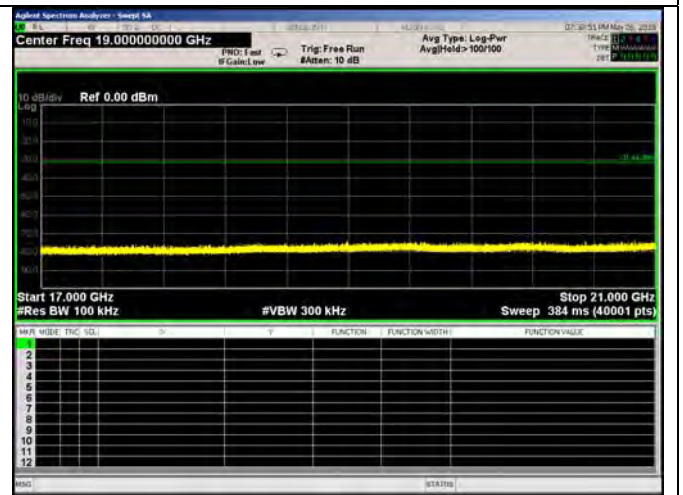

21 – 25 GHz

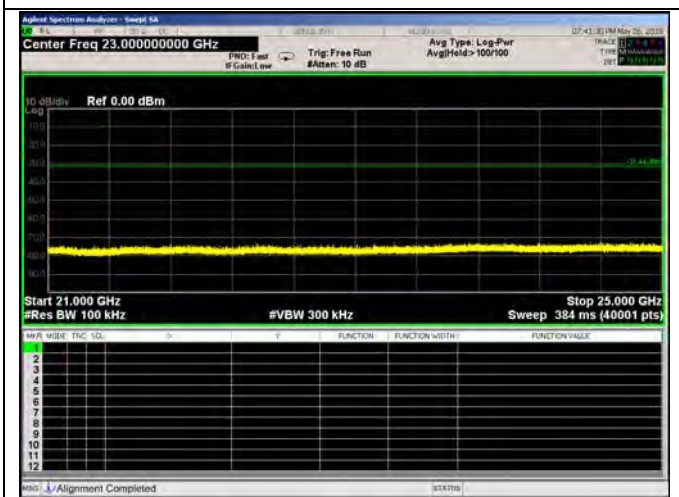

Bluetooth Low Energy, 2440MHz

0.009 – 0.15 MHz

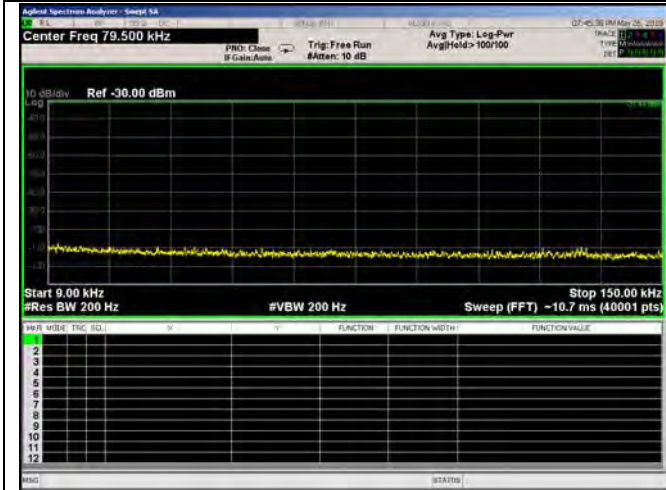

0.15 – 30 MHz

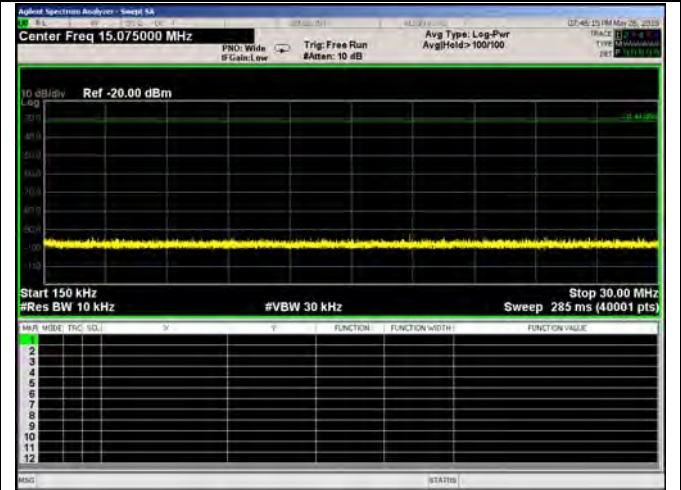

30 – 1000 MHz

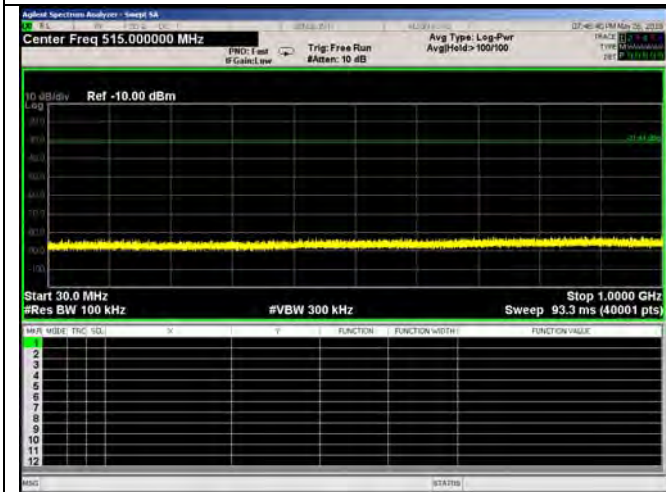

1 - 5 GHz

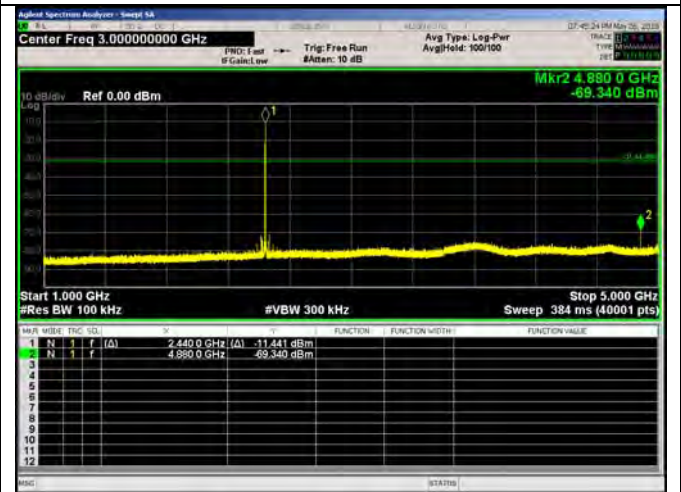

5 – 9 GHz

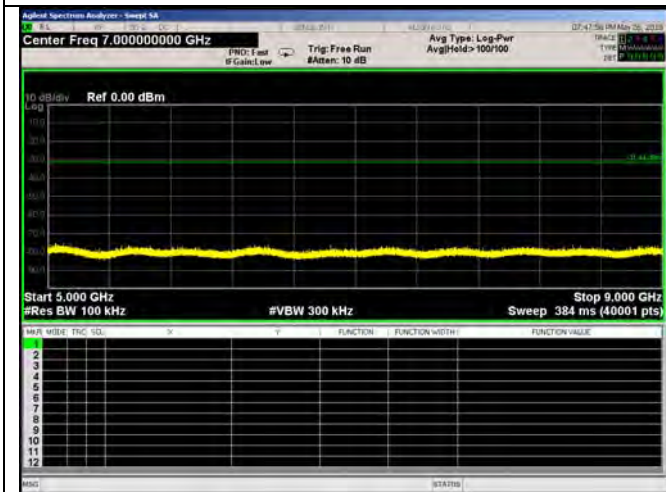

9 – 13 GHz

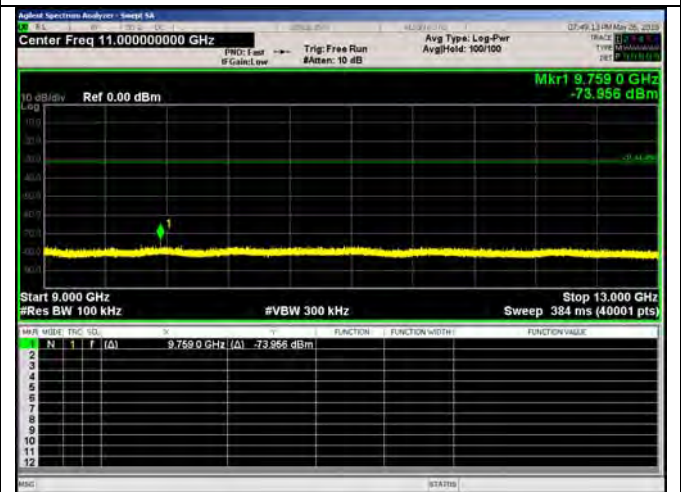

13 – 17 GHz

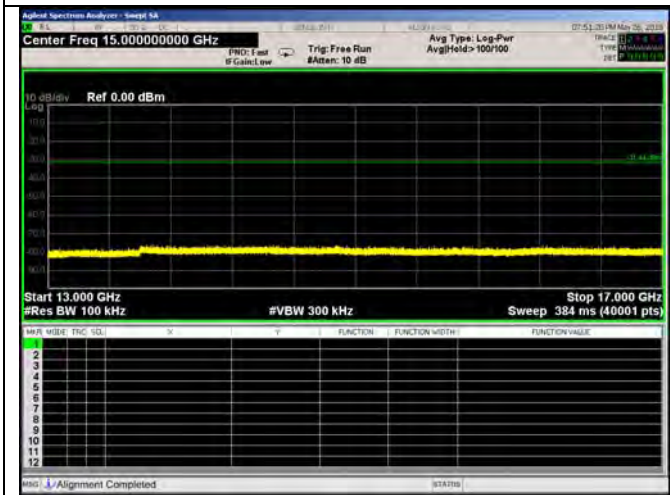

17 – 21 GHz

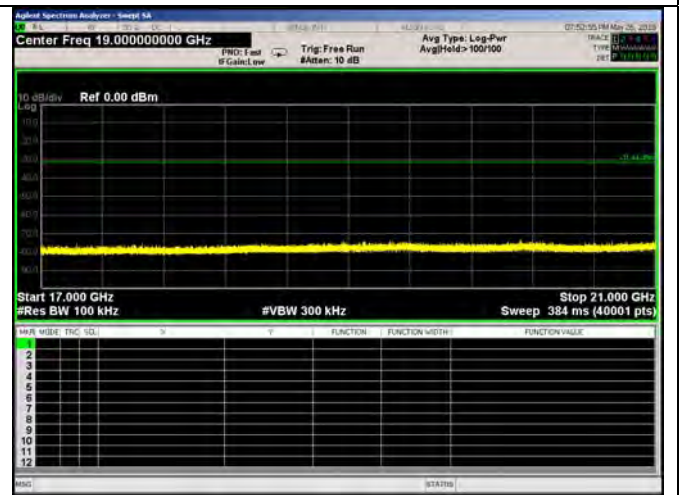

21 – 25 GHz

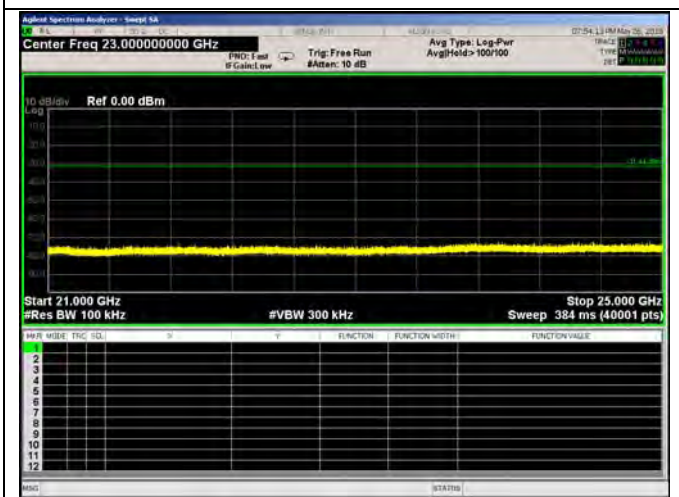

Bluetooth Low Energy, 2480MHz

0.009 – 0.15 MHz



0.15 – 30 MHz

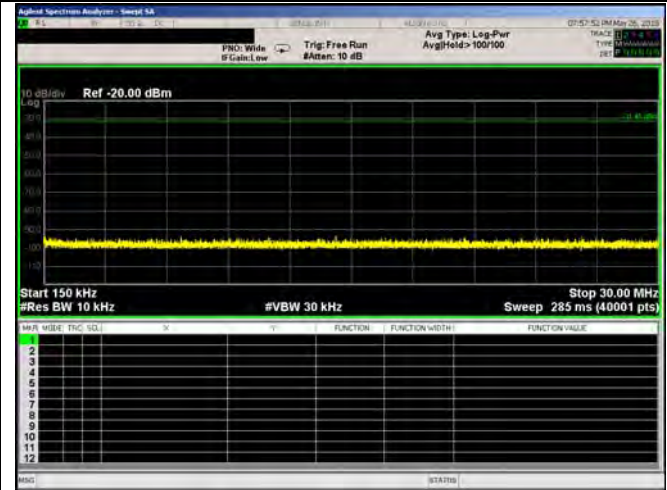

30 – 1000 MHz



1 - 5 GHz

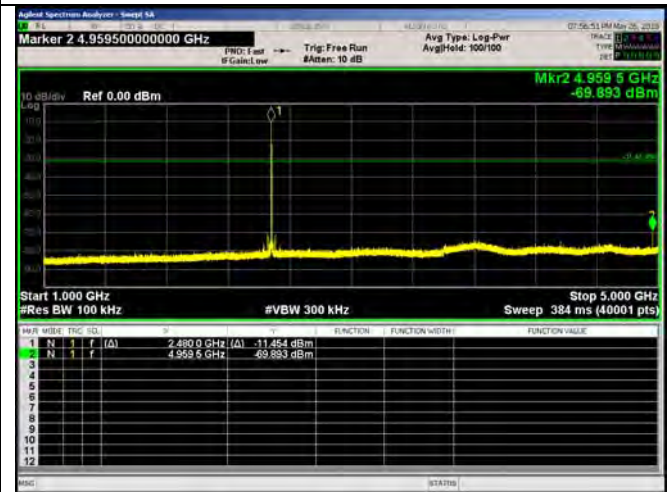

5 – 9 GHz

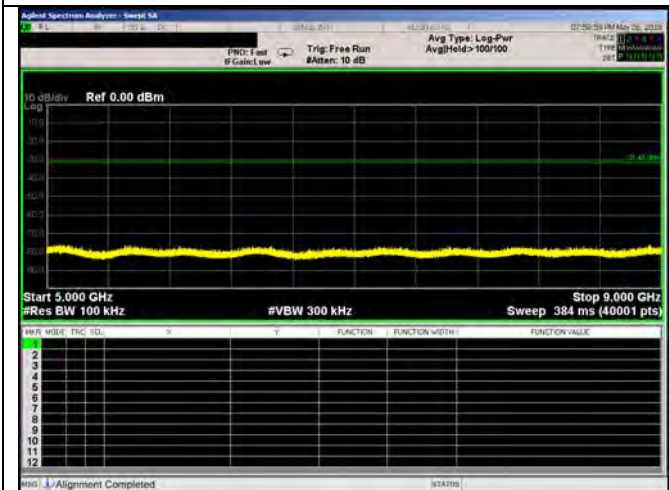

9 – 13 GHz

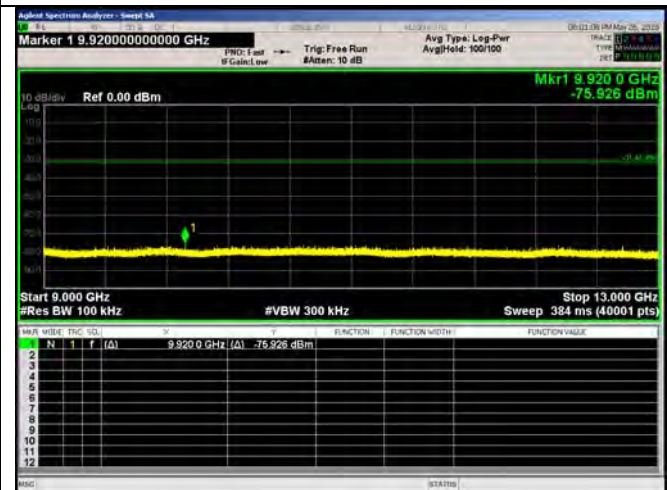

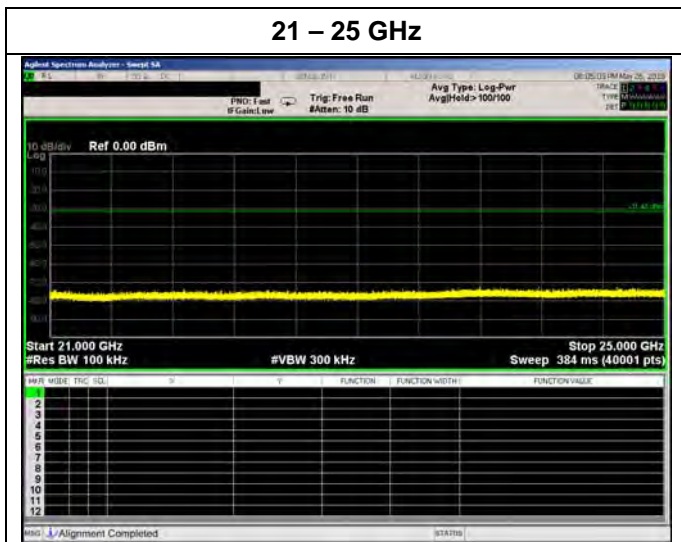
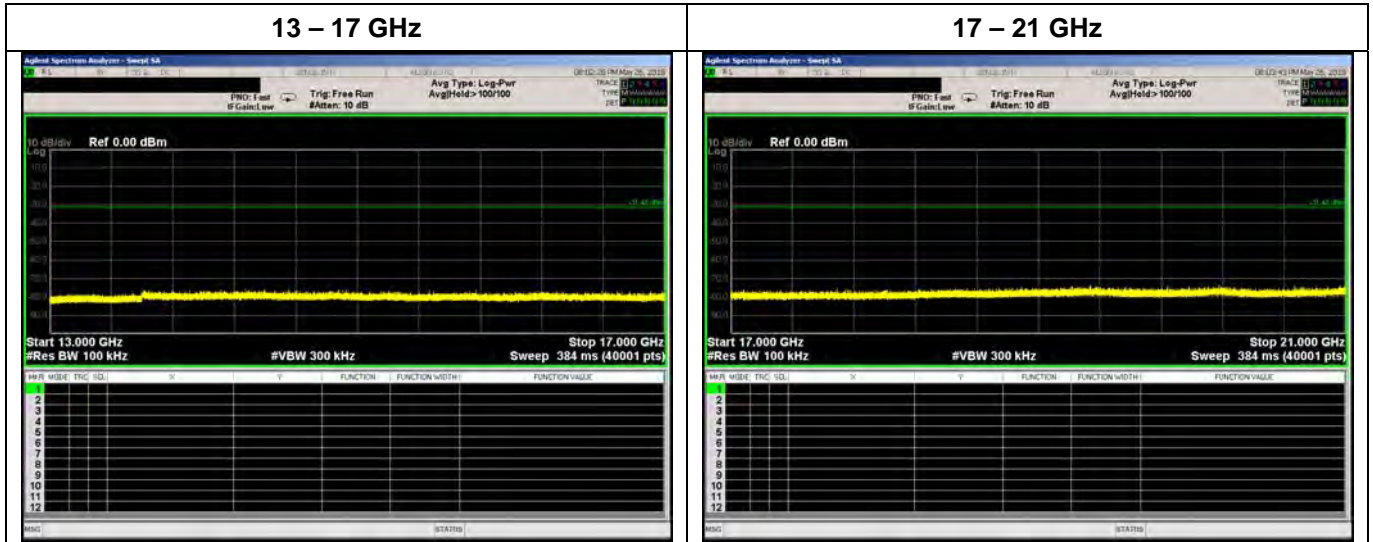

A.4 Power Density

Bluetooth Low Energy

2402 MHz



2440 MHz

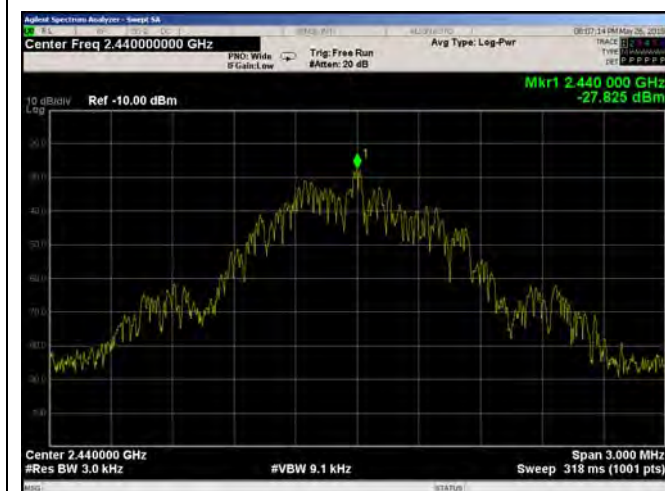

2480 MHz

