

# SAR TEST REPORT

**JVC KENWOOD CORPORATION**

1-16-2 Hakusan Midori-ku Yokohama-shi  
Kanagawa 226-8525 Japan

**Date of Issue: Jan. 09, 2015**

**Test Report No: HCT-A-1410-F006-2**

**Test Site: HCT CO., LTD.**

**FCC ID:**

**K44431501**

**Rule Part(s) / Standard(s):**  
**Equipment Type:**  
**Application Type:**  
**FCC Model Name:**

**Part 2, 90**  
**UHF DIGITAL TRANSCEIVER**  
**Class II Permissive Change**  
**NX-5300-K5, NX-5300-K6, NX-5300-F5, NX-5300-F6**

**Testing has been carried out in accordance with:**

**47CFR §2.1093**  
**ANSI/ IEEE C95.1 – 1992**  
**IEEE 1528-2003**  
**RSS-102 Issue 4; Health Canada Safety Code 6**  
**Jan. 06, 2015**

**Date of Test:**

This device has been shown to be capable of compliance for localized specific absorption rate (SAR) for uncontrolled environment/general population exposure limits specified in FCC KDB procedures and had been tested in accordance with the measurement procedures specified in FCC KDB procedures.

I attest to the accuracy of data. All measurements reported herein were performed by me or were made under my supervision and are correct to the best of my knowledge and belief. I assume full responsibility for the completeness of these measurements and vouch for the qualifications of all persons taking them.

Tested By

Reviewed By



Young-Soo Jang  
Test Engineer / SAR Team  
Certification Division



Dong-Seob Kim  
Technical Manager / SAR Team  
Certification Division

## Version

Rev.	DATE	DESCRIPTION
HCT-A-1410-F006-2	Jan. 09, 2015	First Approval Report

---

# Table of Contents

---

<u>1. INTRODUCTION .....</u>	<u>4</u>
<u>2. TEST METHODOLOGY .....</u>	<u>5</u>
<u>3. DESCRIPTION OF DEVICE.....</u>	<u>6</u>
<u>4. Manufacturer's Accessory List .....</u>	<u>7</u>
<u>5. DESCRIPTION OF TEST EQUIPMENT .....</u>	<u>1 2</u>
<u>6. SAR MEASUREMENT PROCEDURE.....</u>	<u>1 9</u>
<u>7. DESCRIPTION OF TEST POSITION.....</u>	<u>2 0</u>
<u>8. ANSI/ IEEE C95.1 - 1992 RF EXPOSURE LIMITS .....</u>	<u>2 2</u>
<u>9. SAR SYSTEM VALIDATION.....</u>	<u>2 3</u>
<u>10. SYSTEM VERIFICATION.....</u>	<u>2 4</u>
<u>11. RF CONDUCTED POWER MEASUREMENT .....</u>	<u>2 6</u>
<u>11.3 SAR Test Exclusions Applied.....</u>	<u>2 8</u>
<u>12. SAR TEST DATA SUMMARY .....</u>	<u>2 9</u>
<u>14. CONCLUSION.....</u>	<u>3 6</u>
<u>15.REFERENCES .....</u>	<u>3 7</u>
<u>Attachment 1.– SAR Test Plots .....</u>	<u>3 8</u>
<u>Attachment 2. – Dipole Verification Plots.....</u>	<u>5 6</u>
<u>Attachment 3. – Probe Calibration Data .....</u>	<u>6 4</u>
<u>Attachment 4. – Dipole Calibration Data .....</u>	<u>8 7</u>

# 1. INTRODUCTION

The FCC has adopted the guidelines for evaluating the environmental effects of radio frequency radiation in ET Docket 93-62 on Aug. 6, 1996 to protect the public and workers from the potential hazards of RF emissions due to FCC-regulated portable devices.

The safety limits used for the environmental evaluation measurements are based on the criteria published by the American National Standards Institute (ANSI) for localized specific absorption rate (SAR) in IEEE/ANSI C95.1-1992 Standard for Safety Levels with Respect to Human Exposure to Radio Frequency Electromagnetic Fields, 3 kHz to 300 GHz. 1992 by the Institute of Electrical and Electronics Engineers, Inc., New York, New York 10017. The measurement procedure described in IEEE/ANSI C95.3-1992 Recommended Practice for the Measurement of Potentially Hazardous Electromagnetic Fields - RF and Microwave is used for guidance in measuring SAR due to the RF radiation exposure from the Equipment Under Test (EUT). These criteria for SAR evaluation are similar to those recommended by the National Council on Radiation Protection and Measurements (NCRP) in Biological Effects and Exposure Criteria for Radio frequency Electromagnetic Fields," NCRP Report No. 86 NCRP, 1986, Bethesda, MD 20814. SAR is a measure of the rate of energy absorption due to exposure to an RF transmitting source. SAR values have been related to threshold levels for potential biological hazards.

## SAR Definition

Specific Absorption Rate (SAR) is defined as the time derivative of the incremental electromagnetic energy (dW) absorbed by (dissipated in) an incremental mass (dm) contained in a volume element (dV) of a given density (ρ). It is also defined as the rate of RF energy absorption per unit mass at a point in an absorbing body.

$$SAR = \frac{d}{dt} \left( \frac{dU}{dm} \right) = \frac{d}{dt} \left( \frac{dU}{\rho dV} \right)$$

Figure 1. SAR Mathematical Equation

*SAR is expressed in units of Watts per Kilogram (W/kg)*

$$SAR = \sigma E^2 / \rho$$

Where:

- σ = conductivity of the tissue-simulant material (S/m)
- ρ = mass density of the tissue-simulant material (kg/m<sup>3</sup>)
- E = Total RMS electric field strength (V/m)

NOTE: The primary factors that control rate of energy absorption were found to be the wavelength of the incident field in relations to the dimensions and geometry of the irradiated organism, the orientation of the organism in relation to the polarity of field vectors, the presence of reflecting surfaces, and whether conductive contact is made by the organism with a ground plane.

## **2. TEST METHODOLOGY**

The tests documented in this report were performed in accordance with IEEE Standard 1528-2003 & IEEE 1528-2005 and the following published KDB procedures.

- FCC KDB Publication 447498 D01v05r02 (General SAR Guidance)
- FCC KDB 634646 D01 Handset SAR v01r01
- FCC KDB Publication 865664 D01 SAR measurement 100 MHz to 6 GHz v01r03
- FCC KDB Publication 865664 D02 SAR Reporting v01r01

### 3. DESCRIPTION OF DEVICE

Environmental evaluation measurements of specific absorption rate (SAR) distributions in emulated human head and body tissues exposed to radio frequency (RF) radiation from wireless portable devices for compliance with the rules and regulations of the U.S. Federal Communications Commission (FCC).

EUT Type	UHF DIGITAL TRANSCEIVER					
FCC ID:	K44431501					
FCC Model Name:	NX-5300-K5, NX-5300-K6, NX-5300-F5, NX-5300-F6 (Models are electrically identical and differ only in number of buttons on keypad)					
IC Model Name:	NX-5300-K5, NX-5300-K6					
Trade Name	JVC KENWOOD CORPORATION					
Application Type	Class II Permissive Change					
Production Unit or Identical Prototype	Prototype					
Max. SAR	Band	Tx. Frequency (MHz)	Equipment Class	Reported 1 g SAR (W/kg)		50% PTT duty cycle
				Head	Body-worn	
	UHF(FCC)	406.1 - 470	TNF	2.51	5.19	
	Bluetooth	2 402 - 2 480	DSS/ DTS	-	0.02 <sup>*1</sup>	
Simultaneous SAR per KDB 690783 D01v01r03				UHF(FCC)	5.21	
Date(s) of Tests	Sep. 21, 2014 , Sep. 22, 2014, Sep. 23, 2014, Oct. 14, 2014, Jan. 06, 2015					

**\*Note 1:** BT Body-worn SAR value is estimate SAR value that should not be reported standalone SAR on grants of equipment approval.

**\*\* Note 2 :** The device is electrically identical to the previously certified original device, additional SAR test were done for KRA-29 Ant.

## 4.Manufacturer's Accessory List

Part No.	Description	Accessory Type	Accessory
KRA-29P	Broad-band UHF Antenna (406-470MHz) (IC Option)	Antenna	Original antenna
KRA-29	Broad-band UHF Antenna (380-430MHz)		3
KRA-23(M)	UHF short type Antenna(440-490MHz)		Original antenna
KRA-23(M3)	UHF short type Antenna(400-450MHz)		Original antenna
KRA-27(M)	UHF Whip Antenna(440-490MHz)		Original antenna
KRA-27(M3)	UHF Whip Antenna (400-450MHz)		Original antenna
KRA-42(M)	UHF short type Antenna(440-490MHz)		1
KRA-42(M3)	UHF short type Antenna(400-450MHz)		2
KNB-L1	Li-ion Intelligent Battery(S) 2000 mAh	Battery	1
KNB-L2	Li-ion Intelligent Battery(M) 2600 mAh		2
KNB-L3	Li-ion Intelligent Battery(L) 3400 mAh		3
KBH-11	Spring action belt clip (2.5")	Body-worn	1
KBH-8DS	Leather swivel belt loop with portable D-Ring attachment		2
KLH-6SW	Leather swivel belt loop / detachable swivel D-Ring back		3
KLH-137ST	Firemen's heavy-Duty Leather Shoulder Strap for a heavy-Duty Leather Case		4
KLH-201(K3)	Nylon Case _ Cordura Nylon		5
KLH-37BT	Universal "48" Leather Belt		6
KLH-38ST	Shoulder Strap		7
KLH-3SW	Swivel Belt Loop		8
KLH-202(P/P2)	Leather Case (Standard/Full key)		9
KLH-200(K2/K3)	Leather Case (Standard/Full key)		10
KMC-25	MIL-SPEC, Noise canceling Speaker Mic	Audio Accessory	1
KMC-41	MIL-SPEC, IP54/55 Noise- canceling Speaker Mic		2
KMC-41D	MIL-SPEC, IP54/55 Noise- canceling Speaker Mic		3
KMC-42W	MIL-SPEC, IP67 (immersion) Noise-canceling Speaker Mic		4
KMC-42WD	MIL-SPEC, IP67 (immersion) Noise-canceling Speaker Mic		5
KMC-47GPS	GPS Speaker Microphone		6
KMC-47GPSD	GPS Speaker Microphone		7
KMC-54WD	Speaker Microphone		8
KMC-49	MIL-SPEC, Speaker Mic. With Antenna Connector		9
KEP-1	3.5mm earphone kit for KMC-25/26/41M/42WM Speaker Mics		10
KEP-2	2.5mm earphone kit for KMC-17/45 Speaker Mic		11
KEP-3	30" Earphone kit w / 2.5mm plug for KCT-30		12
KEP-4	48" Earphone kit w / 2.5mm plug for KCT-30		13
KCT-30	2.5mm Audio Accessory Adapter for KEP-3/4		14
KCT-51	Hirose 6-pin Adapter(adapts KVL/aftermarket audio acc.to portable connector)		15
KHS-12BE	3-wire mini lapel Mic w/earphone, universal connector(Beige)		16
KHS-12BL	3-wire mini lapel Mic w/earphone, universal connector(Black)		17
KHS-11BE	2-wire palm Mic w/earphone, universal connector(Beige) (USA Option)		18
KHS-11BL	2-wire palm Mic w/earphone, universal connector(Black) (USA Option)		19
KHS-14	Lt. Wt. Single muff headset w/boom Mic & in-line PTT		20
KHS-15-BH	Hvy-duty noise reduction behind-the-headset w/noise cancelling boom Mic & in-line PTT	21	
KHS-15-OH	Hvy-duty noise reduction over-the-headset w/noise cancelling boom Mic & in-line PTT	22	

**Manufacture’s disclosed accessory listing information provided by Kenwood corporation.**

\*Note :Audio Accessory KMC-54WD, KMC-49, was chosen for the testing body worn radio configuration. Audio Accessory KMC-25, KMC-41D, KMC-41D, KMC-42W, KMC-42WD, KMC-47GPS, KMC-47GPSD,KEP-1, KEP-2, KEP-3, KEP-4, KCP-30, KCT-51, KHS-12BE, KHS-12BL, KHS-14, KHS-15-BH, KHS-15-OH, KHS-11BE and KHS-11BL are excluded per KDB 643646 D01 v01r01 page 10 1) A).

**Radio Face Test**

Battery 1			Battery 2			Battery 3		
Ant. 1	Ant. 2	Ant. 3	Ant. 1	Ant. 2	Ant. 3	Ant. 1	Ant. 2	Ant. 3
Yes	Yes	Yes	Yes	Yes	Yes	Yes	Yes	Yes

**Microphone Face Test**

Battery 1			Battery 2			Battery 3		
Ant. 1	Ant. 2	Ant. 3	Ant. 1	Ant. 2	Ant. 3	Ant. 1	Ant. 2	Ant. 3
Yes	Yes	Yes	Yes	Yes	Yes	Yes	Yes	Yes



**Radio Body Test**

Audio Accessory	Battery 1									
	Body-worn 1	Body-worn2	Body-worn3	Body-worn4	Body-worn5	Body-worn6	Body-worn7	Body-worn8	Body-worn9	Body-worn10
Audio Accessory 1	No	No	No	No	No	No	No	No	No	No
Audio Accessory 2	No	No	No	No	No	No	No	No	No	No
Audio Accessory 3	No	No	No	No	No	No	No	No	No	No
Audio Accessory 4	No	No	No	No	No	No	No	No	No	No
Audio Accessory 5	No	No	No	No	No	No	No	No	No	No
Audio Accessory 6	No	No	No	No	No	No	No	No	No	No
Audio Accessory 7	No	No	No	No	No	No	No	No	No	No
Audio Accessory 8	Yes	Yes	No	No	Yes	No	No	No	No	No
Audio Accessory 9	Yes	Yes	No	No	Yes	No	No	No	No	No
Audio Accessory 10	No	No	No	No	No	No	No	No	No	No
Audio Accessory 11	No	No	No	No	No	No	No	No	No	No
Audio Accessory 12	No	No	No	No	No	No	No	No	No	No
Audio Accessory 13	No	No	No	No	No	No	No	No	No	No
Audio Accessory 14	No	No	No	No	No	No	No	No	No	No
Audio Accessory 15	No	No	No	No	No	No	No	No	No	No
Audio Accessory 16	No	No	No	No	No	No	No	No	No	No
Audio Accessory 17	No	No	No	No	No	No	No	No	No	No
Audio Accessory 18	No	No	No	No	No	No	No	No	No	No
Audio Accessory 19	No	No	No	No	No	No	No	No	No	No
Audio Accessory 20	No	No	No	No	No	No	No	No	No	No
Audio Accessory 21	No	No	No	No	No	No	No	No	No	No
Audio Accessory 22	No	No	No	No	No	No	No	No	No	No

**Radio Body Test**

Audio Accessory	Battery 2									
	Body-worn 1	Body-worn2	Body-worn3	Body-worn4	Body-worn5	Body-worn6	Body-worn7	Body-worn8	Body-worn9	Body-worn10
Audio Accessory 1	No	No	No	No	No	No	No	No	No	No
Audio Accessory 2	No	No	No	No	No	No	No	No	No	No
Audio Accessory 3	No	No	No	No	No	No	No	No	No	No
Audio Accessory 4	No	No	No	No	No	No	No	No	No	No
Audio Accessory 5	No	No	No	No	No	No	No	No	No	No
Audio Accessory 6	No	No	No	No	No	No	No	No	No	No
Audio Accessory 7	No	No	No	No	No	No	No	No	No	No
Audio Accessory 8	Yes	Yes	No	No	Yes	No	No	No	No	No
Audio Accessory 9	Yes	Yes	No	No	Yes	No	No	No	No	No
Audio Accessory 10	No	No	No	No	No	No	No	No	No	No
Audio Accessory 11	No	No	No	No	No	No	No	No	No	No
Audio Accessory 12	No	No	No	No	No	No	No	No	No	No
Audio Accessory 13	No	No	No	No	No	No	No	No	No	No
Audio Accessory 14	No	No	No	No	No	No	No	No	No	No
Audio Accessory 15	No	No	No	No	No	No	No	No	No	No
Audio Accessory 16	No	No	No	No	No	No	No	No	No	No
Audio Accessory 17	No	No	No	No	No	No	No	No	No	No
Audio Accessory 18	No	No	No	No	No	No	No	No	No	No
Audio Accessory 19	No	No	No	No	No	No	No	No	No	No
Audio Accessory 20	No	No	No	No	No	No	No	No	No	No
Audio Accessory 21	No	No	No	No	No	No	No	No	No	No
Audio Accessory 22	No	No	No	No	No	No	No	No	No	No

**Radio Body Test**

Audio Accessory	Battery 3									
	Body-worn 1	Body-worn2	Body-worn3	Body-worn4	Body-worn5	Body-worn6	Body-worn7	Body-worn8	Body-worn9	Body-worn10
Audio Accessory 1	No	No	No	No	No	No	No	No	No	No
Audio Accessory 2	No	No	No	No	No	No	No	No	No	No
Audio Accessory 3	No	No	No	No	No	No	No	No	No	No
Audio Accessory 4	No	No	No	No	No	No	No	No	No	No
Audio Accessory 5	No	No	No	No	No	No	No	No	No	No
Audio Accessory 6	No	No	No	No	No	No	No	No	No	No
Audio Accessory 7	No	No	No	No	No	No	No	No	No	No
Audio Accessory 8	Yes	Yes	No	No	Yes	No	No	No	No	No
Audio Accessory 9	Yes	Yes	No	No	Yes	No	No	No	No	No
Audio Accessory 10	No	No	No	No	No	No	No	No	No	No
Audio Accessory 11	No	No	No	No	No	No	No	No	No	No
Audio Accessory 12	No	No	No	No	No	No	No	No	No	No
Audio Accessory 13	No	No	No	No	No	No	No	No	No	No
Audio Accessory 14	No	No	No	No	No	No	No	No	No	No
Audio Accessory 15	No	No	No	No	No	No	No	No	No	No
Audio Accessory 16	No	No	No	No	No	No	No	No	No	No
Audio Accessory 17	No	No	No	No	No	No	No	No	No	No
Audio Accessory 18	No	No	No	No	No	No	No	No	No	No
Audio Accessory 19	No	No	No	No	No	No	No	No	No	No
Audio Accessory 20	No	No	No	No	No	No	No	No	No	No
Audio Accessory 21	No	No	No	No	No	No	No	No	No	No
Audio Accessory 22	No	No	No	No	No	No	No	No	No	No

## 5. DESCRIPTION OF TEST EQUIPMENT

### 5.1 SAR MEASUREMENT SETUP

These measurements are performed using the DASY4 automated dosimetric assessment system. It is made by Schmid & Partner Engineering AG (SPEAG) in Zurich, Switzerland. It consists of high precision robotics system (Staubli), robot controller, Pentium III computer, near-field probe, probe alignment sensor, and the generic twin phantom containing the brain equivalent material. The robot is a six-axis industrial robot performing precise movements to position the probe to the location (points) of maximum electromagnetic field (EMF) (see Figure.2).

A cell controller system contains the power supply, robot controller, teach pendant (Joystick), and remote control, is used to drive the robot motors. The PC consists of the HP Pentium IV 3.0GHz computer with Windows XP system and SAR Measurement Software DASY4, A/D interface card, monitor, mouse, and keyboard. The Staubli Robot is connected to the cell controller to allow software manipulation of the robot. A data acquisition electronic (DAE) circuit performs the signal amplification, signal multiplexing, AD-conversion, offset measurements, mechanical surface detection, collision detection, etc. is connected to the Electro-optical coupler (EOC). The EOC performs the conversion from the optical into digital electric signal of the DAE and transfers data to the PC plug-in card.

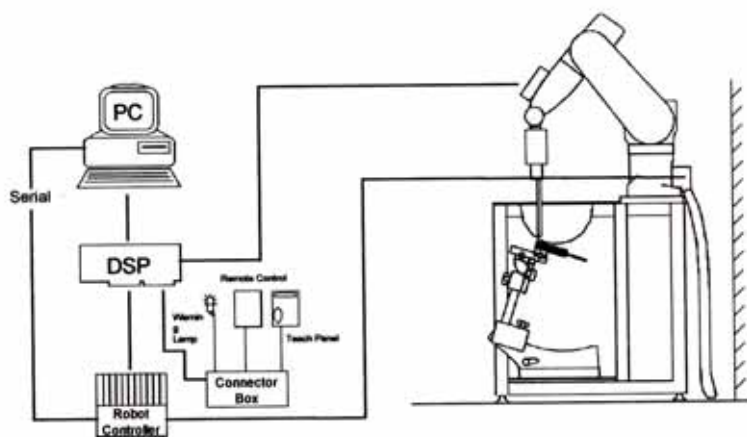

Figure 2. HCT SAR Lab. Test Measurement Set-up

The DAE4 consists of a highly sensitive electrometer-grade preamplifier with auto-zeroing, a channel and gain-switching multiplexer, a fast 16 bit AD-converter and a command decoder and control logic unit. Transmission to the PC-card is accomplished through an optical downlink for data and status information and an optical uplink for commands and clock lines. The mechanical probe mounting device includes two different sensor systems for frontal and sideways probe contacts. They are also used for mechanical surface detection and probe collision detection. The robot uses its own controller with a built in VME-bus computer. The system is described in detail in.

## 5.2 DASY E-FIELD PROBE SYSTEM

### 5.2.1 ET3DV6 Probe Specification

Construction	Symmetrical design with triangular core Built-in optical fiber for surface detection System Built-in shielding against static charges
Calibration	In air from 10 MHz to 2.5 GHz In brain and muscle simulating tissue at Frequencies of 450 MHz, 900 MHz and 1.8 GHz (accuracy: 8%)
Frequency	10 MHz to >3 GHz; Linearity: $\pm 0.2$ dB (30 MHz to 3 GHz)
Directivity	$\pm 0.2$ dB in brain tissue (rotation around probe axis) $\pm 0.4$ dB in brain tissue (rotation normal probe axis)
Dynamic	5 $\mu$ W/g to > 100 mW/g;
Range Linearity:	$\pm 0.2$ dB
Surface Detection	$\pm 0.2$ mm repeatability in air and clear liquids over diffuse reflecting surfaces.
Dimensions	Overall length: 330 mm Tip length: 16 mm Body diameter: 12 mm Tip diameter: 6.8 mm Distance from probe tip to dipole centers: 2.7 mm
Application	General dissymmetry up to 3 GHz Compliance tests of WCDMA/LTE Phones Fast automatic scanning in arbitrary phantoms



Figure 3. Photograph of the probe and the Phantom

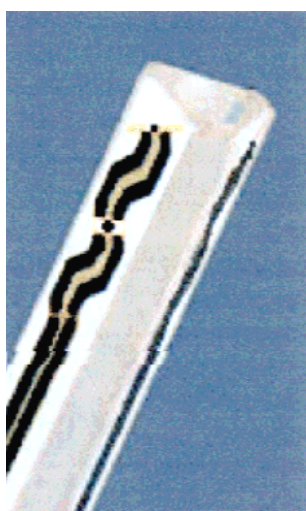

Figure 4. ET3DV6 E-field Probe

The SAR measurements were conducted with the dosimetric probe ET3DV6, designed in the classical triangular configuration and optimized for dosimetric evaluation. The probe is constructed using the thick film technique; with printed resistive lines on ceramic substrates. The probe is equipped with an optical multifiber line ending at the front of the probe tip. It is connected to the EOC box on the robot arm and provides an automatic detection of the phantom surface. Half of the fibers are connected to a pulsed infrared transmitter, the other half to a synchronized receiver. As the probe approaches the surface, the reflection from the surface produces a coupling from the transmitting to the receiving fibers. This reflection increases first during the approach, reaches a maximum and then decreases. If the probe is flatly touching the surface, the coupling is zero. The distance of the coupling maximum to the surface is independent of the surface reflectivity and largely independent of the surface to probe angle. The DASY4 software reads the reflection during a software approach and looks for the maximum using a 2<sup>nd</sup> order fitting. The approach is stopped at reaching the maximum.

## 5.3 PROBE CALIBRATION PROCESS

### 5.3.1 E-Probe Calibration

Each probe is calibrated according to a dosimetric assessment procedure with an accuracy better than ± 10%. The spherical isotropy was evaluated with the proper procedure and found to be better than ± 0.25dB. The sensitivity parameters (NormX, NormY, NormZ), the diodecompression parameter (DCP) and the conversion factor (ConvF) of the probe is tested.

The free space E-field from amplified probe outputs is determined in a test chamber. This is performed in a TEM cell for frequencies below 1 GHz, and in a waveguide above 1 GHz for free space. For the free space calibration, the probe is placed in the volumetric center of the cavity and at the proper orientation with the field. The probe is then rotated 360 degrees.

E-field temperature correlation calibration is performed in a flat phantom filled with the appropriate simulated brain tissue. The measured free space E-field in the medium correlates to temperature rise in a dielectric medium. For temperature correlation calibration a RF transparent thermistor-based temperature probe is used in conjunction with the E-field probe.

$$SAR = C \frac{\Delta T}{\Delta t} \Rightarrow SAR = \frac{|E^2| \cdot \sigma}{\rho}$$

where:

$\Delta t$  = exposure time (30 seconds),  $\sigma$  = simulated tissue conductivity,

$C$  = heat capacity of tissue (brain or muscle),

$\Delta T$  = temperature increase due to RF exposure.

SAR is proportional to  $\Delta T/\Delta t$ , the initial rate of tissue heating, before thermal diffusion takes place.

Now it's possible to quantify the electric field in the simulated tissue by equating the thermally derived SAR to the E-field;

where:

$\rho$  = Tissue density (1.25 g/cm<sup>3</sup> for brain tissue)

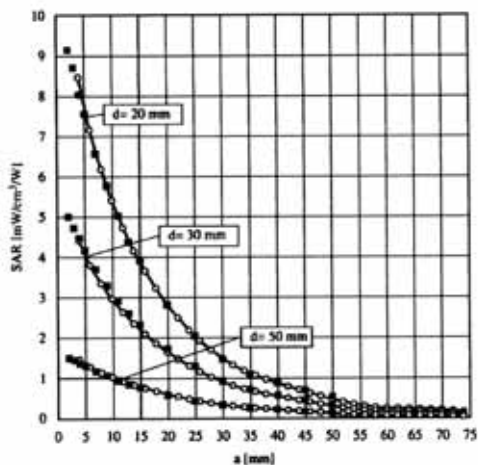

Figure 7. E-Field and Temperature measurements at 900MHz

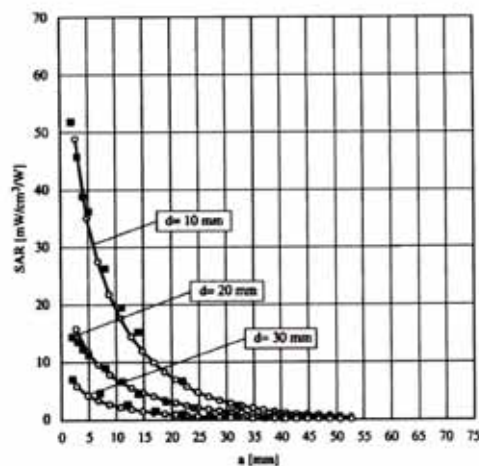

Figure 8. E-Field and temperature measurements at 1.8GHz

### 5.3.2 Data Extrapolation

The DASY4 software automatically executes the following procedures to calculate the field units from the microvolt readings at the probe connector. The first step of the evaluation is a linearization of the filtered input signal to account for the compression characteristics of the detector diode. The compensation depends on the input signal, the diode type and the DC-transmission factor from the diode to the evaluation electronics. If the exciting field is pulsed, the crest factor of the signal must be known to correctly compensate for peak power. The formula for each channel can be given like below;

$$V_i = U_i + U_i^2 \cdot \frac{cf}{dcp_i} \quad \text{with}$$

- $V_i$  = compensated signal of channel i (i=x,y,z)
- $U_i$  = input signal of channel i (i=x,y,z)
- $cf$  = crest factor of exciting field (DASY parameter)
- $dcp_i$  = diode compression poing (DASY parameter)

From the compensated input signals the primary field data for each channel can be evaluated:

E-field probes: with

$$E_i = \sqrt{\frac{V_i}{Norm_i \cdot ConvF}}$$

- $V_i$  = compensated signal of channel i (i=x,y,z)
- $Norm_i$  = sensor sensitivity of channel i (i=x,y,z)  
 $\mu V / (V/m)^2$  for E-field probes
- $ConvF$  = sensitivity of enhancement in solution
- $E_i$  = electric field strength of channel i in V/m

The RSS value of the field components gives the total field strength (Hermetian magnitude):

$$E_{tot} = \sqrt{E_x^2 + E_y^2 + E_z^2}$$

The primary field data are used to calculate the derived field units.

$$SAR = E_{tot}^2 \cdot \frac{\sigma}{\rho \cdot 1000} \quad \text{with}$$

- $SAR$  = local specific absorption rate in W/g
- $E_{tot}$  = total field strength in V/m
- $\sigma$  = conductivity in [mho/m] or [Siemens/m]
- $\rho$  = equivalent tissue density in  $g/cm^3$

The power flow density is calculated assuming the excitation field to be a free space field.

$$P_{pwe} = \frac{E_{tot}^2}{3770} \quad \text{with}$$

- $P_{pwe}$  = equivalent power density of a plane wave in  $w/cm^2$
- $E_{tot}$  = total electric field strength in V/m

## 5.4 SAM Phantom

Phantom for compliance testing of handheld and body-mounted wireless devices in the frequency range of 30 MHz to 6 GHz. ELI is fully compatible with the IEC 62209-2 standard and all known tissue simulating liquids. ELI has been optimized regarding its performance and can be integrated into our standard phantom tables. A cover prevents evaporation of the liquid. Reference markings on the phantom allow installation of the complete setup, including all predefined phantom positions and measurement grids, by teaching three points. The phantom is compatible with all SPEAG dosimetric probes and dipoles.

ELI V5.0 has the same shell geometry and is manufactured from the same material as ELI4, but has reinforced top structure.



Figure 9. SAM Phantom

Shell Thickness	2.0 mm $\pm$ 0.2 mm (6 $\pm$ 0.2 mm at ear point)
Filling Volume	about 25 L
Dimensions	810 mm x 1000 mm x 500 mm (H x L x W)

## 5.5 Device Holder for Transmitters

In combination with the SAM Phantom V4.0, the Mounting Device (POM) enables the rotation of the mounted transmitter in spherical coordinates whereby the rotation points is the ear opening. The devices can be easily, accurately, and repeatably positioned according to the FCC and CENELEC specifications. The device holder can be locked at different phantom locations (left head, right head, flat phantom).

Note: A simulating human hand is not used due to the complex anatomical and geometrical structure of the hand that may produce an infinite number of configurations. To produce the Worst-case condition (the hand absorbs antenna output power), the hand is omitted during the tests.



Figure01.Device Holder



## 5.6 Brain & Muscle Simulating Mixture Characterization

The brain and muscle mixtures consist of a viscous gel using hydrox-ethyl cellulose (HEC) gelling agent and saline solution (see Table 3.1). Preservation with a bactericide is added and visual inspection is made to make sure air bubbles are not trapped during the mixing process. The mixture is calibrated to obtain proper dielectric constant (permittivity) and conductivity of the desired tissue. The mixture characterizations used for the brain and muscle tissue simulating liquids are according to the data by C. Gabriel and G. Hartsgrave.

Ingredients (% by weight)	Frequency (MHz)	
	450	
Tissue Type	Head	Body
Water	38.91 %	46.21 %
Salt (NaCl)	3.79 %	2.34 %
Sugar	56.93 %	51.17 %
HEC	0.25 %	0.18 %
Bactericide	0.12 %	0.08 %
Triton X-100	-	-
DGBE	-	-
Diethyleneglycolhexylether	-	-

Salt:	99%Pure Sodium Chloride	Sugar:	98%Pure Sucrose
Water:	De-ionized, 16M resistivity	HEC:	Hydroxyethyl Cellulose
DGBE:	99% Di(ethylene glycol) butyl ether,[2-(2-butoxyethoxy)ethanol]		
Triton X-100(ultra pure):	Polyethylene glycol mono[4-(1,1,3,3-tetramethylbutyl)phenyl] ether		

**Table 3.1 Composition of the Tissue Equivalent Matter**

## 5.7 SAR TEST EQUIPMENT

Manufacturer	Type / Model	S/N	Calib. Date	Calib.Interval	Calib.Due
SPEAG	SAM Phantom	-	N/A	N/A	N/A
SPEAG	Triple Modular Phantom	-	N/A	N/A	N/A
Staubli	Robot TX90Lspeag	F13/5R4XF1/A/01	N/A	N/A	N/A
Staubli	Robot ControllerCS7MB	F13/5R4XF1/C/01	N/A	N/A	N/A
HP	Pavilion t000_puffer	KRJ51201TV	N/A	N/A	N/A
SPEAG	Light Alignment Sensor	SE UKS 030 AA	N/A	N/A	N/A
Staubli	Teach Pendant (Joystick)	D21142605	N/A	N/A	N/A
SPEAG	DAE4	652	Mar. 26, 2014	Annual	Mar. 26, 2015
SPEAG	DAE4	1417	Jan. 03, 2014	Annual	Jan. 03, 2015
SPEAG	DAE3	466	Feb. 27, 2014	Annual	Feb. 27, 2015
SPEAG	E-Field Probe ET3DV6	1605	Jan. 31, 2014	Annual	Jan. 31, 2015
SPEAG	E-Field Probe ET3DV6	1798	Aug. 25, 2014	Annual	Aug. 25, 2015
SPEAG	Dipole D450V2	1007	Aug.19, 2014	Annual	Aug.19, 2015
Agilent	Power Meter(F) E4419B	MY41291386	Oct. 27, 2014	Annual	Oct. 27, 2015
Agilent	Power Sensor(G) 8481	MY41090680	Oct. 27, 2014	Annual	Oct. 27, 2015
HP	Dielectric Probe Kit 85070C	00721521	CBT		
HP	Dual Directional Coupler 778D	16072	Oct. 27, 2014	Annual	Oct. 27, 2015
Agilent	Base Station E5515C	GB44400269	Feb. 10, 2014	Annual	Feb. 10, 2015
HP	Signal Generator 8664A	3744A02069	Oct. 27, 2014	Annual	Oct. 27, 2015
Hewlett Packard	11636B/Power Divider	58698	Mar. 03. 2014	Annual	Mar. 03. 2015
Agilent	N9020A/ SIGNAL ANALYZER	MY50510407	Mar. 25, 2014	Annual	Mar. 25, 2015
TESCOM	TC-3000C / BLUETOOTH	3000C000276	Apr. 11, 2014	Annual	Apr. 11. 2015
HP	Network Analyzer 8753ES	JP39240221	Mar. 21, 2014	Annual	Mar. 21, 2015

**NOTE:**

1. The E-field probe was calibrated by SPEAG, by the waveguide technique procedure. Dipole Verification measurement is performed by HCT Lab. before each test. The brain/body simulating material is calibrated by HCT using the dielectric probe system and network analyzer to determine the conductivity and permittivity (dielectric constant) of the brain/body-equivalent material.

2. CBT(Calibrating Before Testing). Prior to testing, the dielectric probe kit was calibrated via the network analyzer, with the specified procedure(calibrated in pure water) and calibration kit(standard) short circuit, before the dielectric measurement. The specific procedure and calibration kit are provided by Agilent

## 6. SAR MEASUREMENT PROCEDURE

The evaluation was performed with the following procedure:

1. The SAR value at a fixed location above the ear point was measured and was used as a reference value for assessing the power drop.
2. The SAR distribution at the exposed side of the head was measured at a distance of 3.9mm from the innersurface of the shell. The area covered the entire dimension of the head and the horizontal grid spacing was 15mm x 15mm. Based on this data, the area of the maximum absorption was determined by spline interpolation.
3. Around this point, a volume of 32mm x 32mm x 30 mm was assessed by measuring 5 x 5 x 7 points. On this basis of this data set, the spatial peak SAR value was evaluated with the following procedure:
  - a. The data at the surface were extrapolated, since the center of the dipoles is 2.7mm away from the tip of the probe and the distance between the surface and the lowest measuring point is 1.2mm. The extrapolation was based on a least square algorithm. A polynomial of the fourth order was calculated through the points in z-axis. This polynomial was then used to evaluate the points between the surface and the probe tip.
  - b. The maximum interpolated value was searched with a straight-forward algorithm. Around this maximum the SAR values averaged over the spatial volumes (1g or 10g) were computed using the 3D-Spline interpolation algorithm. The 3D-spline is composed of three one-dimensional splines with the "Not a knot" condition (in x, y, and z directions). The volume was integrated with the trapezoidal algorithm. One thousand points (10 x 10 x 10) were interpolated to calculate the average.
  - c. All neighboring volumes were evaluated until no neighboring volume with a higher average value was found.
4. The SAR value, at the same location as procedure #1, was re-measured. If the value changed by more than 5%, the evaluation is repeated.

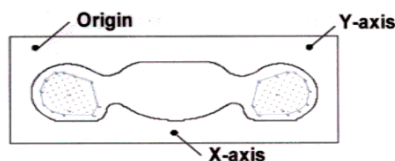

Figure 12. SAR Measurement Point in Area Scan

First Area Scan is used to locate the approximate location(s) of the local peak SAR value(s). The measurement grid within an Area Scan is defined by the grid extend, grid step size and grid offset. Next, in order to determine the EM field distribution in a three-dimensional spatial extension, Zoom Scan is required. The Zoom Scan is performed around the highest E-field value to determine the averaged SAR-distribution over 10g.

Area scan and zoom scan resolution setting follow KDB 865664 D01v01r03 quoted below.

		$\leq 3$ GHz	$> 3$ GHz
Maximum distance from closest measurement point (geometric center of probe sensors) to phantom surface		$5 \pm 1$ mm	$\frac{1}{2} \cdot \delta \cdot \ln(2) \pm 0.5$ mm
Maximum probe angle from probe axis to phantom surface normal at the measurement location		$30^\circ \pm 1^\circ$	$20^\circ \pm 1^\circ$
Maximum area scan spatial resolution: $\Delta x_{Area}, \Delta y_{Area}$		$\leq 2$ GHz: $\leq 15$ mm 2 – 3 GHz: $\leq 12$ mm	3 – 4 GHz: $\leq 12$ mm 4 – 6 GHz: $\leq 10$ mm
		When the x or y dimension of the test device, in the measurement plane orientation, is smaller than the above, the measurement resolution must be $\leq$ the corresponding x or y dimension of the test device with at least one measurement point on the test device.	
Maximum zoom scan spatial resolution: $\Delta x_{Zoom}, \Delta y_{Zoom}$		$\leq 2$ GHz: $\leq 8$ mm 2 – 3 GHz: $\leq 5$ mm*	3 – 4 GHz: $\leq 5$ mm* 4 – 6 GHz: $\leq 4$ mm*
Maximum zoom scan spatial resolution, normal to phantom surface	uniform grid: $\Delta z_{Zoom}(n)$	$\leq 5$ mm	3 – 4 GHz: $\leq 4$ mm 4 – 5 GHz: $\leq 3$ mm 5 – 6 GHz: $\leq 2$ mm
	graded grid	$\Delta z_{Zoom}(1)$ : between 1 <sup>st</sup> two points closest to phantom surface	$\leq 4$ mm
		$\Delta z_{Zoom}(n>1)$ : between subsequent points	$\leq 1.5 \cdot \Delta z_{Zoom}(n-1)$
Minimum zoom scan volume	x, y, z	$\geq 30$ mm	3 – 4 GHz: $\geq 28$ mm 4 – 5 GHz: $\geq 25$ mm 5 – 6 GHz: $\geq 22$ mm
<p>Note: <math>\delta</math> is the penetration depth of a plane-wave at normal incidence to the tissue medium; see draft standard IEEE P1528-2011 for details.</p> <p>* When zoom scan is required and the <i>reported</i> SAR from the area scan based <i>1-g SAR estimation</i> procedures of KDB 447498 is <math>\leq 1.4</math> W/kg, <math>\leq 8</math> mm, <math>\leq 7</math> mm and <math>\leq 5</math> mm zoom scan resolution may be applied, respectively, for 2 GHz to 3 GHz, 3 GHz to 4 GHz and 4 GHz to 6 GHz.</p>			

## **7. DESCRIPTION OF TEST POSITION**

### **7.1 Body Holster/Belt Clip Configurations**

Body-worn operating configurations are tested with the belt-clips and holsters attached to the device and positioned against a flat phantom in a normal use configuration. A device with a headset output is tested with a headset connected to the device. Body dielectric parameters are used.

Accessories for Body-worn operation configurations are divided into two categories: those that do not contain metallic components and those that contain metallic components. When multiple accessories that do not contain metallic components are supplied with the device, the device is tested with only the accessory that dictates the closest spacing to the body. Then multiple accessories that contain metallic components are tested with each accessory. If multiple accessories share an identical metallic component (i.e. the same metallic belt-clip used with different holsters with no other metallic components) only the accessory that dictates the closest spacing to the body is tested.

Body-worn accessories may not always be supplied or available as options for some Devices intended to be authorized for body-worn use. In this case, a test configuration with a separation distance between the back of the device and the flat phantom is used.

Transmitters that are designed to operate in front of a person's face, as in push-to-talk configurations, are tested for SAR compliance with the front of the device positioned to face the flat phantom. For devices that are carried next to the body such as a shoulder, waist or chest-worn transmitters, SAR compliance is tested with the accessory(ies), including headsets and microphones, attached to the device and positioned against a flat phantom in a normal use configuration.

In all cases SAR measurements are performed to investigate the worst-case positioning. Worst case positioning is then documented and used to perform Body SAR testing.

## 8. ANSI/ IEEE C95.1 - 1992 RF EXPOSURE LIMITS

HUMAN EXPOSURE	UNCONTROLLED ENVIRONMENT General Population (W/kg) or (mW/g)	CONTROLLED ENVIRONMENT Occupational (W/kg) or (mW/g)
SPATIAL PEAK SAR * (Brain)	1.60	8.00
SPATIAL AVERAGE SAR ** (Whole Body)	0.08	0.40
SPATIAL PEAK SAR *** (Hands / Feet / Ankle / Wrist)	4.00	20.00

**Table 8.1 Safety Limits for Partial Body Exposure**

**NOTES:**

- \* The Spatial Peak value of the SAR averaged over any 1 g of tissue (defined as a tissue volume in the shape of a cube) and over the appropriate averaging time.
- \*\* The Spatial Average value of the SAR averaged over the whole-body.
- \*\*\* The Spatial Peak value of the SAR averaged over any 10 g of tissue (defined as a tissue volume in the shape of a cube) and over the appropriate averaging time.

**Uncontrolled Environments** are defined as locations where there is the exposure of individuals who have no knowledge or control of their exposure.

**Controlled Environments** are defined as locations where there is exposure that may be incurred by persons who are aware of the potential for exposure, (i.e.as a result of employment or occupation).

## 9. SAR SYSTEM VALIDATION

Per FCC KCB 865664 D02v01r01, SAR system validation status should be document to confirm measurement accuracy. The SAR systems (including SAR probes, system components and software versions) used for this device were validated against its performance specifications prior to the SAR measurements. Reference dipoles were used with the required tissue- equivalent media for system validation, according to the procedures outlined in IEEE 1528-2003 and FCC KDB 865664 D01v01r03. Since SAR probe calibrations are frequency dependent, each probe calibration point was validated at a frequency within the valid frequency range of the probe calibration point, using the system that normally operates with the probe for routine SAR measurements and according to the required tissue-equivalent media.

A tabulated summary of the system validation status including the validation date(s), measurement frequencies, SAR probes and tissue dielectric parameters has been included.

SAR System #	Probe	Probe Type	Probe Calibration Point		Dipole	Date	Dielectric Parameters		CW Validation			Modulation Validation		
							Measured Permittivity	Measured Conductivity	Sensitivity	Probe Linearity	Probe Isotropy	MOD. Type	Duty Factor	PAR
2	1605	ET3DV6	Head	450	1007	Sep. 10,2014	45.423	0.843	PASS	PASS	PASS	N/A	N/A	N/A
2	1605	ET3DV6	Body	450	1007	Sep. 10,2014	55.4	0.941	PASS	PASS	PASS	N/A	N/A	N/A
3	1798	ET3DV6	Head	450	1007	Oct. 13,2014	45.348	0.854	PASS	PASS	PASS	N/A	N/A	N/A
3	1798	ET3DV6	Body	450	1007	Oct. 13,2014	55.246	0.956	PASS	PASS	PASS	N/A	N/A	N/A

**Table 9.1 SAR System Validation Summary**

**Note;**

All measurement were performed using probes calibrated for CW signal only. Modulations in the table above represent test configurations for which the measurement system has been validated per FCC KDB Publication 865664 D01v01r03. SAR system were validated for modulated signals with a periodic duty cycle, such as GMSK, or with a high peak to average ratio (>5 dB), such as OFDM according to KDB 865664 D01v01r03.

# 10. SYSTEM VERIFICATION

## 10.1 Tissue Verification

Freq. [MHz]	Date	Probe	Dipole	Liquid	Liquid Temp [°C]	Parameters	Target Value	Measured Value	Deviation [%]	Limit [%]	
400	Sep. 23, 2014	1605	1007	Head	20.4	$\epsilon_r$	44.1	45.24	+ 2.59	$\pm 5$	
						$\sigma$	0.87	0.83	- 4.60	$\pm 5$	
400	Sep. 21, 2014	1605		Body	20.3	$\epsilon_r$	57.2	56.25	- 1.66	$\pm 5$	
						$\sigma$	0.933	0.89	- 4.61	$\pm 5$	
400	Sep. 22, 2014	1605		Body	20.5	$\epsilon_r$	57.2	56.35	- 1.49	$\pm 5$	
						$\sigma$	0.933	0.887	- 4.93	$\pm 5$	
400	Oct. 14, 2014	1605		Head	20.7	$\epsilon_r$	44.1	45.337	+ 2.80	$\pm 5$	
						$\sigma$	0.87	0.832	- 4.37	$\pm 5$	
400	Oct. 14, 2014	1605		Body	20.7	$\epsilon_r$	57.2	56.5	- 1.22	$\pm 5$	
						$\sigma$	0.933	0.888	- 4.82	$\pm 5$	
450	Sep. 23, 2014	1605		1007	Head	20.4	$\epsilon_r$	43.5	43.883	+ 0.88	$\pm 5$
							$\sigma$	0.87	0.867	- 0.34	$\pm 5$
450	Sep. 22, 2014	1605	Body		20.3	$\epsilon_r$	56.7	55.298	- 2.47	$\pm 5$	
						$\sigma$	0.94	0.933	- 0.74	$\pm 5$	
450	Sep. 21, 2014	1605	Body		20.5	$\epsilon_r$	56.7	55.398	- 2.30	$\pm 5$	
						$\sigma$	0.94	0.938	- 0.21	$\pm 5$	
450	Oct. 14, 2014	1605	Head		20.7	$\epsilon_r$	43.5	43.959	+ 1.06	$\pm 5$	
						$\sigma$	0.87	0.867	-0.34	$\pm 5$	
450	Oct. 14, 2014	1605	Body		20.7	$\epsilon_r$	56.7	55.308	-2.46	$\pm 5$	
						$\sigma$	0.94	0.938	-0.21	$\pm 5$	
470	Sep. 23, 2014	1605	1007		Head	20.4	$\epsilon_r$	43.5	43.469	- 0.07	$\pm 5$
							$\sigma$	0.87	0.885	+ 1.72	$\pm 5$
470	Sep. 21, 2014	1605		Body	20.3	$\epsilon_r$	56.7	54.948	- 3.09	$\pm 5$	
						$\sigma$	0.94	0.951	+ 1.17	$\pm 5$	
470	Sep. 22, 2014	1605		Body	20.5	$\epsilon_r$	56.7	54.998	- 3.00	$\pm 5$	
						$\sigma$	0.94	0.953	+ 1.38	$\pm 5$	
470	Oct. 14, 2014	1605		Head	20.7	$\epsilon_r$	43.5	43.527	+ 0.06	$\pm 5$	
						$\sigma$	0.87	0.886	+ 1.84	$\pm 5$	
470	Oct. 14, 2014	1605		Body	20.7	$\epsilon_r$	56.7	54.928	- 3.13	$\pm 5$	
						$\sigma$	0.94	0.953	- 1.38	$\pm 5$	
400	Jan. 6, 2015	1798		1007	Head	20.2	$\epsilon_r$	44.1	46.281	+ 4.95	$\pm 5$
							$\sigma$	0.87	0.854	- 1.84	$\pm 5$
400	Jan. 6, 2015	1798	Body		20.2	$\epsilon_r$	57.2	56.272	- 1.62	$\pm 5$	
						$\sigma$	0.933	0.919	- 1.50	$\pm 5$	
450	Jan. 6, 2015	1798	Head		20.2	$\epsilon_r$	43.5	45.124	+ 3.73	$\pm 5$	
						$\sigma$	0.87	0.895	+ 2.87	$\pm 5$	
450	Jan. 6, 2015	1798	Body		20.2	$\epsilon_r$	56.7	54.652	- 3.61	$\pm 5$	
						$\sigma$	0.94	0.952	+ 1.28	$\pm 5$	

The Tissue dielectronic parameters were measured prior to the SAR evaluation using an Agilent 85070C Dielectronic Probe Kit and Agilent Network Analyzer.



## 10.2 System Verification

Prior to assessment, the system is verified to the  $\pm 10\%$  of the specifications at 450 MHz by using the system Verification kit. (Graphic Plots Attached)

Freq. [MHz]	Date	Probe (SN)	Dipole (SN)	Liquid	Amb. Temp. [°C]	Liquid Temp. [°C]	1 W Target SAR <sub>1g</sub> (SPEAG) (mW/g)	Measured SAR <sub>1g</sub> (mW/g)	1 W Normalized SAR <sub>1g</sub> (mW/g)	Deviation [%]	Limit [%]
450	Sep. 23, 2014	1605	1007	Head	20.6	20.4	4.89	0.464	4.64	- 5.11	$\pm 10$
450	Sep. 22, 2014	1605		Body	20.5	20.3	4.84	0.501	5.01	+ 3.51	$\pm 10$
450	Sep. 21, 2014	1605		Body	20.7	20.5	4.84	0.483	4.83	- 0.21	$\pm 10$
450	Oct. 14, 2014	1605		Head	20.7	20.5	4.89	0.500	5.00	+ 2.25	$\pm 10$
450	Oct. 14, 2014	1605		Body	20.7	20.5	4.84	0.497	4.97	+ 2.69	$\pm 10$
450	Jan. 6, 2015	1798		Head	20.4	20.2	4.89	0.473	4.73	- 3.27	$\pm 10$
450	Jan. 6, 2015	1798		Body	20.4	20.2	4.84	0.481	4.81	- 0.62	$\pm 10$

## 10.3 System Verification Procedure

SAR measurement was prior to assessment, the system is verified to the  $\pm 10\%$  of the specifications at each frequencyband by using the system Verification kit. (Graphic Plots Attached)

- Cabling the system, using the Verification kit equipments.
- Generate about 100 mW Input Level from the Signal generator to the Dipole Antenna.
- Dipole Antenna was placed below the Flat phantom.
- The measured one-gram SAR at the surface of the phantom above the dipole feed-point should be within 10 % of the target reference value.
- The results are normalized to 1 W input power.

NOTE;

SAR Verification was performed according to the FCC KDB 865664D01v01r03.

## 11. RF CONDUCTED POWER MEASUREMENT

Power measurements were performed using a base station simulator under digital average power. The handset was placed into a simulated call using a base station simulator in a shielded chamber. Such test signals offer a consistent means for testing SAR and are recommended for evaluation SAR. SAR measurements were taken with a fully charged battery. In order to verify that the device was tested and maintained at full power, this was configured with the base station simulator. The SAR measurement Software calculates a reference point at the start and end of the test to check for power drifts. If conducted Power deviations of more than 5 % occurred, the tests were repeated.

### 11.1 Output Power Specifications.

This device operates using the following maximum output power specifications. SAR values were scaled to the maximum allowed power to determine compliance per KDB publication 447498 D01v05r02.

<b>Transceiver section</b>
Output Power : 5W
Tune-up Tolerance : - 0.2 W/ +0.2 W

<b>Bluetooth section</b>
Output Power : 2.5mW

## 11.2 Output Average Conducted Power

UHF			
Model	Frequency	Channel	Power(dBm)
Nx-5300-K5	406.1	1	37.00
	422.075	2	36.97
	438.05	3	36.93
	454.025	4	36.95
	470	5	36.93
Nx-5300-K6	406.1	1	37.00
	422.075	2	36.98
	438.05	3	36.94
	454.025	4	36.95
	470	5	36.94

For FCC Band:

Per KDB 447498 D01 v05r01 Page 7 section 6) pages 7-8, the number of channels required to be tested is as follows.

$F_{high}$  = 406.1 MHz

$F_c$  = 438.05 MHz

$F_{Low}$  = 470 MHz

$N_c = \text{Round} \{ [100(f_{high} - f_{low}) / f_c]^{0.5} \times (f_c / 100)^{0.2} \} = \text{Round} \{ [100(512-450) / 481]^{0.5} \times (481 / 100)^{0.2} \} = 5$

Therefore, for the frequency band from 450 MHz to 512, 5channels are required for testing.

## 11.3 SAR Test Exclusions Applied

### 11.3.1BT

Per FCC KDB 447498 D01v05r02, The SAR exclusion threshold for distance < 50mm is defined by the following equation:

$$\frac{MaxPowerofChannel(mW)}{TestSeparationDistance(mm)} * \sqrt{Frequency(GHz)} \leq 3.0$$

. Mode	Frequency	Maximum Allowed Power	Separation Distance	3.0
	[MHz]	[mW]	[mm]	
Bluetooth	2480	2.5	25	0.16

Based on the maximum conducted power of Bluetooth and antenna to use separation distance, Bluetooth SAR was not required  $[(2.5/25)*\sqrt{2.480}] = 0.16 < 3.0$ .

this device contains transmitters that may operate simultaneously. Therefore simultaneous transmission analysis is required. Per FCC KDB 447498 D01v05r02 IV.C.1iii, simultaneous transmission SAR test exclusion may be applied when the sum of the 1-g SAR for all the simultaneous transmitting antennas in a specific a physical test configuration is  $\leq 1.6W/kg$ . When standalone SAR is not required to be measured per FCC KDB 447498 D01v05r02 4.3.22, the following equation must be used to estimate the standalone 1-g SAR for simultaneous transmission assessment involving that transmitter

$$Estimated\ SAR = \frac{\sqrt{f(GHZ)}}{7.5} * \frac{(Max\ Power\ of\ channel\ mW)}{Min\ Seperation\ Distance}$$

. Mode	Frequency	Maximum Allowed Power	separation Distance (Body)	Estimated SAR (Body)
	[MHz]	[mW]	[mm]	[W/kg]
Bluetooth	2441	2.5	25	0.02

**Note :** Held-to ear configurations are not applicable to Bluetooth operations and therefore were not considered for simultaneous transmission. The Estimated SAR results were determined according to FCC KDB447498 D01v05r02.

## 12. SAR TEST DATA SUMMARY

### 12.1 Measurement Results (Face-held SAR)

Frequency		Mode	Power (dBm)		Power Drift (dB)	Battery	Model	Antenna	Separation Distance	Measured SAR(mW/g)	Adjusted SAR(mW/g)	SAR 50% Duty (mW/g)	Plot No.
MHz	Ch.		Tune-Up Limit	Conducted Power									
406.1	1	FM	37.16	37	-0.09	KNB-L3	NX-5300-K6	KRA-42(M3)	25mm	4.11	4.35	2.18	
406.1	1		37.16	37	-0.12	KNB-L3	NX-5300-K6	KRA-29	25mm	4.7	5.01	2.51	1
454.025	4		37.16	36.95	-0.17	KNB-L3	NX-5300-K6	KRA-42(M)	25mm	3.27	3.57	1.78	
406.1	1		37.16	37	-0.09	KNB-L1	NX-5300-K6	KRA-29	25mm	4.3	4.55	2.28	
406.1	1		37.16	37	-0.17	KNB-L2	NX-5300-K6	KRA-29	25mm	4.53	4.89	2.44	
406.1	1		37.16	37	-0.14	KNB-L3	NX-5300-K5	KRA-29	25mm	4.3	4.61	2.30	
ANSI/ IEEE C95.1 - 1992- Safety Limit Spatial Peak controlled Exposure/ Occupational										Head 8 W/kg (mW/g) Averaged over 1 gram			

- The test data reported are the worst-case SAR values according to test procedures specified in IEEE 1528-2003, FCC KDB Procedure.
- All modes of operation were investigated and the worst-case are reported.
- The manufacturer has confirmed that the device(s) tested have the same physical, mechanical and thermal characteristics and are within operational tolerances expected for production units
- Liquid tissue depth was at least 15.0 cm for all frequencies
- Tissue parameters and temperatures are listed on the SAR plot.
- Batteries are fully charged at the beginning of the SAR measurements.
- Test Signal Call Mode Manual Test cord Base Station Simulator
- SAR Configuration Head Body Hand
- The EUT was tested for face-held SAR with a 2.5cm separation distance between the front of the EUT and the outer surface of the planer phantom
- SAR Measurement Time 30min
- The adjusted SAR value was calculated by first scaling the SAR value up by the drift. This value was then scaled up based on the difference of the upper end the tolerance (37.16dBm) and the measured conducted power. The resultant value is then multiplied by 0.5 to give the SAR value at 50% duty cycle
- SAR results were scaled to the maximum allowed power to demonstrate compliance per FCC KDB 447498 D01v05r02.  
Test Procedures applied in accordance with FCC KDB 643646 D01v01
- For Face-held configuration, the highest capacity battery was selected as the default battery.(KNB-L3)
- Measurement was reduced per KDB 643646 D01 v01r01
- When the SAR for all antennas tested using the default battery is 3.5 W/kg (50% PTT duty factor), testing of all other required channels is not necessary.
- When the SAR of an antenna tested on the highest output power using the default battery is > 3.5 W/Kg and 4.0 W/Kg (50% PTT duty factor), testing of the immediately adjacent channel(s) is not necessary, but testing of other required channels may still be required.
- When the SAR for all antennas tested using the default battery ≤ 4.0 W/kg(50% PTT duty factor), test additional batteries using the antenna and channel configuration that resulted in the highest SAR.
- The worst case configuration was repeated with the K5 model.
- Adding to KRA-29 Ant.

## 12.2 Measurement Results (Body-wornBelt clip SAR)

Frequency		Mode	Power (dBm)		Power Drift (dB)	Battery	Model	Antenna	Measured SAR(mW/g)	Adjusted SAR(mW/g)	SAR 50% Duty (mW/g)	Plot No.
MHz	Ch.		Tune-Up Limit	Conducted Power								
406.1	1	FM	37.16	37	-0.24	KNB-L1	NX-5300-K6	KRA-42(M3)	5.65	6.34	3.17	
406.1	1		37.16	37	-0.14	KNB-L1	NX-5300-K6	KRA-29	9.68	10.37	<b>5.19</b>	2
422.075	2		37.16	36.98	-0.05	KNB-L1	NX-5300-K6	KRA-29	9.26	9.76	4.88	3
438.05	3		37.16	36.94	-0.03	KNB-L1	NX-5300-K6	KRA-42(M)	6.87	7.28	3.64	
454.025	4		37.16	36.95	-0.16	KNB-L1	NX-5300-K6	KRA-42(M)	8.86	9.65	4.82	4
470	5		37.16	36.94	-0.14	KNB-L1	NX-5300-K6	KRA-42(M)	4.23	4.60	2.30	
406.1	1		37.16	37	-0.18	KNB-L2	NX-5300-K6	KRA-29	9.46	10.23	5.12	5
406.1	1		37.16	37	-0.29	KNB-L3	NX-5300-K6	KRA-29	8.76	9.72	4.86	6
406.1	1		37.16	37	-0.05	KNB-L1	NX-5300-K5	KRA-29	9.56	10.03	5.02	7
ANSI/ IEEE C95.1 – 1992– Safety Limit Spatial Peak controlled Exposure/ Occupational									Body 8 W/kg (mW/g) Averaged over 1 gram			

- 1 The test data reported are the worst-case SAR values according to test procedures specified in IEEE 1528-2003, FCC KDB Procedure.
- 2 All modes of operation were investigated and the worst-case are reported.
- 3 The manufacturer has confirmed that the device(s) tested have the same physical, mechanical and thermal characteristics and are within operational tolerances expected for production units
- 4 Liquid tissue depth was at least 15.0 cm for all frequencies
- 5 Tissue parameters and temperatures are listed on the SAR plot.
- 6 Batteries are fully charged at the beginning of the SAR measurements.
- 7 Test Signal Call Mode Manual Test cord Base Station Simulator
- 8 SAR Configuration Head Body Hand
- 9 The Body-worn SAR evaluation was performed with the Leather Case body-worn accessory attached to the DUT and touching the outer surface of the planar phantom.
- 10 SAR Measurement Time 30min
- 11 The adjusted SAR value was calculated by first scaling the SAR value up by the drift. This value was then scaled up based on the difference of the upper end the tolerance (37.16dBm) and the measured conducted power. The resultant value is then multiplied by 0.5 to give the SAR value at 50% duty cycle
- 12 SAR results were scaled to the maximum allowed power to demonstrate compliance per FCC KDB 447498 D01v05r02.  
**Test Procedures applied in accordance with FCC KDB 643646 D01v01**
- 13 For Body-worn configuration, the thinnest standard battery was selected as the default battery.(KNB-L1)
- 14 The body-worn SAR evaluation was performed with the speaker-microphone audio accessory connected to the DUT.Audio Accessory KMC-54WD was selected as the default audio accessory.
- 15 When the SAR for all antennas tested using the default battery is > 4.0 W/kg and 6.0 W/kg (50% PTT duty factor), test additional batteries using the antenna and channel configuration that resulted in the highest SAR.
- 16 When the SAR of an antenna tested on the highest output power channel using the default battery is > 4.0 W/kg and 6.0 W/kg (50% PTT duty factor), testing of the required immediately adjacent channel(s) is necessary. For the remaining channels that cannot be excluded, this rule may be applied recursively with respect to the highest output power channel among the remaining channels.
- 17 The worst case configuration was repeated with the K5 model.
- 18 Based on the SAR measured in the body-worn test sequence with default audio accessory, if the SAR for the antenna, body-worn accessory and battery combination(s) applicable to an audio accessory is/are >4.0 W/kg and < 6.0 W/kg(50% PTT duty factor), test that audio accessory using the highest body-worn SAR combination(antenna, battery and body-worn accessory) and channel configuration previously identified that is applicable to the audio accessory.

## 12.3 Measurement Results (Body-worn Nylon Case SAR)

Frequency		Mode	Power (dBm)		Power Drift (dB)	Battery	Model	Antenna	Measured SAR(mW/g)	Adjusted SAR(mW/g)	SAR 50% Duty (mW/g)	Plot No.
MHz	Ch.		Tune-Up Limit	Conducted Power								
406.1	1	FM	37.16	37	-0.01	KNB-L1	NX-5300-K6	KRA-42(M3)	8.99	9.35	4.67	8
406.1	1		37.16	37	-0.15	KNB-L1	NX-5300-K6	KRA-29	8.56	9.19	4.60	9
422.075	2		37.16	36.98	-0.28	KNB-L1	NX-5300-K6	KRA-29	8.7	9.30	4.65	10
422.075	2		37.16	36.98	-0.56	KNB-L1	NX-5300-K6	KRA-42(M3)	7.65	9.07	4.54	11
438.05	3		37.16	36.94	-0.28	KNB-L1	NX-5300-K6	KRA-42(M3)	6.52	7.32	3.66	
438.05	3		37.16	36.94	0	KNB-L1	NX-5300-K6	KRA-42(M)	8.98	9.45	<b>4.72</b>	12
454.025	4		37.16	36.95	-0.12	KNB-L1	NX-5300-K6	KRA-42(M)	6.66	7.19	3.42	
470	5		37.16	36.94	-0.05	KNB-L1	NX-5300-K6	KRA-42(M)	6.93	7.37	3.51	
406.1	1		37.16	37	-0.08	KNB-L2	NX-5300-K6	KRA-42(M3)	7.1	7.50	3.62	13
406.1	1		37.16	37	-0.42	KNB-L3	NX-5300-K6	KRA-42(M3)	7.33	8.38	4.04	14
406.1	1		37.16	37	-0.15	KNB-L1	NX-5300-K5	KRA-42(M3)	6.58	7.07	3.53	
ANSI/ IEEE C95.1 - 1992- Safety Limit Spatial Peak controlled Exposure/ Occupational									Body 8 W/kg (mW/g) Averaged over 1 gram			

- The test data reported are the worst-case SAR values according to test procedures specified in IEEE 1528-2003, FCC KDB Procedure.
- All modes of operation were investigated and the worst-case are reported.
- The manufacturer has confirmed that the device(s) tested have the same physical, mechanical and thermal characteristics and are within operational tolerances expected for production units
- Liquid tissue depth was at least 15.0 cm for all frequencies
- Tissue parameters and temperatures are listed on the SAR plot.
- Batteries are fully charged at the beginning of the SAR measurements.
- Test Signal Call Mode Manual Test cord Base Station Simulator
- SAR Configuration Head Body Hand
- The Body-worn SAR evaluation was performed with the Leather Case body-worn accessory attached to the DUT and touching the outer surface of the planar phantom.
- SAR Measurement Time 30min
- The adjusted SAR value was calculated by first scaling the SAR value up by the drift. This value was then scaled up based on the difference of the upper end the tolerance (37.16dBm) and the measured conducted power. The resultant value is then multiplied by 0.5 to give the SAR value at 50% duty cycle
- SAR results were scaled to the maximum allowed power to demonstrate compliance per FCC KDB 447498 D01v05r02.  
Test Procedures applied in accordance with FCC KDB 643646 D01v01
- For Body-worn configuration, the thinnest standard battery was selected as the default battery.(KNB-L1)
- The body-worn SAR evaluation was performed with the speaker-microphone audio accessory connected to the DUT.Audio Accessory KMC-54WD was selected as the default audio accessory.
- The worst case configuration was repeated with the K5 model.
- When the SAR for all antennas tested using the default battery is 3.5 W/kg (50% PTT duty factor), testing of all other required channels is not necessary.
- When the body SAR of an antenna tested on the highest output power using the default battery is > 3.5 W/Kg and 4.0 W/Kg (50% PTT duty factor), testing of the immediately adjacent channel(s) is not necessary, but testing of other required channels may still be required.
- When the SAR for all antennas tested using the default battery ≤ 4.0(50% PTT duty factor) W/kg, test additional batteries using the antenna and channel configuration that resulted in the highest SAR.

## 12.4 Measurement Results (Body-wornKBH-8DS SAR)

Frequency		Mode	Power (dBm)		Power Drift (dB)	Battery	Model	Antenna	Measured SAR(mW/g)	Adjusted SAR(mW/g)	SAR 50% Duty (mW/g)	Plot No.
MHz	Ch.		Tune-Up Limit	Conducted Power								
406.1	1	FM	37.16	37	-0.1	KNB-L1	NX-5300-K6	KRA-42(M3)	3.07	3.26	1.63	
406.1	1		37.16	37	-0.13	KNB-L1	NX-5300-K6	KRA-29	5.25	5.61	2.81	
422.075	2		37.16	36.94	-0.08	KNB-L1	NX-5300-K6	KRA-29	5.15	5.47	<b>2.73</b>	15
454.025	4		37.16	36.95	-0.15	KNB-L1	NX-5300-K6	KRA-42(M)	3.39	3.68	1.84	
406.1	1		37.16	37	-0.10	KNB-L2	NX-5300-K6	KRA-29	4.98	5.29	2.64	
406.1	1		37.16	37	-0.12	KNB-L3	NX-5300-K6	KRA-29	4.89	5.22	2.61	
406.1	1		37.16	37	-0.06	KNB-L1	NX-5300-K5	KRA-29	5.06	5.32	2.57	
ANSI/ IEEE C95.1 - 1992- Safety Limit Spatial Peak controlled Exposure/ Occupational									Body 8 W/kg (mW/g) Averaged over 1 gram			

- The test data reported are the worst-case SAR values according to test procedures specified in IEEE 1528-2003, FCC KDB Procedure.
- All modes of operation were investigated and the worst-case are reported.
- The manufacturer has confirmed that the device(s) tested have the same physical, mechanical and thermal characteristics and are within operational tolerances expected for production units
- Liquid tissue depth was at least 15.0 cm for all frequencies
- Tissue parameters and temperatures are listed on the SAR plot.
- Batteries are fully charged at the beginning of the SAR measurements.
- Test Signal Call Mode Manual Test cord Base Station Simulator
- SAR Configuration Head Body Hand
- The Body-worn SAR evaluation was performed with the Leather Case body-worn accessory attached to the DUT and touching the outer surface of the planar phantom.
- SAR Measurement Time 30min
- The adjusted SAR value was calculated by first scaling the SAR value up by the drift. This value was then scaled up based on the difference of the upper end the tolerance (37.16dBm) and the measured conducted power. The resultant value is then multiplied by 0.5 to give the SAR value at 50% duty cycle
- SAR results were scaled to the maximum allowed power to demonstrate compliance per FCC KDB 447498 D01v05r02.  
**Test Procedures applied in accordance with FCC KDB 643646 D01v01**
- For Body-worn configuration, the thinnest standard battery was selected as the default battery.(KNB-L1)
- The body-worn SAR evaluation was performed with the speaker-microphone audio accessory connected to the DUT.Audio Accessory KMC-54WD was selected as the default audio accessory.
- The worst case configuration was repeated with the K5 model.
- When the SAR for all antennas tested using the default battery is 3.5 W/kg (50% PTT duty factor), testing of all other required channels is not necessary.
- When the body SAR of an antenna tested on the highest output power using the default battery is > 3.5 W/Kg and 4.0 W/Kg (50% PTT duty factor), testing of the immediately adjacent channel(s) is not necessary, but testing of other required channels may still be required.
- When the SAR for all antennas tested using the default battery ≤ 4.0(50% PTT duty factor) W/kg, test additional batteries using the antenna and channel configuration that resulted in the highest SAR.



## 12.5 Measurement Results (KMC-49 Accessory SAR)

Frequency		Mode	Power (dBm)		Power Drift (dB)	Battery	Position	Model	Antenna	Separation Distance	Measured SAR (mW/g)	Adjusted SAR(W/kg)	SAR 50% Duty (mW/g)	Plot No.
MHz	Ch		Tune-Up Limit	Conducted Power										
406.1	1	FM	37.16	37	-0.3	KNB-L3	Head	NX-5300-K6	KRA-42(M)	25 mm	2.8	3.11	1.56	
406.1	1		37.16	37	-0.2	KNB-L3	Head	NX-5300-K6	KRA-27(M3)*	25 mm	3.26	3.54	1.77	
406.1	1		37.16	37	-0.18	KNB-L3	Head	NX-5300-K6	KRA-29	25 mm	3.55	3.84	1.92	16
454.025	4		37.16	36.95	-0.1	KNB-L1	Body	NX-5300-K6	KRA-42(M)	0 mm	6.83	7.34	3.67	
454.025	4		37.16	36.95	-0.19	KNB-L1	Body	NX-5300-K6	KRA-23(M)*	0 mm	6.88	7.54	<b>3.77</b>	17
406.1	1		37.16	37	-0.10	KNB-L1	Body	NX-5300-K6	KRA-29	0 mm	6.31	6.70	3.35	
ANSI/ IEEE C95.1 - 1992- Safety Limit Spatial Peak controlled Exposure/ Occupational											Head & Body 8 W/kg (mW/g) Averaged over 1 gram			

- 1 The test data reported are the worst-case SAR values according to test procedures specified in IEEE 1528-2003, FCC KDB Procedure.
- 2 All modes of operation were investigated and the worst-case are reported.
- 3 The manufacturer has confirmed that the device(s) tested have the same physical, mechanical and thermal characteristics and are within operational tolerances expected for production units
- 4 Liquid tissue depth was at least 15.0 cm for all frequencies
- 5 Tissue parameters and temperatures are listed on the SAR plot.
- 6 Batteries are fully charged at the beginning of the SAR measurements.
- 7 Test Signal Call Mode           Manual Test cord                   Base Station Simulator
- 8 SAR Configuration               Head                                   Body                                   Hand
- 9 SAR Measurement Time           30min
- 10 The adjusted SAR value was calculated by first scaling the SAR value up by the drift. This value was then scaled up based on the difference of the upper end the tolerance (37.16dBm) and the measured conducted power. The resultant value is then multiplied by 0.5 to give the SAR value at 50% duty cycle
- 11 SAR results were scaled to the maximum allowed power to demonstrate compliance per FCC KDB 447498 D01v05r02.
- 12 The worst case configuration including **original antenna** was repeated KMC-49 with the Audio Accessory

### 13. SAR Summation Scenario

	Position	Applicable Combination	Note
Simultaneous Transmission	Body-worn	450MHzFM+ 2.4 GHz Bluetooth	

### 13.1 Simultaneous Transmission Summation for Body-Worn

**Simultaneous Transmission Summation with Bluetooth (2.5cm)**

Band	configuration	Scaled SAR (W/kg)	BT SAR (W/kg)	$\sum$ 1-g SAR (W/kg)
450MHz(FCC)	Rear	5.19	0.02	5.21

## **13.2 Simultaneous Transmission Conclusion**

The above numerical summed SAR results for all the worst-case simultaneous transmission conditions were below the SAR limit. Therefore, the above analysis is sufficient to determine that simultaneous transmission cases will not exceed the SAR limit. And therefore no measured volumetric simultaneous SAR summation is required per FCC KDB Publication 447498 D01v05r02.

## 14. CONCLUSION

The SAR measurement indicates that the EUT complies with the RF radiation exposure limits of the ANSI/IEEE C95.1 1992.

These measurements are taken to simulate the RF effects exposure under worst-case conditions. Precise laboratory measures were taken to assure repeatability of the tests.

## 15. REFERENCES

---

- [1] IEEE Standards Coordinating Committee 34 – IEEE Std. 1528-2003, IEE Recommended Practice on Determining the Peak Spatial-Average Specific Absorption Rate (SAR) in the Human Body from Wireless Communications Devices.
- [2] Federal Communications Commission, ET Docket 93-62, Guidelines for Evaluating the Environmental Effects of Radio frequency Radiation, Aug. 1996.
- [3] ANSI/IEEE C95.1 - 1991, American National Standard safety levels with respect to human exposure to radio frequency electromagnetic fields, 300kHz to 100GHz, New York: IEEE, Aug. 1992
- [4] ANSI/IEEE C95.3 - 1991, IEEE Recommended Practice for the Measurement of Potentially Hazardous Electromagnetic Fields - RF and Microwave, New York: IEEE, 1992.
- [5] NCRP, National Council on Radiation Protection and Measurements, Biological Effects and Exposure Criteria for Radio Frequency Electromagnetic Fields, NCRP Report No. 86, 1986. Reprinted Feb. 1995.
- [6] T. Schmid, O. Egger, N. Kuster, Automated E-field scanning system for dosimetric assessments, IEEE Transaction on Microwave Theory and Techniques, vol. 44, Jan. 1996, pp. 105-113.
- [7] K. Pokovic, T. Schmid, N. Kuster, Robust setup for precise calibration of E-field probes in tissue simulating liquids at mobile communications frequencies, ICECOM97, Oct. 1997, pp. 120-124.
- [8] K. Pokovic, T. Schmid, and N. Kuster, E-field Probe with improved isotropy in brain simulating liquids, Proceedings of the ELMAR, Zadar, Croatia, June 23-25, 1996, pp. 172-175.
- [9] Schmid & Partner Engineering AG, Application Note: Data Storage and Evaluation, June 1998, p2.
- [10] V. Hombach, K. Meier, M. Burkhardt, E. Kuhn, N. Kuster, The Dependence of EM Energy Absorption upon Human Head Modeling at 900 MHz, IEEE Transaction on Microwave Theory and Techniques, vol. 44 no. 10, Oct. 1996, pp. 1865-1873.
- [11] N. Kuster and Q. Balzano, Energy absorption mechanism by biological bodies in the near field of dipole antennas above 300MHz, IEEE Transaction on Vehicular Technology, vol. 41, no. 1, Feb. 1992, pp. 17-23.
- [12] G. Hartsgrrove, A. Kraszewski, A. Surowiec, Simulated Biological Materials for Electromagnetic Radiation Absorption Studies, University of Ottawa, Bioelectromagnetics, Canada: 1987, pp. 29-36.
- [13] Q. Balzano, O. Garay, T. Manning Jr., Electromagnetic Energy Exposure of Simulated Users of Portable Cellular Telephones, IEEE Transactions on Vehicular Technology, vol. 44, no.3, Aug. 1995.
- [14] W. Gander, Computer mathematic, Birkhaeuser, Basel, 1992.
- [15] W.H. Press, S.A. Teukolsky, W.T. Vetterling, and B.P. Flannery, Numerical Recipes in C, The Art of Scientific Computing, Second edition, Cambridge University Press, 1992.
- [16] N. Kuster, R. Kastle, T. Schmid, Dosimetric evaluation of mobile communications equipment with known precision, IEEE Transaction on Communications, vol. E80-B, no. 5, May 1997, pp. 645-652.
- [17] CENELEC CLC/SC111B, European Prestandard (prENV 50166-2), Human Exposure to Electromagnetic Fields  
High-frequency: 10kHz-300GHz, Jan. 1995.
- [18] Prof. Dr. Niels Kuster, ETH, Eidgenössische Technische Hochschule Zürich, Dosimetric Evaluation of the Cellular Phone.
- [19] SAR Evaluation of Handsets with Multiple Transmitters and Antennas #648474.
- [20] SAR Measurement Procedure for 802.11 a/b/g Transmitters #KDB 248227.

## Attachment 1.– SAR Test Plots

Test Laboratory: HCT CO., LTD  
 EUT Type: UHF DIGITAL TRANSCEIVER  
 Liquid Temperature: 20.2  
 Ambient Temperature: 20.4  
 Test Date: Jan. 06, 2015  
 Plot No.: 1

**DUT: NX-5300-K6; Type: bar**

Communication System: UID 0, 400MHz FCC (0); Frequency: 406.1 MHz; Duty Cycle: 1:1  
 Medium parameters used (interpolated):  $f = 406.1$  MHz;  $\sigma = 0.859$  S/m;  $\epsilon_r = 46.417$ ;  $\rho = 1000$  kg/m<sup>3</sup>  
 Phantom section: Flat Section  
 Measurement Standard: DASYS5 (IEEE/IEC/ANSI C63.19-2007)

DASY4 Configuration:

- Probe: ET3DV6 - SN1798; ConvF(7.61, 7.61, 7.61); Calibrated: 2014-08-25;
- Sensor-Surface: 4mm (Mechanical Surface Detection)
- Electronics: DAE3 Sn466; Calibrated: 2014-02-27
- Phantom: ELI v4.0; Type: QDOVA001BB; Serial: TP:xxxx
- ; SEMCAD X Version 14.6.10 (7331)

**NX-5300-K6/Head front 1ch KNB-L3\_KRA-29/Area Scan (51x151x1):** Interpolated grid: dx=1.500 mm, dy=1.500 mm  
 Maximum value of SAR (interpolated) = 4.96 W/kg

**NX-5300-K6/Head front 1ch KNB-L3\_KRA-29/Zoom Scan (5x5x7)/Cube 0:** Measurement grid: dx=8mm, dy=8mm, dz=5mm  
 Reference Value = 77.34 V/m; Power Drift = -0.12 dB  
 Peak SAR (extrapolated) = 5.83 W/kg  
**SAR(1 g) = 4.7 W/kg; SAR(10 g) = 3.74 W/kg**  
 Maximum value of SAR (measured) = 4.88 W/kg

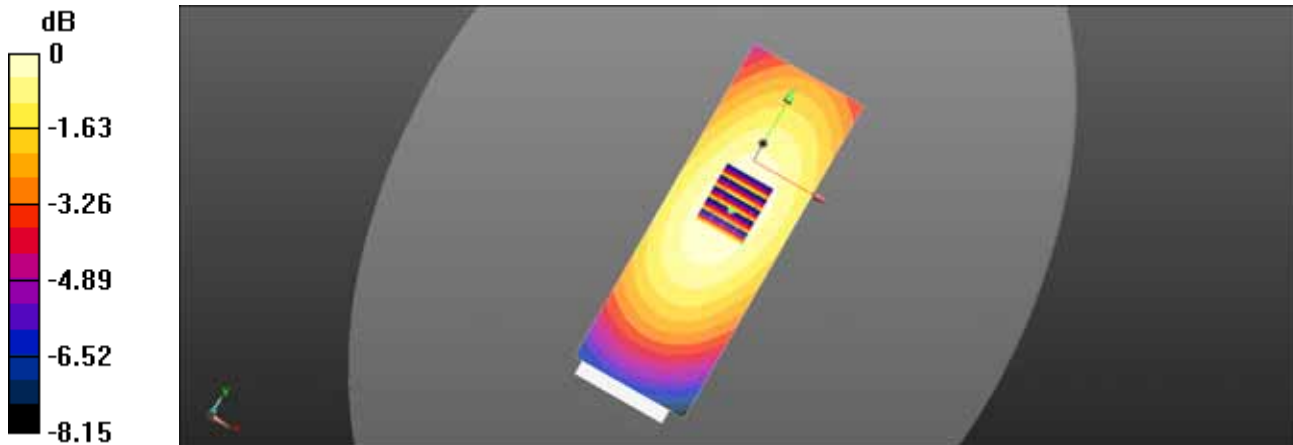

0 dB = 4.96 W/kg = 6.95 dBW/kg

Test Laboratory: HCT CO., LTD  
 EUT Type: UHF DIGITAL TRANSCEIVER  
 Liquid Temperature: 20.2  
 Ambient Temperature: 20.4  
 Test Date: Jan. 06, 2015  
 Plot No.: 2

**DUT: NX-5300-K6; Type: bar**

Communication System: UID 0, 400MHz FCC 2 (0); Frequency: 406.1 MHz; Duty Cycle: 1:1  
 Medium parameters used (interpolated):  $f = 406.1$  MHz;  $\sigma = 0.924$  S/m;  $\epsilon_r = 56.272$ ;  $\rho = 1000$  kg/m<sup>3</sup>  
 Phantom section: Flat Section  
 Measurement Standard: DASYS5 (IEEE/IEC/ANSI C63.19-2007)

DASY4 Configuration:

- Probe: ET3DV6 - SN1798; ConvF(7.97, 7.97, 7.97); Calibrated: 2014-08-25;
- Sensor-Surface: 4mm (Mechanical Surface Detection)
- Electronics: DAE3 Sn466; Calibrated: 2014-02-27
- Phantom: ELI v4.0; Type: QDOVA001BB; Serial: TP:xxxx
- ; SEMCAD X Version 14.6.10 (7331)

**NX-5300-K6/Body rear 1 ch KNB-L1\_KRA-29/Area Scan (51x151x1):** Interpolated grid: dx=1.500 mm, dy=1.500 mm  
 Maximum value of SAR (interpolated) = 10.1 W/kg

**NX-5300-K6/Body rear 1 ch KNB-L1\_KRA-29/Zoom Scan (5x5x7)/Cube 0:** Measurement grid: dx=8mm, dy=8mm, dz=5mm  
 Reference Value = 106.5 V/m; Power Drift = -0.14 dB  
 Peak SAR (extrapolated) = 13.5 W/kg  
**SAR(1 g) = 9.68 W/kg; SAR(10 g) = 7.25 W/kg**  
 Maximum value of SAR (measured) = 10.1 W/kg

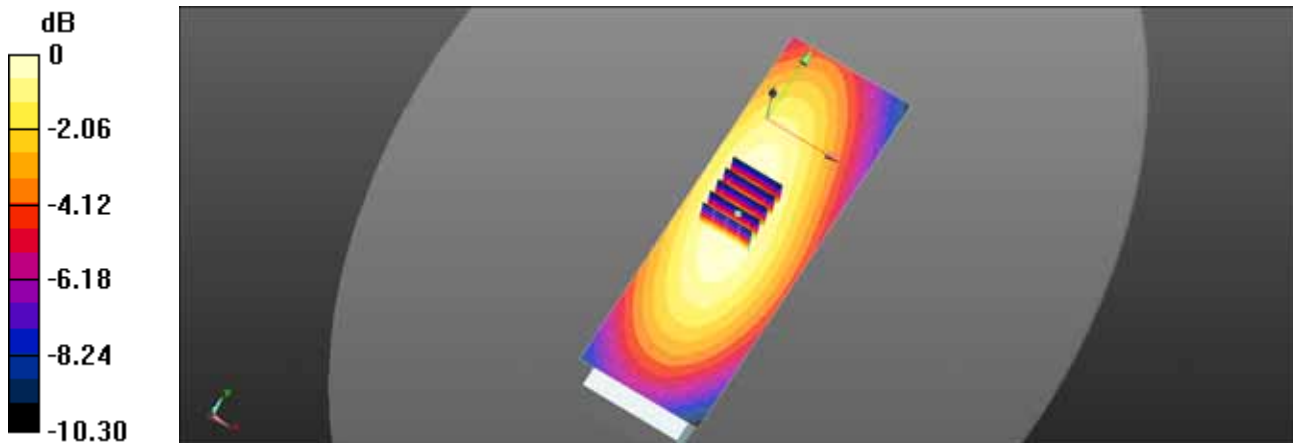

0 dB = 10.1 W/kg = 10.04 dBW/kg



Test Laboratory: HCT CO., LTD  
 EUT Type: UHF DIGITAL TRANSCEIVER  
 Liquid Temperature: 20.2  
 Ambient Temperature: 20.4  
 Test Date: Jan. 06, 2015  
 Plot No.: 3

**DUT: NX-5300-K6; Type: bar**

Communication System: UID 0, 400MHz FCC 2 (0); Frequency: 422.075 MHz; Duty Cycle: 1:1  
 Medium parameters used (interpolated):  $f = 422.075$  MHz;  $\sigma = 0.93$  S/m;  $\epsilon_r = 55.971$ ;  $\rho = 1000$  kg/m<sup>3</sup>  
 Phantom section: Flat Section  
 Measurement Standard: DASYS5 (IEEE/IEC/ANSI C63.19-2007)

DASY4 Configuration:

- Probe: ET3DV6 - SN1798; ConvF(7.97, 7.97, 7.97); Calibrated: 2014-08-25;
- Sensor-Surface: 4mm (Mechanical Surface Detection)
- Electronics: DAE3 Sn466; Calibrated: 2014-02-27
- Phantom: ELI v4.0; Type: QDOVA001BB; Serial: TP:xxxx
- ; SEMCAD X Version 14.6.10 (7331)

**NX-5300-K6/Body rear 2 ch KNB-L1\_KRA-29/Area Scan (51x151x1):** Interpolated grid: dx=1.500 mm, dy=1.500 mm  
 Maximum value of SAR (interpolated) = 9.76 W/kg

**NX-5300-K6/Body rear 2 ch KNB-L1\_KRA-29/Zoom Scan (5x5x7)/Cube 0:** Measurement grid: dx=8mm, dy=8mm, dz=5mm  
 Reference Value = 103.0 V/m; Power Drift = -0.05 dB  
 Peak SAR (extrapolated) = 12.9 W/kg  
**SAR(1 g) = 9.26 W/kg; SAR(10 g) = 6.93 W/kg**  
 Maximum value of SAR (measured) = 9.66 W/kg

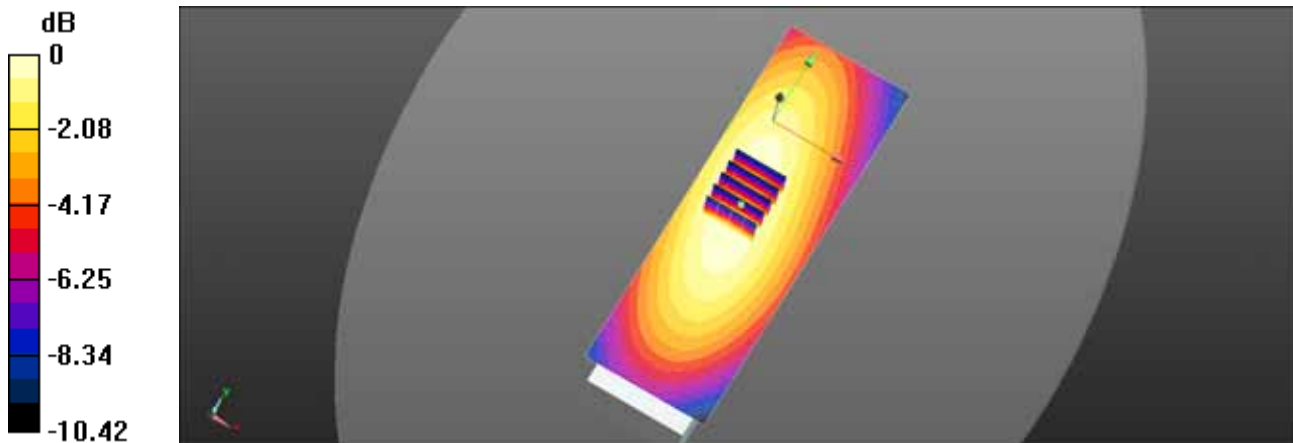

0 dB = 9.76 W/kg = 9.89 dBW/kg

Test Laboratory: HCT CO., LTD  
 EUT Type: UHF DIGITAL TRANSCEIVER  
 Liquid Temperature: 20.5  
 Ambient Temperature: 20.3  
 Test Date: Sep. 22, 2014  
 Plot No.: 4

**DUT: NX-5300-K6; Type: bar**

Communication System: UID 0, 400MHz FCC 2 (0); Frequency: 454.025 MHz; Duty Cycle: 1:1  
 Medium parameters used:  $f = 455 \text{ MHz}$ ;  $\sigma = 0.938 \text{ S/m}$ ;  $\epsilon_r = 55.231$ ;  $\rho = 1000 \text{ kg/m}^3$   
 Phantom section: Flat Section  
 Measurement Standard: DASY5 (IEEE/IEC/ANSI C63.19-2007)

DASY4 Configuration:

- Probe: ET3DV6 - SN1605; ConvF(7.34, 7.34, 7.34); Calibrated: 2014-01-31;
- Sensor-Surface: 4mm (Mechanical Surface Detection)
- Electronics: DAE4 Sn1417; Calibrated: 2014-01-03
- Phantom: ELI v4.0; Type: QDOVA001BB; Serial: TP:xxxx
- ; SEMCAD X Version 14.6.10 (7331)

**NX-5300-K6/Body rear 4ch KNB-L1\_Belt clip\_42M/Area Scan (61x151x1):** Interpolated grid:  $dx=1.500 \text{ mm}$ ,  $dy=1.500 \text{ mm}$   
 Maximum value of SAR (interpolated) = 9.04 W/kg

**NX-5300-K6/Body rear 4ch KNB-L1\_Belt clip\_42M/Zoom Scan (5x5x7)/Cube 0:** Measurement grid:  $dx=8\text{mm}$ ,  $dy=8\text{mm}$ ,  $dz=5\text{mm}$   
 Reference Value = 97.71 V/m; Power Drift = -0.16 dB  
 Peak SAR (extrapolated) = 13.0 W/kg  
**SAR(1 g) = 8.86 W/kg; SAR(10 g) = 6.33 W/kg**  
 Maximum value of SAR (measured) = 9.40 W/kg

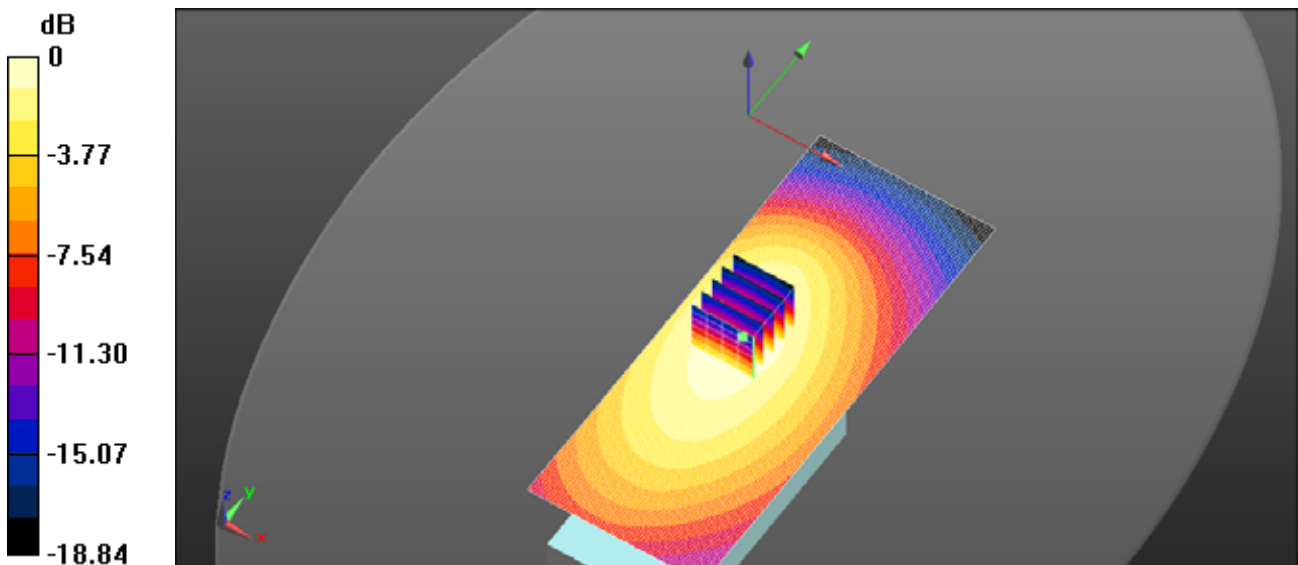

0 dB = 9.04 W/kg = 9.56 dBW/kg

Test Laboratory: HCT CO., LTD  
 EUT Type: UHF DIGITAL TRANSCEIVER  
 Liquid Temperature: 20.2

Ambient Temperature: 20.4  
 Test Date: Jan. 06, 2015  
 Plot No.: 5

**DUT: NX-5300-K6; Type: bar**

Communication System: UID 0, 400MHz FCC 2 (0); Frequency: 406.1 MHz; Duty Cycle: 1:1  
 Medium parameters used (interpolated):  $f = 406.1 \text{ MHz}$ ;  $\sigma = 0.924 \text{ S/m}$ ;  $\epsilon_r = 56.272$ ;  $\rho = 1000 \text{ kg/m}^3$   
 Phantom section: Flat Section  
 Measurement Standard: DASY5 (IEEE/IEC/ANSI C63.19-2007)

DASY4 Configuration:

- Probe: ET3DV6 - SN1798; ConvF(7.97, 7.97, 7.97); Calibrated: 2014-08-25;
- Sensor-Surface: 4mm (Mechanical Surface Detection)
- Electronics: DAE3 Sn466; Calibrated: 2014-02-27
- Phantom: ELI v4.0; Type: QDOVA001BB; Serial: TP:xxxx
- ; SEMCAD X Version 14.6.10 (7331)

**NX-5300-K6/Body rear 1 ch KNB-L1\_KRA-29/Area Scan (51x151x1):** Interpolated grid:  $dx=1.500 \text{ mm}$ ,  $dy=1.500 \text{ mm}$   
 Maximum value of SAR (interpolated) = 10.0 W/kg

**NX-5300-K6/Body rear 1 ch KNB-L1\_KRA-29/Zoom Scan (5x5x7)/Cube 0:** Measurement grid:  $dx=8\text{mm}$ ,  $dy=8\text{mm}$ ,  $dz=5\text{mm}$   
 Reference Value = 102.2 V/m; Power Drift = -0.18 dB  
 Peak SAR (extrapolated) = 13.4 W/kg  
**SAR(1 g) = 9.46 W/kg; SAR(10 g) = 6.96 W/kg**  
 Maximum value of SAR (measured) = 9.84 W/kg

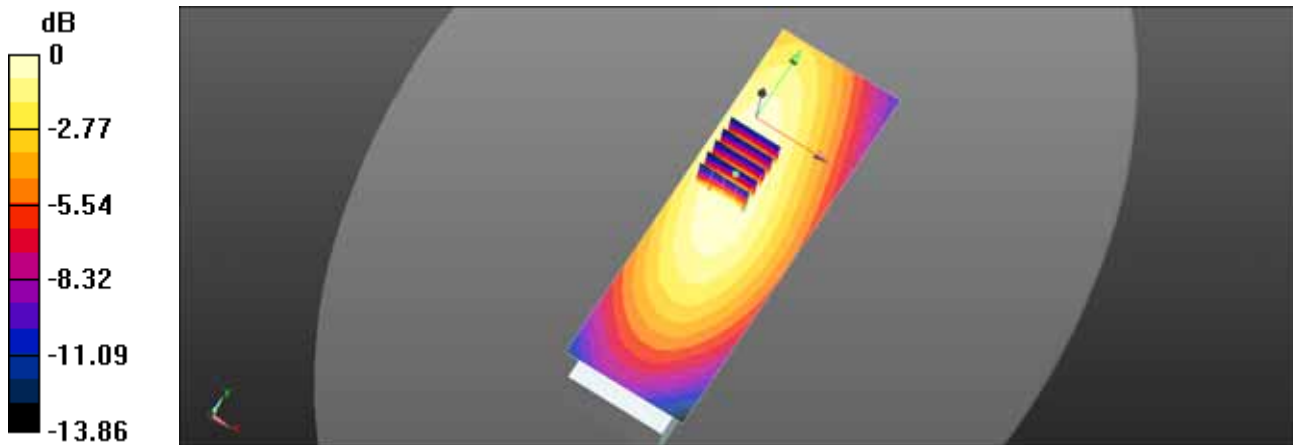

0 dB = 10.0 W/kg = 10.00 dBW/kg

Test Laboratory: HCT CO., LTD  
 EUT Type: UHF DIGITAL TRANSCEIVER  
 Liquid Temperature: 20.2  
 Ambient Temperature: 20.4  
 Test Date: Jan. 06, 2015  
 Plot No.: 6

**DUT: NX-5300-K6; Type: bar**

Communication System: UID 0, 400MHz FCC 2 (0); Frequency: 406.1 MHz; Duty Cycle: 1:1  
 Medium parameters used (interpolated):  $f = 406.1$  MHz;  $\sigma = 0.924$  S/m;  $\epsilon_r = 56.272$ ;  $\rho = 1000$  kg/m<sup>3</sup>  
 Phantom section: Flat Section  
 Measurement Standard: DASYS5 (IEEE/IEC/ANSI C63.19-2007)

DASY4 Configuration:

- Probe: ET3DV6 - SN1798; ConvF(7.97, 7.97, 7.97); Calibrated: 2014-08-25;
- Sensor-Surface: 4mm (Mechanical Surface Detection)
- Electronics: DAE3 Sn466; Calibrated: 2014-02-27
- Phantom: ELI v4.0; Type: QDOVA001BB; Serial: TP:xxxx
- ; SEMCAD X Version 14.6.10 (7331)

**NX-5300-K6/Body rear 3 ch KNB-L1\_KRA-29/Area Scan (51x151x1):** Interpolated grid: dx=1.500 mm, dy=1.500 mm  
 Maximum value of SAR (interpolated) = 9.48 W/kg

**NX-5300-K6/Body rear 3 ch KNB-L1\_KRA-29/Zoom Scan (5x5x7)/Cube 0:** Measurement grid: dx=8mm, dy=8mm, dz=5mm  
 Reference Value = 99.34 V/m; Power Drift = -0.29 dB  
 Peak SAR (extrapolated) = 12.3 W/kg  
**SAR(1 g) = 8.76 W/kg; SAR(10 g) = 6.49 W/kg**  
 Maximum value of SAR (measured) = 9.13 W/kg

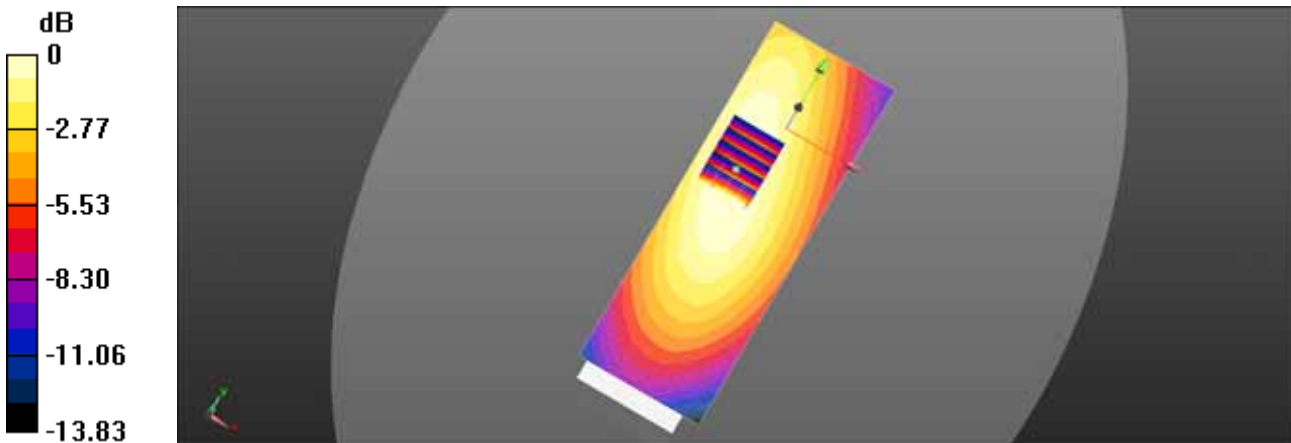

0 dB = 9.48 W/kg = 9.77 dBW/kg

Test Laboratory: HCT CO., LTD  
 EUT Type: UHF DIGITAL TRANSCEIVER  
 Liquid Temperature: 20.2  
 Ambient Temperature: 20.4  
 Test Date: Jan. 06, 2015  
 Plot No.: 7

**DUT: NX-5300-K6; Type: bar**

Communication System: UID 0, 400MHz FCC 2 (0); Frequency: 406.1 MHz; Duty Cycle: 1:1  
 Medium parameters used (interpolated):  $f = 406.1$  MHz;  $\sigma = 0.924$  S/m;  $\epsilon_r = 56.272$ ;  $\rho = 1000$  kg/m<sup>3</sup>  
 Phantom section: Flat Section  
 Measurement Standard: DASYS5 (IEEE/IEC/ANSI C63.19-2007)

DASY4 Configuration:

- Probe: ET3DV6 - SN1798; ConvF(7.97, 7.97, 7.97); Calibrated: 2014-08-25;
- Sensor-Surface: 4mm (Mechanical Surface Detection)
- Electronics: DAE3 Sn466; Calibrated: 2014-02-27
- Phantom: ELI v4.0; Type: QDOVA001BB; Serial: TP:xxxx
- ; SEMCAD X Version 14.6.10 (7331)

**NX-5300-K6/Body rear 1 ch KNB-L1\_KRA-29/Area Scan (51x151x1):** Interpolated grid: dx=1.500 mm, dy=1.500 mm  
 Maximum value of SAR (interpolated) = 10.1 W/kg

**NX-5300-K6/Body rear 1 ch KNB-L1\_KRA-29/Zoom Scan (5x5x7)/Cube 0:** Measurement grid: dx=8mm, dy=8mm, dz=5mm  
 Reference Value = 105.6 V/m; Power Drift = -0.05 dB  
 Peak SAR (extrapolated) = 13.4 W/kg  
**SAR(1 g) = 9.56 W/kg; SAR(10 g) = 7.11 W/kg**  
 Maximum value of SAR (measured) = 9.98 W/kg

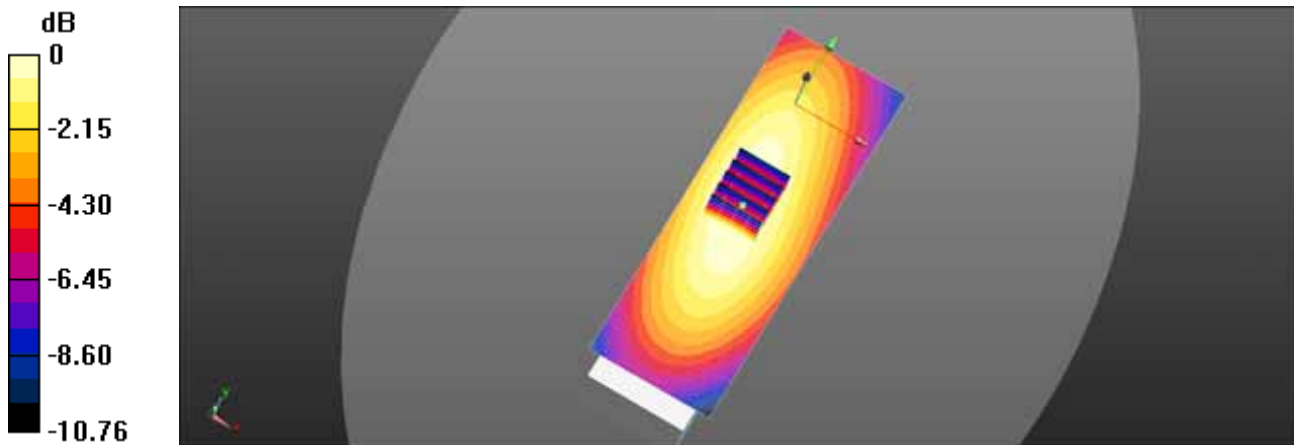

0 dB = 10.1 W/kg = 10.03 dBW/kg

Test Laboratory: HCT CO., LTD  
 EUT Type: UHF DIGITAL TRANSCEIVER  
 Liquid Temperature: 20.5  
 Ambient Temperature: 20.3  
 Test Date: Sep. 22, 2014  
 Plot No.: 8

**DUT: NX-5300-K6; Type: bar**

Communication System: UID 0, 400MHz FCC 2 (0); Frequency: 406.1 MHz; Duty Cycle: 1:1  
 Medium parameters used (interpolated):  $f = 406.1$  MHz;  $\sigma = 0.895$  S/m;  $\epsilon_r = 56.157$ ;  $\rho = 1000$  kg/m<sup>3</sup>  
 Phantom section: Flat Section  
 Measurement Standard: DASYS (IEEE/IEC/ANSI C63.19-2007)

DASY4 Configuration:

- Probe: ET3DV6 - SN1605; ConvF(7.34, 7.34, 7.34); Calibrated: 2014-01-31;
- Sensor-Surface: 4mm (Mechanical Surface Detection)
- Electronics: DAE4 Sn1417; Calibrated: 2014-01-03
- Phantom: ELI v4.0; Type: QDOVA001BB; Serial: TP:xxxx
- ; SEMCAD X Version 14.6.10 (7331)

**NX-5300-K6/Body rear 1ch KNB-L1\_42M3/Area Scan (61x151x1):** Interpolated grid: dx=1.500 mm, dy=1.500 mm  
 Maximum value of SAR (interpolated) = 9.36 W/kg

**NX-5300-K6/Body rear 1ch KNB-L1\_42M3/Zoom Scan (5x5x7)/Cube 0:** Measurement grid: dx=8mm, dy=8mm, dz=5mm  
 Reference Value = 100.1 V/m; Power Drift = -0.01 dB  
 Peak SAR (extrapolated) = 12.2 W/kg  
**SAR(1 g) = 8.99 W/kg; SAR(10 g) = 6.83 W/kg**  
 Maximum value of SAR (measured) = 9.38 W/kg

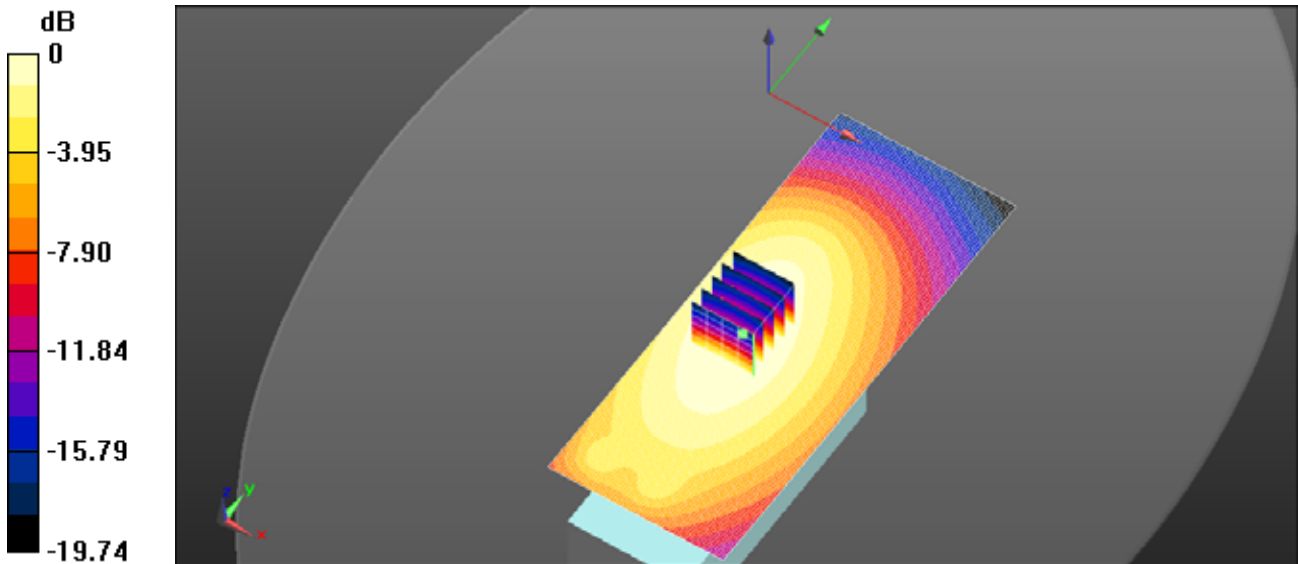

0 dB = 9.36 W/kg = 9.71 dBW/kg

Test Laboratory: HCT CO., LTD  
 EUT Type: UHF DIGITAL TRANSCEIVER  
 Liquid Temperature: 20.2  
 Ambient Temperature: 20.4  
 Test Date: Jan. 06, 2015  
 Plot No.: 9

**DUT: NX-5300-K6; Type: bar**

Communication System: UID 0, 400MHz FCC 2 (0); Frequency: 406.1 MHz; Duty Cycle: 1:1  
 Medium parameters used (interpolated):  $f = 406.1$  MHz;  $\sigma = 0.906$  S/m;  $\epsilon_r = 56.314$ ;  $\rho = 1000$  kg/m<sup>3</sup>  
 Phantom section: Flat Section  
 Measurement Standard: DASYS5 (IEEE/IEC/ANSI C63.19-2007)

DASY4 Configuration:

- Probe: ET3DV6 - SN1798; ConvF(7.97, 7.97, 7.97); Calibrated: 2014-08-25;
- Sensor-Surface: 4mm (Mechanical Surface Detection)
- Electronics: DAE3 Sn466; Calibrated: 2014-02-27
- Phantom: ELI v4.0; Type: QDOVA001BB; Serial: TP:xxxx
- ; SEMCAD X Version 14.6.10 (7331)

**NX-5300-K6/Body rear 1 ch KNB-L1\_KRA-29/Area Scan (51x151x1):** Interpolated grid: dx=1.500 mm, dy=1.500 mm  
 Maximum value of SAR (interpolated) = 9.07 W/kg

**NX-5300-K6/Body rear 1 ch KNB-L1\_KRA-29/Zoom Scan (5x5x7)/Cube 0:** Measurement grid: dx=8mm, dy=8mm, dz=5mm  
 Reference Value = 101.9 V/m; Power Drift = -0.15 dB  
 Peak SAR (extrapolated) = 11.8 W/kg  
**SAR(1 g) = 8.56 W/kg; SAR(10 g) = 6.44 W/kg**  
 Maximum value of SAR (measured) = 8.94 W/kg

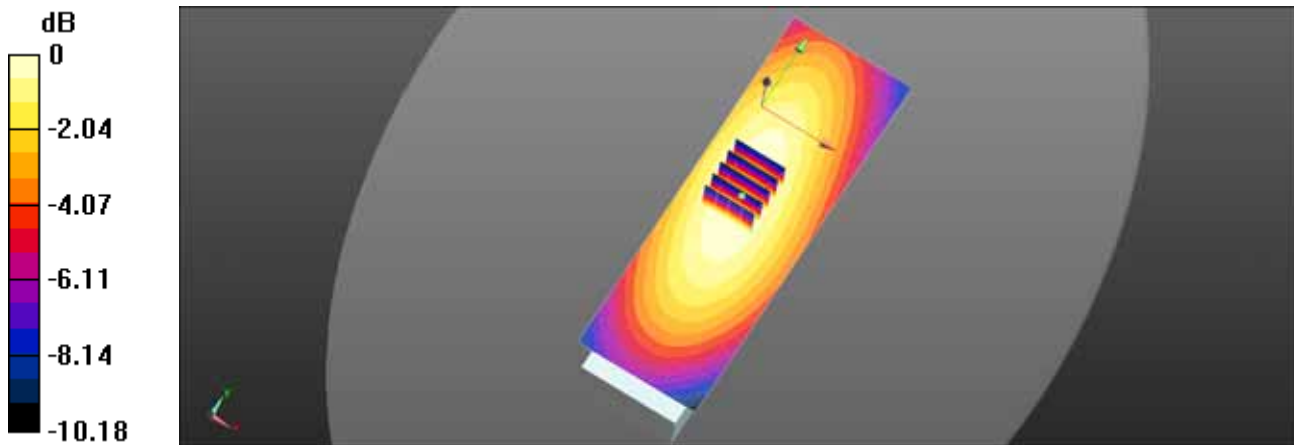

0 dB = 9.07 W/kg = 9.58 dBW/kg

Test Laboratory: HCT CO., LTD  
 EUT Type: UHF DIGITAL TRANSCEIVER  
 Liquid Temperature: 20.2  
 Ambient Temperature: 20.4  
 Test Date: Jan. 06, 2015  
 Plot No.: 10

**DUT: NX-5300-K6; Type: bar**

Communication System: UID 0, 400MHz FCC 2 (0); Frequency: 422.075 MHz; Duty Cycle: 1:1  
 Medium parameters used (interpolated):  $f = 422.075$  MHz;  $\sigma = 0.93$  S/m;  $\epsilon_r = 55.971$ ;  $\rho = 1000$  kg/m<sup>3</sup>  
 Phantom section: Flat Section  
 Measurement Standard: DASYS5 (IEEE/IEC/ANSI C63.19-2007)

DASY4 Configuration:

- Probe: ET3DV6 - SN1798; ConvF(7.97, 7.97, 7.97); Calibrated: 2014-08-25;
- Sensor-Surface: 4mm (Mechanical Surface Detection)
- Electronics: DAE3 Sn466; Calibrated: 2014-02-27
- Phantom: ELI v4.0; Type: QDOVA001BB; Serial: TP:xxxx
- ; SEMCAD X Version 14.6.10 (7331)

**NX-5300-K6/Body rear 2 ch KNB-L1\_KRA-29/Area Scan (51x151x1):** Interpolated grid: dx=1.500 mm, dy=1.500 mm  
 Maximum value of SAR (interpolated) = 9.16 W/kg

**NX-5300-K6/Body rear 2 ch KNB-L1\_KRA-29/Zoom Scan (5x5x7)/Cube 0:** Measurement grid: dx=8mm, dy=8mm, dz=5mm  
 Reference Value = 103.0 V/m; Power Drift = -0.28 dB  
 Peak SAR (extrapolated) = 12.1 W/kg  
**SAR(1 g) = 8.7 W/kg; SAR(10 g) = 6.47 W/kg**  
 Maximum value of SAR (measured) = 9.09 W/kg

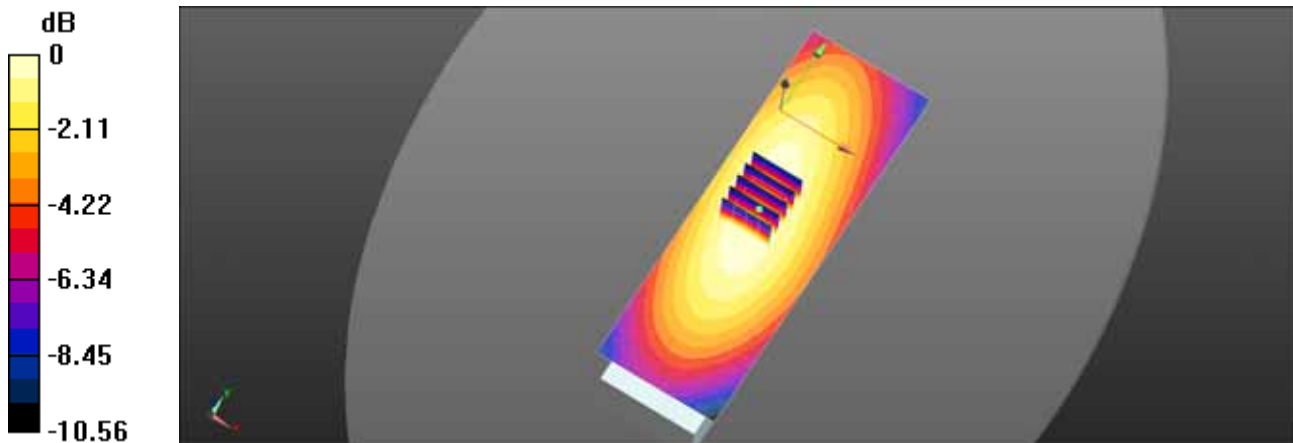

0 dB = 9.16 W/kg = 9.62 dBW/kg



Test Laboratory: HCT CO., LTD  
 EUT Type: UHF DIGITAL TRANSCEIVER  
 Liquid Temperature: 20.5  
 Ambient Temperature: 20.3  
 Test Date: Sep. 22, 2014  
 Plot No.: 11

**DUT: NX-5300-K6; Type: bar**

Communication System: UID 0, 400MHz FCC 2 (0); Frequency: 422.075 MHz; Duty Cycle: 1:1  
 Medium parameters used (interpolated):  $f = 422.075$  MHz;  $\sigma = 0.909$  S/m;  $\epsilon_r = 55.866$ ;  $\rho = 1000$  kg/m<sup>3</sup>  
 Phantom section: Flat Section

DASY4 Configuration:

- Probe: ET3DV6 - SN1605; ConvF(7.34, 7.34, 7.34); Calibrated: 2014-01-31;
- Sensor-Surface: 4mm (Mechanical Surface Detection)
- Electronics: DAE4 Sn1417; Calibrated: 2014-01-03
- Phantom: ELI v4.0; Type: QDOVA001BB; Serial: TP:xxxx
- ; SEMCAD X Version 14.6.10 (7331)

**NX-5300-K6/Body rear 2ch KNB-L1\_42M3/Area Scan (61x151x1):** Interpolated grid: dx=1.500 mm, dy=1.500 mm  
 Maximum value of SAR (interpolated) = 8.58 W/kg

**NX-5300-K6/Body rear 2ch KNB-L1\_42M3/Zoom Scan (5x5x7)/Cube 0:** Measurement grid: dx=8mm, dy=8mm, dz=5mm  
 Reference Value = 98.04 V/m; Power Drift = -0.56 dB  
 Peak SAR (extrapolated) = 10.3 W/kg  
**SAR(1 g) = 7.65 W/kg; SAR(10 g) = 5.82 W/kg**  
 Maximum value of SAR (measured) = 7.98 W/kg

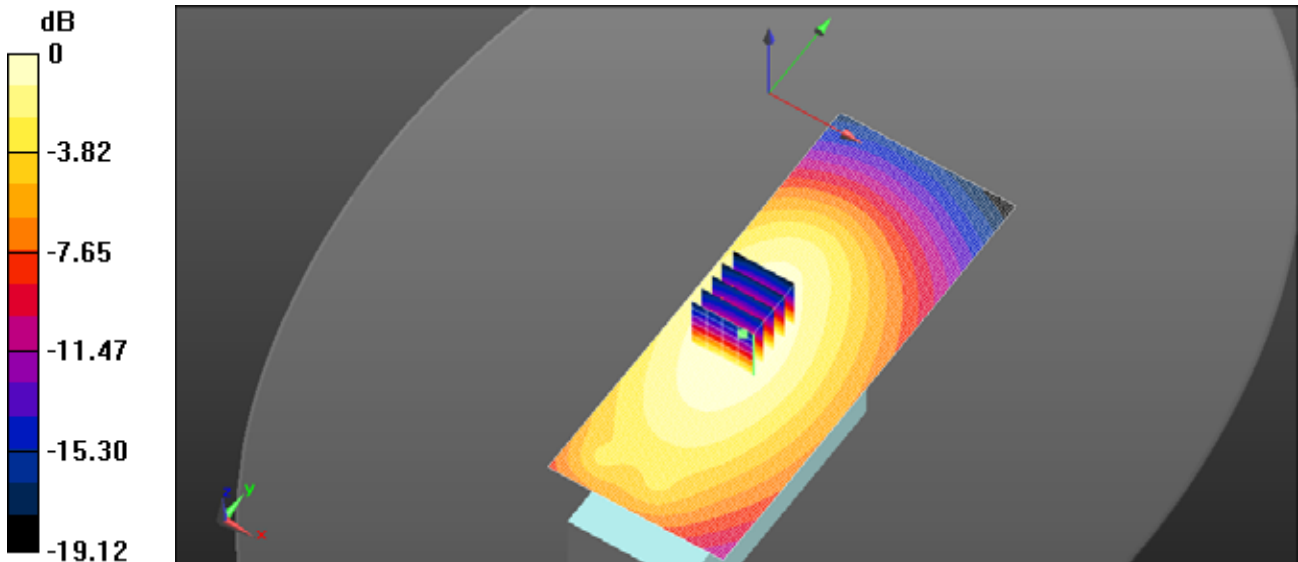

0 dB = 8.58 W/kg = 9.34 dBW/kg

Test Laboratory: HCT CO., LTD  
 EUT Type: UHF DIGITAL TRANSCEIVER  
 Liquid Temperature: 20.5

Ambient Temperature: 20.3  
 Test Date: Sep. 22, 2014  
 Plot No.: 12

**DUT: NX-5300-K6; Type: bar**

Communication System: UID 0, 400MHz FCC 2 (0); Frequency: 438.05 MHz; Duty Cycle: 1:1  
 Medium parameters used (interpolated):  $f = 438.05$  MHz;  $\sigma = 0.922$  S/m;  $\epsilon_r = 55.535$ ;  $\rho = 1000$  kg/m<sup>3</sup>  
 Phantom section: Flat Section

DASY4 Configuration:

- Probe: ET3DV6 - SN1605; ConvF(7.34, 7.34, 7.34); Calibrated: 2014-01-31;
- Sensor-Surface: 4mm (Mechanical Surface Detection)
- Electronics: DAE4 Sn1417; Calibrated: 2014-01-03
- Phantom: ELI v4.0; Type: QDOVA001BB; Serial: TP:xxxx
- ; SEMCAD X Version 14.6.10 (7331)

**NX-5300-K6/Body rear 3ch KNB-L1\_42M/Area Scan (61x151x1):** Interpolated grid: dx=1.500 mm, dy=1.500 mm  
 Maximum value of SAR (interpolated) = 9.37 W/kg

**NX-5300-K6/Body rear 3ch KNB-L1\_42M/Zoom Scan (5x5x7)/Cube 0:** Measurement grid: dx=8mm, dy=8mm, dz=5mm  
 Reference Value = 96.74 V/m; Power Drift = -0.00 dB  
 Peak SAR (extrapolated) = 12.1 W/kg  
**SAR(1 g) = 8.98 W/kg; SAR(10 g) = 6.82 W/kg**  
 Maximum value of SAR (measured) = 9.38 W/kg

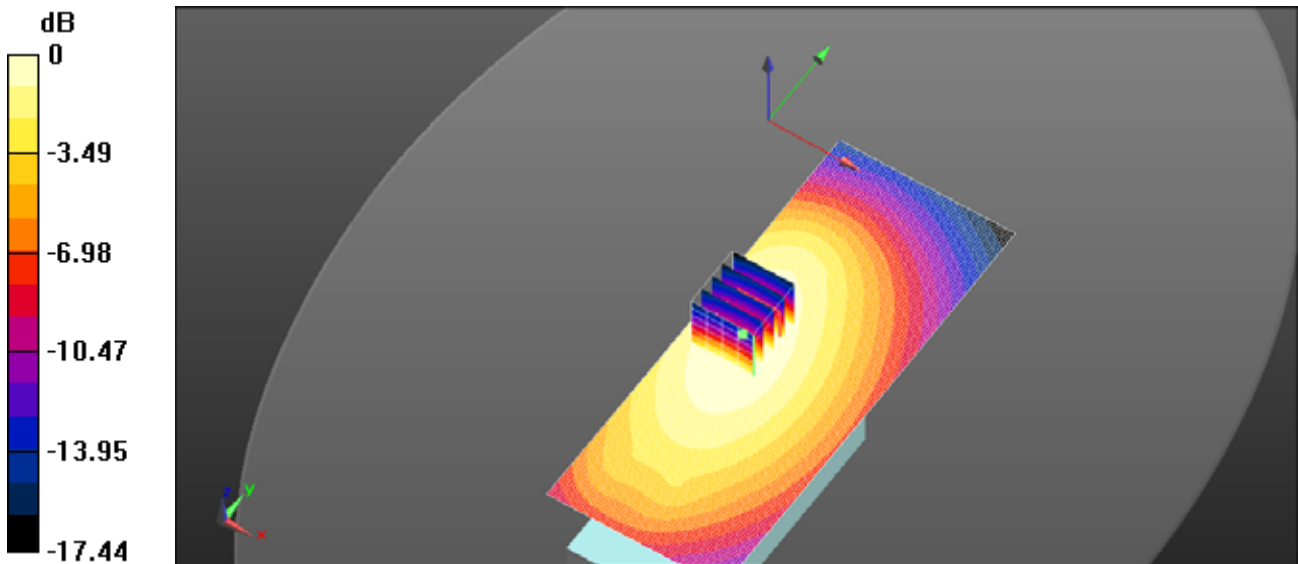

0 dB = 9.37 W/kg = 9.72 dBW/kg

Test Laboratory: HCT CO., LTD  
 EUT Type: UHF DIGITAL TRANSCEIVER  
 Liquid Temperature: 20.5  
 Ambient Temperature: 20.3  
 Test Date: Sep. 22, 2014  
 Plot No.: 13

**DUT: NX-5300-K6; Type: bar**

Communication System: UID 0, 400MHz FCC 2 (0); Frequency: 406.1 MHz; Duty Cycle: 1:1  
 Medium parameters used (interpolated):  $f = 406.1$  MHz;  $\sigma = 0.895$  S/m;  $\epsilon_r = 56.157$ ;  $\rho = 1000$  kg/m<sup>3</sup>  
 Phantom section: Flat Section

DASY4 Configuration:

- Probe: ET3DV6 - SN1605; ConvF(7.34, 7.34, 7.34); Calibrated: 2014-01-31;
- Sensor-Surface: 4mm (Mechanical Surface Detection)
- Electronics: DAE4 Sn1417; Calibrated: 2014-01-03
- Phantom: ELI v4.0; Type: QDOVA001BB; Serial: TP:xxxx
- ; SEMCAD X Version 14.6.10 (7331)

**NX-5300-K6/Body rear 1ch KNB-L2\_42M/Area Scan (61x151x1):** Interpolated grid: dx=1.500 mm, dy=1.500 mm  
 Maximum value of SAR (interpolated) = 7.32 W/kg

**NX-5300-K6/Body rear 1ch KNB-L2\_42M/Zoom Scan (5x5x7)/Cube 0:** Measurement grid: dx=8mm, dy=8mm, dz=5mm  
 Reference Value = 85.37 V/m; Power Drift = 0.08 dB  
 Peak SAR (extrapolated) = 9.47 W/kg  
**SAR(1 g) = 7.1 W/kg; SAR(10 g) = 5.45 W/kg**  
 Maximum value of SAR (measured) = 7.40 W/kg

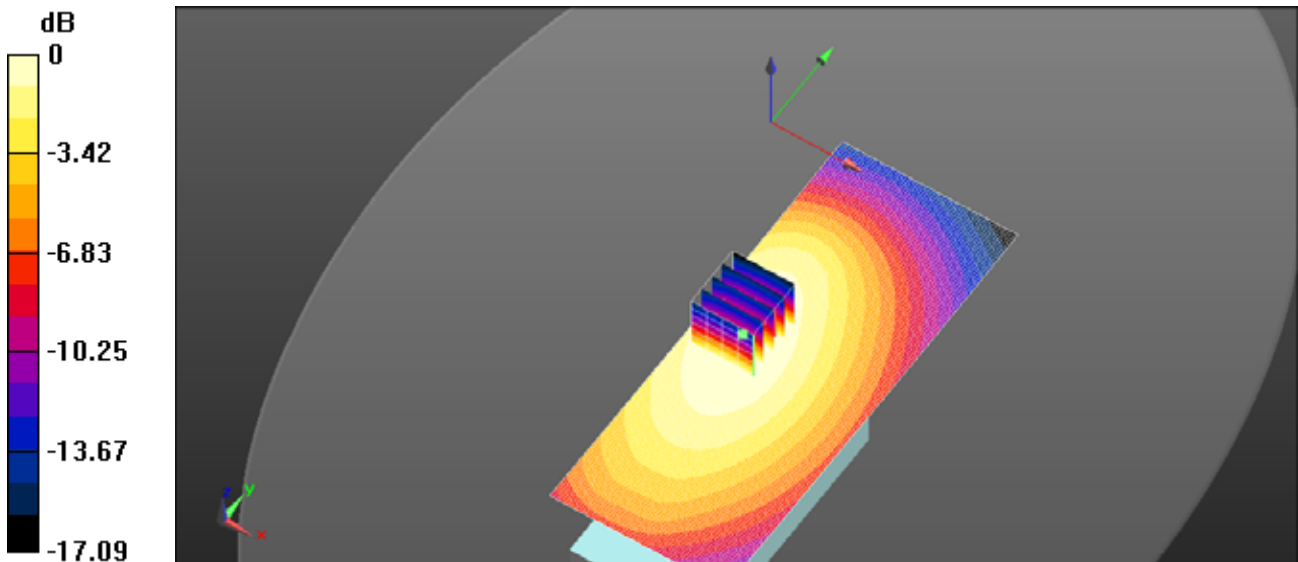

0 dB = 7.32 W/kg = 8.64 dBW/kg

Test Laboratory: HCT CO., LTD  
 EUT Type: UHF DIGITAL TRANSCEIVER  
 Liquid Temperature: 20.5  
 Ambient Temperature: 20.3  
 Test Date: Sep. 22, 2014  
 Plot No.: 14

**DUT: NX-5300-K6; Type: bar**

Communication System: UID 0, 400MHz FCC 2 (0); Frequency: 406.1 MHz; Duty Cycle: 1:1  
 Medium parameters used (interpolated):  $f = 406.1$  MHz;  $\sigma = 0.895$  S/m;  $\epsilon_r = 56.157$ ;  $\rho = 1000$  kg/m<sup>3</sup>  
 Phantom section: Flat Section

DASY4 Configuration:

- Probe: ET3DV6 - SN1605; ConvF(7.34, 7.34, 7.34); Calibrated: 2014-01-31;
- Sensor-Surface: 4mm (Mechanical Surface Detection)
- Electronics: DAE4 Sn1417; Calibrated: 2014-01-03
- Phantom: ELI v4.0; Type: QDOVA001BB; Serial: TP:xxxx
- ; SEMCAD X Version 14.6.10 (7331)

**NX-5300-K6/Body rear 1ch KNB-L3\_42M/Area Scan (61x151x1):** Interpolated grid: dx=1.500 mm, dy=1.500 mm  
 Maximum value of SAR (interpolated) = 7.58 W/kg

**NX-5300-K6/Body rear 1ch KNB-L3\_42M/Zoom Scan (5x5x7)/Cube 0:** Measurement grid: dx=8mm, dy=8mm, dz=5mm  
 Reference Value = 89.33 V/m; Power Drift = -0.42 dB  
 Peak SAR (extrapolated) = 9.79 W/kg  
**SAR(1 g) = 7.33 W/kg; SAR(10 g) = 5.58 W/kg**  
 Maximum value of SAR (measured) = 7.59 W/kg

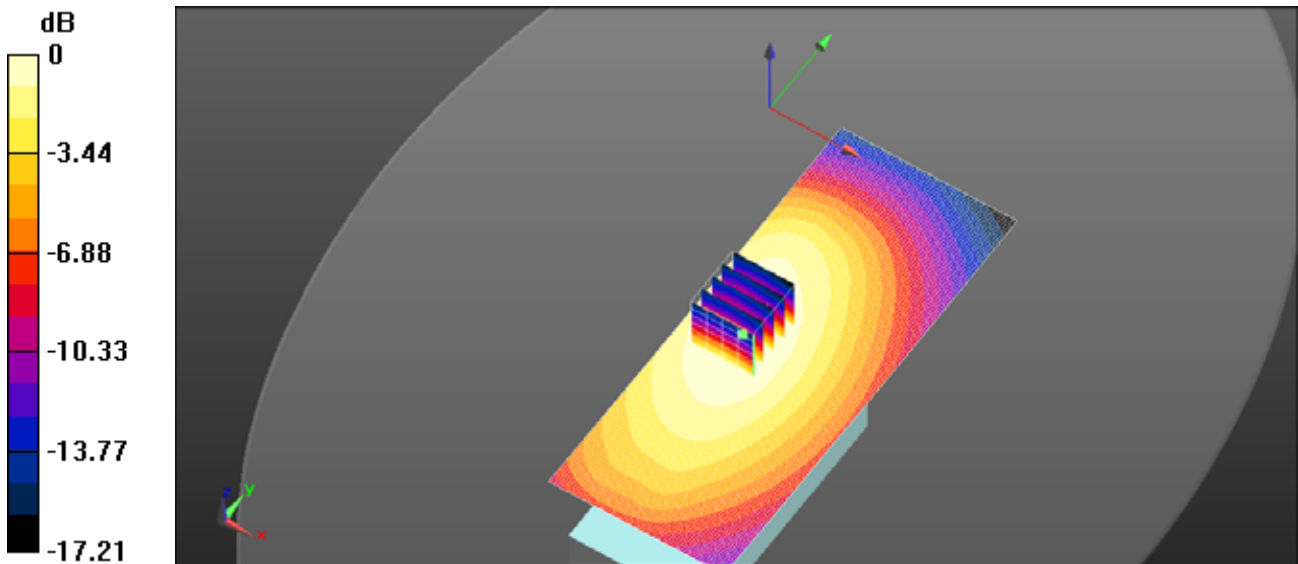

0 dB = 7.58 W/kg = 8.79 dBW/kg

Test Laboratory: HCT CO., LTD  
 EUT Type: UHF DIGITAL TRANSCEIVER  
 Liquid Temperature: 20.2  
 Ambient Temperature: 20.4  
 Test Date: Jan. 06, 2015  
 Plot No.: 15

**DUT: NX-5300-K6; Type: bar**

Communication System: UID 0, 400MHz FCC 2 (0); Frequency: 422.075 MHz; Duty Cycle: 1:1  
 Medium parameters used (interpolated):  $f = 422.075$  MHz;  $\sigma = 0.93$  S/m;  $\epsilon_r = 55.971$ ;  $\rho = 1000$  kg/m<sup>3</sup>  
 Phantom section: Flat Section  
 Measurement Standard: DASYS (IEEE/IEC/ANSI C63.19-2007)

DASY4 Configuration:

- Probe: ET3DV6 - SN1798; ConvF(7.97, 7.97, 7.97); Calibrated: 2014-08-25;
- Sensor-Surface: 4mm (Mechanical Surface Detection)
- Electronics: DAE3 Sn466; Calibrated: 2014-02-27
- Phantom: ELI v4.0; Type: QDOVA001BB; Serial: TP:xxxx
- ; SEMCAD X Version 14.6.10 (7331)

**NX-5300-K6/Body rear 2 ch KNB-L1\_KRA-29/Area Scan (51x151x1):** Interpolated grid: dx=1.500 mm, dy=1.500 mm  
 Maximum value of SAR (interpolated) = 5.43 W/kg

**NX-5300-K6/Body rear 2 ch KNB-L1\_KRA-29/Zoom Scan (5x5x7)/Cube 0:** Measurement grid: dx=8mm, dy=8mm, dz=5mm  
 Reference Value = 77.28 V/m; Power Drift = -0.08 dB  
 Peak SAR (extrapolated) = 6.89 W/kg  
**SAR(1 g) = 5.15 W/kg; SAR(10 g) = 3.98 W/kg**  
 Maximum value of SAR (measured) = 5.35 W/kg

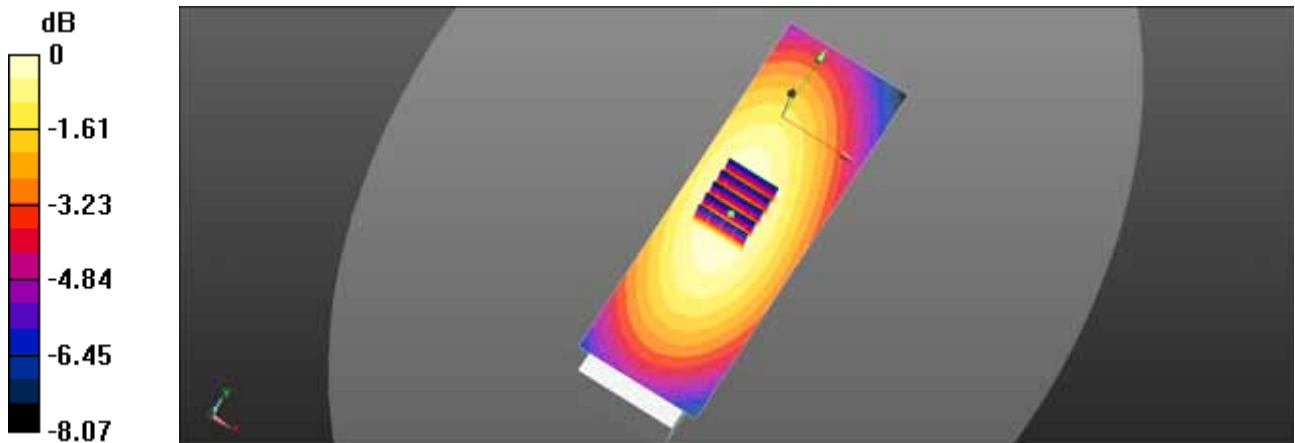

0 dB = 5.43 W/kg = 7.35 dBW/kg

Test Laboratory: HCT CO., LTD  
 EUT Type: UHF DIGITAL TRANSCEIVER  
 Liquid Temperature: 20.2  
 Ambient Temperature: 20.4  
 Test Date: Jan. 06, 2015  
 Plot No.: 16

**DUT: NX-5300-K6; Type: bar**

Communication System: UID 0, 400MHz FCC (0); Frequency: 406.1 MHz; Duty Cycle: 1:1  
 Medium parameters used (interpolated):  $f = 406.1 \text{ MHz}$ ;  $\sigma = 0.859 \text{ S/m}$ ;  $\epsilon_r = 46.417$ ;  $\rho = 1000 \text{ kg/m}^3$   
 Phantom section: Flat Section  
 Measurement Standard: DASYS5 (IEEE/IEC/ANSI C63.19-2007)

DASY4 Configuration:

- Probe: ET3DV6 - SN1798; ConvF(7.61, 7.61, 7.61); Calibrated: 2014-08-25;
- Sensor-Surface: 4mm (Mechanical Surface Detection)
- Electronics: DAE3 Sn466; Calibrated: 2014-02-27
- Phantom: ELI v4.0; Type: QDOVA001BB; Serial: TP:xxxx
- ; SEMCAD X Version 14.6.10 (7331)

**NX-5300-K6/Head front 1ch KMC-49\_KRA-29/Area Scan (51x151x1):** Interpolated grid:  $dx=1.500 \text{ mm}$ ,  $dy=1.500 \text{ mm}$   
 Maximum value of SAR (interpolated) = 3.78 W/kg

**NX-5300-K6/Head front 1ch KMC-49\_KRA-29/Zoom Scan (5x5x7)/Cube 0:** Measurement grid:  $dx=8\text{mm}$ ,  $dy=8\text{mm}$ ,  $dz=5\text{mm}$   
 Reference Value = 54.39 V/m; Power Drift = -0.18 dB  
 Peak SAR (extrapolated) = 4.58 W/kg  
**SAR(1 g) = 3.55 W/kg; SAR(10 g) = 2.7 W/kg**  
 Maximum value of SAR (measured) = 3.73 W/kg

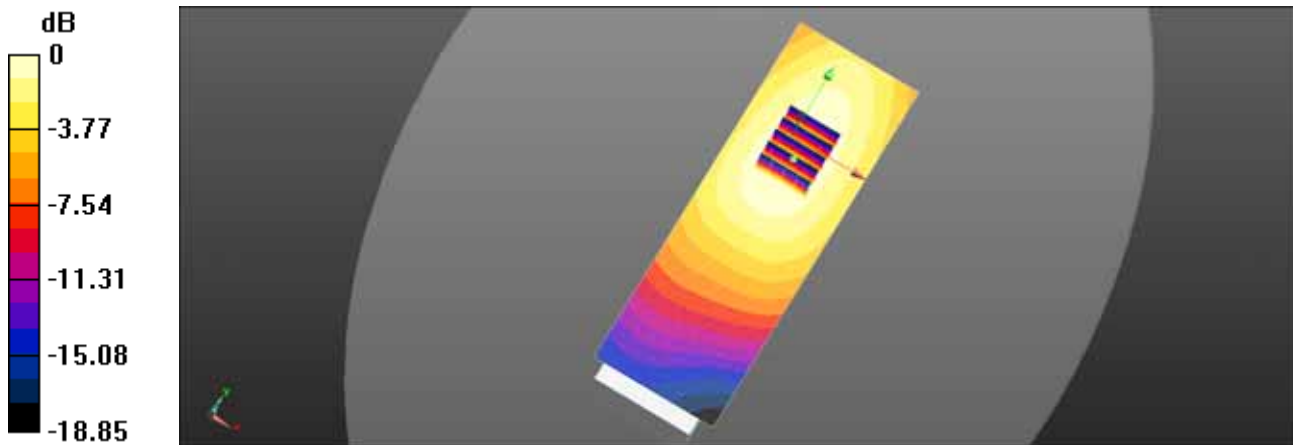

0 dB = 3.78 W/kg = 5.77 dBW/kg

Test Laboratory: HCT CO., LTD  
 EUT Type: UHF DIGITAL TRANSCEIVER  
 Liquid Temperature: 20.9  
 Ambient Temperature: 20.7  
 Test Date: Oct. 14, 2014  
 Plot No.: 17

**DUT: KMC-49; Type: bar**

Communication System: UID 0, 400MHz FCC 2 (0); Frequency: 454.025 MHz; Duty Cycle: 1:1  
 Medium parameters used:  $f = 455 \text{ MHz}$ ;  $\sigma = 0.945 \text{ S/m}$ ;  $\epsilon_r = 55.231$ ;  $\rho = 1000 \text{ kg/m}^3$   
 Phantom section: Flat Section  
 Measurement Standard: DASy5 (IEEE/IEC/ANSI C63.19-2007)

DASy4 Configuration:

- Probe: ET3DV6 - SN1605; ConvF(7.34, 7.34, 7.34); Calibrated: 2014-01-31;
- Sensor-Surface: 4mm (Mechanical Surface Detection)
- Electronics: DAE4 Sn1417; Calibrated: 2014-01-03
- Phantom: ELI v4.0; Type: QDOVA001BB; Serial: TP:xxxx
- ; SEMCAD X Version 14.6.10 (7331)

**NX-5300-K6/Body Rear 4ch KNB-L3\_23M\_KMC-49/Area Scan (61x121x1):** Interpolated grid:  $dx=1.500 \text{ mm}$ ,  $dy=1.500 \text{ mm}$   
 Maximum value of SAR (interpolated) = 7.31 W/kg

**NX-5300-K6/Body Rear 4ch KNB-L3\_23M\_KMC-49/Zoom Scan (5x5x7)/Cube 0:** Measurement grid:  $dx=8\text{mm}$ ,  $dy=8\text{mm}$ ,  $dz=5\text{mm}$   
 Reference Value = 81.71 V/m; Power Drift = -0.19 dB  
 Peak SAR (extrapolated) = 9.31 W/kg  
**SAR(1 g) = 6.88 W/kg; SAR(10 g) = 5.08 W/kg**  
 Maximum value of SAR (measured) = 7.24 W/kg

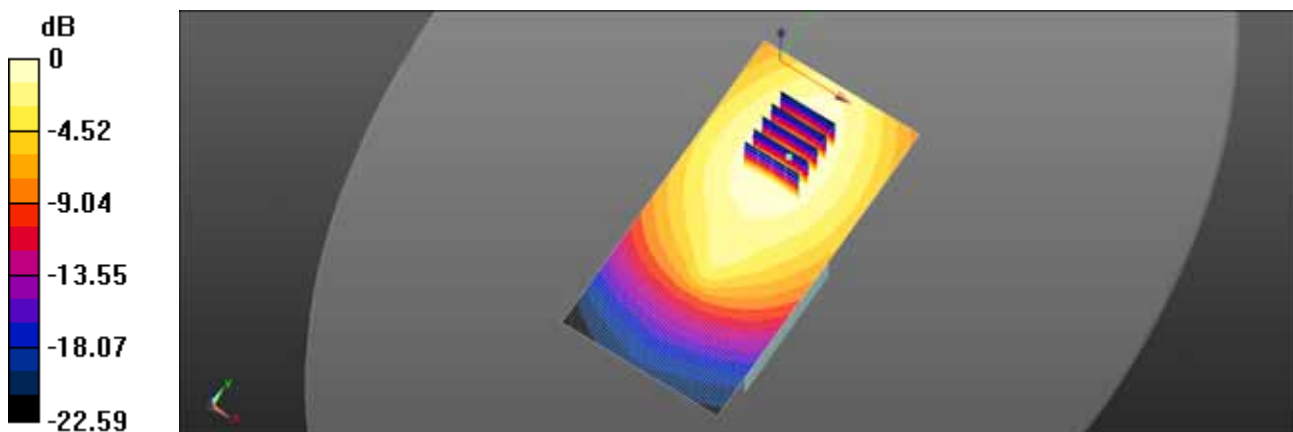

0 dB = 7.31 W/kg = 8.64 dBW/kg

## Attachment 2. –Dipole Verification Plots



## ■ Verification Data (450 MHz Head)

Test Laboratory: HCT CO., LTD  
 Input Power 100 mW (20 dBm)  
 Liquid Temp: 20.4  
 Test Date: Sep. 23, 2014

**DUT: Dipole 450 MHz D450V2; Type: D450V2; Serial: D450V2 - SN:1007**

Communication System: UID 0, CW; Frequency: 450 MHz; Duty Cycle: 1:1  
 Medium parameters used:  $f = 450 \text{ MHz}$ ;  $\sigma = 0.867 \text{ S/m}$ ;  $\epsilon_r = 43.883$ ;  $\rho = 1000 \text{ kg/m}^3$   
 Phantom section: Flat Section

DASY4 Configuration:

- Probe: ET3DV6 - SN1605; ConvF(7.34, 7.34, 7.34); Calibrated: 2014-01-31;
- Sensor-Surface: 4mm (Mechanical Surface Detection)
- Electronics: DAE4 Sn1417; Calibrated: 2014-01-03
- Phantom: ELI v4.0; Type: QDOVA001BB; Serial: TP:xxxx
- ; SEMCAD X Version 14.6.10 (7331)

**450MHz SAR validation/450MHz Validation/Area Scan (61x171x1):** Interpolated grid:  $dx=1.500 \text{ mm}$ ,  $dy=1.500 \text{ mm}$   
 Maximum value of SAR (interpolated) = 0.495 W/kg

**450MHz SAR validation/450MHz Validation/Zoom Scan (5x5x7)/Cube 0:** Measurement grid:  $dx=8\text{mm}$ ,  $dy=8\text{mm}$ ,  $dz=5\text{mm}$   
 Reference Value = 24.48 V/m; Power Drift = 0.01 dB  
 Peak SAR (extrapolated) = 0.640 W/kg  
**SAR(1 g) = 0.464 W/kg; SAR(10 g) = 0.326 W/kg**  
 Maximum value of SAR (measured) = 0.498 W/kg

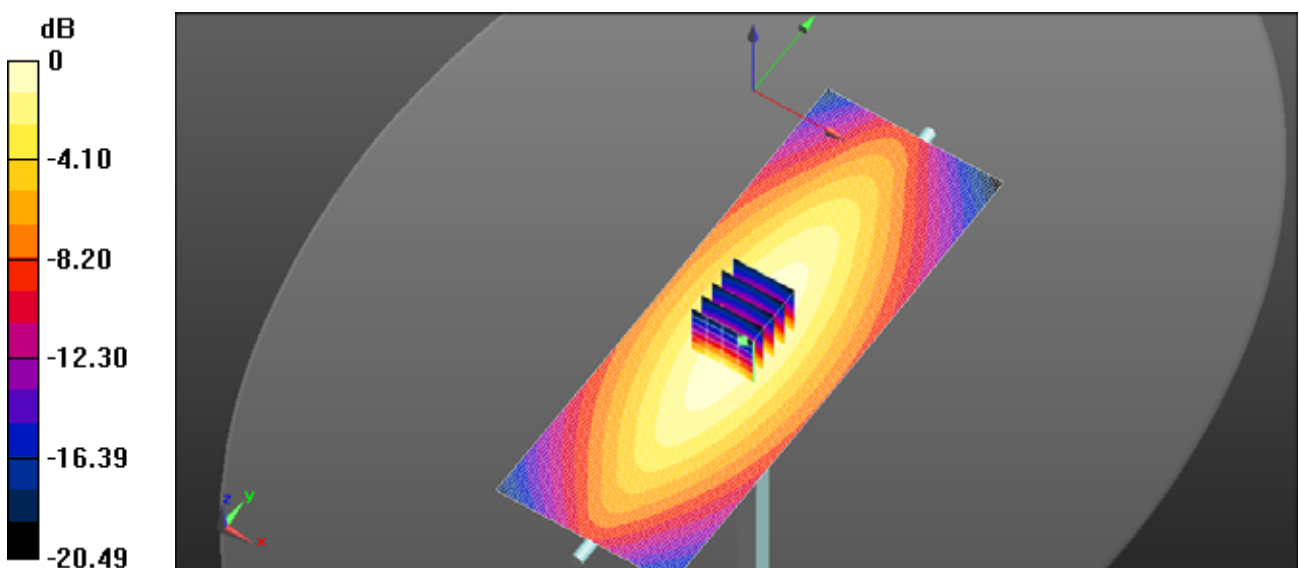

0 dB = 0.495 W/kg = -3.05 dBW/kg

## ■ Verification Data (450 MHz Body)

Test Laboratory: HCT CO., LTD  
 Input Power 100 mW (20 dBm)  
 Liquid Temp: 20.2  
 Test Date: Sep. 22, 2014

**DUT: Dipole 450 MHz D450V2; Type: D450V2; Serial: D450V2 - SN:1007**

Communication System: UID 0, CW; Frequency: 450 MHz; Duty Cycle: 1:1  
 Medium parameters used:  $f = 450 \text{ MHz}$ ;  $\sigma = 0.933 \text{ S/m}$ ;  $\epsilon_r = 55.298$ ;  $\rho = 1000 \text{ kg/m}^3$   
 Phantom section: Flat Section

DASY4 Configuration:

- Probe: ET3DV6 - SN1605; ConvF(7.34, 7.34, 7.34); Calibrated: 2014-01-31;
- Sensor-Surface: 4mm (Mechanical Surface Detection)
- Electronics: DAE4 Sn1417; Calibrated: 2014-01-03
- Phantom: ELI v4.0; Type: QDOVA001BB; Serial: TP:xxxx
- ; SEMCAD X Version 14.6.10 (7331)

**450MHz SAR Verification/450MHz Verification/Area Scan (61x171x1):** Interpolated grid:  $dx=1.500 \text{ mm}$ ,  $dy=1.500 \text{ mm}$   
 Maximum value of SAR (interpolated) = 0.535 W/kg

**450MHz SAR Verification/450MHz Verification/Zoom Scan (5x5x7)/Cube 0:** Measurement grid:  $dx=8\text{mm}$ ,  $dy=8\text{mm}$ ,  $dz=5\text{mm}$   
 Reference Value = 24.16 V/m; Power Drift = -0.03 dB  
 Peak SAR (extrapolated) = 0.740 W/kg  
**SAR(1 g) = 0.501 W/kg; SAR(10 g) = 0.346 W/kg**  
 Maximum value of SAR (measured) = 0.535 W/kg

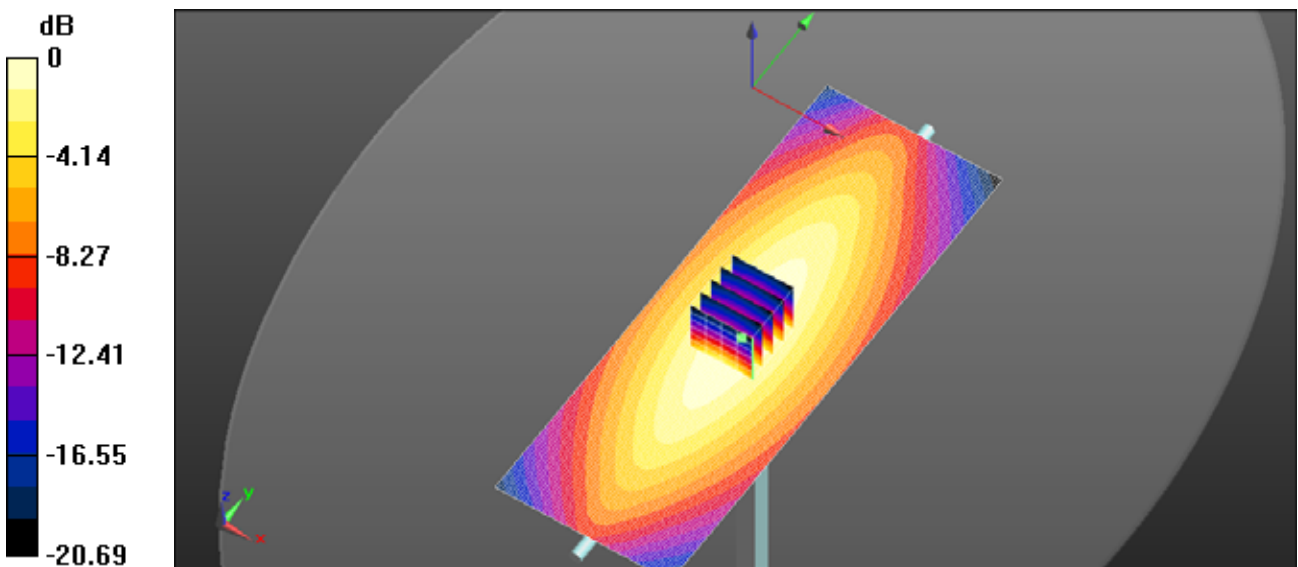

0 dB = 0.535 W/kg = -2.72 dBW/kg

## ■ Verification Data (450 MHz Body)

Test Laboratory: HCT CO., LTD  
 Input Power 100 mW (20 dBm)  
 Liquid Temp: 20.5  
 Test Date: Sep. 21, 2014

**DUT: Dipole 450 MHz D450V2; Type: D450V2; Serial: D450V2 – SN:1007**

Communication System: UID 0, CW; Frequency: 450 MHz; Duty Cycle: 1:1  
 Medium parameters used:  $f = 450 \text{ MHz}$ ;  $\sigma = 0.938 \text{ S/m}$ ;  $\epsilon_r = 55.398$ ;  $\rho = 1000 \text{ kg/m}^3$   
 Phantom section: Flat Section  
 Measurement Standard: DASy5 (IEEE/IEC/ANSI C63.19-2007)

DASy4 Configuration:

- Probe: ET3DV6 - SN1605; ConvF(7.34, 7.34, 7.34); Calibrated: 2014-01-31;
- Sensor-Surface: 4mm (Mechanical Surface Detection)
- Electronics: DAE4 Sn1417; Calibrated: 2014-01-03
- Phantom: ELI v4.0; Type: QDOVA001BB; Serial: TP:xxxx
- ; SEMCAD X Version 14.6.10 (7331)

**450MHz SAR Verification/450MHz Verification/Area Scan (61x171x1):** Interpolated grid:  $dx=1.500 \text{ mm}$ ,  $dy=1.500 \text{ mm}$   
 Maximum value of SAR (interpolated) = 0.511 W/kg

**450MHz SAR Verification/450MHz Verification/Zoom Scan (5x5x7)/Cube 0:** Measurement grid:  $dx=8\text{mm}$ ,  $dy=8\text{mm}$ ,  $dz=5\text{mm}$   
 Reference Value = 23.53 V/m; Power Drift = 0.01 dB  
 Peak SAR (extrapolated) = 0.711 W/kg  
**SAR(1 g) = 0.483 W/kg; SAR(10 g) = 0.335 W/kg**  
 Maximum value of SAR (measured) = 0.515 W/kg

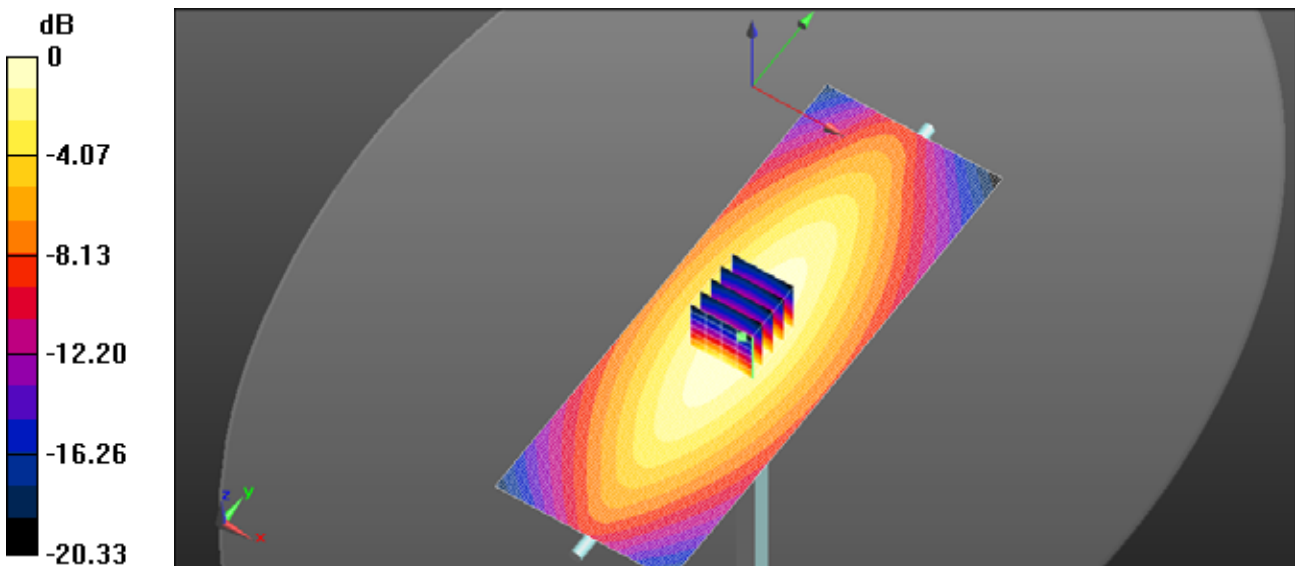

0 dB = 0.511 W/kg = -2.91 dBW/kg

## ■ Verification Data (450 MHz Head)

Test Laboratory: HCT CO., LTD  
 Input Power 100 mW (20 dBm)  
 Liquid Temp: 20.7  
 Test Date: Oct. 14, 2014

**DUT: Dipole 450 MHz D450V2; Type: D450V2; Serial: D450V2 - SN: 1007**

Communication System: UID 0, CW; Frequency: 450 MHz; Duty Cycle: 1:1  
 Medium parameters used:  $f = 450 \text{ MHz}$ ;  $\sigma = 0.867 \text{ S/m}$ ;  $\epsilon_r = 43.959$ ;  $\rho = 1000 \text{ kg/m}^3$   
 Phantom section: Flat Section  
 Measurement Standard: DASYS (IEEE/IEC/ANSI C63.19-2007)

DASY4 Configuration:

- Probe: ET3DV6 - SN1605; ConvF(7.34, 7.34, 7.34); Calibrated: 2014-01-31;
- Sensor-Surface: 4mm (Mechanical Surface Detection)
- Electronics: DAE4 Sn652; Calibrated: 2014-03-26
- Phantom: ELI v4.0; Type: QDOVA001BB; Serial: TP:xxxx
- ; SEMCAD X Version 14.6.10 (7331)

**450MHz SAR validation/450MHz Validation/Area Scan (61x171x1):** Interpolated grid:  $dx=1.500 \text{ mm}$ ,  $dy=1.500 \text{ mm}$   
 Maximum value of SAR (interpolated) = 0.534 W/kg

**450MHz SAR validation/450MHz Validation/Zoom Scan (5x5x7)/Cube 0:** Measurement grid:  $dx=8\text{mm}$ ,  $dy=8\text{mm}$ ,  $dz=5\text{mm}$   
 Reference Value = 25.51 V/m; Power Drift = 0.01 dB  
 Peak SAR (extrapolated) = 0.716 W/kg  
**SAR(1 g) = 0.500 W/kg; SAR(10 g) = 0.346 W/kg**  
 Maximum value of SAR (measured) = 0.534 W/kg

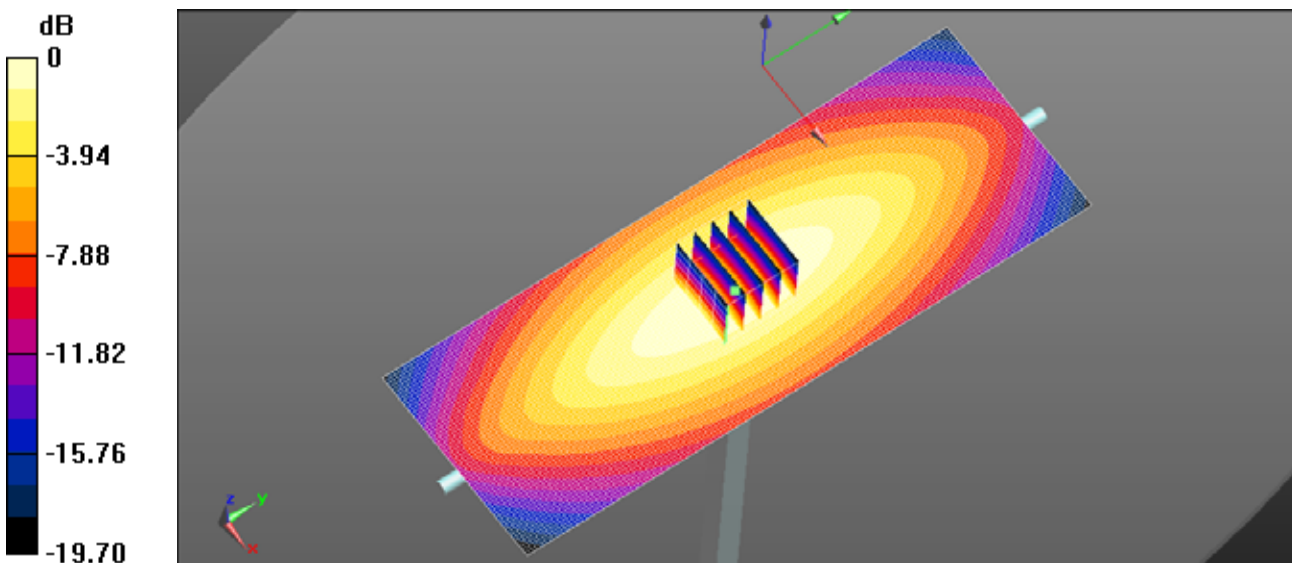

$0 \text{ dB} = 0.534 \text{ W/kg} = -2.72 \text{ dBW/kg}$

## ■ Verification Data (450 MHz Body)

Test Laboratory: HCT CO., LTD  
 Input Power 100 mW (20 dBm)  
 Liquid Temp: 20.7  
 Test Date: Oct. 14, 2014

**DUT: Dipole 450 MHz D450V2; Type: D450V2; Serial: D450V2 - SN: 1007**

Communication System: UID 0, CW; Frequency: 450 MHz; Duty Cycle: 1:1  
 Medium parameters used:  $f = 450 \text{ MHz}$ ;  $\sigma = 0.938 \text{ S/m}$ ;  $\epsilon_r = 55.308$ ;  $\rho = 1000 \text{ kg/m}^3$   
 Phantom section: Flat Section  
 Measurement Standard: DASYS (IEEE/IEC/ANSI C63.19-2007)

DASY4 Configuration:

- Probe: ET3DV6 - SN1605; ConvF(7.34, 7.34, 7.34); Calibrated: 2014-01-31;
- Sensor-Surface: 4mm (Mechanical Surface Detection)
- Electronics: DAE4 Sn652; Calibrated: 2014-03-26
- Phantom: ELI v4.0; Type: QDOVA001BB; Serial: TP:xxxx
- ; SEMCAD X Version 14.6.10 (7331)

**450MHz SAR verification/450MHz Verification/Area Scan (61x171x1):** Interpolated grid:  $dx=1.500 \text{ mm}$ ,  $dy=1.500 \text{ mm}$   
 Maximum value of SAR (interpolated) = 0.524 W/kg

**450MHz SAR verification/450MHz Verification/Zoom Scan (5x5x7)/Cube 0:** Measurement grid:  $dx=8\text{mm}$ ,  $dy=8\text{mm}$ ,  $dz=5\text{mm}$   
 Reference Value = 23.77 V/m; Power Drift = 0.03 dB  
 Peak SAR (extrapolated) = 0.784 W/kg  
**SAR(1 g) = 0.497 W/kg; SAR(10 g) = 0.331 W/kg**  
 Maximum value of SAR (measured) = 0.530 W/kg

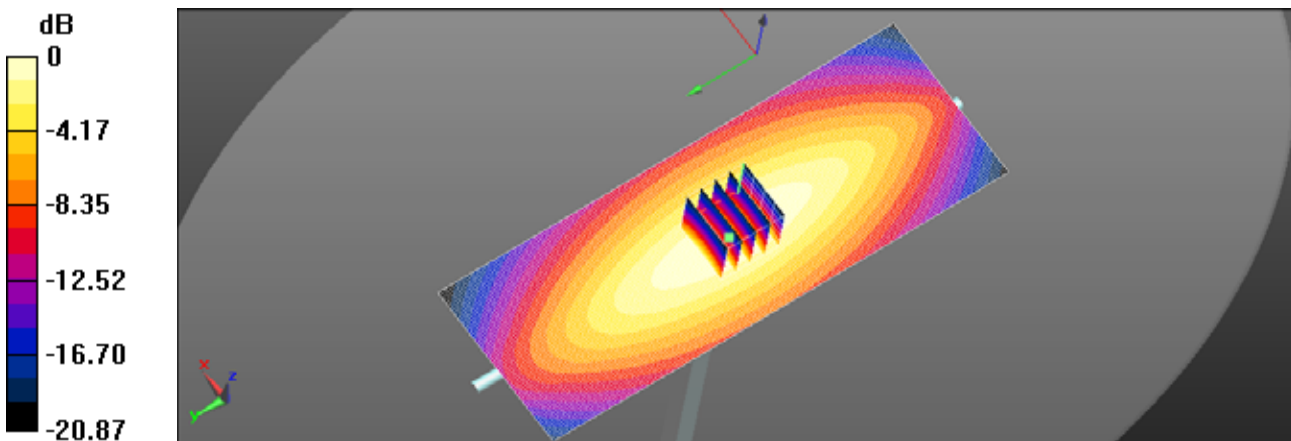

$$0 \text{ dB} = 0.524 \text{ W/kg} = -2.81 \text{ dBW/kg}$$

## ■ Verification Data (450 MHz Head)

Test Laboratory: HCT CO., LTD  
 Input Power 100 mW (20 dBm)  
 Liquid Temp: 20.2  
 Test Date: Jan. 06, 2015

**DUT: Dipole 450 MHz D450V2; Type: D450V2; Serial: D450V2 - SN: 1007**

Communication System: UID 0, CW; Frequency: 450 MHz; Duty Cycle: 1:1  
 Medium parameters used:  $f = 450 \text{ MHz}$ ;  $\sigma = 0.895 \text{ S/m}$ ;  $\epsilon_r = 45.124$ ;  $\rho = 1000 \text{ kg/m}^3$   
 Phantom section: Flat Section  
 Measurement Standard: DASY5 (IEEE/IEC/ANSI C63.19-2007)

DASY4 Configuration:

- Probe: ET3DV6 - SN1798; ConvF(7.61, 7.61, 7.61); Calibrated: 2014-08-25;
- Sensor-Surface: 4mm (Mechanical Surface Detection)
- Electronics: DAE3 Sn466; Calibrated: 2014-02-27
- Phantom: ELI v4.0; Type: QDOVA001BB; Serial: TP:xxxx
- ; SEMCAD X Version 14.6.10 (7331)

**450Mhz SAR validation/450MHz Validation/Area Scan (61x171x1):** Interpolated grid:  $dx=1.500 \text{ mm}$ ,  $dy=1.500 \text{ mm}$   
 Maximum value of SAR (interpolated) = 0.506 W/kg

**450Mhz SAR validation/450MHz Validation/Zoom Scan (5x5x7)/Cube 0:** Measurement grid:  $dx=8\text{mm}$ ,  $dy=8\text{mm}$ ,  $dz=5\text{mm}$   
 Reference Value = 24.17 V/m; Power Drift = 0.03 dB  
 Peak SAR (extrapolated) = 0.690 W/kg  
**SAR(1 g) = 0.473 W/kg; SAR(10 g) = 0.326 W/kg**  
 Maximum value of SAR (measured) = 0.506 W/kg

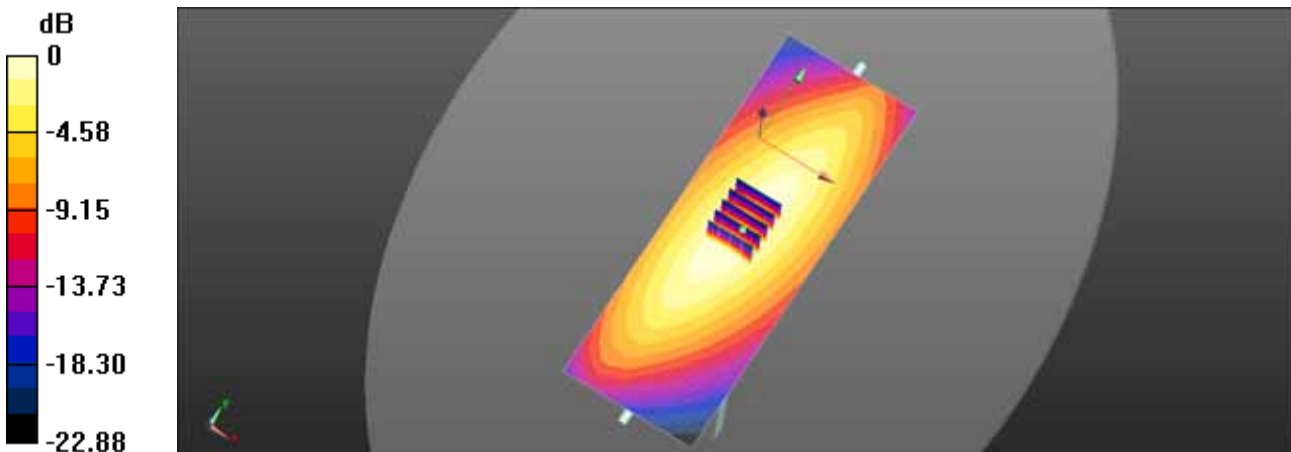

0 dB = 0.506 W/kg = -2.96 dBW/kg

## ■ Verification Data (450 MHz Body)

Test Laboratory: HCT CO., LTD  
 Input Power 100 mW (20 dBm)  
 Liquid Temp: 20.2  
 Test Date: Jan. 06, 2015

**DUT: Dipole 450 MHz D450V2; Type: D450V2; Serial: D450V2 - SN: 1007**

Communication System: UID 0, CW; Frequency: 450 MHz; Duty Cycle: 1:1  
 Medium parameters used:  $f = 450 \text{ MHz}$ ;  $\sigma = 0.952 \text{ S/m}$ ;  $\epsilon_r = 54.652$ ;  $\rho = 1000 \text{ kg/m}^3$   
 Phantom section: Flat Section  
 Measurement Standard: DASY5 (IEEE/IEC/ANSI C63.19-2007)

DASY4 Configuration:

- Probe: ET3DV6 - SN1798; ConvF(7.97, 7.97, 7.97); Calibrated: 2014-08-25;
- Sensor-Surface: 4mm (Mechanical Surface Detection)
- Electronics: DAE3 Sn466; Calibrated: 2014-02-27
- Phantom: ELI v4.0; Type: QDOVA001BB; Serial: TP:xxxx
- ; SEMCAD X Version 14.6.10 (7331)

**450Mhz SAR verification/450MHz Verification/Area Scan (61x171x1):** Interpolated grid:  $dx=1.500 \text{ mm}$ ,  $dy=1.500 \text{ mm}$   
 Maximum value of SAR (interpolated) = 0.509 W/kg

**450Mhz SAR verification/450MHz Verification/Zoom Scan (5x5x7)/Cube 0:** Measurement grid:  $dx=8\text{mm}$ ,  $dy=8\text{mm}$ ,  $dz=5\text{mm}$   
 Reference Value = 23.35 V/m; Power Drift = 0.02 dB  
 Peak SAR (extrapolated) = 0.765 W/kg  
**SAR(1 g) = 0.481 W/kg; SAR(10 g) = 0.317 W/kg**  
 Maximum value of SAR (measured) = 0.514 W/kg

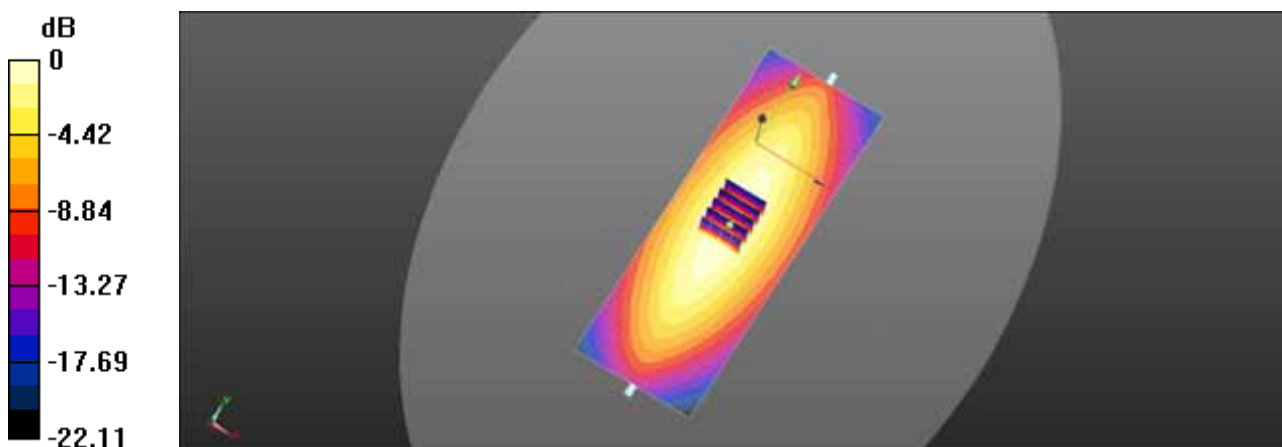

0 dB = 0.509 W/kg = -2.93 dBW/kg

## Attachment 3. – Probe Calibration Data



**Calibration Laboratory of  
Schmid & Partner  
Engineering AG**  
Zeughausstrasse 43, 8004 Zurich, Switzerland



**S** Schweizerischer Kalibrierdienst  
**S** Service suisse d'étalonnage  
**S** Servizio svizzero di taratura  
**S** Swiss Calibration Service

Accredited by the Swiss Accreditation Service (SAS)  
The Swiss Accreditation Service is one of the signatories to the EA  
Multilateral Agreement for the recognition of calibration certificates

Accreditation No.: **SCS 108**

Client **HCT (Dymstec)**

Certificate No: **ET3-1605\_Jan14/2**

**CALIBRATION CERTIFICATE (Replacement of No: ET3-1605\_Jan14)**

Object **ET3DV6 - SN:1605**

Calibration procedure(s) **QA CAL-01.v9, QA CAL-12.v9, QA CAL-23.v5, QA CAL-25.v6  
Calibration procedure for dosimetric E-field probes**

Calibration date: **January 31, 2014**

This calibration certificate documents the traceability to national standards, which realize the physical units of measurements (SI).  
The measurements and the uncertainties with confidence probability are given on the following pages and are part of the certificate.

All calibrations have been conducted in the closed laboratory facility: environment temperature (22 ± 3)°C and humidity < 70%.

Calibration Equipment used (M&TE critical for calibration)

Primary Standards	ID	Cal Date (Certificate No.)	Scheduled Calibration
Power meter E4419B	GB41293874	04-Apr-13 (No. 217-01733)	Apr-14
Power sensor E4412A	MY41496087	04-Apr-13 (No. 217-01733)	Apr-14
Reference 3 dB Attenuator	SN: S5054 (3c)	04-Apr-13 (No. 217-01737)	Apr-14
Reference 20 dB Attenuator	SN: S5277 (20x)	04-Apr-13 (No. 217-01735)	Apr-14
Reference 30 dB Attenuator	SN: S5129 (30b)	04-Apr-13 (No. 217-01738)	Apr-14
Reference Probe ES3DV2	SN: 3013	30-Dec-13 (No. ES3-3013_Dec13)	Dec-14
DAE4	SN: 660	13-Dec-13 (No. DAE4-660_Dec13)	Dec-14
Secondary Standards	ID	Check Date (in house)	Scheduled Check
RF generator HP 8648C	US3642U01700	4-Aug-99 (in house check Apr-13)	In house check: Apr-16
Network Analyzer HP 8753E	US37390585	18-Oct-01 (in house check Oct-13)	In house check: Oct-14

Calibrated by:	Name <b>Jeton Kastrati</b>	Function <b>Laboratory Technician</b>	Signature 
Approved by:	Name <b>Katja Pokovic</b>	Function <b>Technical Manager</b>	Signature 

Issued: January 31, 2014

This calibration certificate shall not be reproduced except in full without written approval of the laboratory.

**Calibration Laboratory of  
Schmid & Partner  
Engineering AG**  
Zeughausstrasse 43, 8004 Zurich, Switzerland



**S** Schweizerischer Kalibrierdienst  
**C** Service suisse d'étalonnage  
**S** Servizio svizzero di taratura  
**S** Swiss Calibration Service

Accredited by the Swiss Accreditation Service (SAS)  
The Swiss Accreditation Service is one of the signatories to the EA  
Multilateral Agreement for the recognition of calibration certificates

Accreditation No.: **SCS 108**

**Glossary:**

TSL	tissue simulating liquid
NORM <sub>x,y,z</sub>	sensitivity in free space
ConvF	sensitivity in TSL / NORM <sub>x,y,z</sub>
DCP	diode compression point
CF	crest factor (1/duty_cycle) of the RF signal
A, B, C, D	modulation dependent linearization parameters
Polarization $\varphi$	$\varphi$ rotation around probe axis
Polarization $\theta$	$\theta$ rotation around an axis that is in the plane normal to probe axis (at measurement center), i.e., $\theta = 0$ is normal to probe axis
Connector Angle	information used in DASY system to align probe sensor X to the robot coordinate system

**Calibration is Performed According to the Following Standards:**

- a) IEEE Std 1528-2013, "IEEE Recommended Practice for Determining the Peak Spatial-Averaged Specific Absorption Rate (SAR) in the Human Head from Wireless Communications Devices: Measurement Techniques", June 2013
- b) IEC 62209-1, "Procedure to measure the Specific Absorption Rate (SAR) for hand-held devices used in close proximity to the ear (frequency range of 300 MHz to 3 GHz)", February 2005

**Methods Applied and Interpretation of Parameters:**

- **NORM<sub>x,y,z</sub>:** Assessed for E-field polarization  $\theta = 0$  ( $f \leq 900$  MHz in TEM-cell;  $f > 1800$  MHz: R22 waveguide). NORM<sub>x,y,z</sub> are only intermediate values, i.e., the uncertainties of NORM<sub>x,y,z</sub> does not affect the E<sup>2</sup>-field uncertainty inside TSL (see below ConvF).
- **NORM(f)<sub>x,y,z</sub> = NORM<sub>x,y,z</sub> \* frequency\_response** (see Frequency Response Chart). This linearization is implemented in DASY4 software versions later than 4.2. The uncertainty of the frequency response is included in the stated uncertainty of ConvF.
- **DCP<sub>x,y,z</sub>:** DCP are numerical linearization parameters assessed based on the data of power sweep with CW signal (no uncertainty required). DCP does not depend on frequency nor media.
- **PAR:** PAR is the Peak to Average Ratio that is not calibrated but determined based on the signal characteristics
- **A<sub>x,y,z</sub>; B<sub>x,y,z</sub>; C<sub>x,y,z</sub>; D<sub>x,y,z</sub>; VR<sub>x,y,z</sub>:** A, B, C, D are numerical linearization parameters assessed based on the data of power sweep for specific modulation signal. The parameters do not depend on frequency nor media. VR is the maximum calibration range expressed in RMS voltage across the diode.
- **ConvF and Boundary Effect Parameters:** Assessed in flat phantom using E-field (or Temperature Transfer Standard for  $f \leq 800$  MHz) and inside waveguide using analytical field distributions based on power measurements for  $f > 800$  MHz. The same setups are used for assessment of the parameters applied for boundary compensation (alpha, depth) of which typical uncertainty values are given. These parameters are used in DASY4 software to improve probe accuracy close to the boundary. The sensitivity in TSL corresponds to NORM<sub>x,y,z</sub> \* ConvF whereby the uncertainty corresponds to that given for ConvF. A frequency dependent ConvF is used in DASY version 4.4 and higher which allows extending the validity from  $\pm 50$  MHz to  $\pm 100$  MHz.
- **Spherical isotropy (3D deviation from isotropy):** in a field of low gradients realized using a flat phantom exposed by a patch antenna.
- **Sensor Offset:** The sensor offset corresponds to the offset of virtual measurement center from the probe tip (on probe axis). No tolerance required.
- **Connector Angle:** The angle is assessed using the information gained by determining the NORM<sub>x</sub> (no uncertainty required).

ET3DV6 – SN:1605

January 31, 2014

# Probe ET3DV6

## SN:1605

Manufactured: July 27, 2001  
Repaired: January 24, 2014  
Calibrated: January 31, 2014

Calibrated for DASY/EASY Systems  
(Note: non-compatible with DASY2 system!)

ET3DV6- SN:1605

January 31, 2014

## DASY/EASY - Parameters of Probe: ET3DV6 - SN:1605

### Basic Calibration Parameters

	Sensor X	Sensor Y	Sensor Z	Unc (k=2)
Norm ( $\mu\text{V}/(\text{V}/\text{m})^2$ ) <sup>A</sup>	1.49	1.76	1.49	± 10.1 %
DCP (mV) <sup>B</sup>	97.1	97.1	98.1	

### Modulation Calibration Parameters

UID	Communication System Name		A dB	B dB $\sqrt{\mu\text{V}}$	C	D dB	VR mV	Unc <sup>E</sup> (k=2)
0	CW	X	0.0	0.0	1.0	0.00	176.1	±3.5 %
		Y	0.0	0.0	1.0		186.9	
		Z	0.0	0.0	1.0		183.4	

The reported uncertainty of measurement is stated as the standard uncertainty of measurement multiplied by the coverage factor k=2, which for a normal distribution corresponds to a coverage probability of approximately 95%.

<sup>A</sup> The uncertainties of NormX,Y,Z do not affect the E<sup>2</sup>-field uncertainty inside TSL (see Pages 5 and 6).

<sup>B</sup> Numerical linearization parameter; uncertainty not required.

<sup>E</sup> Uncertainty is determined using the max. deviation from linear response applying rectangular distribution and is expressed for the square of the field value.

ET3DV6- SN:1605

January 31, 2014

## DASY/EASY - Parameters of Probe: ET3DV6 - SN:1605

### Calibration Parameter Determined in Head Tissue Simulating Media

f (MHz) <sup>c</sup>	Relative Permittivity <sup>f</sup>	Conductivity (S/m) <sup>f</sup>	ConvF X	ConvF Y	ConvF Z	Alpha <sup>g</sup>	Depth <sup>g</sup> (mm)	Unct. (k=2)
150	52.3	0.76	8.22	8.22	8.22	0.10	1.35	± 13.3 %
300	45.3	0.87	8.06	8.06	8.06	0.23	2.40	± 13.3 %
450	43.5	0.87	7.34	7.34	7.34	0.26	2.82	± 13.3 %
750	41.9	0.89	6.88	6.88	6.88	0.31	3.00	± 12.0 %
835	41.5	0.90	6.57	6.57	6.57	0.33	3.00	± 12.0 %
900	41.5	0.97	6.37	6.37	6.37	0.31	3.00	± 12.0 %
1450	40.5	1.20	5.69	5.69	5.69	0.44	2.69	± 12.0 %
1750	40.1	1.37	5.43	5.43	5.43	0.78	2.13	± 12.0 %
1900	40.0	1.40	5.20	5.20	5.20	0.80	2.05	± 12.0 %
1950	40.0	1.40	5.05	5.05	5.05	0.80	2.18	± 12.0 %
2300	39.5	1.67	4.83	4.83	4.83	0.80	1.92	± 12.0 %
2450	39.2	1.80	4.55	4.55	4.55	0.80	1.72	± 12.0 %

<sup>c</sup> Frequency validity of ± 100 MHz only applies for DASY v4.4 and higher (see Page 2), else it is restricted to ± 50 MHz. The uncertainty is the RSS of the ConvF uncertainty at calibration frequency and the uncertainty for the indicated frequency band.

<sup>f</sup> At frequencies below 3 GHz, the validity of tissue parameters ( $\epsilon$  and  $\sigma$ ) can be relaxed to ± 10% if liquid compensation formula is applied to measured SAR values. At frequencies above 3 GHz, the validity of tissue parameters ( $\epsilon$  and  $\sigma$ ) is restricted to ± 5%. The uncertainty is the RSS of the ConvF uncertainty for indicated target tissue parameters.

<sup>g</sup> Alpha/Depth are determined during calibration. SPEAG warrants that the remaining deviation due to the boundary effect after compensation is always less than ± 1% for frequencies below 3 GHz and below ± 2% for frequencies between 3-6 GHz at any distance larger than half the probe tip diameter from the boundary.

ET3DV6- SN:1605

January 31, 2014

## DASY/EASY - Parameters of Probe: ET3DV6 - SN:1605

### Calibration Parameter Determined in Body Tissue Simulating Media

f (MHz) <sup>C</sup>	Relative Permittivity <sup>F</sup>	Conductivity (S/m) <sup>F</sup>	ConvF X	ConvF Y	ConvF Z	Alpha <sup>G</sup>	Depth <sup>G</sup> (mm)	Unct. (k=2)
150	61.9	0.80	7.44	7.44	7.44	0.15	1.35	± 13.3 %
300	58.2	0.92	7.57	7.57	7.57	0.18	2.03	± 13.3 %
450	56.7	0.94	7.34	7.34	7.34	0.19	2.19	± 13.3 %
750	55.5	0.96	6.45	6.45	6.45	0.27	2.96	± 12.0 %
835	55.2	0.97	6.35	6.35	6.35	0.33	3.00	± 12.0 %
1750	53.4	1.49	4.81	4.81	4.81	0.80	2.59	± 12.0 %
1900	53.3	1.52	4.57	4.57	4.57	0.80	2.39	± 12.0 %
2450	52.7	1.95	3.97	3.97	3.97	0.57	1.04	± 12.0 %

<sup>C</sup> Frequency validity of ± 100 MHz only applies for DASY v4.4 and higher (see Page 2), else it is restricted to ± 50 MHz. The uncertainty is the RSS of the ConvF uncertainty at calibration frequency and the uncertainty for the indicated frequency band.

<sup>F</sup> At frequencies below 3 GHz, the validity of tissue parameters ( $\epsilon$  and  $\sigma$ ) can be relaxed to ± 10% if liquid compensation formula is applied to measured SAR values. At frequencies above 3 GHz, the validity of tissue parameters ( $\epsilon$  and  $\sigma$ ) is restricted to ± 5%. The uncertainty is the RSS of the ConvF uncertainty for indicated target tissue parameters.

<sup>G</sup> Alpha/Depth are determined during calibration. SPEAG warrants that the remaining deviation due to the boundary effect after compensation is always less than ± 1% for frequencies below 3 GHz and below ± 2% for frequencies between 3-6 GHz at any distance larger than half the probe tip diameter from the boundary.

ET3DV6-SN:1605

January 31, 2014

### Frequency Response of E-Field (TEM-Cell:ifi110 EXX, Waveguide: R22)

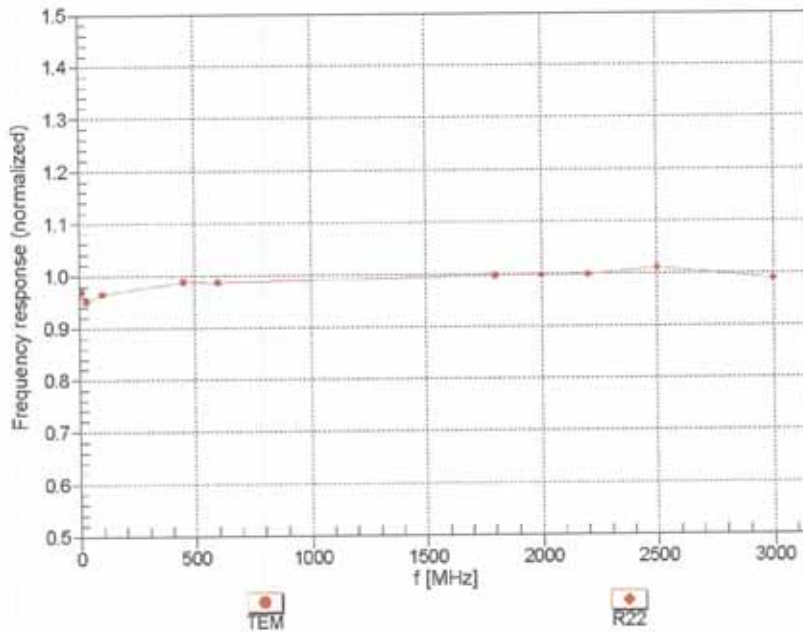

Uncertainty of Frequency Response of E-field:  $\pm 6.3\%$  (k=2)

ET3DV6-SN:1605

January 31, 2014

### Receiving Pattern ( $\phi$ ), $\theta = 0^\circ$

f=600 MHz, TEM

f=1800 MHz, R22

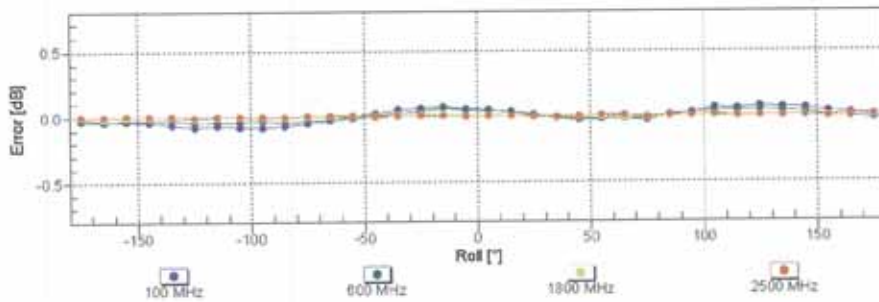
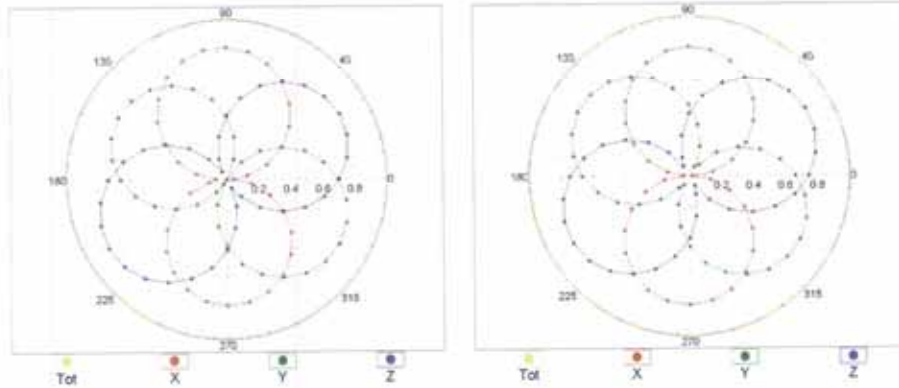

Uncertainty of Axial Isotropy Assessment:  $\pm 0.5\%$  (k=2)



ET3DV6- SN:1605

January 31, 2014

### Dynamic Range f(SAR<sub>head</sub>) (TEM cell , f = 900 MHz)

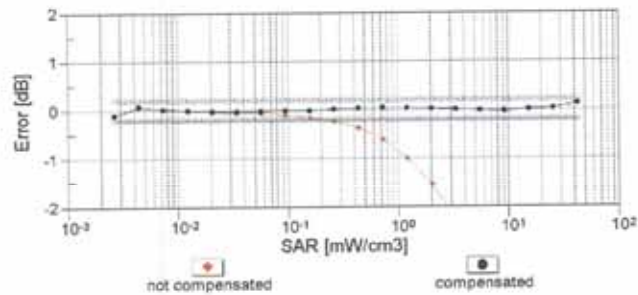
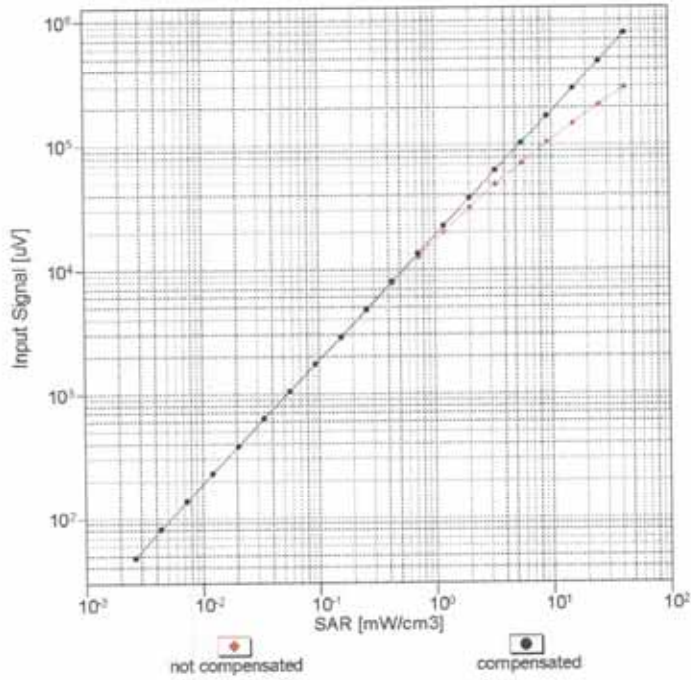

Uncertainty of Linearity Assessment: ± 0.6% (k=2)

ET3DV6-SN:1605

January 31, 2014

### Conversion Factor Assessment

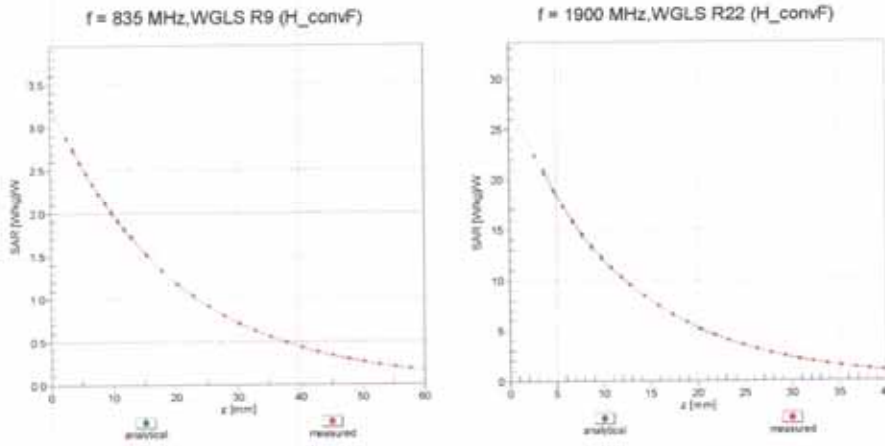

### Deviation from Isotropy in Liquid Error ( $\phi, \theta$ ), f = 900 MHz

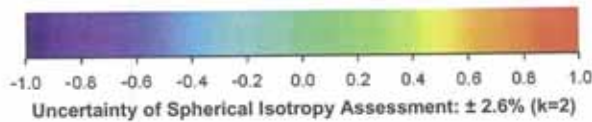
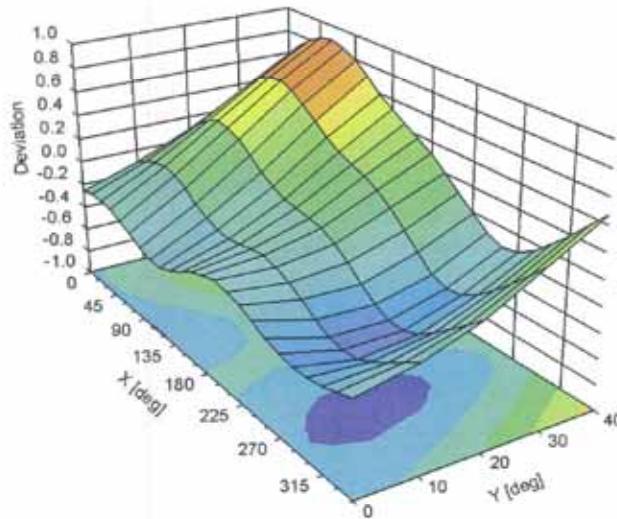

ET3DV6- SN:1605

January 31, 2014

**DASY/EASY - Parameters of Probe: ET3DV6 - SN:1605****Other Probe Parameters**

Sensor Arrangement	Triangular
Connector Angle (°)	-125
Mechanical Surface Detection Mode	enabled
Optical Surface Detection Mode	disabled
Probe Overall Length	337 mm
Probe Body Diameter	10 mm
Tip Length	10 mm
Tip Diameter	6.8 mm
Probe Tip to Sensor X Calibration Point	2.7 mm
Probe Tip to Sensor Y Calibration Point	2.7 mm
Probe Tip to Sensor Z Calibration Point	2.7 mm
Recommended Measurement Distance from Surface	4 mm

**Calibration Laboratory of  
Schmid & Partner  
Engineering AG**  
Zeughausstrasse 43, 8004 Zurich, Switzerland



**S** Schweizerischer Kalibrierdienst  
**S** Service suisse d'étalonnage  
**S** Servizio svizzero di taratura  
**S** Swiss Calibration Service

Accredited by the Swiss Accreditation Service (SAS)  
The Swiss Accreditation Service is one of the signatories to the EA  
Multilateral Agreement for the recognition of calibration certificates

Accreditation No.: **SCS 108**

Client **HCT (Dymstec)**

Certificate No: **ET3-1798\_Aug14**

**CALIBRATION CERTIFICATE**

Object **ET3DV6 - SN:1798**

Calibration procedure(s) **QA CAL-01.v9, QA CAL-12.v9, QA CAL-23.v5, QA CAL-25.v6  
Calibration procedure for dosimetric E-field probes**

Calibration date: **August 25, 2014**

This calibration certificate documents the traceability to national standards, which realize the physical units of measurements (SI).  
The measurements and the uncertainties with confidence probability are given on the following pages and are part of the certificate.

All calibrations have been conducted in the closed laboratory facility: environment temperature (22 ± 3)°C and humidity < 70%.

Calibration Equipment used (M&TE critical for calibration)

Primary Standards	ID	Cal Date (Certificate No.)	Scheduled Calibration
Power meter E4419B	GB41293874	03-Apr-14 (No. 217-01911)	Apr-15
Power sensor E4412A	MY41498087	03-Apr-14 (No. 217-01911)	Apr-15
Reference 3 dB Attenuator	SN: S5054 (3c)	03-Apr-14 (No. 217-01915)	Apr-15
Reference 20 dB Attenuator	SN: S5277 (20x)	03-Apr-14 (No. 217-01919)	Apr-15
Reference 30 dB Attenuator	SN: S5129 (30b)	03-Apr-14 (No. 217-01920)	Apr-15
Reference Probe ES3DV2	SN: 3013	30-Dec-13 (No. ES3-3013, Dec13)	Dec-14
DAE4	SN: 660	13-Dec-13 (No. DAE4-660, Dec13)	Dec-14
Secondary Standards	ID	Check Date (in house)	Scheduled Check
RF generator HP 8648C	US3642U01700	4-Aug-99 (in house check Apr-13)	In house check: Apr-16
Network Analyzer HP 8753E	US37390585	18-Oct-01 (in house check Oct-13)	In house check: Oct-14

	Name	Function	Signature
Calibrated by:	Jeton Kastrati	Laboratory Technician	
Approved by:	Katja Pokovic	Technical Manager	

Issued: August 25, 2014

This calibration certificate shall not be reproduced except in full without written approval of the laboratory.

**Calibration Laboratory of  
Schmid & Partner  
Engineering AG**  
Zeughausstrasse 43, 8004 Zurich, Switzerland



**S** Schweizerischer Kalibrierdienst  
**C** Service suisse d'étalonnage  
**S** Servizio svizzero di taratura  
**S** Swiss Calibration Service

Accredited by the Swiss Accreditation Service (SAS)  
The Swiss Accreditation Service is one of the signatories to the EA  
Multilateral Agreement for the recognition of calibration certificates

Accreditation No.: **SCS 108**

**Glossary:**

TSL	tissue simulating liquid
NORM <sub>x,y,z</sub>	sensitivity in free space
ConvF	sensitivity in TSL / NORM <sub>x,y,z</sub>
DCP	diode compression point
CF	crest factor (1/duty_cycle) of the RF signal
A, B, C, D	modulation dependent linearization parameters
Polarization $\varphi$	$\varphi$ rotation around probe axis
Polarization $\vartheta$	$\vartheta$ rotation around an axis that is in the plane normal to probe axis (at measurement center), i.e., $\vartheta = 0$ is normal to probe axis
Connector Angle	information used in DASY system to align probe sensor X to the robot coordinate system

**Calibration is Performed According to the Following Standards:**

- a) IEEE Std 1528-2013, "IEEE Recommended Practice for Determining the Peak Spatial-Averaged Specific Absorption Rate (SAR) in the Human Head from Wireless Communications Devices: Measurement Techniques", June 2013
- b) IEC 62209-1, "Procedure to measure the Specific Absorption Rate (SAR) for hand-held devices used in close proximity to the ear (frequency range of 300 MHz to 3 GHz)", February 2005

**Methods Applied and Interpretation of Parameters:**

- **NORM<sub>x,y,z</sub>**: Assessed for E-field polarization  $\vartheta = 0$  ( $f \leq 900$  MHz in TEM-cell;  $f > 1800$  MHz: R22 waveguide). NORM<sub>x,y,z</sub> are only intermediate values, i.e., the uncertainties of NORM<sub>x,y,z</sub> does not affect the E<sup>2</sup>-field uncertainty inside TSL (see below ConvF).
- **NORM(f)<sub>x,y,z</sub>** = NORM<sub>x,y,z</sub> \* frequency\_response (see Frequency Response Chart). This linearization is implemented in DASY4 software versions later than 4.2. The uncertainty of the frequency response is included in the stated uncertainty of ConvF.
- **DCP<sub>x,y,z</sub>**: DCP are numerical linearization parameters assessed based on the data of power sweep with CW signal (no uncertainty required). DCP does not depend on frequency nor media.
- **PAR**: PAR is the Peak to Average Ratio that is not calibrated but determined based on the signal characteristics
- **A<sub>x,y,z</sub>; B<sub>x,y,z</sub>; C<sub>x,y,z</sub>; D<sub>x,y,z</sub>; VR<sub>x,y,z</sub>**: A, B, C, D are numerical linearization parameters assessed based on the data of power sweep for specific modulation signal. The parameters do not depend on frequency nor media. VR is the maximum calibration range expressed in RMS voltage across the diode.
- **ConvF and Boundary Effect Parameters**: Assessed in flat phantom using E-field (or Temperature Transfer Standard for  $f \leq 800$  MHz) and inside waveguide using analytical field distributions based on power measurements for  $f > 800$  MHz. The same setups are used for assessment of the parameters applied for boundary compensation (alpha, depth) of which typical uncertainty values are given. These parameters are used in DASY4 software to improve probe accuracy close to the boundary. The sensitivity in TSL corresponds to NORM<sub>x,y,z</sub> \* ConvF whereby the uncertainty corresponds to that given for ConvF. A frequency dependent ConvF is used in DASY version 4.4 and higher which allows extending the validity from  $\pm 50$  MHz to  $\pm 100$  MHz.
- **Spherical isotropy (3D deviation from isotropy)**: in a field of low gradients realized using a flat phantom exposed by a patch antenna.
- **Sensor Offset**: The sensor offset corresponds to the offset of virtual measurement center from the probe tip (on probe axis). No tolerance required.
- **Connector Angle**: The angle is assessed using the information gained by determining the NORM<sub>x</sub> (no uncertainty required).

ET3DV6 – SN:1798

August 25, 2014

# Probe ET3DV6

## SN:1798

Manufactured: August 14, 2003

Calibrated: August 25, 2014

Calibrated for DASY/EASY Systems

(Note: non-compatible with DASY2 system!)

ET3DV6- SN:1798

August 25, 2014

## DASY/EASY - Parameters of Probe: ET3DV6 - SN:1798

### Basic Calibration Parameters

	Sensor X	Sensor Y	Sensor Z	Unc (k=2)
Norm ( $\mu\text{V}/(\text{V}/\text{m})^2$ ) <sup>A</sup>	1.99	1.79	2.03	± 10.1 %
DCP (mV) <sup>B</sup>	101.2	99.6	100.0	

### Modulation Calibration Parameters

UID	Communication System Name		A dB	B dB $\sqrt{\mu\text{V}}$	C	D dB	VR mV	Unc <sup>C</sup> (k=2)
0	CW	X	0.0	0.0	1.0	0.00	239.0	±3.5 %
		Y	0.0	0.0	1.0		260.8	
		Z	0.0	0.0	1.0		239.9	

The reported uncertainty of measurement is stated as the standard uncertainty of measurement multiplied by the coverage factor k=2, which for a normal distribution corresponds to a coverage probability of approximately 95%.

<sup>A</sup> The uncertainties of NormX,Y,Z do not affect the E<sup>2</sup>-field uncertainty inside TSL (see Pages 5 and 6).

<sup>B</sup> Numerical linearization parameter: uncertainty not required.

<sup>C</sup> Uncertainty is determined using the max. deviation from linear response applying rectangular distribution and is expressed for the square of the field value.

ET3DV6- SN:1798

August 25, 2014

## DASY/EASY - Parameters of Probe: ET3DV6 - SN:1798

### Calibration Parameter Determined in Head Tissue Simulating Media

f (MHz) <sup>C</sup>	Relative Permittivity <sup>F</sup>	Conductivity (S/m) <sup>F</sup>	ConvF X	ConvF Y	ConvF Z	Alpha <sup>G</sup>	Depth <sup>G</sup> (mm)	Unct. (k=2)
150	52.3	0.76	8.64	8.64	8.64	0.15	1.40	± 16.0 %
300	45.3	0.87	8.26	8.26	8.26	0.20	2.20	± 13.4 %
450	43.5	0.87	7.61	7.61	7.61	0.26	2.76	± 13.4 %

<sup>C</sup> Frequency validity above 300 MHz of ± 100 MHz only applies for DASY v4.4 and higher (see Page 2), else it is restricted to ± 50 MHz. The uncertainty is the RSS of the ConvF uncertainty at calibration frequency and the uncertainty for the indicated frequency band. Frequency validity below 300 MHz is ± 10, 25, 40, 50 and 70 MHz for ConvF assessments at 30, 64, 128, 150 and 220 MHz respectively. Above 5 GHz frequency validity can be extended to ± 110 MHz.

<sup>F</sup> At frequencies below 3 GHz, the validity of tissue parameters ( $\epsilon$  and  $\sigma$ ) can be relaxed to ± 10% if liquid compensation formula is applied to measured SAR values. At frequencies above 3 GHz, the validity of tissue parameters ( $\epsilon$  and  $\sigma$ ) is restricted to ± 5%. The uncertainty is the RSS of the ConvF uncertainty for indicated target tissue parameters.

<sup>G</sup> Alpha/Depth are determined during calibration. SPEAG warrants that the remaining deviation due to the boundary effect after compensation is always less than ± 1% for frequencies below 3 GHz and below ± 2% for frequencies between 3-6 GHz at any distance larger than half the probe tip diameter from the boundary.



ET3DV6- SN:1798

August 25, 2014

## DASY/EASY - Parameters of Probe: ET3DV6 - SN:1798

### Calibration Parameter Determined in Body Tissue Simulating Media

f (MHz) <sup>C</sup>	Relative Permittivity <sup>F</sup>	Conductivity (S/m) <sup>F</sup>	ConvF X	ConvF Y	ConvF Z	Alpha <sup>G</sup>	Depth (mm) <sup>G</sup>	Unct. (k=2)
150	61.9	0.80	8.20	8.20	8.20	0.12	1.50	± 13.3 %
300	58.2	0.92	8.08	8.08	8.08	0.16	1.84	± 13.4 %
450	56.7	0.94	7.97	7.97	7.97	0.18	2.35	± 13.4 %

<sup>C</sup> Frequency validity above 300 MHz of ± 100 MHz only applies for DASY v4.4 and higher (see Page 2), else it is restricted to ± 50 MHz. The uncertainty is the RSS of the ConvF uncertainty at calibration frequency and the uncertainty for the indicated frequency band. Frequency validity below 300 MHz is ± 10, 25, 40, 50 and 70 MHz for ConvF assessments at 30, 64, 128, 150 and 220 MHz respectively. Above 5 GHz frequency validity can be extended to ± 110 MHz.

<sup>F</sup> At frequencies below 3 GHz, the validity of tissue parameters ( $\epsilon$  and  $\sigma$ ) can be relaxed to ± 10% if liquid compensation formula is applied to measured SAR values. At frequencies above 3 GHz, the validity of tissue parameters ( $\epsilon$  and  $\sigma$ ) is restricted to ± 5%. The uncertainty is the RSS of the ConvF uncertainty for indicated target tissue parameters.

<sup>G</sup> Alpha/Depth are determined during calibration. SPEAG warrants that the remaining deviation due to the boundary effect after compensation is always less than ± 1% for frequencies below 3 GHz and below ± 2% for frequencies between 3-6 GHz at any distance larger than half the probe tip diameter from the boundary.

ET3DV6-SN:1798

August 25, 2014

### Frequency Response of E-Field (TEM-Cell:ifi110 EXX, Waveguide: R22)

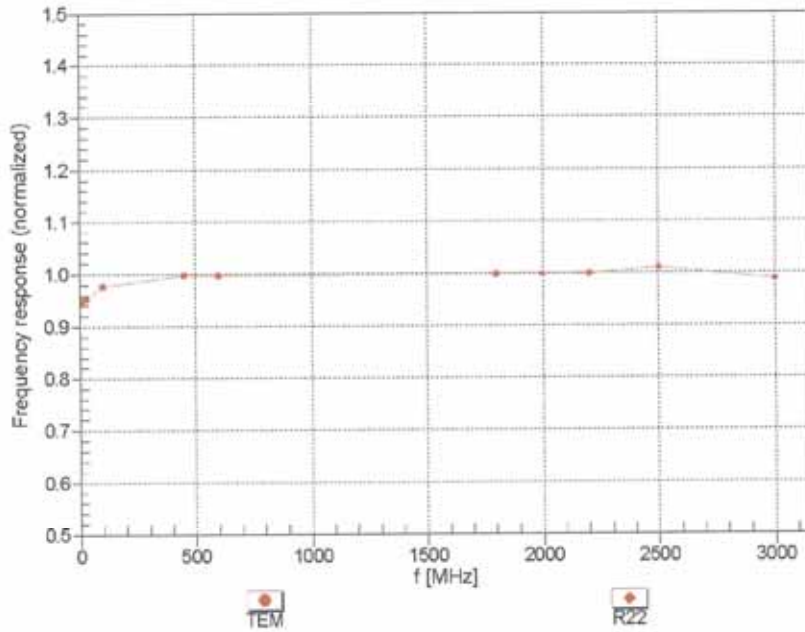

Uncertainty of Frequency Response of E-field:  $\pm 6.3\%$  (k=2)

ET3DV6-SN:1798

August 25, 2014

### Receiving Pattern ( $\phi$ ), $\theta = 0^\circ$

f=600 MHz, TEM

f=1800 MHz, R22

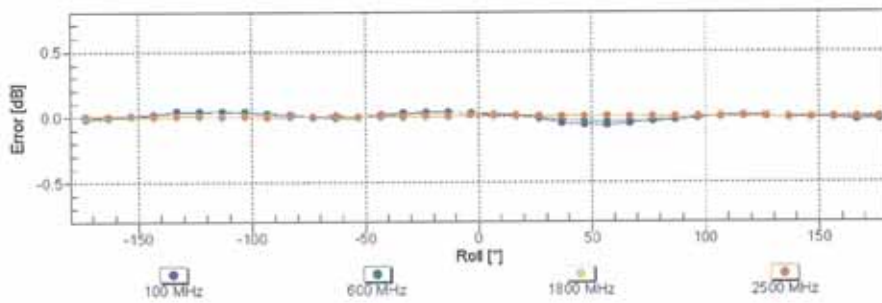
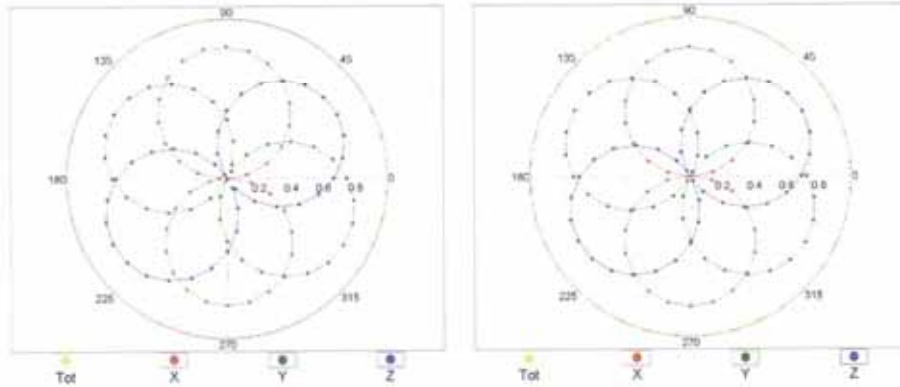

Uncertainty of Axial Isotropy Assessment:  $\pm 0.5\%$  (k=2)

ET3DV6- SN:1798

August 25, 2014

### Dynamic Range f(SAR<sub>head</sub>) (TEM cell , f<sub>eval</sub>= 1900 MHz)

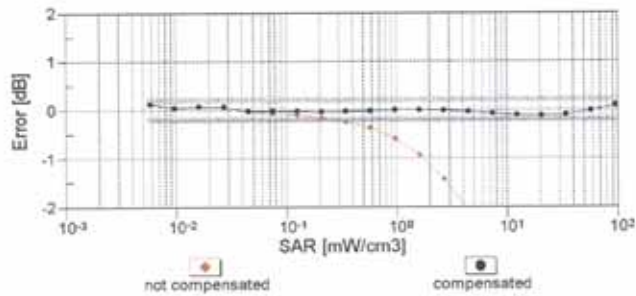
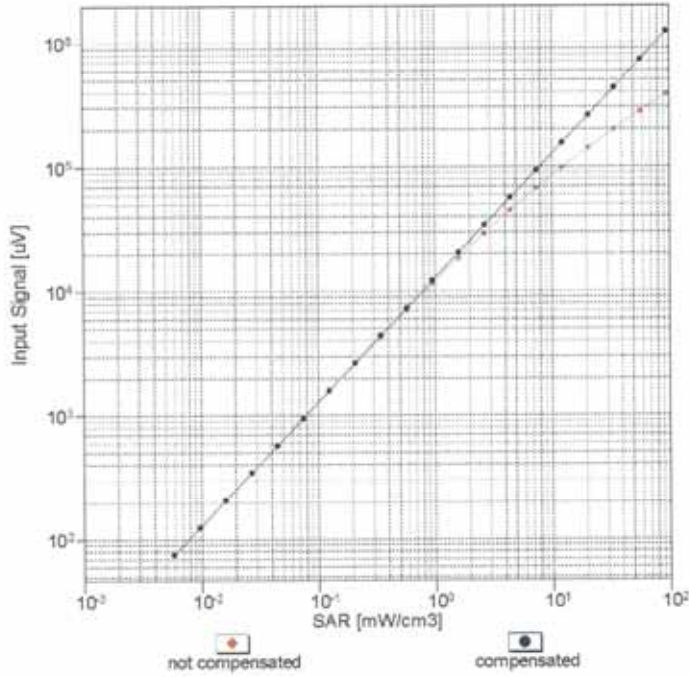

Uncertainty of Linearity Assessment: ± 0.6% (k=2)

ET3DV6- SN:1798

August 25, 2014

### Conversion Factor Assessment

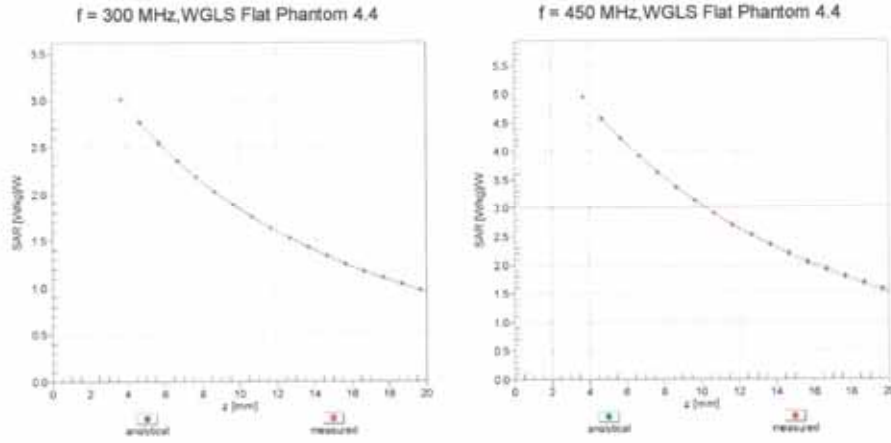

### Deviation from Isotropy in Liquid Error ( $\phi, \theta$ ), f = 900 MHz

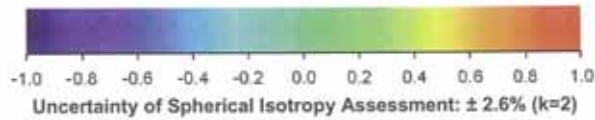
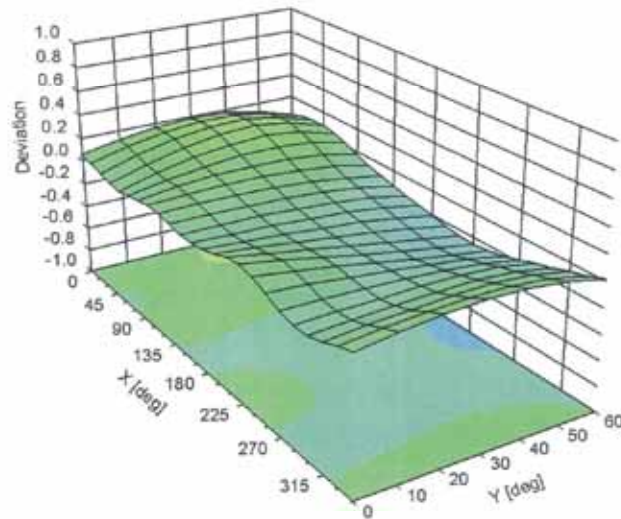

ET3DV6- SN:1798

August 25, 2014

**DASY/EASY - Parameters of Probe: ET3DV6 - SN:1798****Other Probe Parameters**

Sensor Arrangement	Triangular
Connector Angle (°)	-123.1
Mechanical Surface Detection Mode	enabled
Optical Surface Detection Mode	disabled
Probe Overall Length	337 mm
Probe Body Diameter	10 mm
Tip Length	10 mm
Tip Diameter	6.8 mm
Probe Tip to Sensor X Calibration Point	2.7 mm
Probe Tip to Sensor Y Calibration Point	2.7 mm
Probe Tip to Sensor Z Calibration Point	2.7 mm
Recommended Measurement Distance from Surface	4 mm

## Attachment 4. – Dipole Calibration Data

**Calibration Laboratory of  
Schmid & Partner  
Engineering AG**  
Zeughausstrasse 43, 8004 Zurich, Switzerland



**S** Schweizerischer Kalibrierdienst  
**S** Service suisse d'étalonnage  
**C** Servizio svizzero di taratura  
**S** Swiss Calibration Service

Accredited by the Swiss Accreditation Service (SAS)  
The Swiss Accreditation Service is one of the signatories to the EA  
Multilateral Agreement for the recognition of calibration certificates

Accreditation No.: **SCS 108**

Client **HCT (Dymstec)**

Certificate No: **D450V2-1007\_Aug14**

**CALIBRATION CERTIFICATE**

Object **D450V2 - SN:1007**

Calibration procedure(s) **QA CAL-15.v8  
Calibration procedure for dipole validation kits below 700 MHz**

Calibration date: **August 19, 2014**

This calibration certificate documents the traceability to national standards, which realize the physical units of measurements (SI).  
The measurements and the uncertainties with confidence probability are given on the following pages and are part of the certificate.

All calibrations have been conducted in the closed laboratory facility; environment temperature (22 ± 3)°C and humidity < 70%.

Calibration Equipment used (M&E critical for calibration)

Primary Standards	ID #	Cal Date (Certificate No.)	Scheduled Calibration
Power meter E4419B	GB41293874	03-Apr-14 (No. 217-01911)	Apr-15
Power sensor E4412A	MY41498087	03-Apr-14 (No. 217-01911)	Apr-15
Reference 3 dB Attenuator	SN: S5054 (3c)	03-Apr-14 (No. 217-01915)	Apr-15
Reference 20 dB Attenuator	SN: S5058 (20k)	03-Apr-14 (No. 217-01918)	Apr-15
Type-N mismatch combination	SN: 5047.2 / 08327	03-Apr-14 (No. 217-01921)	Apr-15
Reference Probe ET3DV8	SN: 1507	30-Dec-13 (No. ET3-1507_Dec13)	Dec-14
DAE4	SN: 654	30-Jun-14 (No. DAE4-654_Jun14)	Jun-15

Secondary Standards	ID #	Check Date (in house)	Scheduled Check
RF generator HP 8648C	US3642U01700	04-Aug-99 (in house check Apr-13)	In house check: Apr-16
Network Analyzer HP 8753E	US37390585 S4206	18-Oct-01 (in house check Oct-13)	In house check: Oct-14

Calibrated by:	Name <b>Jeton Kastrali</b>	Function Laboratory Technician	Signature 
Approved by:	Name <b>Katja Pokovic</b>	Technical Manager	

Issued: August 19, 2014

This calibration certificate shall not be reproduced except in full without written approval of the laboratory.



**Calibration Laboratory of  
Schmid & Partner  
Engineering AG**  
Zeughausstrasse 43, 8004 Zurich, Switzerland



**S** Schweizerischer Kalibrierdienst  
**C** Service suisse d'étalonnage  
**S** Servizio svizzero di taratura  
**S** Swiss Calibration Service

Accredited by the Swiss Accreditation Service (SAS)  
The Swiss Accreditation Service is one of the signatories to the EA  
Multilateral Agreement for the recognition of calibration certificates

Accreditation No.: **SCS 108**

**Glossary:**

TSL tissue simulating liquid  
ConvF sensitivity in TSL / NORM x,y,z  
N/A not applicable or not measured

**Calibration is Performed According to the Following Standards:**

- a) IEEE Std 1528-2013, "IEEE Recommended Practice for Determining the Peak Spatial-Averaged Specific Absorption Rate (SAR) in the Human Head from Wireless Communications Devices: Measurement Techniques", June 2013
- b) IEC 62209-1, "Procedure to measure the Specific Absorption Rate (SAR) for hand-held devices used in close proximity to the ear (frequency range of 300 MHz to 3 GHz)", February 2005
- c) KDB 865664, "SAR Measurement Requirements for 100 MHz to 6 GHz"

**Additional Documentation:**

- d) DASY4/5 System Handbook

**Methods Applied and Interpretation of Parameters:**

- *Measurement Conditions:* Further details are available from the Validation Report at the end of the certificate. All figures stated in the certificate are valid at the frequency indicated.
- *Antenna Parameters with TSL:* The dipole is mounted with the spacer to position its feed point exactly below the center marking of the flat phantom section, with the arms oriented parallel to the body axis.
- *Feed Point Impedance and Return Loss:* These parameters are measured with the dipole positioned under the liquid filled phantom. The impedance stated is transformed from the measurement at the SMA connector to the feed point. The Return Loss ensures low reflected power. No uncertainty required.
- *Electrical Delay:* One-way delay between the SMA connector and the antenna feed point. No uncertainty required.
- *SAR measured:* SAR measured at the stated antenna input power.
- *SAR normalized:* SAR as measured, normalized to an input power of 1 W at the antenna connector.
- *SAR for nominal TSL parameters:* The measured TSL parameters are used to calculate the nominal SAR result.

The reported uncertainty of measurement is stated as the standard uncertainty of measurement multiplied by the coverage factor k=2, which for a normal distribution corresponds to a coverage probability of approximately 95%.

**Measurement Conditions**

DASY system configuration, as far as not given on page 1.

DASY Version	DASY5	V52.8.8
Extrapolation	Advanced Extrapolation	
Phantom	Flat Phantom V4.4	Shell thickness: 6 ± 0.2 mm
Distance Dipole Center - TSL	15 mm	with Spacer
Zoom Scan Resolution	dx, dy, dz = 5 mm	
Frequency	450 MHz ± 1 MHz	

**Head TSL parameters**

The following parameters and calculations were applied.

	Temperature	Permittivity	Conductivity
Nominal Head TSL parameters	22.0 °C	43.5	0.87 mho/m
Measured Head TSL parameters	(22.0 ± 0.2) °C	44.4 ± 6 %	0.89 mho/m ± 6 %
Head TSL temperature change during test	< 0.5 °C	----	----

**SAR result with Head TSL**

SAR averaged over 1 cm <sup>3</sup> (1 g) of Head TSL	Condition	
SAR measured	250 mW input power	1.24 W/kg
SAR for nominal Head TSL parameters	normalized to 1W	<b>4.89 W/kg ± 18.1 % (k=2)</b>

SAR averaged over 10 cm <sup>3</sup> (10 g) of Head TSL	condition	
SAR measured	250 mW input power	0.820 W/kg
SAR for nominal Head TSL parameters	normalized to 1W	<b>3.24 W/kg ± 17.6 % (k=2)</b>

**Body TSL parameters**

The following parameters and calculations were applied.

	Temperature	Permittivity	Conductivity
Nominal Body TSL parameters	22.0 °C	56.7	0.94 mho/m
Measured Body TSL parameters	(22.0 ± 0.2) °C	56.8 ± 6 %	0.96 mho/m ± 6 %
Body TSL temperature change during test	< 0.5 °C	----	----

**SAR result with Body TSL**

SAR averaged over 1 cm <sup>3</sup> (1 g) of Body TSL	Condition	
SAR measured	250 mW input power	1.23 W/kg
SAR for nominal Body TSL parameters	normalized to 1W	<b>4.84 W/kg ± 18.1 % (k=2)</b>

SAR averaged over 10 cm <sup>3</sup> (10 g) of Body TSL	condition	
SAR measured	250 mW input power	0.812 W/kg
SAR for nominal Body TSL parameters	normalized to 1W	<b>3.20 W/kg ± 17.6 % (k=2)</b>

**Appendix (Additional assessments outside the scope of SCS108)**

**Antenna Parameters with Head TSL**

Impedance, transformed to feed point	52.8 $\Omega$ - 8.7 $j\Omega$
Return Loss	- 21.1 dB

**Antenna Parameters with Body TSL**

Impedance, transformed to feed point	51.4 $\Omega$ - 9.3 $j\Omega$
Return Loss	- 20.7 dB

**General Antenna Parameters and Design**

Electrical Delay (one direction)	1.356 ns
----------------------------------	----------

After long term use with 100W radiated power, only a slight warming of the dipole near the feedpoint can be measured.

The dipole is made of standard semirigid coaxial cable. The center conductor of the feeding line is directly connected to the second arm of the dipole. The antenna is therefore short-circuited for DC-signals. On some of the dipoles, small end caps are added to the dipole arms in order to improve matching when loaded according to the position as explained in the "Measurement Conditions" paragraph. The SAR data are not affected by this change. The overall dipole length is still according to the Standard.

No excessive force must be applied to the dipole arms, because they might bend or the soldered connections near the feedpoint may be damaged.

**Additional EUT Data**

Manufactured by	SPEAG
Manufactured on	July 01, 2002

**DASY5 Validation Report for Head TSL**

Date: 19.08.2014

Test Laboratory: SPEAG, Zurich, Switzerland

**DUT: Dipole 450 MHz; Type: D450V2; Serial: D450V2 - SN:1007**

Communication System: UID 0 - CW; Frequency: 450 MHz  
 Medium parameters used:  $f = 450 \text{ MHz}$ ;  $\sigma = 0.89 \text{ S/m}$ ;  $\epsilon_r = 44.4$ ;  $\rho = 1000 \text{ kg/m}^3$   
 Phantom section: Flat Section  
 Measurement Standard: DASY5 (IEEE/IEC/ANSI C63.19-2011)

**DASY52 Configuration:**

- Probe: ET3DV6 - SN1507; ConvF(6.65, 6.65, 6.65); Calibrated: 30.12.2013;
- Sensor-Surface: 4mm (Mechanical Surface Detection)
- Electronics: DAE4 Sn654; Calibrated: 30.06.2014
- Phantom: Flat Phantom 4.4 ; Type: Flat Phantom 4.4; Serial: 1002
- DASY52 52.8.8(1222); SEMCAD X 14.6.10(7331)

**Dipole Calibration for Head Tissue/d=15mm, Pin=250mW/Zoom Scan (7x7x7)/Cube 0:**

Measurement grid:  $dx=5\text{mm}$ ,  $dy=5\text{mm}$ ,  $dz=5\text{mm}$   
 Reference Value = 39.92 V/m; Power Drift = -0.01 dB  
 Peak SAR (extrapolated) = 1.85 W/kg  
**SAR(1 g) = 1.24 W/kg; SAR(10 g) = 0.820 W/kg**  
 Maximum value of SAR (measured) = 1.33 W/kg

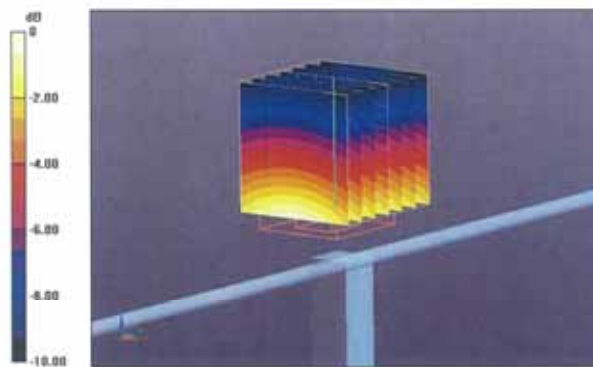

Impedance Measurement Plot for Head TSL

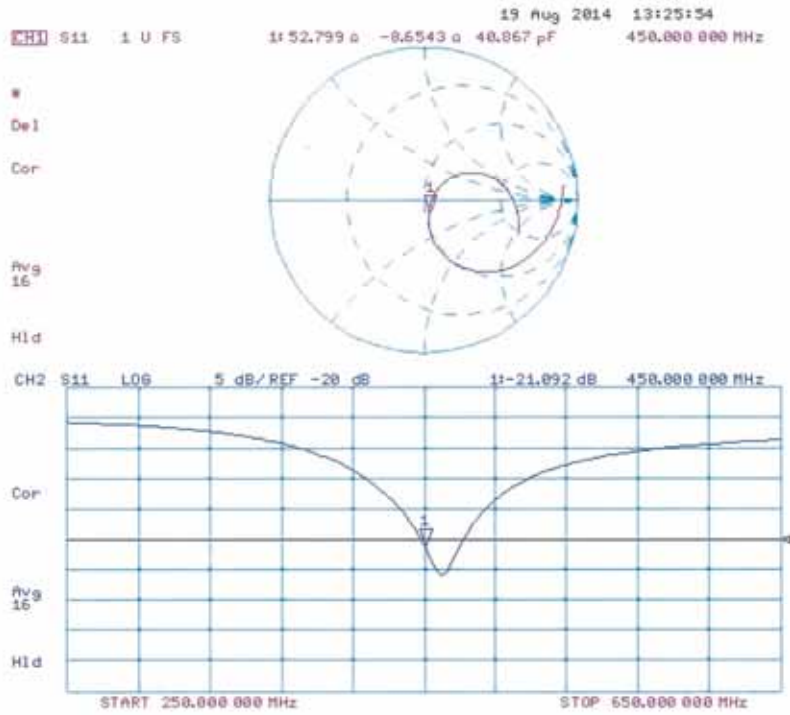

**DASY5 Validation Report for Body TSL**

Date: 19.08.2014

Test Laboratory: SPEAG, Zurich, Switzerland

**DUT: Dipole 450 MHz; Type: D450V2; Serial: D450V2 - SN:1007**

Communication System: UID 0 - CW; Frequency: 450 MHz  
 Medium parameters used:  $f = 450 \text{ MHz}$ ;  $\sigma = 0.96 \text{ S/m}$ ;  $\epsilon_r = 56.8$ ;  $\rho = 1000 \text{ kg/m}^3$   
 Phantom section: Flat Section  
 Measurement Standard: DASY5 (IEEE/IEC/ANSI C63.19-2011)

DASY52 Configuration:

- Probe: ET3DV6 - SN1507; ConvF(7.1, 7.1, 7.1); Calibrated: 30.12.2013;
- Sensor-Surface: 4mm (Mechanical Surface Detection)
- Electronics: DAE4 Sn654; Calibrated: 30.06.2014
- Phantom: Flat Phantom 4.4 ; Type: Flat Phantom 4.4; Serial: 1002
- DASY52 52.8.8(1222); SEMCAD X 14.6.10(7331)

**Dipole Calibration for Body Tissue/d=15mm, Pin=250mW/Zoom Scan (7x7x7)/Cube 0:**

Measurement grid:  $dx=5\text{mm}$ ,  $dy=5\text{mm}$ ,  $dz=5\text{mm}$   
 Reference Value = 37.42 V/m; Power Drift = -0.01 dB  
 Peak SAR (extrapolated) = 1.92 W/kg  
**SAR(1 g) = 1.23 W/kg; SAR(10 g) = 0.812 W/kg**  
 Maximum value of SAR (measured) = 1.31 W/kg

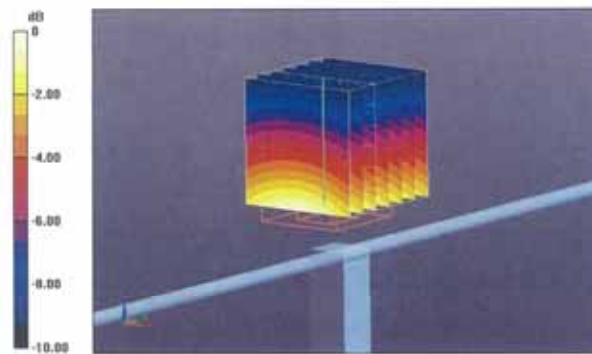

0 dB = 1.31 W/kg = 1.17 dBW/kg

Impedance Measurement Plot for Body TSL

