

16K0F3E_450.05 MHz_HIGH POWER

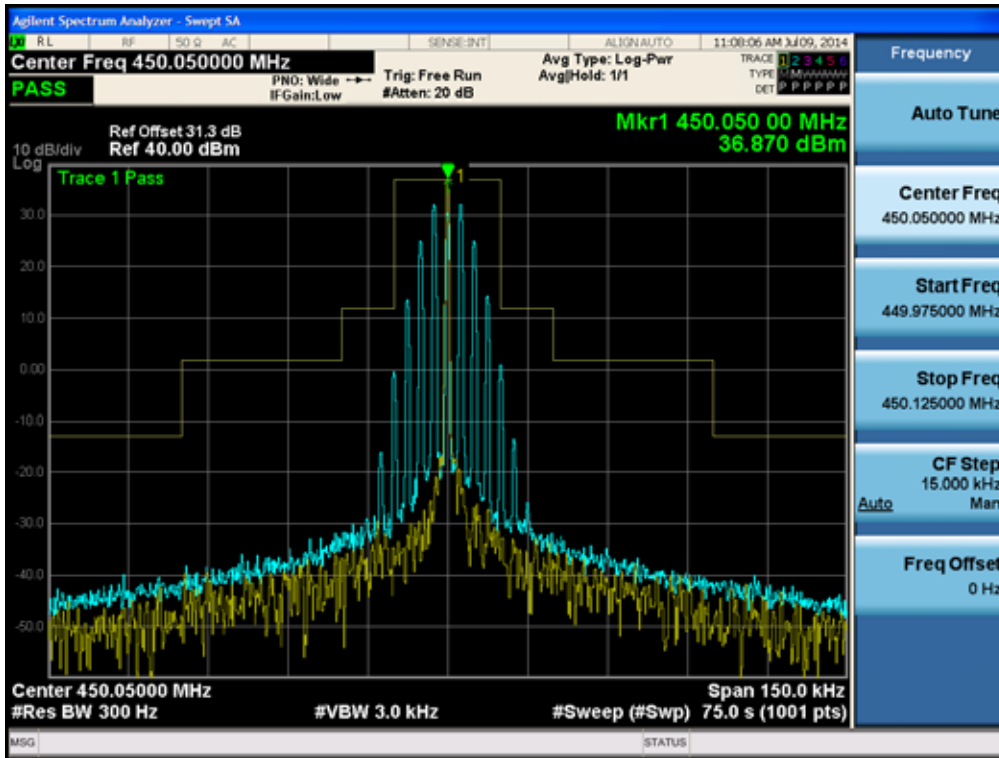

16K0F3E_460.05 MHz_HIGH POWER

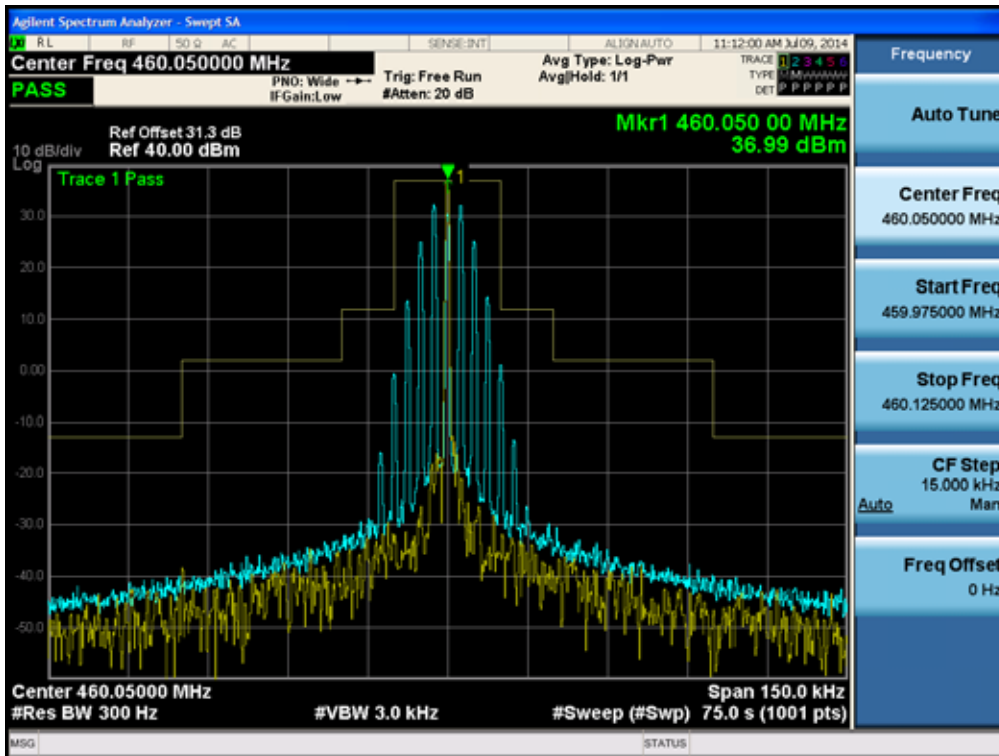

16K0F3E_406.15 MHz_LOW POWER

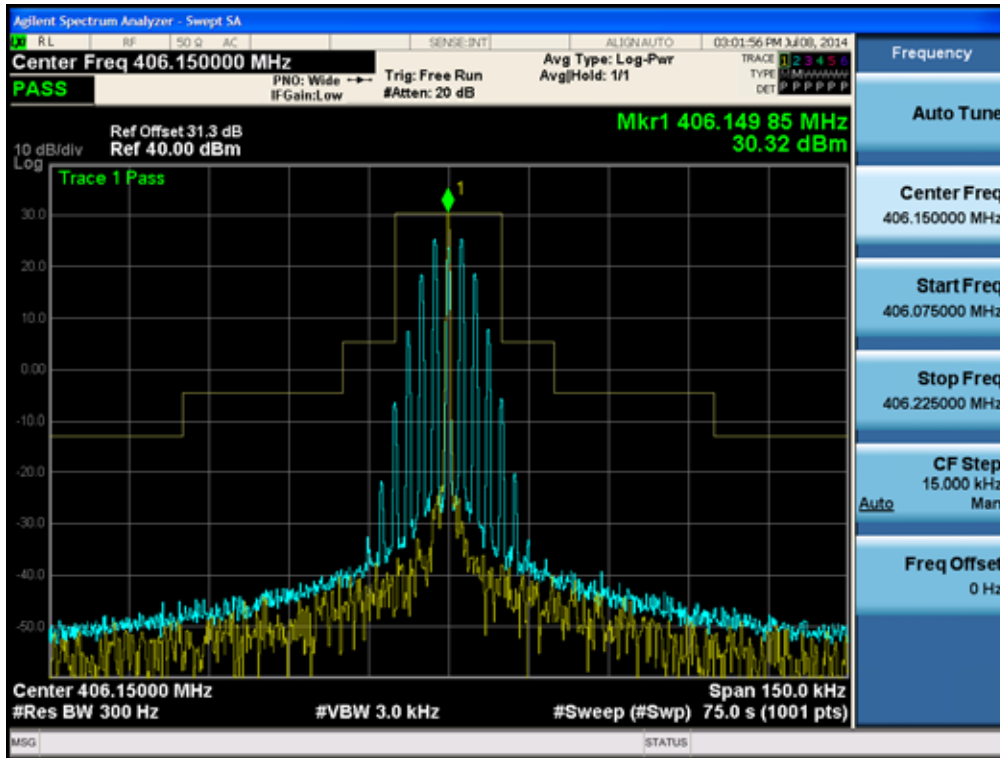

16K0F3E_418.05 MHz_LOW POWER

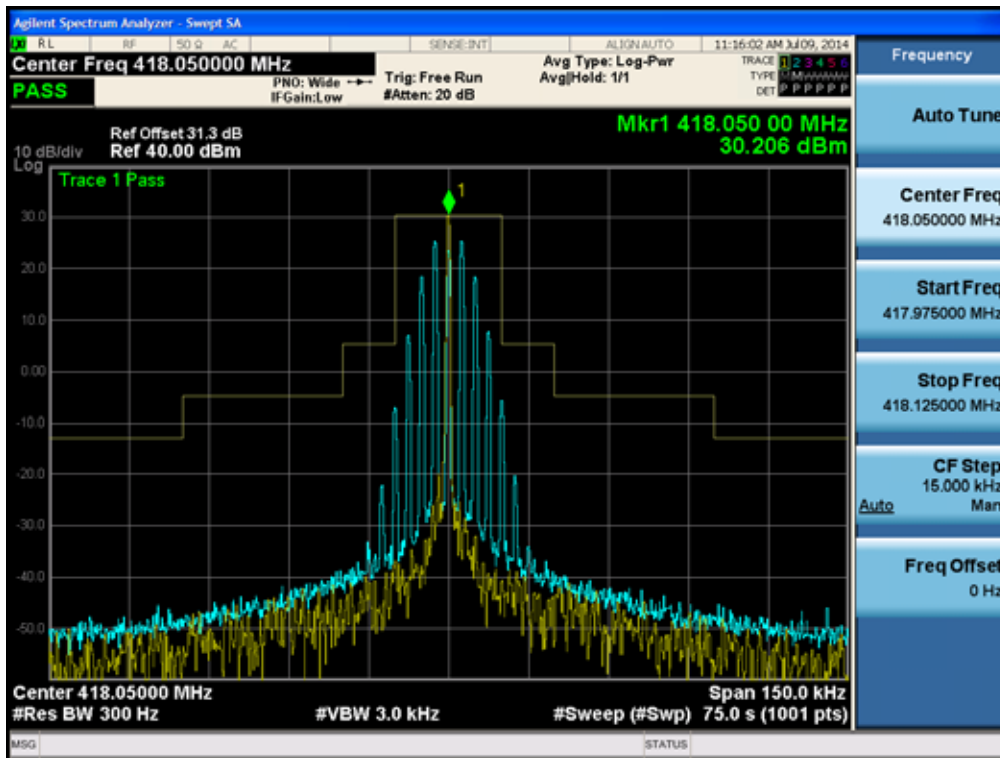

16K0F3E_450.05 MHz_LOW POWER

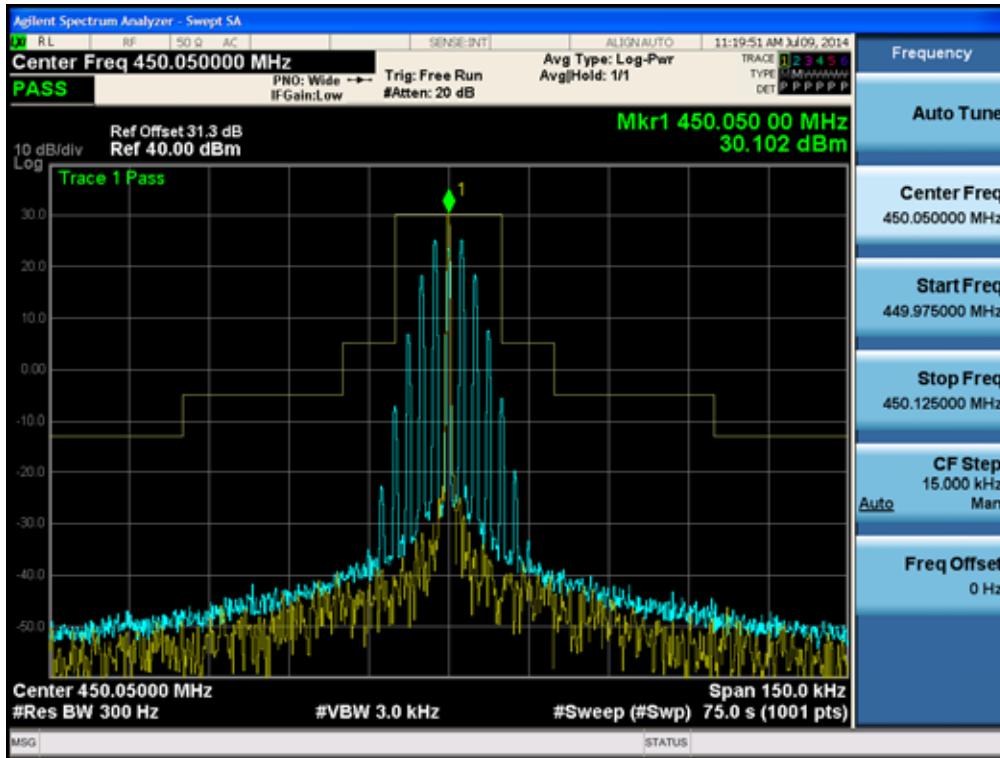

16K0F3E_460.05 MHz_LOW POWER

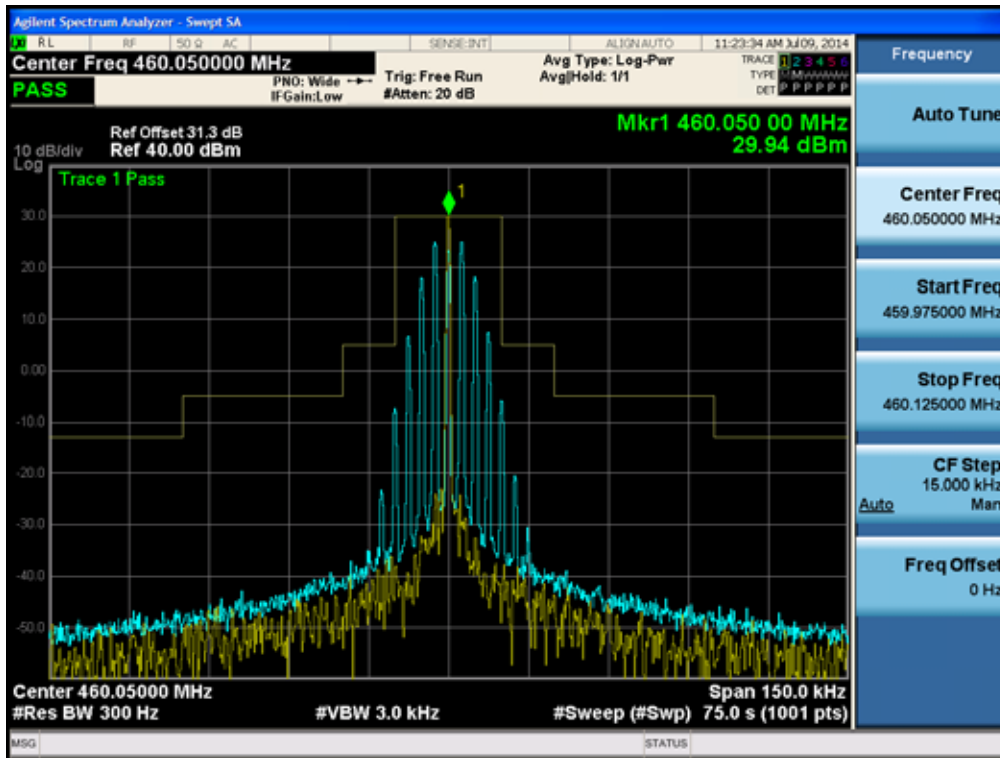

16K0F3E_429.95 MHz_HIGH POWER

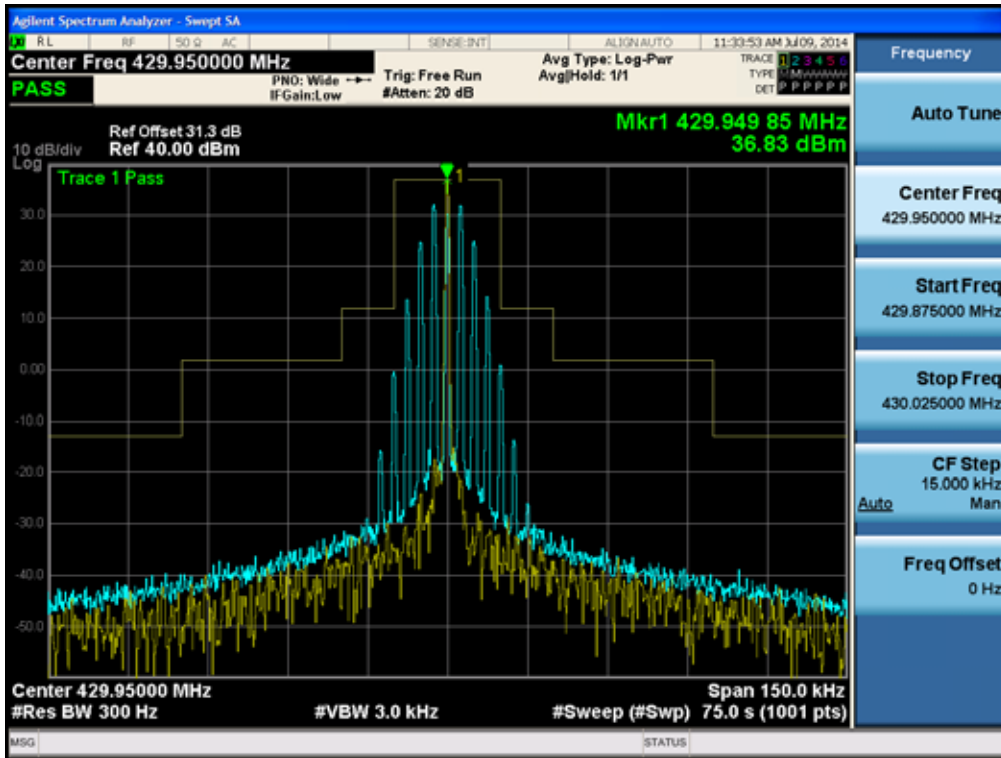

16K0F3E_469.95 MHz_HIGH POWER

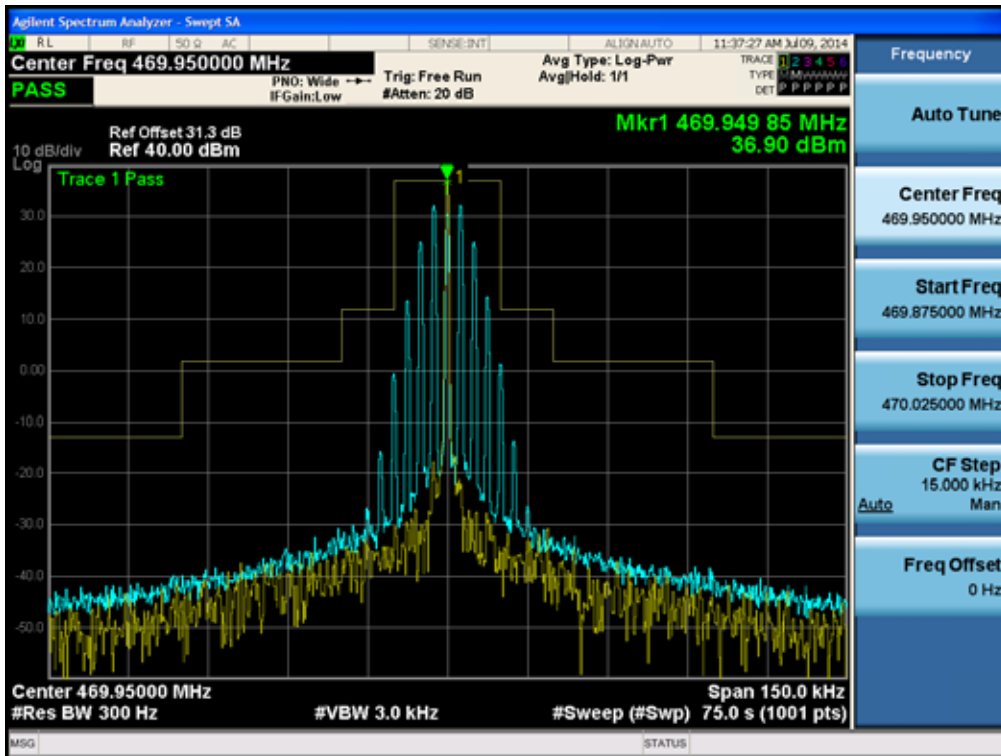

16K0F3E_429.95 MHz_LOW POWER

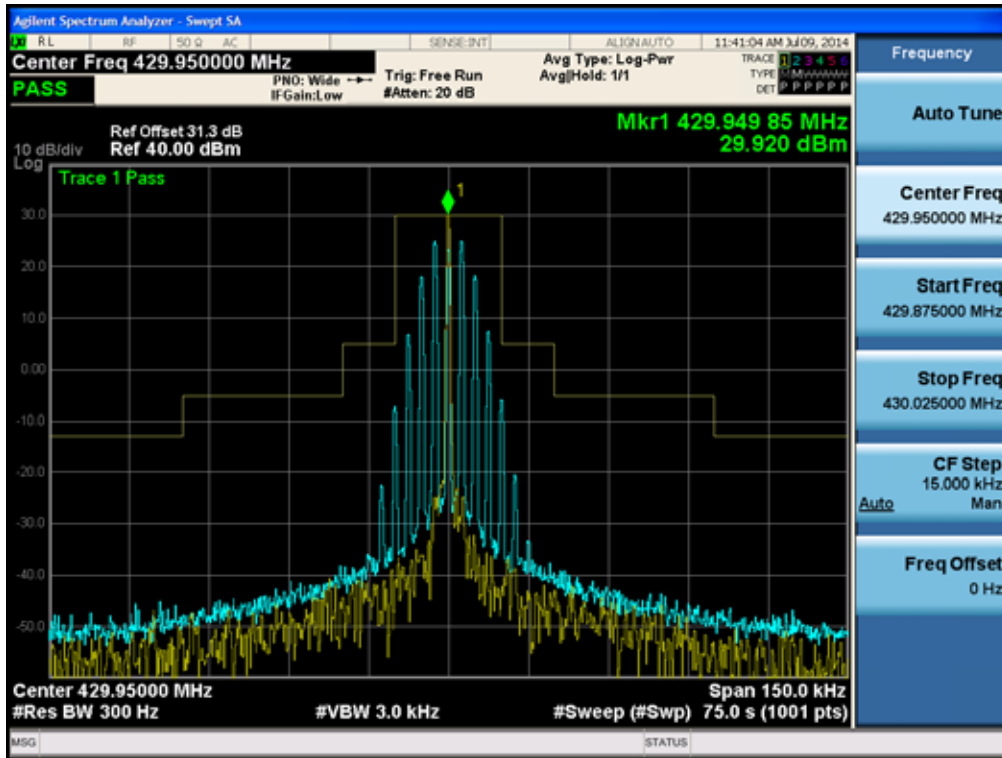

16K0F3E_469.95 MHz_LOW POWER

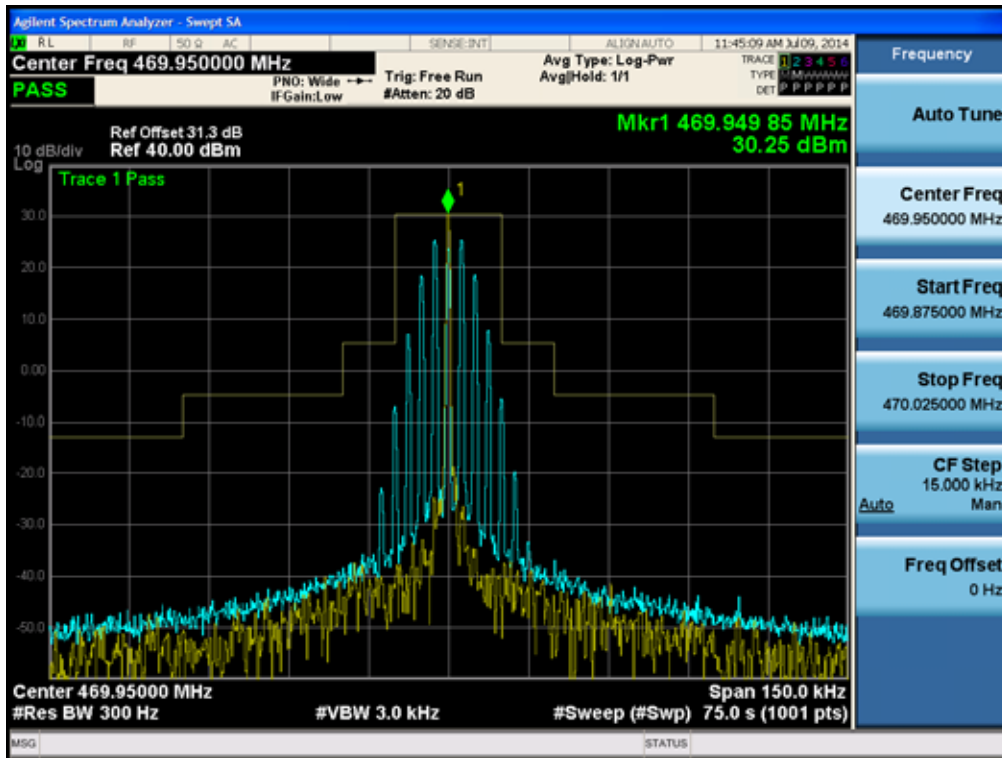

7.7 Transient Frequency Behavior

Definition

Transient frequency behavior is a measure of the difference, as a function in time, of the actual transmitter frequency to the assigned transmitter frequency when the transmitted RF output power is switched on or off.

TEST CONFIGURATION

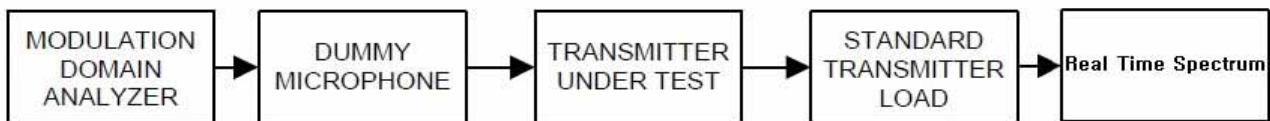

TEST PROCEDURE

According to 2.2.19 in TIA-603-D Standard.

- a) Connect the equipment as illustrated.
- b) Connect the output of the standard transmitter load to the RF power meter.
Supply sufficient attenuation via the RF attenuator to provide a level that is approximately 40 dB below the maximum allowable input to the modulation domain analyzer.
- c) Unkey the transmitter.
- d) Disconnect the RF power meter and connect the modulation domain analyzer in its place.
Set the envelope trigger of the modulation domain analyzer to the minimum level that will trigger when the transmitter is keyed.
- e) Reduce the attenuation of the RF attenuator so that the input to the modulation domain analyzer is increased by 30 dB when the transmitter is keyed.
- f) Set the modulation domain analyzer to trigger on the rising edge of the waveform in order to capture a single-shot turn-on of the transmitter signal.
- g) Adjust the display of the modulation domain analyzer for proper viewing of the transmitter transient behavior. Set the timebase reference to the left for observing the transmitter turn-on transient.
- h) Key the transmitter.
- i) Observe the stored display of the modulation domain analyzer.
The signal trace shall be maintained within the allowable limits during the periods t_1 and t_2 , and shall also remain within limits following t_2 .

- j) Adjust the modulation domain analyzer to trigger on the falling edge of the transmitter waveform in order to capture a single-shot turn-off transient of the transmitter signal.
- k) Adjust the display of the modulation domain analyzer for proper viewing of the transmitter transient behavior. Set the timebase reference to the right for observing the transmitter turn-off transient.
- l) Unkey the transmitter.
- m) Observe the stored display of the modulation domain analyzer. The signal trace shall be maintained within the allowable limits during the period t_3 .

*Note : Digital test is no provision to configure the device with un-modulated carrier, hence test was performed with digital modulation on.

TEST RESULTS

4K00F1E,4K00F1D,4K00F7W for FCC

4K00F1E,4K00F1D,4K00F7W_406.15 MHz_HIGH POWER

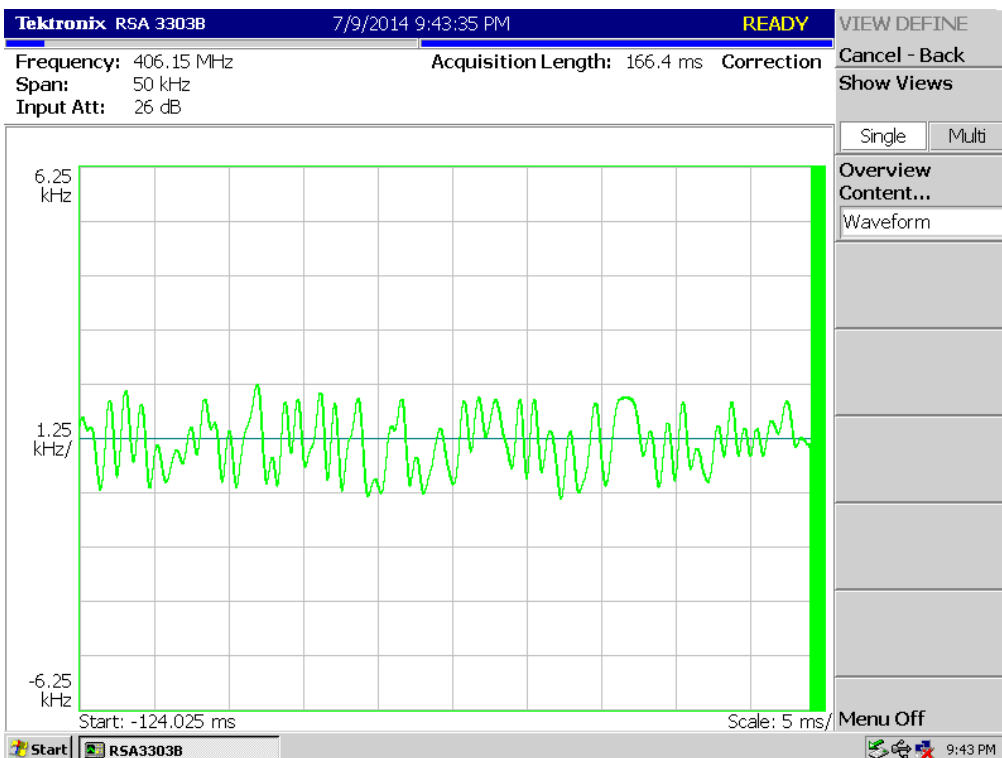

4K00F1E,4K00F1D,4K00F7W_429.95 MHz_HIGH POWER

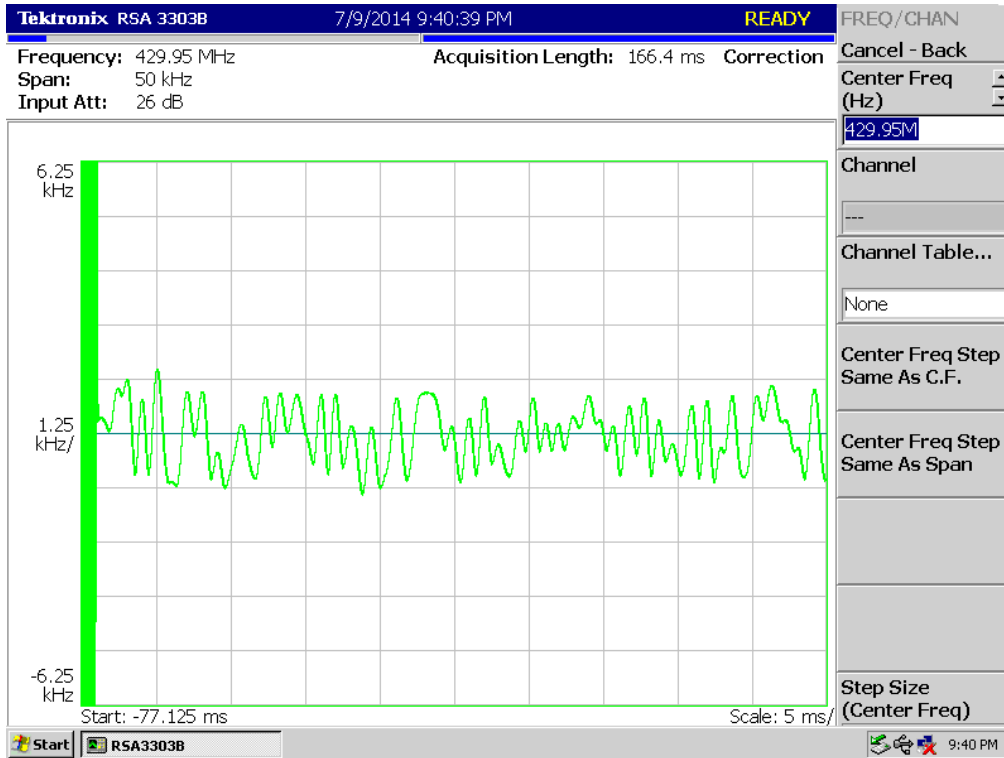

4K00F1E,4K00F1D,4K00F7W_469.95 MHz_HIGH POWER

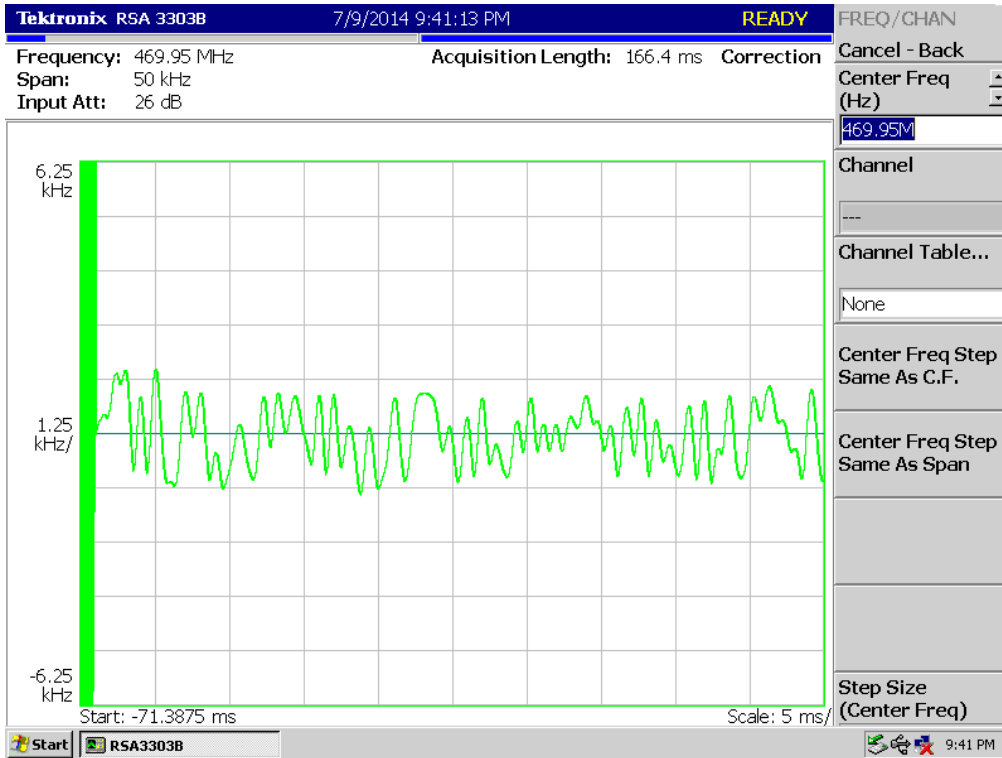

4K00F1E,4K00F1D,4K00F7W _406.15 MHz_LOW POWER

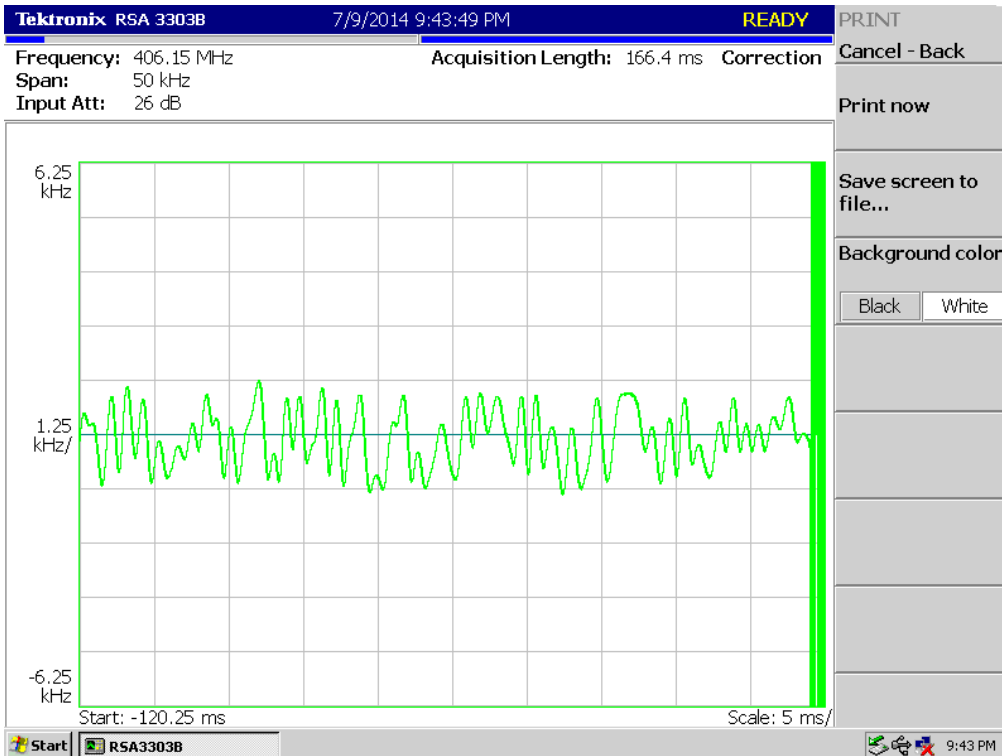
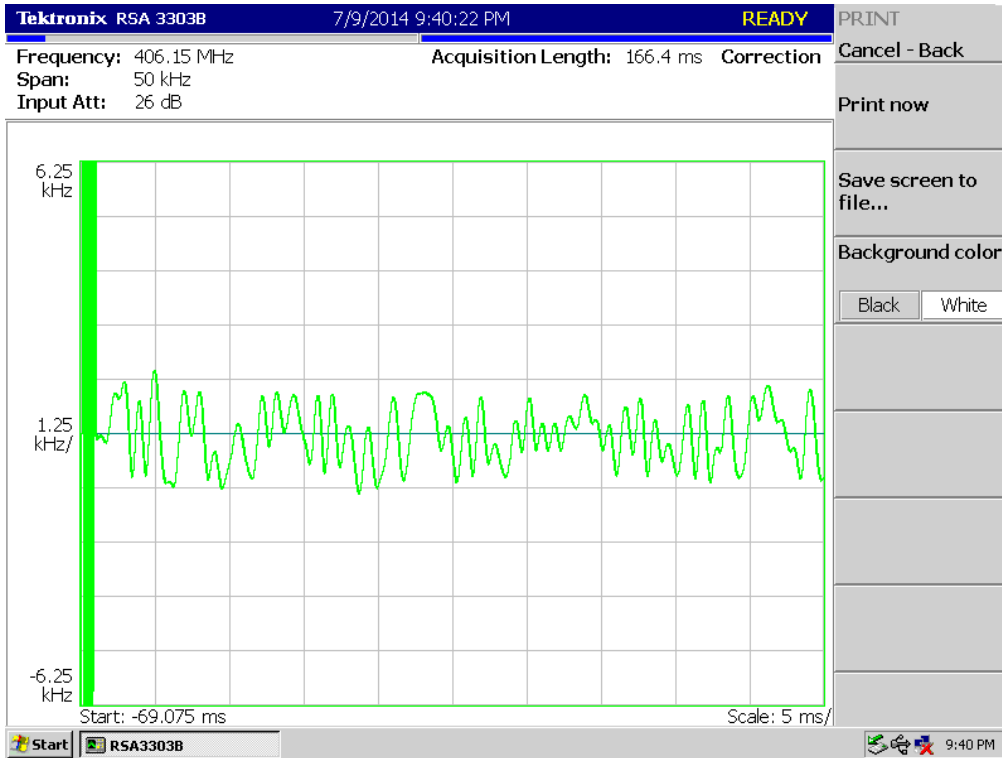

4K00F1E,4K00F1D,4K00F7W _429.95 MHz_LOW POWER

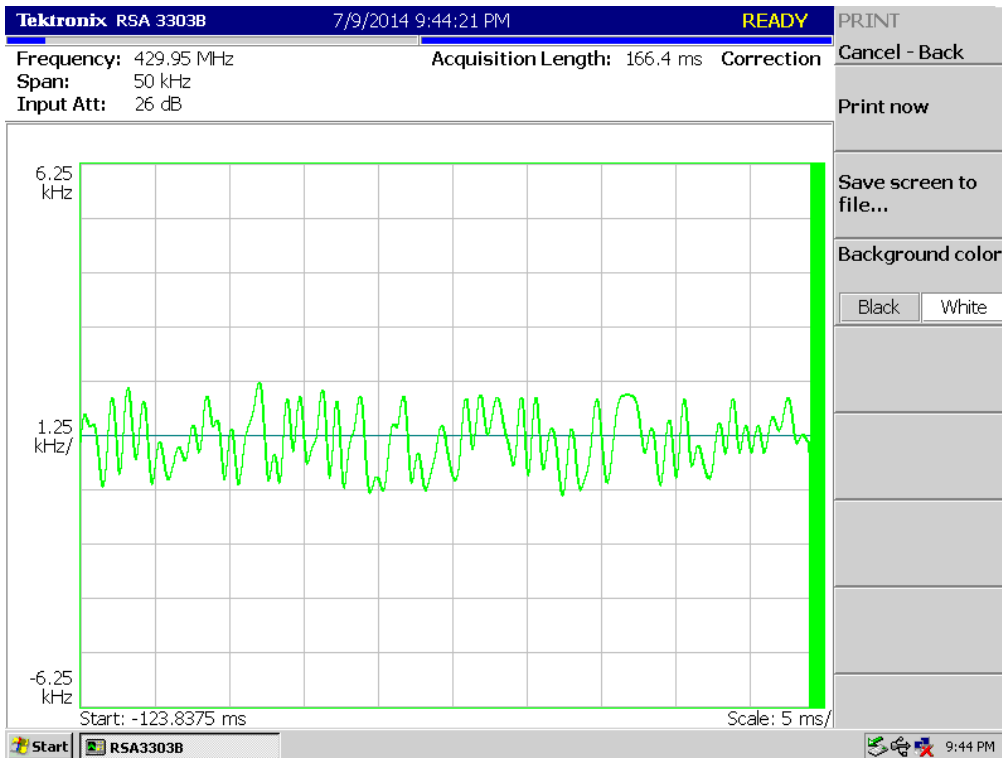
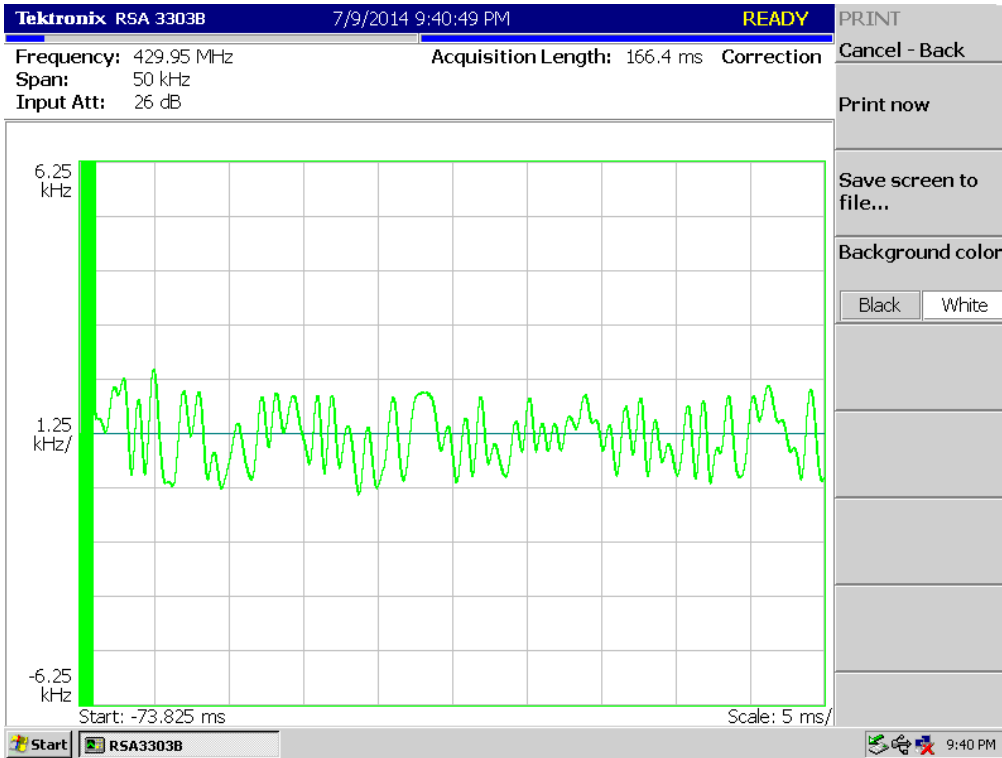

4K00F1E,4K00F1D,4K00F7W _469.95 MHz_LOW POWER

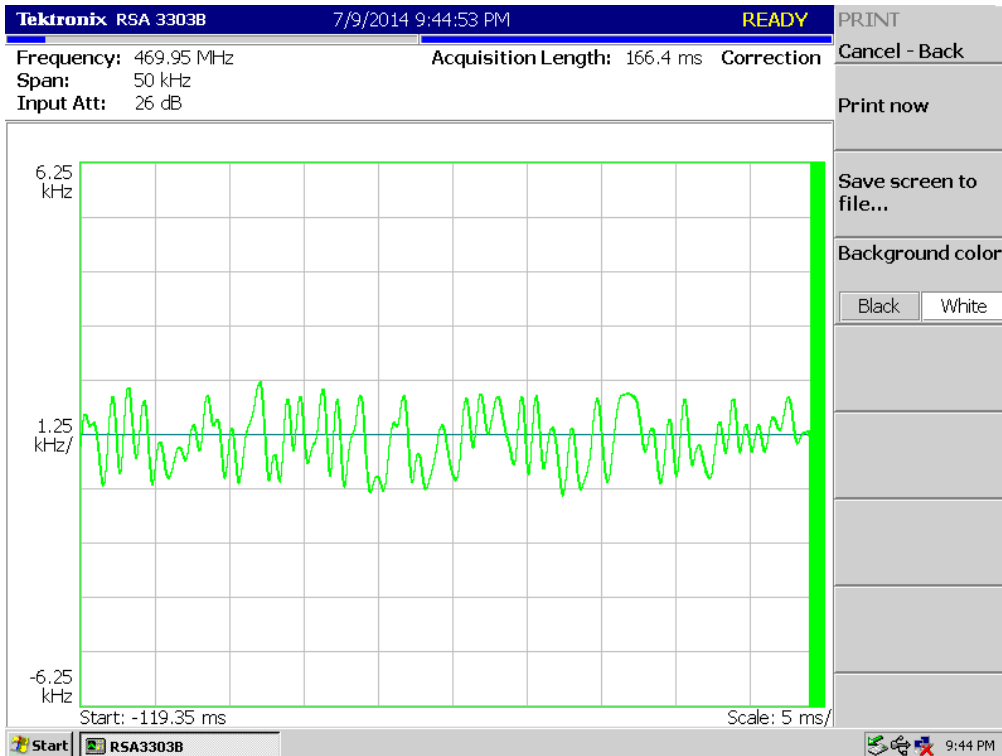
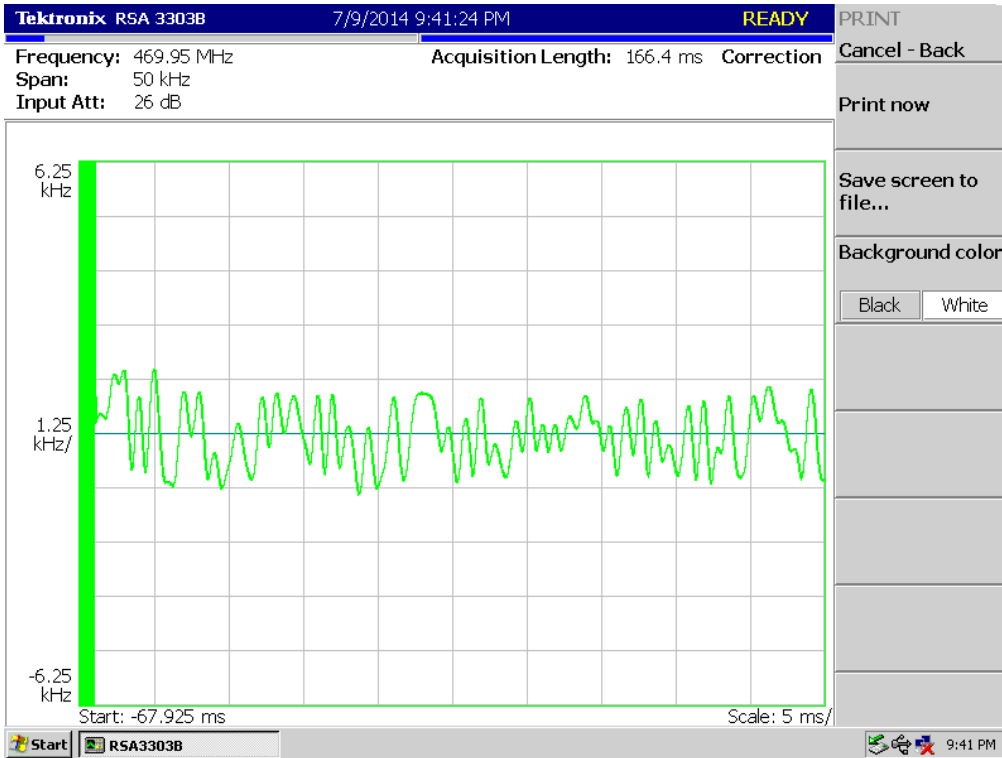

TEST RESULTS

4K00F1E,4K00F1D,4K00F7W for IC

4K00F1E,4K00F1D,4K00F7W_418.05 MHz_HIGH POWER

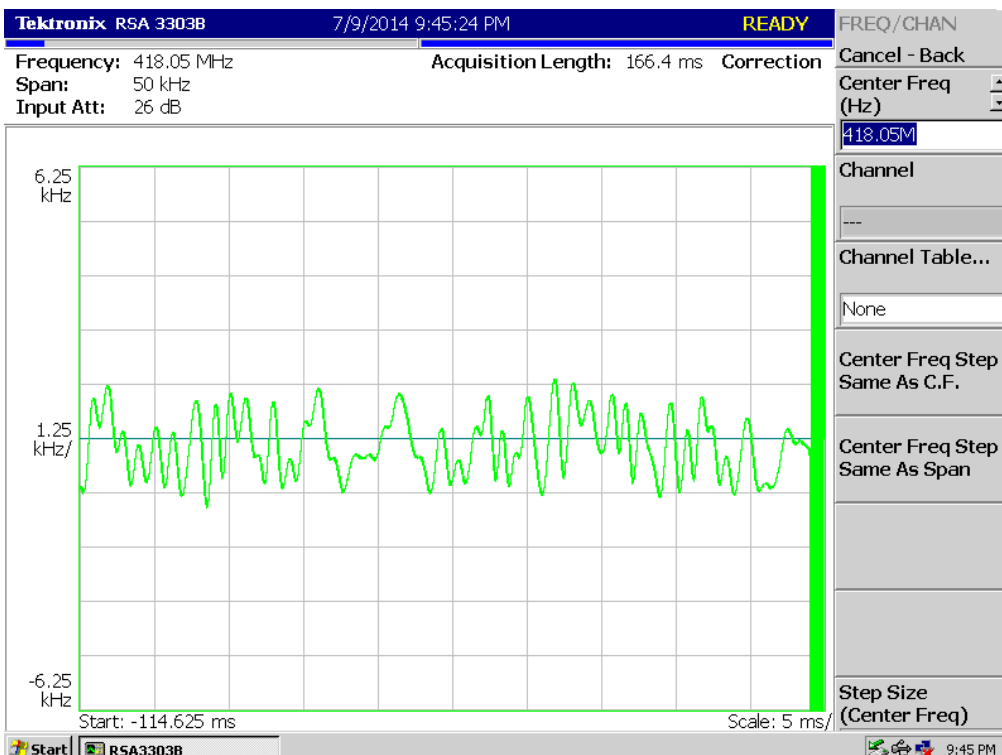
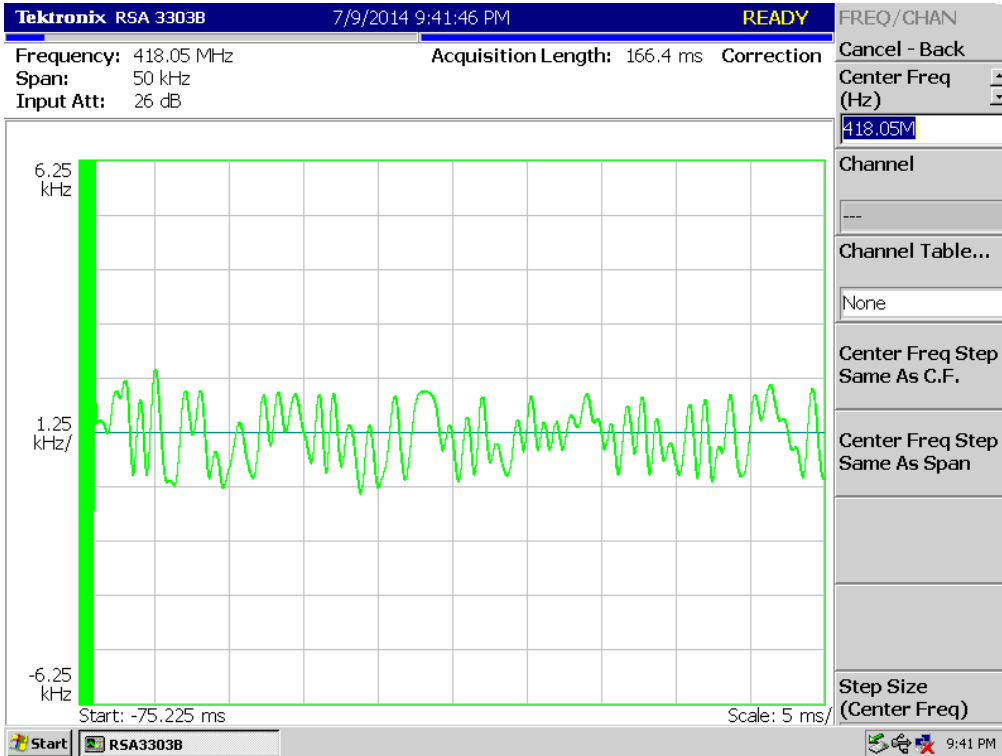

4K00F1E,4K00F1D,4K00F7W_450.05 MHz_HIGH POWER

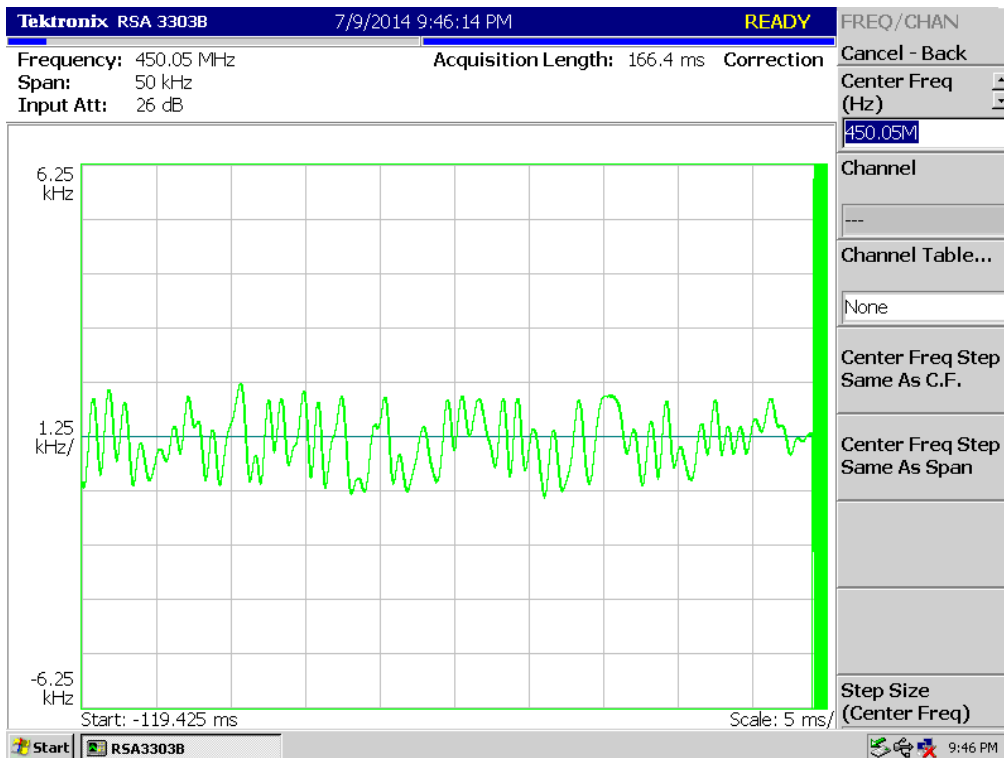
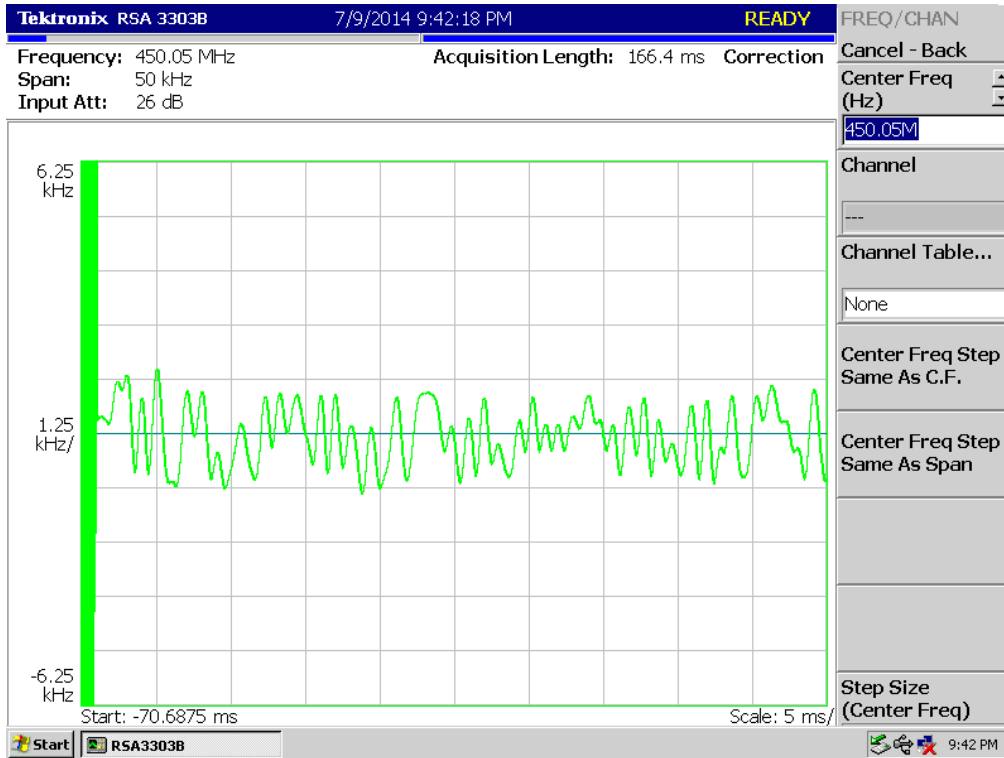

4K00F1E,4K00F1D,4K00F7W_460.05 MHz_HIGH POWER

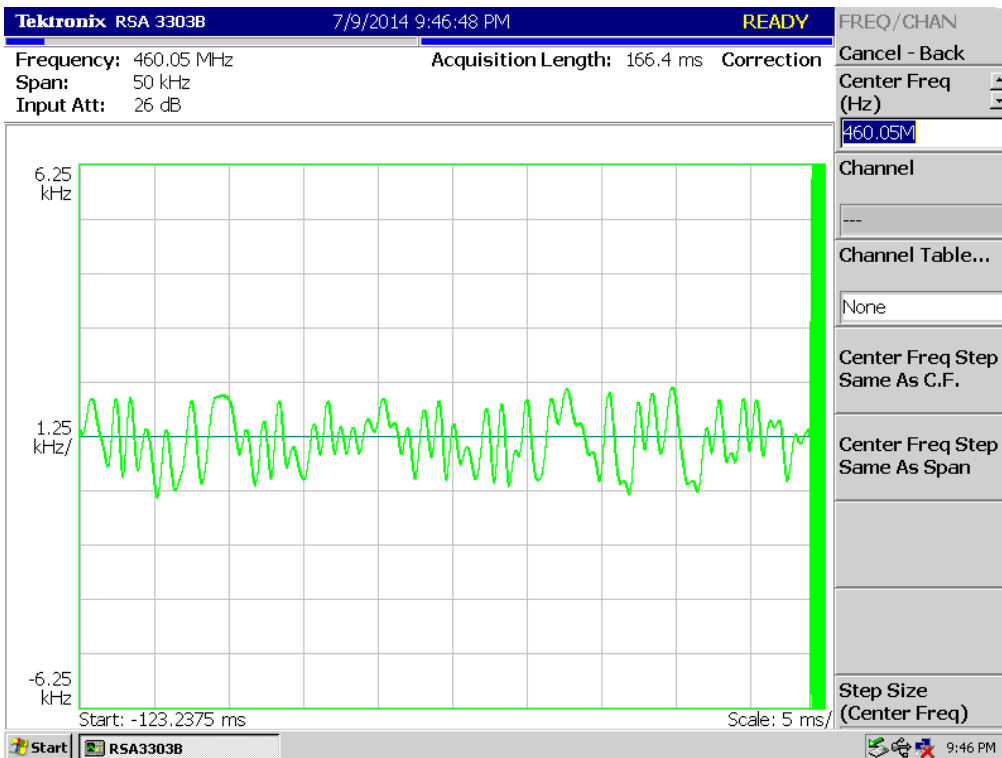
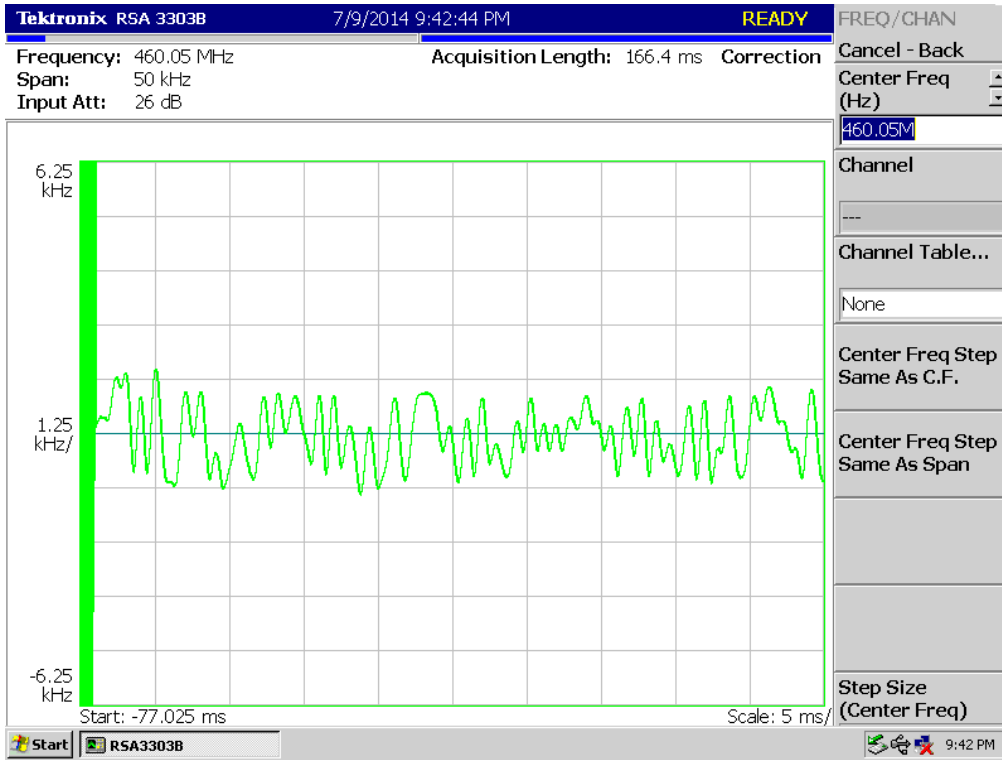

4K00F1E,4K00F1D,4K00F7W _418.05 MHz_LOW POWER

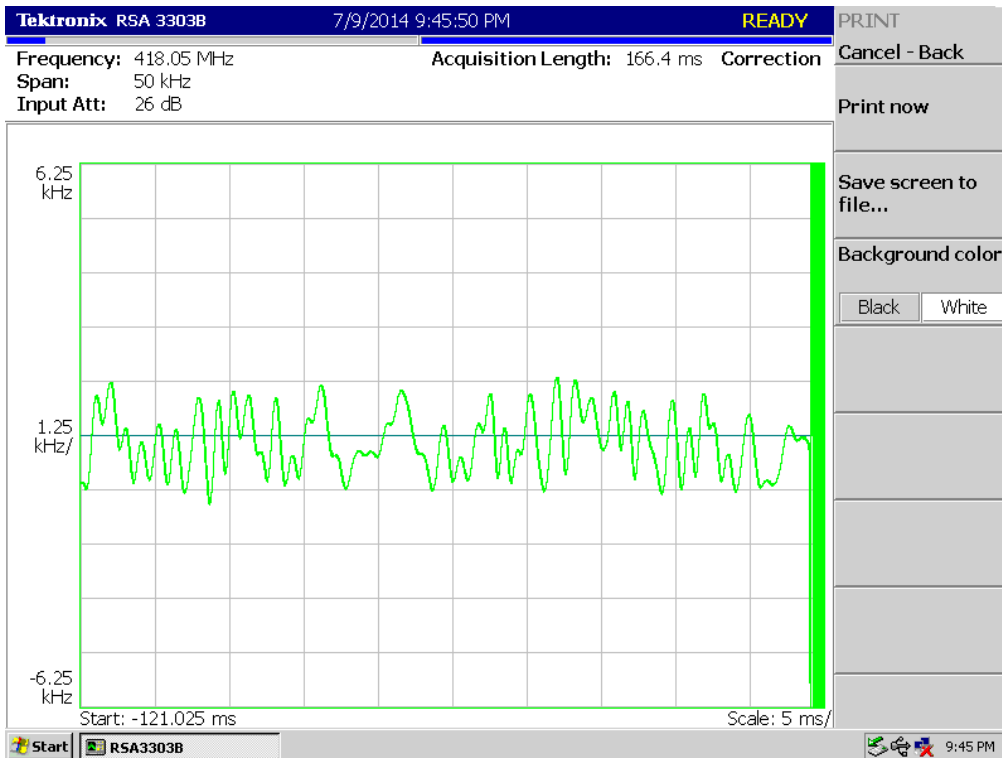
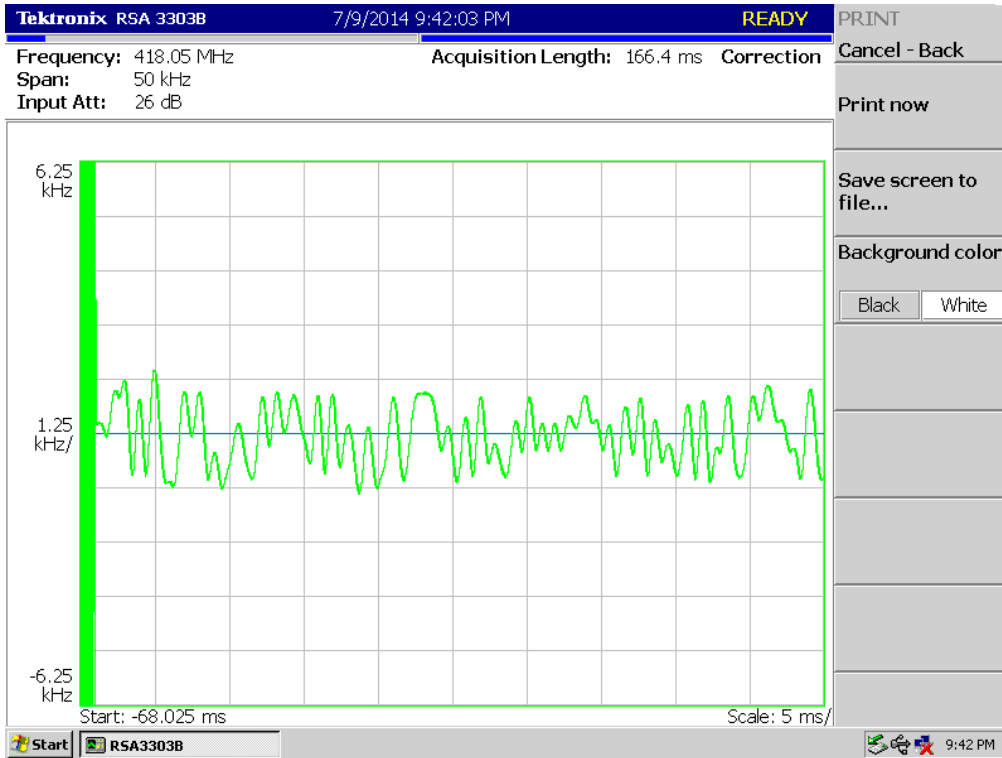

4K00F1E,4K00F1D,4K00F7W _450.05 MHz_LOW POWER

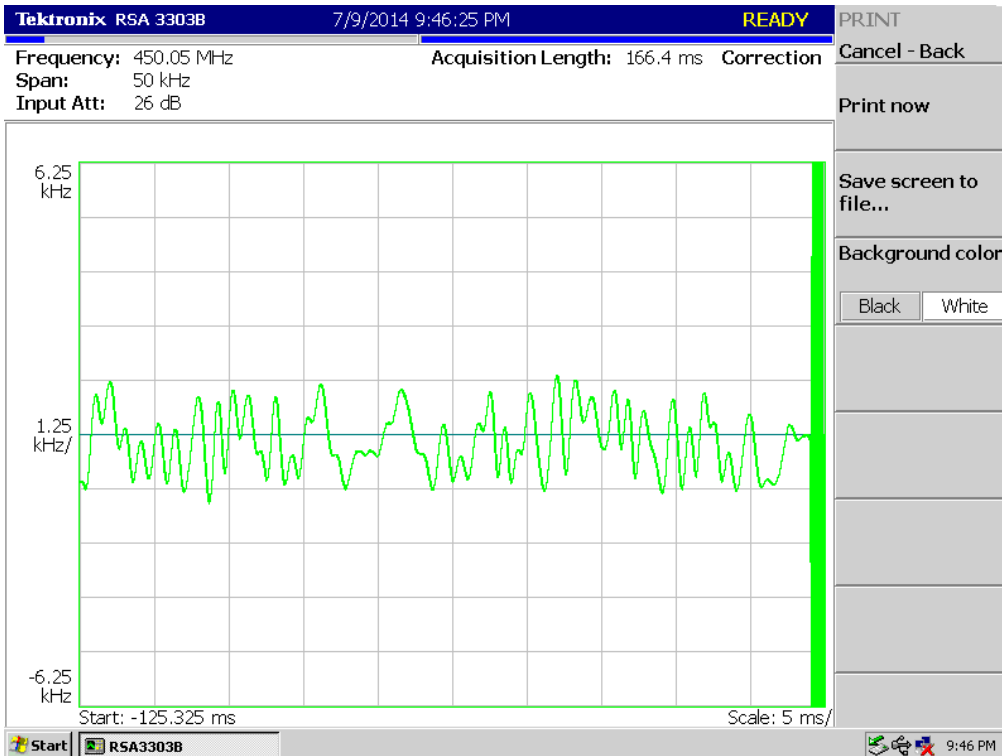
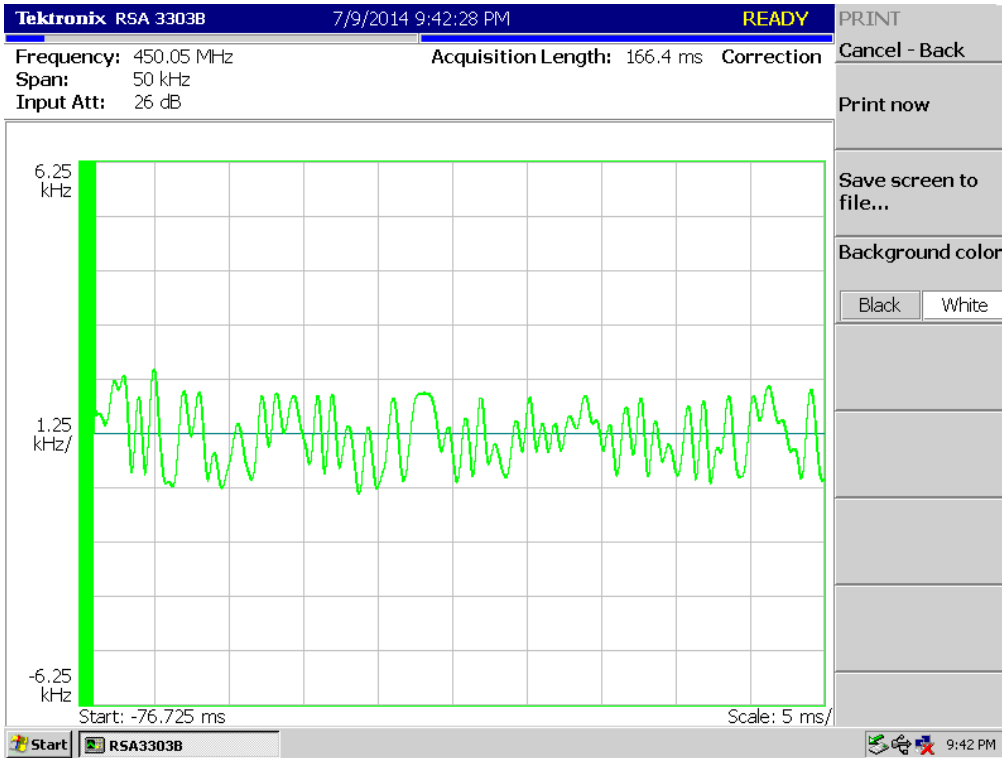

4K00F1E,4K00F1D,4K00F7W _460.05 MHz_LOW POWER

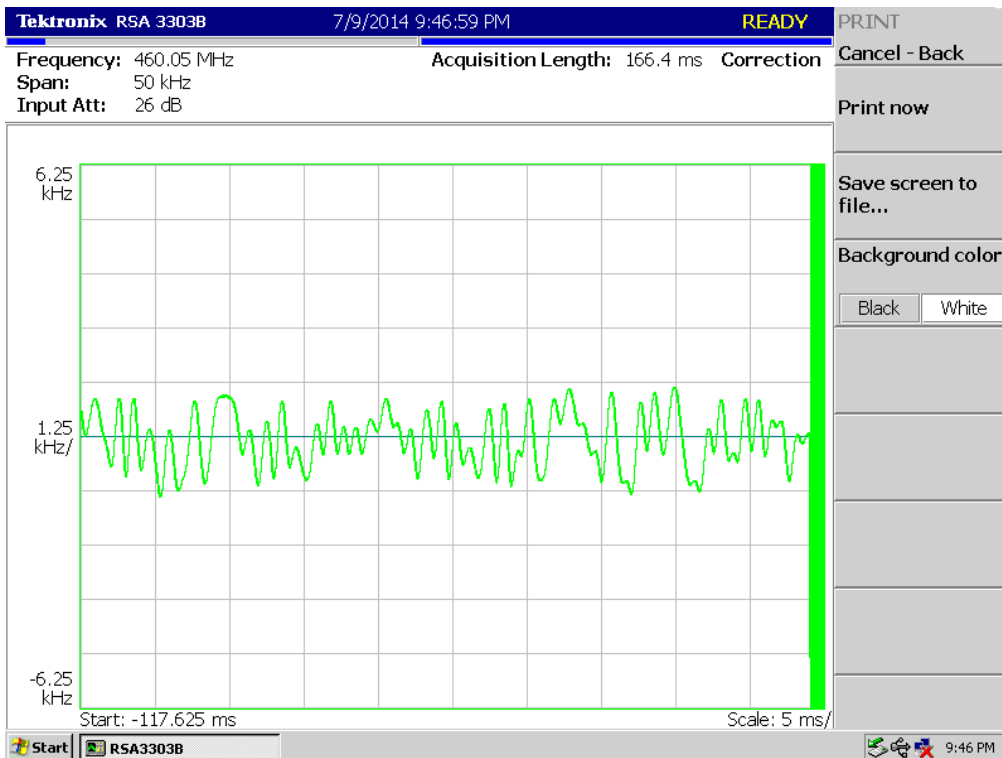
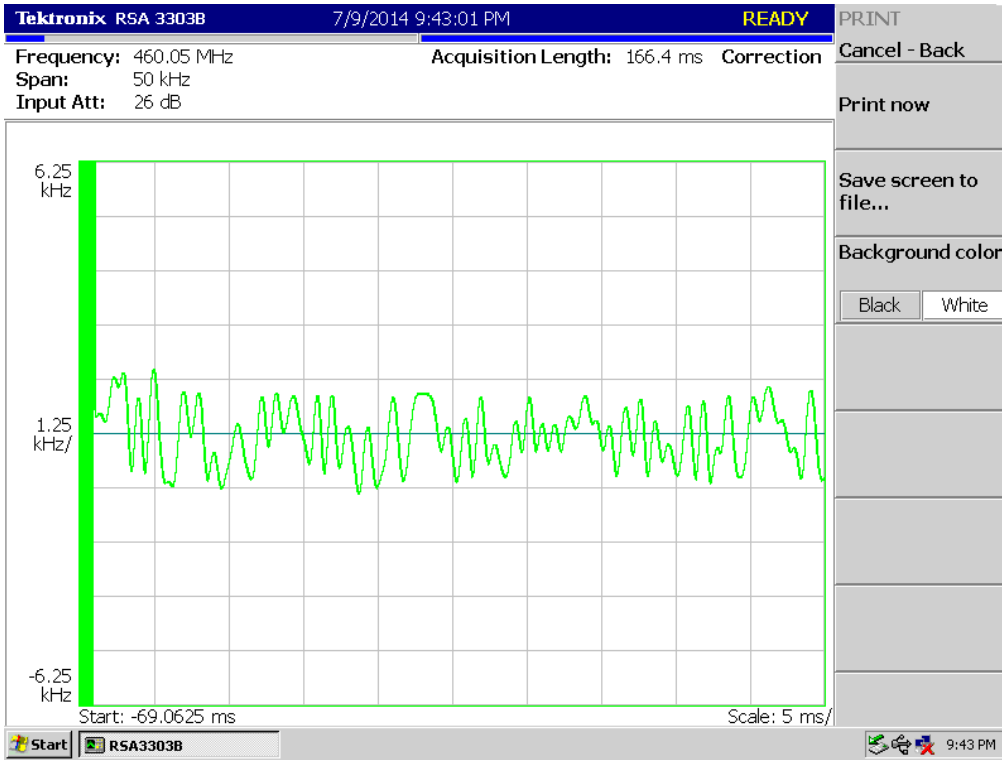

TEST RESULTS
4K00F2D for FCC

4K00F2D_406.15 MHz_LOW POWER

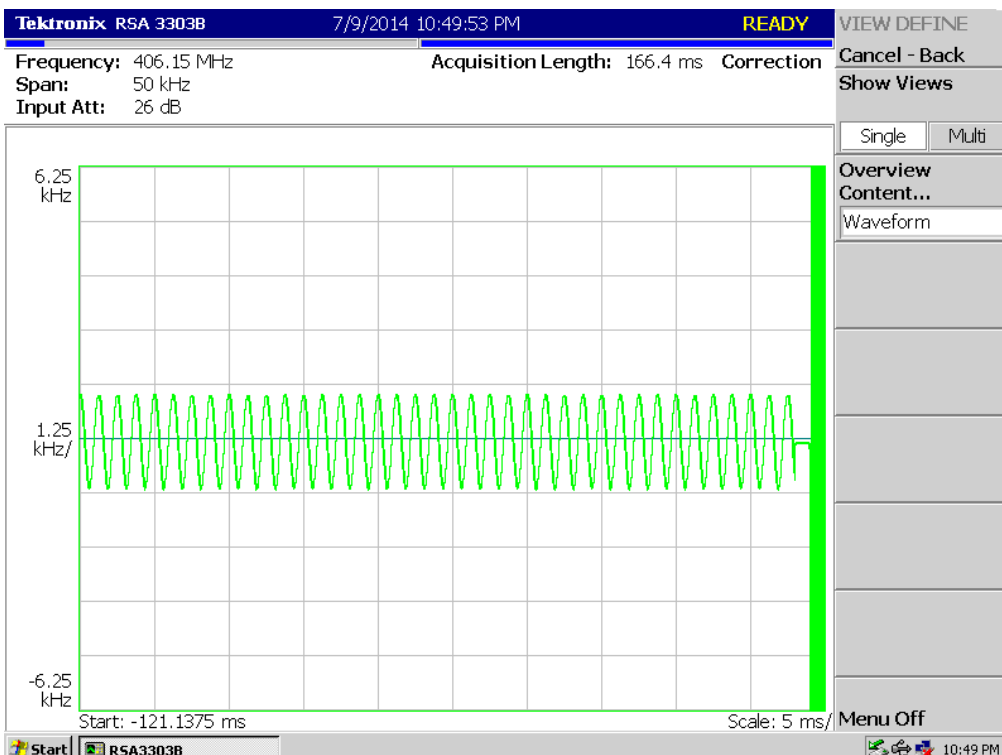
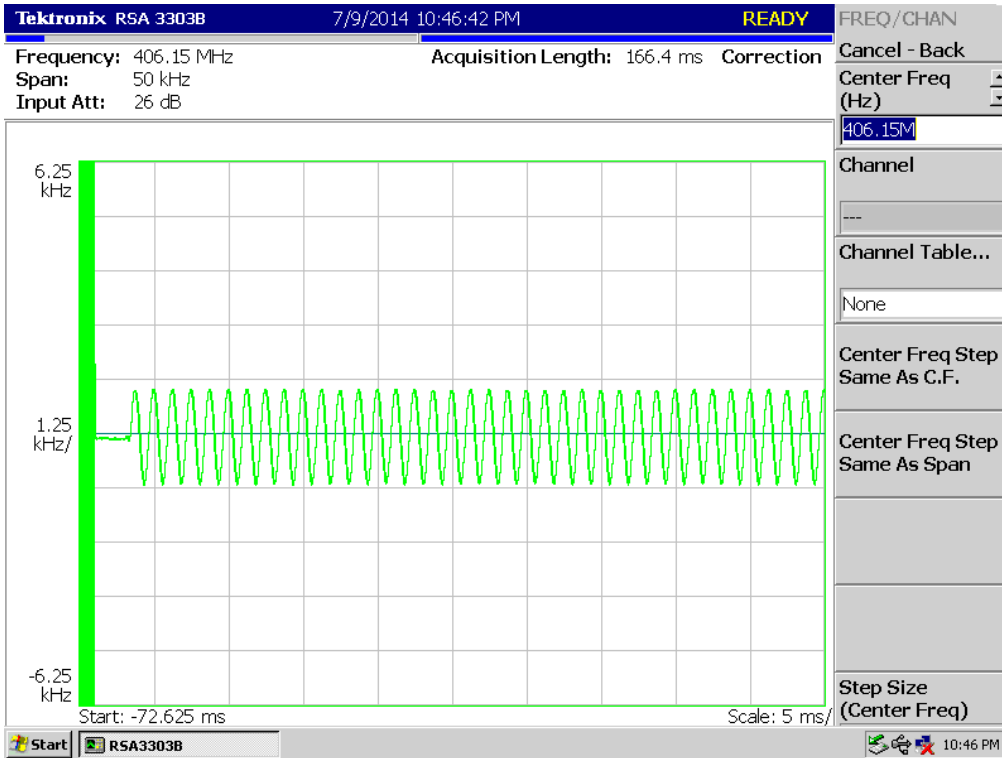

4K00F2D_429.95 MHz_LOW POWER

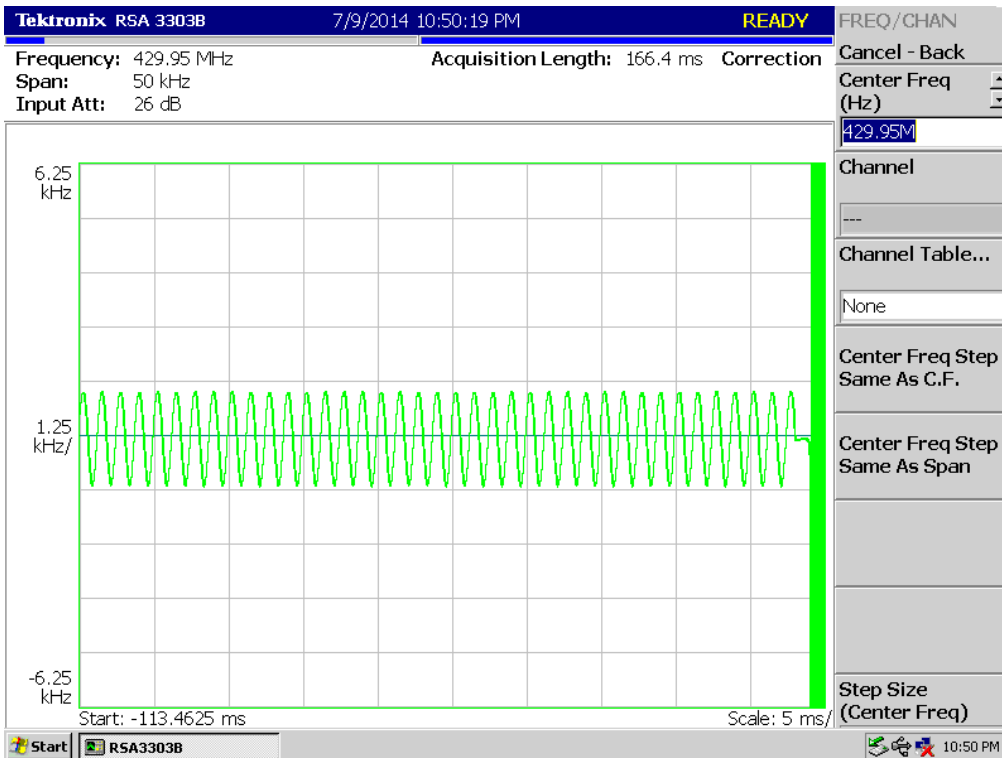
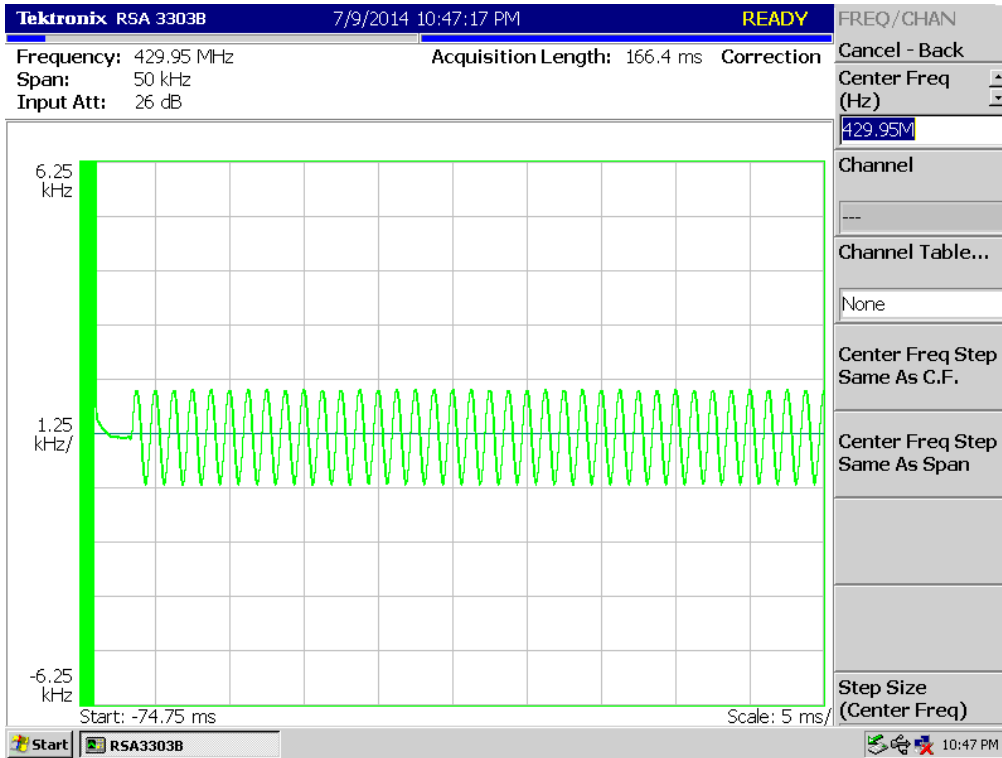

4K00F2D_469.95 MHz_LOW POWER

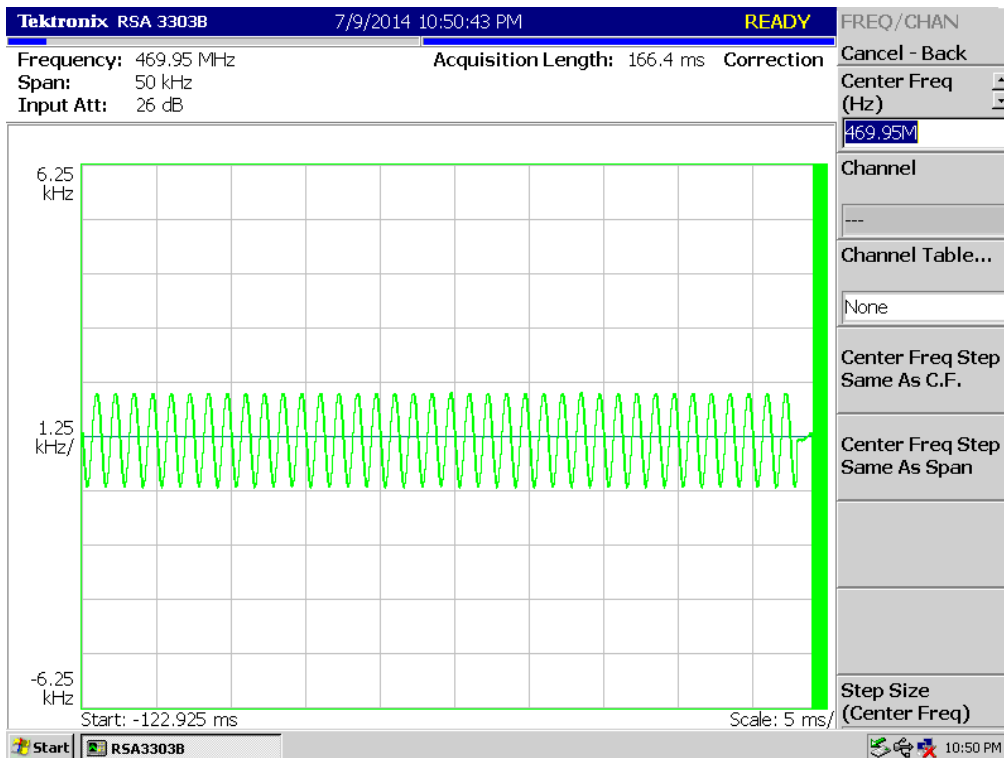
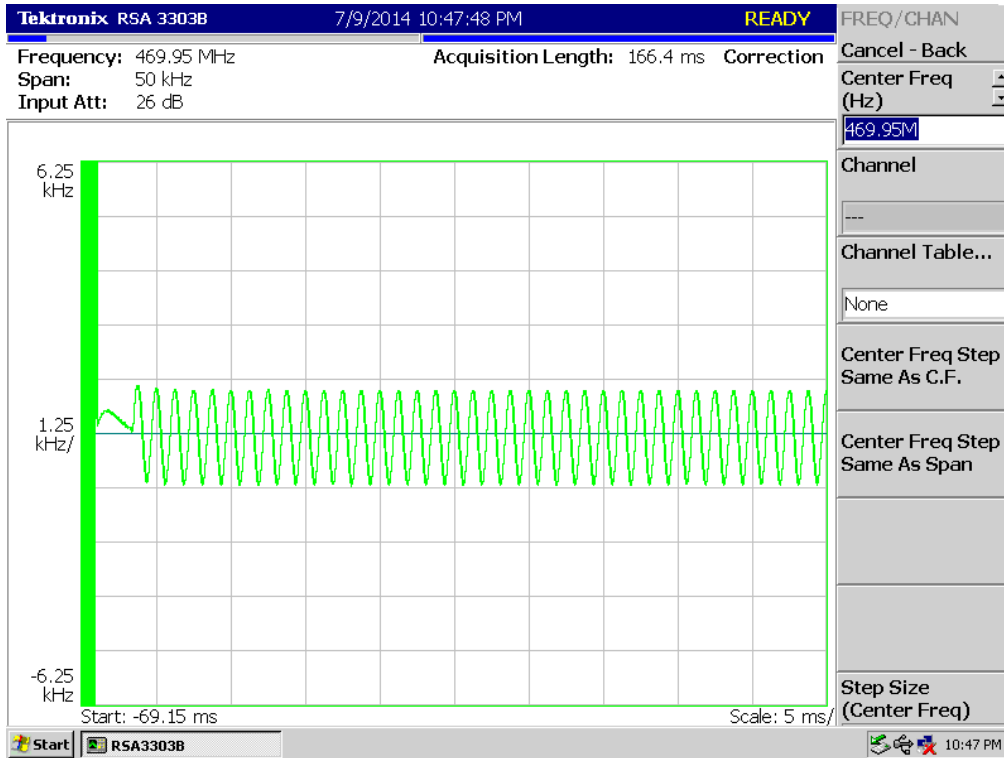

TEST RESULTS

4K00F2D for IC

4K00F2D_418.05 MHz_LOW POWER

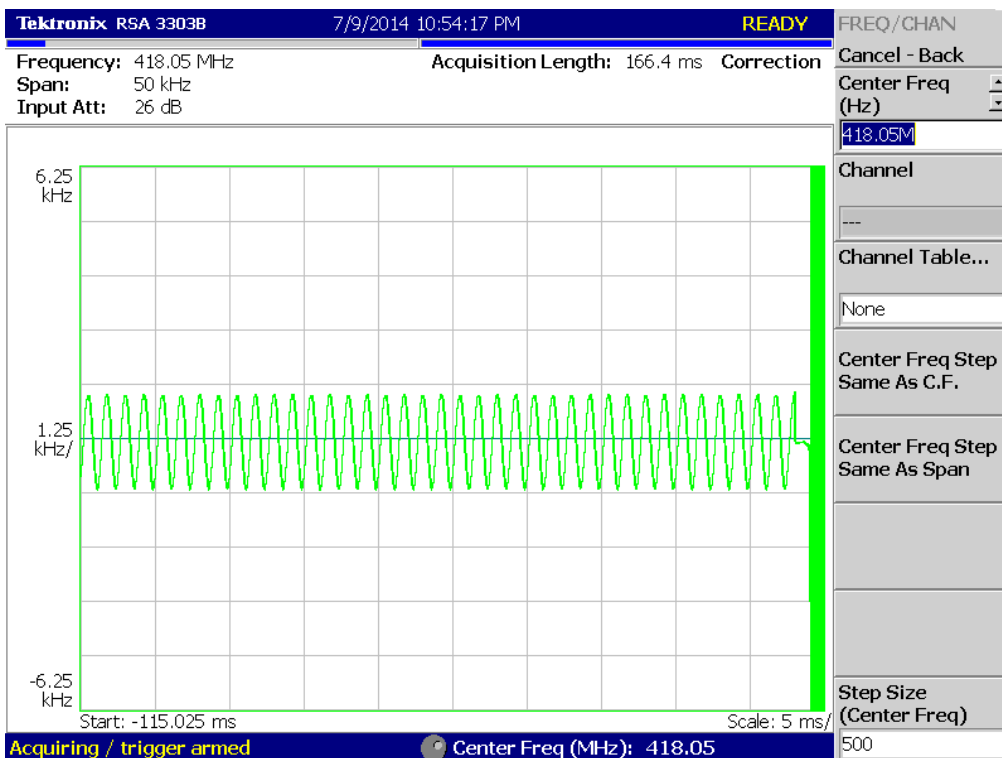
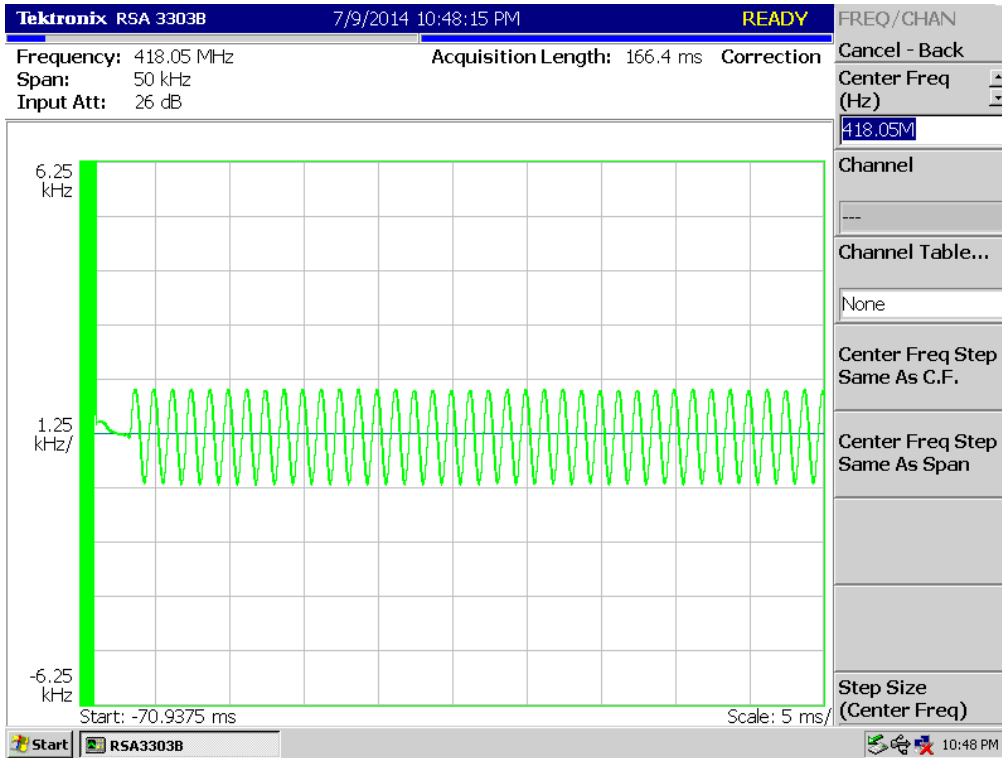

4K00F2D_450.05 MHz_LOW POWER

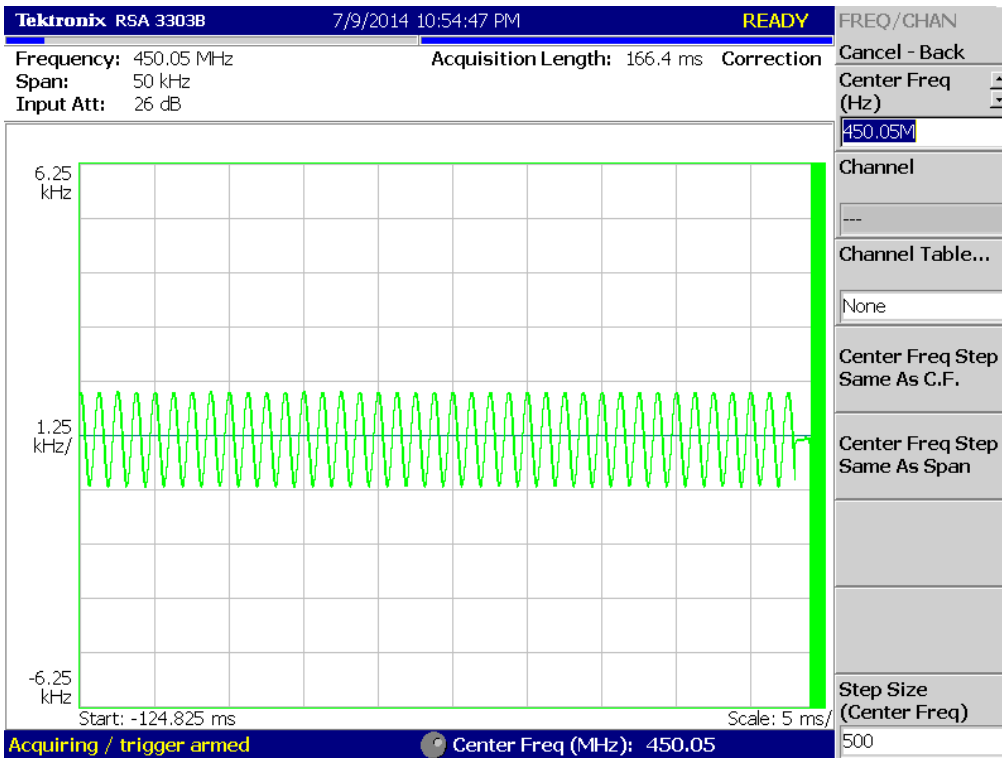
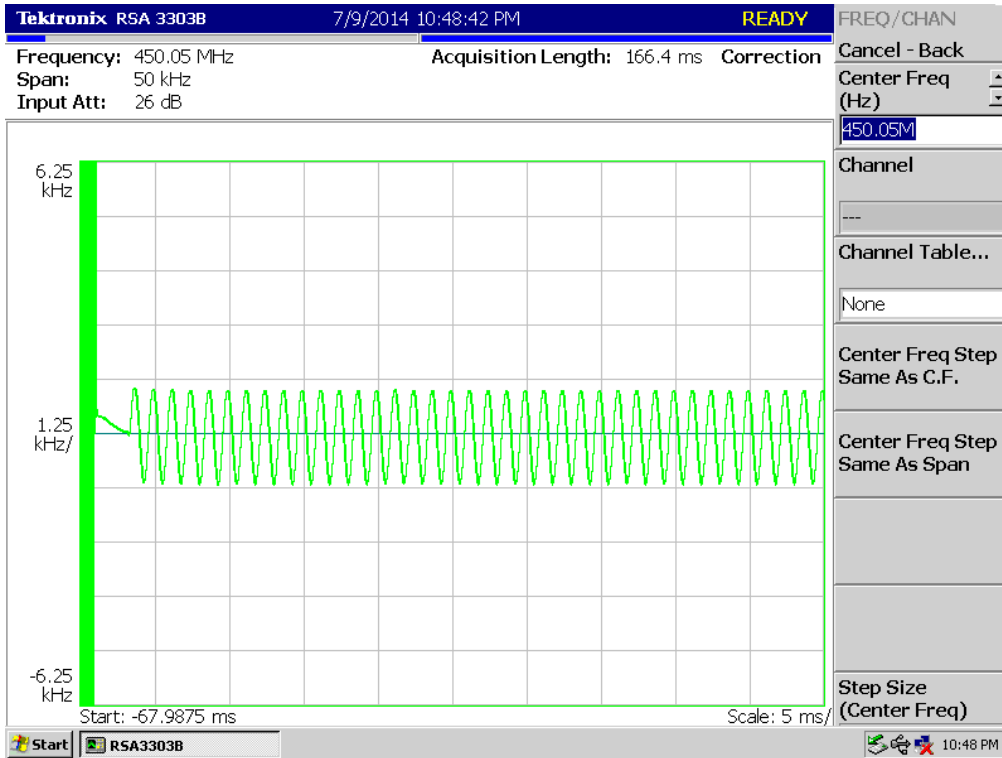

4K00F2D_460.05 MHz_LOW POWER

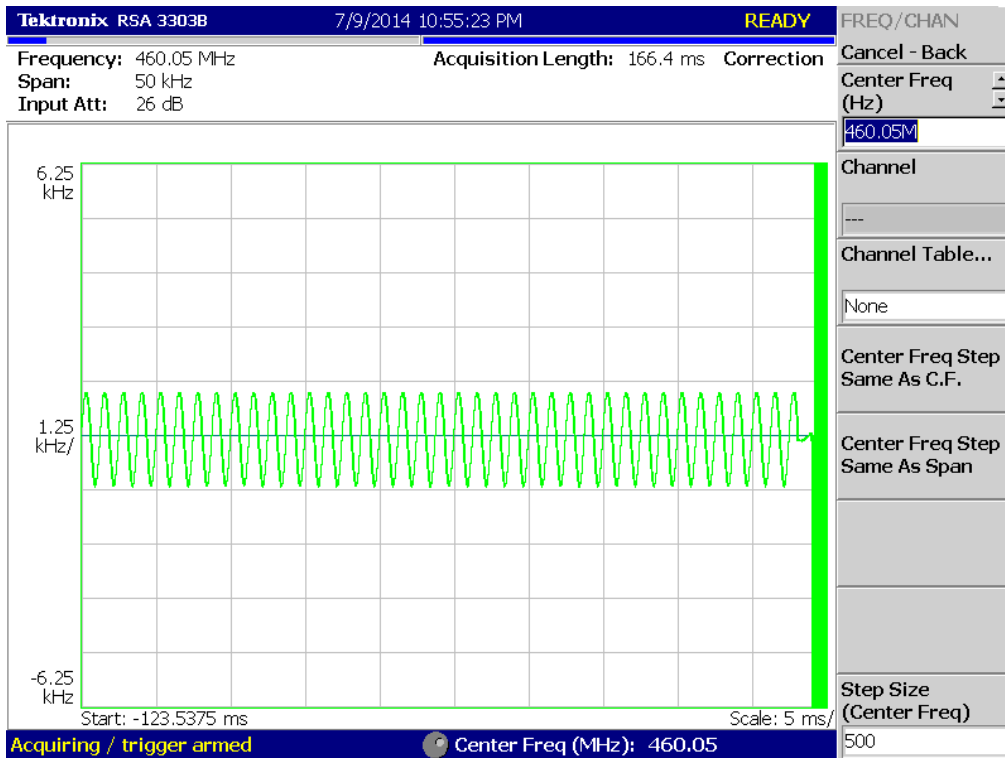
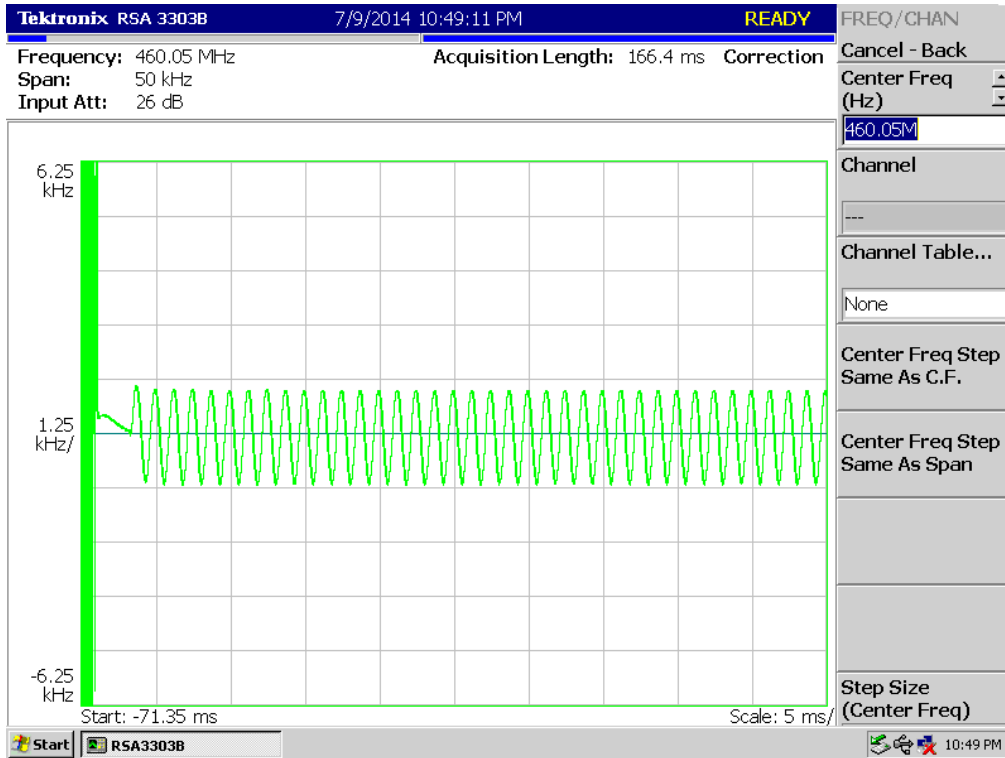

TEST RESULTS

8K10F1E, 8K10F1D for FCC

8K10F1E, 8K10F1D_429.95 MHz_HIGH POWER

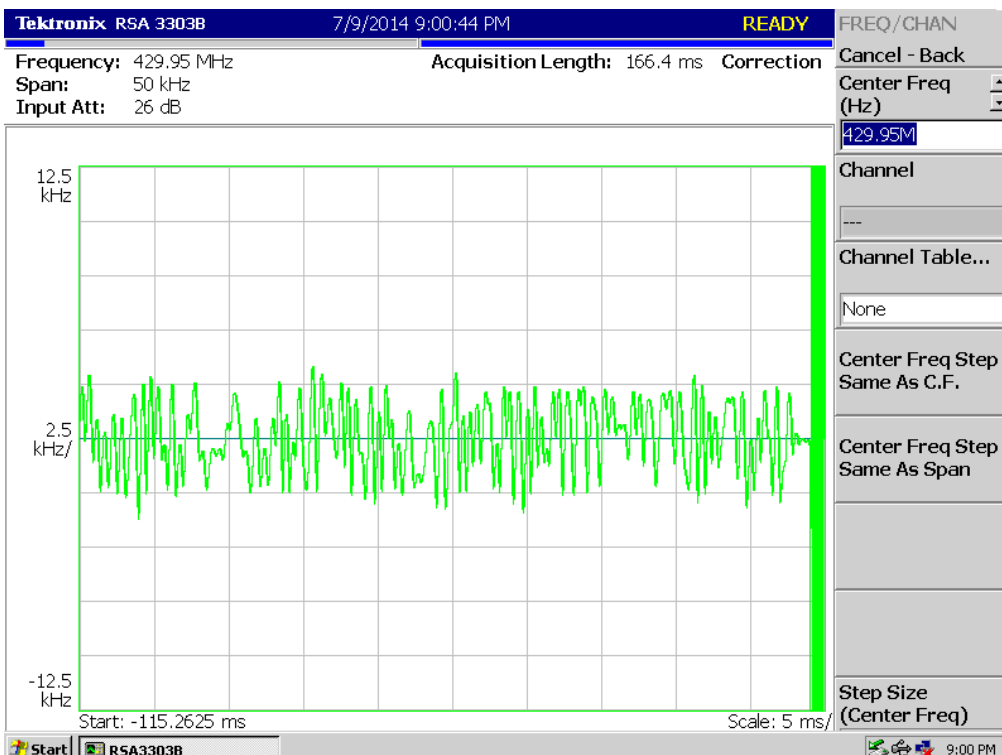
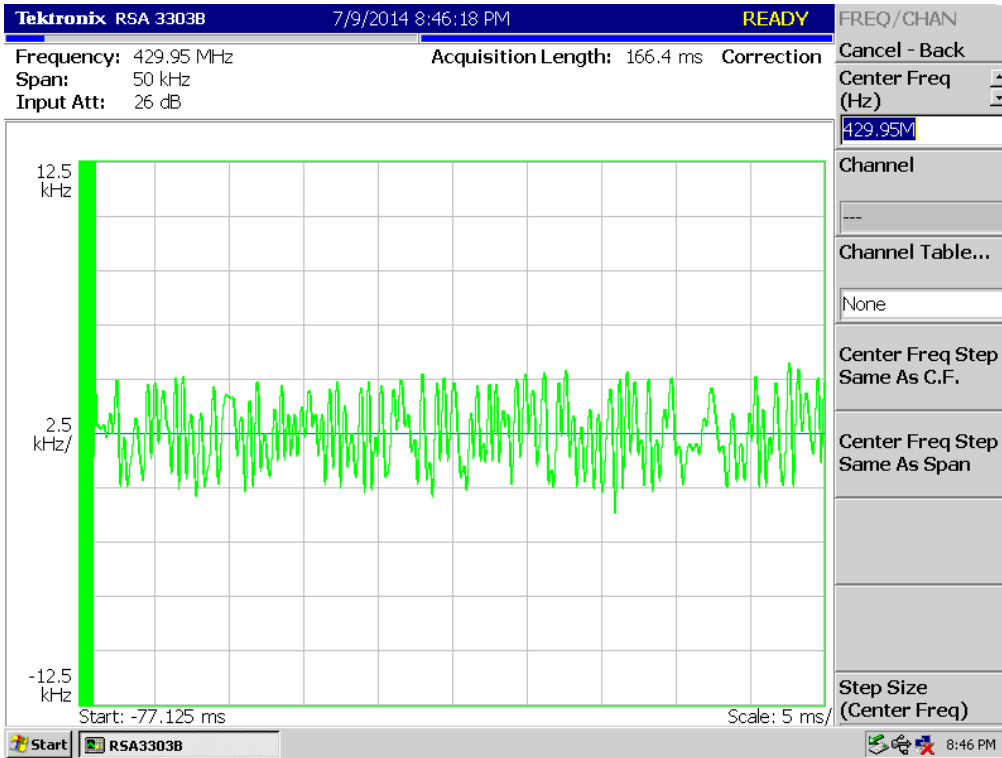

8K10F1E, 8K10F1D_406.15 MHz_HIGH POWER

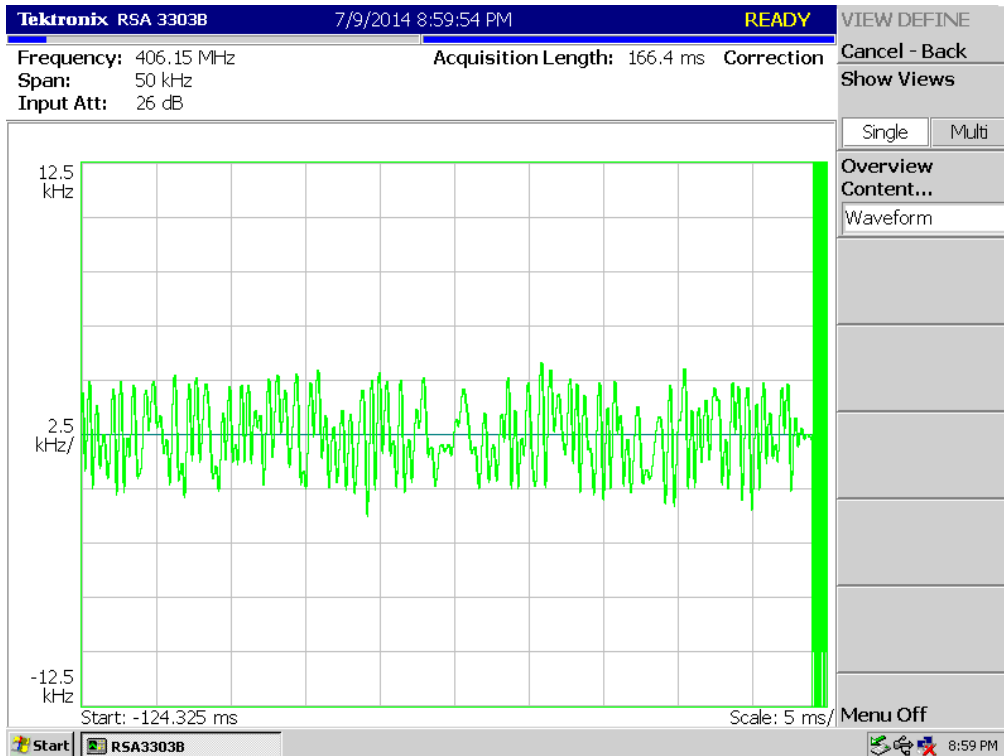
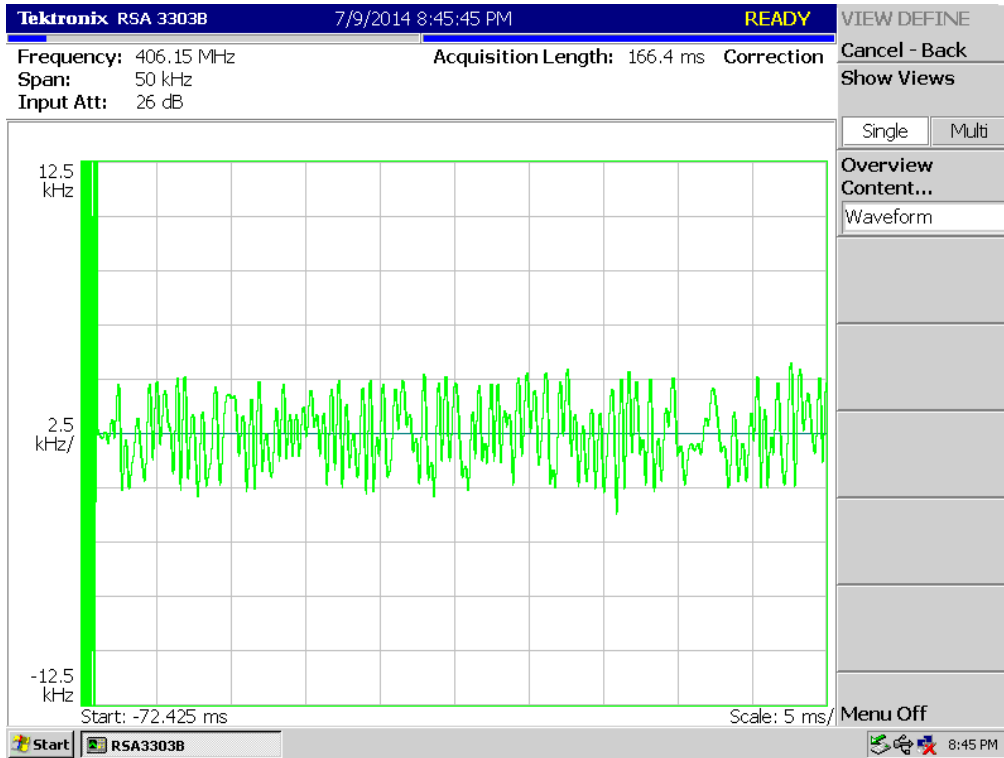

8K10F1E, 8K10F1D_469.95 MHz_HIGH POWER

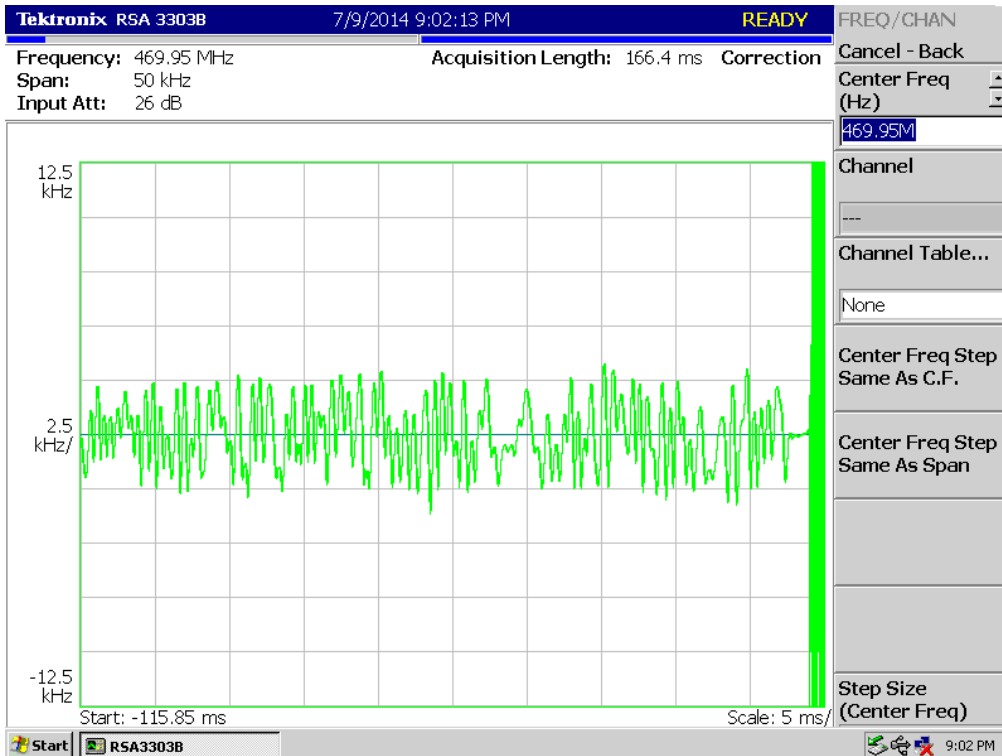
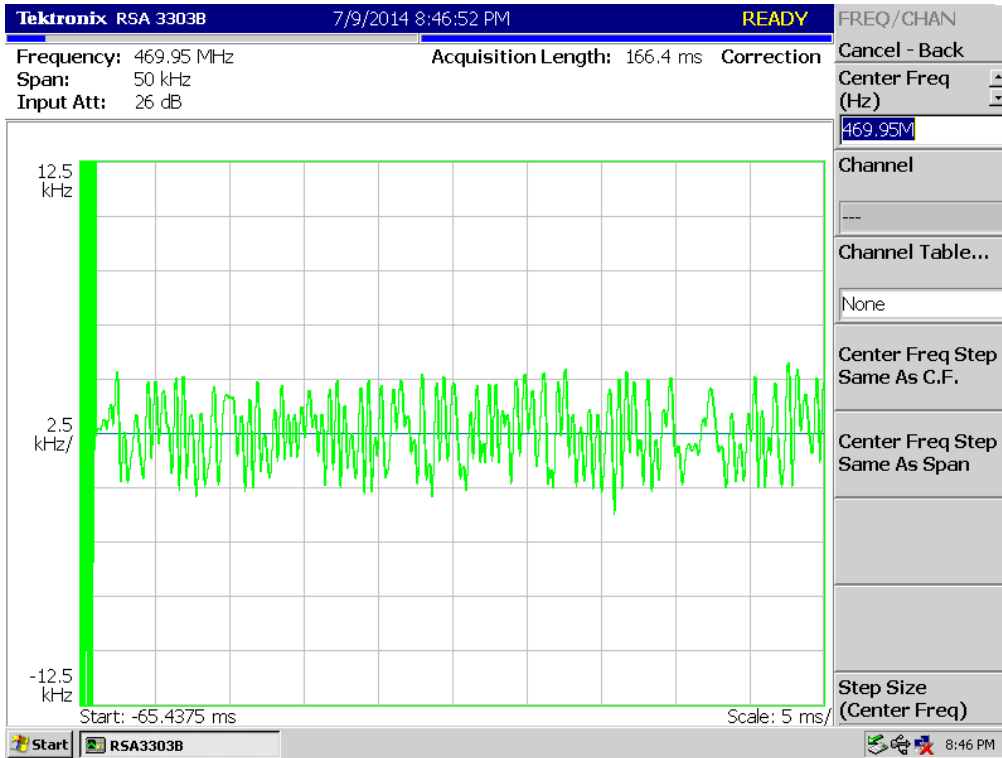

8K10F1E, 8K10F1D_406.15 MHz_LOW POWER

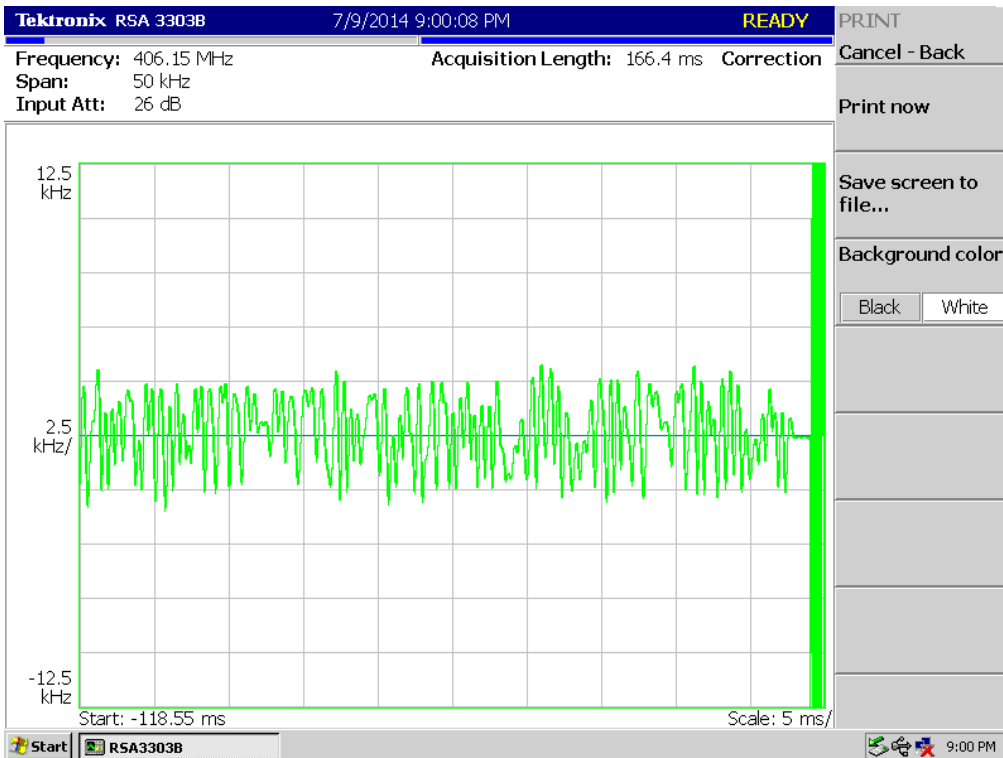
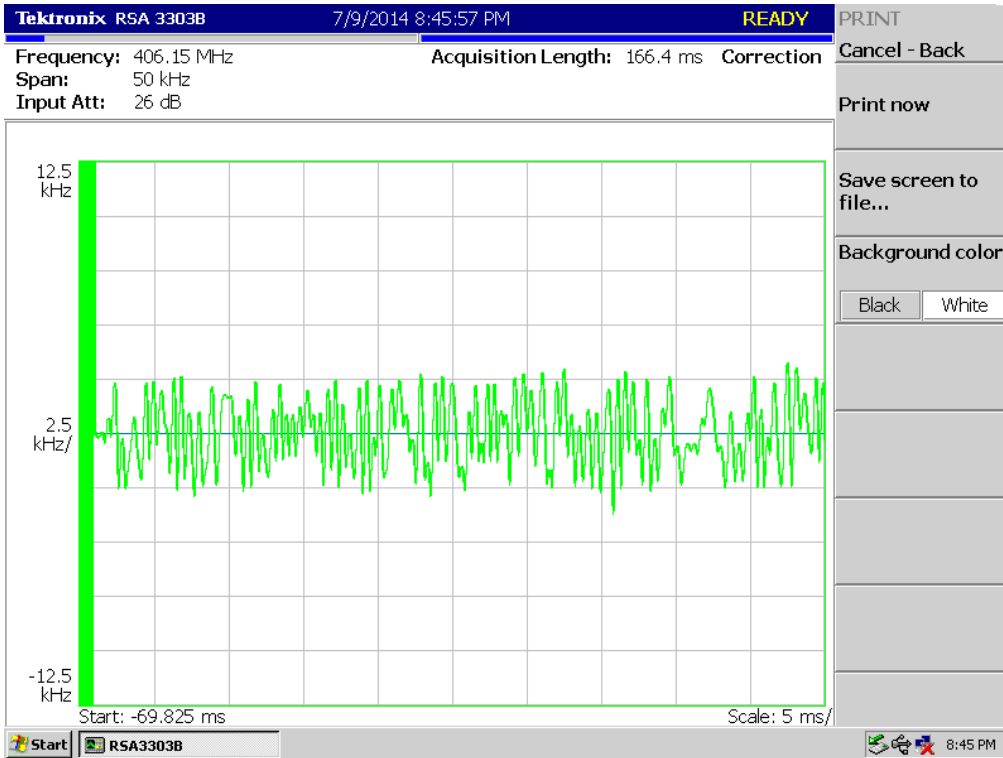

8K10F1E, 8K10F1D_429.95 MHz_LOW POWER

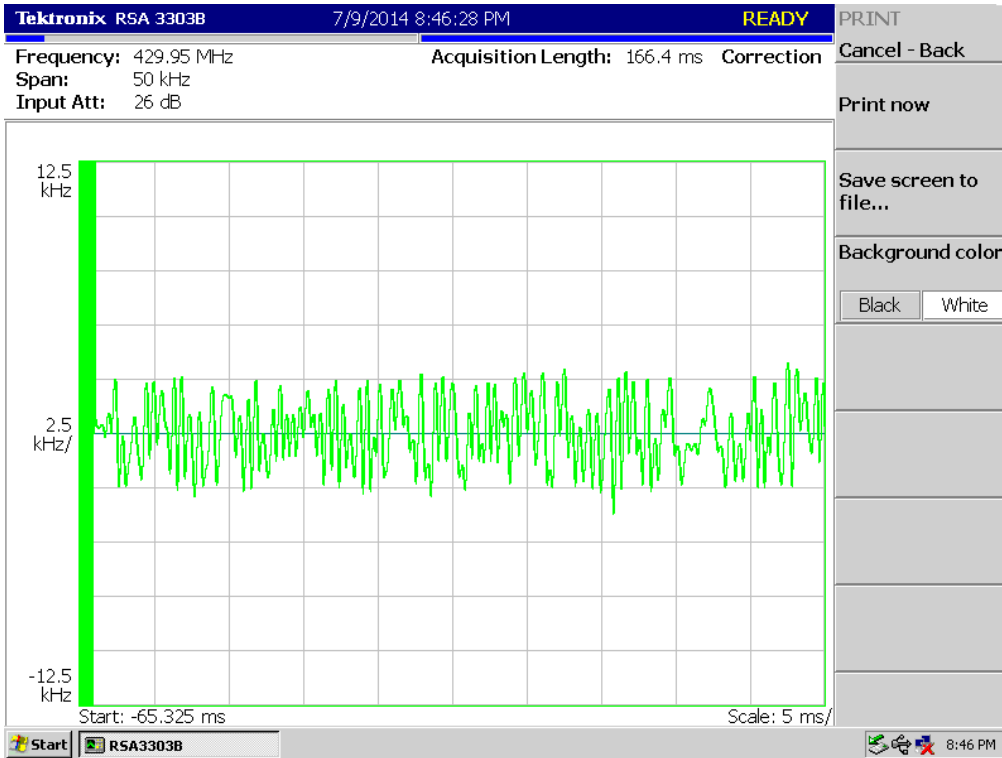

8K10F1E, 8K10F1D_469.95 MHz_LOW POWER

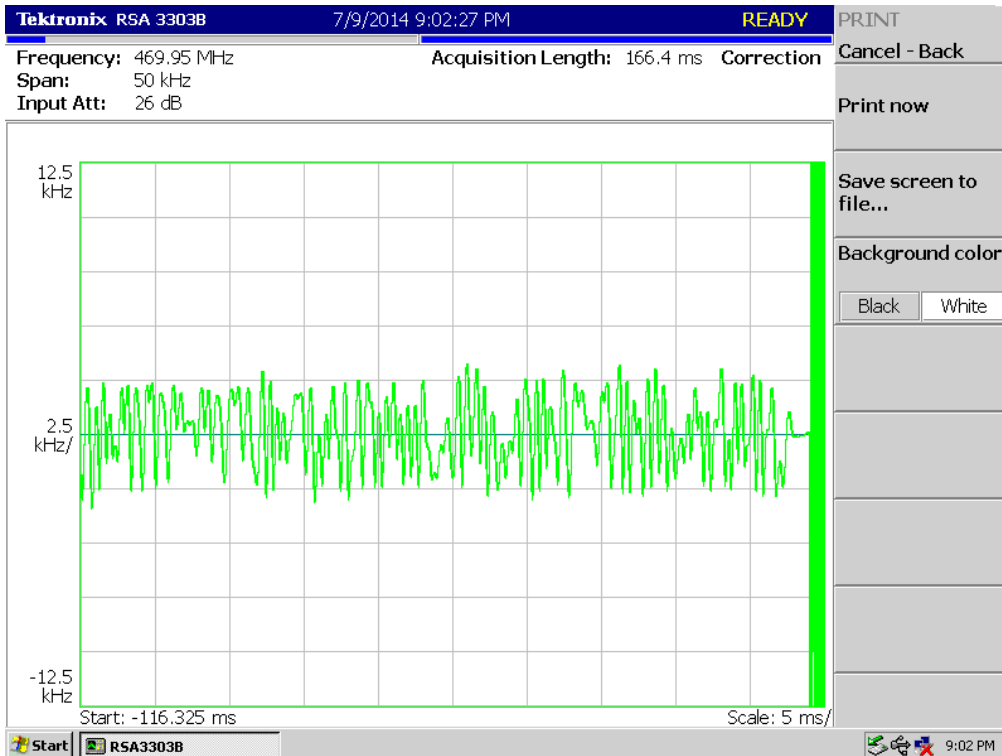
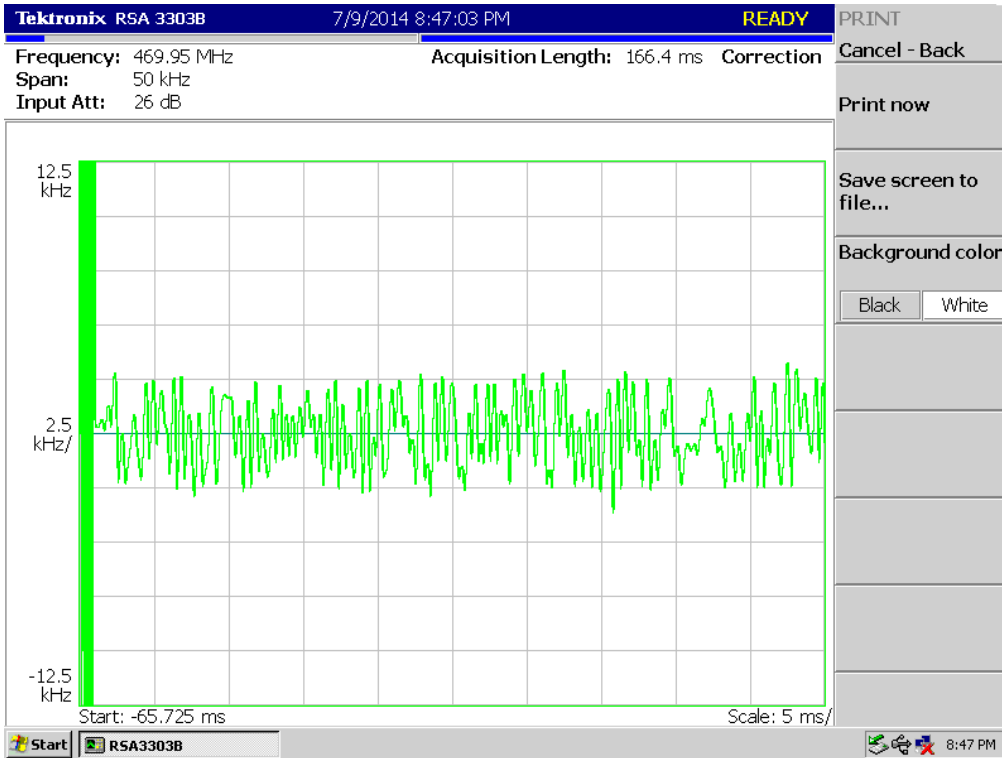

TEST RESULTS

8K10F1E, 8K10F1D for IC

8K10F1E, 8K10F1D_418.05 MHz_HIGH POWER

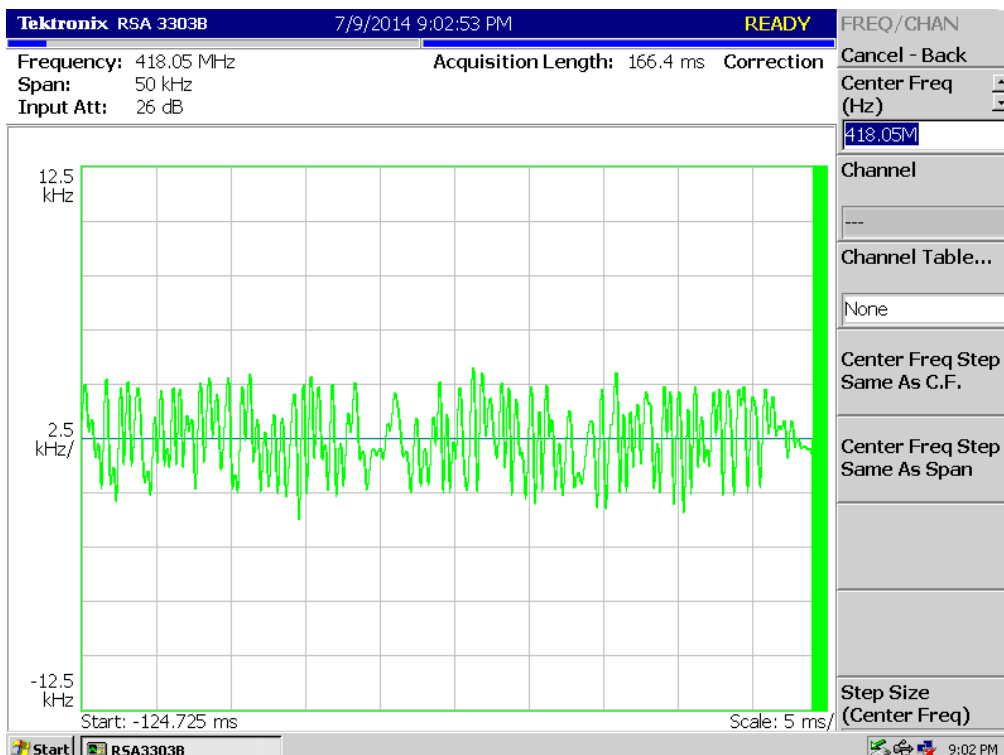
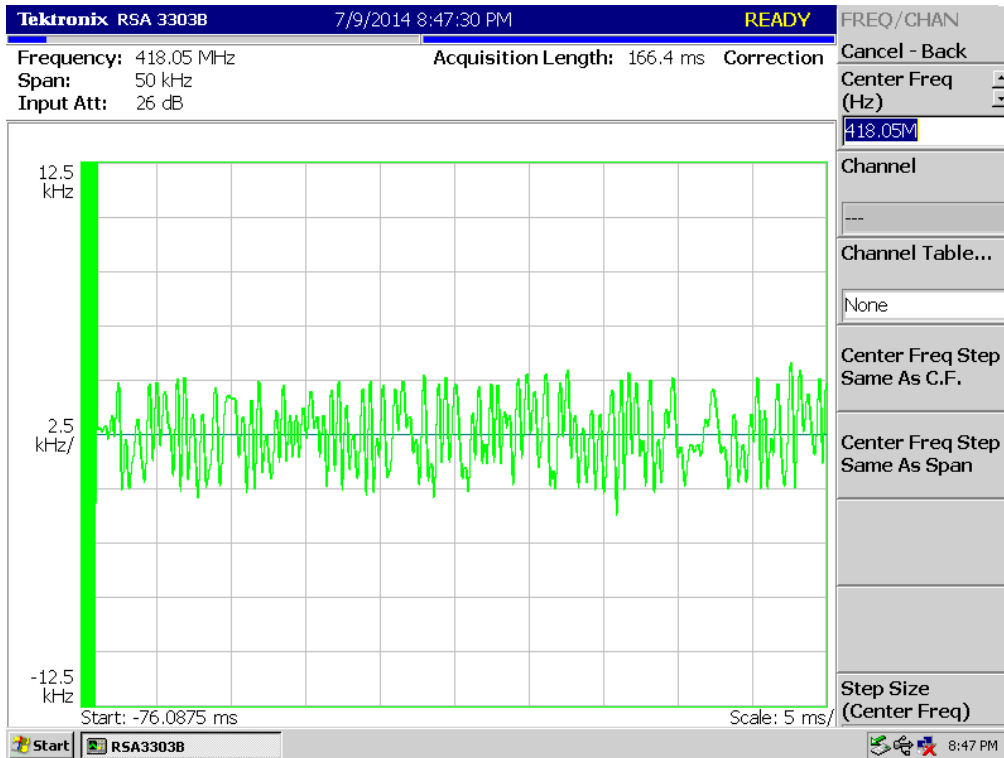

8K10F1E, 8K10F1D_450.05 MHz_HIGH POWER

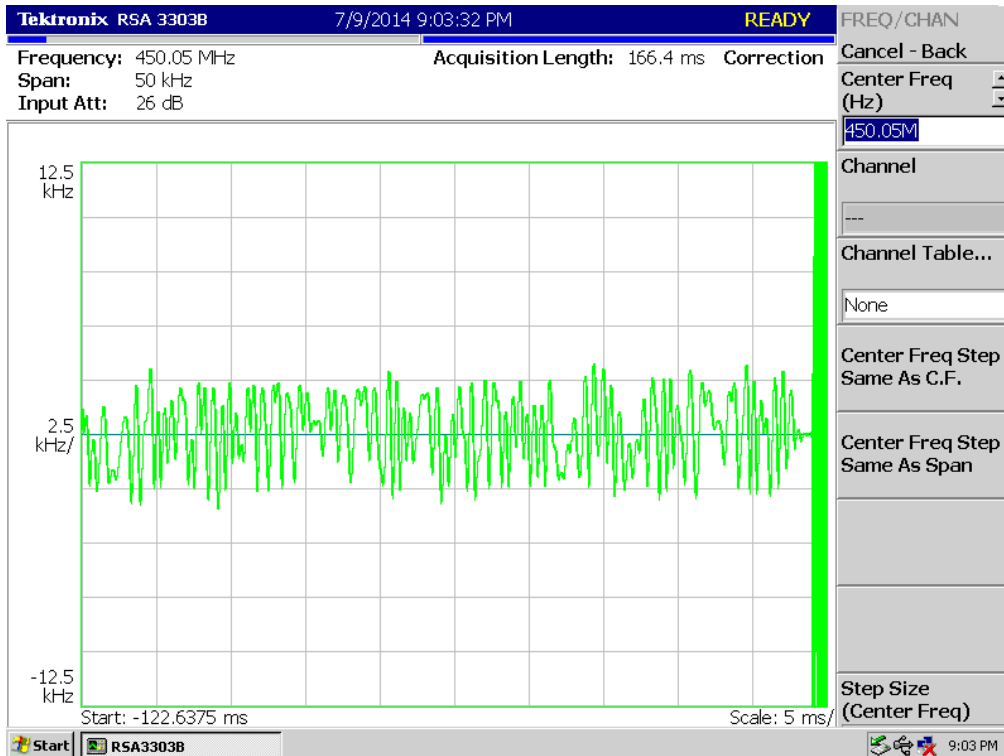
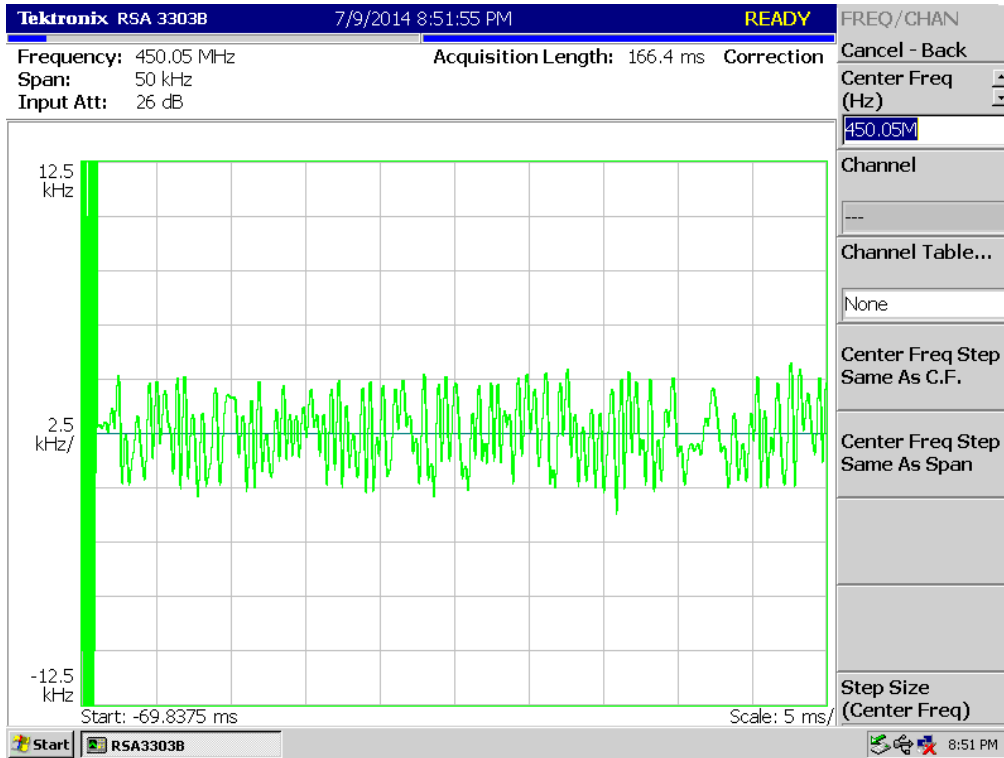

8K10F1E, 8K10F1D_460.05 MHz_HIGH POWER

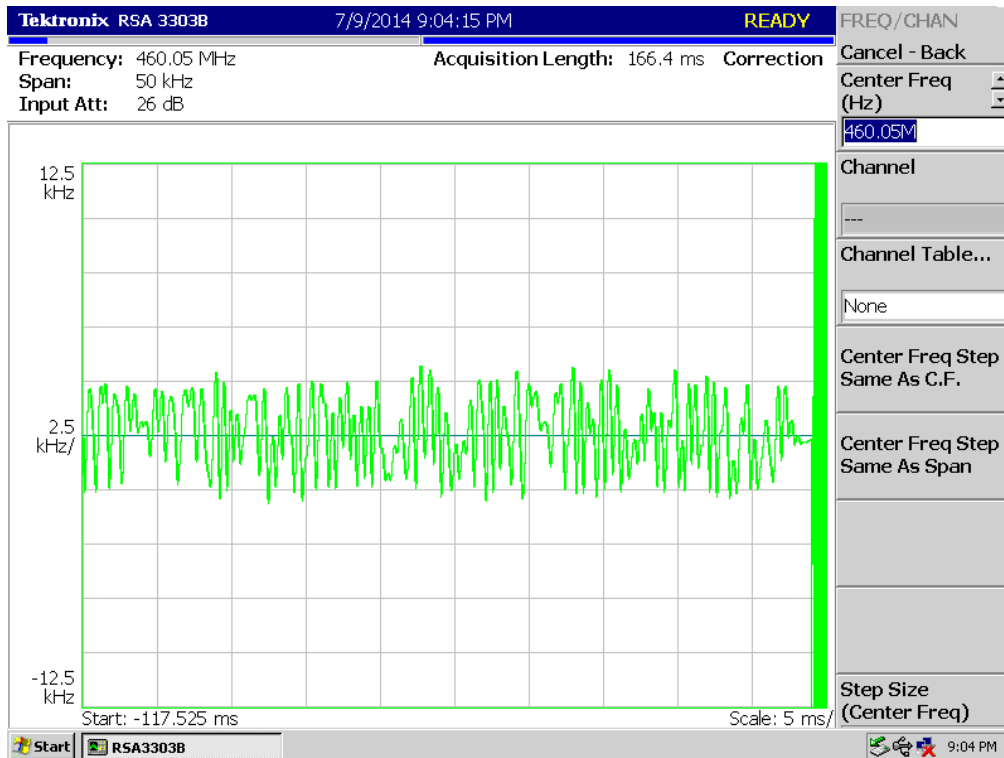
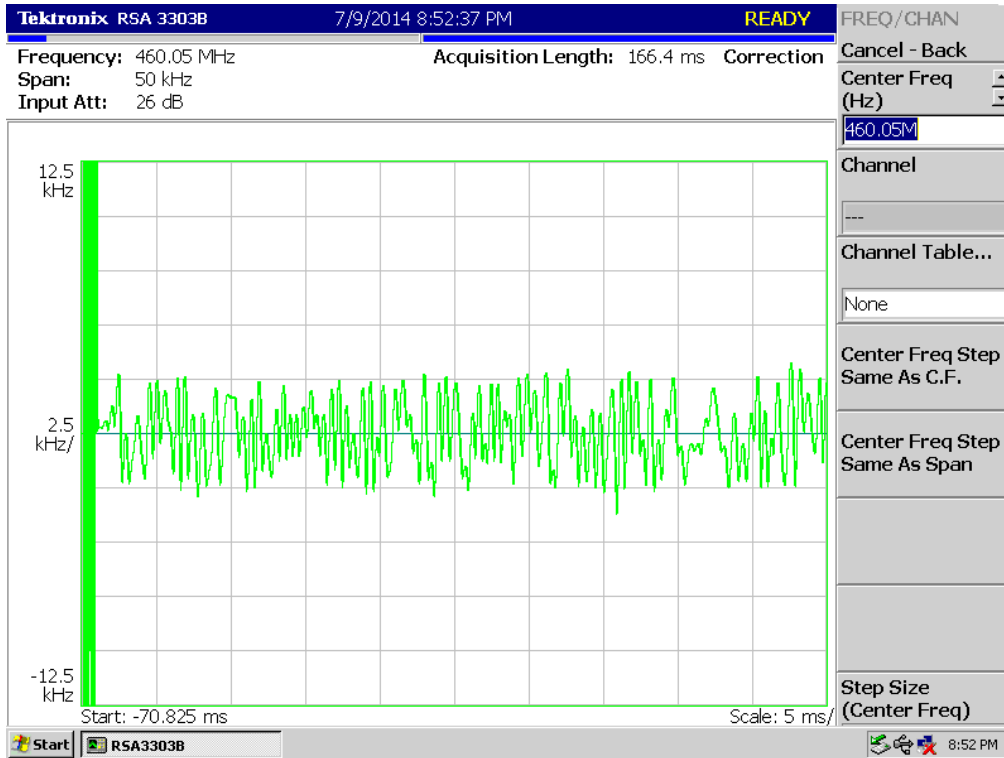

8K10F1E, 8K10F1D_418.05 MHz_LOW POWER

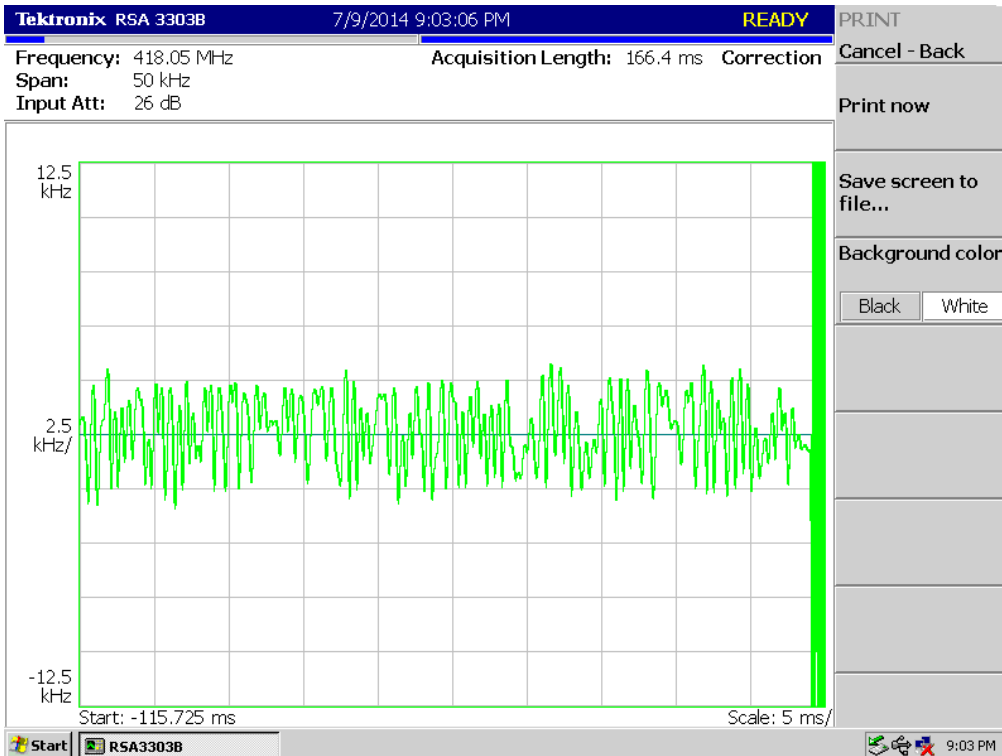
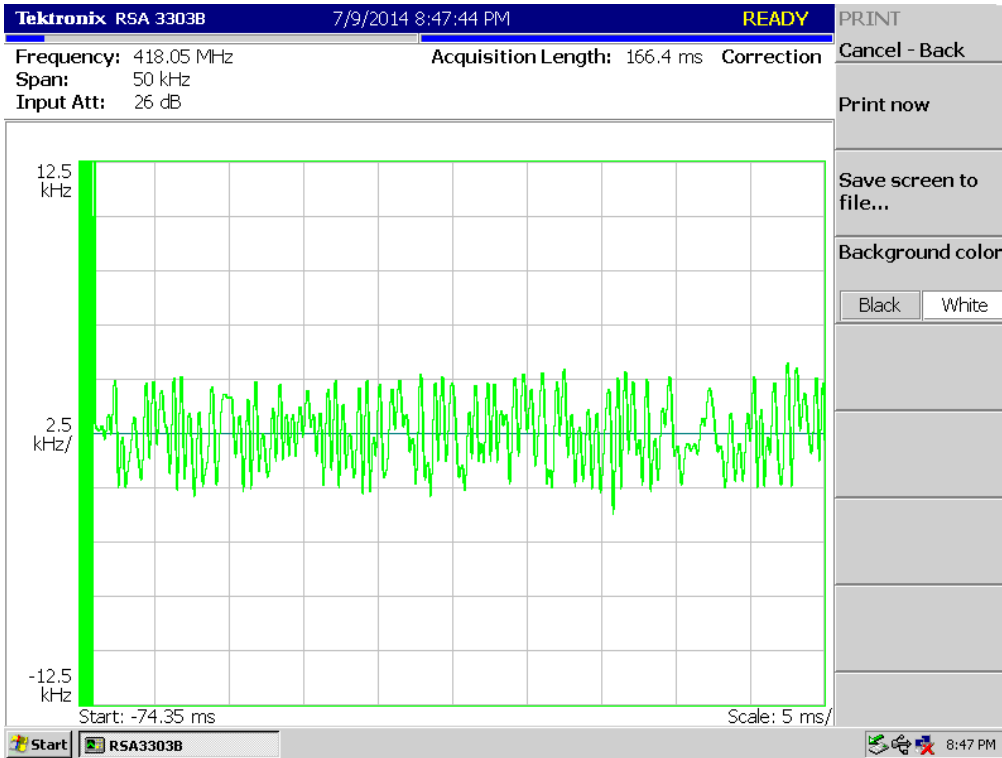

8K10F1E, 8K10F1D_450.05 MHz_LOW POWER

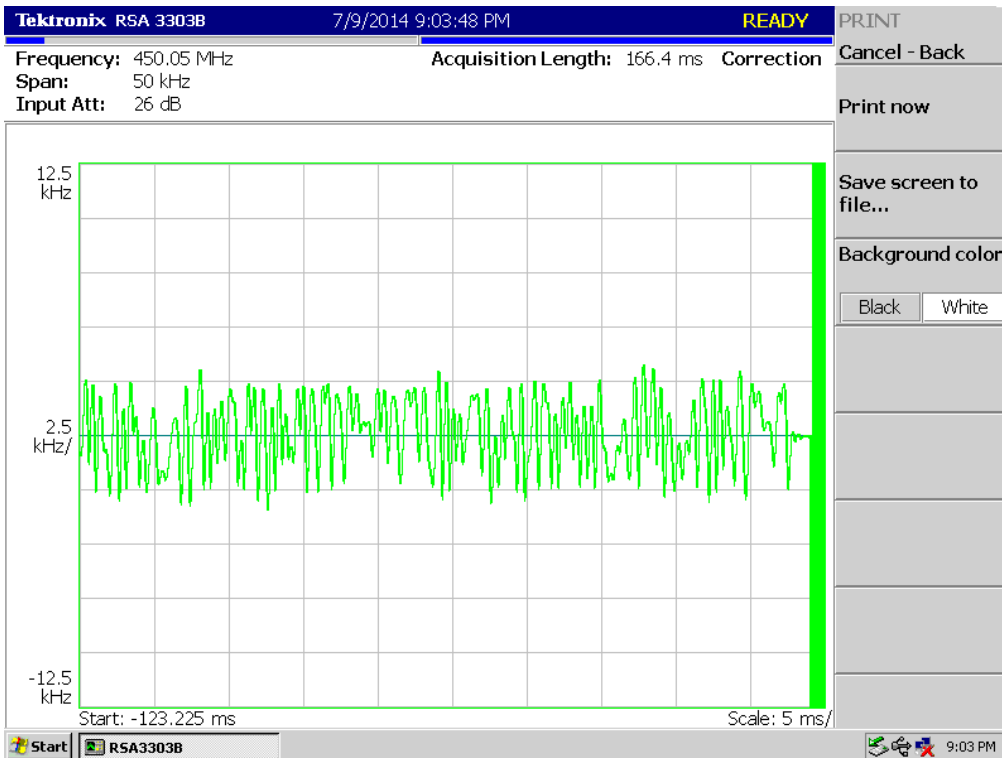
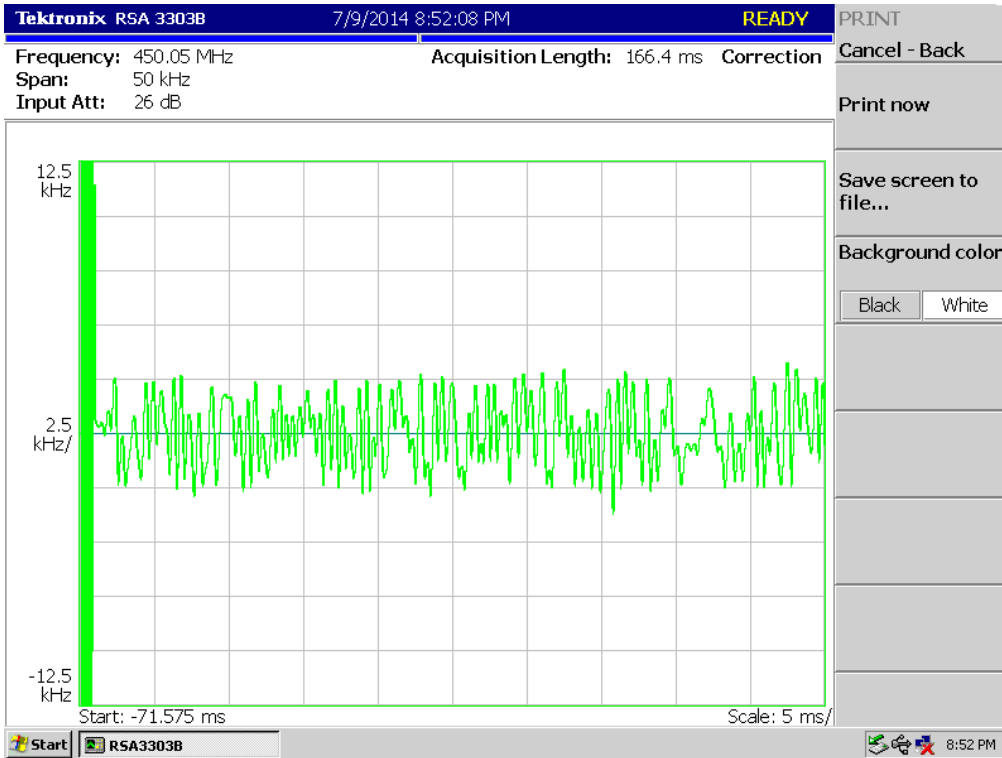

8K10F1E, 8K10F1D_460.05 MHz_LOW POWER

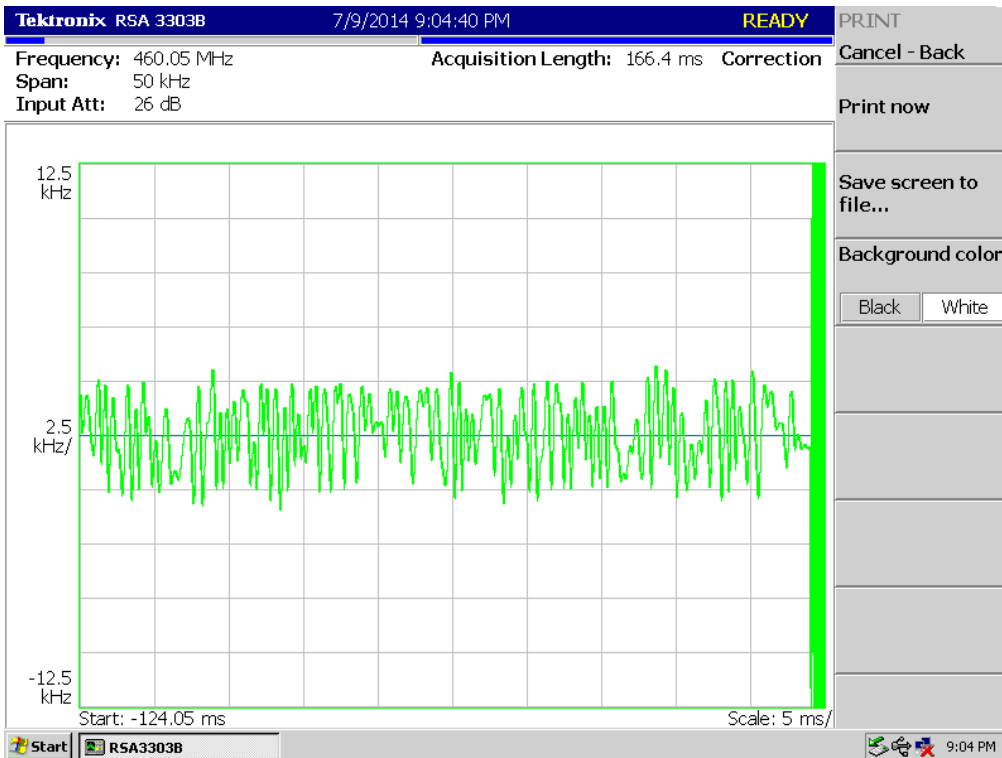
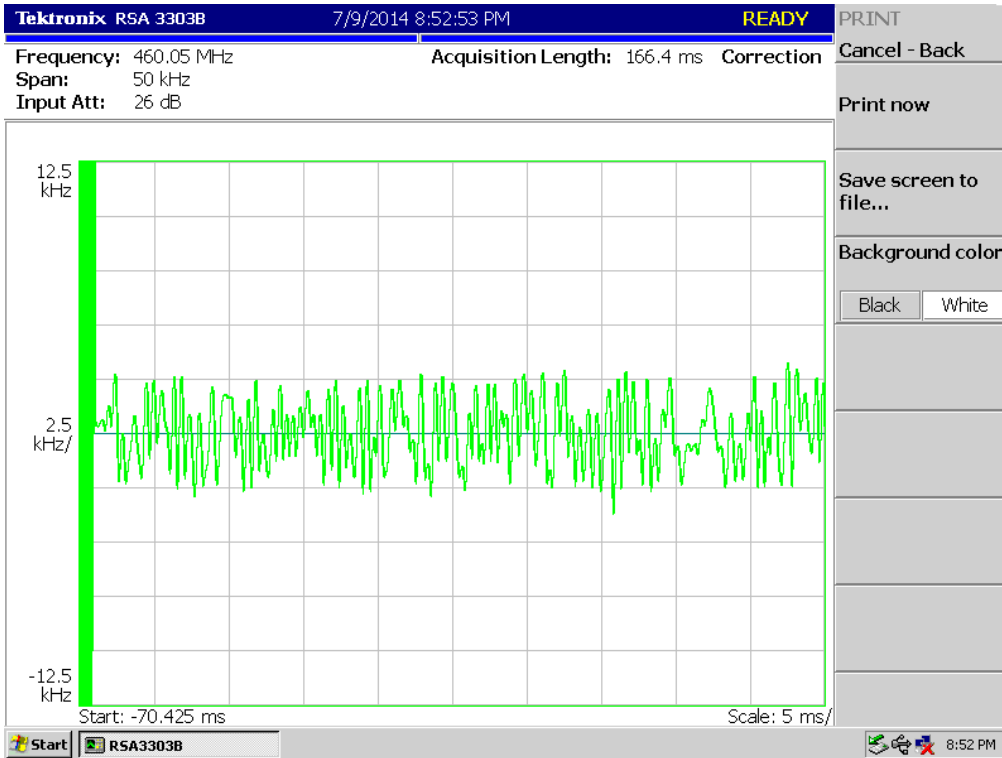

TEST RESULTS

8K10F1W for FCC

8K10F1W_406.15 MHz_HIGH POWER

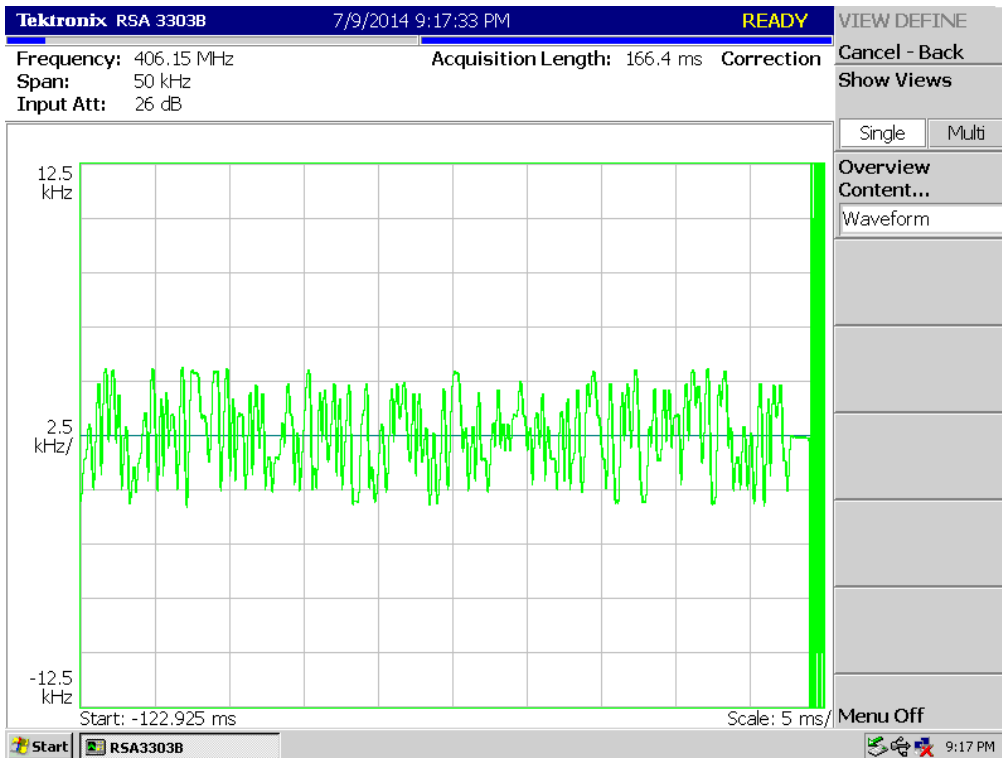
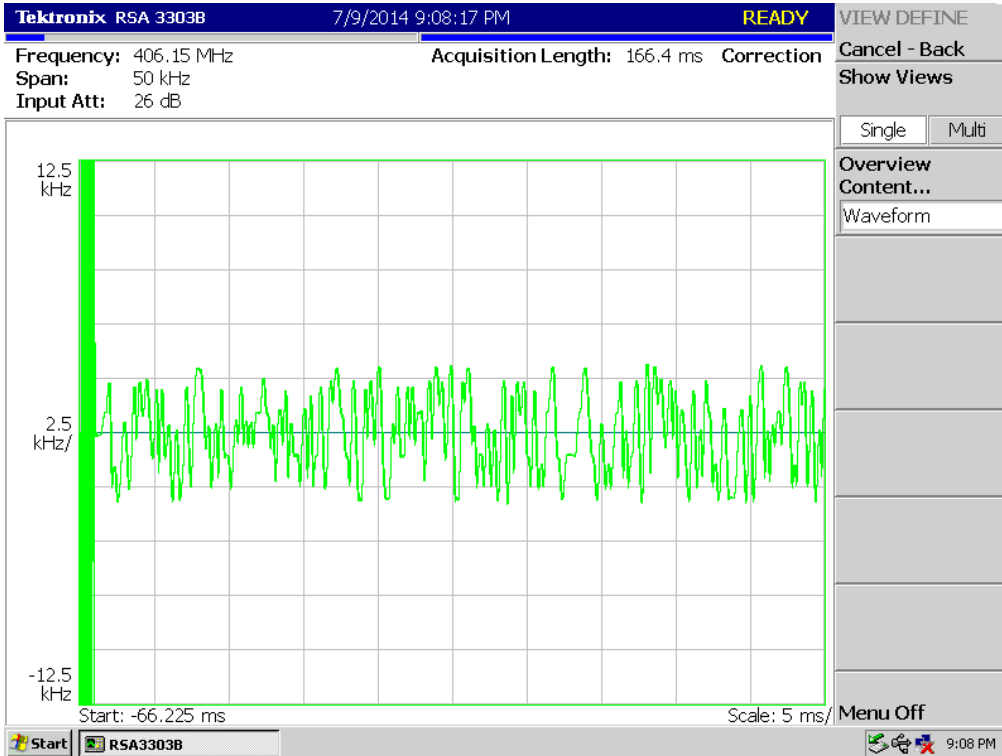

8K10F1W_429.95 MHz_HIGH POWER

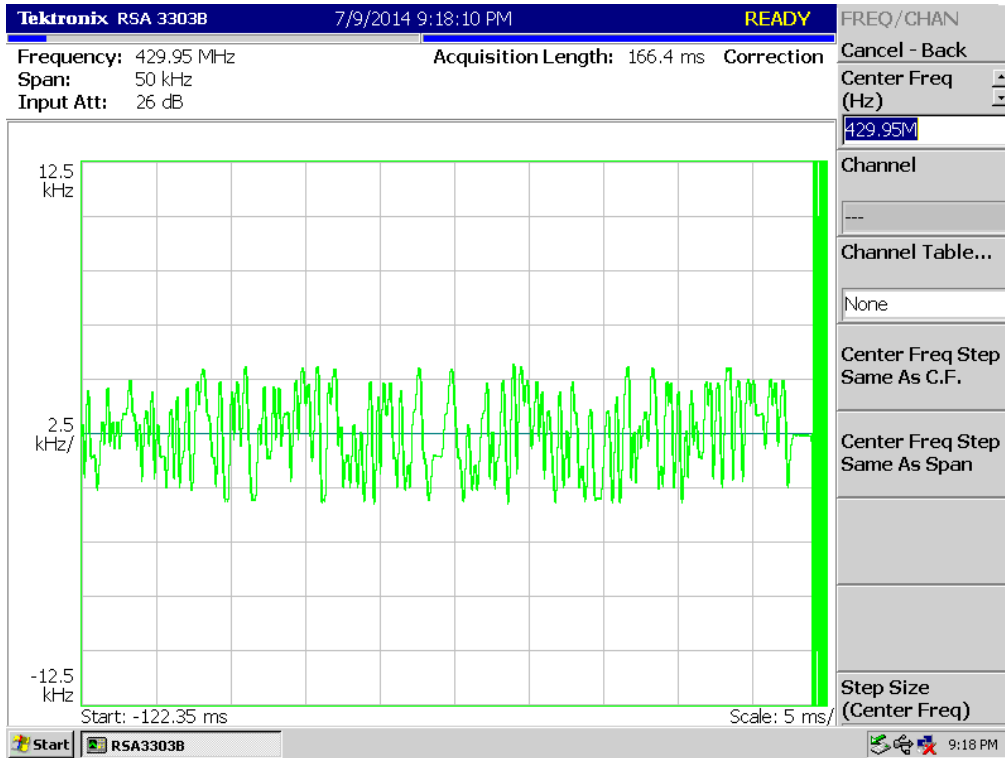
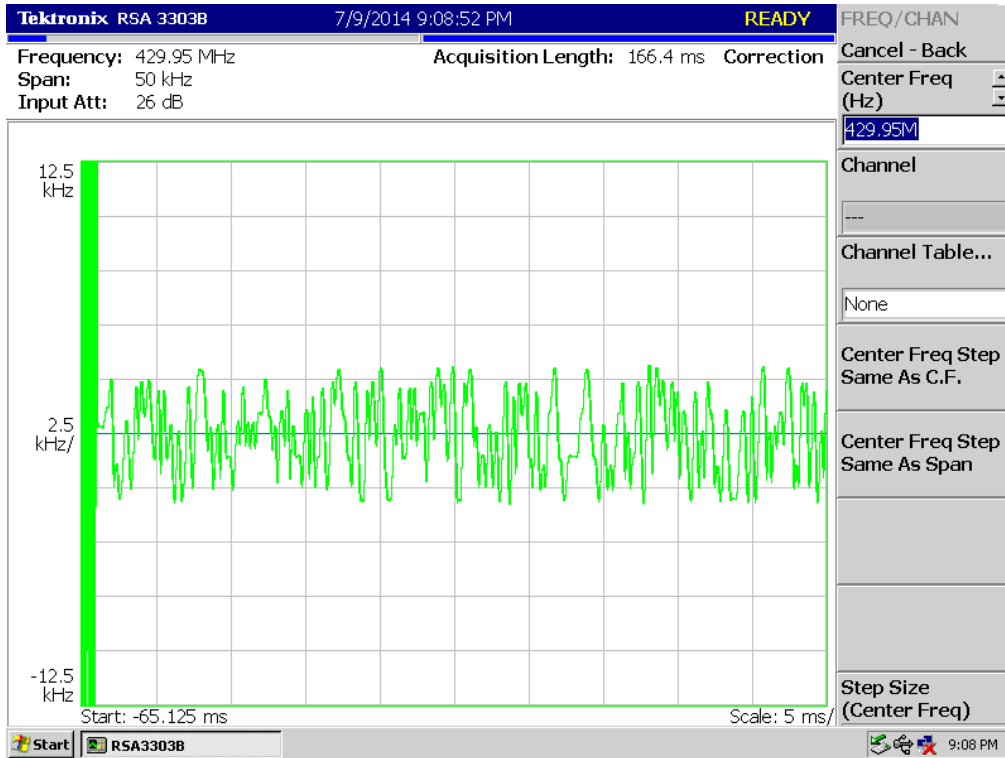

8K10F1W_469.95 MHz_HIGH POWER

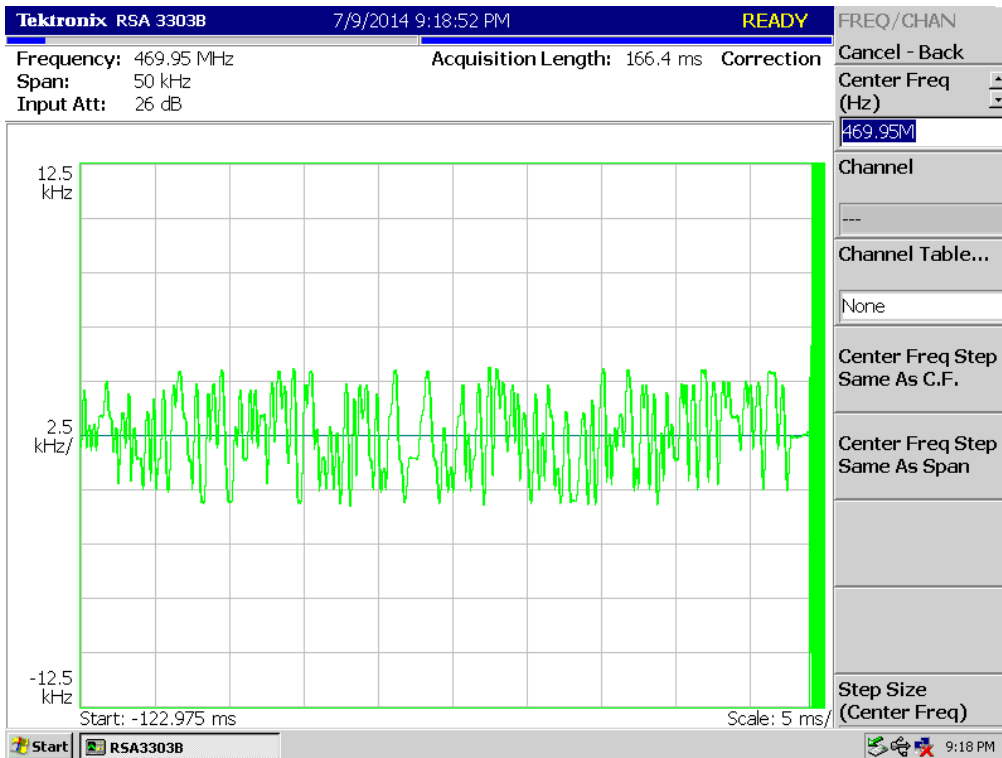
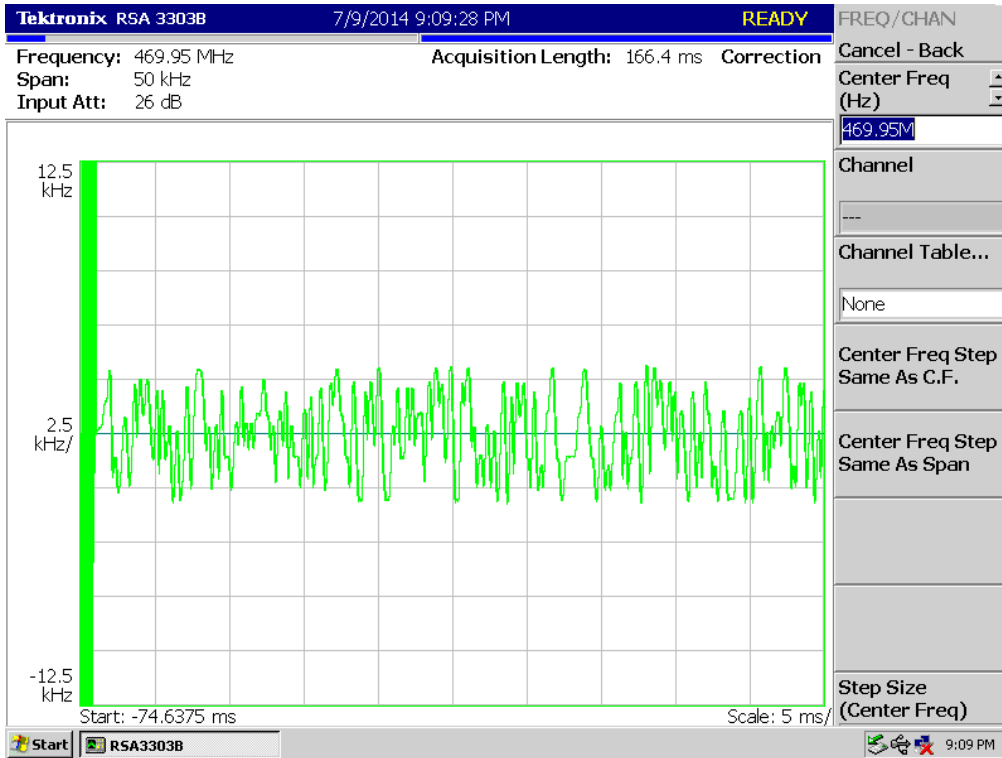

8K10F1W_406.15 MHz_LOW POWER

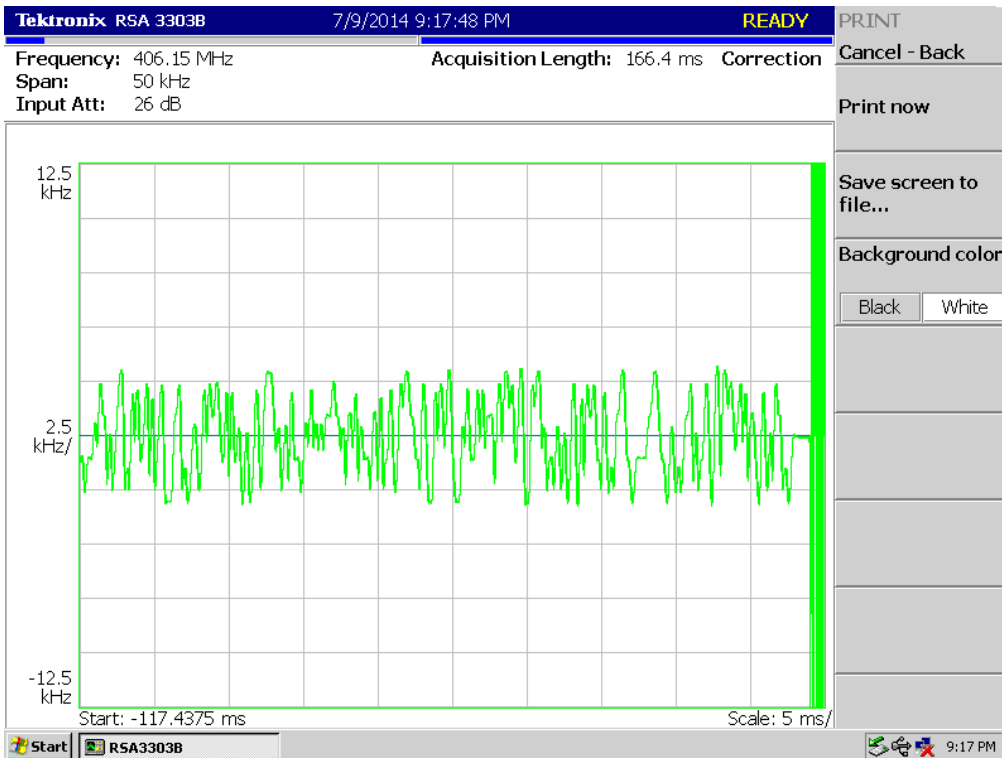
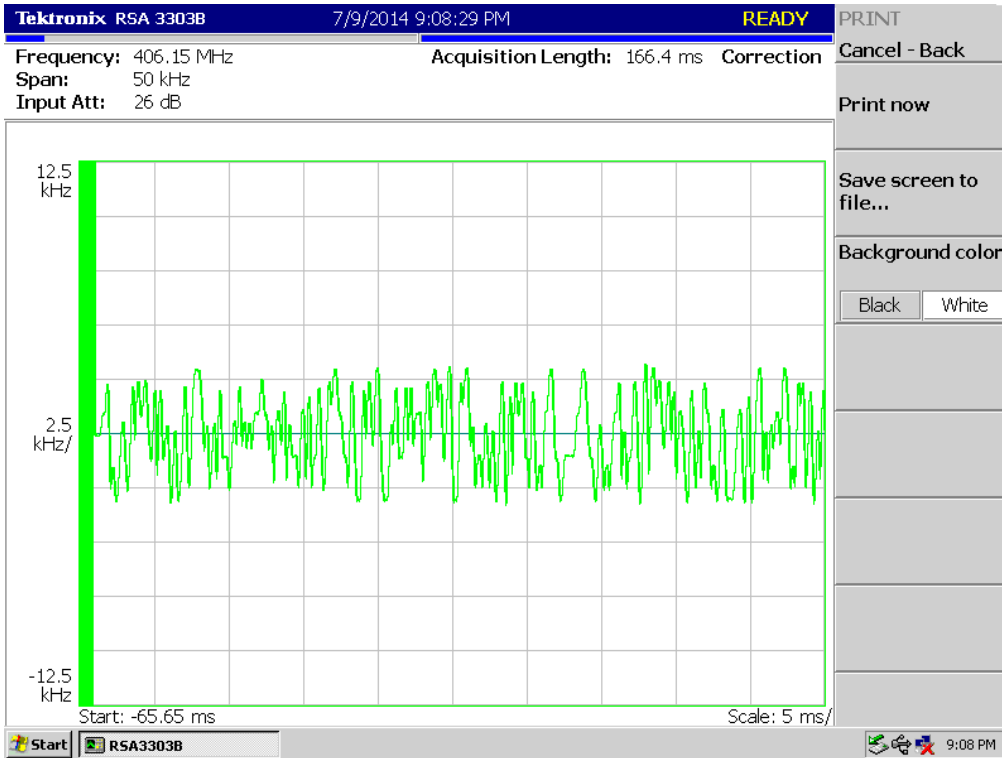

8K10F1W_429.95 MHz_LOW POWER

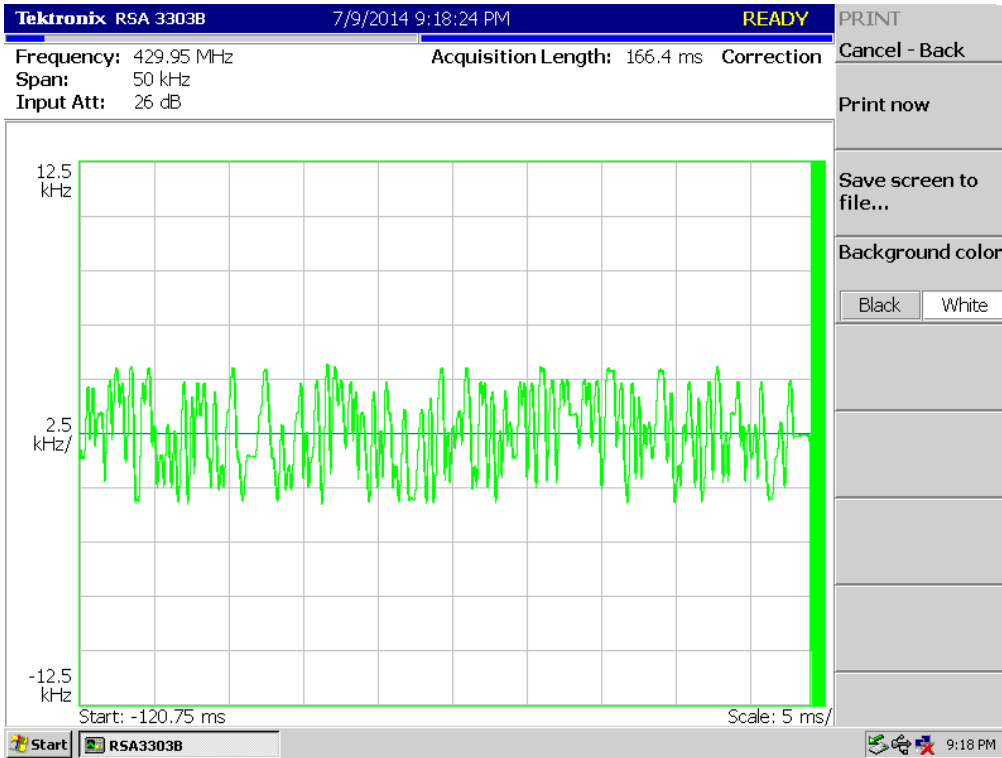
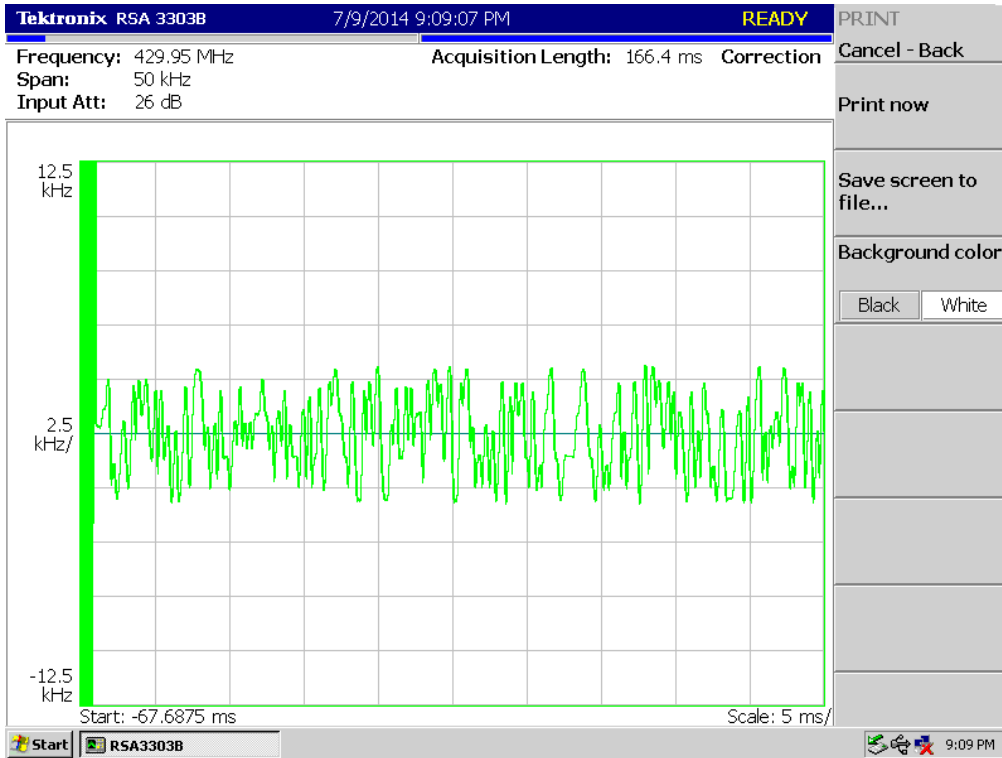

8K10F1W_469.95 MHz_LOW POWER

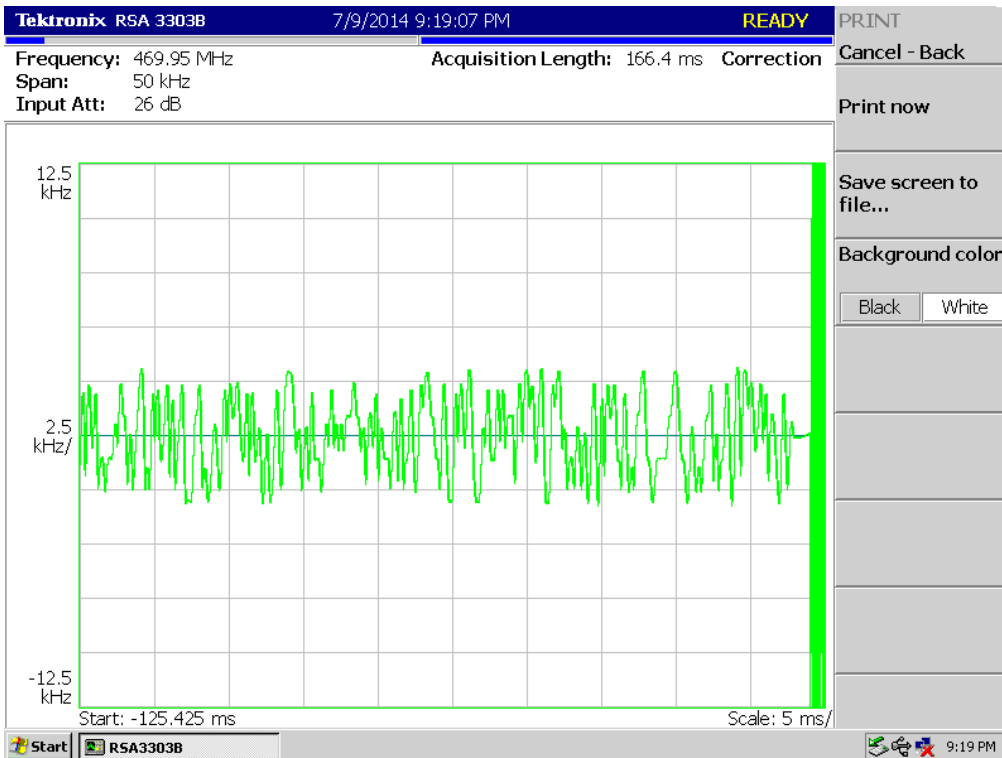
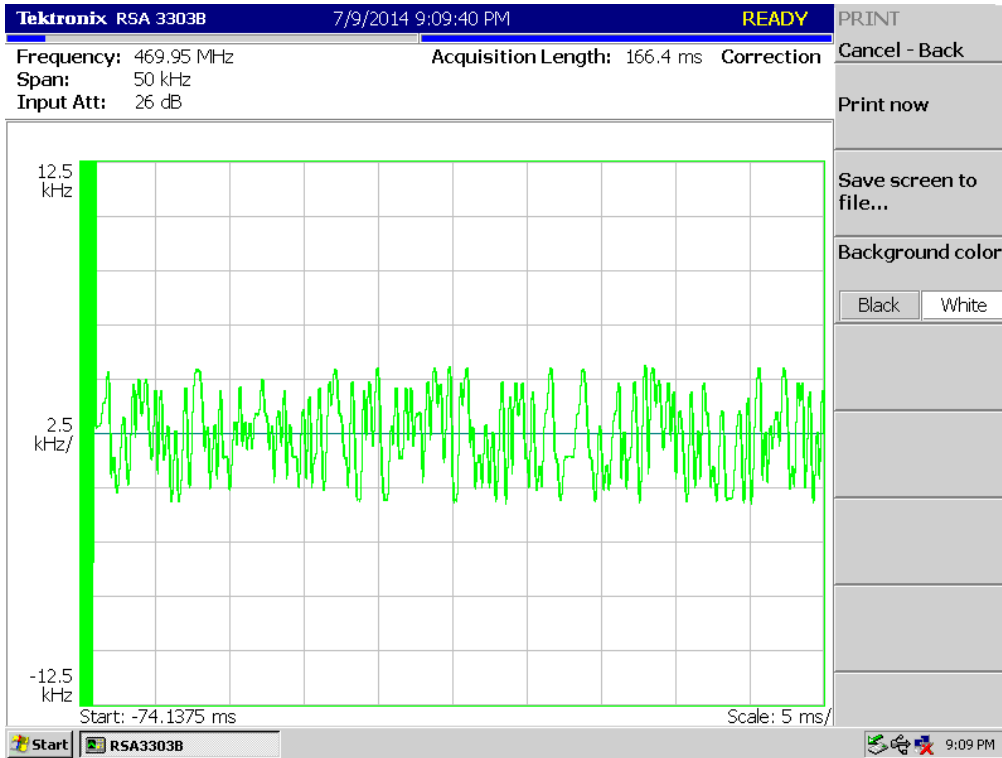

TEST RESULTS

8K10F1W for IC

8K10F1W_418.05 MHz_HIGH POWER

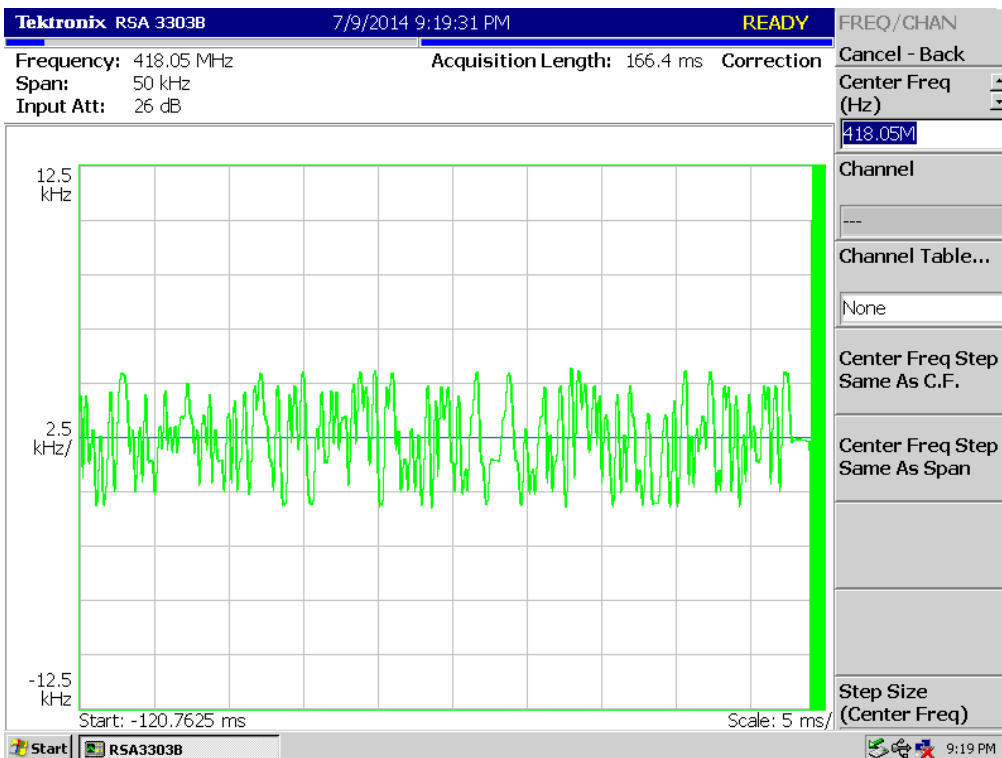
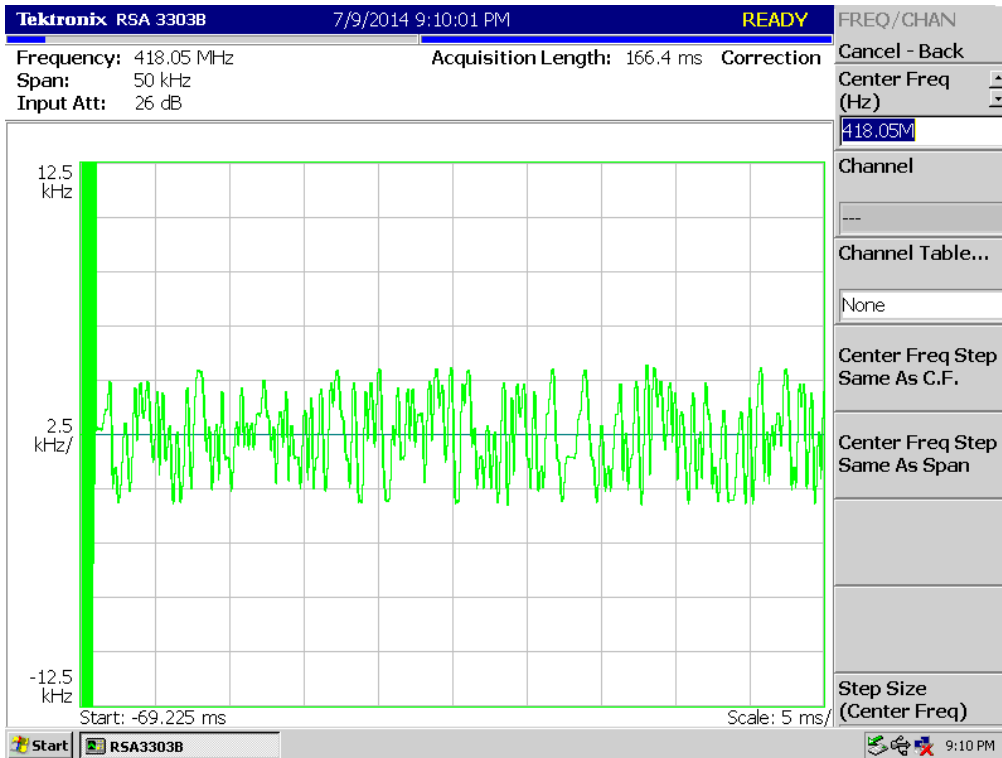

8K10F1W_450.05 MHz_HIGH POWER

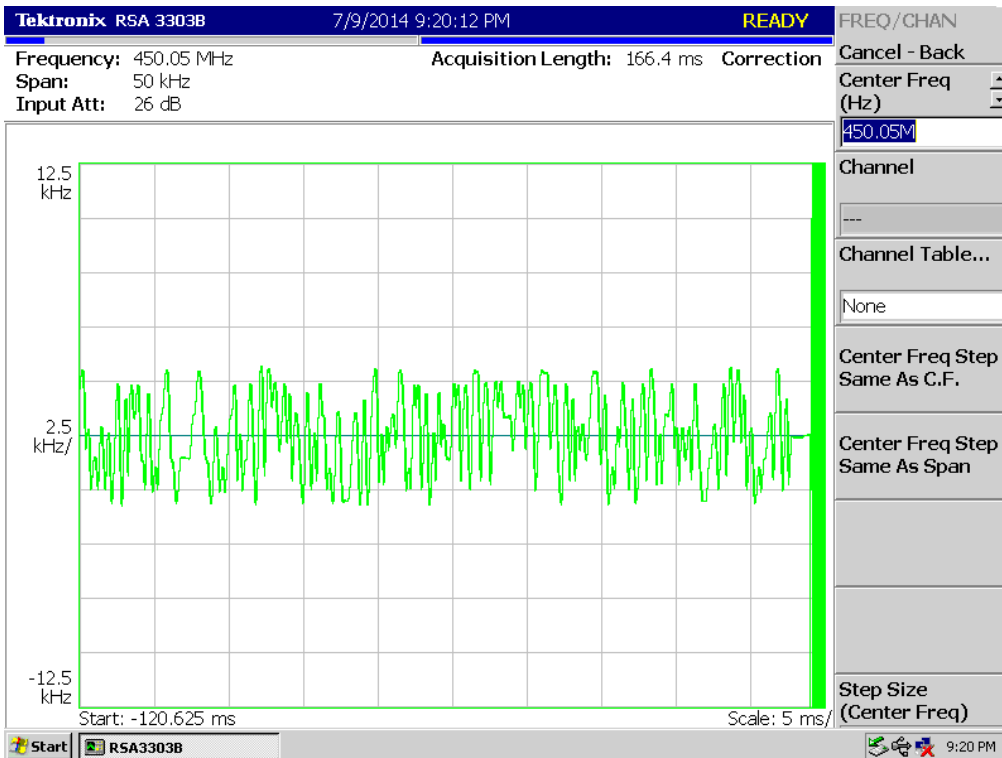
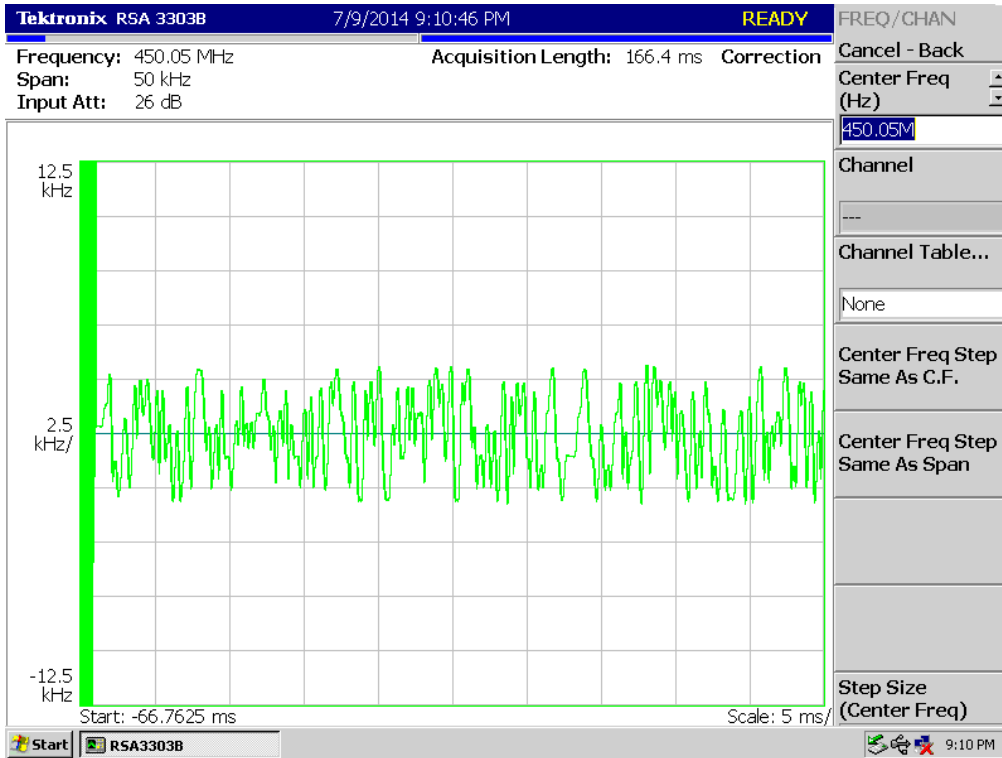

8K10F1W_460.05 MHz_HIGH POWER

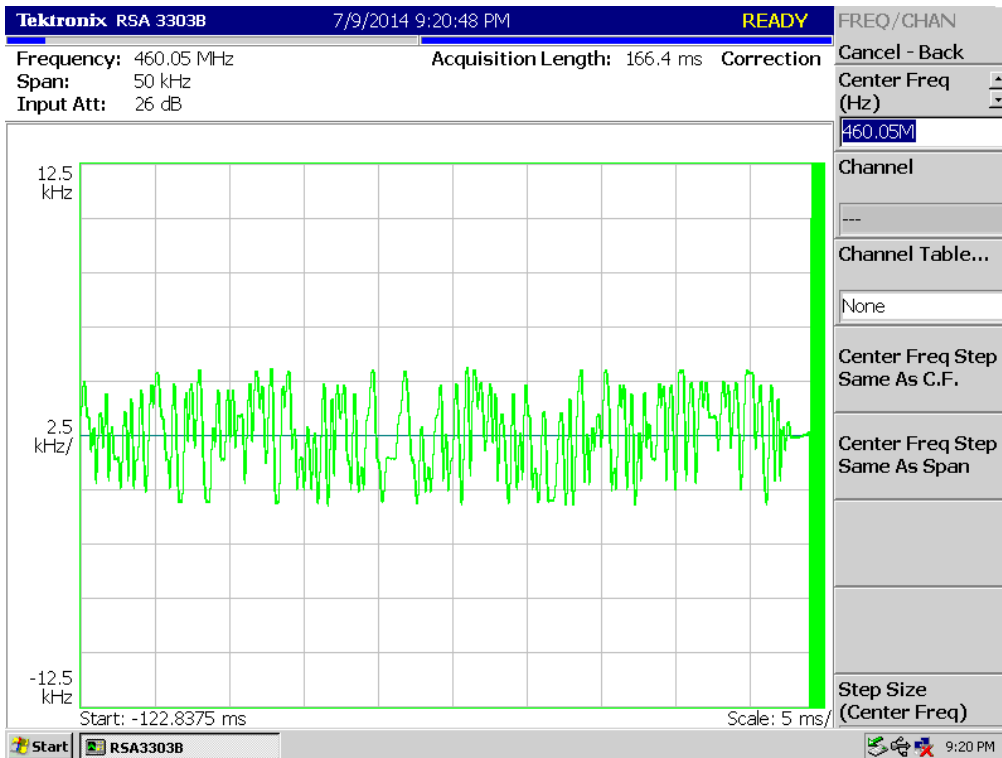
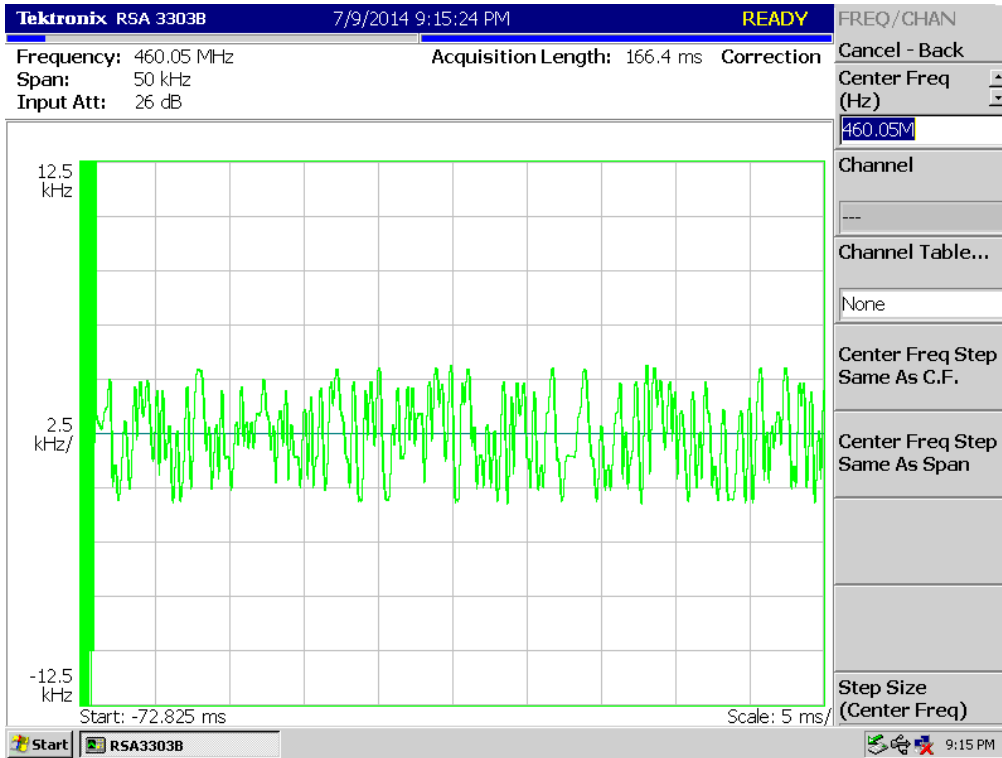

8K10F1W_418.05 MHz_LOW POWER

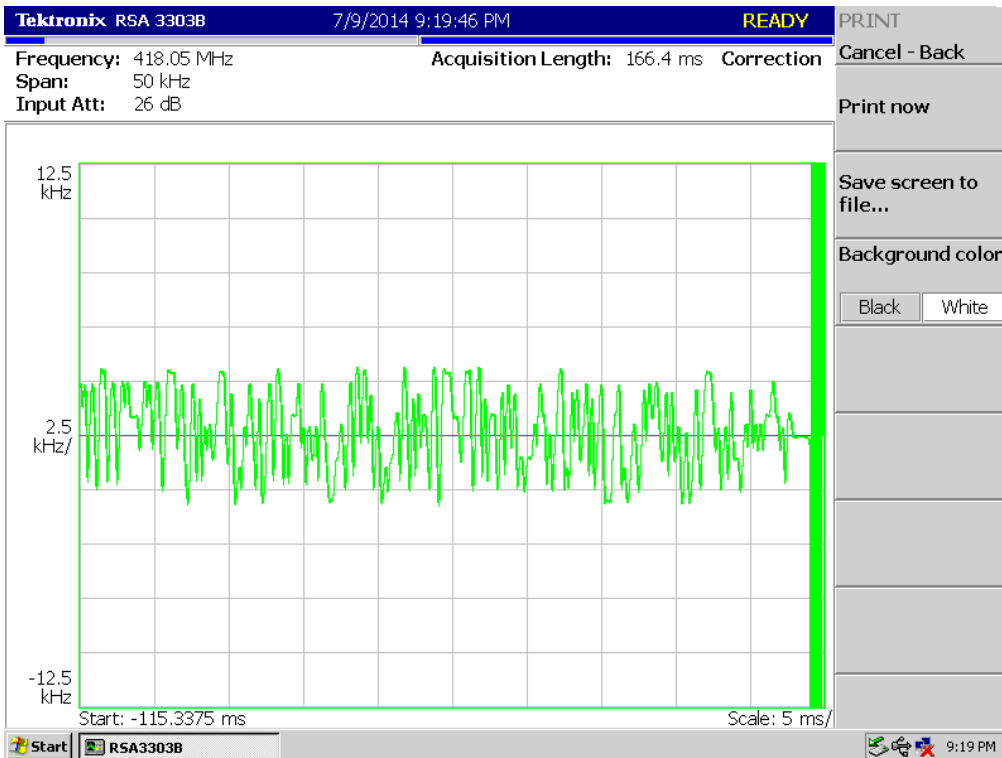
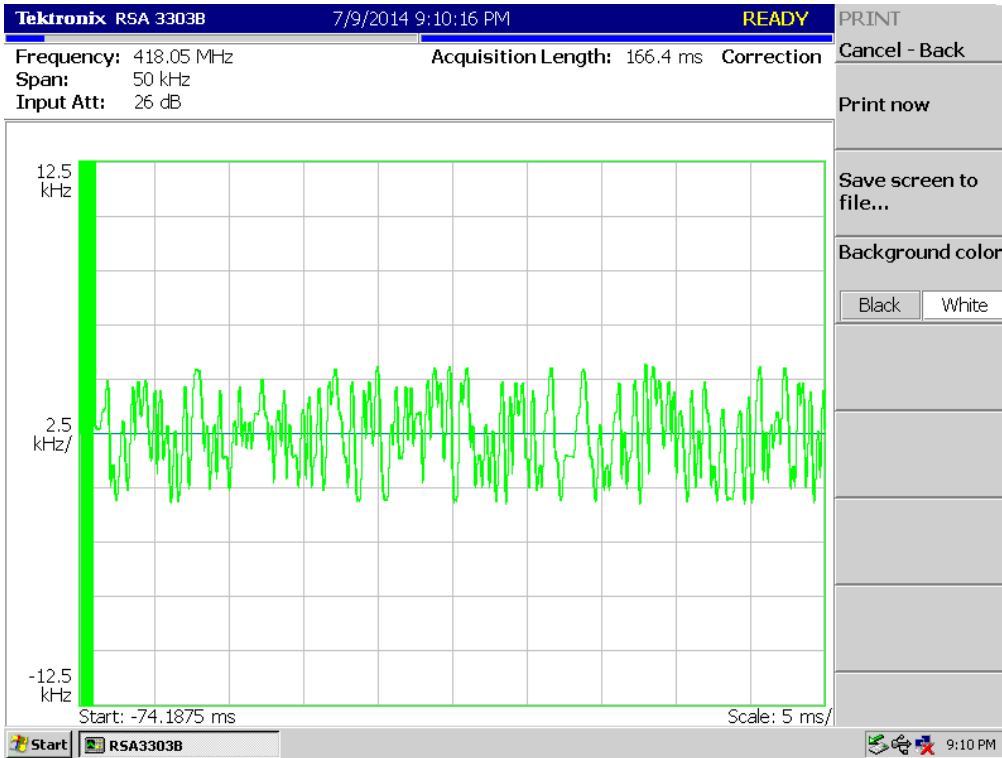

8K10F1W_450.05 MHz_LOW POWER

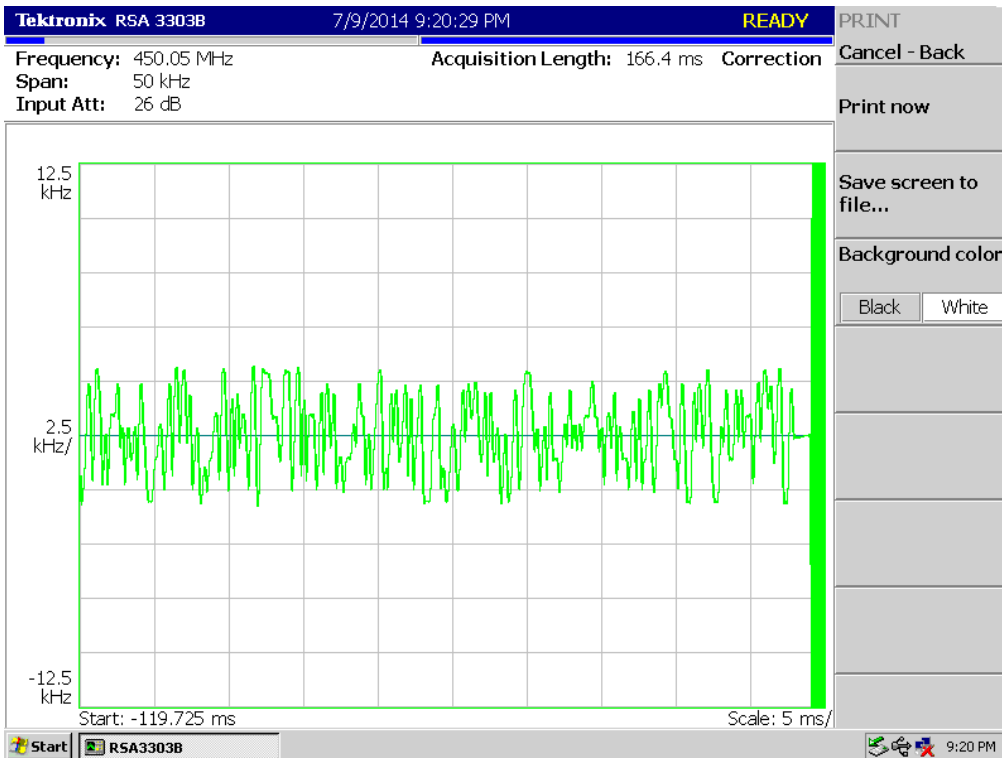
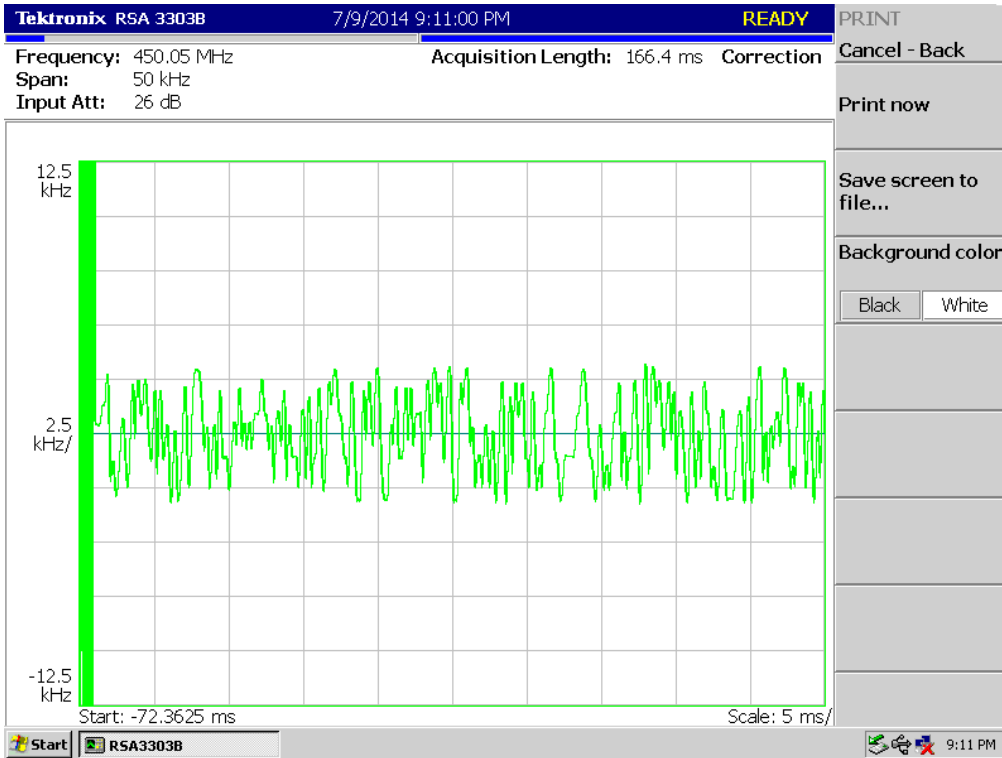

8K10F1W_460.05 MHz_LOW POWER

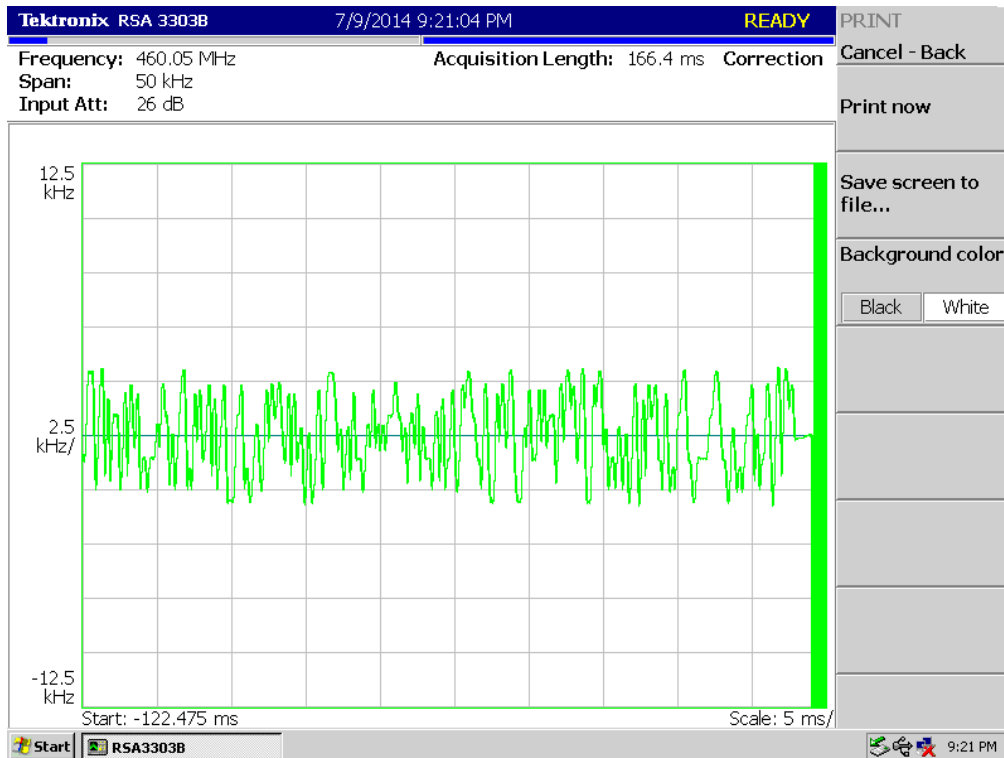
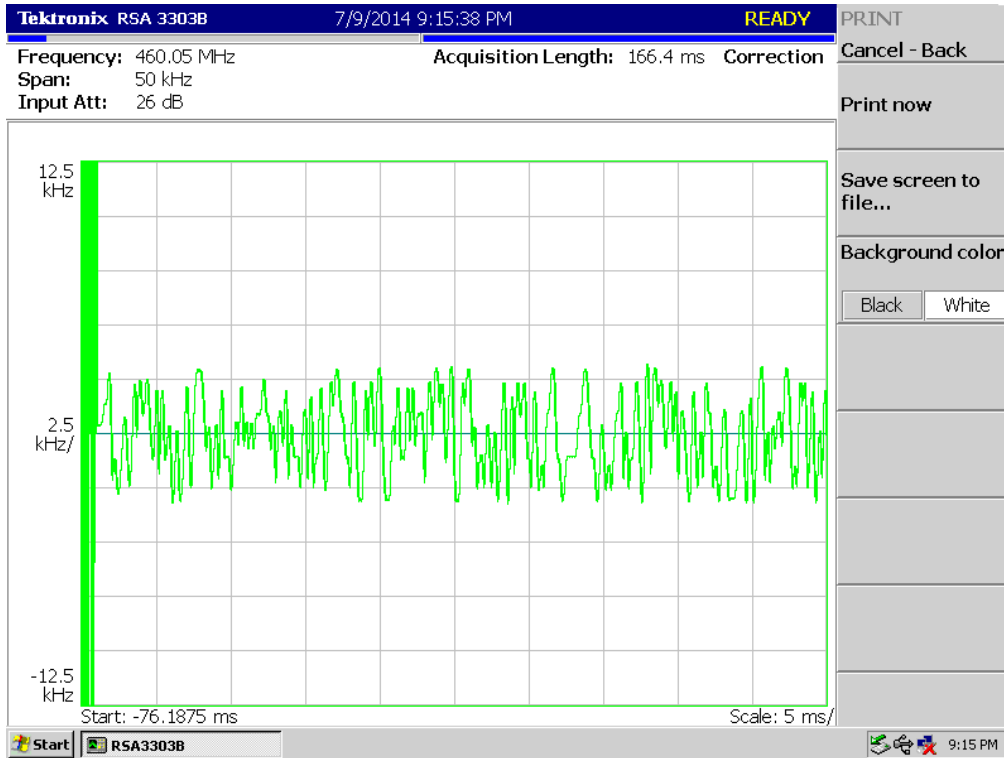

TEST RESULTS

8K30F1E, 8K30F1D, 8K30F7W for FCC

8K30F1E, 8K30F1D, 8K30F7W_406.15 MHz_HIGH POWER

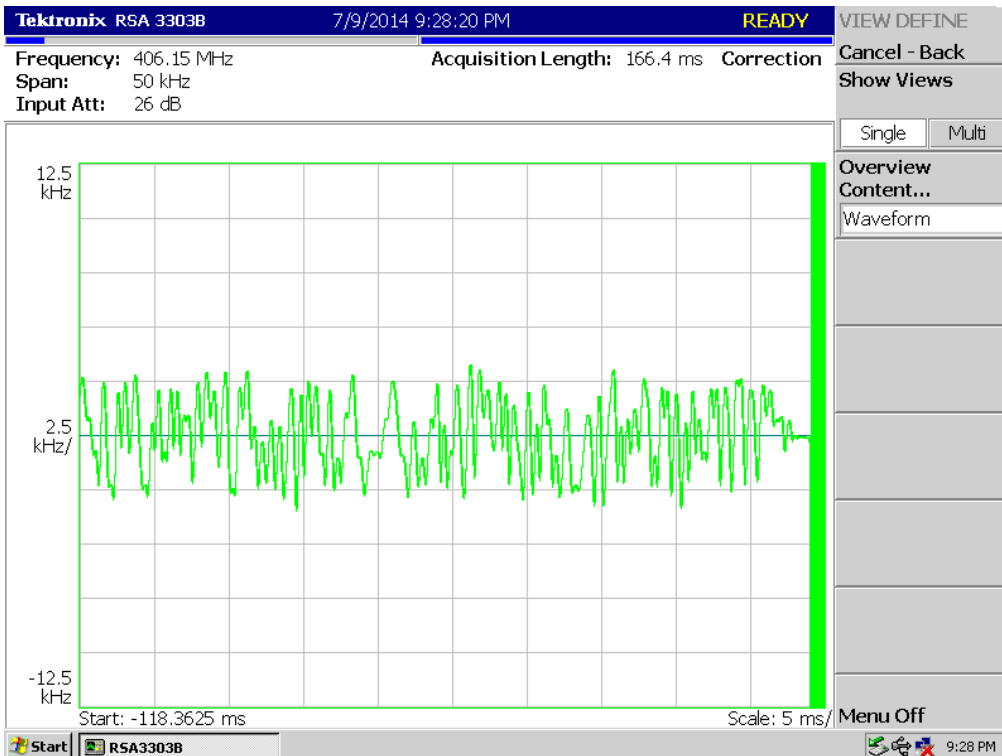
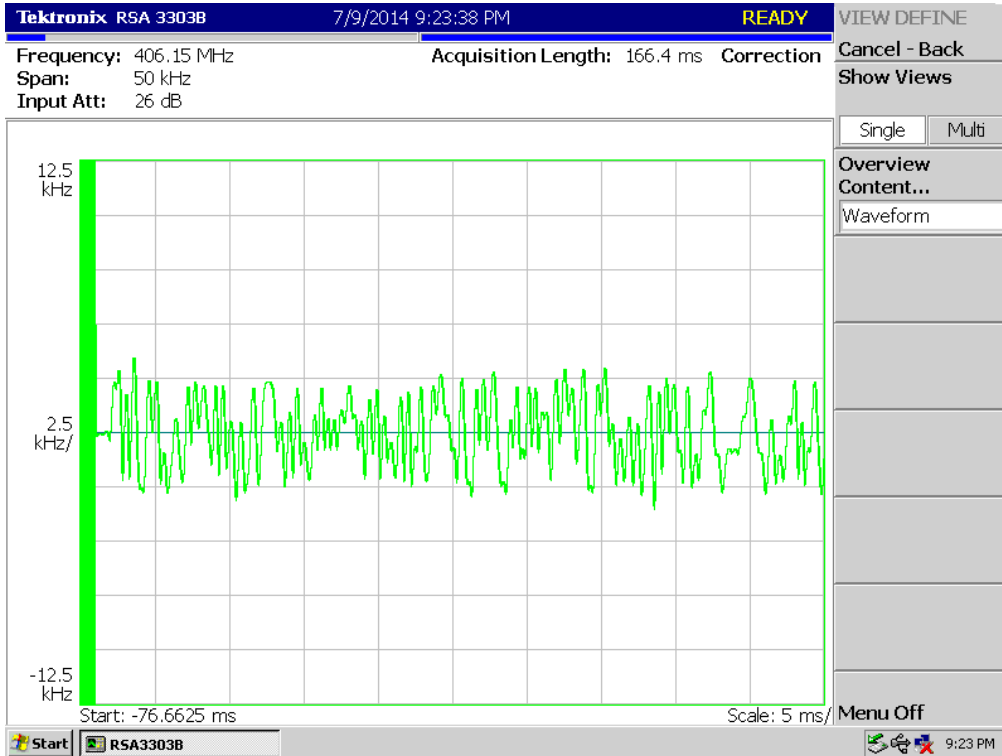

8K30F1E, 8K30F1D, 8K30F7W_429.95 MHz_HIGH POWER

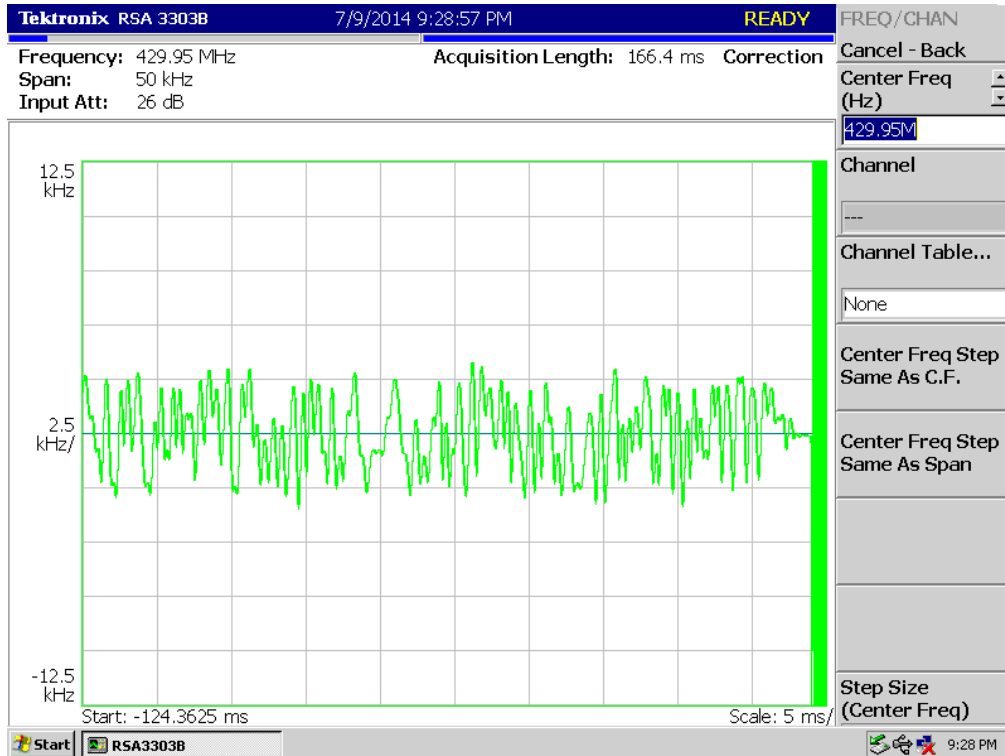
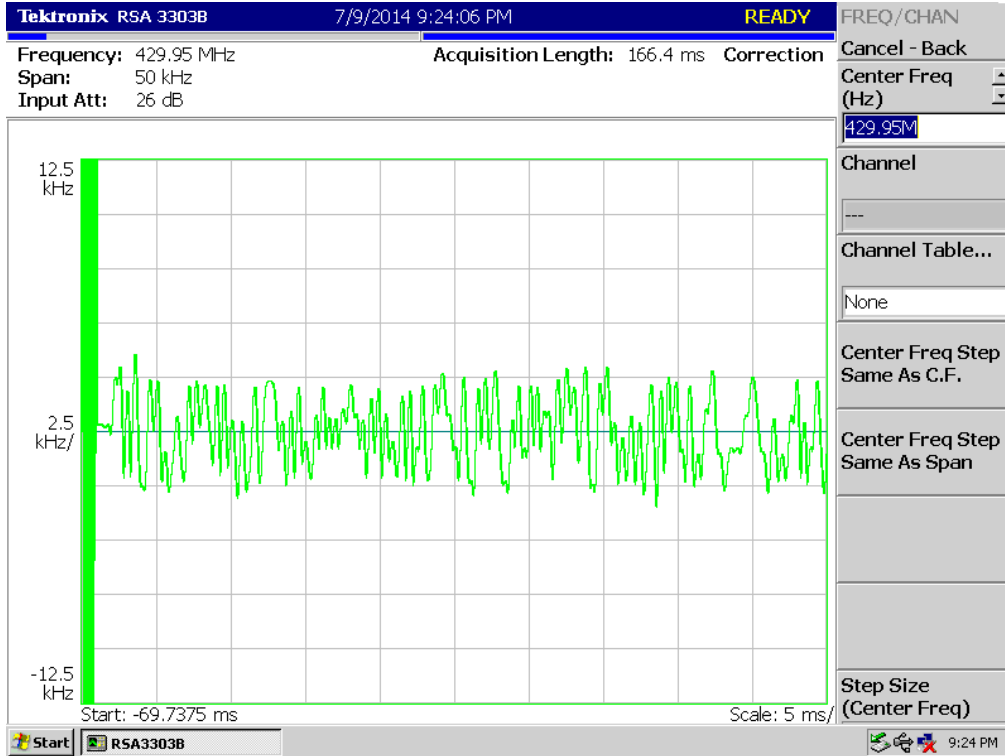

8K30F1E, 8K30F1D, 8K30F7W_469.95 MHz_HIGH POWER

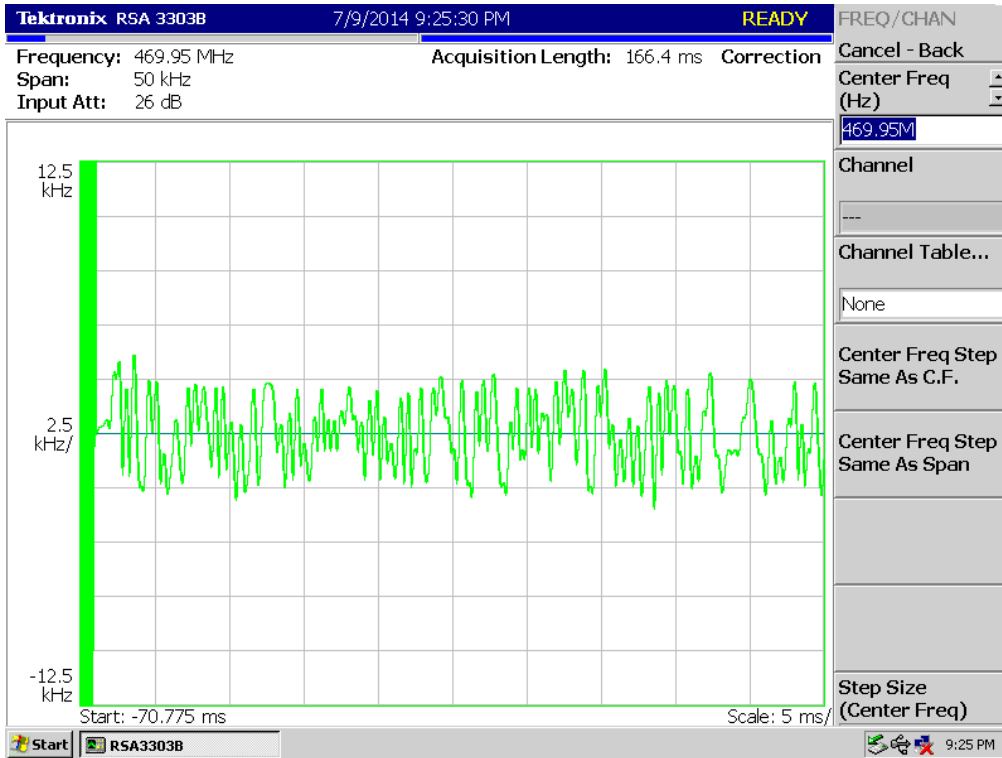

8K30F1E, 8K30F1D, 8K30F7W_406.15 MHz_LOW POWER

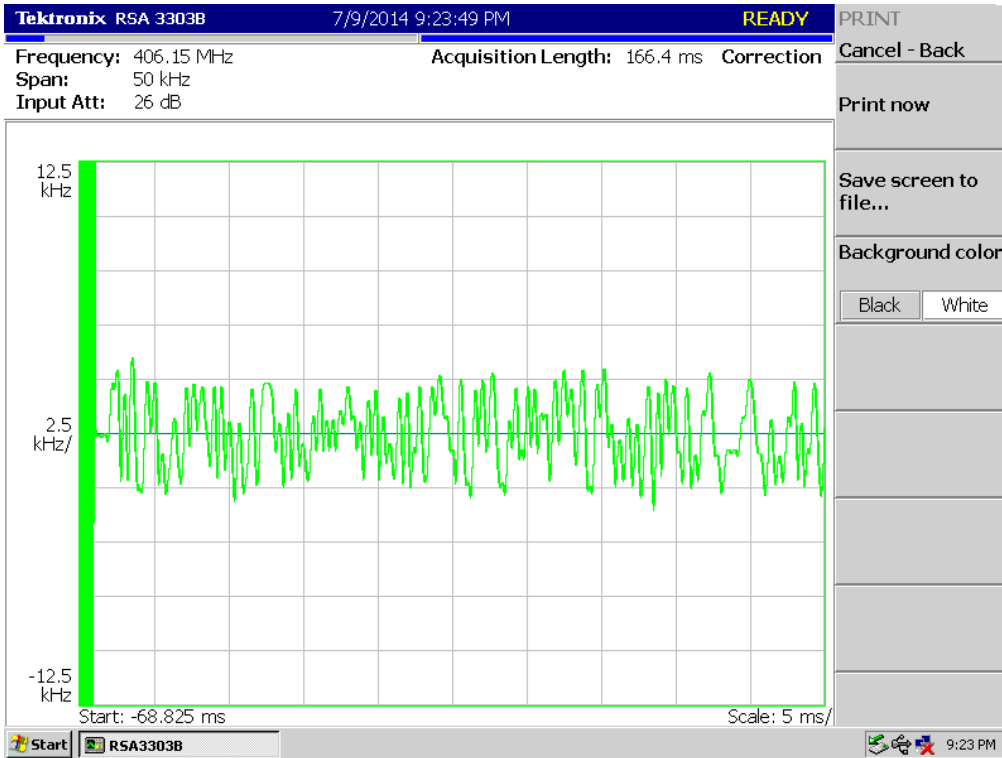

8K30F1E, 8K30F1D, 8K30F7W_429.95 MHz_LOW POWER

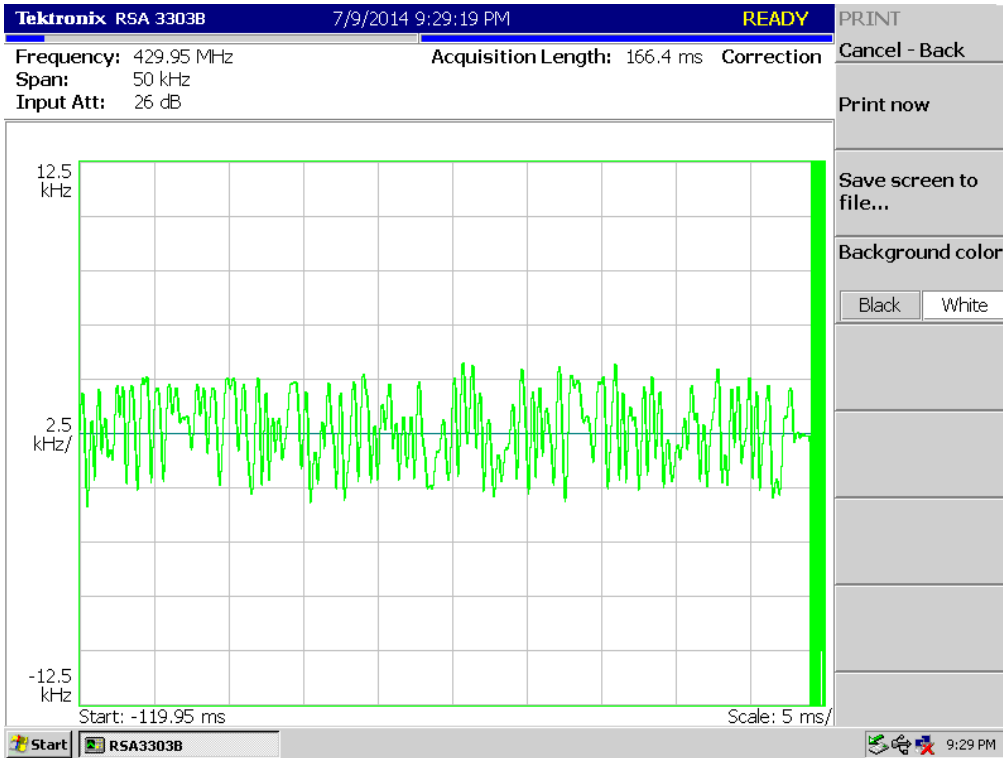
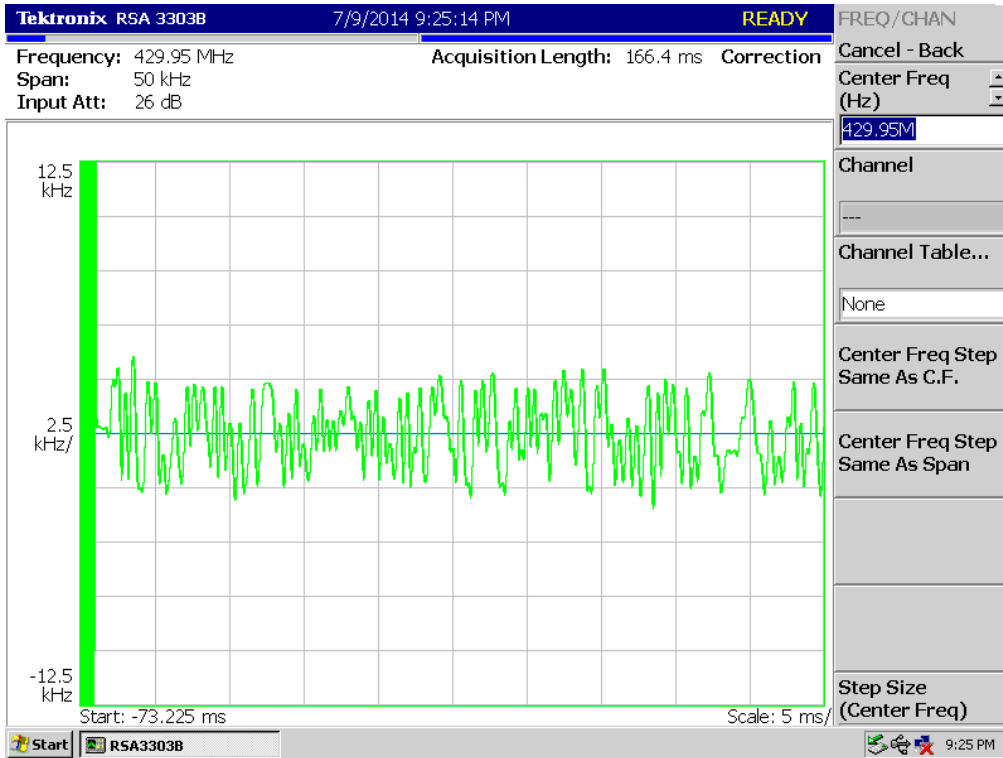

8K30F1E, 8K30F1D, 8K30F7W_469.95 MHz_LOW POWER

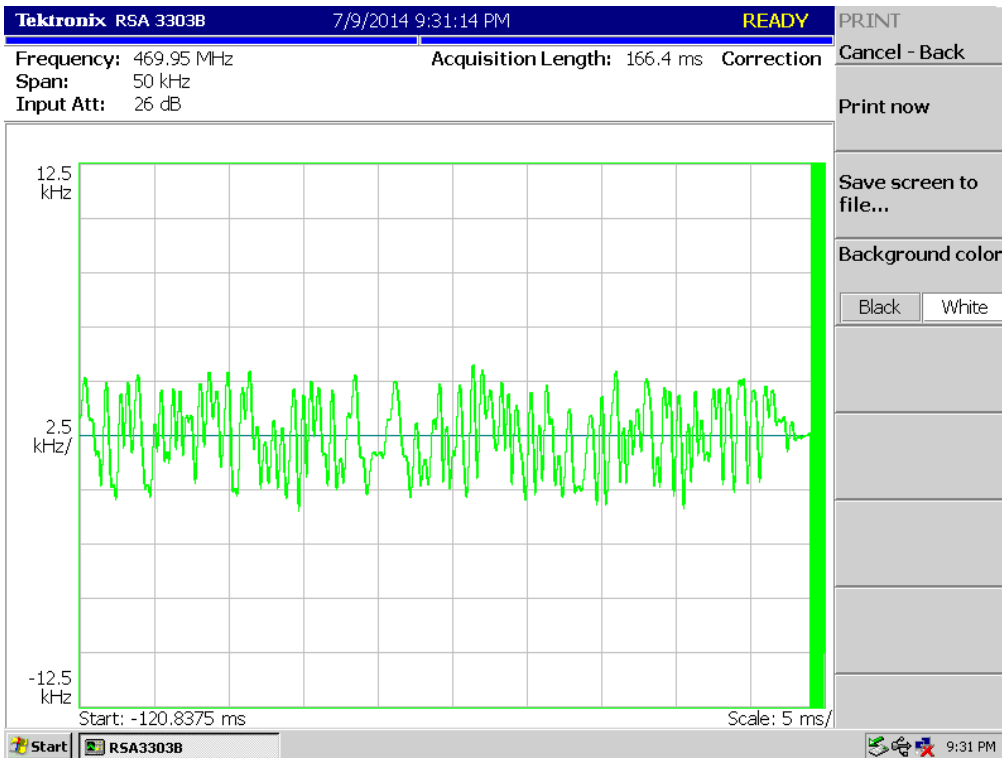
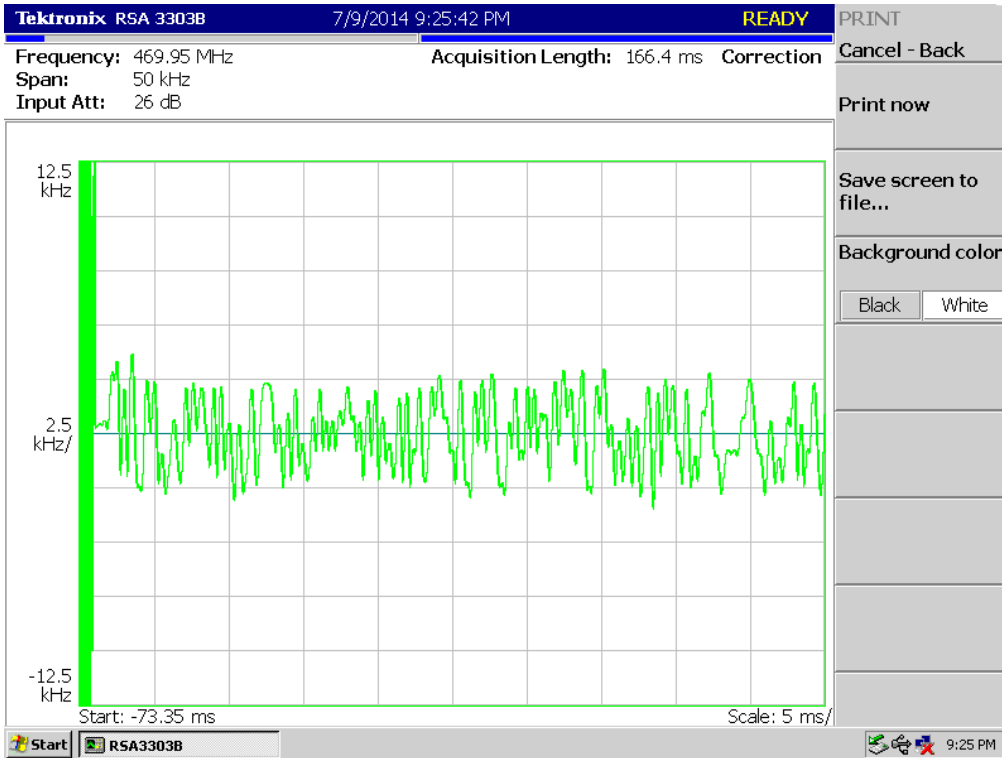

TEST RESULTS

8K10F1W for IC

8K30F1E, 8K30F1D, 8K30F7W_418.05 MHz_HIGH POWER

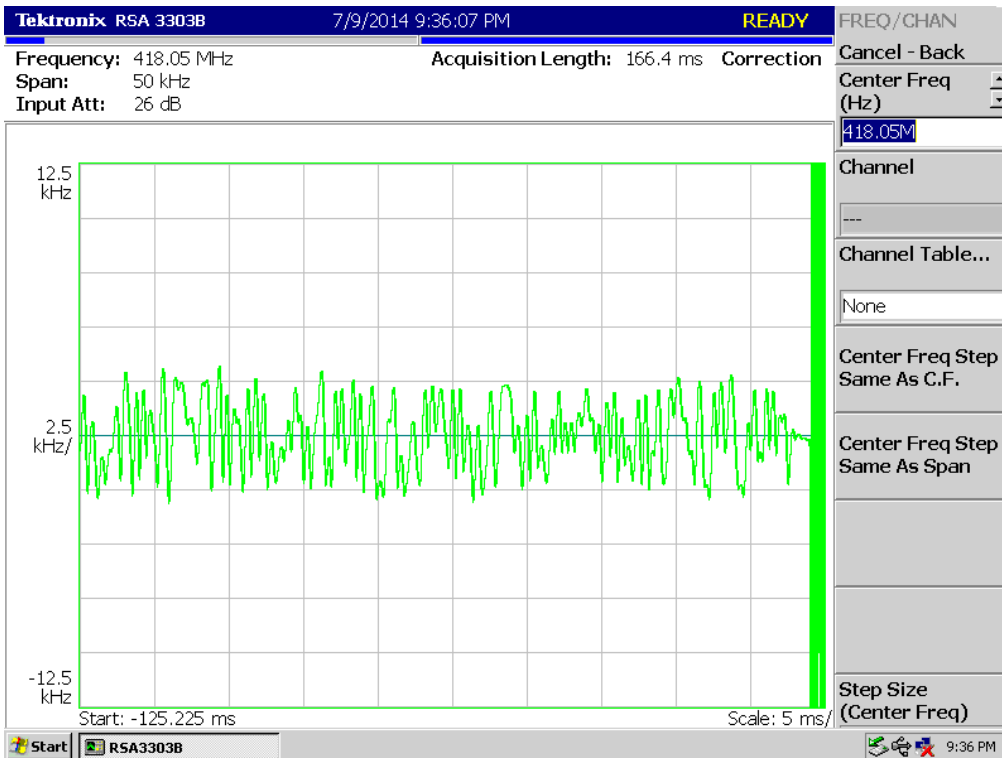
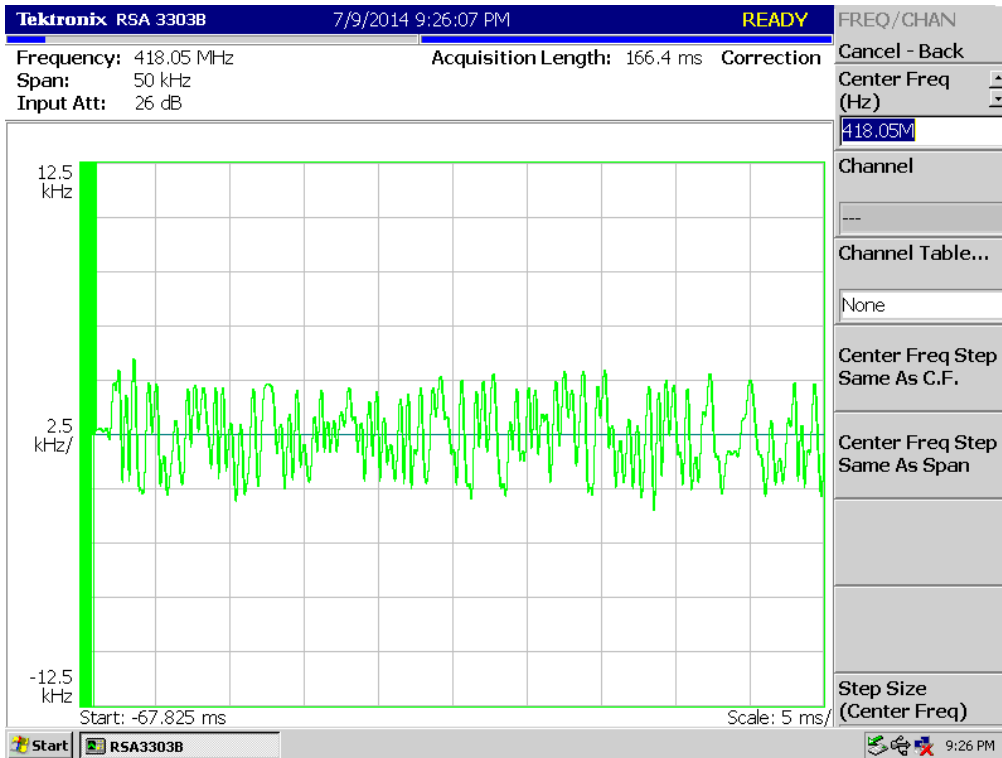

8K30F1E, 8K30F1D, 8K30F7W _450.05 MHz_HIGH POWER

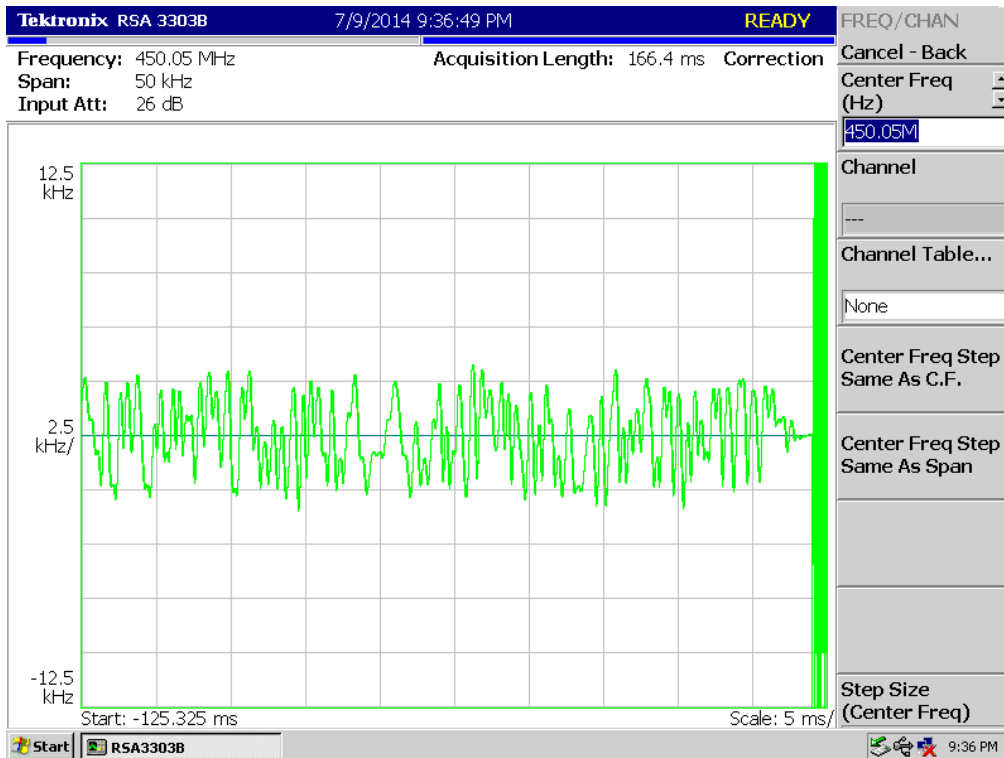
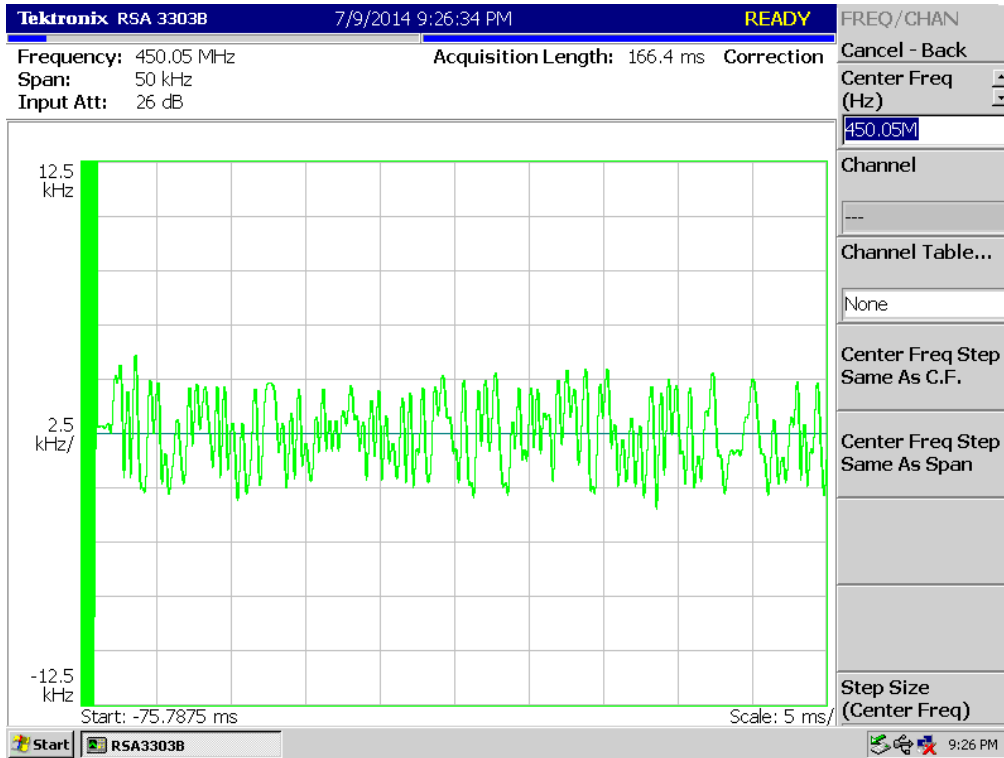

8K30F1E, 8K30F1D, 8K30F7W_460.05 MHz_HIGH POWER

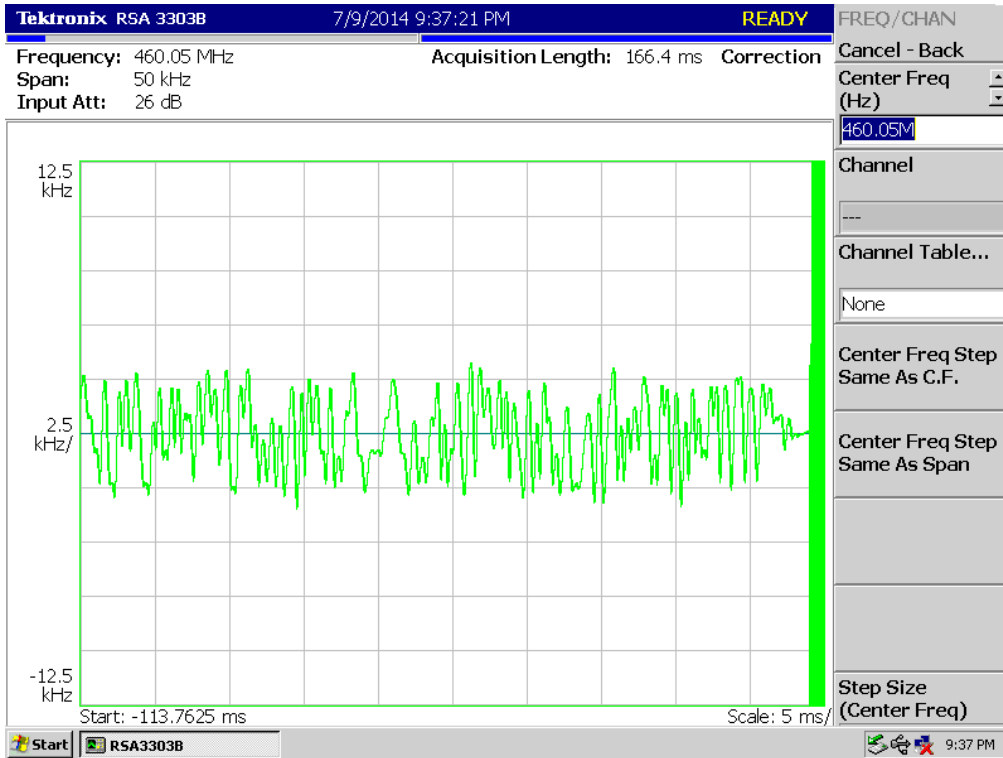
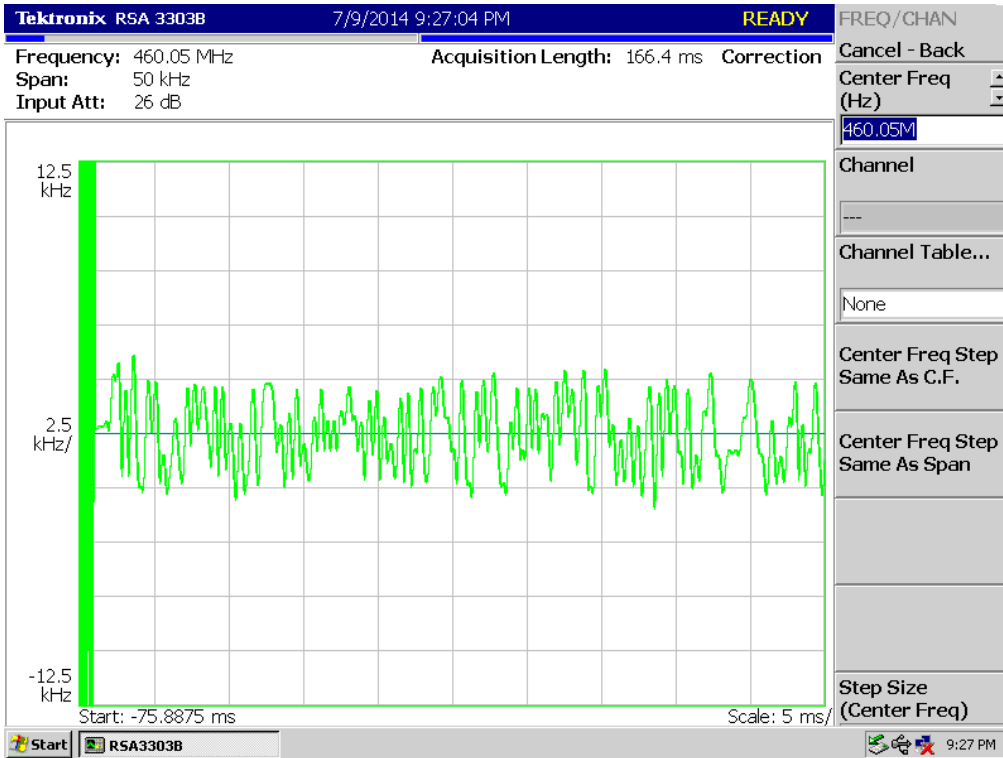

8K30F1E, 8K30F1D, 8K30F7W _418.05 MHz_LOW POWER

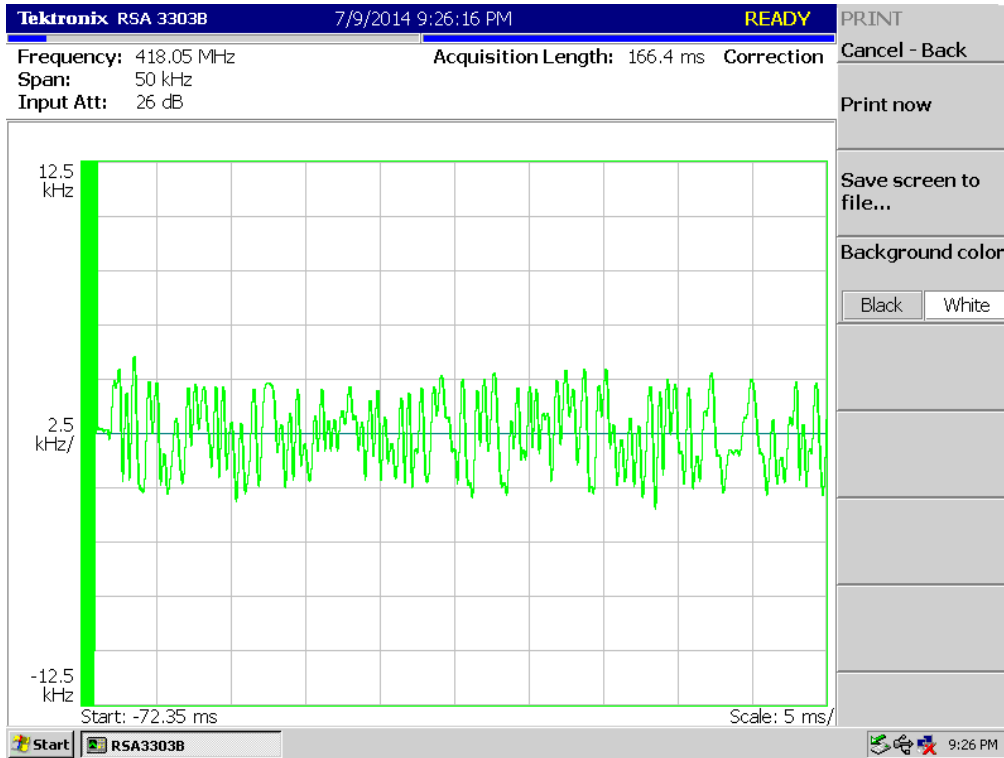

Cancel - Back

Print now

Save screen to file...

Background color

Black White

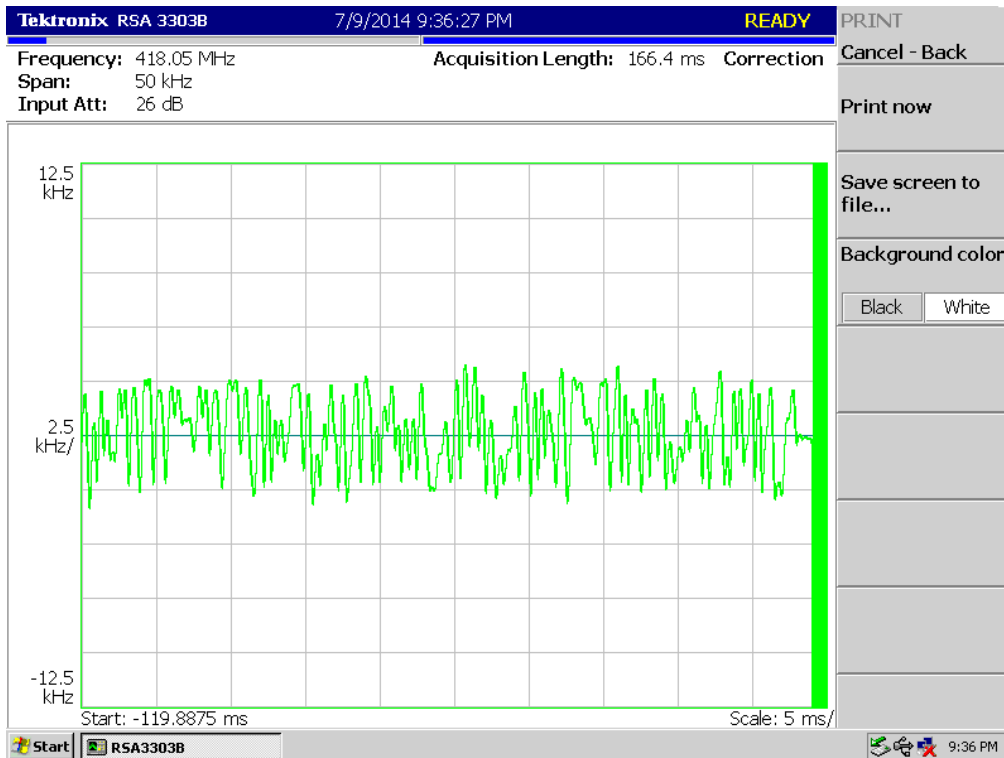

Cancel - Back

Print now

Save screen to file...

Background color

Black White

8K30F1E, 8K30F1D, 8K30F7W _450.05 MHz_LOW POWER

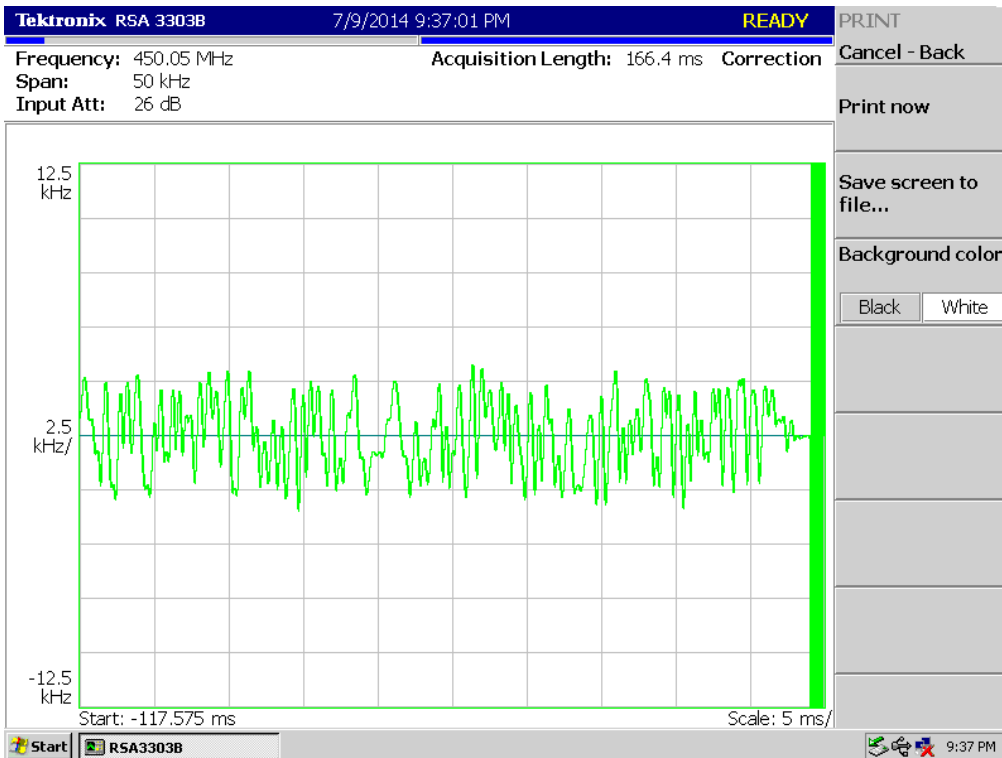
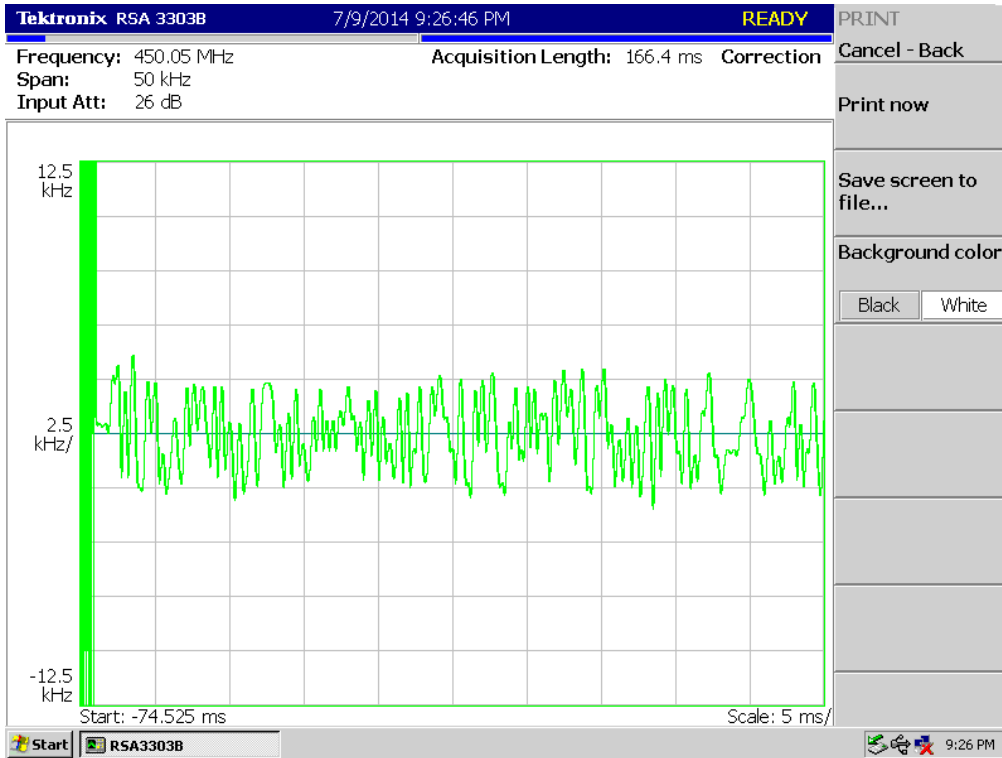

8K30F1E, 8K30F1D, 8K30F7W _460.05 MHz_LOW POWER

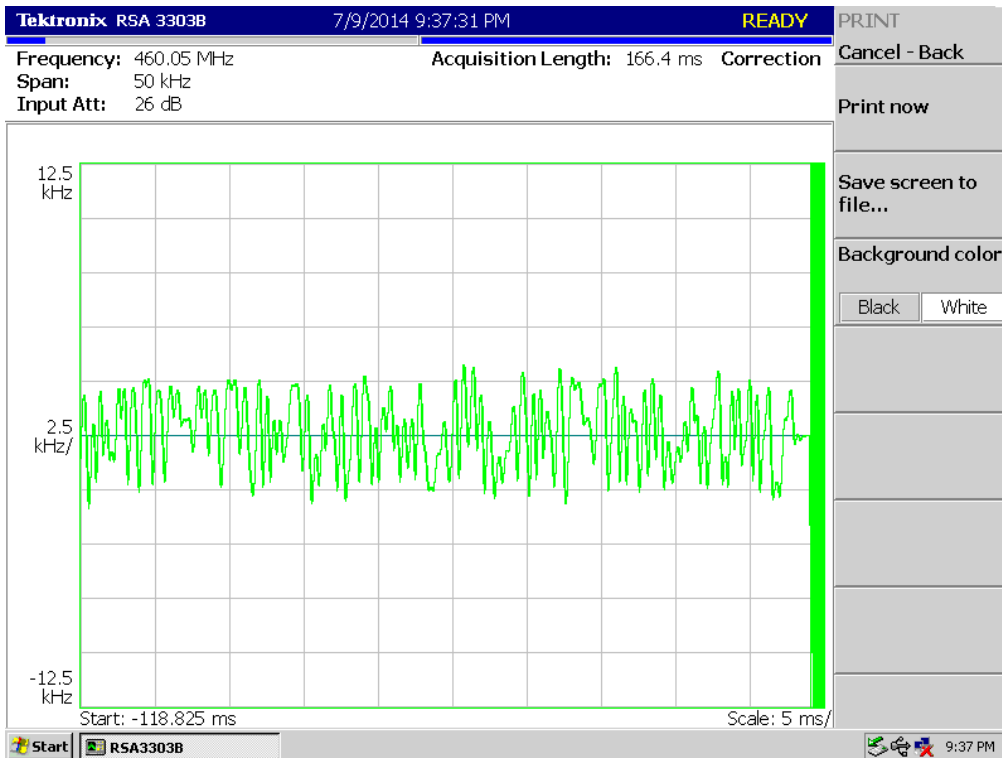
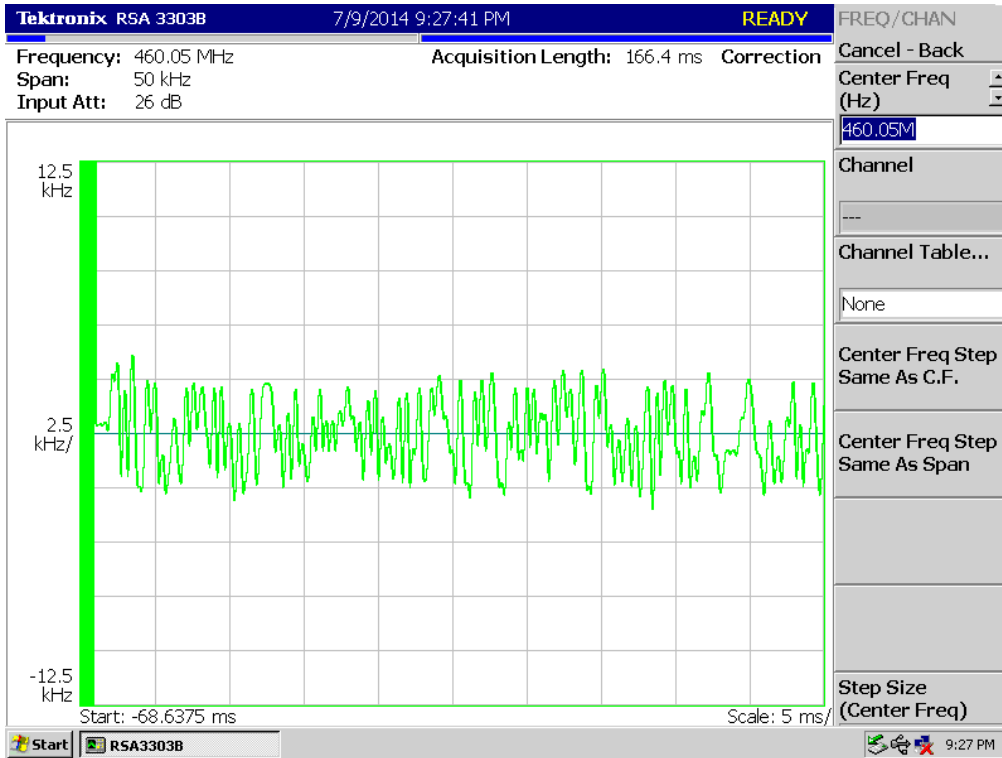

TEST RESULTS

11K0F3E for FCC

11K0F3E_406.15 MHz_HIGH POWER

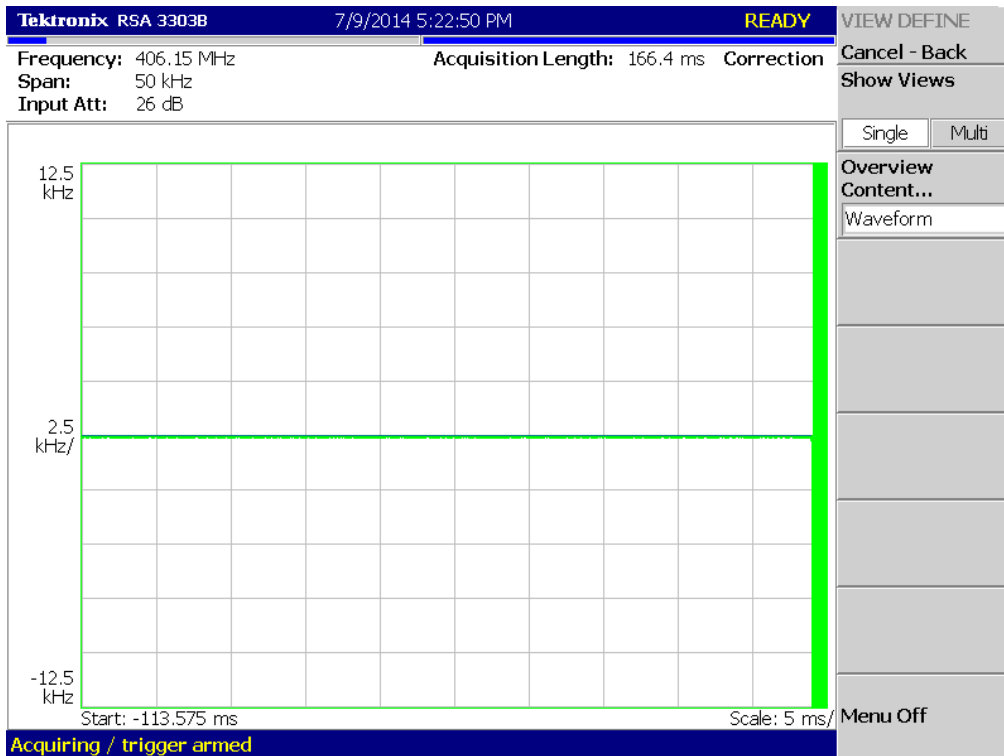
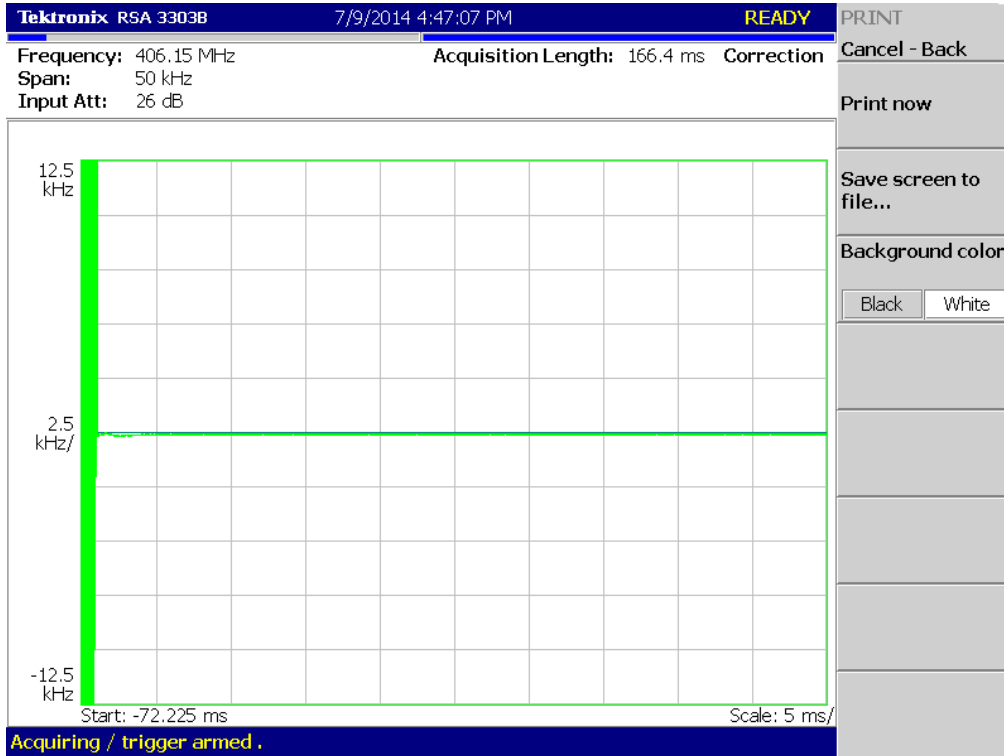

11K0F3E_429.95 MHz_HIGH POWER

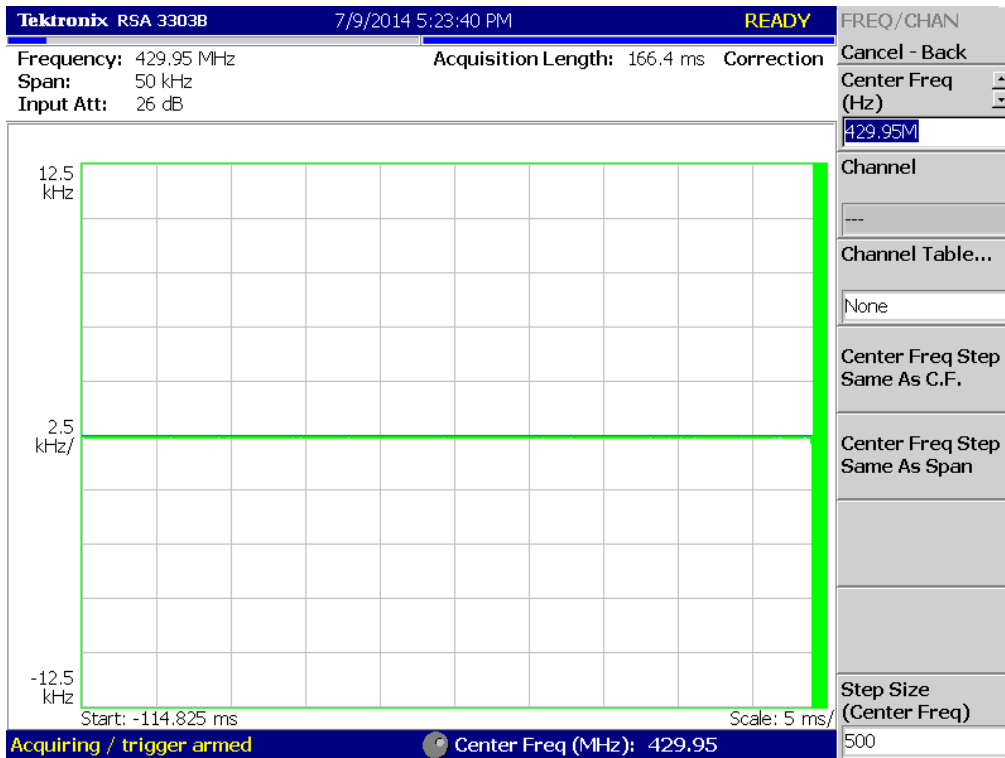
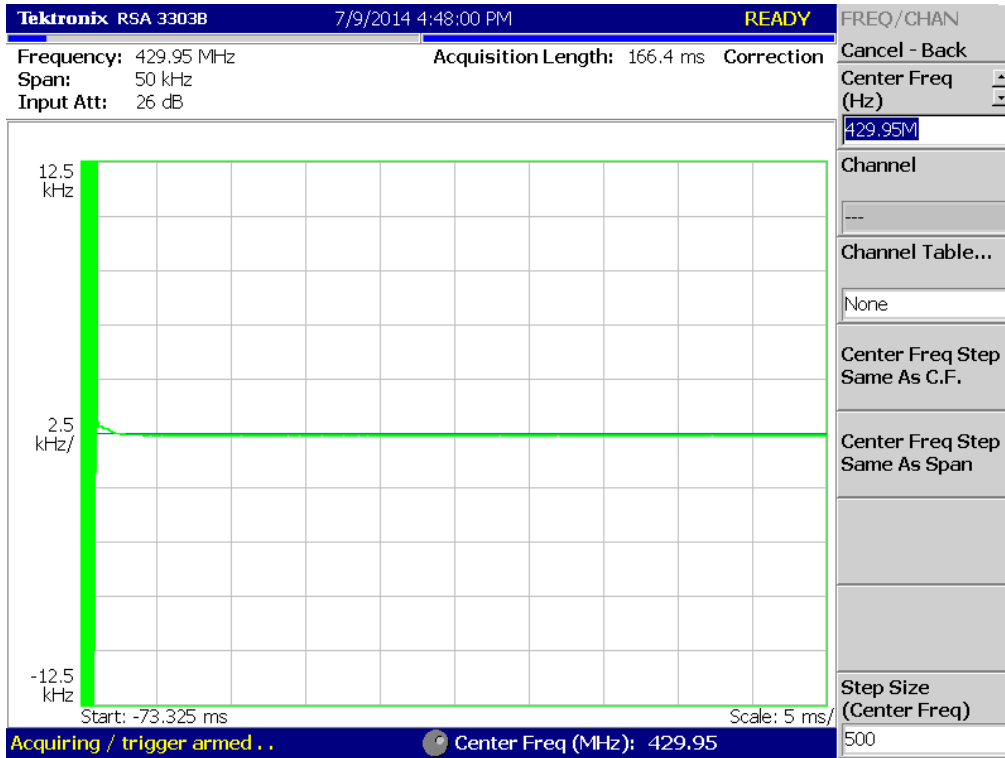

11K0F3E_469.95 MHz_HIGH POWER

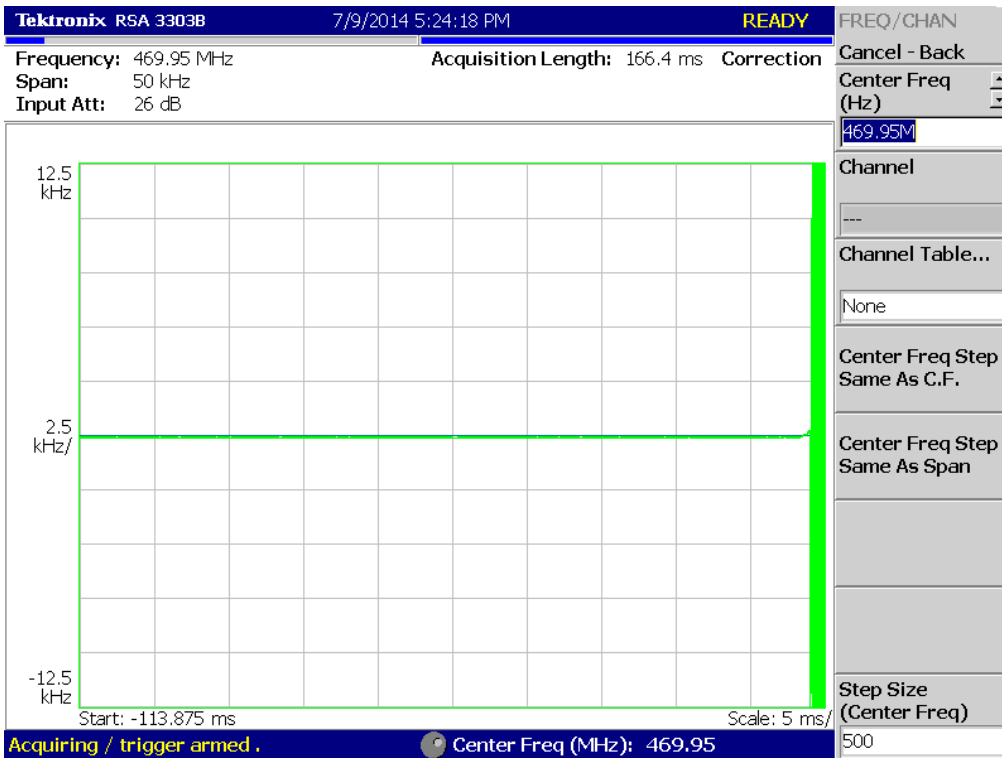
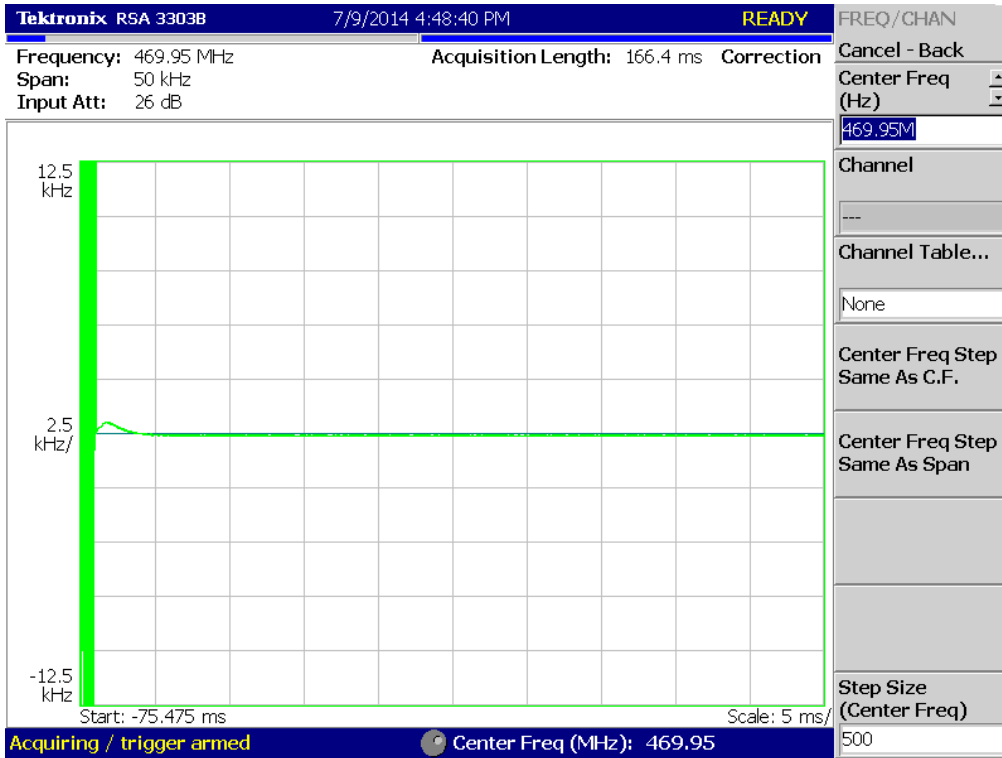

11K0F3E_406.15 MHz_LOW POWER

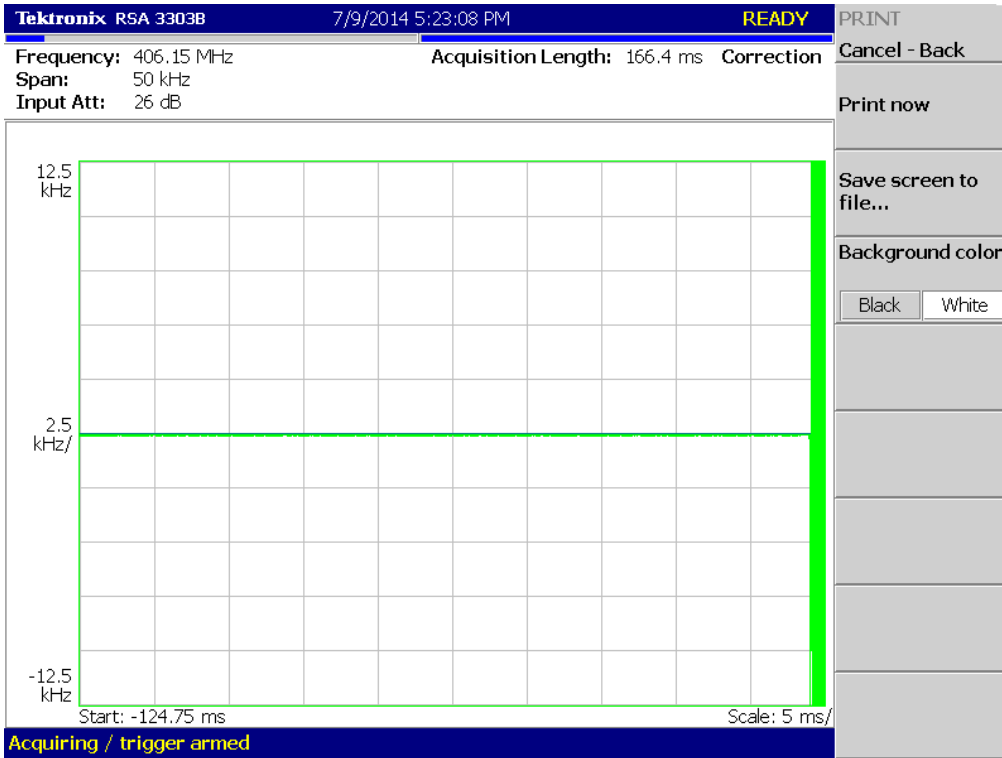
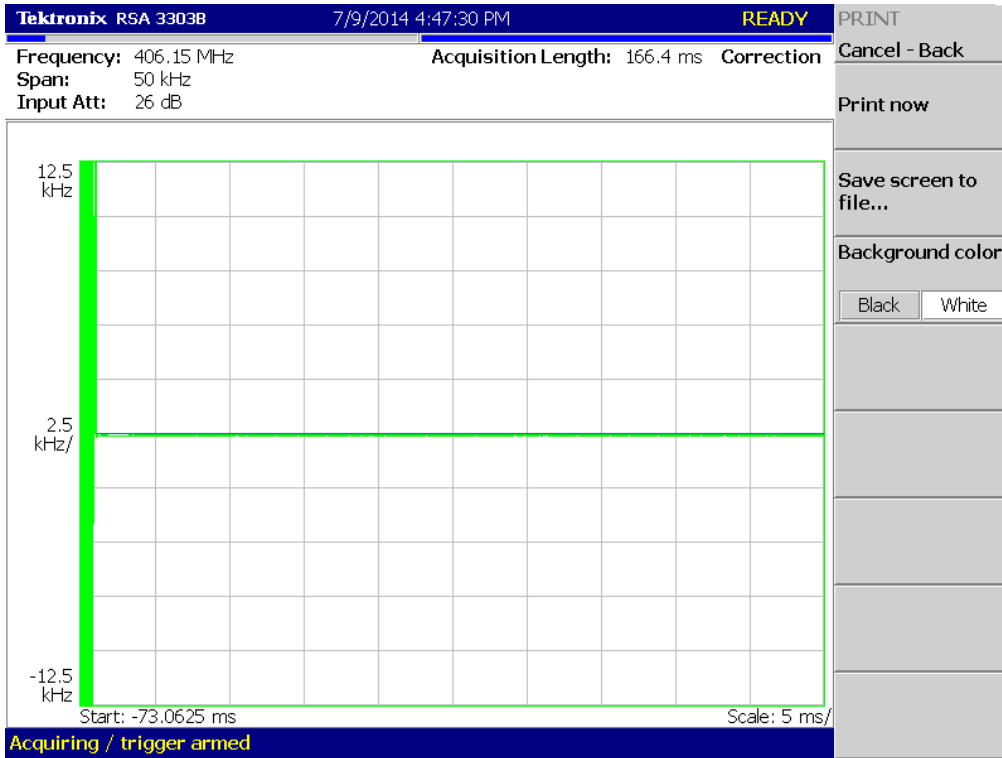

11K0F3E_429.95 MHz_LOW POWER

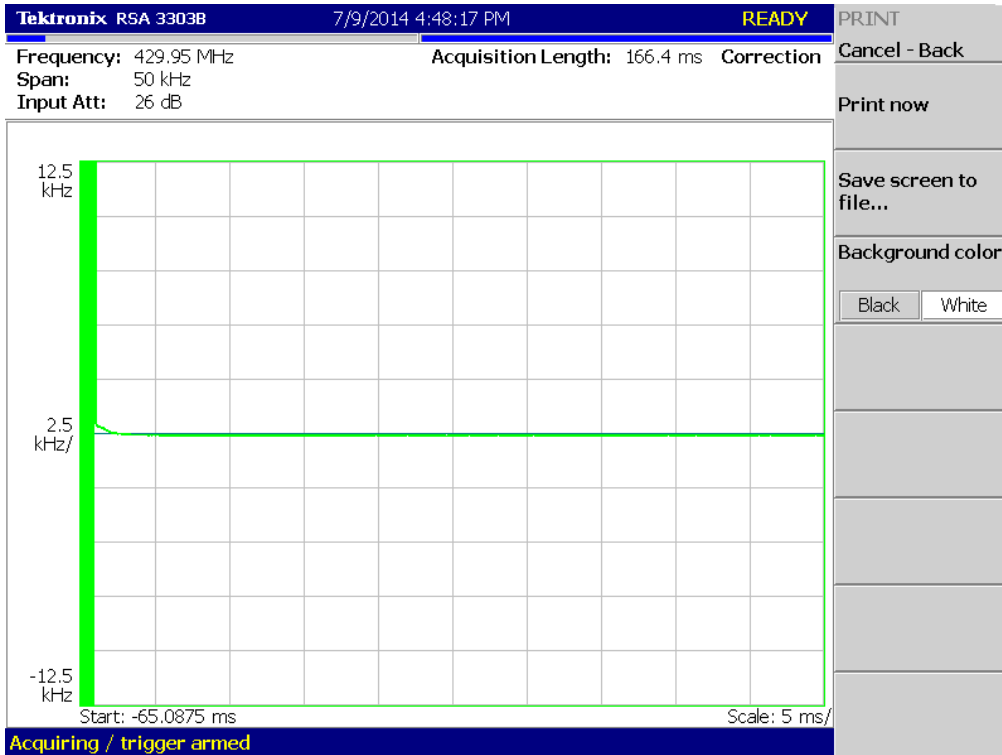

Cancel - Back

Print now

Save screen to file...

Background color

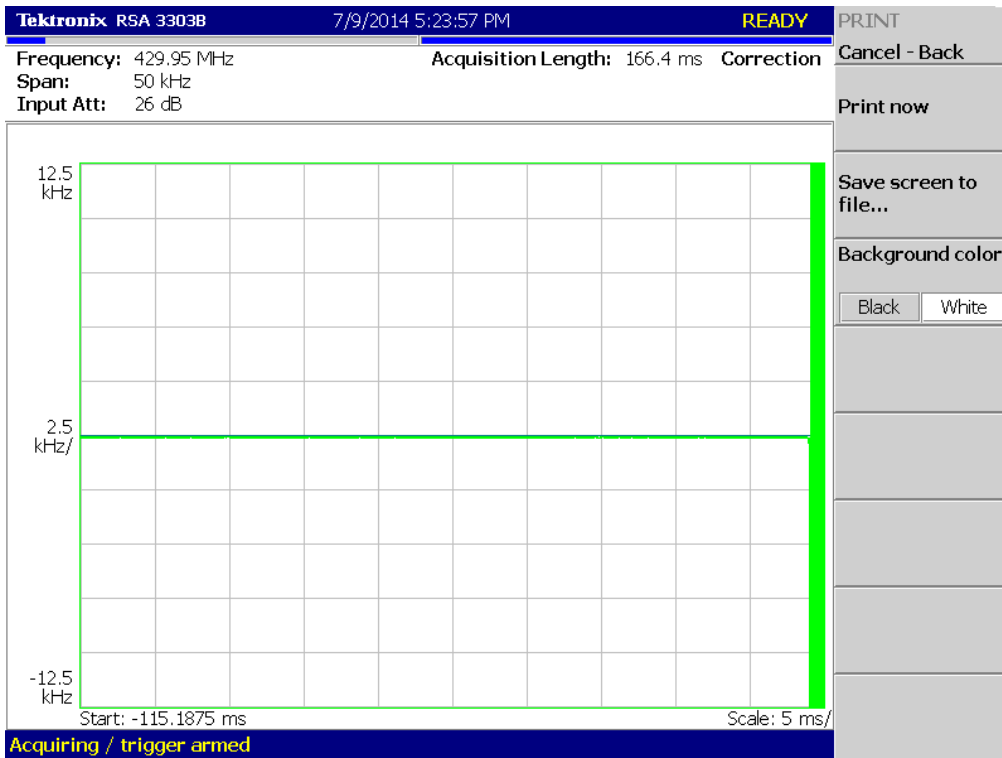

Cancel - Back

Print now

Save screen to file...

Background color

11K0F3E_469.95 MHz_LOW POWER

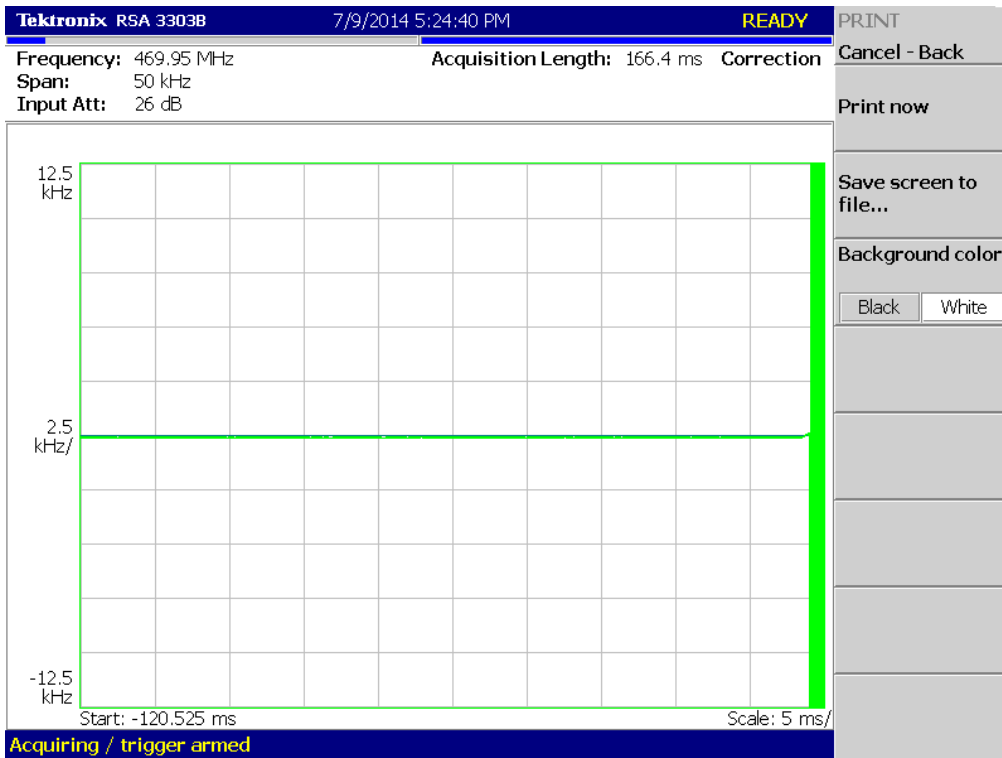
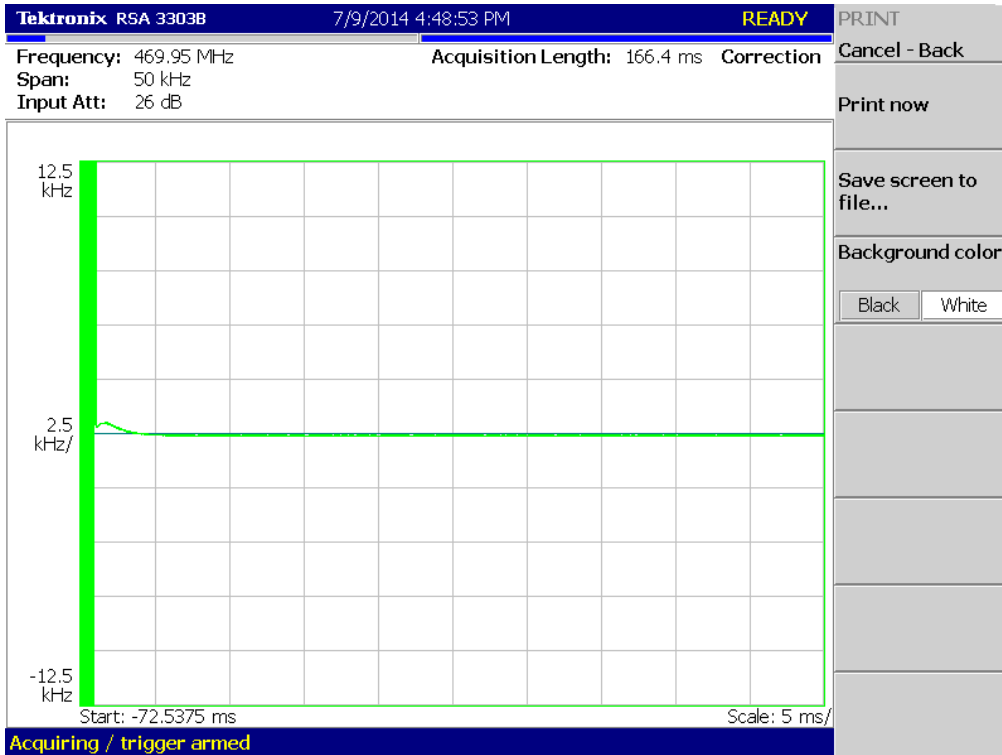

TEST RESULTS

11K0F3E for IC

11K0F3E_418.05 MHz_HIGH POWER

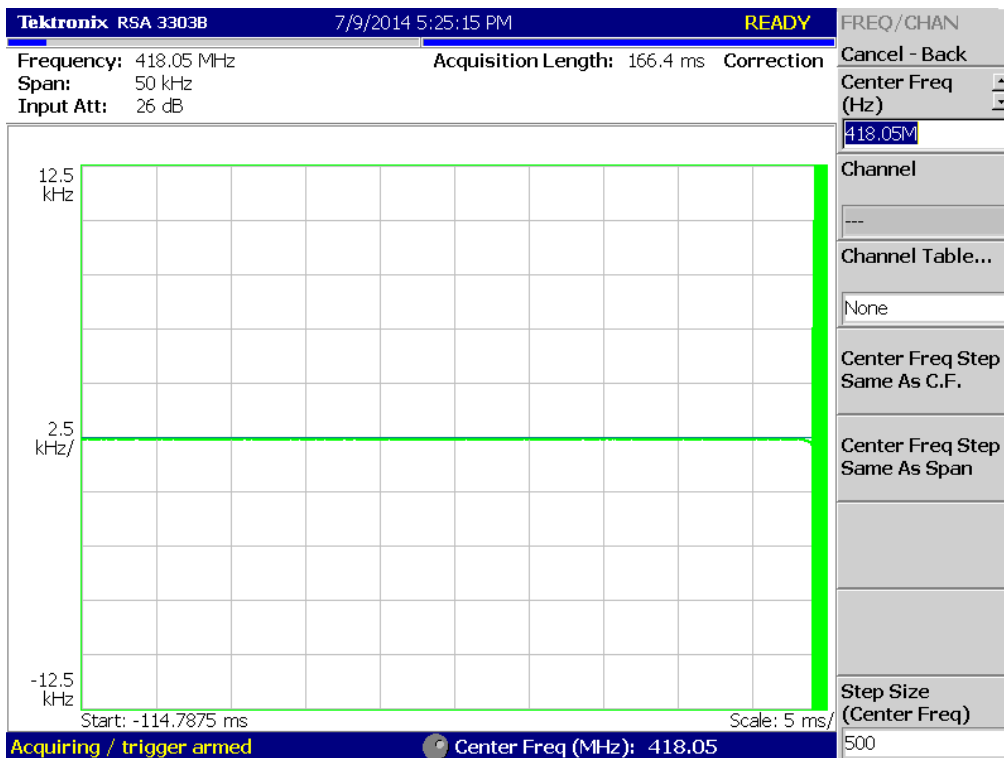
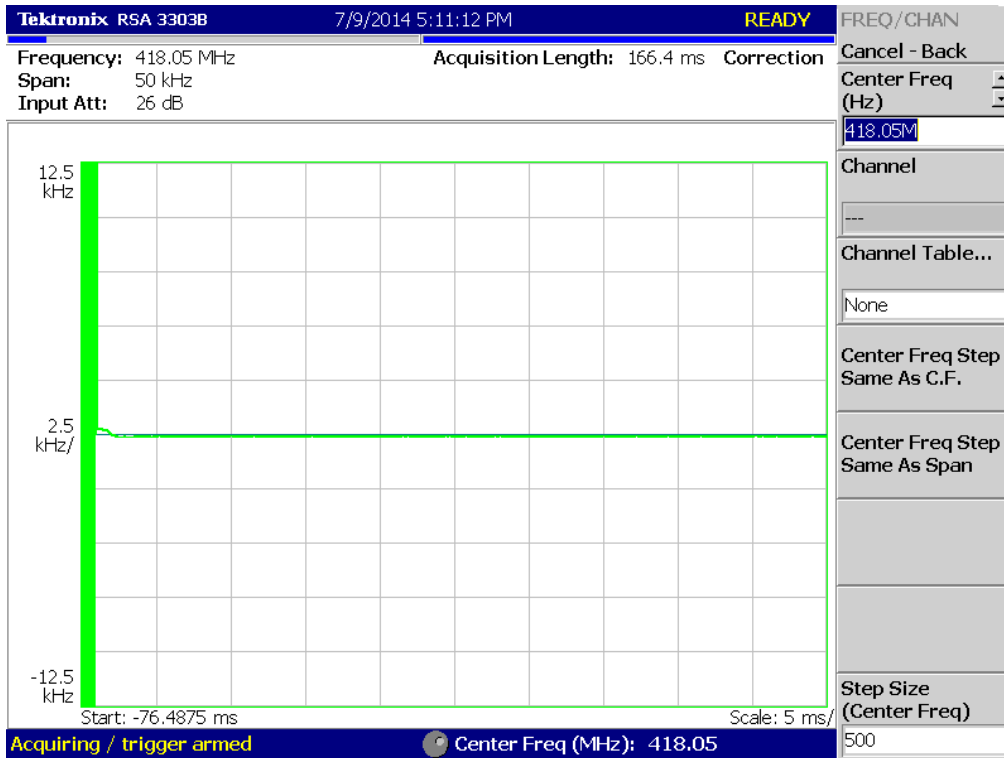

11K0F3E_450.05 MHz_HIGH POWER

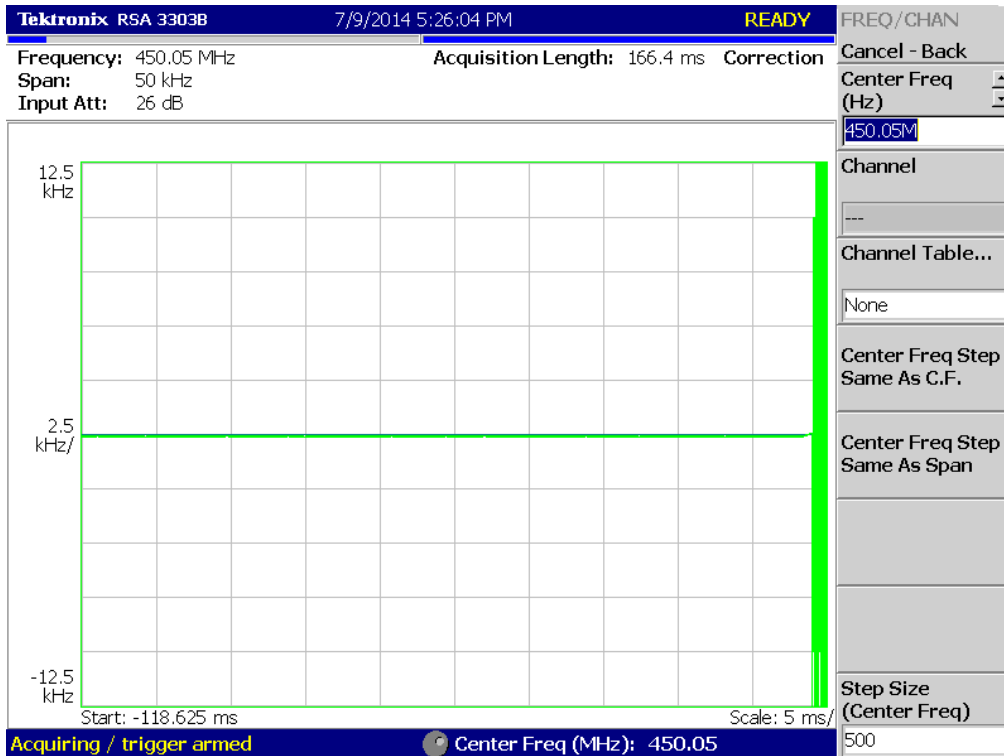
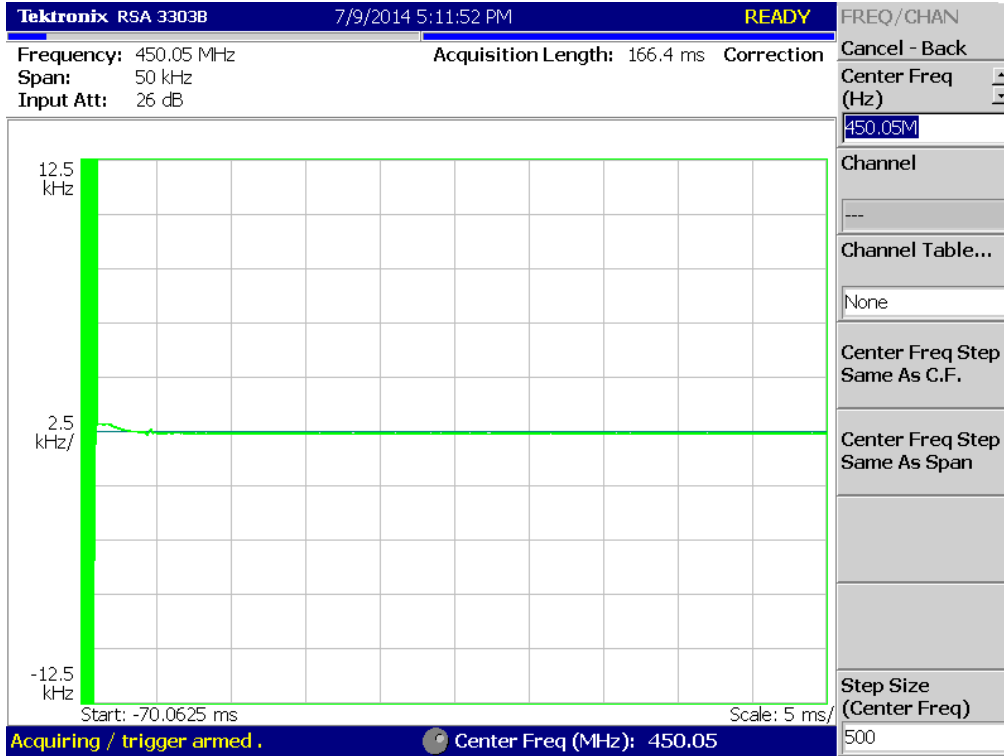

11K0F3E_460.05 MHz_HIGH POWER

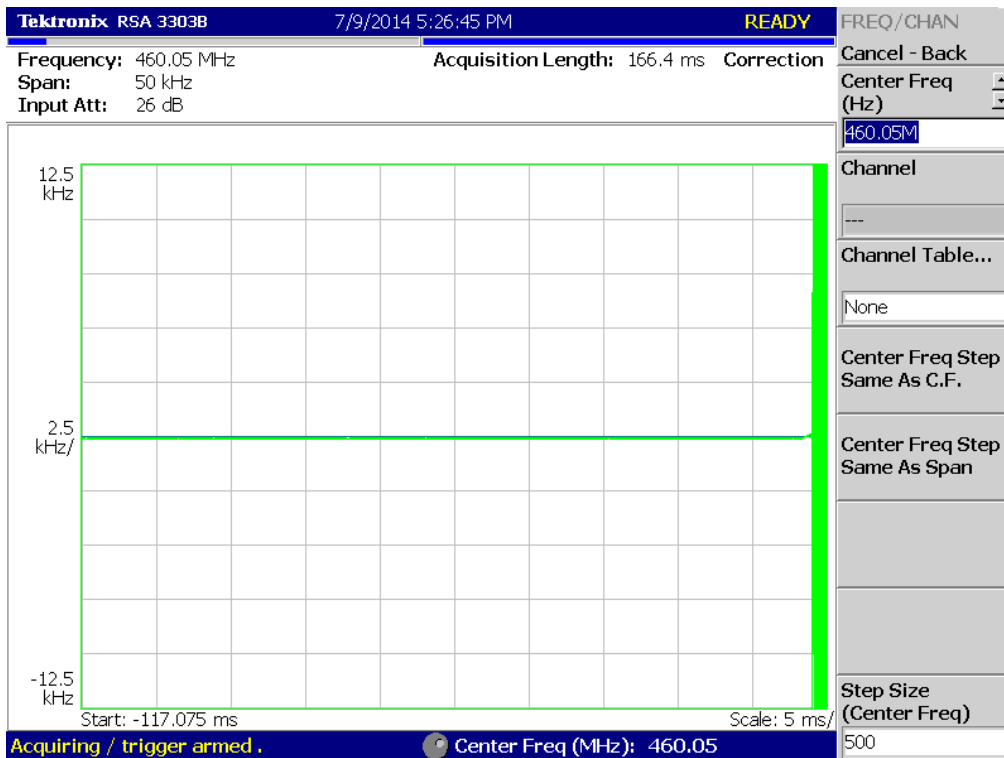
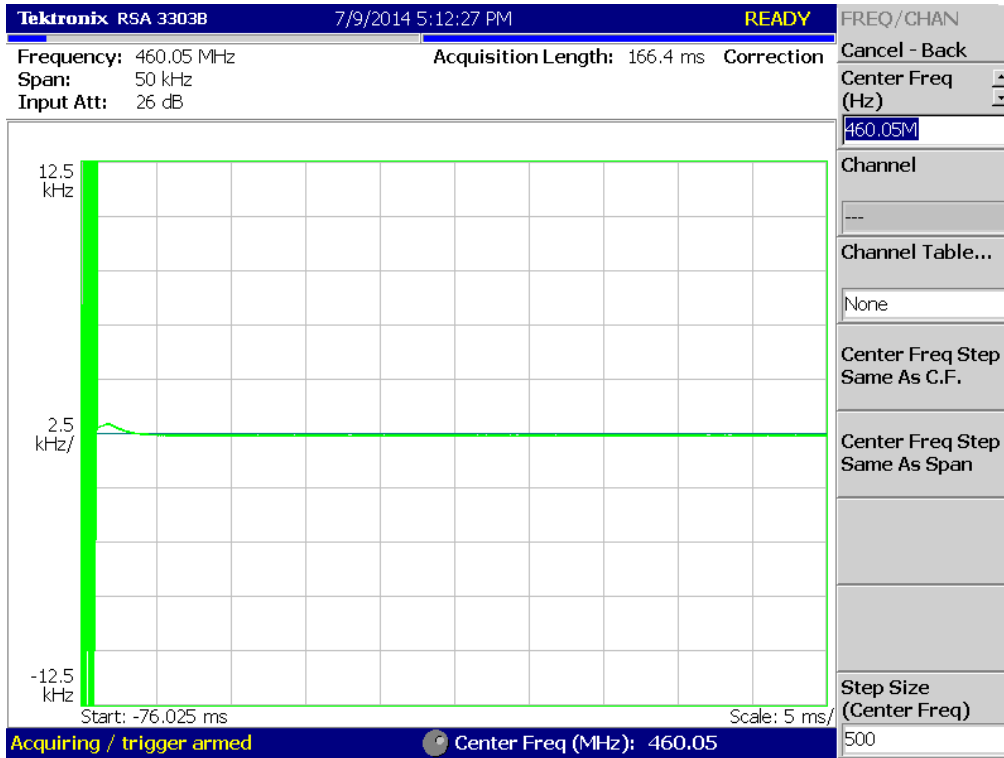

11K0F3E_418.05 MHz_LOW POWER

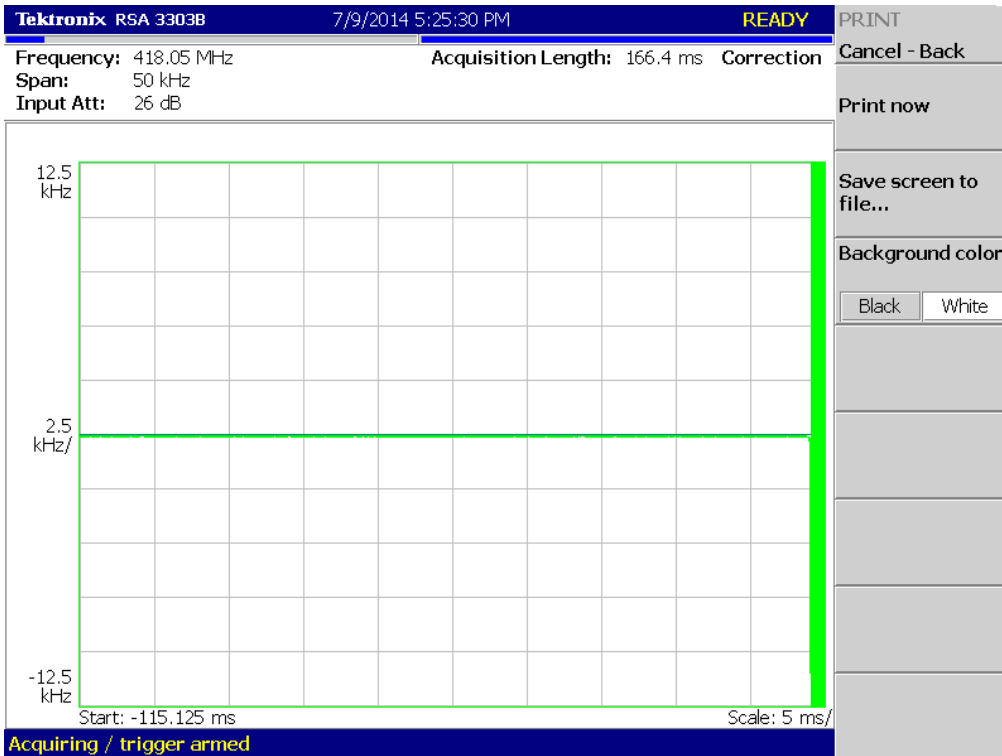
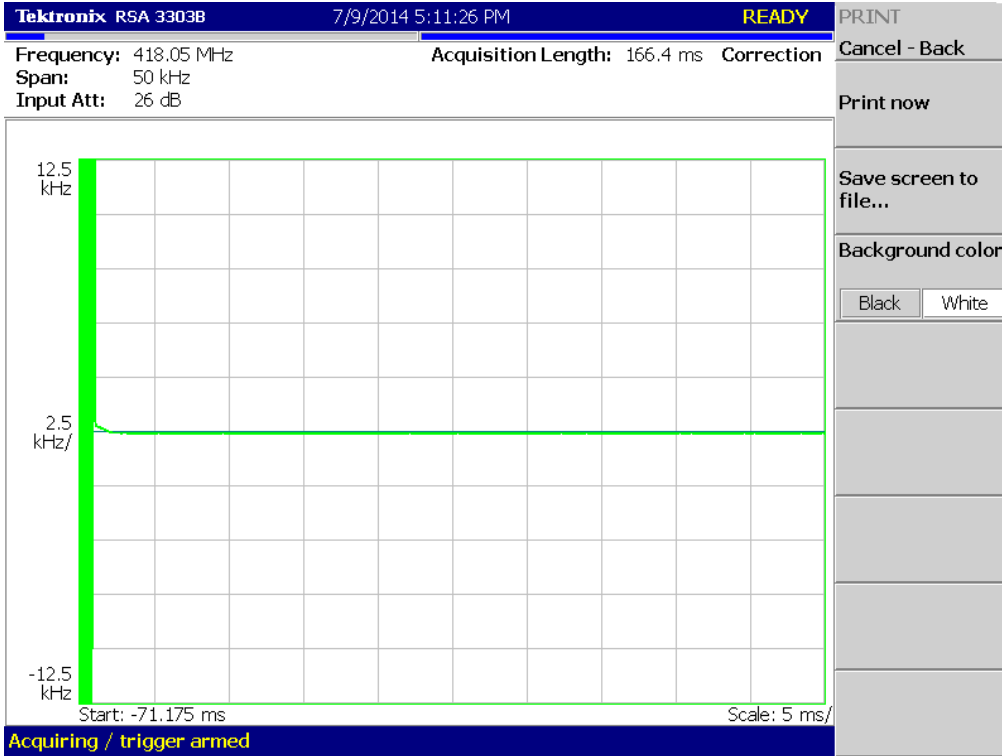

11K0F3E _450.05 MHz_LOW POWER

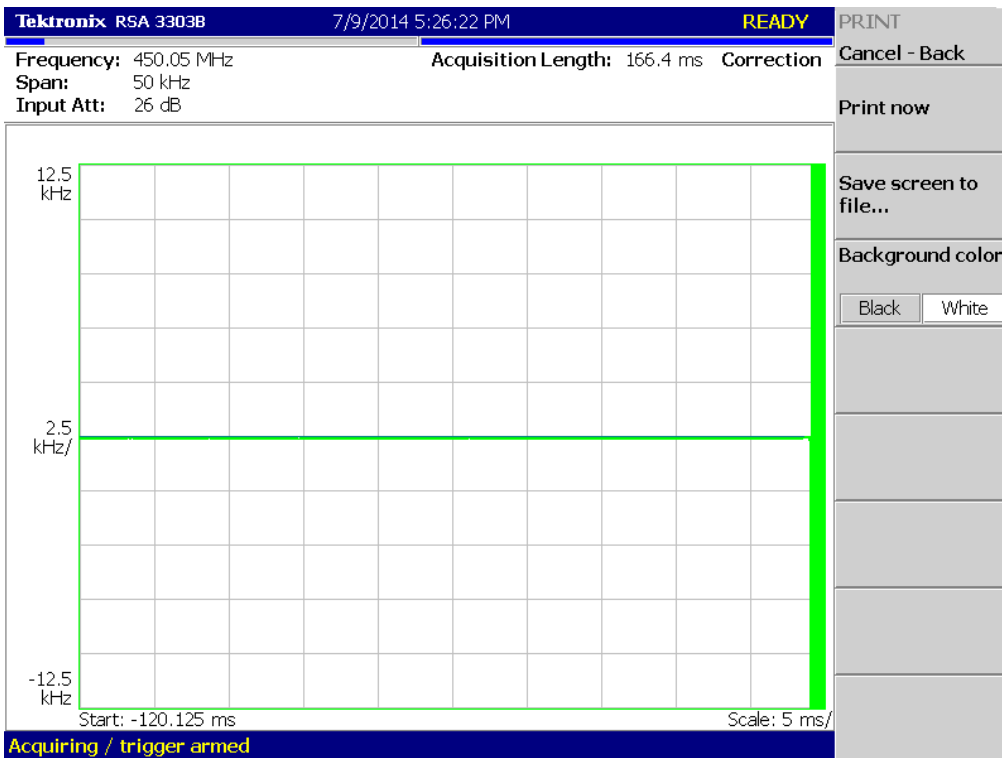
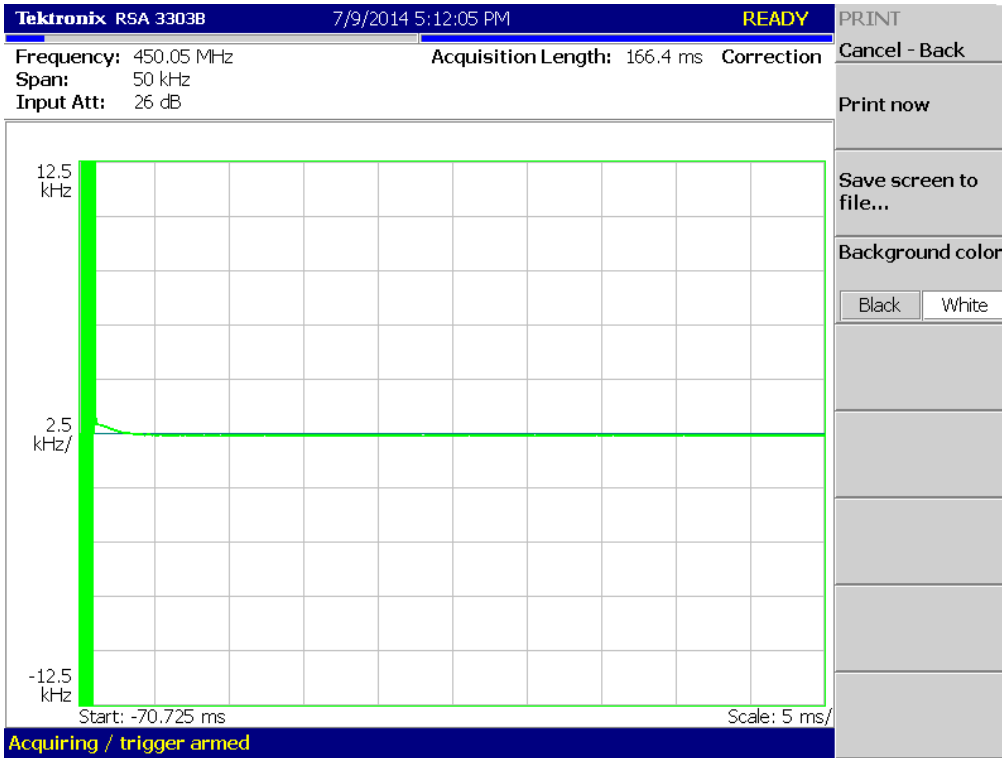

11K0F3E _460.05 MHz_LOW POWER

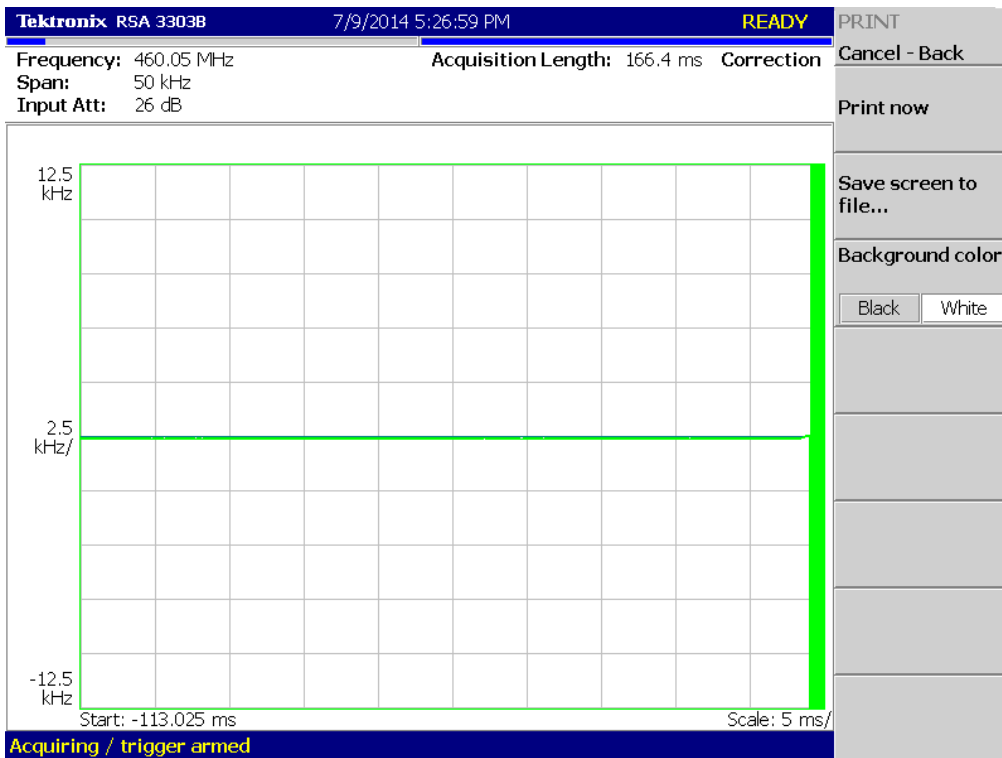
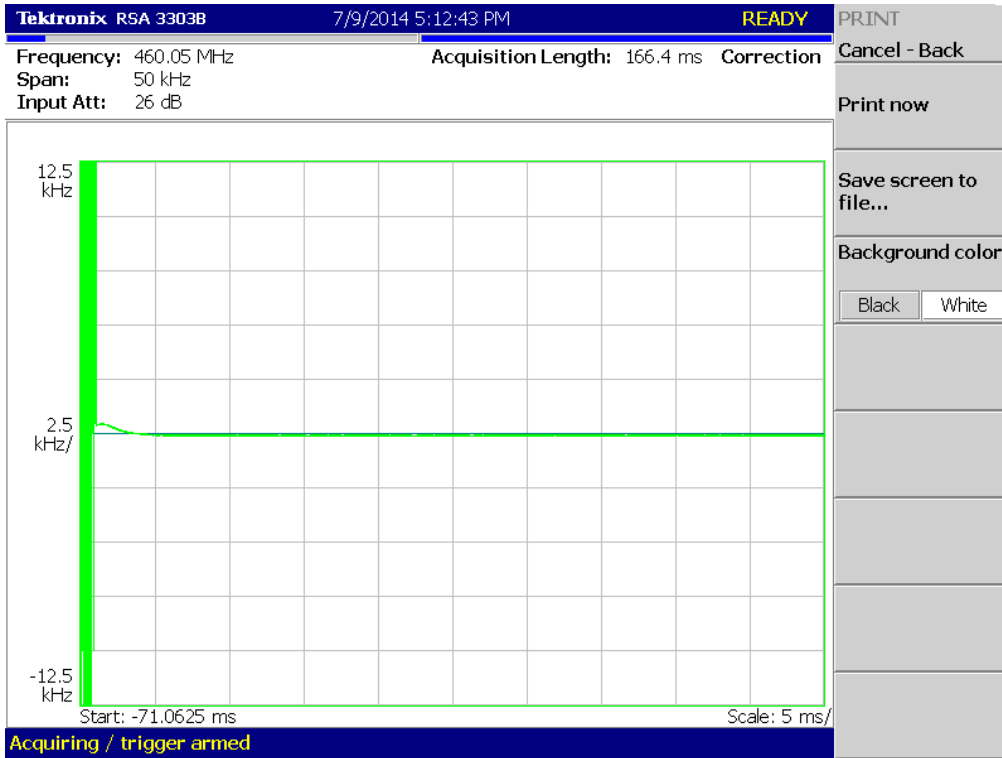

TEST RESULTS

16K0F3E for IC

16K0F3E_406.15 MHz_HIGH POWER

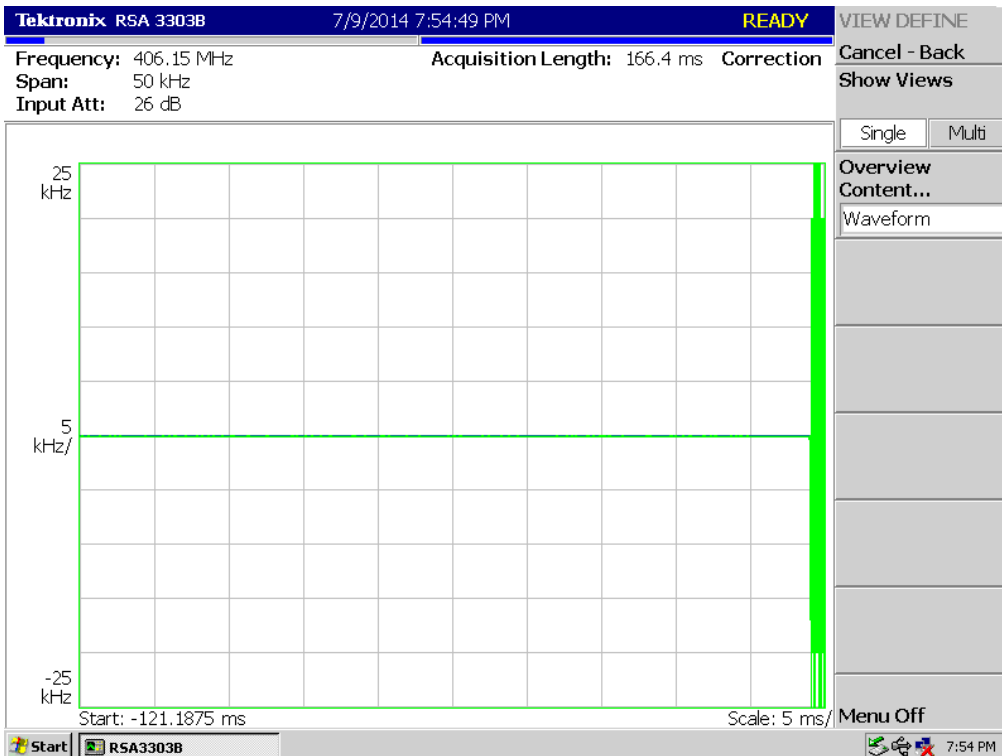
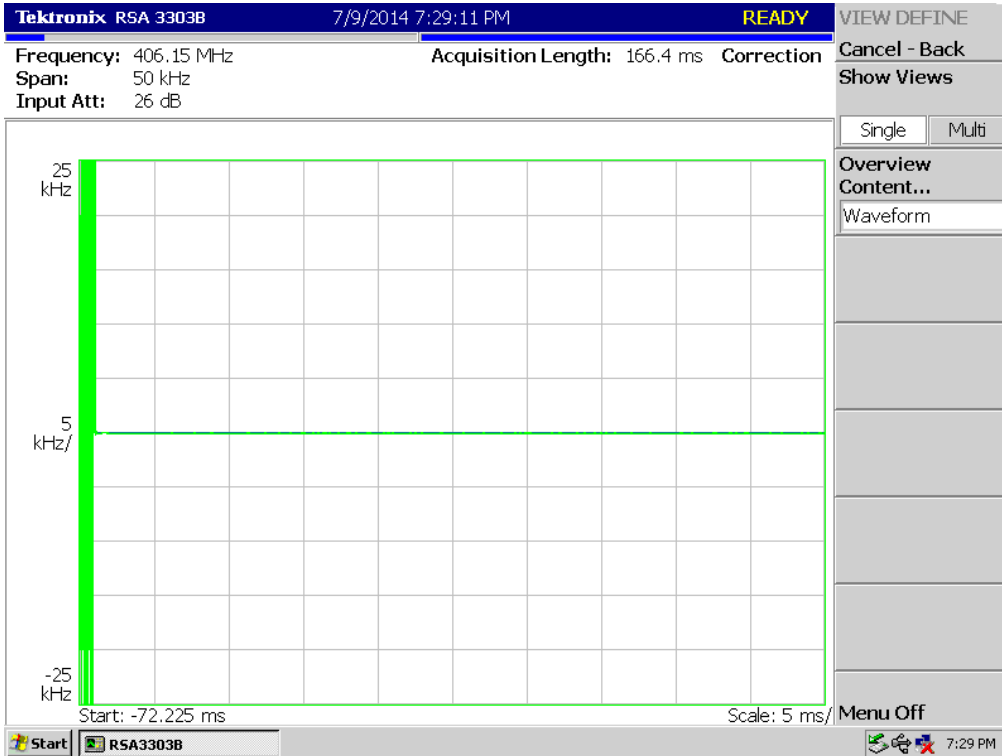

16K0F3E_418.05 MHz_HIGH POWER

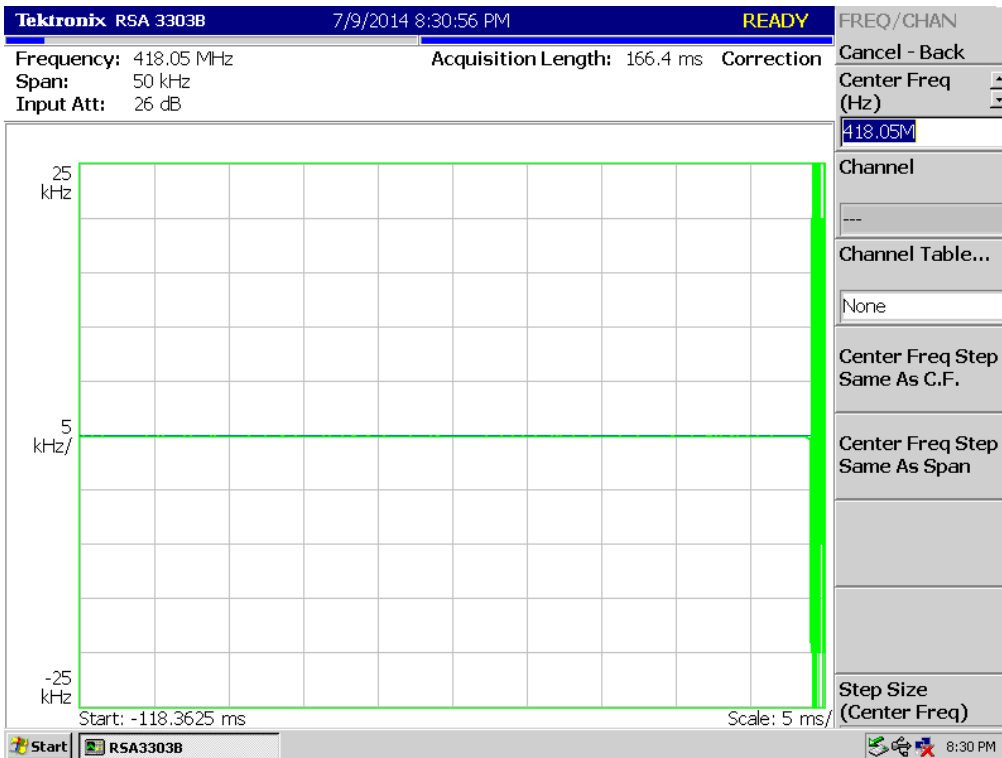
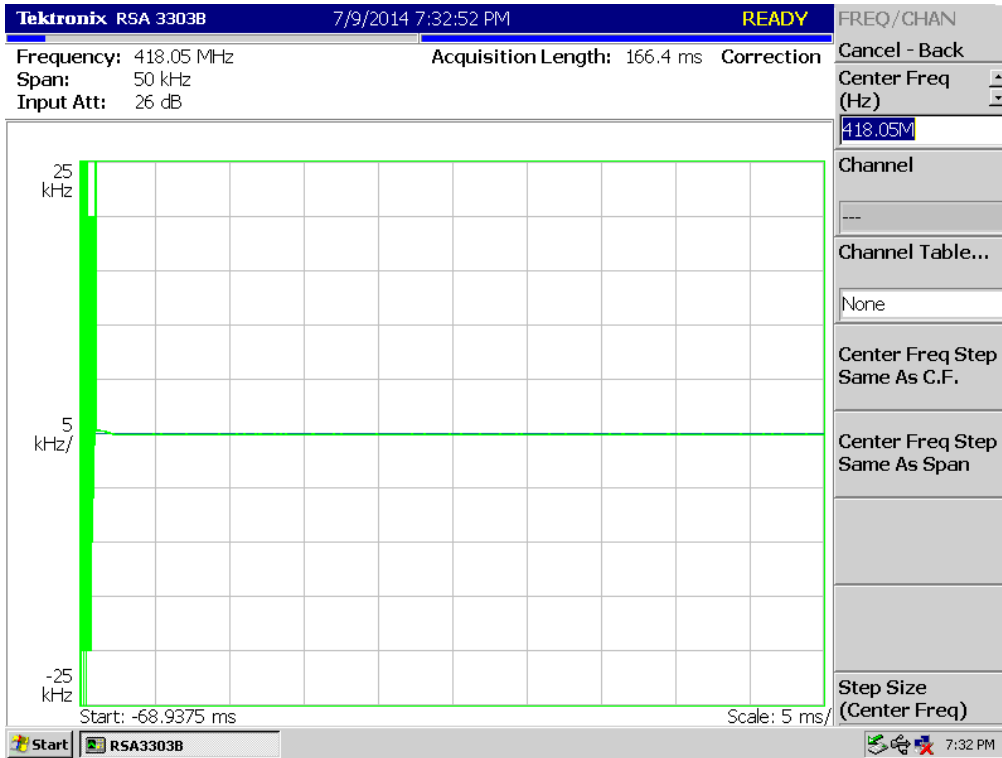

16K0F3E _450.05 MHz_HIGH POWER

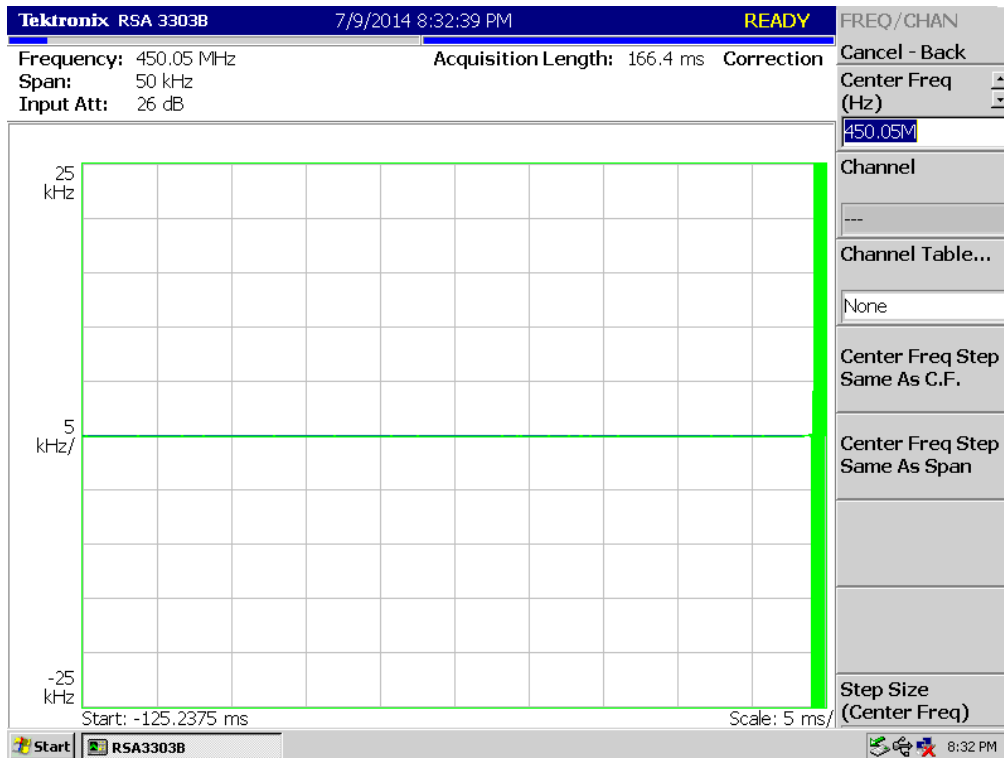
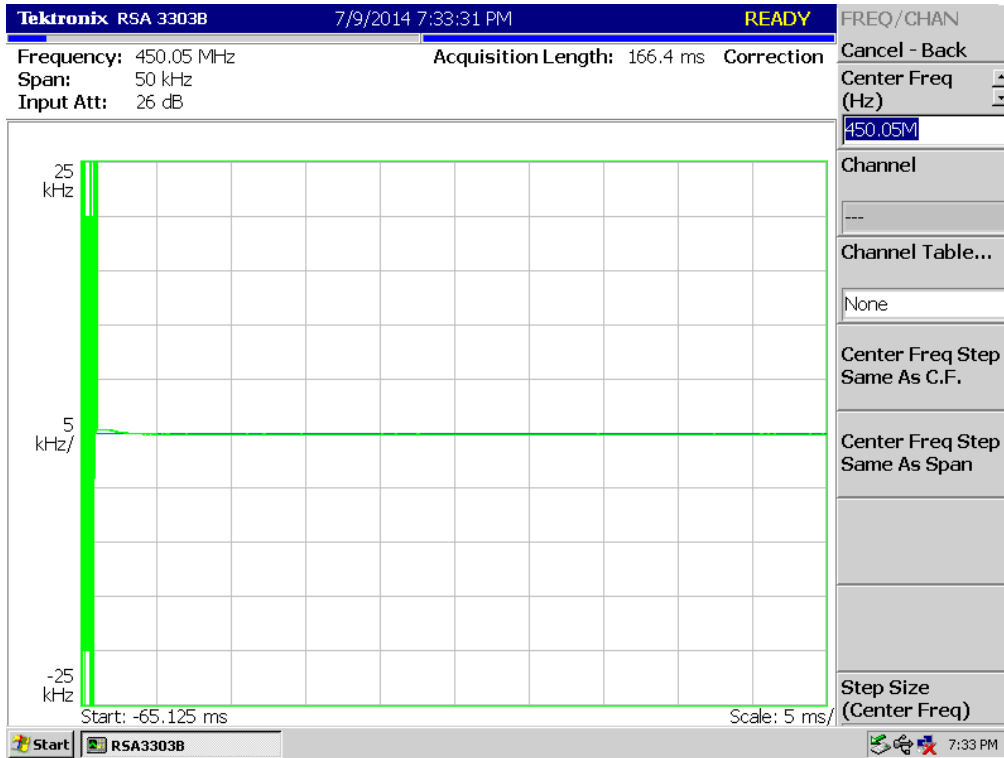

16K0F3E _460.05 MHz_HIGH POWER

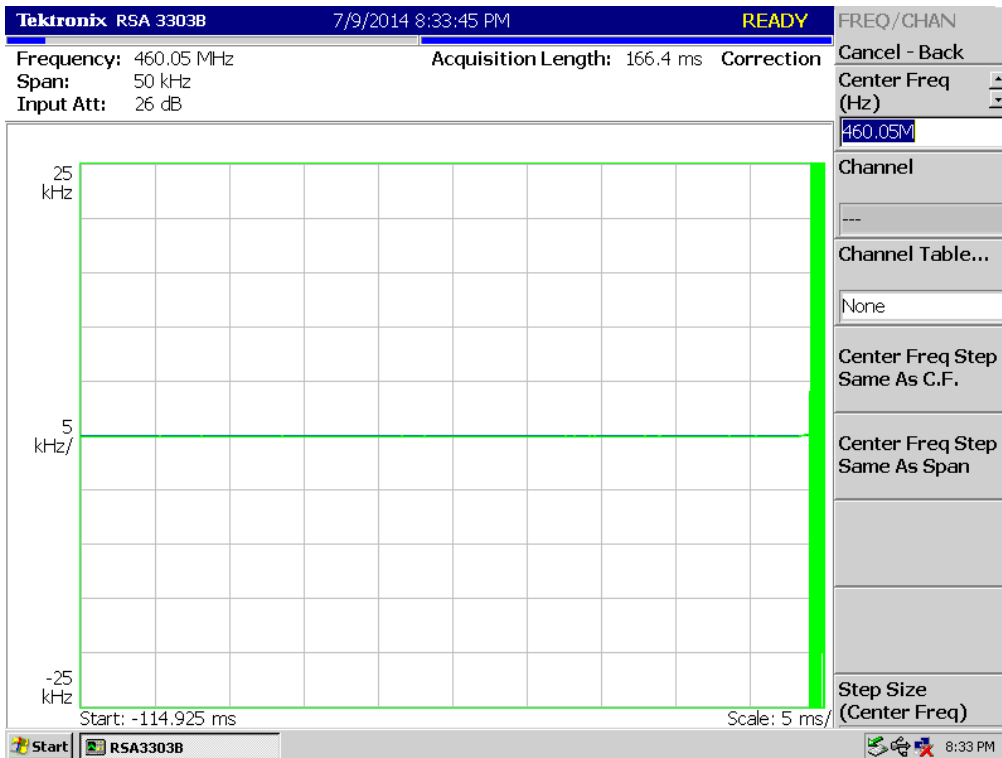
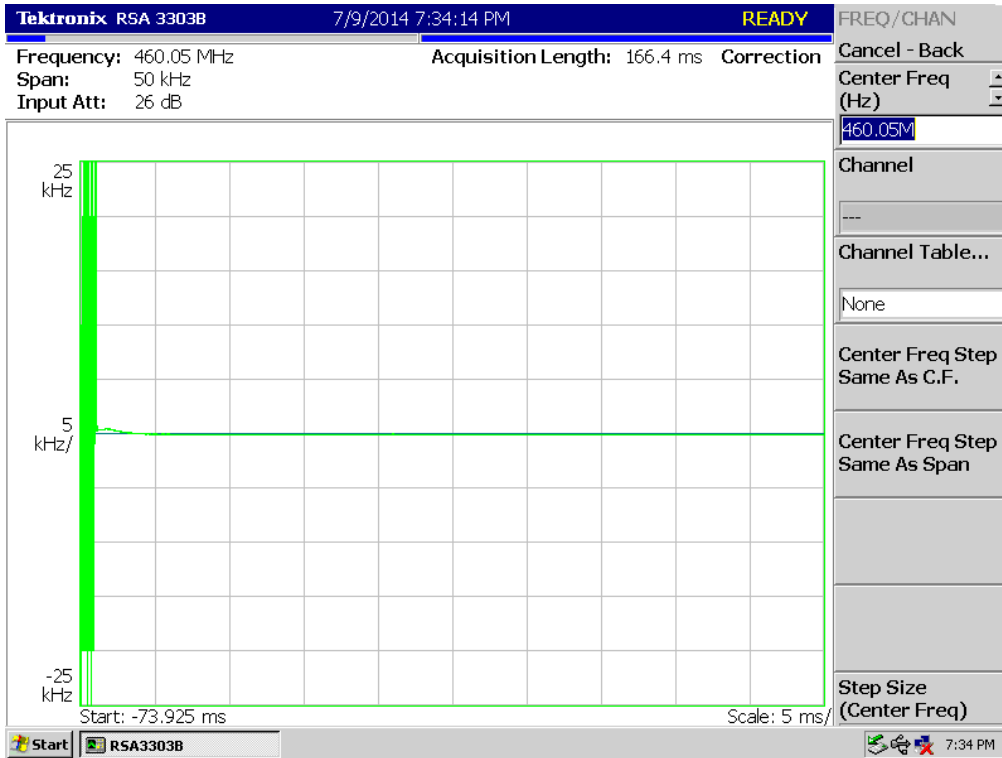

16K0F3E_406.15 MHz_LOW POWER

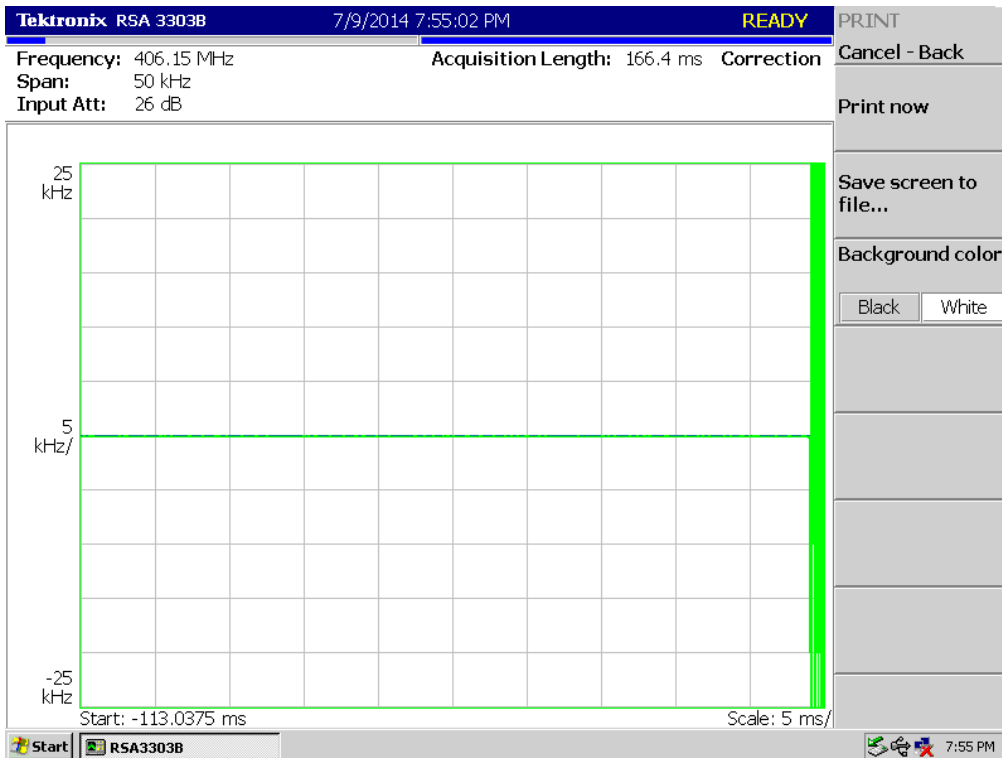
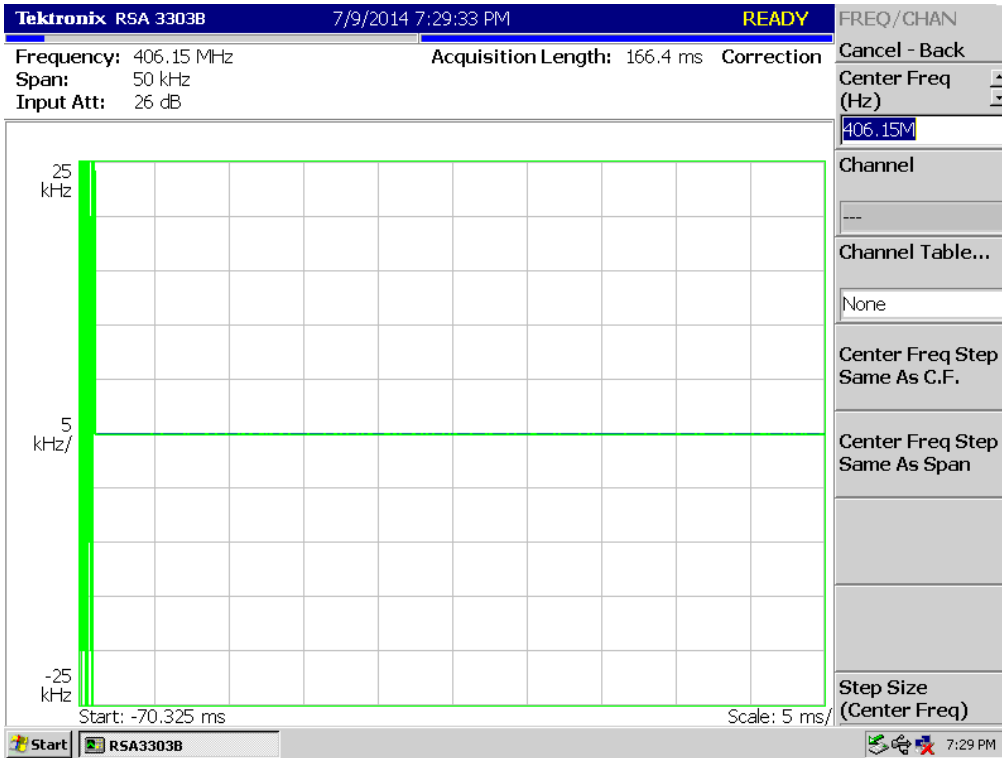

16K0F3E_418.05 MHz_LOW POWER

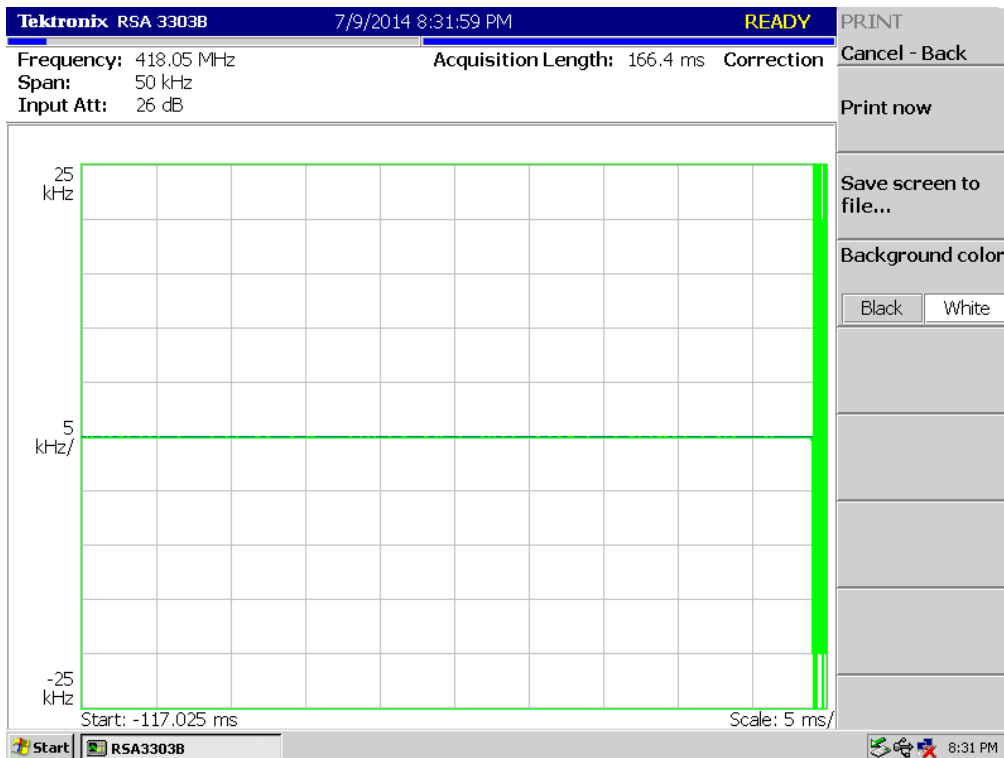
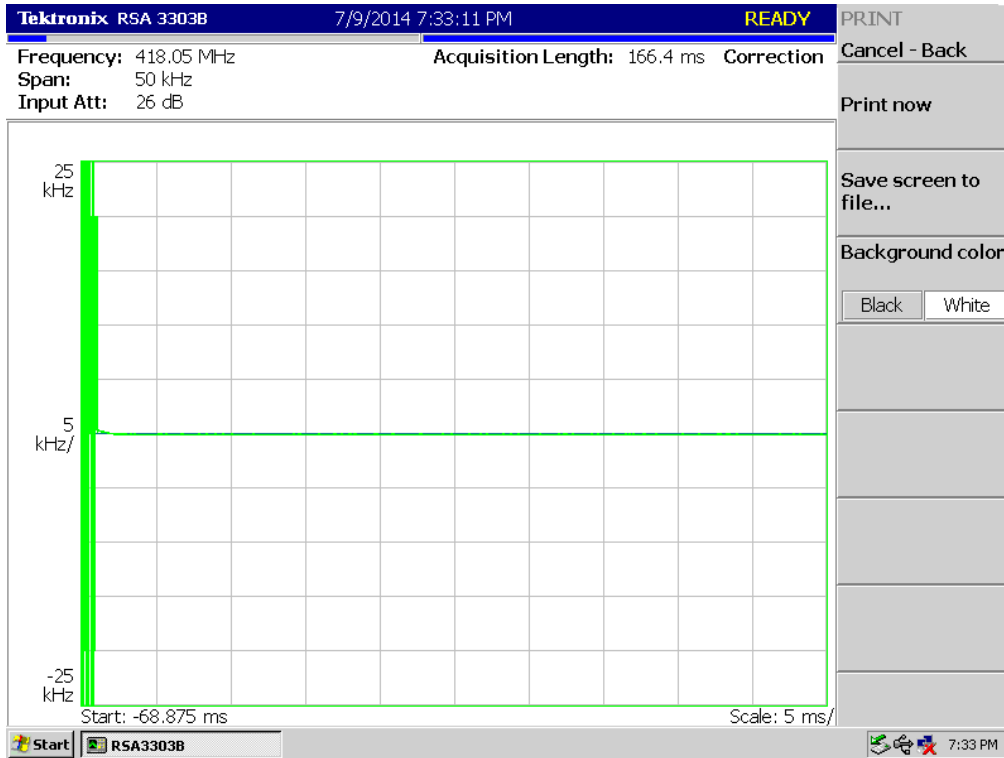

16K0F3E _450.05 MHz_LOW POWER

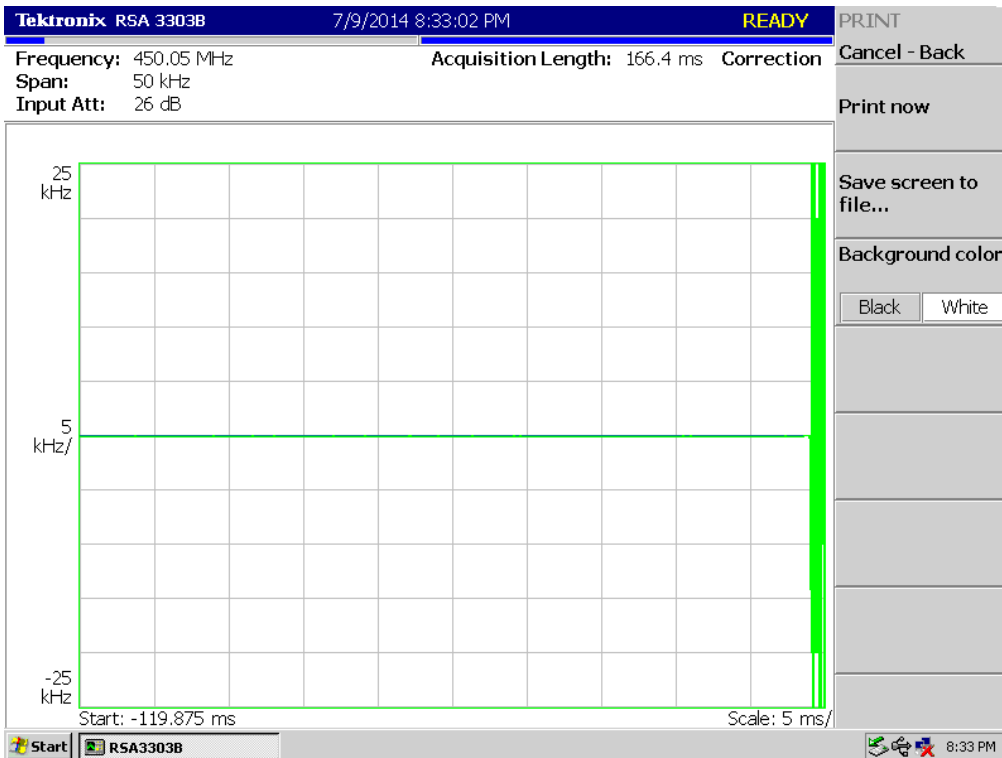
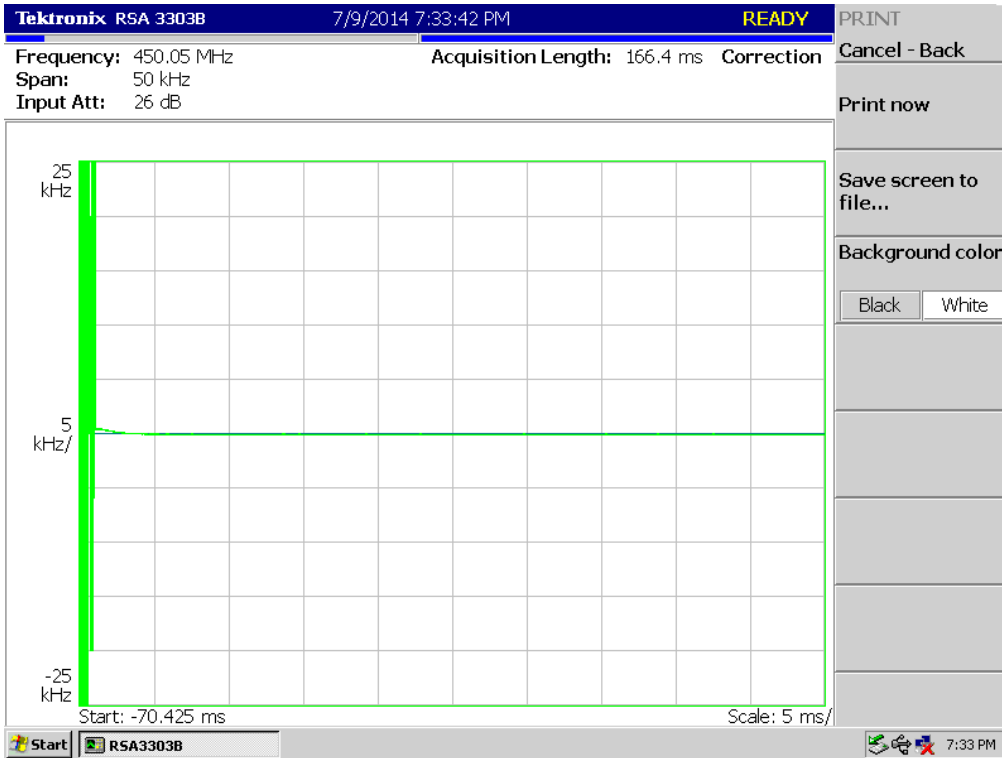

16K0F3E _460.05 MHz_LOW POWER

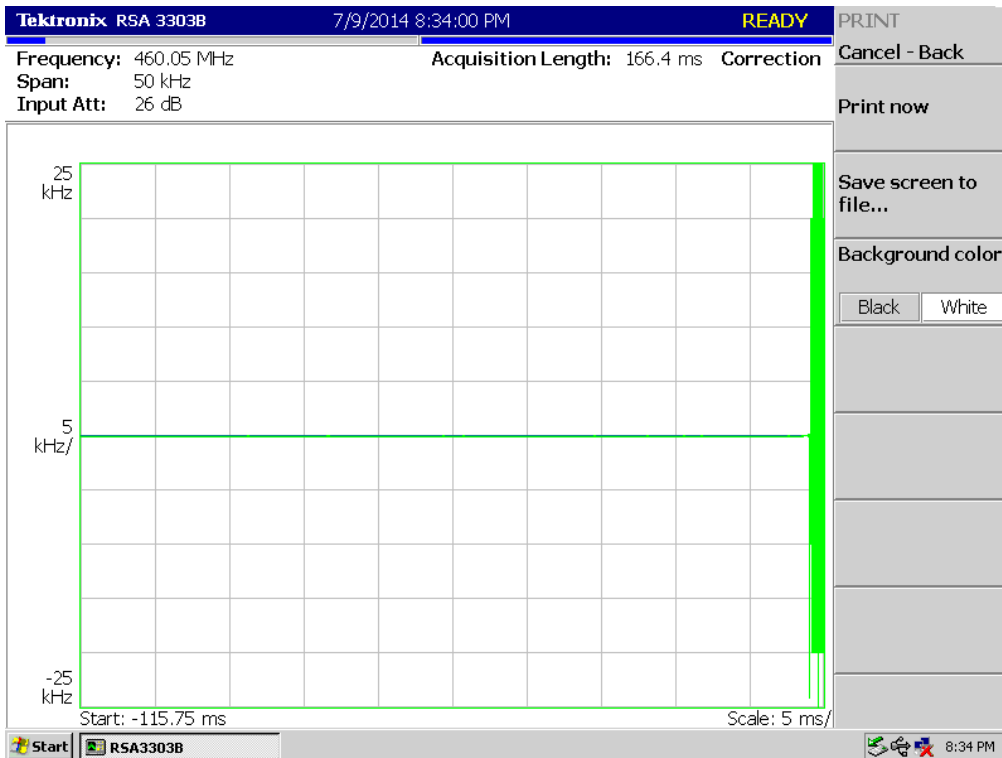
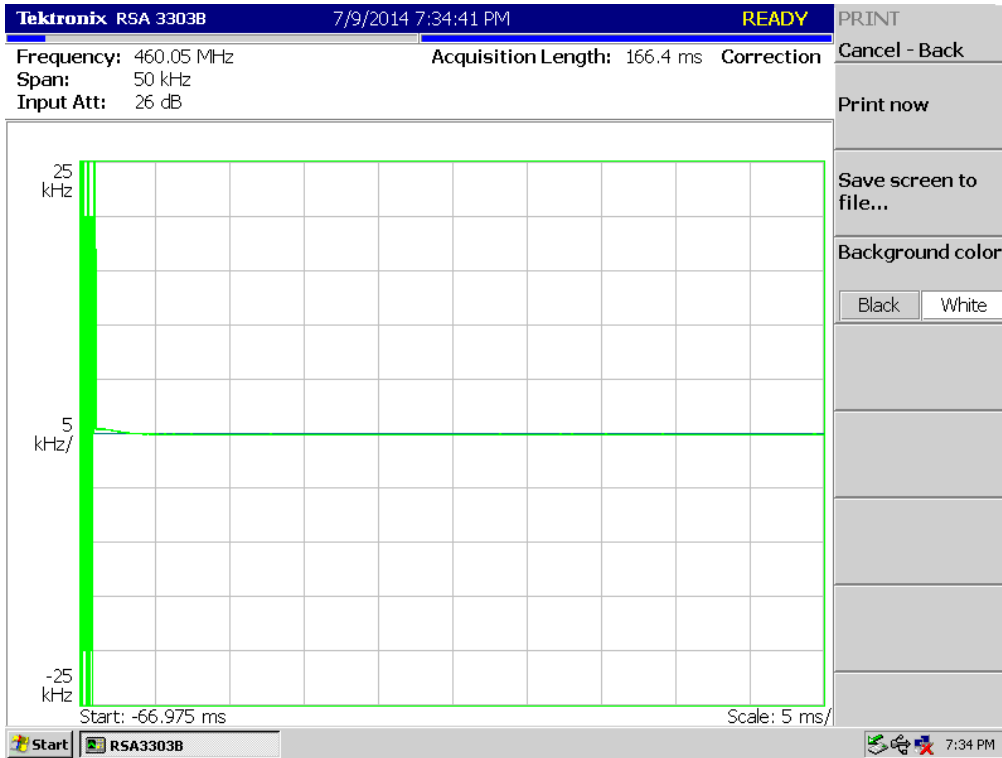

16K0F3E _429.95 MHz_HIGH POWER

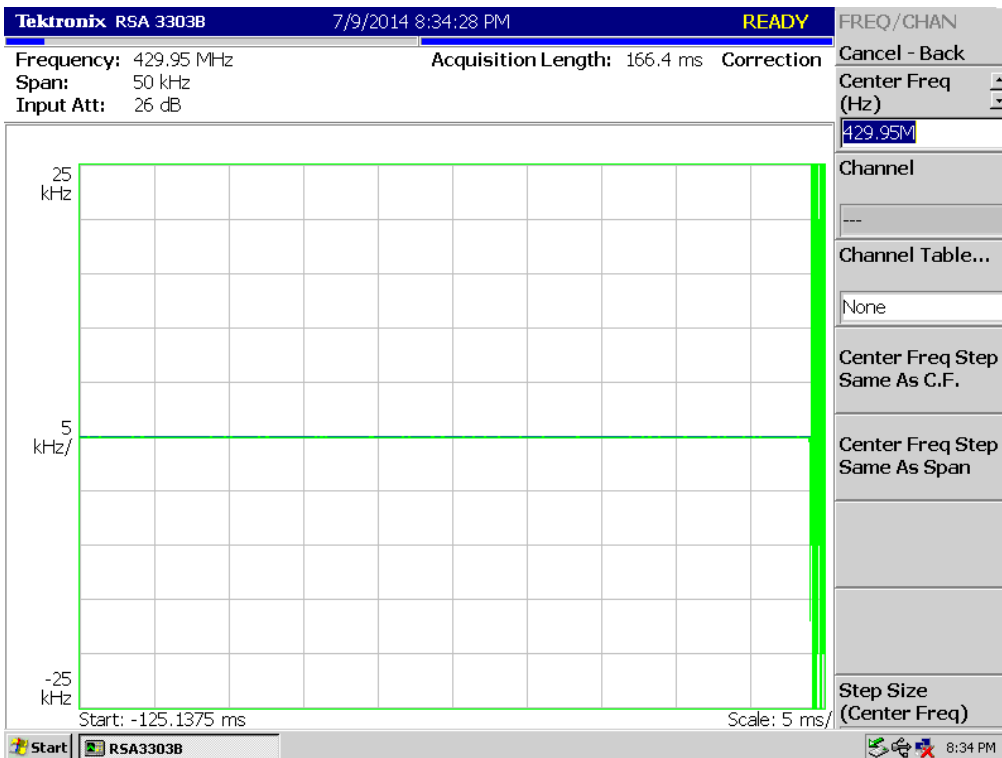
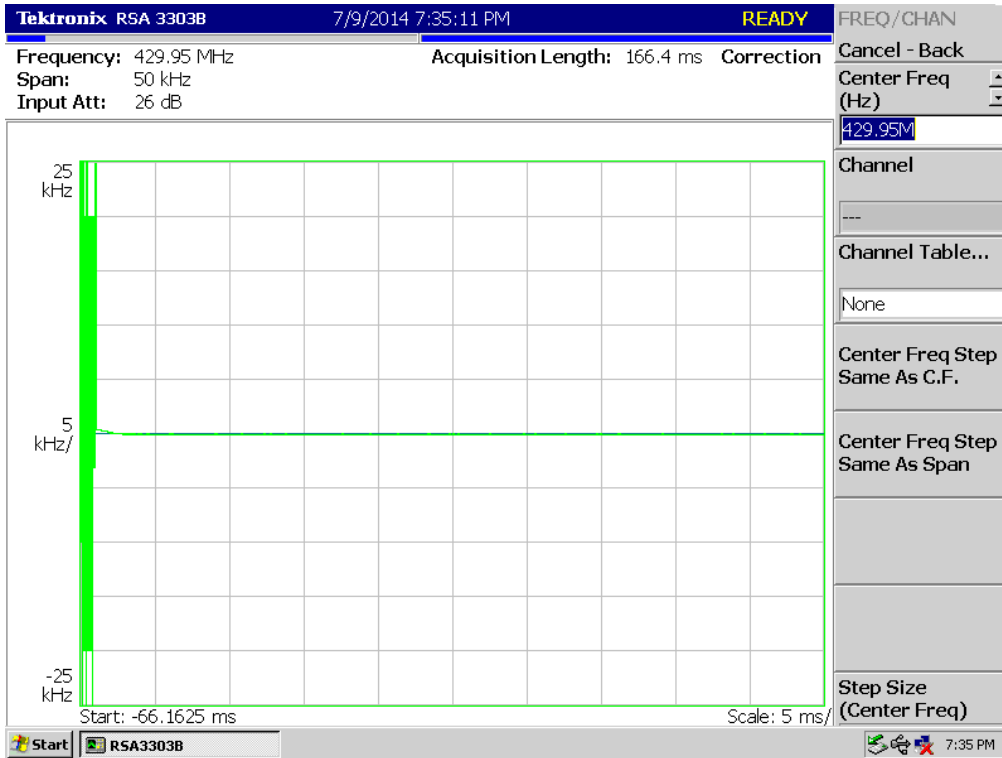

16K0F3E_469.95 MHz_HIGH POWER

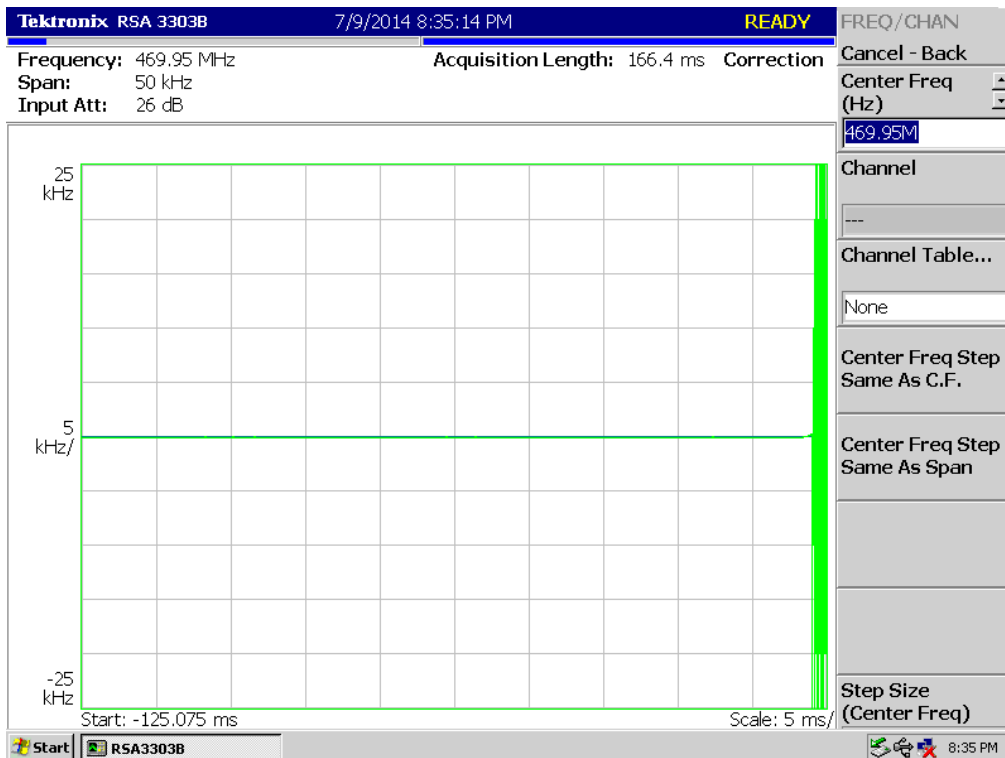
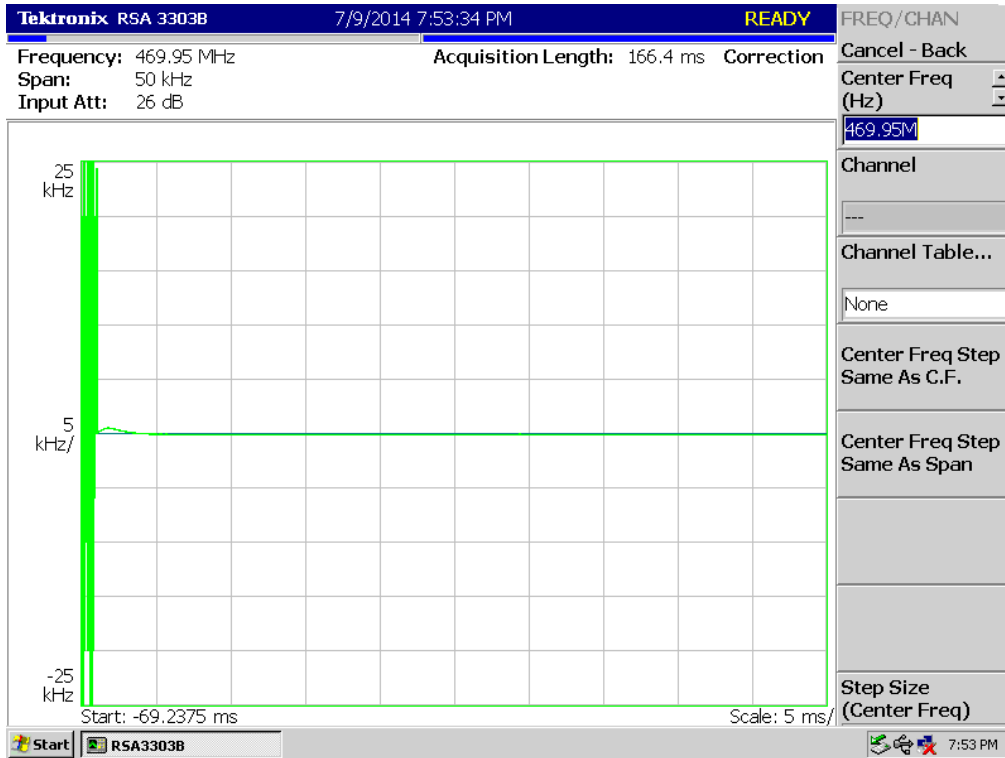

16K0F3E _429.95 MHz_LOW POWER

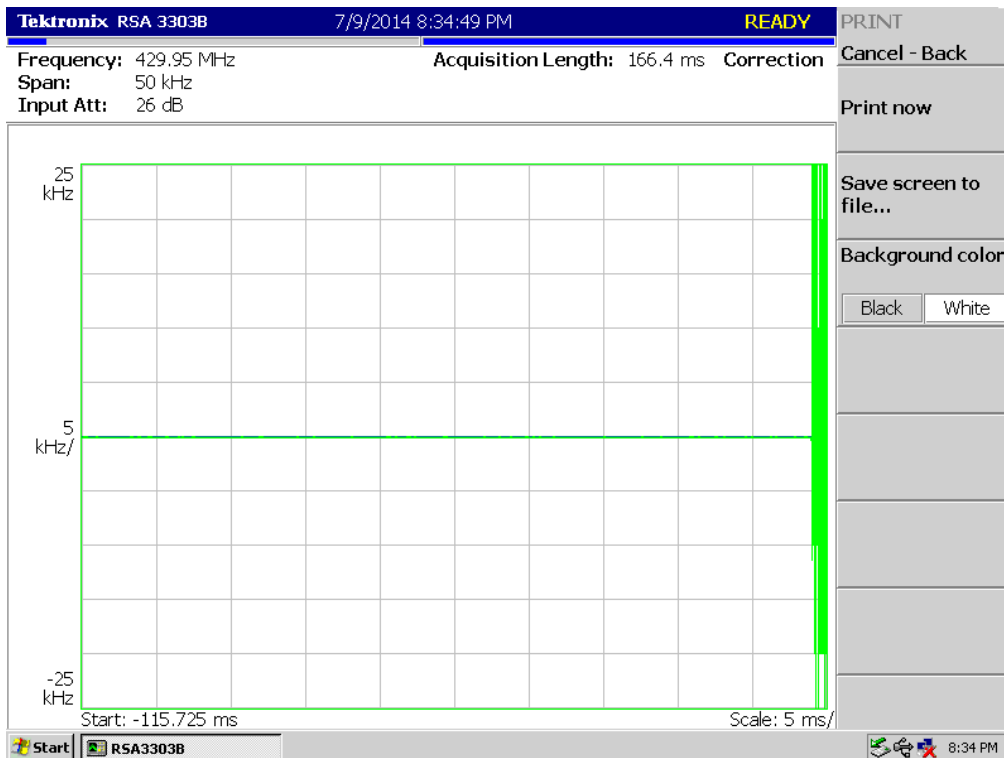
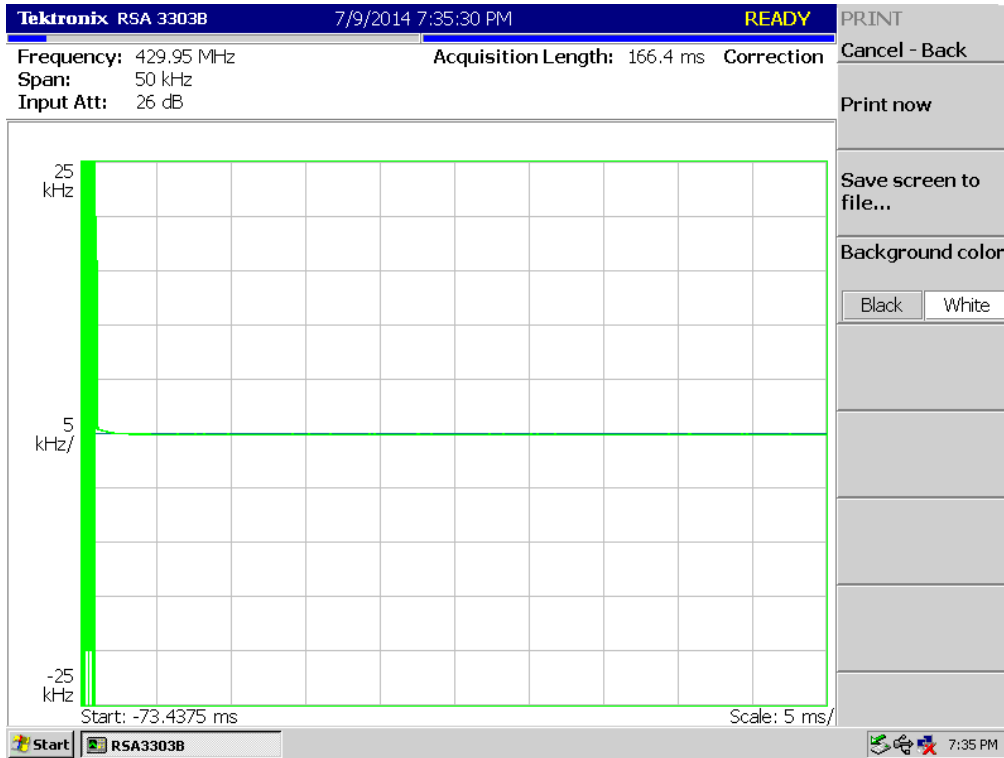

16K0F3E _469.95 MHz_LOW POWER

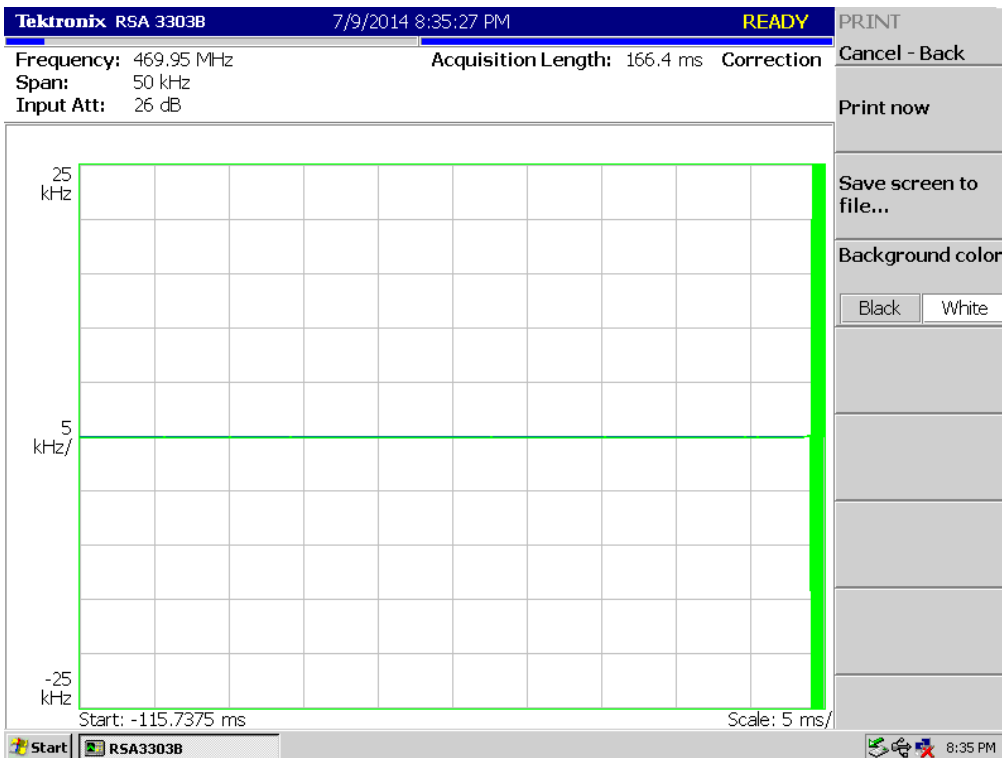
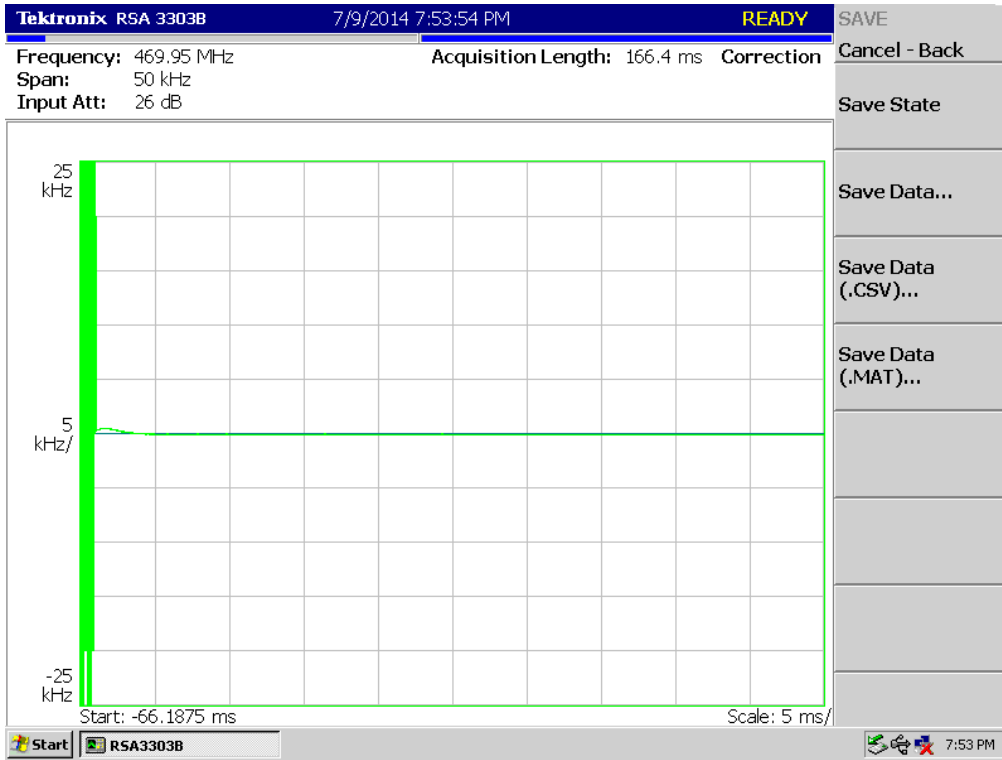

7.8 Unwanted Emissions : Conducted Spurious Emission

Definition

Conducted spurious emissions are emissions at the antenna terminals on a frequency or frequencies that are outside a band sufficient to ensure transmission of information of required quality for the class of communication desired.

TEST CONFIGURATION

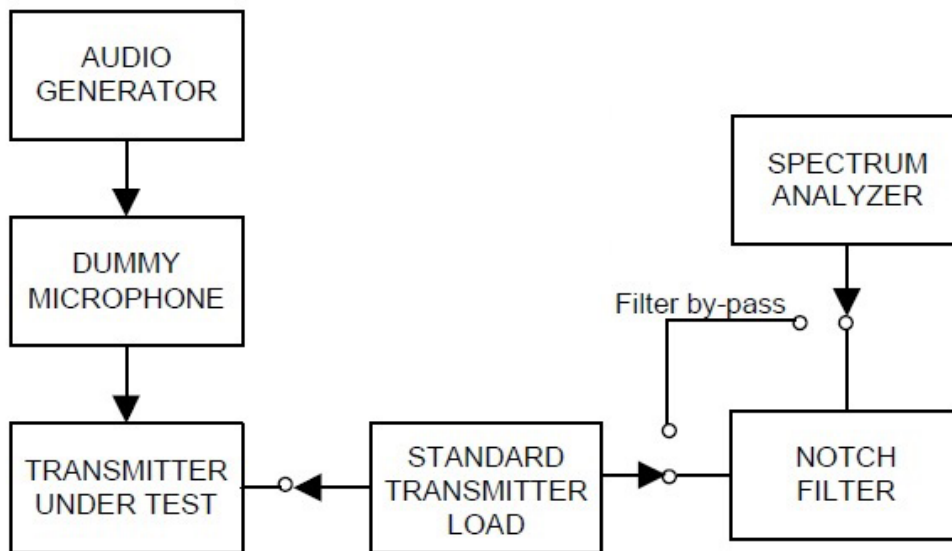

TEST PROCEDURE

According to 2.2.13 in TIA-603-D Standard.

- e) Connect the equipment as illustrated, with the notch filter by-passed.
- f) Set the center frequency of the spectrum analyzer to the assigned transmitter frequency, key the transmitter, and set the level of the carrier to the full scale reference line.
- g) Modulate the transmitter with a 2500 Hz sine wave at an input level 16 dB greater than that necessary to produce 50% of rated system deviation. The input level shall be established at the frequency of maximum response of the audio modulation circuit.
- h) Adjust the spectrum analyzer for the following settings:
 - 1) Resolution Bandwidth = 10 kHz for spurious emissions below 1 GHz, and 1 MHz for spurious emissions above 1 GHz.
 - 2) Video Bandwidth ≥ 3 times the resolution bandwidth.
 - 3) Sweep Speed ≤ 2000 Hz per second.
 - 4) Detector Mode = mean or average power.
- e) Adjust the center frequency of the spectrum analyzer for incremental coverage of the range from:
 - 1) The lowest radio frequency generated in the equipment to the carrier frequency minus the test bandwidth (see 1.3.4.4).

- 2) The carrier frequency plus the test bandwidth to a frequency less than 2 times the carrier frequency.
- f) Record the frequencies and levels of spurious emissions from step e).
- g) Unkey the transmitter. Replace the transmitter under test with the signal generator and adjust the signal level to reproduce the frequencies and levels of every spurious emission recorded in step f). Record the signal generator levels in dBm.
- h) Insert the notch filter.
- i) Adjust the spectrum analyzer for the following settings:
 - 1) Resolution Bandwidth = 10 kHz for spurious emissions below 1 GHz, and 1 MHz for spurious emissions above 1 GHz.
 - 2) Video Bandwidth ≥ 3 times the resolution bandwidth.
 - 3) Sweep Speed ≤ 2000 Hz per second.
 - 4) Detector Mode = mean or average power.
- j) Key the transmitter. Adjust the center frequency of the spectrum analyzer for incremental coverage of the range from a frequency equal to 2 times the carrier frequency and to the tenth harmonic of the carrier frequency.

TEST RESULTS For FCC

11K0F3E

No.	Frequency (MHz)	Channel	Power Mode	Spurious Frequency (MHz)	Correct Level (dBm)
1	406.15	Low	High Power	322.94	-52.195
2	429.95	Middle	High Power	899.12	-51.981
3	469.95	High	High Power	939.90	-56.77
4	406.15	Low	Low Power	113.42	-45.236
5	429.95	Middle	Low Power	108.57	-47.776
6	469.95	High	Low Power	114.37	-48.421
				939.90	-59.772

8K30F1E, 8K30F1D, 8K30F7W

No.	Frequency (MHz)	Channel	Power Mode	Spurious Frequency (MHz)	Correct Level (dBm)
1	406.15	Low	High Power	123.12	-52.828
2	429.95	Middle	High Power	3465.3	-47.359
3	469.95	High	High Power	939.9	-52.362
4	406.15	Low	Low Power	109.54	-45.711
5	429.95	Middle	Low Power	108.57	-46.597
6	469.95	High	Low Power	111.48	-48.690

8K10F1W

No.	Frequency (MHz)	Channel	Power Mode	Spurious Frequency (MHz)	Correct Level (dBm)
1	406.15	Low	High Power	3147.2	-46.471
2	429.95	Middle	High Power	3605.8	-47.037
3	469.95	High	High Power	939.9	-51.537
4	406.15	Low	Low Power	112.5	-45.073
5	429.95	Middle	Low Power	109.5	-47.626
6	469.95	High	Low Power	110.5	-46.831

8K10F1E, 8K10F1D

No.	Frequency (MHz)	Channel	Power Mode	Spurious Frequency (MHz)	Correct Level (dBm)
1	406.15	Low	High Power	2445.2	-45.605
2	429.95	Middle	High Power	3613.8	-47.027
3	469.95	High	High Power	939.9	-51.458
4	406.15	Low	Low Power	108.57	-44.706
5	429.95	Middle	Low Power	108.57	-46.810
				3600.3	-46.218
6	469.95	High	Low Power	110.51	-478.124
				939.9	-53.026

4K00F1E, 4K00F1D, 4K00F7W

No.	Frequency (MHz)	Channel	Power Mode	Spurious Frequency (MHz)	Correct Level (dBm)
1	406.15	Low	High Power	933.07	-52.971
2	429.95	Middle	High Power	2451.2	-47.526
3	469.95	High	High Power	939.9	-52.127
4	406.15	Low	Low Power	107.6	-44.824
5	429.95	Middle	Low Power	113.42	-47.105
6	469.95	High	Low Power	110.51	-48.848
				939.9	-53.227

4K00F2D

No.	Frequency (MHz)	Channel	Power Mode	Spurious Frequency (MHz)	Correct Level (dBm)
1	406.15	Low	High Power	-	-
2	429.95	Middle	High Power	-	-
3	469.95	High	High Power	-	-
4	406.15	Low	Low Power	113.42	-45.522
5	429.95	Middle	Low Power	108.57	-47.055
6	469.95	High	Low Power	112.45	-48.191
				939.9	-52.562

TEST RESULTS For IC

16K0F3E

No.	Frequency (MHz)	Channel	Power Mode	Spurious Frequency (MHz)	Correct Level (dBm)
1	406.15	Low	High Power	2454.2	-45.603
2	418.05	Middle	High Power	3180.2	-47.715
3	429.95	High	High Power	501.42	-52.837
4	450.05	Low	High Power	900.1	-58.039
5	460.05	Middle	High Power	920.1	-50.524
6	469.95	High	High Power	939.9	-56.785
7	406.15	Low	Low Power	111.48	-45.641
				2450.2	-45.78
8	418.05	Middle	Low Power	109.54	-46.502
9	429.95	High	Low Power	107.6	-47.436
10	450.05	Low	Low Power	113.42	-48.411
				900.1	-59.587
				2453.2	-46.488
11	460.05	Middle	Low Power	115.36	-47.949
				920.1	-53.767
12	469.95	High	Low Power	112.45	-48.007
				939.9	-59.627

11K0F3E

No.	Frequency (MHz)	Channel	Power Mode	Spurious Frequency (MHz)	Correct Level (dBm)
1	418.05	Low	High Power	836.1	-62.727
2	450.05	Middle	High Power	900.1	-57.956
3	460.05	High	High Power	920.1	-50.547
4	418.05	Low	Low Power	108.57	-46.699
5	450.05	Middle	Low Power	112.45	-48.038
				900.1	-59.325
6	460.05	High	Low Power	110.51	-48.372
				920.1	-53.612

8K30F1E, 8K30F1D, 8K30F7W

No.	Frequency (MHz)	Channel	Power Mode	Spurious Frequency (MHz)	Correct Level (dBm)
1	418.05	Low	High Power	164.83	-52.550
2	450.05	Middle	High Power	900.10	-52.133
3	460.05	High	High Power	920.10	-47.481
4	418.05	Low	Low Power	111.48	-47.644
5	450.05	Middle	Low Power	113.42	-47.421
6	460.05	High	Low Power	114.39	-48.042
				920.10	-49.973

8K10F1W

No.	Frequency (MHz)	Channel	Power Mode	Spurious Frequency (MHz)	Correct Level (dBm)
1	418.05	Low	High Power	499.48	-53.013
2	450.05	Middle	High Power	900.10	-52.285
3	460.05	High	High Power	920.10	-47.501
4	418.05	Low	Low Power	113.42	-46.489
5	450.05	Middle	Low Power	112.45	-47.767
6	460.05	High	Low Power	114.39	-48.354
				920.10	-49.990

8K10F1E, 8K10F1D

No.	Frequency (MHz)	Channel	Power Mode	Spurious Frequency (MHz)	Correct Level (dBm)
1	418.05	Low	High Power	705.12	-52.706
2	450.05	Middle	High Power	900.10	-52.149
3	460.05	High	High Power	920.10	-47.906
4	418.05	Low	Low Power	106.63	-45.808
5	450.05	Middle	Low Power	112.45	-47.961
6	460.05	High	Low Power	111.48	-48.139
				920.10	-49.781

4K00F1E, 4K00F1D, 4K00F7W

No.	Frequency (MHz)	Channel	Power Mode	Spurious Frequency (MHz)	Correct Level (dBm)
1	418.05	Low	High Power	157.07	-52.54
2	450.05	Middle	High Power	900.10	-52.368
3	460.05	High	High Power	920.10	-47.524
4	418.05	Low	Low Power	108.57	-45.196
5	450.05	Middle	Low Power	112.45	-46.977
6	460.05	High	Low Power	112.45	-47.558
				920.10	-50.223

4K00F2D

No.	Frequency (MHz)	Channel	Power Mode	Spurious Frequency (MHz)	Correct Level (dBm)
1	418.05	Low	High Power	-	-
2	450.05	Middle	High Power	-	-
3	460.05	High	High Power	-	-
4	418.05	Low	Low Power	105.66	-46.613
5	450.05	Middle	Low Power	112.45	-48.136
6	460.05	High	Low Power	112.45	-49.266
				920.10	-50.012

TEST PLOT For FCC

*Note : Worst Case is 4K00F1E, 4K00F1D, 4K00F7W all of the modulation

4K00F1E, 4K00F1D, 4K00F7W_406.15 MHz_HIGH POWER

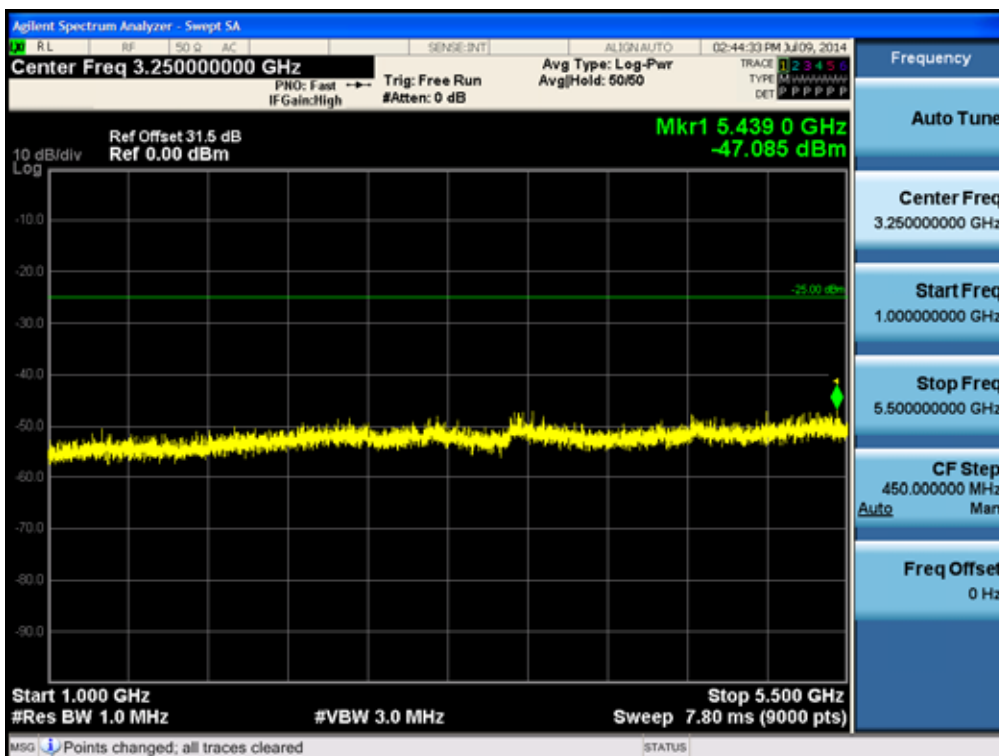
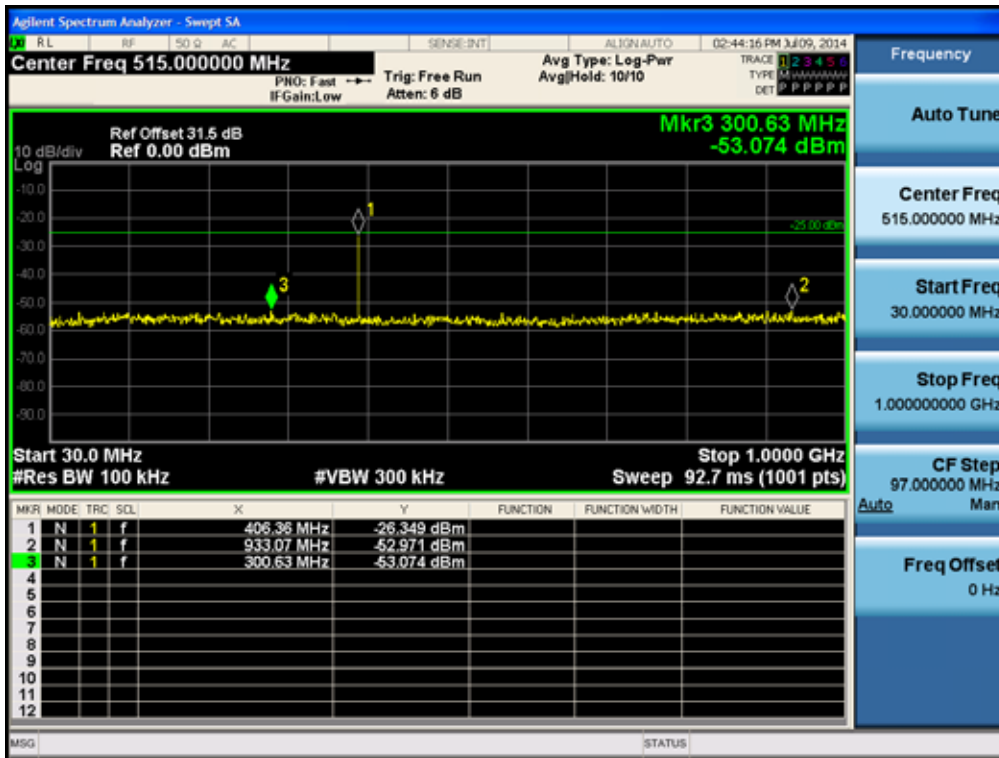

4K00F1E, 4K00F1D, 4K00F7W_406.15 MHz_LOW POWER

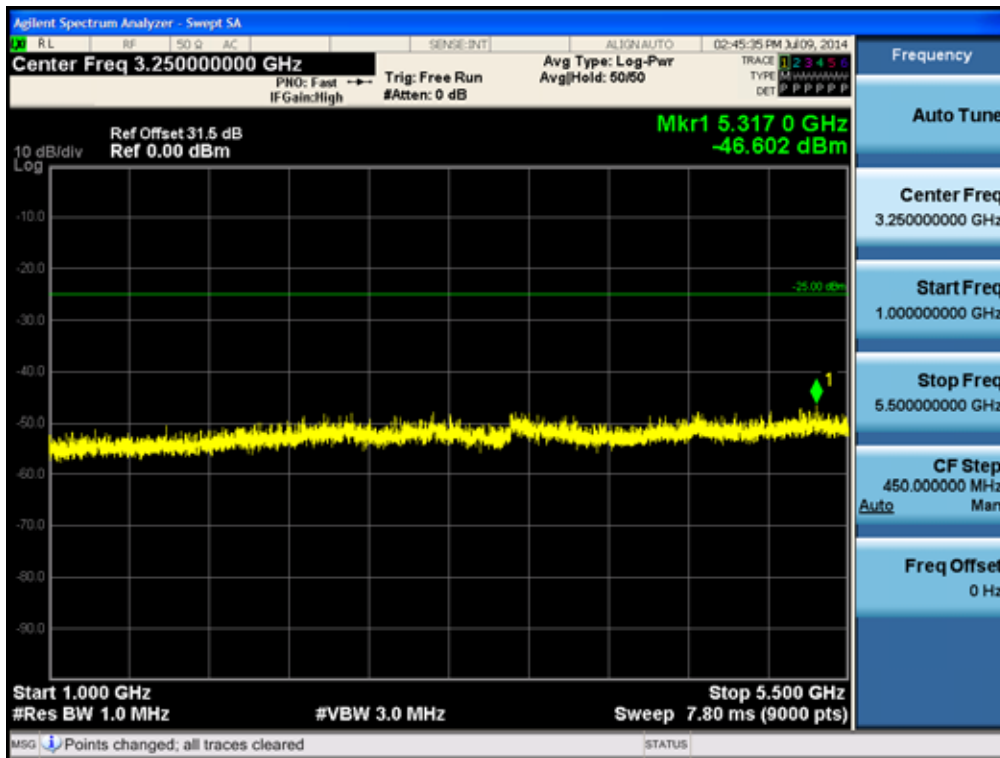
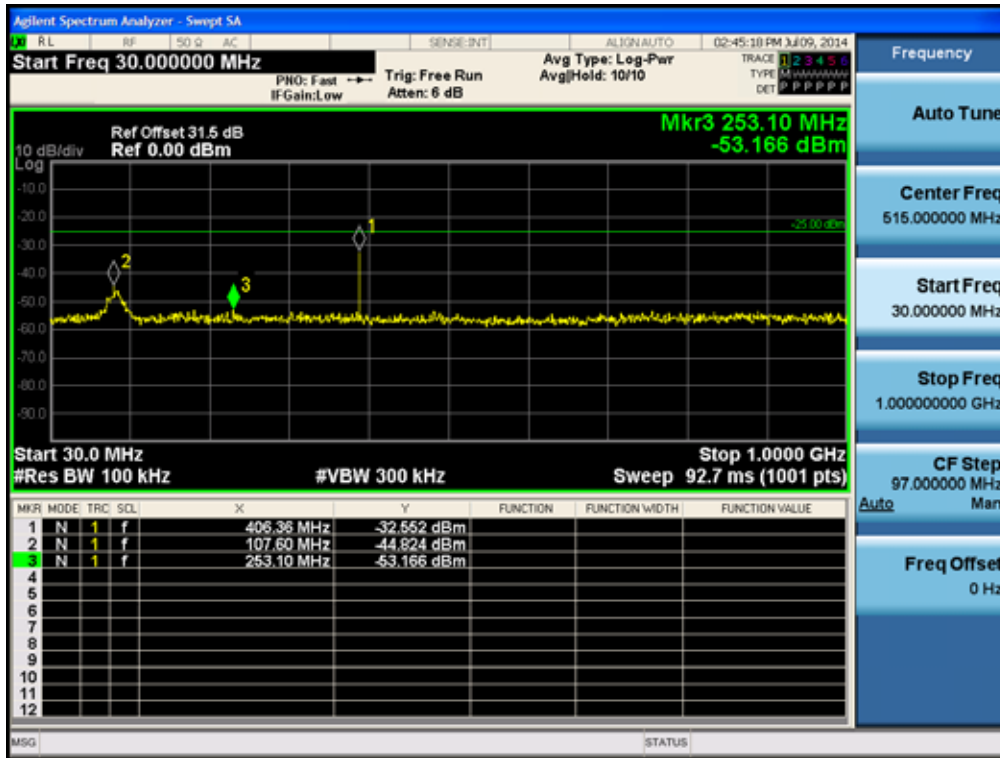

4K00F1E, 4K00F1D, 4K00F7W_429.95 MHz_HIGH POWER

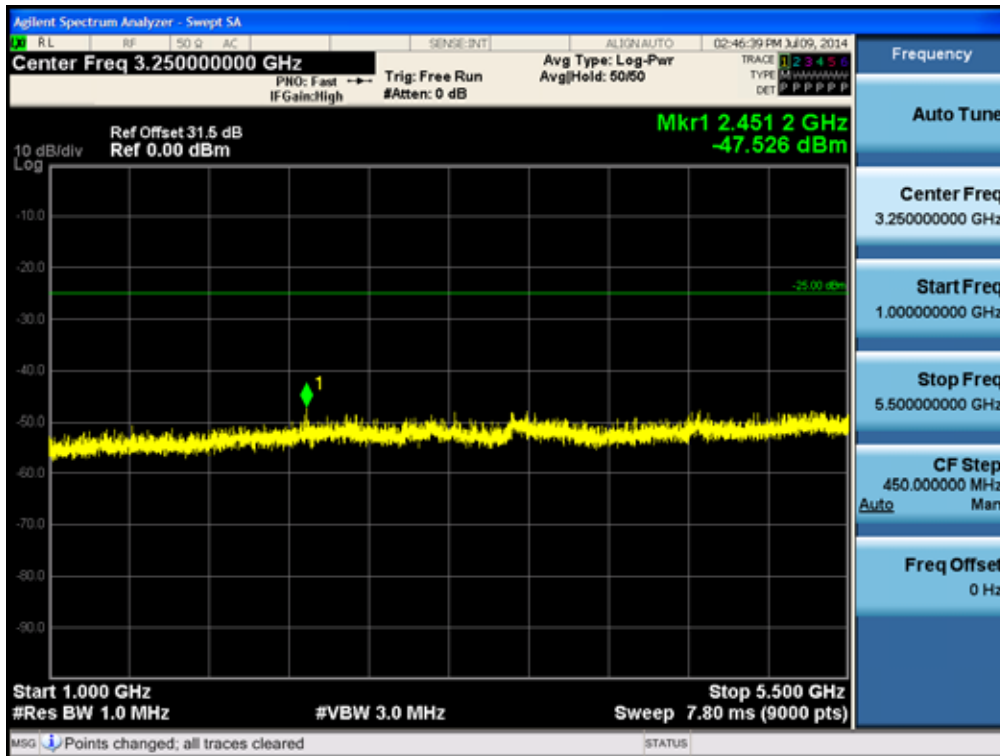
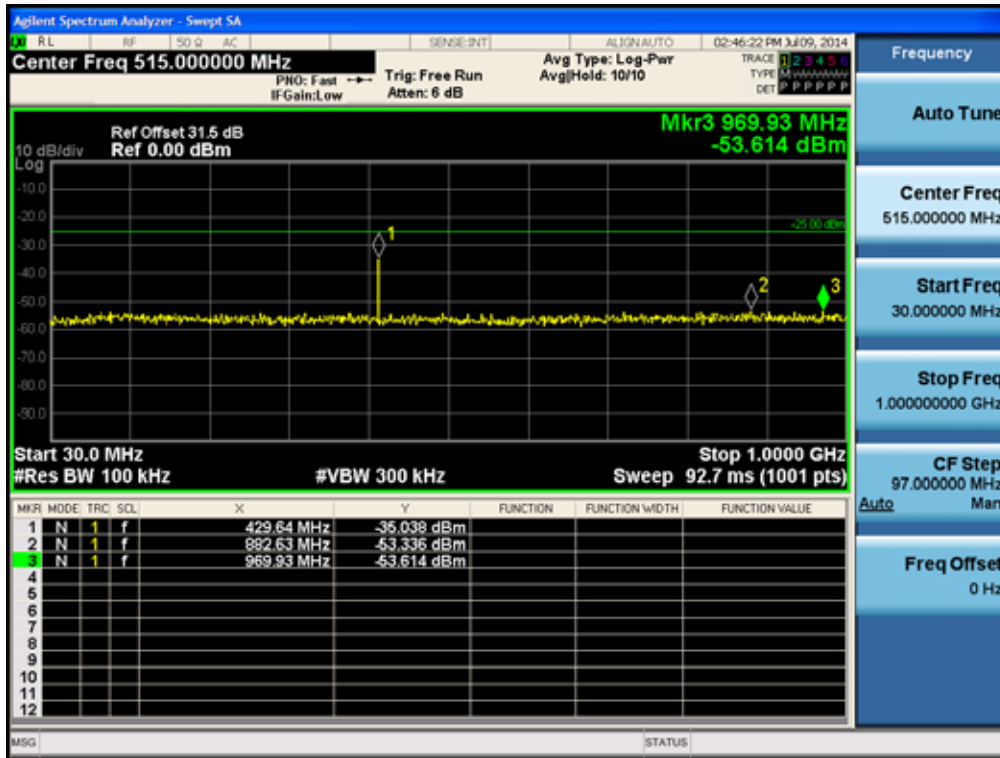

4K00F1E, 4K00F1D, 4K00F7W_429.95 MHz_LOW POWER

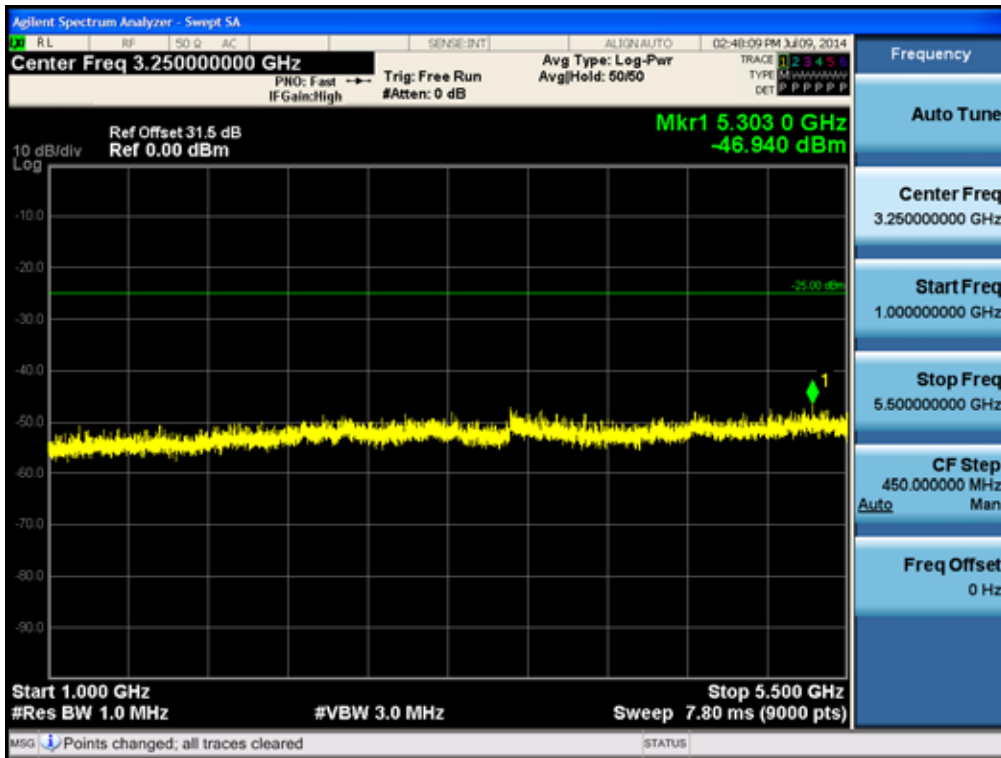
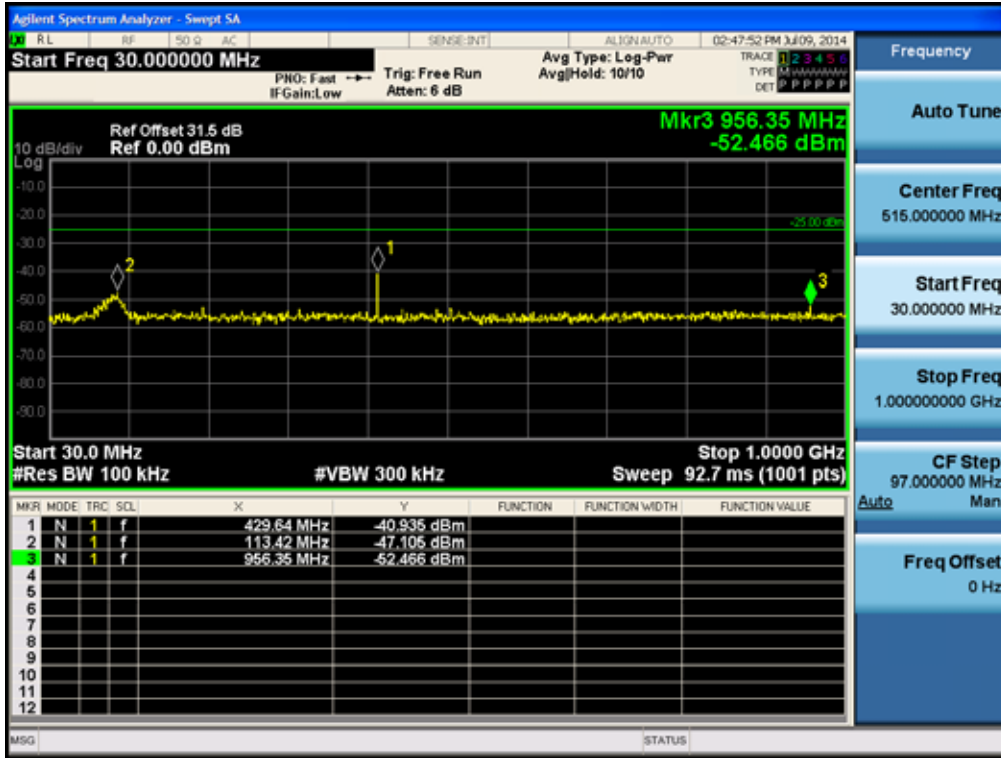

4K00F1E, 4K00F1D, 4K00F7W_469.95 MHz_HIGH POWER

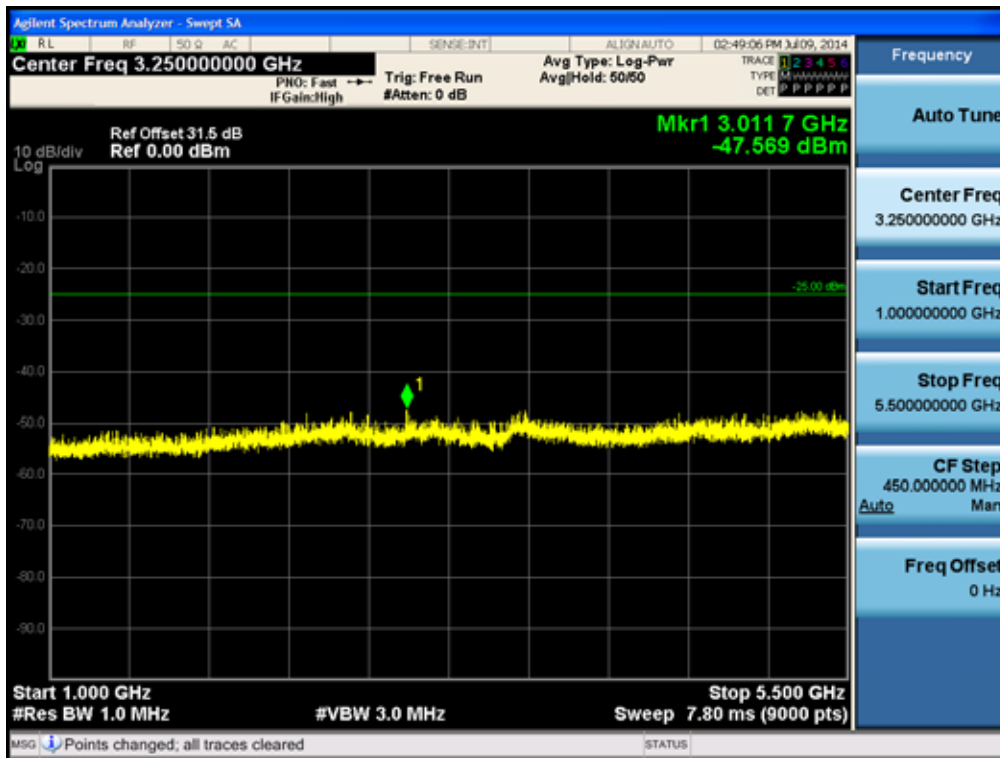
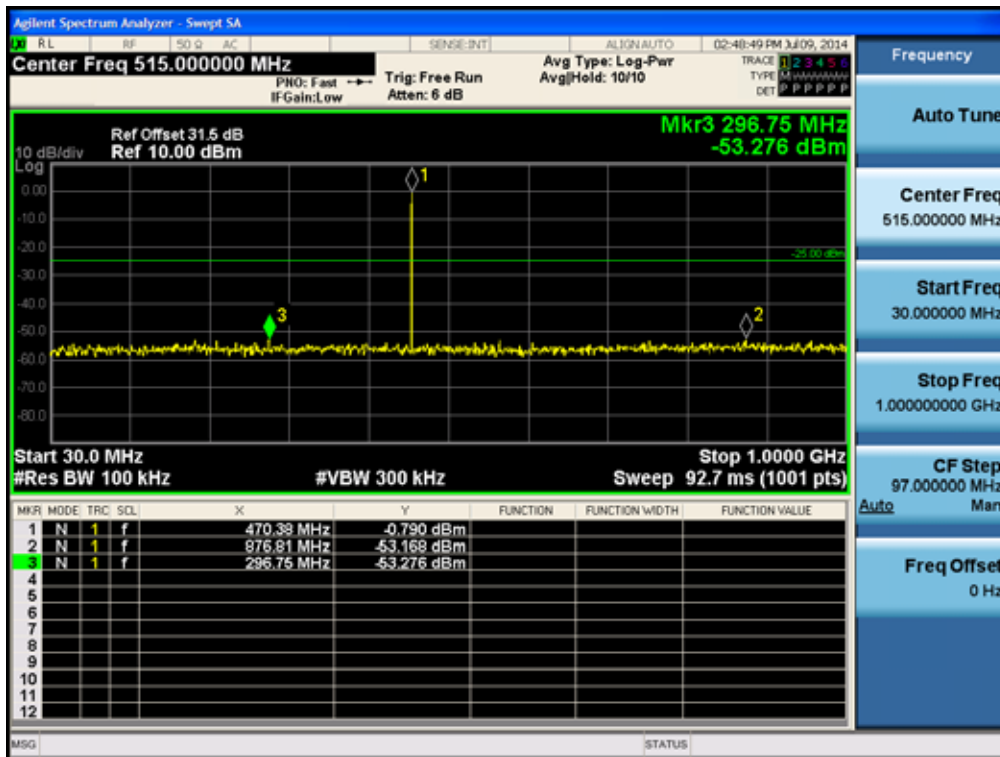

4K00F1E, 4K00F1D, 4K00F7W_469.95 MHz_LOW POWER

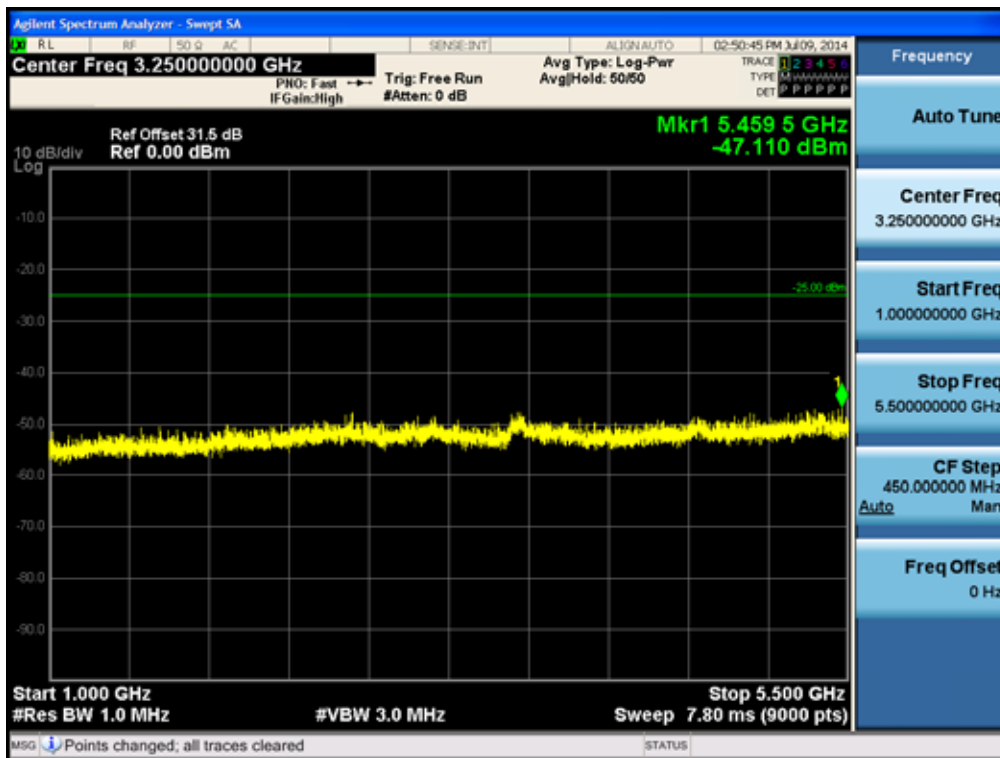
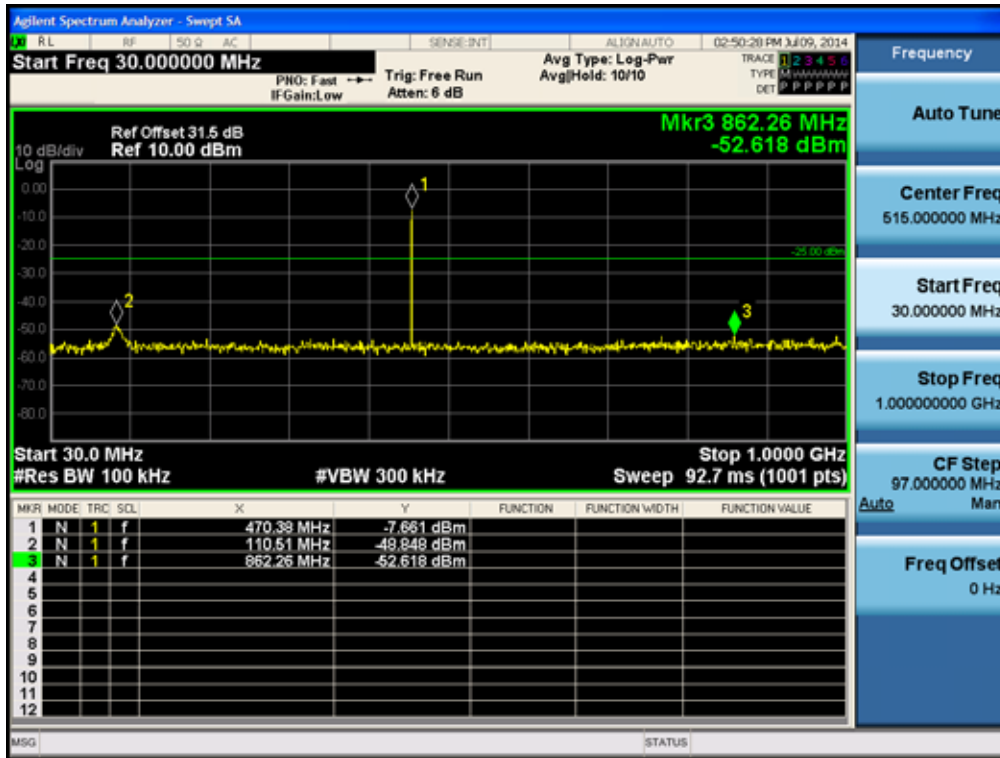

TEST PLOT For IC

4K00F1E, 4K00F1D, 4K00F7W_418.05 MHz_HIGH POWER

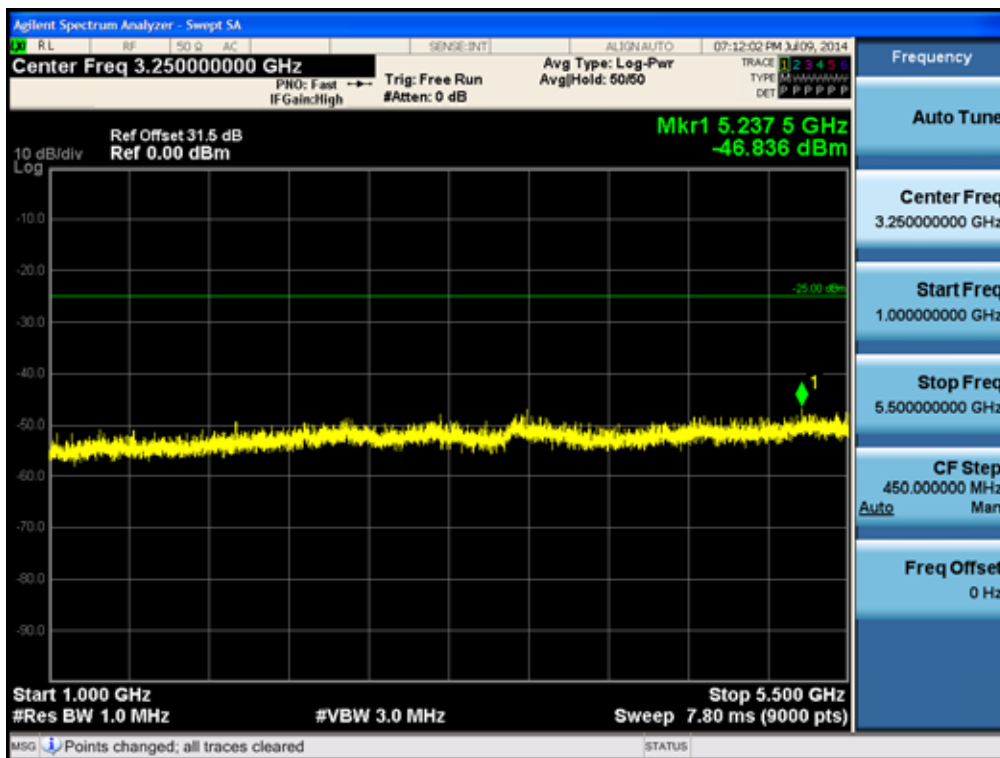
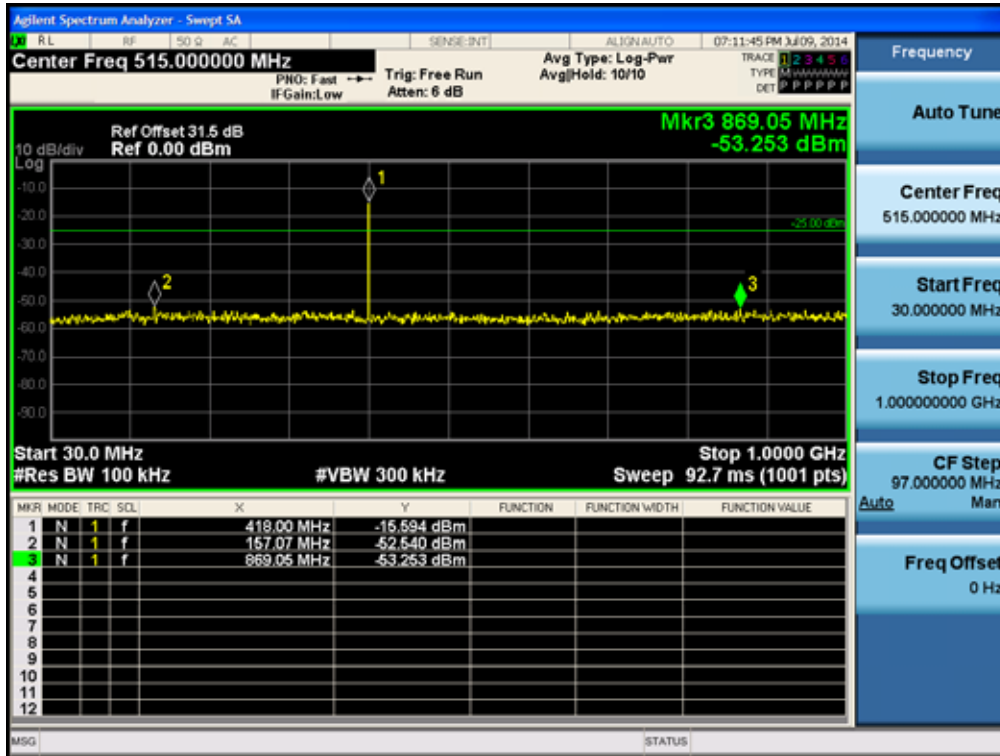

4K00F1E, 4K00F1D, 4K00F7W_418.05 MHz_LOW POWER

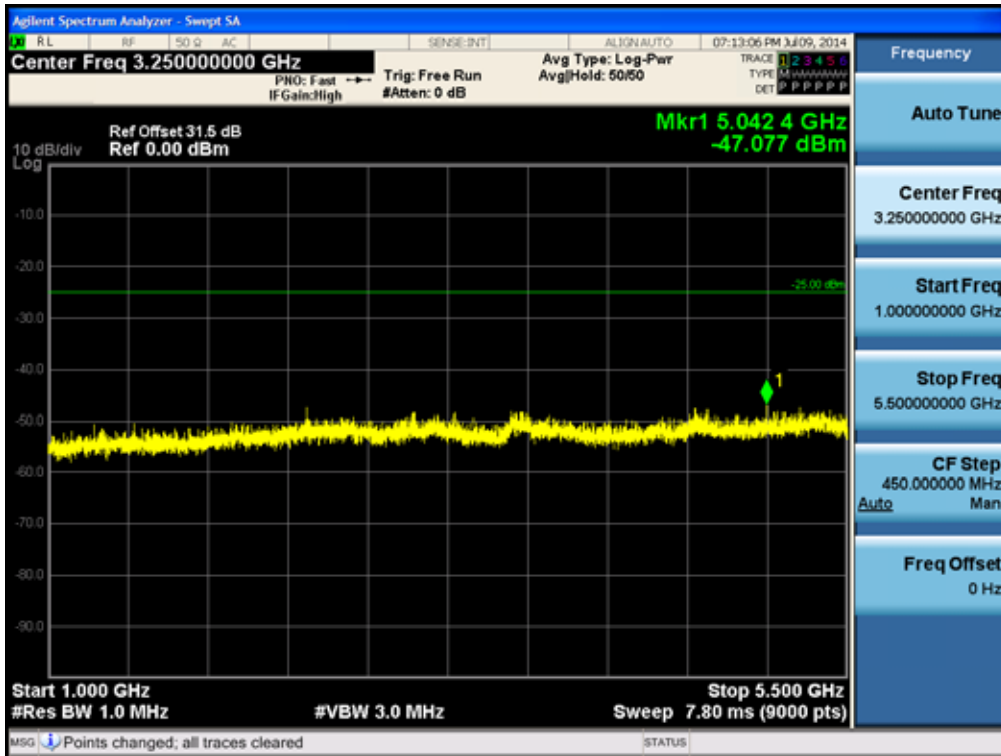
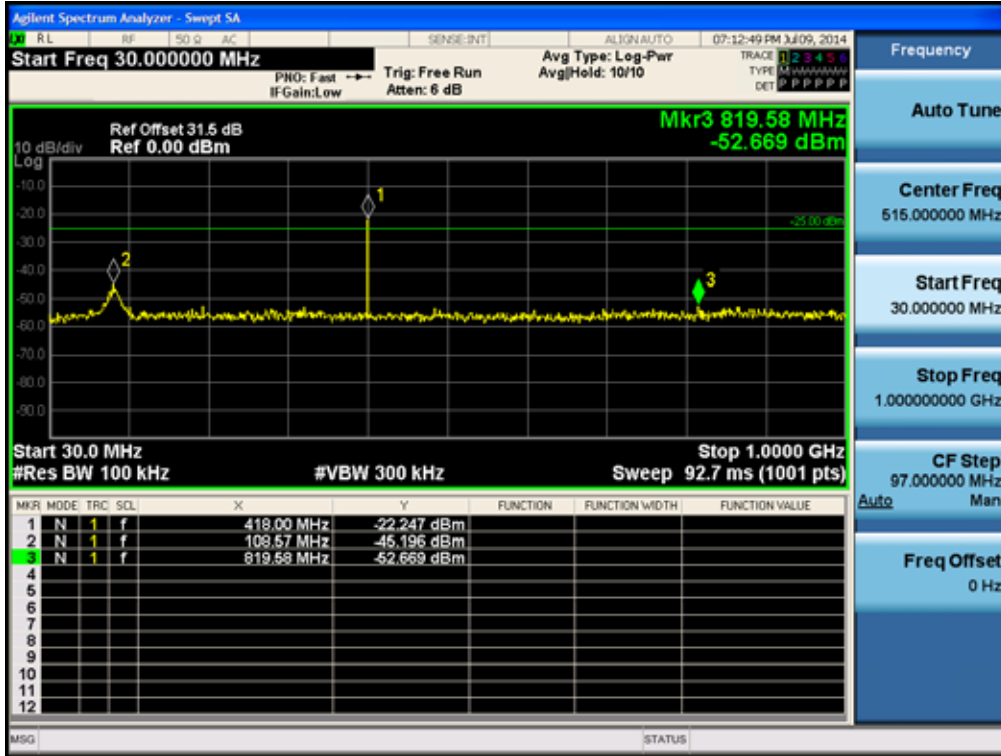

4K00F1E, 4K00F1D, 4K00F7W_450.05 MHz_HIGH POWER

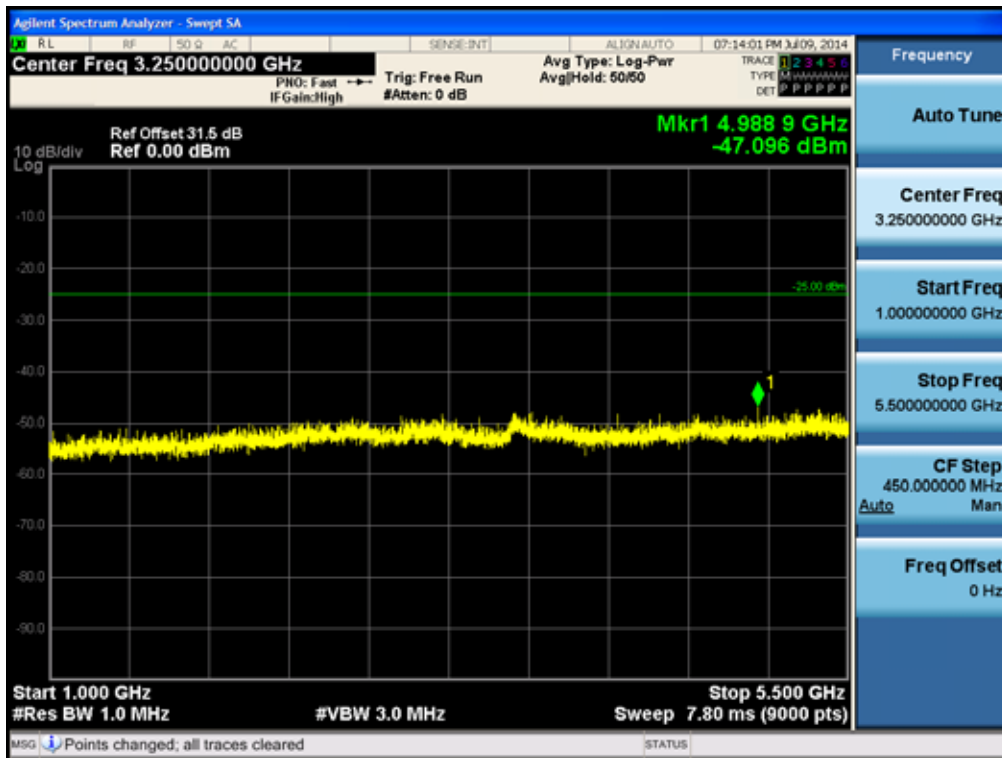
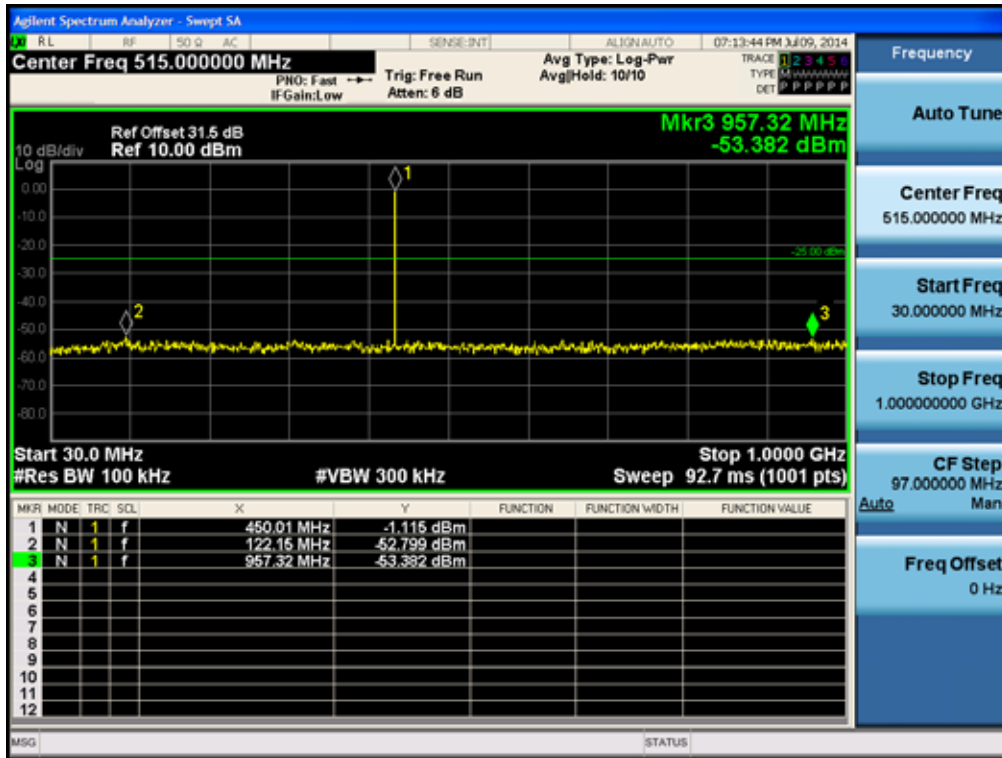

4K00F1E, 4K00F1D, 4K00F7W_450.05 MHz_LOW POWER

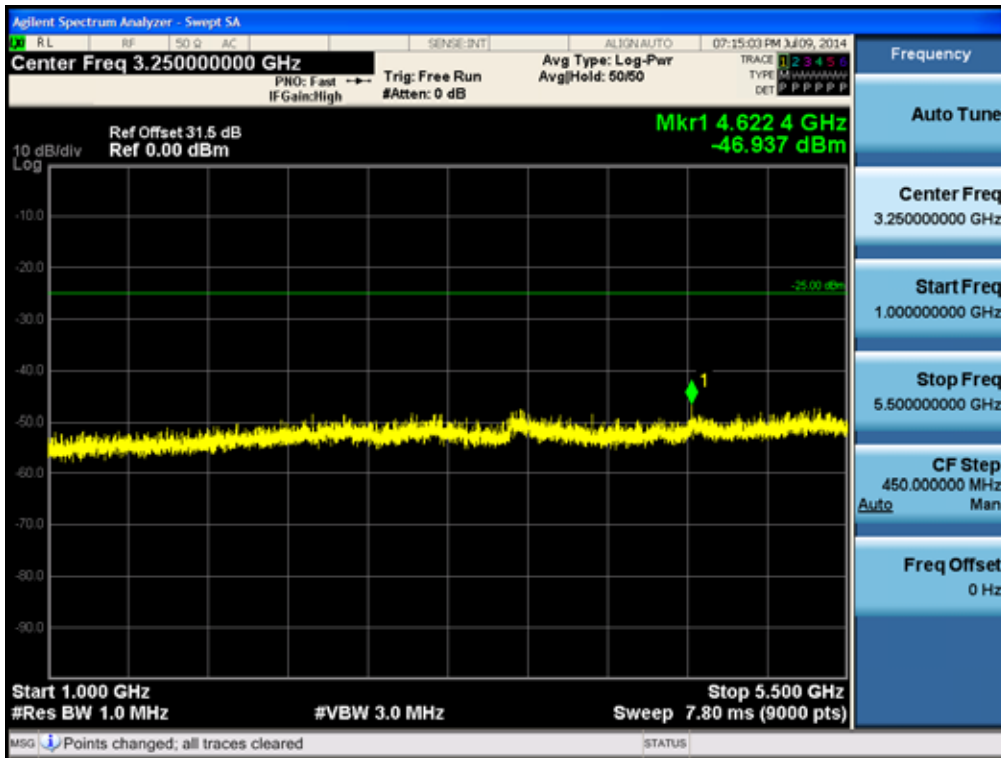
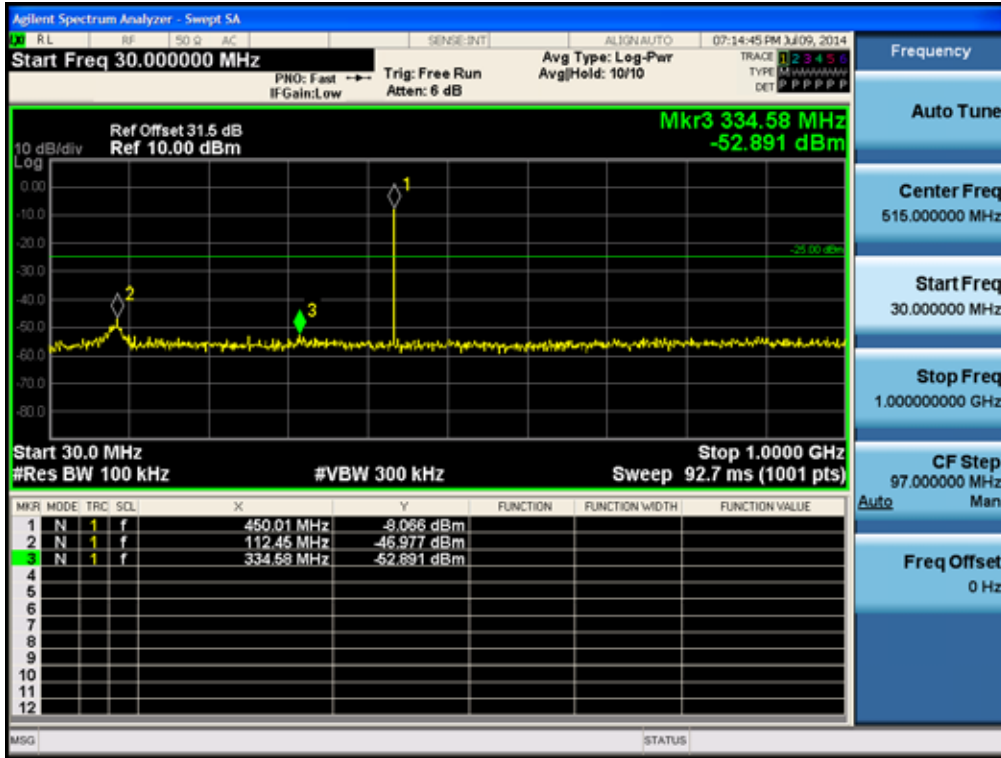

4K00F1E, 4K00F1D, 4K00F7W_460.05 MHz_HIGH POWER

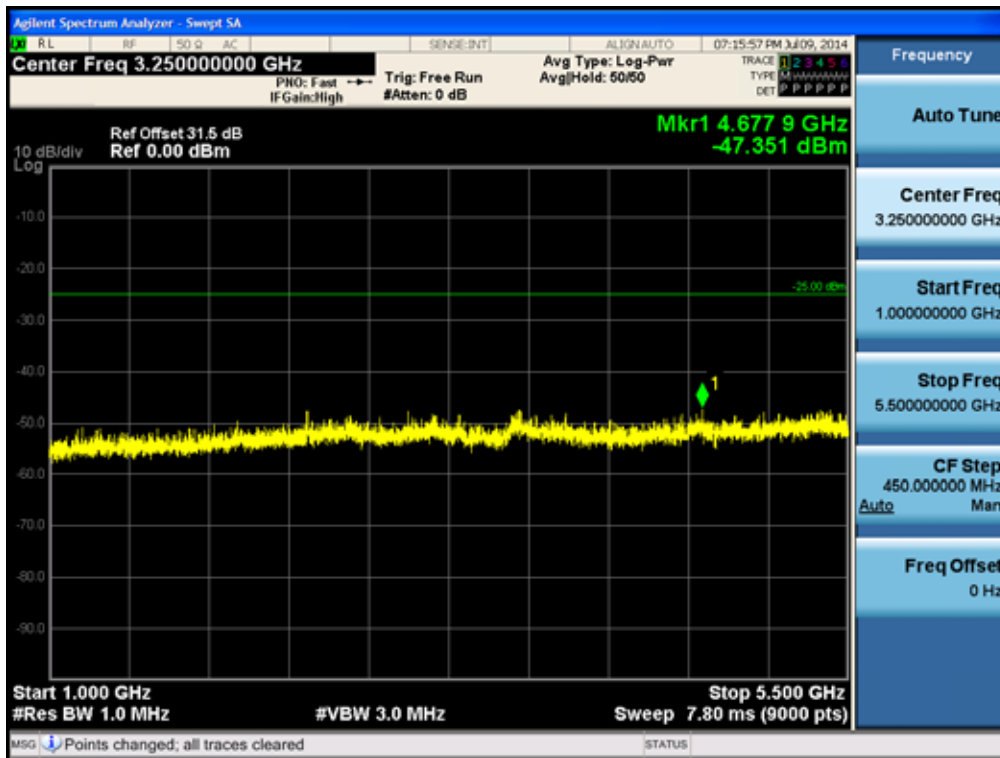
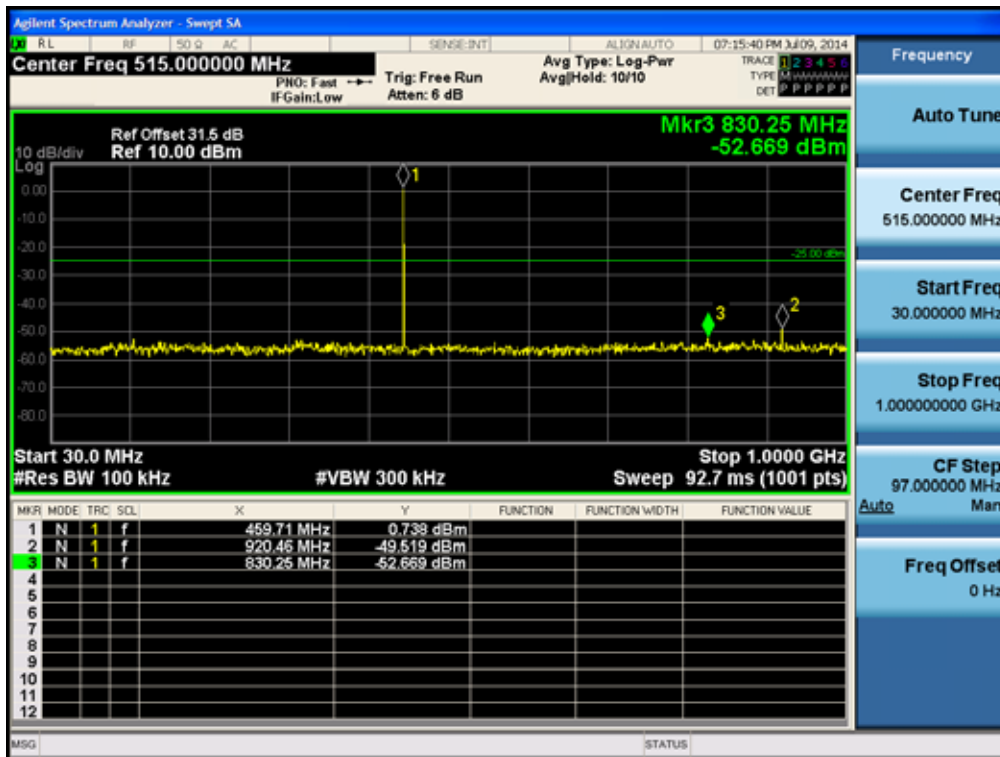

4K00F1E, 4K00F1D, 4K00F7W_460.05 MHz_LOW POWER

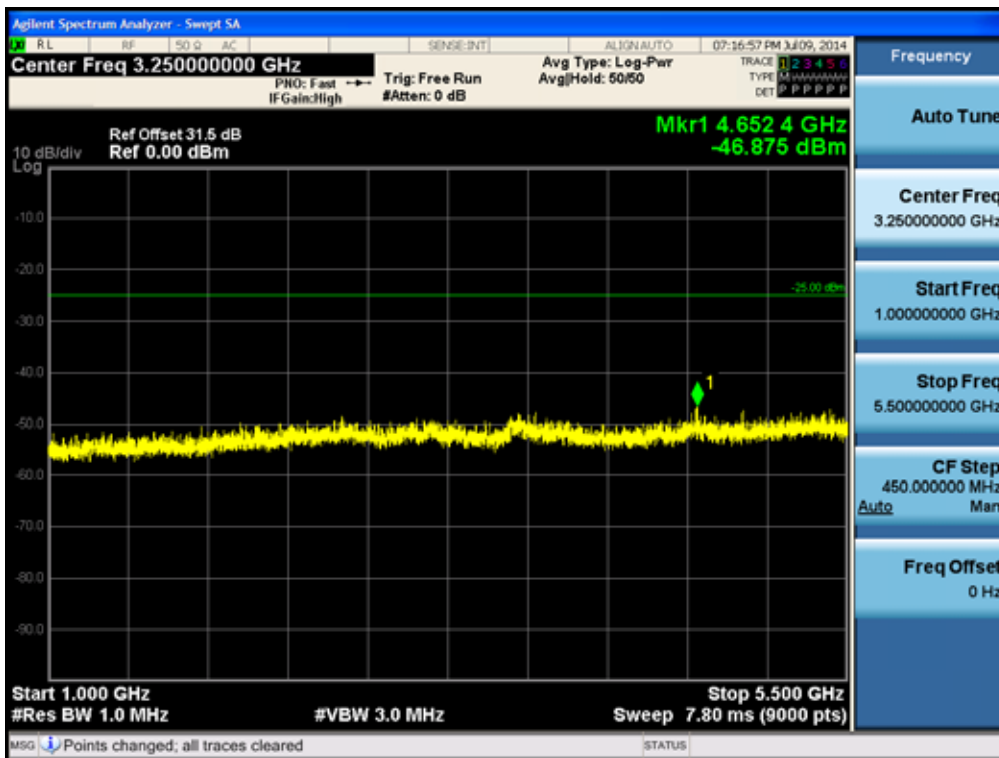
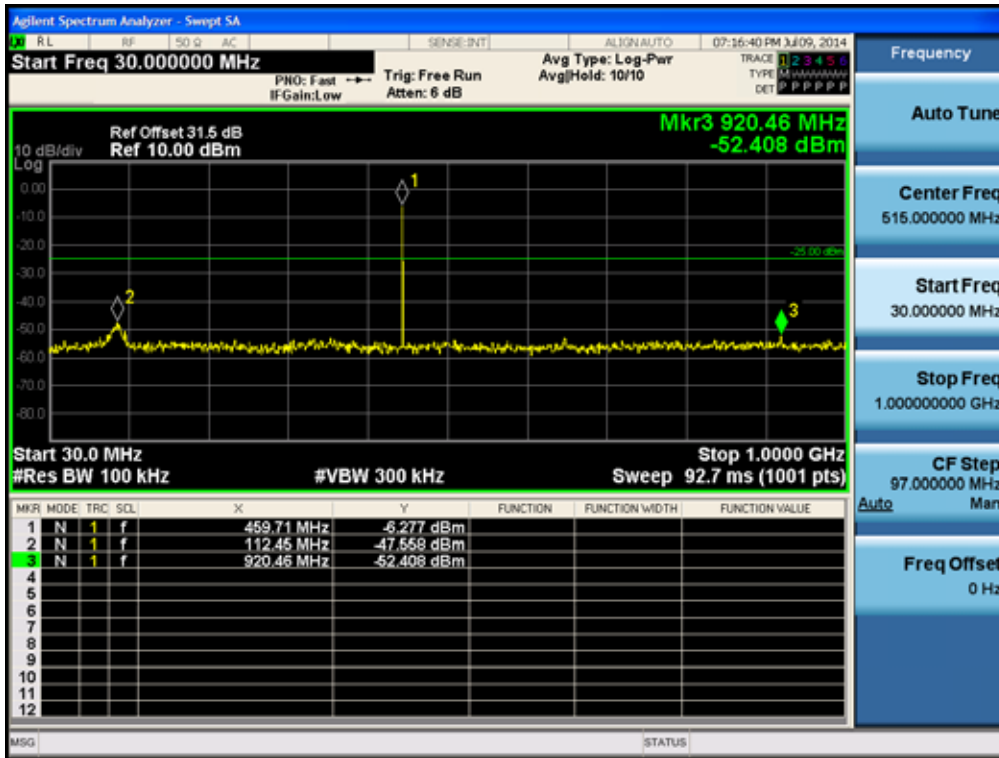

7.9 Unwanted Emissions : Radiated Spurious Emission

Definition

Radiated spurious emissions are emissions from the equipment when transmitting into a non-radiating load on a frequency or frequencies that are outside an occupied band sufficient to ensure transmission of information of required quality for the class of communications desired.

TEST CONFIGURATION

Below 30 MHz

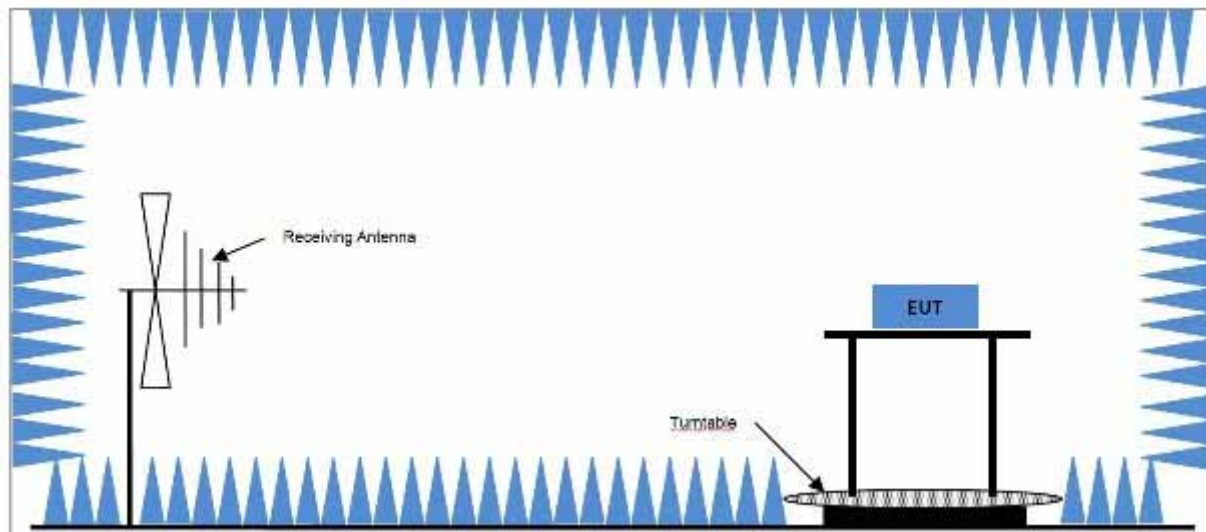

Above 1 GHz

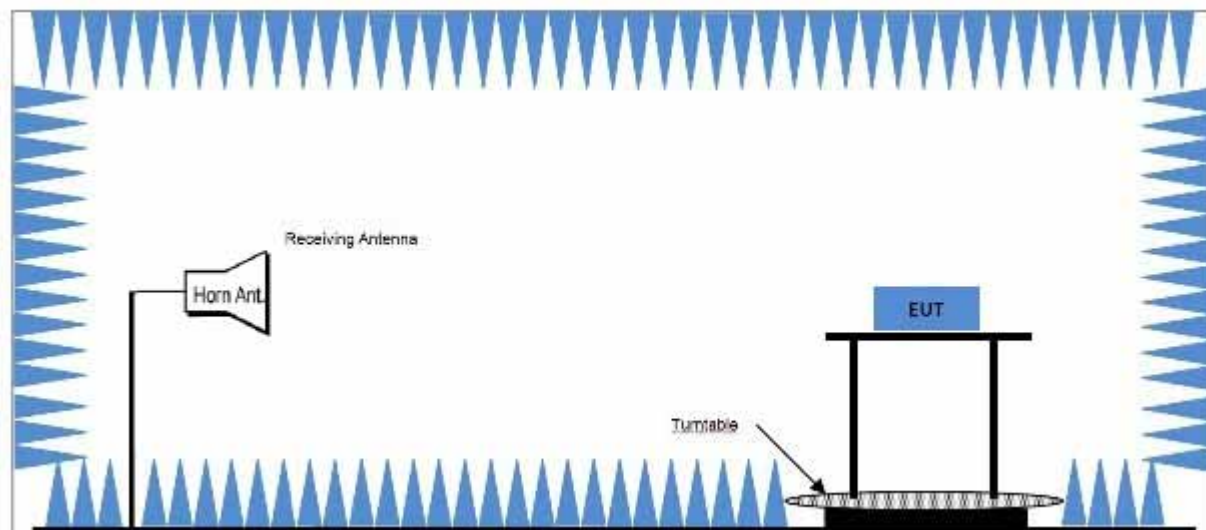

TEST PROCEDURE USED

According to 2.2.12 in TIA-603-D Standard.

- Connect the equipment as illustrated.
- Adjust the spectrum analyzer for the following settings:

- 1) Resolution Bandwidth = 10 kHz for spurious emissions below 1 GHz, and 1 MHz for spurious emissions above 1GHz.
 - 2) Video Bandwidth = 300 kHz for spurious emissions below 1 GHz, and 3 MHz for spurious emissions above 1 GHz.
 - 3) Sweep Speed slow enough to maintain measurement calibration.
 - 4) Detector Mode = Positive Peak.
- c) Place the transmitter to be tested on the turntable in the standard test site, or an FCC listed site compliant with ANSI C63.4-2001 clause 5.4. The transmitter is transmitting into a nonradiating load that is placed on the turntable. The RF cable to this load should be of minimum length. For transmitters with integral antennas, the tests are to be run with the unit operating into the integral antenna.
- d) For each spurious measurement the test antenna should be adjusted to the correct length for the frequency involved. This length may be determined from a calibration ruler supplied with the equipment. Measurements shall be made from the lowest radio frequency generated in the equipment to the tenth harmonic of the carrier, except for the region close to the carrier equal to \pm the test bandwidth (see 1.3.4.4).
- e) Key the transmitter.
- f) For each spurious frequency, raise and lower the test antenna from 1 m to 4 m to obtain a maximum reading on the spectrum analyzer with the test antenna at horizontal polarity. Then the turntable should be rotated 360° to determine the maximum reading.
Repeat this procedure to obtain the highest possible reading. Record this maximum reading.
- g) Repeat step f) for each spurious frequency with the test antenna polarized vertically.
- h) Reconnect the equipment as illustrated.
- i) Keep the spectrum analyzer adjusted as in step b).
- j) Remove the transmitter and replace it with a substitution antenna (the antenna should be half-wavelength for each frequency involved). The center of the substitution antenna should be approximately at the same location as the center of the transmitter. At the lower frequencies, where the substitution antenna is very long, this will be impossible to achieve when the antenna is polarized vertically. In such case the lower end of the antenna should be 0.3 m above the ground.
- k) Feed the substitution antenna at the transmitter end with a signal generator connected to the antenna by means of a nonradiating cable. With the antennas at both ends horizontally polarized, and with the signal generator tuned to a particular spurious frequency, raise and lower the test antenna to obtain a maximum reading at the spectrum analyzer. Adjust the level of the signal generator output until the previously recorded maximum reading for this set of conditions is obtained. This should be done carefully repeating the adjustment of the test antenna and generator output.

- l) Repeat step k) with both antennas vertically polarized for each spurious frequency.
- m) Calculate power in dBm into a reference ideal half-wave dipole antenna by reducing the readings obtained in steps k) and l) by the power loss in the cable between the generator and the antenna, and further corrected for the gain of the substitution antenna used relative to an ideal half-wave dipole antenna by the following formula:

$$Pd(\text{dBm}) = Pg(\text{dBm}) - \text{cable loss (dB)} + \text{antenna gain (dB)}$$

where:

Pd is the dipole equivalent power and

Pg is the generator output power into the substitution antenna.

- n) The Pd levels record in step m) are the absolute levels of radiated spurious emissions in dBm. The radiated spurious emissions in dB can be calculated by the following:

Radiated spurious emissions (dB) =

$$10 \cdot \log_{10}(\text{TX power in watts}/0.001) - \text{the levels in step m)}$$

NOTE: It is permissible to use other antennas provided they can be referenced to a dipole.

TEST RESULTS For FCC

11K0F3E

Frequency [MHz] F1 : 406.15

Battery : EX-4621 Antenna : KRA23-M3

Freq (MHz)	Reading [dBm]	Factor (dBm)	Reading+Factor[dBm]	Pol	Result (dB)	Limit (dB)	Margin (dB)
406.15	5.56	24.95	30.51	X-H	0.00	-	-
812.3	-82.58	31.06	-51.52	X-H	82.03	50.51	31.52
1218.45	-53.41	-1.71	-55.12	X-V	85.63	50.51	35.12
1624.6	-39.84	-0.74	-40.58	X-V	71.09	50.51	20.58
2030.75	-48.09	2.61	-45.48	X-V	75.99	50.51	25.48
2843.05	-49.83	3.45	-46.38	X-V	76.89	50.51	26.38
3249.2	-51.98	3.94	-48.04	X-V	78.55	50.51	28.04
4061.5	-52.02	5.63	-46.39	X-V	76.90	50.51	26.39

*Note :

1. Worst Case is 11K0F3E all of the modulation.
2. Limit = Reading + Factor + (P – 50 log (P))

11K0F3E

Frequency [MHz] F1 : 406.15

Battery : EX-4622 Antenna : KRA23-M3

Freq (MHz)	Reading [dBm]	Factor (dBm)	Reading+Factor [dBm]	Pol	Result (dB)	Limit (dB)	Margin (dB)
406.15	5.96	24.95	30.91	X-H	0.00	-	-
812.3	-83.46	31.06	-52.40	X-H	83.31	50.91	32.40
1218.45	-51.37	-1.71	-53.08	X-V	83.99	50.91	33.08
1624.6	-38.26	-0.74	-39.00	X-V	69.91	50.91	19.00
2030.75	-48.22	2.61	-45.61	X-V	76.52	50.91	25.61
2843.05	-48.99	3.45	-45.54	X-V	76.45	50.91	25.54
3249.2	-52.59	3.94	-48.65	X-V	79.56	50.91	28.65
3655.35	-55.18	4.84	-50.34	X-V	81.25	50.91	30.34
4061.5	-51.62	5.63	-45.99	X-V	76.90	-30.34	107.24

*Note :

1. Worst Case is 11K0F3E all of the modulation.
2. Limit = Reading + Factor + (P – 50 log (P))

11K0F3E

Frequency [MHz] F1 : 406.15
 Battery : EX-4623 Antenna : KRA23-M3

Freq (MHz)	Reading [dBm]	Factor (dBm)	Reading+Factor [dBm]	Pol	Result (dB)	Limit (dB)	Margin (dB)
406.15	6	24.95	30.95	X-H	0.00	-	-
812.3	-79	31.06	-47.94	X-H	78.89	50.95	27.94
1218.45	-50.51	-1.71	-52.22	X-V	83.17	50.95	32.22
1624.6	-37.73	-0.74	-38.47	X-V	69.42	50.95	18.47
2030.75	-42.34	2.61	-39.73	X-V	70.68	50.95	19.73
2843.05	-48.87	3.45	-45.42	X-V	76.37	50.95	25.42
3249.2	-53.09	3.94	-49.15	X-V	80.10	50.95	29.15
3655.35	-53.42	4.84	-48.58	X-V	79.53	50.95	28.58
4061.5	-50.86	5.63	-45.23	X-V	76.18	50.95	25.23

*Note :

1. Worst Case is 11K0F3E all of the modulation.
2. Limit = Reading + Factor +(P – 50 log (P))

11K0F3E

Frequency [MHz] F2 : 429.95

Battery : EX-4621 Antenna : KRA23-M3

Freq (MHz)	Reading [dBm]	Factor (dBm)	Reading+Factor [dBm]	Pol	Result (dB)	Limit (dB)	Margin (dB)
429.95	8.41	25.55	33.96	Y-V	0.00	-	-
859.9	-77.28	31.13	-46.15	Y-V	80.11	53.96	26.15
1289.85	-50.47	-0.96	-51.43	X-V	85.39	53.96	31.43
1719.8	-44.8	-0.89	-45.69	X-V	79.65	53.96	25.69
2149.75	-52.16	2.57	-49.59	X-V	83.55	54.96	28.59
2579.7	-54.56	2.3	-52.26	X-V	86.22	53.96	32.26
3009.65	-52.88	4.06	-48.82	X-V	82.78	55.96	26.82
3439.6	-53.34	3.9	-49.44	X-V	83.40	53.96	29.44
3869.55	-55.81	5.81	-50.00	X-V	83.96	56.96	27.00
4299.5	-51.81	6.19	-45.62	X-V	79.58	53.96	25.62

*Note :

1. Worst Case is 11K0F3E all of the modulation.
2. Limit = Reading + Factor + (P – 50 log (P))

11K0F3E

Frequency [MHz] F2 : 429.95

Battery : EX-4622 Antenna : KRA23-M3

Freq (MHz)	Reading [dBm]	Factor (dBm)	Reading+Factor [dBm]	Pol	Result (dB)	Limit (dB)	Margin (dB)
429.95	8.39	25.55	33.94	Y-V	0.00	-	-
859.9	-78.38	31.13	-47.25	Y-V	81.19	53.94	27.25
1289.85	-46.6	-0.96	-47.56	X-V	81.50	53.94	27.56
1719.8	-45.82	-0.89	-46.71	X-V	80.65	53.94	26.71
2149.75	-50.73	2.57	-48.16	X-V	82.10	53.94	28.16
2579.7	-54.64	2.3	-52.34	X-V	86.28	53.94	32.34
3009.65	-53.67	4.06	-49.61	X-V	83.55	53.94	29.61
3439.6	-53.03	3.9	-49.13	X-V	83.07	53.94	29.13
4299.5	-51.32	6.19	-45.13	X-V	79.07	53.94	25.13

*Note :

1. Worst Case is 11K0F3E all of the modulation.
2. Limit = Reading + Factor + (P – 50 log (P))

11K0F3E

Frequency [MHz] F2 : 429.95

Battery : EX-4623 Antenna : KRA23-M3

Freq (MHz)	Reading [dBm]	Factor (dBm)	Reading+Factor [dBm]	Pol	Result (dB)	Limit (dB)	Margin (dB)
429.95	8.28	25.55	33.83	Y-V	0.00	-	-
859.9	-74.39	31.13	-43.26	Y-V	77.09	53.83	23.26
1289.85	-47.95	-0.96	-48.91	X-V	82.74	53.83	28.91
1719.8	-46.25	-0.89	-47.14	X-V	80.97	53.83	27.14
2149.75	-48.11	2.57	-45.54	X-V	79.37	53.83	25.54
2579.7	-54.37	2.3	-52.07	X-V	85.90	53.83	32.07
3009.65	-54.61	4.06	-50.55	X-V	84.38	53.83	30.55
3439.6	-51.81	3.9	-47.91	X-V	81.74	53.83	27.91
4299.5	-51.97	6.19	-45.78	X-V	79.61	53.83	25.78

*Note :

1. Worst Case is 11K0F3E all of the modulation.
2. Limit = Reading + Factor + (P – 50 log (P))

11K0F3E

Frequency [MHz] F2 : 469.95

Battery : EX-4621 Antenna : KRA23-M(No.5)

Freq (MHz)	Reading [dBm]	Factor (dBm)	Reading+Factor [dBm]	Pol	Result (dB)	Limit (dB)	Margin (dB)
469.95	8.08	26.18	34.26	Y-V	0.00	-	-
939.9	-75.49	32.83	-42.66	Y-V	76.92	54.26	22.66
1409.85	-50.47	0.55	-49.92	Y-H	84.18	54.26	29.92
1879.8	-36.67	-0.42	-37.09	Y-H	71.35	54.26	17.09
2349.75	-50.14	2.68	-47.46	Y-H	81.72	54.26	27.46
2819.7	-50.25	3.19	-47.06	Y-H	81.32	54.26	27.06
3289.65	-52.38	3.47	-48.91	Y-H	83.17	54.26	28.91
3759.6	-49.77	5.31	-44.46	Y-H	78.72	54.26	24.46
4229.55	-51.52	6.32	-45.20	Y-H	79.46	54.26	25.20
4699.5	-50.66	8.04	-42.62	Y-H	76.88	54.26	22.62

*Note :

1. Worst Case is 11K0F3E all of the modulation.
2. Limit = Reading + Factor + (P – 50 log (P))

11K0F3E

Frequency [MHz] F3 : 469.95 Battery : EX-4622 Antenna : KRA23-M(No.5)							
Freq (MHz)	Reading [dBm]	Factor (dBm)	Reading+Factor [dBm]	Pol	Result (dB)	Limit (dB)	Margin (dB)
469.95	8.28	26.18	34.46	Y-V	0.00	-	-
939.9	-74.68	32.83	-41.85	Y-V	76.31	54.46	21.85
1409.85	-46.29	0.55	-45.74	Y-H	80.20	54.46	25.74
1879.8	-34.97	-0.42	-35.39	Y-H	69.85	54.46	15.39
2349.75	-51.35	2.68	-48.67	Y-H	83.13	54.46	28.67
2819.7	-48.55	3.19	-45.36	Y-H	79.82	54.46	25.36
3289.65	-52.45	3.47	-48.98	Y-H	83.44	54.46	28.98
3759.6	-49.27	5.31	-43.96	Y-H	78.42	54.46	23.96
4229.55	-49.64	6.32	-43.32	Y-H	77.78	54.46	23.32
4699.5	-47.01	8.04	-38.97	Y-H	73.43	54.46	18.97

*Note :

1. Worst Case is 11K0F3E all of the modulation.
2. Limit = Reading + Factor + (P – 50 log (P))

11K0F3E

Frequency [MHz] F3 : 469.95

Battery : EX-4623 Antenna : KRA23-M(No.5)

Freq (MHz)	Reading [dBm]	Factor (dBm)	Reading+Factor [dBm]	Pol	Result (dB)	Limit (dB)	Margin (dB)
469.95	8.3	26.18	34.48	Y-V	0.00	-	-
939.9	-76.03	32.83	-43.20	Y-V	77.68	54.48	23.20
1409.85	-47.91	0.55	-47.36	Y-H	81.84	54.48	27.36
1879.8	-34.31	-0.42	-34.73	Y-H	69.21	54.48	14.73
2349.75	-49.76	2.68	-47.08	Y-H	81.56	54.48	27.08
2819.7	-47.89	3.19	-44.70	Y-H	79.18	54.48	24.70
3289.65	-52.92	3.47	-49.45	Y-H	83.93	54.48	29.45
3759.6	-50.13	5.31	-44.82	Y-H	79.30	54.48	24.82
4229.55	-51.88	6.32	-45.56	Y-H	80.04	54.48	25.56
4699.5	-49.03	8.04	-40.99	Y-H	75.47	54.48	20.99

*Note :

1. Worst Case is 11K0F3E all of the modulation.
2. Limit = Reading + Factor + (P – 50 log (P))

TEST RESULTS For IC

11K0F3E

Frequency : 418.05

Battery : EX-4621 Antenna : KRA-29P(No.2)

Freq (MHz)	Reading [dBm]	Factor (dBm)	Reading+Factor [dBm]	Pol	Result (dB)	Limit (dB)	Margin (dB)
418.05	8.07	25.25	33.32	X-H	0.00		
836.1	-82.92	31.17	-51.75	X-H	85.07	53.32	31.75
1254.15	-53.15	-0.73	-53.88	X-V	87.20	53.32	33.88
1672.2	-40.97	-0.6	-41.57	X-V	74.89	53.32	21.57
2090.25	-49.13	1.1	-48.03	X-V	81.35	53.32	28.03
2926.35	-52.89	3.51	-49.38	X-V	82.70	53.32	29.38
3344.4	-52.54	3.9	-48.64	X-V	81.96	53.32	28.64
3762.45	-54.78	5.31	-49.47	X-V	82.79	53.32	29.47
4180.5	-55.5	6.44	-49.06	X-V	82.38	53.32	29.06

*Note :

1. Worst Case is 11K0F3E all of the modulation.
2. Limit = Reading + Factor +(P – 50 log (P))

11K0F3E

Frequency [MHz] F1 : 418.05

Battery : EX-4622 Antenna : KRA-29P(No.2)

Freq (MHz)	Reading [dBm]	Factor (dBm)	Reading+Factor [dBm]	Pol	Result (dB)	Limit (dB)	Margin (dB)
418.05	8.34	25.25	33.59	X-H	0.00		
836.1	-85.28	31.17	-54.11	X-H	87.70	53.59	34.11
1254.15	-50.59	-0.73	-51.32	X-V	84.91	53.32	31.59
1672.2	-40.09	-0.6	-40.69	X-V	74.28	53.32	20.96
2090.25	-49.57	1.1	-48.47	X-V	82.06	53.32	28.74
2926.35	-51.65	3.51	-48.14	X-V	81.73	53.32	28.41
3344.4	-52.41	3.9	-48.51	X-V	82.10	53.32	28.78
3762.45	-55.74	5.31	-50.43	X-V	84.02	53.32	30.70
4180.5	-53.11	6.44	-46.67	X-V	80.26	53.32	26.94

*Note :

1. Worst Case is 11K0F3E all of the modulation.
2. Limit = Reading + Factor + (P – 50 log (P))

11K0F3E

Frequency [MHz] F1 : 418.05

Battery : EX-4623 Antenna : KRA-29P(No.2)

Freq (MHz)	Reading [dBm]	Factor (dBm)	Reading+Factor [dBm]	Pol	Result (dB)	Limit (dB)	Margin (dB)
418.05	8.35	25.25	33.60	X-H	0.00		
836.1	-79.63	31.17	-48.46	X-H	82.06	53.60	28.46
1254.15	-50.29	-0.73	-51.02	X-V	84.62	53.32	31.30
1672.2	-40.62	-0.6	-41.22	X-V	74.82	53.32	21.50
2090.25	-45	1.1	-43.90	X-V	77.50	53.32	24.18
2508.3	-55.49	2.72	-52.77	X-V	86.37	53.32	33.05
2926.35	-52.48	3.51	-48.97	X-V	82.57	53.32	29.25
3344.4	-52.47	3.9	-48.57	X-V	82.17	53.32	28.85
3762.45	-54.37	5.31	-49.06	X-V	82.66	53.32	29.34
4180.5	-55.07	6.44	-48.63	X-V	82.23	53.32	28.91

*Note :

1. Worst Case is 11K0F3E all of the modulation.
2. Limit = Reading + Factor +(P – 50 log (P))

11K0F3E

Frequency [MHz] F2 : 450.05

Battery : EX-4621 Antenna : KRA-29P(No.2)

Freq (MHz)	Reading [dBm]	Factor (dBm)	Reading+Factor [dBm]	Pol	Result (dB)	Limit (dB)	Margin (dB)
450.05	7.85	26.21	34.06	Y-V	0.00		
900.1	-76.81	31.98	-44.83	Y-V	78.89	54.06	24.83
1350.15	-50.01	-0.8	-50.81	X-V	84.87	54.06	30.81
1800.2	-45.29	-0.8	-46.09	X-V	80.15	54.06	26.09
2250.25	-53.6	2.94	-50.66	X-V	84.72	54.06	30.66
2700.3	-51.73	3.03	-48.70	X-V	82.76	54.06	28.70
3600.4	-52.72	4.65	-48.07	X-V	82.13	54.06	28.07
4050.45	-55.75	5.69	-50.06	X-V	84.12	54.06	30.06
4500.5	-50.77	7.66	-43.11	X-V	77.17	54.06	23.11

*Note :

1. Worst Case is 11K0F3E all of the modulation.
2. Limit = Reading + Factor +(P – 50 log (P))

11K0F3E

Frequency [MHz] F2 : 450.05

Battery : EX-4622 Antenna : KRA-29P(No.2)

Freq (MHz)	Reading [dBm]	Factor (dBm)	Reading+Factor [dBm]	Pol	Result (dB)	Limit (dB)	Margin (dB)
450.05	7.75	26.21	33.96	Y-V	0.00		
900.1	-77.01	31.98	-45.03	Y-V	78.99	53.96	25.03
1350.15	-52.61	-0.8	-53.41	X-V	87.37	53.96	33.41
1800.2	-46.67	-0.8	-47.47	X-V	81.43	53.96	27.47
2250.25	-54.09	2.94	-51.15	X-V	85.11	53.96	31.15
2700.3	-51.36	3.03	-48.33	X-V	82.29	53.96	28.33
3600.4	-53.57	4.65	-48.92	X-V	82.88	53.96	28.92
4050.45	-56.11	5.69	-50.42	X-V	84.38	53.96	30.42
4500.5	-51.45	7.66	-43.79	X-V	77.75	53.96	23.79

*Note :

1. Worst Case is 11K0F3E all of the modulation.
2. Limit = Reading + Factor + (P – 50 log (P))

11K0F3E

Frequency [MHz] F2 : 450.05

Battery : EX-4623 Antenna : KRA-29P(No.2)

Freq (MHz)	Reading [dBm]	Factor (dBm)	Reading+Factor [dBm]	Pol	Result (dB)	Limit (dB)	Margin (dB)
450.05	7.57	26.21	33.78	Y-V	0.00		
900.1	-73.84	31.98	-41.86	Y-V	75.64	53.78	21.86
1350.15	-48.05	-0.8	-48.85	X-V	82.63	53.78	28.85
1800.2	-44.41	-0.8	-45.21	X-V	78.99	53.78	25.21
2250.25	-50.62	2.94	-47.68	X-V	81.46	53.78	27.68
2700.3	-52.29	3.03	-49.26	X-V	83.04	53.78	29.26
3600.4	-48.93	4.65	-44.28	X-V	78.06	53.78	24.28
4050.45	-54.92	5.69	-49.23	X-V	83.01	53.78	29.23
4500.5	-52.37	7.66	-44.71	X-V	78.49	53.78	24.71

*Note :

1. Worst Case is 11K0F3E all of the modulation.
2. Limit = Reading + Factor + (P – 50 log (P))

11K0F3E

Frequency [MHz] F3 : 460.05

Battery : EX-4621 Antenna : KRA-29P(No.2)

Freq (MHz)	Reading [dBm]	Factor (dBm)	Reading+Factor[dBm]	Pol	Result (dB)	Limit (dB)	Margin (dB)
460.05	7.04	26.24	33.28	Y-V	0.00		
920.1	-72.82	32.42	-40.40	Y-V	73.68	53.28	20.40
1380.15	-51.15	-0.47	-51.62	X-V	84.90	53.28	31.62
1840.2	-43	-0.9	-43.90	X-V	77.18	53.28	23.90
2300.25	-51.84	2.61	-49.23	X-V	82.51	53.28	29.23
2760.3	-52.3	3.5	-48.80	X-V	82.08	53.28	28.80
3220.35	-54.51	4.22	-50.29	X-V	83.57	53.28	30.29
3680.4	-53.88	4.84	-49.04	X-V	82.32	53.28	29.04
4140.45	-55.73	6.22	-49.51	X-V	82.79	53.28	29.51
4600.5	-52.62	8.01	-44.61	X-V	77.89	53.28	24.61

*Note :

1. Worst Case is 11K0F3E all of the modulation.
2. Limit = Reading + Factor + (P – 50 log (P))

11K0F3E

Frequency [MHz] F3 : 460.05

Battery : EX-4622 Antenna : KRA-29P(No.2)

Freq (MHz)	Reading [dBm]	Factor (dBm)	Reading+Factor [dBm]	Pol	Result (dB)	Limit (dB)	Margin (dB)
460.05	6.98	26.24	33.22	Y-V	0.00		
920.1	-73.84	32.42	-41.42	Y-V	74.70	53.28	21.42
1380.15	-54.02	-0.47	-54.49	Y-H	87.77	53.28	34.49
1840.2	-43.53	-0.9	-44.43	Y-H	77.71	53.28	24.43
2300.25	-50.42	2.61	-47.81	Y-H	81.09	53.28	27.81
2760.3	-54.07	3.5	-50.57	Y-H	83.85	53.28	30.57
3220.35	-55.46	4.22	-51.24	Y-H	84.52	53.28	31.24
3680.4	-53.62	4.84	-48.78	Y-H	82.06	53.28	28.78
4140.45	-55.8	6.22	-49.58	Y-H	82.86	53.28	29.58
4600.5	-53.82	8.01	-45.81	Y-H	79.09	53.28	25.81

*Note :

1. Worst Case is 11K0F3E all of the modulation.
2. Limit = Reading + Factor + (P – 50 log (P))

11K0F3E

Frequency [MHz] F3 : 460.05

Battery : EX-4623 Antenna : KRA-29P(No.2)

Freq (MHz)	Reading [dBm]	Factor (dBm)	Reading+Factor [dBm]	Pol	Result (dB)	Limit (dB)	Margin (dB)
460.05	7.01	26.24	33.25	Y-V	0.00		
920.1	-71.81	32.42	-39.39	Y-V	72.67	53.28	19.39
1380.15	-48.12	-0.47	-48.59	X-V	81.87	53.28	28.59
1840.2	-41.47	-0.9	-42.37	X-V	75.65	53.28	22.37
2300.25	-50.3	2.61	-47.69	X-V	80.97	53.28	27.69
2760.3	-53.05	3.5	-49.55	X-V	82.83	53.28	29.55
3220.35	-54.78	4.22	-50.56	X-V	83.84	53.28	30.56
3680.4	-48.22	4.84	-43.38	X-V	76.66	53.28	23.38
4140.45	-56.84	6.22	-50.62	X-V	83.90	53.28	30.62
4600.5	-52.09	8.01	-44.08	X-V	77.36	53.28	24.08

*Note :

1. Worst Case is 11K0F3E all of the modulation.
2. Limit = Reading + Factor + (P – 50 log (P))

7.10 Unwanted Emissions : Receiver Radiated Spurious Emission

IC Rule(s) RSS-GEN
Test Requirements: Blow the table
Operating conditions: Under normal test conditions
Method of testing: Radiated

S/A. Settings: F < 1 GHz: RBW: 120 kHz, VBW: 300 kHz (Quasi Peak)
 F > 1 GHz: RBW: 1 MHz, VBW: 1 MHz (Peak)
Mode of operation: Receive

Frequency (MHz)	Field Strength (microvolts/m at 3 meters)
30 – 88	100
88 - 216	150
216 – 960	200
Above 960	500

Operation Mode: Receive:

30 MHz ~ 1 GHz

Frequency	Reading	Ant. factor	Cable loss	Ant. POL	Total	Limit	Margin
MHz	dBµV	dB /m	dB	(H/V)	dBµV/m	dBµV/m	dB
No Critical peaks found							

Above 1 GHz

Frequency	Reading	Ant. factor	Cable loss	Ant. POL	Total	Limit	Margin
MHz	dBµV	dB /m	dB	(H/V)	dBµV/m	dBµV/m	dB
No Critical peaks found							

7.11 Necessary Bandwidth Calculations

Modulation = 16K0F3E	
Maximum Modulation (M), kHz	3
Maximum Deviation (D), kHz	5
Constant Factor (K)	1
Necessary Bandwidth (BN), kHz	$(2 \times M) + (2 \times D \times K)$
Necessary Bandwidth (BN), kHz	16.0

Modulation = 11K0F3E	
Maximum Modulation (M), kHz	3
Maximum Deviation (D), kHz	2.5
Constant Factor (K)	1
Necessary Bandwidth (BN), kHz	$(2 \times M) + (2 \times D \times K)$
Necessary Bandwidth (BN), kHz	11.0

Modulation = 8K30F1E, 8K30F1D, 8K30F7W	
Digital information rate (R), bps	9600
Maximum Deviation (D), kHz	3.391
Signaling States (S)	4
Constant Factor (K)	0.516
Necessary Bandwidth (BN), kHz	$(R / \log_2 S) + 2DK$
Necessary Bandwidth (BN), kHz	8.3

Modulation = 4K00F1E, 4K00F1D, 4K00F7W	
Digital information rate (R), bps	4800
Maximum Deviation (D), kHz	1.55
Signaling States (S)	4
Constant Factor (K)	0.516
Necessary Bandwidth (BN), kHz	$(R/\log_2 S) + 2DK$
Necessary Bandwidth (BN), kHz	4.0

Modulation = 4K00F2D	
Maximum Modulation (M), kHz	0.8
Maximum Deviation (D), kHz	1.2
Constant Factor (K)	1
Necessary Bandwidth (BN), kHz	$(2xM) + (2xDxK)$
Necessary Bandwidth (BN), kHz	4.0

8. LIST OF TEST EQUIPMENT

Manufacturer	Model / Equipment	Calibration Date	Calibration Interval	Calibration Due	Serial No.
Agilent	N9020A/ SIGNAL ANALYZER	07/01/2014	Annual	07/01/2015	MY51110085
Agilent	N1911A/Power Meter	01/24/2014	Annual	01/24/2015	MY45100523
Agilent	N1921A /POWER SENSOR	07/09/2014	Annual	07/09/2015	MY45241059
Hewlett Packard	8903B/Audio Analyzer	12/21/2013	Annual	12/21/2014	3413A13913
Hewlett Packard	8901B/Modulation Analyzer	04/10/2014	Annual	04/10/2015	2406A00169
Tektronix	RSA3303B/Real Time Spectrum Analyzer	05/20/2014	Annual	05/20/2015	B010208
Agilent	8498A/30 dB Attenuator	11/05/2013	Annual	11/05/2014	51162
EAGLE	230NFNM/Tuneable Notch Filter	10/17/2013	Annual	10/17/2014	H00564-10
Korea Engineering	KR-1005L / Temperature Chamber	10/30/2013	Annual	10/30/2014	KRAB05063-3CH
MITEQ	AMF-6D-001180-35-20P/AMP	09/12/2013	Annual	09/12/2014	1081666
Wainwright	WHK1.2/15G-10EF/H.P.F	06/17/2014	Annual	06/17/2015	4
Schwarzbeck	UHAP/ Dipole Antenna	03/05/2013	Biennial	03/05/2015	557
Schwarzbeck	UHAP/ Dipole Antenna	05/03/2013	Biennial	05/03/2015	558
Schwarzbeck	BBHA 9120D/ Horn Antenna	12/03/2013	Biennial	12/03/2015	1191
Schwarzbeck	BBHA 9120D/ Horn Antenna	10/05/2013	Biennial	10/05/2015	1151
REOHDE&SCHWARZ	FSV40/Spectrum Analyzer	06/09/2014	Annual	06/09/2015	1307.9002K40-100931-NK
Inn-co GmbH	CT 0800/Turn table	N/A	N/A	N/A	AS2000P/034/9740305
Inn-co GmbH	DE 3260/Ant. Mast	N/A	N/A	N/A	DE3260/005/7860504/L
Schwarzbeck	VULB 9160/ TRILOG Antenna	12/17/2012	Biennial	12/17/2014	3150