

SAR TEST REPORT

JVC KENWOOD CORPORATION

1-16-2 Hakusan Midori-ku Yokohama-shi
Kanagawa 226-8525 Japan

Date of Issue: Nov. 04, 2014

Test Report No:HCT-A-1410-F003-1

Test Site: HCT CO., LTD.

FCC ID:

K44431400

Rule Part(s) / Standard(s):
Equipment Type:
FCC Model Name:

Part 2, 90
VHF P25 TRANSCEIVER with Bluetooth
NX-5200-K2, NX-5200-K3, NX-5200-F2, NX-5200-F3

Testing has been carried
out in accordance with:

47CFR §2.1093
ANSI/ IEEE C95.1 – 1992
IEEE 1528-2003
RSS-102 Issue 4; Health Canada Safety Code 6
Oct. 24, 2014, Oct. 25, 2014, Oct. 26, 2014

Date of Test:

This device has been shown to be capable of compliance for localized specific absorption rate (SAR) for uncontrolled environment/general population exposure limits specified in FCC KDB procedures and had been tested in accordance with the measurement procedures specified in FCC KDB procedures.

I attest to the accuracy of data. All measurements reported herein were performed by me or were made under my supervision and are correct to the best of my knowledge and belief. I assume full responsibility for the completeness of these measurements and vouch for the qualifications of all persons taking them.

Tested By

Reviewed By



Young-Soo Jang
Test Engineer / SAR Team
Certification Division



Dong-Seob Kim
Technical Manager / SAR Team
Certification Division

Version

Rev.	DATE	DESCRIPTION
HCT-A-1410-F003	Oct. 31, 2014	First Approval Report
HCT-A-1410-F003-1	Nov. 04, 2014	Sec. 4 was revised.

Table of Contents

1. INTRODUCTION	4
2. TEST METHODOLOGY	5
3. DESCRIPTION OF DEVICE.....	6
4. Manufacturer's Accessory List	7
5. DESCRIPTION OF TEST EQUIPMENT	1 2
6. SAR MEASUREMENT PROCEDURE.....	1 9
7. DESCRIPTION OF TEST POSITION.....	2 1
8. ANSI/ IEEE C95.1 - 1992 RF EXPOSURE LIMITS	2 2
9. SAR SYSTEM VALIDATION.....	2 3
10. SYSTEM VERIFICATION.....	2 4
11. RF CONDUCTED POWER MEASUREMENT	2 6
12. SAR TEST DATA SUMMARY	2 9
13. SAR Summation Scenario	3 4
14. CONCLUSION.....	3 6
15. REFERENCES	3 7
Attachment 1.- SAR Test Plots	3 8
Attachment 2. – Verification Plots.....	5 3
Attachment 3. – Probe Calibration Data	5 8
Attachment 4. – Dipole Calibration Data	7 0

1. INTRODUCTION

The FCC has adopted the guidelines for evaluating the environmental effects of radio frequency radiation in ET Docket 93-62 on Aug. 6, 1996 to protect the public and workers from the potential hazards of RF emissions due to FCC-regulated portable devices.

The safety limits used for the environmental evaluation measurements are based on the criteria published by the American National Standards Institute (ANSI) for localized specific absorption rate (SAR) in IEEE/ANSI C95.1-1992 Standard for Safety Levels with Respect to Human Exposure to Radio Frequency Electromagnetic Fields, 3 kHz to 300 GHz. 1992 by the Institute of Electrical and Electronics Engineers, Inc., New York, New York 10017. The measurement procedure described in IEEE/ANSI C95.3-1992 Recommended Practice for the Measurement of Potentially Hazardous Electromagnetic Fields - RF and Microwave is used for guidance in measuring SAR due to the RF radiation exposure from the Equipment Under Test (EUT). These criteria for SAR evaluation are similar to those recommended by the National Council on Radiation Protection and Measurements (NCRP) in Biological Effects and Exposure Criteria for Radio frequency Electromagnetic Fields," NCRP Report No. 86 NCRP, 1986, Bethesda, MD 20814. SAR is a measure of the rate of energy absorption due to exposure to an RF transmitting source. SAR values have been related to threshold levels for potential biological hazards.

SAR Definition

Specific Absorption Rate (SAR) is defined as the time derivative of the incremental electromagnetic energy (dW) absorbed by (dissipated in) an incremental mass (dm) contained in a volume element (dV) of a given density (ρ). It is also defined as the rate of RF energy absorption per unit mass at a point in an absorbing body.

$$SAR = \frac{d}{dt} \left(\frac{dU}{dm} \right) = \frac{d}{dt} \left(\frac{dU}{\rho dV} \right)$$

Figure 1. SAR Mathematical Equation

SAR is expressed in units of Watts per Kilogram (W/kg)

$$SAR = \sigma E^2 / \rho$$

Where:

- σ = conductivity of the tissue-simulant material (S/m)
- ρ = mass density of the tissue-simulant material (kg/m³)
- E = Total RMS electric field strength (V/m)

NOTE: The primary factors that control rate of energy absorption were found to be the wavelength of the incident field in relations to the dimensions and geometry of the irradiated organism, the orientation of the organism in relation to the polarity of field vectors, the presence of reflecting surfaces, and whether conductive contact is made by the organism with a ground plane.

2. TEST METHODOLOGY

The tests documented in this report were performed in accordance with IEEE Standard 1528-2003 & IEEE 1528-2005 and the following published KDB procedures.

- FCC KDB Publication 447498 D01v05r02 (General SAR Guidance)
- FCC KDB 634646 D01 Handset SAR v01r01
- FCC KDB Publication 865664 D01 SAR measurement 100 MHz to 6 GHz v01r03
- FCC KDB Publication 865664 D02 SAR Reporting v01r01

3. DESCRIPTION OF DEVICE

Environmental evaluation measurements of specific absorption rate (SAR) distributions in emulated human head and body tissues exposed to radio frequency (RF) radiation from wireless portable devices for compliance with the rules and regulations of the U.S. Federal Communications Commission (FCC).

EUT Type	VHF P25 TRANSCEIVER WITH BLUETOOTH					
FCC ID:	K44431400					
FCC Model Name:	NX-5200-K2, NX-5200-K3, NX-5200-F2, NX-5200-F3 (Models are electrically identical and differ only in number of buttons on keypad)					
IC Model Name:	NX-5200-K2, NX-5200-K3					
Trade Name	JVC KENWOOD CORPORATION					
Application Type	Certification					
Production Unit or Identical Prototype	Prototype					
Max. SAR	Band	Tx. Frequency (MHz)	Equipment Class	Reported 1 g SAR (W/kg)		50% PTT duty cycle
				Head	Body-worn	
	VHF(FCC)	150 - 174	TNF	1.58	4.74	
	Bluetooth	2 402 - 2 480	DSS/ DTS	-	0.02 ^{*1}	
Simultaneous SAR per KDB 690783 D01v01r03				-	4.76	
Date(s) of Tests	Oct. 24, 2014 , Oct. 25, 2014, Oct. 26, 2014					

***Note 1:** BT Body-worn SAR value is estimate SAR value that should not be reported standalone SAR on grants of equipment approval.

4.Manufacturer's Accessory List

Part No.	Description	Accessory Type	Accessory
KRA-26(M)	VHF Herilal Antenna(146-162MHz)	Antenna	1
KRA-26(M2)	VHF Herilal Antenna(162-174MHz)		2
KRA-26(M3)	VHF Herilal Antenna(136-150MHz)		3
KRA-22(M)	VHF low-profile helicalantenna(146-162MHz)		4
KRA-22(M2)	VHF low-profile helicalantenna(162-174MHz)		5
KRA-22(M3)	VHF low-profile helicalantenna(136-150MHz)		6
KRA-41(M)	VHF stubbyantenna(146-162MHz)		7
KRA-41(M2)	VHF stubbyantenna (162-174MHz)		8
KRA-41(M3)	VHF stubbyantenna (136-150MHz)		9
KRA-25	High gain VHF helically loaded whip antenna 148-162MHz		10
KRA-28	Broad-band VHF helically loaded whip antenna 140-170MHz		11
KNB-L1	Li-ion Intelligent Battery(S)	Battery	2000 mAh 1
KNB-L2	Li-ion Intelligent Battery(M)		2600 mAh 2
KNB-L3	Li-ion Intelligent Battery(L)		3400 mAh 3
KBH-11	Spring action belt clip (2.5")	Body-worn	1
KBH-8DS	Leather swivel belt loop with portable D-Ring attachment		2
KLH-6SW	Leather swivel belt loop / detachable swivel D-Ring back		3
KLH-137ST	Firemen's heavy-Duty Leather Shoulder Strap for a heavy-Duty Leather Case		4
KLH-201(K3)	Nylon Case_Cordura Nylon		5
KLH-37BT	Universal "48" Leather Belt		6
KLH-38ST	Shoulder Strap		7
KLH-3SW	Swivel Belt Loop		8
KLH-202(P/P2)	Leather Case (Standard/Full key)		9
KLH-200(K2/K3)	Leather Case (Standard/Full key)		10
KMC-25	MIL-SPEC, Noise canceling Speaker Mic	Audio Accessory	1
KMC-41	MIL-SPEC, IP54/55 Noise- canceling Speaker Mic		2
KMC-41D	MIL-SPEC, IP54/55 Noise- canceling Speaker Mic		3
KMC-42W	MIL-SPEC, IP67 (immersion) Noise-canceling Speaker Mic		4
KMC-42WD	MIL-SPEC, IP67 (immersion) Noise-canceling Speaker Mic		5
KMC-47GPS	GPS Speaker Microphone		6
KMC-47GPSD	GPS Speaker Microphone		7
KMC-54WD	Speaker Microphone		8
KMC-49	MIL-SPEC, Speaker Mic. With Antenna Connector		9
KEP-1	3.5mm earphone kit for KMC-25/26/41M/42WM Speaker Mics		10
KEP-2	2.5mm earphone kit for KMC-17/45 Speaker Mic		11
KEP-3	30"Earphone kit w / 2.5mm plug for KCT-30		12
KEP-4	48"Earphone kit w / 2.5mm pluf for KCT-30		13
KCT-30	2.5mm Audio Accessory Adapter for KEP-3/4		14
KCT-51	Hirose 6-pin Adapter(adapts KVL/aftermarket audio acc.to portable connector)		15
KHS-12BE	3-wire mini lapel Mic w/earphone, universal connector(Beige)		16
KHS-12BL	3-wire mini lapel Mic w/earphone, universal connector(Black)		17
KHS-11BE	2-wire palm Mic w/earphone, universal connector(Beige)		18
KHS-11BL	2-wire palm Mic w/earphone, universal connector(Black)		19
KHS-14	Lt. Wt. Single muff headset w/boom Mic & in-line PTT		20
KHS-15-BH	Hvy-duty noise reduction behind-the-headset w/noise cancelling boom Mic & in-line PTT	21	
KHS-15-OH	Hvy-duty noise reduction over-the-headset w/noise cancelling boom Mic & in-line PTT	22	

Manufacture’s disclosed accessory listing information provided by Kenwood corporation.

*Note :Audio Accessory KMC-54WD, KMC-49, was chosen for the testing body worn radio configuration. Audio Accessory KMC-25, KMC-41D, KMC-41D, KMC-42W, KMC-42WD, KMC-47GPS, KMC-47GPS, KEP-1, KEP-2, KEP-3, KEP-4, KCP-30, KCT-51, KHS-12BE, KHS-12BL, KHS-14, KHS-15-BH, KHS-15-OH, KHS-11BE and KHS-11BL are excluded per KDB 643646 D01 v01r01 page 10 1) A).

Radio Face Test

Battery 1				Battery 2				Battery 3			
Ant. 1	Ant. 2	Ant. 3	Ant. 4	Ant. 1	Ant. 2	Ant. 3	Ant. 4	Ant. 1	Ant. 2	Ant. 3	Ant. 4
Yes	Yes	Yes	Yes	Yes	Yes	Yes	Yes	Yes	Yes	Yes	Yes
Ant. 5	Ant. 6	Ant. 7	Ant. 8	Ant. 5	Ant. 6	Ant. 7	Ant. 8	Ant. 5	Ant. 6	Ant. 7	Ant. 8
Yes	Yes	Yes	Yes	Yes	Yes	Yes	Yes	Yes	Yes	Yes	Yes
Ant. 9	Ant. 10	Ant. 11		Ant. 9	Ant. 10	Ant. 11		Ant. 9	Ant. 10	Ant. 11	
Yes	Yes	Yes		Yes	Yes	Yes		Yes	Yes	Yes	

Microphone Face Test

Battery 1				Battery 2				Battery 3			
Ant. 1	Ant. 2	Ant. 3	Ant. 4	Ant. 1	Ant. 2	Ant. 3	Ant. 4	Ant. 1	Ant. 2	Ant. 3	Ant. 4
Yes	Yes	Yes	Yes	Yes	Yes	Yes	Yes	Yes	Yes	Yes	Yes
Ant. 5	Ant. 6	Ant. 7	Ant. 8	Ant. 5	Ant. 6	Ant. 7	Ant. 8	Ant. 5	Ant. 6	Ant. 7	Ant. 8
Yes	Yes	Yes	Yes	Yes	Yes	Yes	Yes	Yes	Yes	Yes	Yes
Ant. 9	Ant. 10	Ant. 11		Ant. 9	Ant. 10	Ant. 11		Ant. 9	Ant. 10	Ant. 11	
Yes	Yes	Yes		Yes	Yes	Yes		Yes	Yes	Yes	

Radio Body Test

Audio Accessory	Battery 1									
	Body-worn 1	Body-worn2	Body-worn3	Body-worn4	Body-worn5	Body-worn6	Body-worn7	Body-worn8	Body-worn9	Body-worn10
Audio Accessory 1	No	No	No	No	No	No	No	No	No	No
Audio Accessory 2	No	No	No	No	No	No	No	No	No	No
Audio Accessory 3	No	No	No	No	No	No	No	No	No	No
Audio Accessory 4	No	No	No	No	No	No	No	No	No	No
Audio Accessory 5	No	No	No	No	No	No	No	No	No	No
Audio Accessory 6	No	No	No	No	No	No	No	No	No	No
Audio Accessory 7	No	No	No	No	No	No	No	No	No	No
Audio Accessory 8	Yes	Yes	No	No	Yes	No	No	No	No	No
Audio Accessory 9	Yes	Yes	No	No	Yes	No	No	No	No	No
Audio Accessory 10	No	No	No	No	No	No	No	No	No	No
Audio Accessory 11	No	No	No	No	No	No	No	No	No	No
Audio Accessory 12	No	No	No	No	No	No	No	No	No	No
Audio Accessory 13	No	No	No	No	No	No	No	No	No	No
Audio Accessory 14	No	No	No	No	No	No	No	No	No	No
Audio Accessory 15	No	No	No	No	No	No	No	No	No	No
Audio Accessory 16	No	No	No	No	No	No	No	No	No	No
Audio Accessory 17	No	No	No	No	No	No	No	No	No	No
Audio Accessory 18	No	No	No	No	No	No	No	No	No	No
Audio Accessory 19	No	No	No	No	No	No	No	No	No	No
Audio Accessory 20	No	No	No	No	No	No	No	No	No	No
Audio Accessory 21	No	No	No	No	No	No	No	No	No	No
Audio Accessory 22	No	No	No	No	No	No	No	No	No	No

Radio Body Test

Audio Accessory	Battery 2									
	Body-worn 1	Body-worn2	Body-worn3	Body-worn4	Body-worn5	Body-worn6	Body-worn7	Body-worn8	Body-worn9	Body-worn10
Audio Accessory 1	No	No	No	No	No	No	No	No	No	No
Audio Accessory 2	No	No	No	No	No	No	No	No	No	No
Audio Accessory 3	No	No	No	No	No	No	No	No	No	No
Audio Accessory 4	No	No	No	No	No	No	No	No	No	No
Audio Accessory 5	No	No	No	No	No	No	No	No	No	No
Audio Accessory 6	No	No	No	No	No	No	No	No	No	No
Audio Accessory 7	No	No	No	No	No	No	No	No	No	No
Audio Accessory 8	Yes	Yes	No	No	Yes	No	No	No	No	No
Audio Accessory 9	Yes	Yes	No	No	Yes	No	No	No	No	No
Audio Accessory 10	No	No	No	No	No	No	No	No	No	No
Audio Accessory 11	No	No	No	No	No	No	No	No	No	No
Audio Accessory 12	No	No	No	No	No	No	No	No	No	No
Audio Accessory 13	No	No	No	No	No	No	No	No	No	No
Audio Accessory 14	No	No	No	No	No	No	No	No	No	No
Audio Accessory 15	No	No	No	No	No	No	No	No	No	No
Audio Accessory 16	No	No	No	No	No	No	No	No	No	No
Audio Accessory 17	No	No	No	No	No	No	No	No	No	No
Audio Accessory 18	No	No	No	No	No	No	No	No	No	No
Audio Accessory 19	No	No	No	No	No	No	No	No	No	No
Audio Accessory 20	No	No	No	No	No	No	No	No	No	No
Audio Accessory 21	No	No	No	No	No	No	No	No	No	No
Audio Accessory 22	No	No	No	No	No	No	No	No	No	No

Radio Body Test

Audio Accessory	Battery 3									
	Body-worn 1	Body-worn2	Body-worn3	Body-worn4	Body-worn5	Body-worn6	Body-worn7	Body-worn8	Body-worn9	Body-worn10
Audio Accessory 1	No	No	No	No	No	No	No	No	No	No
Audio Accessory 2	No	No	No	No	No	No	No	No	No	No
Audio Accessory 3	No	No	No	No	No	No	No	No	No	No
Audio Accessory 4	No	No	No	No	No	No	No	No	No	No
Audio Accessory 5	No	No	No	No	No	No	No	No	No	No
Audio Accessory 6	No	No	No	No	No	No	No	No	No	No
Audio Accessory 7	No	No	No	No	No	No	No	No	No	No
Audio Accessory 8	Yes	Yes	No	No	Yes	No	No	No	No	No
Audio Accessory 9	Yes	Yes	No	No	Yes	No	No	No	No	No
Audio Accessory 10	No	No	No	No	No	No	No	No	No	No
Audio Accessory 11	No	No	No	No	No	No	No	No	No	No
Audio Accessory 12	No	No	No	No	No	No	No	No	No	No
Audio Accessory 13	No	No	No	No	No	No	No	No	No	No
Audio Accessory 14	No	No	No	No	No	No	No	No	No	No
Audio Accessory 15	No	No	No	No	No	No	No	No	No	No
Audio Accessory 16	No	No	No	No	No	No	No	No	No	No
Audio Accessory 17	No	No	No	No	No	No	No	No	No	No
Audio Accessory 18	No	No	No	No	No	No	No	No	No	No
Audio Accessory 19	No	No	No	No	No	No	No	No	No	No
Audio Accessory 20	No	No	No	No	No	No	No	No	No	No
Audio Accessory 21	No	No	No	No	No	No	No	No	No	No
Audio Accessory 22	No	No	No	No	No	No	No	No	No	No

5. DESCRIPTION OF TEST EQUIPMENT

5.1 SAR MEASUREMENT SETUP

These measurements are performed using the DASY4 automated dosimetric assessment system. It is made by Schmid & Partner Engineering AG (SPEAG) in Zurich, Switzerland. It consists of high precision robotics system (Staubli), robot controller, Pentium III computer, near-field probe, probe alignment sensor, and the generic twin phantom containing the brain equivalent material. The robot is a six-axis industrial robot performing precise movements to position the probe to the location (points) of maximum electromagnetic field (EMF) (see Figure.2).

A cell controller system contains the power supply, robot controller, teach pendant (Joystick), and remote control, is used to drive the robot motors. The PC consists of the HP Pentium IV 3.0GHz computer with Windows XP system and SAR Measurement Software DASY4, A/D interface card, monitor, mouse, and keyboard. The Staubli Robot is connected to the cell controller to allow software manipulation of the robot. A data acquisition electronic (DAE) circuit performs the signal amplification, signal multiplexing, AD-conversion, offset measurements, mechanical surface detection, collision detection, etc. is connected to the Electro-optical coupler (EOC). The EOC performs the conversion from the optical into digital electric signal of the DAE and transfers data to the PC plug-in card.

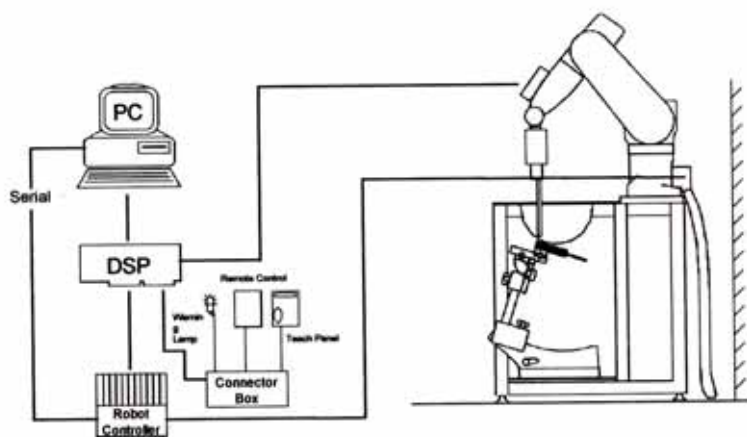

Figure 2. HCT SAR Lab. Test Measurement Set-up

The DAE4 consists of a highly sensitive electrometer-grade preamplifier with auto-zeroing, a channel and gain-switching multiplexer, a fast 16 bit AD-converter and a command decoder and control logic unit. Transmission to the PC-card is accomplished through an optical downlink for data and status information and an optical uplink for commands and clock lines. The mechanical probe mounting device includes two different sensor systems for frontal and sideways probe contacts. They are also used for mechanical surface detection and probe collision detection. The robot uses its own controller with a built in VME-bus computer. This system is described in detail in.

5.2 DASY E-FIELD PROBE SYSTEM

5.2.1 ET3DV6 Probe Specification

Construction	Symmetrical design with triangular core Built-in optical fiber for surface detection System Built-in shielding against static charges
Calibration	In air from 10 MHz to 2.5 GHz In brain and muscle simulating tissue at Frequencies of 450 MHz, 900 MHz and 1.8 GHz (accuracy: 8%)
Frequency	10 MHz to >3 GHz; Linearity: ± 0.2 dB (30 MHz to 3 GHz)
Directivity	± 0.2 dB in brain tissue (rotation around probe axis) ± 0.4 dB in brain tissue (rotation normal probe axis)
Dynamic	5 μ W/g to > 100 mW/g;
Range Linearity:	± 0.2 dB
Surface Detection	± 0.2 mm repeatability in air and clear liquids over diffuse reflecting surfaces.
Dimensions	Overall length: 330 mm Tip length: 16 mm Body diameter: 12 mm Tip diameter: 6.8 mm Distance from probe tip to dipole centers: 2.7 mm
Application	General dissymmetry up to 3 GHz Compliance tests of WCDMA/LTE Phones Fast automatic scanning in arbitrary phantoms



Figure 3. Photograph of the probe and the Phantom

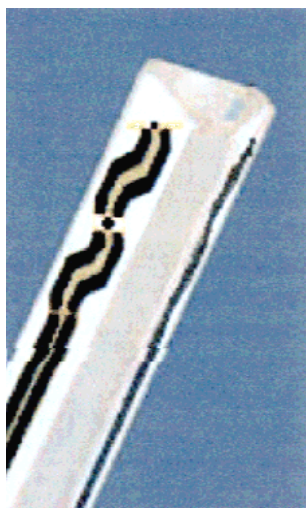

Figure 4. ET3DV6 E-field Probe

The SAR measurements were conducted with the dosimetric probe ET3DV6, designed in the classical triangular configuration and optimized for dosimetric evaluation. The probe is constructed using the thick film technique; with printed resistive lines on ceramic substrates. The probe is equipped with an optical multifiber line ending at the front of the probe tip. It is connected to the EOC box on the robot arm and provides an automatic detection of the phantom surface. Half of the fibers are connected to a pulsed infrared transmitter, the other half to a synchronized receiver. As the probe approaches the surface, the reflection from the surface produces a coupling from the transmitting to the receiving fibers. This reflection increases first during the approach, reaches a maximum and then decreases. If the probe is flatly touching the surface, the coupling is zero. The distance of the coupling maximum to the surface is independent of the surface reflectivity and largely independent of the surface to probe angle. The DASY4 software reads the reflection during a software approach and looks for the maximum using a 2nd order fitting. The approach is stopped at reaching the maximum.

5.3 PROBE CALIBRATION PROCESS

5.3.1 E-Probe Calibration

Each probe is calibrated according to a dosimetric assessment procedure with an accuracy better than ± 10%. The spherical isotropy was evaluated with the proper procedure and found to be better than ± 0.25dB. The sensitivity parameters (NormX, NormY, NormZ), the diodecompression parameter (DCP) and the conversion factor (ConvF) of the probe is tested.

The free space E-field from amplified probe outputs is determined in a test chamber. This is performed in a TEM cell for frequencies below 1 GHz, and in a waveguide above 1 GHz for free space. For the free space calibration, the probe is placed in the volumetric center of the cavity and at the proper orientation with the field. The probe is then rotated 360 degrees.

E-field temperature correlation calibration is performed in a flat phantom filled with the appropriate simulated brain tissue. The measured free space E-field in the medium correlates to temperature rise in a dielectric medium. For temperature correlation calibration a RF transparent thermistor-based temperature probe is used in conjunction with the E-field probe.

$$SAR = C \frac{\Delta T}{\Delta t} \Rightarrow SAR = \frac{|E^2| \cdot \sigma}{\rho}$$

where:

Δt = exposure time (30 seconds), σ = simulated tissue conductivity,

C = heat capacity of tissue (brain or muscle),

ΔT = temperature increase due to RF exposure.

SAR is proportional to $\Delta T/\Delta t$, the initial rate of tissue heating, before thermal diffusion takes place.

Now it's possible to quantify the electric field in the simulated tissue by equating the thermally derived SAR to the E-field;

where:

ρ = Tissue density (1.25 g/cm³ for brain tissue)

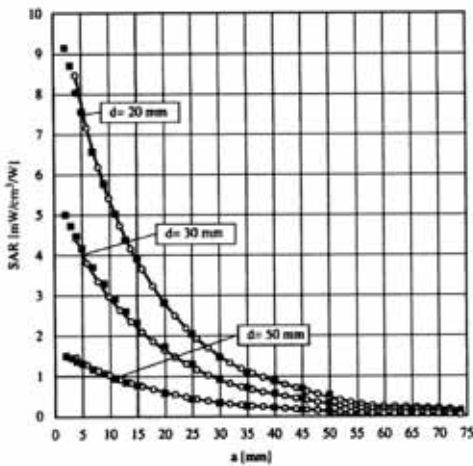

Figure 7. E-Field and Temperature measurements at 900MHz

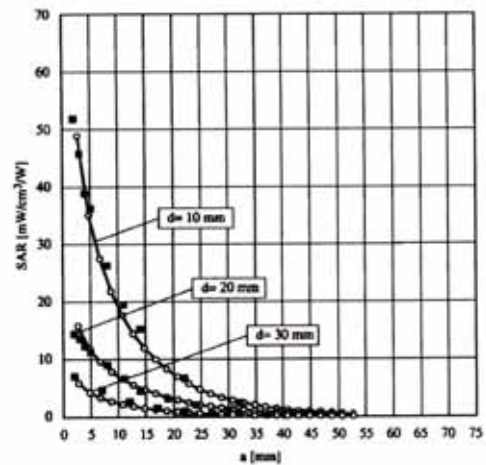

Figure 8. E-Field and temperature measurements at 1.8GHz

5.3.2 Data Extrapolation

The DASY4 software automatically executes the following procedures to calculate the field units from the microvolt readings at the probe connector. The first step of the evaluation is a linearization of the filtered input signal to account for the compression characteristics of the detector diode. The compensation depends on the input signal, the diode type and the DC-transmission factor from the diode to the evaluation electronics. If the exciting field is pulsed, the crest factor of the signal must be known to correctly compensate for peak power. The formula for each channel can be given like below;

$$V_i = U_i + U_i^2 \cdot \frac{cf}{dcp_i} \quad \text{with}$$

- V_i = compensated signal of channel i (i=x,y,z)
- U_i = input signal of channel i (i=x,y,z)
- cf = crest factor of exciting field (DASY parameter)
- dcp_i = diode compression poing (DASY parameter)

From the compensated input signals the primary field data for each channel can be evaluated:

E-field probes: with

$$E_i = \sqrt{\frac{V_i}{Norm_i \cdot ConvF}}$$

- V_i = compensated signal of channel i (i=x,y,z)
- $Norm_i$ = sensor sensitivity of channel i (i=x,y,z)
 $\mu V / (V/m)^2$ for E-field probes
- $ConvF$ = sensitivity of enhancement in solution
- E_i = electric field strength of channel i in V/m

The RSS value of the field components gives the total field strength (Hermetian magnitude):

$$E_{tot} = \sqrt{E_x^2 + E_y^2 + E_z^2}$$

The primary field data are used to calculate the derived field units.

$$SAR = E_{tot}^2 \cdot \frac{\sigma}{\rho \cdot 1000} \quad \text{with}$$

- SAR = local specific absorption rate in W/g
- E_{tot} = total field strength in V/m
- σ = conductivity in [mho/m] or [Siemens/m]
- ρ = equivalent tissue density in g/cm^3

The power flow density is calculated assuming the excitation field to be a free space field.

$$P_{pwe} = \frac{E_{tot}^2}{3770} \quad \text{with}$$

- P_{pwe} = equivalent power density of a plane wave in w/cm^2
- E_{tot} = total electric field strength in V/m

5.4 ELI Phantom

Phantom for compliance testing of handheld and body-mounted wireless devices in the frequency range of 30 MHz to 6 GHz. ELI is fully compatible with the IEC 62209-2 standard and all known tissue simulating liquids. ELI has been optimized regarding its performance and can be integrated into our standard phantom tables. A cover prevents evaporation of the liquid. Reference markings on the phantom allow installation of the complete setup, including all predefined phantom positions and measurement grids, by teaching three points. The phantom is compatible with all SPEAG dosimetric probes and dipoles.

ELI V5.0 has the same shell geometry and is manufactured from the same material as ELI, but has reinforced top structure.



Figure 9.ELI Phantom

Shell Thickness	2.0 mm ± 0.2 mm (6 ± 0.2 mm at ear point)
Filling Volume	about 25 L
Dimensions	810 mm x 1000 mm x 500 mm (H x L x W)

5.5 Device Holder for Transmitters

In combination with the SAM Phantom V4.0, the Mounting Device (POM) enables the rotation of the mounted transmitter in spherical coordinates whereby the rotation points is the ear opening. The devices can be easily, accurately, and repeatably positioned according to the FCC and CENELEC specifications. The device holder can be locked at different phantom locations (left head, right head, flat phantom).

Note: A simulating human hand is not used due to the complex anatomical and geometrical structure of the hand that may produce infinite number of configurations. To produce the Worst-case condition (the hand absorbs antenna output power), the hand is omitted during the tests.



Figure 10. Device Holder

5.6 Brain & Muscle Simulating Mixture Characterization

The brain and muscle mixtures consist of a viscous gel using hydrox-ethyl cellulose (HEC) gelling agent and saline solution (see Table 3.1). Preservation with a bactericide is added and visual inspection is made to make sure air bubbles are not trapped during the mixing process. The mixture is calibrated to obtain proper dielectric constant (permittivity) and conductivity of the desired tissue. The mixture characterizations used for the brain and muscle tissue simulating liquids are according to the data by C. Gabriel and G. Hartsgrove.

Ingredients (% by weight)	Frequency (MHz)	
	150	
Tissue Type	Head	Body
Water	38.35 %	46.6 %
Salt (NaCl)	55.5 %	49.7 %
Sugar	5.15 %	2.6 %
HEC	0.9 %	1.0 %
Bactericide	0.1 %	0.1 %
Triton X-100	-	-
DGBE	-	-
Diethyleneglycolhexylether	-	-

Salt:	99%Pure Sodium Chloride	Sugar:	98%Pure Sucrose
Water:	De-ionized, 16M resistivity	HEC:	Hydroxyethyl Cellulose
DGBE:	99% Di(ethylene glycol) butyl ether,[2-(2-butoxyethoxy)ethanol]		
Triton X-100(ultra pure):	Polyethylene glycol mono[4-(1,1,3,3-tetramethylbutyl)phenyl] ether		

Table 3.1 Composition of the Tissue Equivalent Matter

5.7 SAR TEST EQUIPMENT

Manufacturer	Type / Model	S/N	Calib. Date	Calib.Interval	Calib.Due
SPEAG	SAM Phantom	-	N/A	N/A	N/A
SPEAG	ELI Phantom	-	N/A	N/A	N/A
Staubli	Robot TX90Lspeag	F13/5R4XF1/A/01	N/A	N/A	N/A
Staubli	Robot ControllerCS7MB	F13/5R4XF1/C/01	N/A	N/A	N/A
HP	Pavilion t000_puffer	KRJ51201TV	N/A	N/A	N/A
SPEAG	Light Alignment Sensor	SE UKS 030 AA	N/A	N/A	N/A
Staubli	Teach Pendant (Joystick)	D21142605	N/A	N/A	N/A
SPEAG	DAE4	1417	Jan. 03, 2014	Annual	Jan. 03, 2015
SPEAG	E-Field Probe ET3DV6	1605	Jan. 31, 2014	Annual	Jan. 31, 2015
SPEAG	CLA150	4014	Sep. 04, 2014	Annual	Sep. 04, 2015
Agilent	Power Meter(F) E4419B	MY41291386	Nov. 01, 2013	Annual	Nov. 01, 2014
Agilent	Power Sensor(G) 8481	MY41090680	Oct. 30, 2013	Annual	Oct. 30, 2014
HP	Dielectric Probe Kit 85070C	00721521	CBT		
HP	Dual Directional Coupler 778D	16072	Oct. 31, 2013	Annual	Oct. 31, 2014
Agilent	Base Station E5515C	GB44400269	Feb. 10, 2014	Annual	Feb. 10, 2015
HP	Signal Generator 8664A	3744A02069	Nov. 04, 2013	Annual	Nov. 04, 2014
Hewlett Packard	11636B/Power Divider	11377	Nov. 10, 2013	Annual	Nov. 11, 2014
SONOMA	Amplifier/310N	320622	Feb. 26, 2014	Annual	Feb. 26, 2015
Agilent	N9020A/ SIGNAL ANALYZER	MY50510407	Mar. 25, 2014	Annual	Mar. 25, 2015
TESCOM	TC-3000C / BLUETOOTH	3000C000276	Apr. 11, 2014	Annual	Apr. 11, 2015
HP	Network Analyzer 8753ES	JP39240221	Mar. 21, 2014	Annual	Mar. 21, 2015

NOTE:

1. The E-field probe was calibrated by SPEAG, by the waveguide technique procedure. Dipole Verification measurement is performed by HCT Lab. before each test. The brain/body simulating material is calibrated by HCT using the dielectric probe system and network analyzer to determine the conductivity and permittivity (dielectric constant) of the brain/body-equivalent material.

2. CBT(Calibrating Before Testing). Prior to testing, the dielectric probe kit was calibrated via the network analyzer, with the specified procedure(calibrated in pure water) and calibration kit(standard) short circuit, before the dielectric measurement. The specific procedure and calibration kit are provided by Agilent

6. SAR MEASUREMENT PROCEDURE

The evaluation was performed with the following procedure:

1. The SAR value at a fixed location above the ear point was measured and was used as a reference value for assessing the power drop.
2. The SAR distribution at the exposed side of the head was measured at a distance of 3.9mm from the innersurface of the shell. The area covered the entire dimension of the head and the horizontal grid spacing was 15mm x 15mm. Based on this data, the area of the maximum absorption was determined by spline interpolation.
3. Around this point, a volume of 32mm x 32mm x 30 mm was assessed by measuring 5 x 5 x 7 points. On this basis of this data set, the spatial peak SAR value was evaluated with the following procedure:
 - a. The data at the surface were extrapolated, since the center of the dipoles is 2.7mm away from the tip of the probe and the distance between the surface and the lowest measuring point is 1.2mm. The extrapolation was based on a least square algorithm. A polynomial of the fourth order was calculated through the points in z-axis. This polynomial was then used to evaluate the points between the surface and the probe tip.
 - b. The maximum interpolated value was searched with a straight-forward algorithm. Around this maximum the SAR values averaged over the spatial volumes (1g or 10g) were computed using the 3D-Spline interpolation algorithm. The 3D-spline is composed of three one-dimensional splines with the "Not a knot" condition (in x, y, and z directions). The volume was integrated with the trapezoidal algorithm. One thousand points (10 x 10 x 10) were interpolated to calculate the average.
 - c. All neighboring volumes were evaluated until no neighboring volume with a higher average value was found.
4. The SAR value, at the same location as procedure #1, was re-measured. If the value changed by more than 5%, the evaluation is repeated.

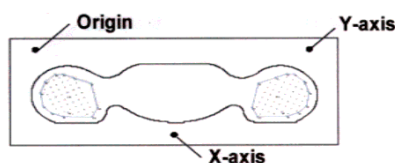

Figure 12. SAR Measurement Point in Area Scan

First Area Scan is used to locate the approximate location(s) of the local peak SAR value(s). The measurement grid within an Area Scan is defined by the grid extend, grid step size and grid offset. Next, in order to determine the EM field distribution in a three-dimensional spatial extension, Zoom Scan is required. The Zoom Scan is performed around the highest E-field value to determine the averaged SAR-distribution over 10g.

Area scan and zoom scan resolution setting follow KDB 865664 D01v01r03 quoted below.

		≤ 3 GHz	> 3 GHz
Maximum distance from closest measurement point (geometric center of probe sensors) to phantom surface		5 ± 1 mm	$\frac{1}{2} \cdot \delta \cdot \ln(2) \pm 0.5$ mm
Maximum probe angle from probe axis to phantom surface normal at the measurement location		$30^\circ \pm 1^\circ$	$20^\circ \pm 1^\circ$
Maximum area scan spatial resolution: $\Delta x_{Area}, \Delta y_{Area}$		≤ 2 GHz: ≤ 15 mm 2 – 3 GHz: ≤ 12 mm	3 – 4 GHz: ≤ 12 mm 4 – 6 GHz: ≤ 10 mm
		When the x or y dimension of the test device, in the measurement plane orientation, is smaller than the above, the measurement resolution must be \leq the corresponding x or y dimension of the test device with at least one measurement point on the test device.	
Maximum zoom scan spatial resolution: $\Delta x_{Zoom}, \Delta y_{Zoom}$		≤ 2 GHz: ≤ 8 mm 2 – 3 GHz: ≤ 5 mm*	3 – 4 GHz: ≤ 5 mm* 4 – 6 GHz: ≤ 4 mm*
Maximum zoom scan spatial resolution, normal to phantom surface	uniform grid: $\Delta z_{Zoom}(n)$	≤ 5 mm	3 – 4 GHz: ≤ 4 mm 4 – 5 GHz: ≤ 3 mm 5 – 6 GHz: ≤ 2 mm
	graded grid	$\Delta z_{Zoom}(1)$: between 1 st two points closest to phantom surface	≤ 4 mm
		$\Delta z_{Zoom}(n>1)$: between subsequent points	$\leq 1.5 \cdot \Delta z_{Zoom}(n-1)$
Minimum zoom scan volume	x, y, z	≥ 30 mm	3 – 4 GHz: ≥ 28 mm 4 – 5 GHz: ≥ 25 mm 5 – 6 GHz: ≥ 22 mm
<p>Note: δ is the penetration depth of a plane-wave at normal incidence to the tissue medium; see draft standard IEEE P1528-2011 for details.</p> <p>* When zoom scan is required and the <i>reported</i> SAR from the area scan based <i>1-g SAR estimation</i> procedures of KDB 447498 is ≤ 1.4 W/kg, ≤ 8 mm, ≤ 7 mm and ≤ 5 mm zoom scan resolution may be applied, respectively, for 2 GHz to 3 GHz, 3 GHz to 4 GHz and 4 GHz to 6 GHz.</p>			

7. DESCRIPTION OF TEST POSITION

7.1 Body Holster/Belt Clip Configurations

Body-worn operating configurations are tested with the belt-clips and holsters attached to the device and positioned against a flat phantom in a normal use configuration. A device with a headset output is tested with a headset connected to the device. Body dielectric parameters are used.

Accessories for Body-worn operation configurations are divided into two categories: those that do not contain metallic components and those that contain metallic components. When multiple accessories that do not contain metallic components are supplied with the device, the device is tested with only the accessory that dictates the closest spacing to the body. Then multiple accessories that contain metallic components are tested with each accessory. If multiple accessories share an identical metallic component (i.e. the same metallic belt-clip used with different holsters with no other metallic components) only the accessory that dictates the closest spacing to the body is tested.

Body-worn accessories may not always be supplied or available as options for some Devices intended to be authorized for body-worn use. In this case, a test configuration with a separation distance between the back of the device and the flat phantom is used.

Transmitters that are designed to operate in front of a person's face, as in push-to-talk configurations, are tested for SAR compliance with the front of the device positioned to face the flat phantom. For devices that are carried next to the body such as a shoulder, waist or chest-worn transmitters, SAR compliance is tested with the accessory(ies), including headsets and microphones, attached to the device and positioned against a flat phantom in a normal use configuration.

In all cases SAR measurements are performed to investigate the worst-case positioning. Worst case positioning is then documented and used to perform Body SAR testing.

8. ANSI/ IEEE C95.1 - 1992 RF EXPOSURE LIMITS

HUMAN EXPOSURE	UNCONTROLLED ENVIRONMENT General Population (W/kg) or (mW/g)	CONTROLLED ENVIRONMENT Occupational (W/kg) or (mW/g)
SPATIAL PEAK SAR * (Brain)	1.60	8.00
SPATIAL AVERAGE SAR ** (Whole Body)	0.08	0.40
SPATIAL PEAK SAR *** (Hands / Feet / Ankle / Wrist)	4.00	20.00

Table 8.1 Safety Limits for Partial Body Exposure

NOTES:

- * The Spatial Peak value of the SAR averaged over any 1 g of tissue (defined as a tissue volume in the shape of a cube) and over the appropriate averaging time.
- ** The Spatial Average value of the SAR averaged over the whole-body.
- *** The Spatial Peak value of the SAR averaged over any 10 g of tissue (defined as a tissue volume in the shape of a cube) and over the appropriate averaging time.

Uncontrolled Environments are defined as locations where there is the exposure of individuals who have no knowledge or control of their exposure.

Controlled Environments are defined as locations where there is exposure that may be incurred by persons who are aware of the potential for exposure, (i.e.as a result of employment or occupation).

9. SAR SYSTEM VALIDATION

Per FCC KCB 865664 D02v01r01, SAR system validation status should be document to confirm measurement accuracy. The SAR systems (including SAR probes, system components and software versions) used for this device were validated against its performance specifications prior to the SAR measurements. Reference dipoles were used with the required tissue- equivalent media for system validation, according to the procedures outlined in IEEE 1528-2003 and FCC KDB 865664 D01v01r03. Since SAR probe calibrations are frequency dependent, each probe calibration point was validated at a frequency within the valid frequency range of the probe calibration point, using the system that normally operates with the probe for routine SAR measurements and according to the required tissue-equivalent media.

A tabulated summary of the system validation status including the validation date(s), measurement frequencies, SAR probes and tissue dielectric parameters has been included.

SAR System #	Probe	Probe Type	Probe Calibration Point		Dipole	Date	Dielectric Parameters		CW Validation			Modulation Validation		
							Measured Permittivity	Measured Conductivity	Sensitivity	Probe Linearity	Probe Isotropy	MOD. Type	Duty Factor	PAR
2	1605	ET3DV6	Head	149.5	4014	Oct. 24,2014	53.23	0.74	PASS	PASS	PASS	N/A	N/A	N/A
2	1605	ET3DV6	Head	150	4014	Oct. 24,2014	53.23	0.74	PASS	PASS	PASS	N/A	N/A	N/A
2	1605	ET3DV6	Head	150.5	4014	Oct. 24,2014	53.22	0.74	PASS	PASS	PASS	N/A	N/A	N/A
2	1605	ET3DV6	Body	149.5	4014	Oct. 24,2014	64.35	0.81	PASS	PASS	PASS	N/A	N/A	N/A
2	1605	ET3DV6	Body	150	4014	Oct. 24,2014	64.35	0.81	PASS	PASS	PASS	N/A	N/A	N/A
2	1605	ET3DV6	Body	150.5	4014	Oct. 24,2014	64.33	0.81	PASS	PASS	PASS	N/A	N/A	N/A

Table 9.1 SAR System Validation Summary

Note;

All measurement were performed using probes calibrated for CW signal only. Modulations in the table above represent test configurations for which the measurement system has been validated per FCC KDB Publication 865664 D01v01r03. SAR system were validated for modulated signals with a periodic duty cycle, such as GMSK, or with a high peak to average ratio (>5 dB), such as OFDM according to KDB 865664 D01v01r03.

According to KDB Inquiry, HCT was fully validated the in the 150 MHz validation from 149.5 MHz to 150.5 MHz

10. SYSTEM VERIFICATION

10.1 Tissue Verification

Freq. [MHz]	Date	Probe	Dipole	Liquid	Liquid Temp. [°C]	Parameters	Target Value	Measured Value	Deviation [%]	Limit [%]
150	Oct. 24, 2014	1605	4014	Head	20.3	ϵ_r	52.3	51.889	-0.79	± 5
						σ	0.76	0.746	-1.84	± 5
150	Oct. 24, 2014	1605		Body	20.3	ϵ_r	61.9	64.108	+ 3.57	± 5
						σ	0.80	0.805	+ 0.63	± 5
150	Oct. 25, 2014	1605		Body	20.6	ϵ_r	61.9	64.276	+ 3.84	± 5
						σ	0.80	0.807	+ 0.88	± 5
150	Oct. 26, 2014	1605		Body	20.8	ϵ_r	61.9	64.171	+ 3.67	± 5
						σ	0.80	0.807	+ 0.88	± 5

The Tissue dielectronic parameters were measured prior to the SAR evaluation using an Agilent 85070C Dielectronic Probe Kit and Agilent Network Analyzer.

10.2 System Verification

Prior to assessment, the system is verified to the ± 10 % of the specifications at 150MHz by using the system Verification kit. (Graphic Plots Attached)

Freq. [MHz]	Date	Probe (SN)	Dipole (SN)	Liquid	Amb. Temp. [°C]	Liquid Temp. [°C]	1 W Target SAR _{1g} (SPEAG) (mW/g)	Measured SAR _{1g} (mW/g)	1 W Normalized SAR _{1g} (mW/g)	Deviation [%]	Limit [%]
150	Oct. 24, 2014	1605	4014	Head	20.5	20.3	3.72	0.361	3.61	-2.96	± 10
150	Oct. 24, 2014	1605		Body	20.5	20.3	3.81	0.398	3.98	+ 4.46	± 10
150	Oct. 25, 2014	1605		Body	20.8	20.6	3.81	0.394	3.94	+ 3.41	± 10
150	Oct. 26, 2014	1605		Body	21.0	20.8	3.81	0.393	3.93	+ 3.15	± 10

10.3 System Verification Procedure

SAR measurement was prior to assessment, the system is verified to the $\pm 10\%$ of the specifications at each frequencybandby using the system Verification kit. (Graphic Plots Attached)

- Cabling the system, using the Verification kit equipments.
- Generate about 100 mW Input Level from the Signal generator to the Dipole Antenna.
- Dipole Antenna was placed below the Flat phantom.
- The measured one-gram SAR at the surface of the phantom above the dipole feed-point should be within 10 % of the target reference value.
- The results are normalized to 1 W input power.

NOTE;

SAR Verification was performed according to the FCC KDB 865664D01v01r03.

11. RF CONDUCTED POWER MEASUREMENT

Power measurements were performed using a base station simulator under digital average power. The handset was placed into a simulated call using a base station simulator in a shielded chamber. Such test signals offer a consistent means for testing SAR and are recommended for evaluation SAR. SAR measurements were taken with a fully charged battery. In order to verify that the device was tested and maintained at full power, this was configured with the base station simulator. The SAR measurement Software calculates a reference point at the start and end of the test to check for power drifts. If conducted Power deviations of more than 5 % occurred, the tests were repeated.

11.1 Output Power Specifications.

This device operates using the following maximum output power specifications. SAR values were scaled to the maximum allowed power to determine compliance per KDB publication 447498 D01v05r02.

Transceiver section
Output Power : 6W
Tune-up Tolerance : - 0.2 W/ +0.2 W

Bluetooth section
Output Power : 2.5mW

11.2 Output Average Conducted Power

UHF			
Model	Frequency	Channel	Power(dBm)
Nx-5200-K3	150.05	1	37.64
	158	2	37.63
	166	3	37.45
	173.95	4	37.47
Nx-5200-K2	150.05	1	37.62
	158	2	37.61
	166	3	37.40
	173.95	4	37.42

For FCC Band:

Per KDB 447498 D01 v05r01 Page 7 section 6) pages 7-8, the number of channels required to be tested is as follows.

F_{high} = 174 MHz

F_c = 162 MHz

F_{Low} = 150 MHz

$N_c = \text{Round} \{ [100(f_{high} - f_{low}) / f_c]^{0.5} \times (f_c / 100)^{0.2} \} = \text{Round} \{ [100(174-150) / 162]^{0.5} \times (162 / 100)^{0.2} \} = 4$

Therefore, for the frequency band from 450 MHz to 512, 5 channels are required for testing.

11.3 SAR Test Exclusions Applied

11.3.1BT

Per FCC KDB 447498 D01v05r02, The SAR exclusion threshold for distance < 50mm is defined by the following equation:

$$\frac{MaxPowerofChannel(mW)}{TestSeparationDistance(mm)} * \sqrt{Frequency(GHz)} \leq 3.0$$

. Mode	Frequency	Maximum Allowed Power	Separation Distance	3.0
	[MHz]	[mW]	[mm]	
Bluetooth	2480	2.5	25	0.16

Based on the maximum conducted power of Bluetooth and antenna to use separation distance, Bluetooth SAR was not required $[(2.5/25)*\sqrt{2.480}] = 0.16 < 3.0$.

this device contains transmitters that may operate simultaneously. Therefore simultaneous transmission analysis is required. Per FCC KDB 447498 D01v05r02 IV.C.1iii, simultaneous transmission SAR test exclusion may be applied when the sum of the 1-g SAR for all the simultaneous transmitting antennas in a specific a physical test configuration is $\leq 1.6W/kg$. When standalone SAR is not required to be measured per FCC KDB 447498 D01v05r02 4.3.22, the following equation must be used to estimate the standalone 1-g SAR for simultaneous transmission assessment involving that transmitter

$$Estimated\ SAR = \frac{\sqrt{f(GHZ)}}{7.5} * \frac{(Max\ Power\ of\ channel\ mW)}{Min\ Seperation\ Distance}$$

. Mode	Frequency	Maximum Allowed Power	separation Distance (Body)	Estimated SAR (Body)
	[MHz]	[mW]	[mm]	[W/kg]
Bluetooth	2441	2.5	25	0.02

Note : Held-to ear configurations are not applicable to Bluetooth operations and therefore were not considered for simultaneous transmission. The Estimated SAR results were determined according to FCC KDB447498 D01v05r02.

12. SAR TEST DATA SUMMARY

12.1 Measurement Results (Face-held SAR)

Frequency		Mode	Power (dBm)		Power Drift (dB)	Battery	Model	Antenna	Separation Distance	Measured SAR(mW/g)	Adjusted SAR(mW/g)	SAR 50% Duty (mW/g)	Plot No.	
MHz	Ch.		Tune-Up Limit	Conducted Power										
150.05	1	FM	37.92	37.56	- 0.17	KNB-L3	NX-5200-K3	KRA-26(M)	25mm	2.86	3.16	1.58	1	
173.95	4		37.92	37.50	- 0.17	KNB-L3	NX-5200-K3	KRA-26(M2)	25mm	2.35	2.72	1.36		
150.05	1		37.92	37.56	- 0.07	KNB-L3	NX-5200-K3	KRA-22(M)	25mm	1.58	1.72	0.86		
173.95	4		37.92	37.56	- 0.15	KNB-L3	NX-5200-K3	KRA-22(M2)	25mm	1.34	1.54	0.77		
150.05	1		37.92	37.50	- 0.27	KNB-L3	NX-5200-K3	KRA-41(M)	25mm	0.919	1.04	0.52		
173.95	4		37.92	37.56	- 0.7	KNB-L3	NX-5200-K3	KRA-41(M2)	25mm	0.56	0.74	0.37		
150.05	1		37.92	37.56	- 0.3	KNB-L3	NX-5200-K3	KRA-25	25mm	2.56	2.58	1.29		
150.05	1		37.92	37.56	- 0.06	KNB-L3	NX-5200-K3	KRA-28	25mm	1.15	1.24	0.62		
150.05	1		37.92	37.56	- 0.17	KNB-L1	NX-5200-K3	KRA-26(M)	25mm	2.52	2.8	1.40		
150.05	1		37.92	37.56	- 0.05	KNB-L2	NX-5200-K3	KRA-26(M)	25mm	2.65	2.86	1.43		
150.05	1		37.92	37.56	- 0.29	KNB-L3	NX-5200-K2	KRA-26(M)	25mm	2.59	2.96	* 1.48	2	
150.05	1		37.92	37.56	- 0.14	KNB-L3	NX-5200-K3	KRA-26(M)	25mm	2.02	1.86	** 0.93	3	
ANSI/ IEEE C95.1 - 1992- Safety Limit Spatial Peak controlled Exposure/ Occupational										Head 8 W/kg (mW/g) Averaged over 1 gram				

- The test data reported are the worst-case SAR values according to test procedures specified in IEEE 1528-2003, FCC KDB Procedure.
- All modes of operation were investigated and the worst-case are reported.
- The manufacturer has confirmed that the device(s) tested have the same physical, mechanical and thermal characteristics and are within operational tolerances expected for production units
- Liquid tissue depth was at least 15.0 cm for all frequencies
- Tissue parameters and temperatures are listed on the SAR plot.
- Batteries are fully charged at the beginning of the SAR measurements.
- Test Signal Call Mode Manual Test cord Base Station Simulator
- SAR Configuration Head Body Hand
- The EUT was tested for face-held SAR with a 2.5cm separation distance between the front of the EUT and the outer surface of the planer phantom
- SAR Measurement Time 30min
- The adjusted SAR value was calculated by first scaling the SAR value up by the drift. This value was then scaled up based on the difference of the upper end the tolerance (37.92dBm) and the measured conducted power. The resultant value is then multiplied by 0.5 to give the SAR value at 50% duty cycle
- SAR results were scaled to the maximum allowed power to demonstrate compliance per FCC KDB 447498 D01v05r02.
Test Procedures applied in accordance with FCC KDB 643646 D01v01
- For Face-held configuration, the highest capacity battery was selected as the default battery.(KNB-L3)
- Measurement was reduced per KDB 643646 D01 v01r01
- When the SAR for all antennas tested using the default battery is 3.5 W/kg (50% PTT duty factor), testing of all other required channels is not necessary.
- When the SAR for all antennas tested using the default battery ≤ 4.0 W/kg(50% PTT duty factor), test additional batteries using the antenna and channel configuration that resulted in the highest SAR.
- * The worst case configuration was repeated with the K2 model.
- ** The face-held worst case configuration was repeated KMC-49 with the Audio Accessory

12.2 Measurement Results (Body-wornBelt clip SAR)

Frequency		Mode	Power (dBm)		Power Drift (dB)	Battery	Model	Antenna	Measured SAR(mW/g)	Adjusted SAR(mW/g)	SAR 50% Duty (mW/g)	Plot No.
MHz	Ch.		Tune-Up Limit	Conducted Power								
150.05	1	FM	37.92	37.64	- 0.10	KNB-L1	NX-5200-K3	KRA-26(M)	8.69	9.48	4.74	4
158	2		37.92	37.63	- 0.12	KNB-L1	NX-5200-K3	KRA-26(M)	3.05	3.35	1.68	
173.95	4		37.92	37.47	- 0.48	KNB-L1	NX-5200-K3	KRA-26(M2)	1.46	1.81	0.91	
150.05	1		37.92	37.64	- 0.35	KNB-L1	NX-5200-K3	KRA-22(M)	4.27	4.93	2.47	
173.95	4		37.92	37.47	- 0.02	KNB-L1	NX-5200-K3	KRA-22(M2)	0.659	0.74	0.37	
150.05	1		37.92	37.64	- 0.38	KNB-L1	NX-5200-K3	KRA-41(M)	2.88	3.35	1.67	
173.95	4		37.92	37.47	- 0.4	KNB-L1	NX-5200-K3	KRA-41(M2)	0.216	0.26	0.13	
150.05	1		37.92	37.64	- 0.01	KNB-L1	NX-5200-K3	KRA-25	7.30	7.80	3.90	5
158	2		37.92	37.63	- 0.23	KNB-L1	NX-5200-K3	KRA-25	7.19	8.10	4.05	6
150.05	1		37.92	37.64	- 0.33	KNB-L1	NX-5200-K3	KRA-28	2.09	2.40	1.20	
150.05	1		37.92	37.64	- 0.28	KNB-L2	NX-5200-K3	KRA-26(M)	7.27	8.26	4.13	7
150.05	1		37.92	37.64	- 0.28	KNB-L3	NX-5200-K3	KRA-26(M)	7.09	8.06	4.03	8
150.05	1		37.92	37.64	- 0.05	KNB-L1	NX-5200-K2	KRA-26(M)	7.20	7.76	* 3.88	9
150.05	1		37.92	37.64	- 0.24	KNB-L1	NX-5200-K3	KRA-26(M)	4.09	4.61	** 2.30	10
ANSI/ IEEE C95.1 – 1992– Safety Limit Spatial Peak controlled Exposure/ Occupational									Body 8 W/kg (mW/g) Averaged over 1 gram			

- 1 The test data reported are the worst-case SAR values according to test procedures specified in IEEE 1528-2003, FCC KDB Procedure.
- 2 All modes of operation were investigated and the worst-case are reported.
- 3 The manufacturer has confirmed that the device(s) tested have the same physical, mechanical and thermal characteristics and are within operational tolerances expected for production units
- 4 Liquid tissue depth was at least 15.0 cm for all frequencies
- 5 Tissue parameters and temperatures are listed on the SAR plot.
- 6 Batteries are fully charged at the beginning of the SAR measurements.
- 7 Test Signal Call Mode Manual Test cord Base Station Simulator
- 8 SAR Configuration Head Body Hand
- 9 The Body-worn SAR evaluation was performed with the Leather Case body-worn accessory attached to the DUT and touching the outer surface of the planar phantom.
- 10 SAR Measurement Time 30min
- 11 The adjusted SAR value was calculated by first scaling the SAR value up by the drift. This value was then scaled up based on the difference of the upper end the tolerance (37.92dBm) and the measured conducted power. The resultant value is then multiplied by 0.5 to give the SAR value at 50% duty cycle
- 12 SAR results were scaled to the maximum allowed power to demonstrate compliance per FCC KDB 447498 D01v05r02.
Test Procedures applied in accordance with FCC KDB 643646 D01v01
- 13 For Body-worn configuration, the thinnest standard battery was selected as the default battery.(KNB-L1)
- 14 The body-worn SAR evaluation was performed with the speaker-microphone audio accessory connected to the DUT.Audio Accessory KMC-54WD was selected as the default audio accessory.
- 15 When the SAR for all antennas tested using the default battery is > 4.0 W/kg and 6.0 W/kg (50% PTT duty factor), test additional batteries using the antenna and channel configuration that resulted in the highest SAR.
- 16 When the SAR of an antenna tested on the highest output power channel using the default battery is > 4.0 W/kg and 6.0 W/kg (50% PTT duty factor), testing of the required immediately adjacent channel(s) is necessary. For the remaining channels that cannot be excluded, this rule may be applied recursively with respect to the highest output power channel among the remaining channels.
- 17 Based on the SAR measured in the body-worn test sequence with default audio accessory, if the SAR for the antenna, body-worn accessory and battery combination(s) applicable to an audio accessory is/are >4.0 W/kg and < 6.0 W/kg(50% PTT duty factor), test that audio accessory using the highest body-worn SAR combination(antenna, battery and body-worn accessory) and channel configuration previously identified that is applicable to the audio accessory.
- 18 * The worst case configuration was repeated with the K2 model.
- 19 ** The body-worn worst case configuration was repeated KMC-49 with the Audio Accessory

12.3 Measurement Results (Body-worn Nylon Case SAR)

Frequency		Mode	Power (dBm)		Power Drift (dB)	Battery	Model	Antenna	Measured SAR(mW/g)	Adjusted SAR(mW/g)	SAR 50% Duty (mW/g)	Plot No.
MHz	Ch.		Tune-Up Limit	Conducted Power								
150.05	1	FM	37.92	37.64	-0.26	KNB-L1	NX-5200-K3	KRA-26(M)	4.21	4.76	2.38	11
173.95	4		37.92	37.47	-0.36	KNB-L1	NX-5200-K3	KRA-26(M2)	0.765	0.92	0.46	
150.05	1		37.92	37.64	-0.11	KNB-L1	NX-5200-K3	KRA-22(M)	3.28	3.58	1.79	
173.95	4		37.92	37.47	-0.04	KNB-L1	NX-5200-K3	KRA-22(M2)	0.563	0.63	0.32	
150.05	1		37.92	37.64	-0.07	KNB-L1	NX-5200-K3	KRA-41(M)	2.48	2.69	1.34	
173.95	4		37.92	37.47	-0.27	KNB-L1	NX-5200-K3	KRA-41(M2)	0.121	0.14	0.07	
150.05	1		37.92	37.64	-0.21	KNB-L1	NX-5200-K3	KRA-25	4.12	4.61	2.30	
150.05	1		37.92	37.64	-0.27	KNB-L1	NX-5200-K3	KRA-28	1.28	1.45	0.73	
150.05	1		37.92	37.64	-0.07	KNB-L2	NX-5200-K3	KRA-26(M)	4.19	4.54	2.27	
150.05	1		37.92	37.64	-0.03	KNB-L3	NX-5200-K3	KRA-26(M)	3.28	3.52	1.76	
150.05	1		37.92	37.64	-0.12	KNB-L1	NX-5200-K2	KRA-26(M)	3.98	4.36	* 2.18	12
ANSI/ IEEE C95.1 - 1992- Safety Limit Spatial Peak controlled Exposure/ Occupational									Body 8 W/kg (mW/g) Averaged over 1 gram			

- The test data reported are the worst-case SAR values according to test procedures specified in IEEE 1528-2003, FCC KDB Procedure.
- All modes of operation were investigated and the worst-case are reported.
- The manufacturer has confirmed that the device(s) tested have the same physical, mechanical and thermal characteristics and are within operational tolerances expected for production units
- Liquid tissue depth was at least 15.0 cm for all frequencies
- Tissue parameters and temperatures are listed on the SAR plot.
- Batteries are fully charged at the beginning of the SAR measurements.
- Test Signal Call Mode Manual Test cord Base Station Simulator
- SAR Configuration Head Body Hand
- The Body-worn SAR evaluation was performed with the Leather Case body-worn accessory attached to the DUT and touching the outer surface of the planar phantom.
- SAR Measurement Time 30min
- The adjusted SAR value was calculated by first scaling the SAR value up by the drift. This value was then scaled up based on the difference of the upper end the tolerance (37.92dBm) and the measured conducted power. The resultant value is then multiplied by 0.5 to give the SAR value at 50% duty cycle
- SAR results were scaled to the maximum allowed power to demonstrate compliance per FCC KDB 447498 D01v05r02.
Test Procedures applied in accordance with FCC KDB 643646 D01v01
- For Body-worn configuration, the thinnest standard battery was selected as the default battery.(KNB-L1)
- The body-worn SAR evaluation was performed with the speaker-microphone audio accessory connected to the DUT.Audio Accessory KMC-54WD was selected as the default audio accessory.
- When the SAR for all antennas tested using the default battery is 3.5 W/kg (50% PTT duty factor), testing of all other required channels is not necessary.
- When the SAR for all antennas tested using the default battery ≤ 4.0 W/kg (50% PTT duty factor) W/kg, test additional batteries using the antenna and channel configuration that resulted in the highest SAR.
- * The worst case configuration was repeated with the K2 model.

12.4 Measurement Results (Body-wornKBH-8DS SAR)

Frequency		Mode	Power (dBm)		Power Drift (dB)	Battery	Model	Antenna	Measured SAR(mW/g)	Adjusted SAR(mW/g)	SAR 50% Duty (mW/g)	Plot No.
MHz	Ch.		Tune-Up Limit	Conducted Power								
150.05	1	FM	37.92	37.64	-0.08	KNB-L1	NX-5200-K3	KRA-26(M)	1.79	1.94	0.97	13
173.95	4		37.92	37.47	-0.47	KNB-L1	NX-5200-K3	KRA-26(M2)	0.631	0.78	0.39	
150.05	1		37.92	37.64	-0.04	KNB-L1	NX-5200-K3	KRA-22(M)	1.09	1.17	0.59	
173.95	4		37.92	37.47	-0.46	KNB-L1	NX-5200-K3	KRA-22(M2)	0.03	0.04	0.02	
150.05	1		37.92	37.64	-0.04	KNB-L1	NX-5200-K3	KRA-41(M)	0.375	0.40	0.20	
173.95	4		37.92	37.47	-0.07	KNB-L1	NX-5200-K3	KRA-41(M2)	0.04	0.05	0.02	
150.05	1		37.92	37.64	-0.35	KNB-L1	NX-5200-K3	KRA-25	1.52	1.76	0.88	
150.05	1		37.92	37.64	-0.12	KNB-L1	NX-5200-K3	KRA-28	0.791	0.87	0.43	
150.05	1		37.92	37.64	-0.22	KNB-L2	NX-5200-K3	KRA-26(M)	1.68	1.88	0.94	
150.05	1		37.92	37.64	-0.06	KNB-L3	NX-5200-K3	KRA-26(M)	1.68	1.82	0.91	
150.05	1		37.92	37.64	-0.1	KNB-L1	NX-5200-K2	KRA-26(M)	1.74	1.90	* 0.95	14
ANSI/ IEEE C95.1 - 1992- Safety Limit Spatial Peak controlled Exposure/ Occupational									Body 8 W/kg (mW/g) Averaged over 1 gram			

- The test data reported are the worst-case SAR values according to test procedures specified in IEEE 1528-2003, FCC KDB Procedure.
- All modes of operation were investigated and the worst-case are reported.
- The manufacturer has confirmed that the device(s) tested have the same physical, mechanical and thermal characteristics and are within operational tolerances expected for production units
- Liquid tissue depth was at least 15.0 cm for all frequencies
- Tissue parameters and temperatures are listed on the SAR plot.
- Batteries are fully charged at the beginning of the SAR measurements.
- Test Signal Call Mode Manual Test cord Base Station Simulator
- SAR Configuration Head Body Hand
- The Body-worn SAR evaluation was performed with the Leather Case body-worn accessory attached to the DUT and touching the outer surface of the planar phantom.
- SAR Measurement Time 30min
- The adjusted SAR value was calculated by first scaling the SAR value up by the drift. This value was then scaled up based on the difference of the upper end the tolerance (37.92dBm) and the measured conducted power. The resultant value is then multiplied by 0.5 to give the SAR value at 50% duty cycle
- SAR results were scaled to the maximum allowed power to demonstrate compliance per FCC KDB 447498 D01v05r02.
Test Procedures applied in accordance with FCC KDB 643646 D01v01
- For Body-worn configuration, the thinnest standard battery was selected as the default battery.(KNB-L1)
- The body-worn SAR evaluation was performed with the speaker-microphone audio accessory connected to the DUT.Audio Accessory KMC-54WD was selected as the default audio accessory.
- When the SAR for all antennas tested using the default battery is 3.5 W/kg (50% PTT duty factor), testing of all other required channels is not necessary.
- When the SAR for all antennas tested using the default battery ≤ 4.0(50% PTT duty factor) W/kg, test additional batteries using the antenna and channel configuration that resulted in the highest SAR.
- * The worst case configuration was repeated with the K2 model.

13. SAR Summation Scenario

	Position	Applicable Combination	Note
Simultaneous Transmission	Body-worn	150MHzFM+ 2.4 GHz Bluetooth	

13.1 Simultaneous Transmission Summation for Body-Worn

Simultaneous Transmission Summation with Bluetooth (2.5cm)

Band	configuration	Scaled SAR (W/kg)	BT SAR (W/kg)	\sum 1-g SAR (W/kg)
150MHz(FCC)	Rear	4.74	0.02	4.76

13.2 Simultaneous Transmission Conclusion

The above numerical summed SAR results for all the worst-case simultaneous transmission conditions were below the SAR limit. Therefore, the above analysis is sufficient to determine that simultaneous transmission cases will not exceed the SAR limit. And therefore no measured volumetric simultaneous SAR summation is required per FCC KDB Publication 447498 D01v05r02.

14. CONCLUSION

The SAR measurement indicates that the EUT complies with the RF radiation exposure limits of the ANSI/IEEE C95.1 1992.

These measurements are taken to simulate the RF effects exposure under worst-case conditions. Precise laboratory measures were taken to assure repeatability of the tests.

15. REFERENCES

- [1] IEEE Standards Coordinating Committee 34 – IEEE Std. 1528-2003, IEE Recommended Practice on Determining the Peak Spatial-Average Specific Absorption Rate (SAR) in the Human Body from Wireless Communications Devices.
- [2] Federal Communications Commission, ET Docket 93-62, Guidelines for Evaluating the Environmental Effects of Radio frequency Radiation, Aug. 1996.
- [3] ANSI/IEEE C95.1 - 1991, American National Standard safety levels with respect to human exposure to radio frequency electromagnetic fields, 300kHz to 100GHz, New York: IEEE, Aug. 1992
- [4] ANSI/IEEE C95.3 - 1991, IEEE Recommended Practice for the Measurement of Potentially Hazardous Electromagnetic Fields - RF and Microwave, New York: IEEE, 1992.
- [5] NCRP, National Council on Radiation Protection and Measurements, Biological Effects and Exposure Criteria for Radio Frequency Electromagnetic Fields, NCRP Report No. 86, 1986. Reprinted Feb. 1995.
- [6] T. Schmid, O. Egger, N. Kuster, Automated E-field scanning system for dosimetric assessments, IEEE Transaction on Microwave Theory and Techniques, vol. 44, Jan. 1996, pp. 105-113.
- [7] K. Pokovic, T. Schmid, N. Kuster, Robust setup for precise calibration of E-field probes in tissue simulating liquids at mobile communications frequencies, ICECOM97, Oct. 1997, pp. 120-124.
- [8] K. Pokovic, T. Schmid, and N. Kuster, E-field Probe with improved isotropy in brain simulating liquids, Proceedings of the ELMAR, Zadar, Croatia, June 23-25, 1996, pp. 172-175.
- [9] Schmid & Partner Engineering AG, Application Note: Data Storage and Evaluation, June 1998, p2.
- [10] V. Hombach, K. Meier, M. Burkhardt, E. Kuhn, N. Kuster, The Dependence of EM Energy Absorption upon Human Head Modeling at 900 MHz, IEEE Transaction on Microwave Theory and Techniques, vol. 44 no. 10, Oct. 1996, pp. 1865-1873.
- [11] N. Kuster and Q. Balzano, Energy absorption mechanism by biological bodies in the near field of dipole antennas above 300MHz, IEEE Transaction on Vehicular Technology, vol. 41, no. 1, Feb. 1992, pp. 17-23.
- [12] G. Hartsgrrove, A. Kraszewski, A. Surowiec, Simulated Biological Materials for Electromagnetic Radiation Absorption Studies, University of Ottawa, Bioelectromagnetics, Canada: 1987, pp. 29-36.
- [13] Q. Balzano, O. Garay, T. Manning Jr., Electromagnetic Energy Exposure of Simulated Users of Portable Cellular Telephones, IEEE Transactions on Vehicular Technology, vol. 44, no.3, Aug. 1995.
- [14] W. Gander, Computer mathematic, Birkhaeuser, Basel, 1992.
- [15] W.H. Press, S.A. Teukolsky, W.T. Vetterling, and B.P. Flannery, Numerical Recipes in C, The Art of Scientific Computing, Second edition, Cambridge University Press, 1992.
- [16] N. Kuster, R. Kastle, T. Schmid, Dosimetric evaluation of mobile communications equipment with known precision, IEEE Transaction on Communications, vol. E80-B, no. 5, May 1997, pp. 645-652.
- [17] CENELEC CLC/SC111B, European Prestandard (prENV 50166-2), Human Exposure to Electromagnetic Fields
High-frequency: 10kHz-300GHz, Jan. 1995.
- [18] Prof. Dr. Niels Kuster, ETH, Eidgenössische Technische Hochschule Zürich, Dosimetric Evaluation of the Cellular Phone.
- [19] SAR Evaluation of Handsets with Multiple Transmitters and Antennas #648474.
- [20] SAR Measurement Procedure for 802.11 a/b/g Transmitters #KDB 248227.

Attachment 1.– SAR Test Plots

Test Laboratory: HCT CO., LTD
 EUT Type: VHF P25 TRANSCEIVER WITH BLUETOOTH
 Liquid Temperature: 20.3
 Ambient Temperature: 20.5
 Test Date: Oct. 24, 2014
 Plot No.: 1

DUT: NX-5200-K3; Type: bar

Communication System: UID 0, 150MHz FCC (0); Frequency: 150.05 MHz; Duty Cycle: 1:1
 Medium parameters used (interpolated): $f = 150.05 \text{ MHz}$; $\sigma = 0.746 \text{ S/m}$; $\epsilon_r = 51.886$; $\rho = 1000 \text{ kg/m}^3$
 Phantom section: Flat Section
 Measurement Standard: DASY5 (IEEE/IEC/ANSI C63.19-2007)

DASY4 Configuration:

- Probe: ET3DV6 - SN1605; ConvF(8.22, 8.22, 8.22); Calibrated: 2014-01-31;
- Sensor-Surface: 4mm (Mechanical Surface Detection)
- Electronics: DAE4 Sn1417; Calibrated: 2014-01-03
- Phantom: ELI v4.0; Type: QDOVA001BB; Serial: TP:xxxx
- ; SEMCAD X Version 14.6.10 (7331)

NX-5200-K3/Head front 1ch KNB-L3_26M/Area Scan (61x151x1): Interpolated grid: $dx=1.500 \text{ mm}$, $dy=1.500 \text{ mm}$
 Maximum value of SAR (interpolated) = 2.96 W/kg

NX-5200-K3/Head front 1ch KNB-L3_26M/Zoom Scan (5x5x7)/Cube 0: Measurement grid: $dx=8\text{mm}$, $dy=8\text{mm}$, $dz=5\text{mm}$
 Reference Value = 60.60 V/m; Power Drift = -0.17 dB
 Peak SAR (extrapolated) = 4.01 W/kg
SAR(1 g) = 2.86 W/kg; SAR(10 g) = 2.24 W/kg
 Maximum value of SAR (measured) = 2.94 W/kg

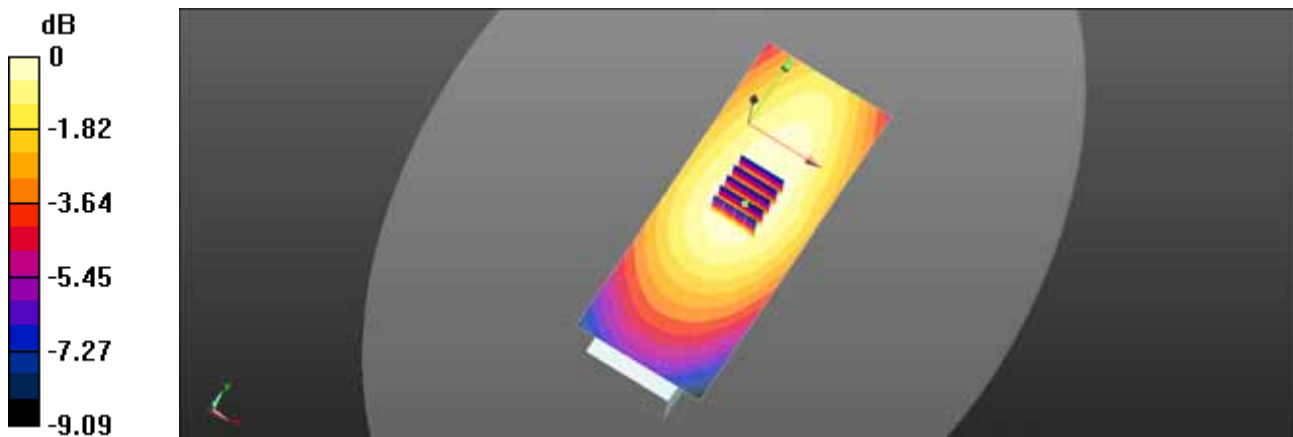

0 dB = 2.96 W/kg = 4.71 dBW/kg

Test Laboratory: HCT CO., LTD
 EUT Type: VHF P25 TRANSCEIVER WITH BLUETOOTH
 Liquid Temperature: 20.3
 Ambient Temperature: 20.5
 Test Date: Oct. 24, 2014
 Plot No.: 2

DUT: NX-5200-K2; Type: bar

Communication System: UID 0, 150MHz FCC (0); Frequency: 150.05 MHz;Duty Cycle: 1:1
 Medium parameters used (interpolated): $f = 150.05$ MHz; $\sigma = 0.746$ S/m; $\epsilon_r = 51.886$; $\rho = 1000$ kg/m³
 Phantom section: Flat Section
 Measurement Standard: DASYS5 (IEEE/IEC/ANSI C63.19-2007)

DASY4 Configuration:

- Probe: ET3DV6 - SN1605; ConvF(8.22, 8.22, 8.22); Calibrated: 2014-01-31;
- Sensor-Surface: 4mm (Mechanical Surface Detection)
- Electronics: DAE4 Sn1417; Calibrated: 2014-01-03
- Phantom: ELI v4.0; Type: QDOVA001BB; Serial: TP:xxxx
- ; SEMCAD X Version 14.6.10 (7331)

NX-5200-K2/Head front 1ch KNB-L3_26M/Area Scan (61x151x1): Interpolated grid: dx=1.500 mm, dy=1.500 mm
 Maximum value of SAR (interpolated) = 2.73 W/kg

NX-5200-K2/Head front 1ch KNB-L3_26M/Zoom Scan (5x5x7)/Cube 0: Measurement grid: dx=8mm, dy=8mm, dz=5mm
 Reference Value = 59.94 V/m; Power Drift = -0.29 dB
 Peak SAR (extrapolated) = 3.59 W/kg
SAR(1 g) = 2.59 W/kg; SAR(10 g) = 2.03 W/kg
 Maximum value of SAR (measured) = 2.67 W/kg

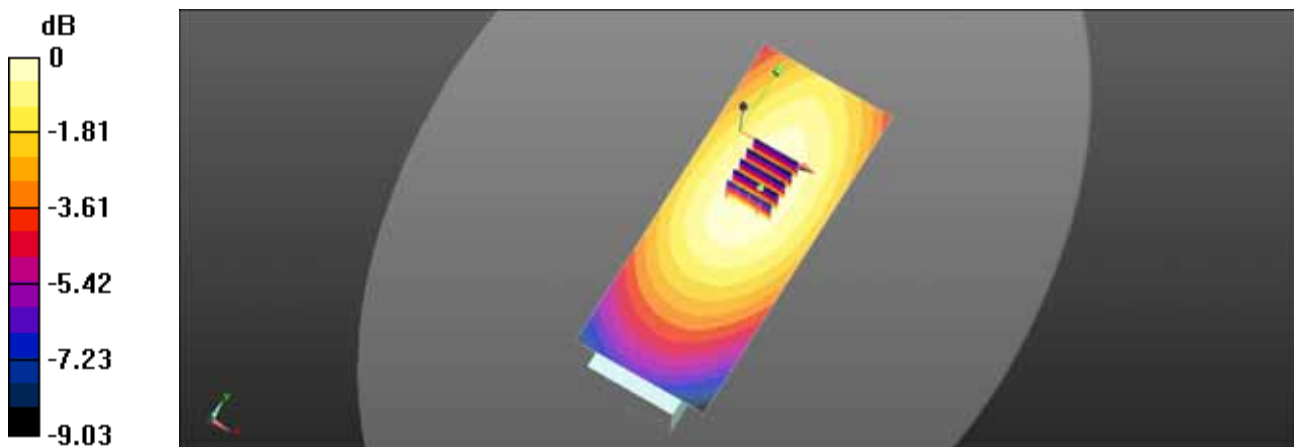

0 dB = 2.73 W/kg = 4.37 dBW/kg

Test Laboratory: HCT CO., LTD
EUT Type: VHF P25 TRANSCEIVER WITH BLUETOOTH
Liquid Temperature: 20.3
Ambient Temperature: 20.5
Test Date: Oct. 24, 2014
Plot No.: 3

DUT: KMC-49; Type: bar

Communication System: UID 0, 150MHz (0); Frequency: 150.05 MHz; Duty Cycle: 1:1
Medium parameters used (interpolated): $f = 150.05$ MHz; $\sigma = 0.746$ S/m; $\epsilon_r = 51.886$; $\rho = 1000$ kg/m³
Phantom section: Flat Section
Measurement Standard: DASYS5 (IEEE/IEC/ANSI C63.19-2007)

DASY4 Configuration:

- Probe: ET3DV6 - SN1605; ConvF(8.22, 8.22, 8.22); Calibrated: 2014-01-31;
- Sensor-Surface: 4mm (Mechanical Surface Detection)
- Electronics: DAE4 Sn1417; Calibrated: 2014-01-03
- Phantom: ELI v4.0; Type: QDOVA001BB; Serial: TP:xxxx
- ; SEMCAD X Version 14.6.10 (7331)

NX-5200-K3/Head front 1ch KNB-L3_26M_KMC-49/Area Scan (61x161x1): Interpolated grid: dx=1.500 mm, dy=1.500 mm
Maximum value of SAR (interpolated) = 2.13 W/kg

NX-5200-K3/Head front 1ch KNB-L3_26M_KMC-49/Zoom Scan (5x5x7)/Cube 0: Measurement grid: dx=8mm, dy=8mm, dz=5mm
Reference Value = 52.74 V/m; Power Drift = -0.14 dB
Peak SAR (extrapolated) = 2.86 W/kg
SAR(1 g) = 2.02 W/kg; SAR(10 g) = 1.56 W/kg
Maximum value of SAR (measured) = 2.09 W/kg

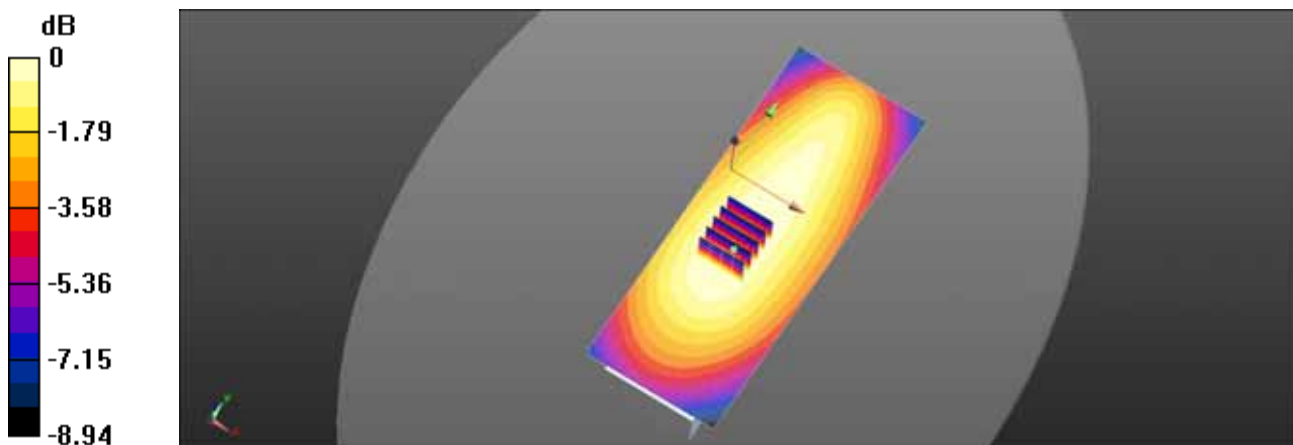

0 dB = 2.13 W/kg = 3.29 dBW/kg

Test Laboratory: HCT CO., LTD
 EUT Type: VHF P25 TRANSCEIVER WITH BLUETOOTH
 Liquid Temperature: 20.8
 Ambient Temperature: 21.0
 Test Date: Oct. 26, 2014
 Plot No.: 4

DUT: NX-5200-K3; Type: bar

Communication System: UID 0, 150MHz FCC (0); Frequency: 150.05 MHz; Duty Cycle: 1:1
 Medium parameters used (interpolated): $f = 150.05 \text{ MHz}$; $\sigma = 0.807 \text{ S/m}$; $\epsilon_r = 64.169$; $\rho = 1000 \text{ kg/m}^3$
 Phantom section: Flat Section
 Measurement Standard: DASY5 (IEEE/IEC/ANSI C63.19-2007)

DASY4 Configuration:

- Probe: ET3DV6 - SN1605; ConvF(7.44, 7.44, 7.44); Calibrated: 2014-01-31;
- Sensor-Surface: 4mm (Mechanical Surface Detection)
- Electronics: DAE4 Sn1417; Calibrated: 2014-01-03
- Phantom: ELI v4.0; Type: QDOVA001BB; Serial: TP:xxxx
- ; SEMCAD X Version 14.6.10 (7331)

NX-5200-K3/Body rear 1ch KNB-L1_26M_CLIP/Area Scan (61x151x1): Interpolated grid: $dx=1.500 \text{ mm}$, $dy=1.500 \text{ mm}$
 Maximum value of SAR (interpolated) = 6.65 W/kg

NX-5200-K3/Body rear 1ch KNB-L1_26M_CLIP/Zoom Scan (5x5x7)/Cube 0: Measurement grid: $dx=8\text{mm}$, $dy=8\text{mm}$, $dz=5\text{mm}$
 Reference Value = 77.05 V/m; Power Drift = -0.10 dB
 Peak SAR (extrapolated) = 33.6 W/kg
SAR(1 g) = 8.69 W/kg; SAR(10 g) = 4.21 W/kg
 Maximum value of SAR (measured) = 9.18 W/kg

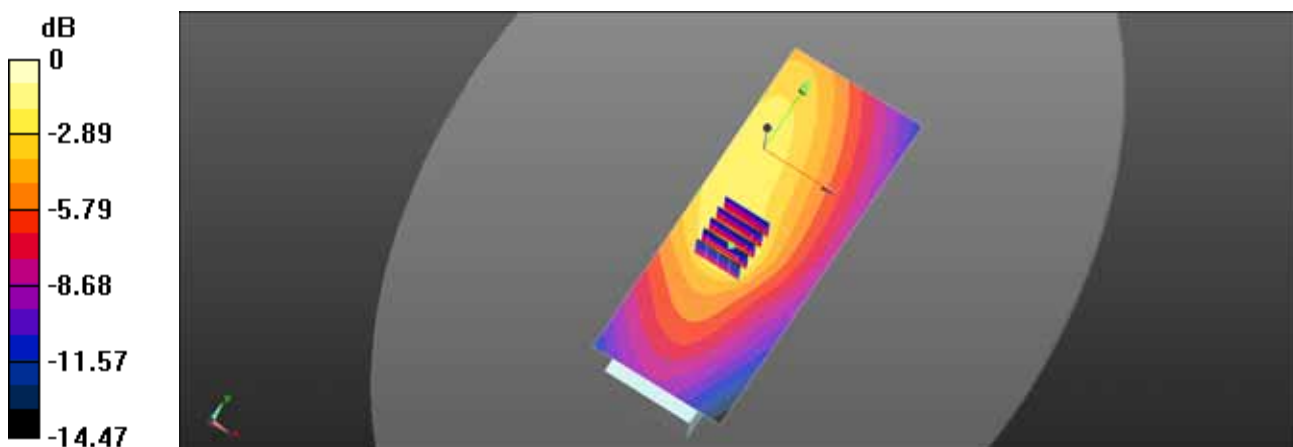

$0 \text{ dB} = 6.65 \text{ W/kg} = 8.23 \text{ dBW/kg}$

Test Laboratory: HCT CO., LTD
 EUT Type: VHF P25 TRANSCEIVER WITH BLUETOOTH
 Liquid Temperature: 20.8
 Ambient Temperature: 21.0
 Test Date: Oct. 26, 2014
 Plot No.: 5

DUT: NX-5200-K3; Type: bar

Communication System: UID 0, 150MHz FCC (0); Frequency: 150.05 MHz;Duty Cycle: 1:1
 Medium parameters used (interpolated): $f = 150.05$ MHz; $\sigma = 0.807$ S/m; $\epsilon_r = 64.169$; $\rho = 1000$ kg/m³
 Phantom section: Flat Section
 Measurement Standard: DASY5 (IEEE/IEC/ANSI C63.19-2007)

DASY4 Configuration:

- Probe: ET3DV6 - SN1605; ConvF(7.44, 7.44, 7.44); Calibrated: 2014-01-31;
- Sensor-Surface: 4mm (Mechanical Surface Detection)
- Electronics: DAE4 Sn1417; Calibrated: 2014-01-03
- Phantom: ELI v4.0; Type: QDOVA001BB; Serial: TP:xxxx
- ; SEMCAD X Version 14.6.10 (7331)

NX-5200-K3/Body rear 1ch KNB-L1_25_CLIP/Area Scan (61x151x1): Interpolated grid: dx=1.500 mm, dy=1.500 mm
 Maximum value of SAR (interpolated) = 7.03 W/kg

NX-5200-K3/Body rear 1ch KNB-L1_25_CLIP/Zoom Scan (5x5x7)/Cube 0: Measurement grid: dx=8mm, dy=8mm, dz=5mm
 Reference Value = 93.73 V/m; Power Drift = -0.01 dB
 Peak SAR (extrapolated) = 22.6 W/kg
SAR(1 g) = 7.3 W/kg; SAR(10 g) = 3.99 W/kg
 Maximum value of SAR (measured) = 7.56 W/kg

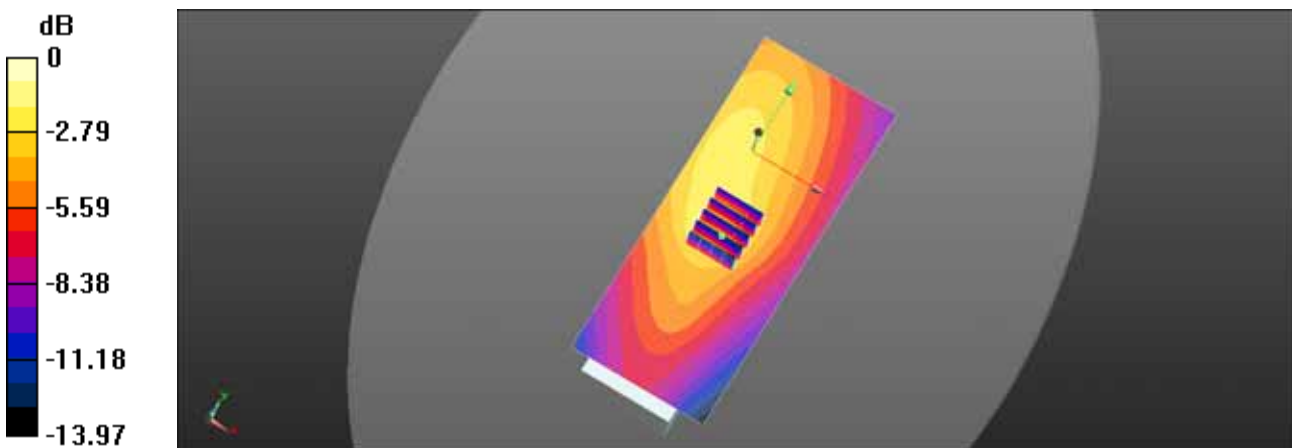

0 dB = 7.03 W/kg = 8.47 dBW/kg

Test Laboratory: HCT CO., LTD
 EUT Type: VHF P25 TRANSCEIVER WITH BLUETOOTH
 Liquid Temperature: 20.8
 Ambient Temperature: 21.0
 Test Date: Oct. 26, 2014
 Plot No.: 6

DUT: NX-5200-K3; Type: bar

Communication System: UID 0, 150MHz FCC (0); Frequency: 158 MHz;Duty Cycle: 1:1
 Medium parameters used (interpolated): $f = 158 \text{ MHz}$; $\sigma = 0.808 \text{ S/m}$; $\epsilon_r = 63.97$; $\rho = 1000 \text{ kg/m}^3$
 Phantom section: Flat Section
 Measurement Standard: DASY5 (IEEE/IEC/ANSI C63.19-2007)

DASY4 Configuration:

- Probe: ET3DV6 - SN1605; ConvF(7.44, 7.44, 7.44); Calibrated: 2014-01-31;
- Sensor-Surface: 4mm (Mechanical Surface Detection)
- Electronics: DAE4 Sn1417; Calibrated: 2014-01-03
- Phantom: ELI v4.0; Type: QDOVA001BB; Serial: TP:xxxx
- ; SEMCAD X Version 14.6.10 (7331)

NX-5200-K3/Body rear 2ch KNB-L1_25_CLIP/Area Scan (61x151x1): Interpolated grid: $dx=1.500 \text{ mm}$, $dy=1.500 \text{ mm}$
 Maximum value of SAR (interpolated) = 7.70 W/kg

NX-5200-K3/Body rear 2ch KNB-L1_25_CLIP/Zoom Scan (5x5x7)/Cube 0: Measurement grid: $dx=8\text{mm}$, $dy=8\text{mm}$, $dz=5\text{mm}$
 Reference Value = 92.28 V/m; Power Drift = -0.23 dB
 Peak SAR (extrapolated) = 21.9 W/kg
SAR(1 g) = 7.19 W/kg; SAR(10 g) = 3.97 W/kg
 Maximum value of SAR (measured) = 7.53 W/kg

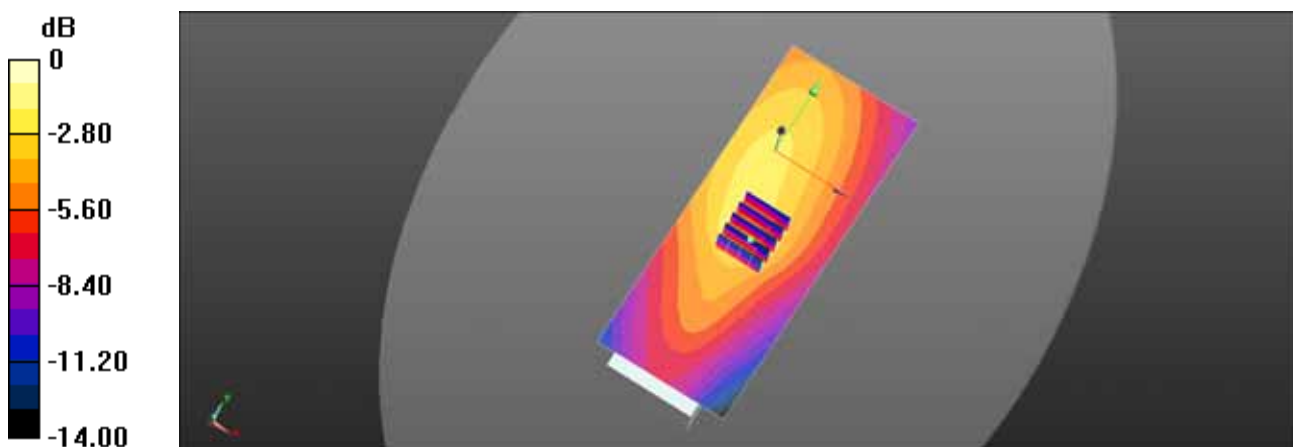

0 dB = 7.70 W/kg = 8.86 dBW/kg

Test Laboratory: HCT CO., LTD
 EUT Type: VHF P25 TRANSCEIVER WITH BLUETOOTH
 Liquid Temperature: 20.8
 Ambient Temperature: 21.0
 Test Date: Oct. 26, 2014
 Plot No.: 7

DUT: NX-5200-K3; Type: bar

Communication System: UID 0, 150MHz FCC (0); Frequency: 150.05 MHz;Duty Cycle: 1:1
 Medium parameters used (interpolated): $f = 150.05 \text{ MHz}$; $\sigma = 0.807 \text{ S/m}$; $\epsilon_r = 64.169$; $\rho = 1000 \text{ kg/m}^3$
 Phantom section: Flat Section
 Measurement Standard: DASYS (IEEE/IEC/ANSI C63.19-2007)

DASY4 Configuration:

- Probe: ET3DV6 - SN1605; ConvF(7.44, 7.44, 7.44); Calibrated: 2014-01-31;
- Sensor-Surface: 4mm (Mechanical Surface Detection)
- Electronics: DAE4 Sn1417; Calibrated: 2014-01-03
- Phantom: ELI v4.0; Type: QDOVA001BB; Serial: TP:xxxx
- ; SEMCAD X Version 14.6.10 (7331)

NX-5200-K3/Body rear 1ch KNB-L2_26M_CLIP/Area Scan (61x151x1): Interpolated grid: $dx=1.500 \text{ mm}$, $dy=1.500 \text{ mm}$
 Maximum value of SAR (interpolated) = 7.53 W/kg

NX-5200-K3/Body rear 1ch KNB-L2_26M_CLIP/Zoom Scan (5x5x7)/Cube 0: Measurement grid: $dx=8\text{mm}$, $dy=8\text{mm}$, $dz=5\text{mm}$
 Reference Value = 83.46 V/m; Power Drift = -0.28 dB
 Peak SAR (extrapolated) = 23.1 W/kg
SAR(1 g) = 7.27 W/kg; SAR(10 g) = 3.9 W/kg
 Maximum value of SAR (measured) = 7.76 W/kg

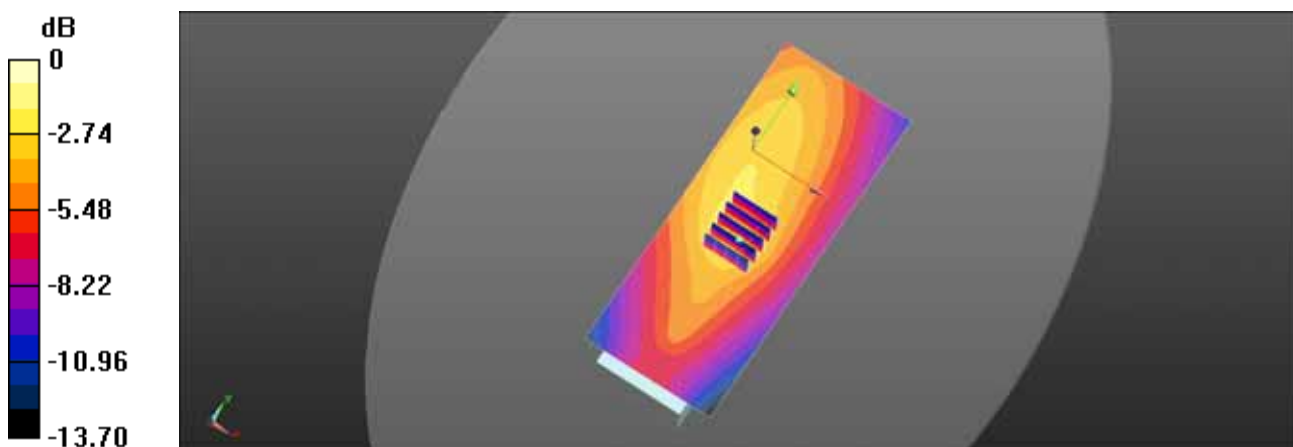

0 dB = 7.53 W/kg = 8.77 dBW/kg

Test Laboratory: HCT CO., LTD
 EUT Type: VHF P25 TRANSCEIVER WITH BLUETOOTH
 Liquid Temperature: 20.8
 Ambient Temperature: 21.0
 Test Date: Oct. 26, 2014
 Plot No.: 8

DUT: NX-5200-K3; Type: bar

Communication System: UID 0, 150MHz FCC (0); Frequency: 150.05 MHz; Duty Cycle: 1:1
 Medium parameters used (interpolated): $f = 150.05$ MHz; $\sigma = 0.807$ S/m; $\epsilon_r = 64.169$; $\rho = 1000$ kg/m³
 Phantom section: Flat Section
 Measurement Standard: DASYS5 (IEEE/IEC/ANSI C63.19-2007)

DASY4 Configuration:

- Probe: ET3DV6 - SN1605; ConvF(7.44, 7.44, 7.44); Calibrated: 2014-01-31;
- Sensor-Surface: 4mm (Mechanical Surface Detection)
- Electronics: DAE4 Sn1417; Calibrated: 2014-01-03
- Phantom: ELI v4.0; Type: QDOVA001BB; Serial: TP:xxxx
- ; SEMCAD X Version 14.6.10 (7331)

NX-5200-K3/Body rear 1ch KNB-L3_26M_CLIP/Area Scan (61x151x1): Interpolated grid: dx=1.500 mm, dy=1.500 mm

Maximum value of SAR (interpolated) = 6.04 W/kg

NX-5200-K3/Body rear 1ch KNB-L3_26M_CLIP/Zoom Scan (5x5x7)/Cube 0: Measurement grid: dx=8mm, dy=8mm, dz=5mm

Reference Value = 89.30 V/m; Power Drift = -0.28 dB

Peak SAR (extrapolated) = 21.9 W/kg

SAR(1 g) = 7.09 W/kg; SAR(10 g) = 3.83 W/kg

Maximum value of SAR (measured) = 7.71 W/kg

NX-5200-K3/Body rear 1ch KNB-L3_26M_CLIP/Zoom Scan (5x5x7)/Cube 1: Measurement grid: dx=8mm, dy=8mm, dz=5mm

Reference Value = 89.30 V/m; Power Drift = -0.28 dB

Peak SAR (extrapolated) = 6.31 W/kg

SAR(1 g) = 4.28 W/kg; SAR(10 g) = 3.23 W/kg

Maximum value of SAR (measured) = 4.44 W/kg

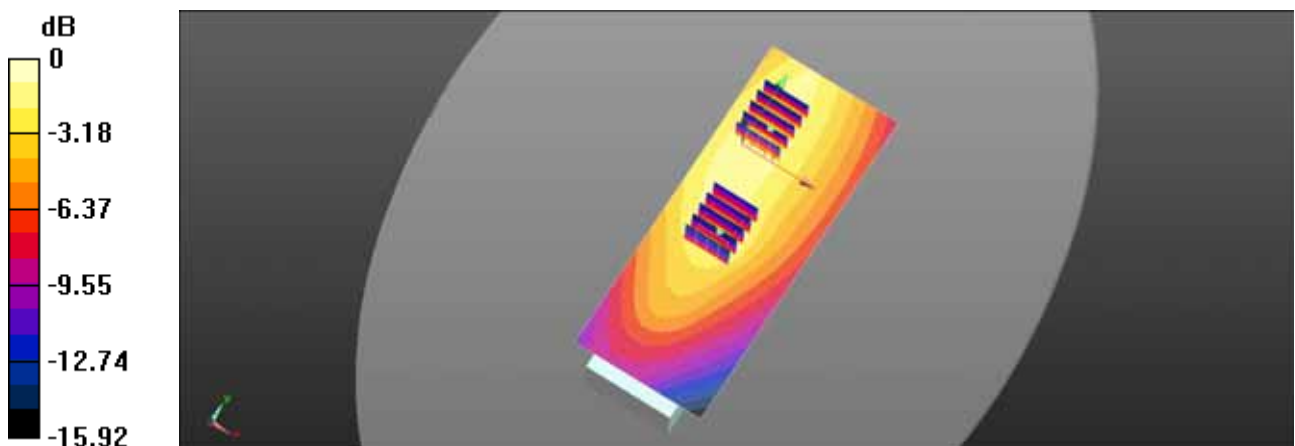

0 dB = 6.04 W/kg = 7.81 dBW/kg

Test Laboratory: HCT CO., LTD
 EUT Type: VHF P25 TRANSCEIVER WITH BLUETOOTH
 Liquid Temperature: 20.8
 Ambient Temperature: 21.0
 Test Date: Oct. 26, 2014
 Plot No.: 9

DUT: NX-5200-K2; Type: bar

Communication System: UID 0, 150MHz FCC (0); Frequency: 150.05 MHz;Duty Cycle: 1:1
 Medium parameters used (interpolated): $f = 150.05 \text{ MHz}$; $\sigma = 0.807 \text{ S/m}$; $\epsilon_r = 64.169$; $\rho = 1000 \text{ kg/m}^3$
 Phantom section: Flat Section
 Measurement Standard: DASY5 (IEEE/IEC/ANSI C63.19-2007)

DASY4 Configuration:

- Probe: ET3DV6 - SN1605; ConvF(7.44, 7.44, 7.44); Calibrated: 2014-01-31;
- Sensor-Surface: 4mm (Mechanical Surface Detection)
- Electronics: DAE4 Sn1417; Calibrated: 2014-01-03
- Phantom: ELI v4.0; Type: QDOVA001BB; Serial: TP:xxxx
- ; SEMCAD X Version 14.6.10 (7331)

NX-5200-K2/Body rear 1ch KNB-L1_26M_CLIP/Area Scan (61x151x1): Interpolated grid: $dx=1.500 \text{ mm}$, $dy=1.500 \text{ mm}$
 Maximum value of SAR (interpolated) = 7.45 W/kg

NX-5200-K2/Body rear 1ch KNB-L1_26M_CLIP/Zoom Scan (5x5x7)/Cube 0: Measurement grid: $dx=8\text{mm}$, $dy=8\text{mm}$, $dz=5\text{mm}$
 Reference Value = 86.39 V/m; Power Drift = -0.05 dB
 Peak SAR (extrapolated) = 22.7 W/kg
SAR(1 g) = 7.2 W/kg; SAR(10 g) = 3.87 W/kg
 Maximum value of SAR (measured) = 7.65 W/kg

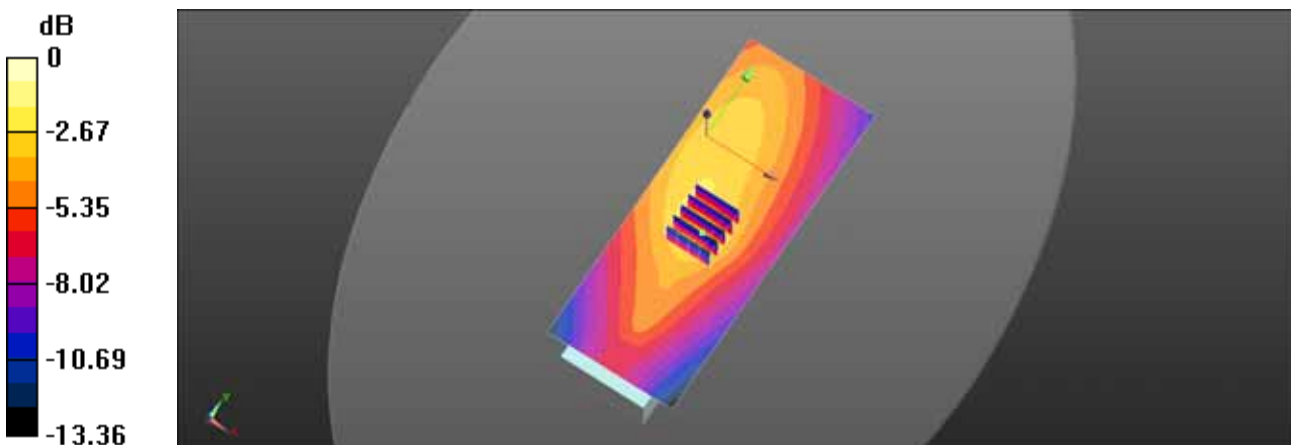

$0 \text{ dB} = 7.45 \text{ W/kg} = 8.72 \text{ dBW/kg}$

Test Laboratory: HCT CO., LTD
 EUT Type: VHF P25 TRANSCEIVER WITH BLUETOOTH
 Liquid Temperature: 20.8
 Ambient Temperature: 21.0
 Test Date: Oct. 26, 2014
 Plot No.: 10

DUT: KMC-49; Type: bar

Communication System: UID 0, 150MHz (0); Frequency: 150.05 MHz;Duty Cycle: 1:1
 Medium parameters used (interpolated): $f = 150.05$ MHz; $\sigma = 0.807$ S/m; $\epsilon_r = 64.169$; $\rho = 1000$ kg/m³
 Phantom section: Flat Section
 Measurement Standard: DASYS5 (IEEE/IEC/ANSI C63.19-2007)

DASY4 Configuration:

- Probe: ET3DV6 - SN1605; ConvF(7.44, 7.44, 7.44); Calibrated: 2014-01-31;
- Sensor-Surface: 4mm (Mechanical Surface Detection)
- Electronics: DAE4 Sn1417; Calibrated: 2014-01-03
- Phantom: ELI v4.0; Type: QDOVA001BB; Serial: TP:xxxx
- ; SEMCAD X Version 14.6.10 (7331)

NX-5200-K3/Body rear 1ch KNB-L1_26M_KMC-49/Area Scan (61x161x1): Interpolated grid: dx=1.500 mm, dy=1.500 mm

Maximum value of SAR (interpolated) = 4.06 W/kg

NX-5200-K3/Body rear 1ch KNB-L1_26M_KMC-49/Zoom Scan (5x5x7)/Cube 0: Measurement grid: dx=8mm, dy=8mm, dz=5mm

Reference Value = 58.51 V/m; Power Drift = -0.24 dB

Peak SAR (extrapolated) = 9.58 W/kg

SAR(1 g) = 3.93 W/kg; SAR(10 g) = 2.51 W/kg

Maximum value of SAR (measured) = 3.97 W/kg

NX-5200-K3/Body rear 1ch KNB-L1_26M_KMC-49/Zoom Scan (5x5x7)/Cube 1: Measurement grid: dx=8mm, dy=8mm, dz=5mm

Reference Value = 58.51 V/m; Power Drift = -0.24 dB

Peak SAR (extrapolated) = 8.32 W/kg

SAR(1 g) = 3.89 W/kg; SAR(10 g) = 2.63 W/kg

Maximum value of SAR (measured) = 3.94 W/kg

NX-5200-K3/Body rear 1ch KNB-L1_26M_KMC-49/Zoom Scan (5x5x7)/Cube 2: Measurement grid: dx=8mm, dy=8mm, dz=5mm

Reference Value = 58.51 V/m; Power Drift = -0.24 dB

Peak SAR (extrapolated) = 15.4 W/kg

SAR(1 g) = 4.09 W/kg; SAR(10 g) = 2.06 W/kg

Maximum value of SAR (measured) = 3.92 W/kg

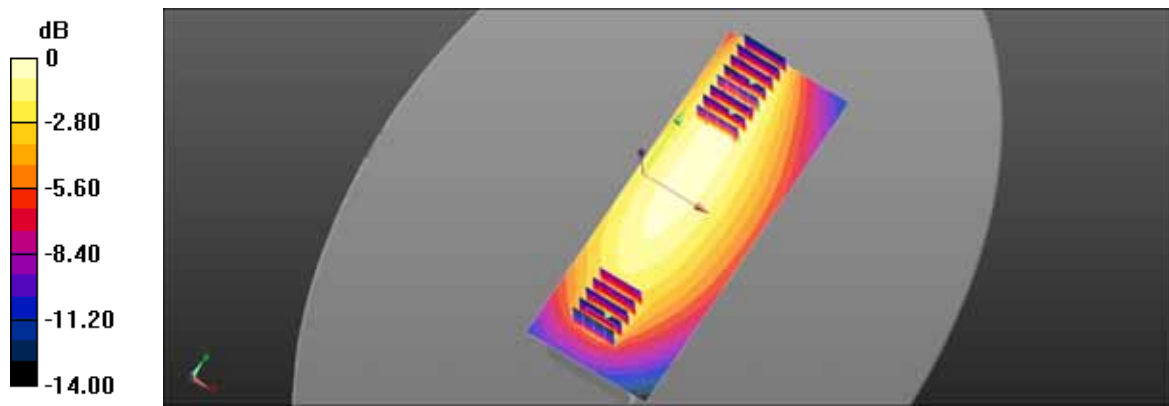

0 dB = 4.06 W/kg = 6.08 dBW/kg

Test Laboratory: HCT CO., LTD

EUT Type: VHF P25 TRANSCEIVER WITH BLUETOOTH
 Liquid Temperature: 20.3
 Ambient Temperature: 20.5
 Test Date: Oct. 24, 2014
 Plot No.: 11

DUT: NX-5200-K3; Type: bar

Communication System: UID 0, 150MHz FCC (0); Frequency: 150.05 MHz; Duty Cycle: 1:1
 Medium parameters used (interpolated): $f = 150.05$ MHz; $\sigma = 0.805$ S/m; $\epsilon_r = 64.104$; $\rho = 1000$ kg/m³
 Phantom section: Flat Section
 Measurement Standard: DASy5 (IEEE/IEC/ANSI C63.19-2007)

DASy4 Configuration:

- Probe: ET3DV6 - SN1605; ConvF(7.44, 7.44, 7.44); Calibrated: 2014-01-31;
- Sensor-Surface: 4mm (Mechanical Surface Detection)
- Electronics: DAE4 Sn1417; Calibrated: 2014-01-03
- Phantom: ELI v4.0; Type: QDOVA001BB; Serial: TP:xxxx
- ; SEMCAD X Version 14.6.10 (7331)

NX-5200-K3/Body rear 1ch KNB-L1_26M_Nyron/Area Scan (61x151x1): Interpolated grid: dx=1.500 mm, dy=1.500 mm
 Maximum value of SAR (interpolated) = 4.38 W/kg

NX-5200-K3/Body rear 1ch KNB-L1_26M_Nyron/Zoom Scan (5x5x7)/Cube 0: Measurement grid: dx=8mm, dy=8mm, dz=5mm
 Reference Value = 65.83 V/m; Power Drift = - 0.26 dB
 Peak SAR (extrapolated) = 6.20 W/kg
SAR(1 g) = 4.21 W/kg; SAR(10 g) = 3.2 W/kg
 Maximum value of SAR (measured) = 4.35 W/kg

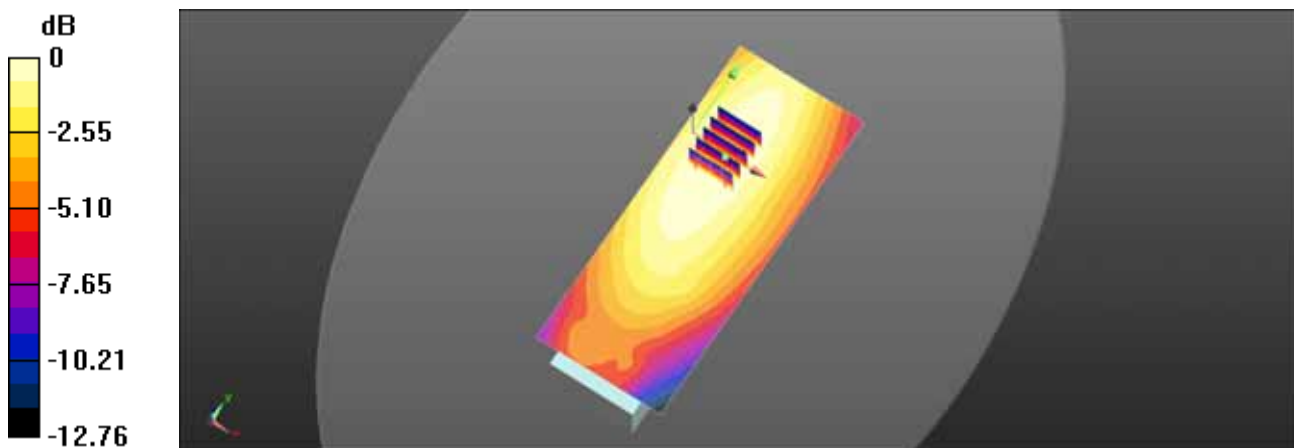

0 dB = 4.38 W/kg = 6.41 dBW/kg

Test Laboratory: HCT CO., LTD
 EUT Type: VHF P25 TRANSCEIVER WITH BLUETOOTH
 Liquid Temperature: 20.3
 Ambient Temperature: 20.5
 Test Date: Oct. 24, 2014
 Plot No.: 12

DUT: NX-5200-K2; Type: bar

Communication System: UID 0, 150MHz FCC (0); Frequency: 150.05 MHz;Duty Cycle: 1:1
 Medium parameters used (interpolated): $f = 150.05 \text{ MHz}$; $\sigma = 0.805 \text{ S/m}$; $\epsilon_r = 64.104$; $\rho = 1000 \text{ kg/m}^3$
 Phantom section: Flat Section
 Measurement Standard: DASY5 (IEEE/IEC/ANSI C63.19-2007)

DASY4 Configuration:

- Probe: ET3DV6 - SN1605; ConvF(7.44, 7.44, 7.44); Calibrated: 2014-01-31;
- Sensor-Surface: 4mm (Mechanical Surface Detection)
- Electronics: DAE4 Sn1417; Calibrated: 2014-01-03
- Phantom: ELI v4.0; Type: QDOVA001BB; Serial: TP:xxxx
- ; SEMCAD X Version 14.6.10 (7331)

NX-5200-K2/Body rear 1ch KNB-L1_26M_Nyron/Area Scan (61x151x1): Interpolated grid: $dx=1.500 \text{ mm}$, $dy=1.500 \text{ mm}$
 Maximum value of SAR (interpolated) = 4.16 W/kg

NX-5200-K2/Body rear 1ch KNB-L1_26M_Nyron/Zoom Scan (5x5x7)/Cube 0: Measurement grid: $dx=8\text{mm}$, $dy=8\text{mm}$, $dz=5\text{mm}$
 Reference Value = 63.19 V/m; Power Drift = -0.12 dB
 Peak SAR (extrapolated) = 5.77 W/kg
SAR(1 g) = 3.98 W/kg; SAR(10 g) = 3.05 W/kg
 Maximum value of SAR (measured) = 4.11 W/kg

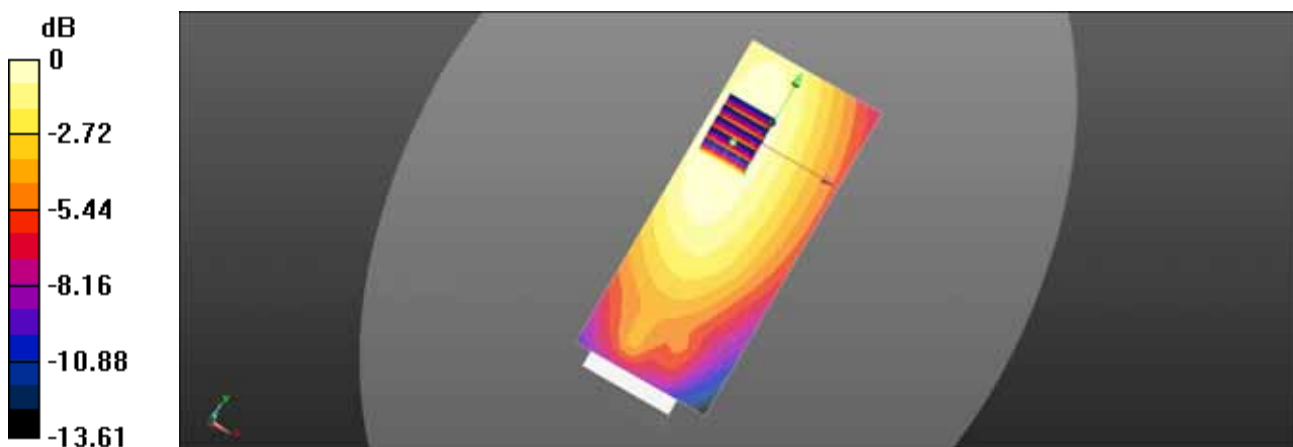

0 dB = 4.16 W/kg = 6.19 dBW/kg

Test Laboratory: HCT CO., LTD
EUT Type: VHF P25 TRANSCEIVER WITH BLUETOOTH
Liquid Temperature: 20.6
Ambient Temperature: 20.8
Test Date: Oct. 25, 2014
Plot No.: 13

DUT: NX-5200-K3; Type: bar

Communication System: UID 0, 150MHz FCC (0); Frequency: 150.05 MHz; Duty Cycle: 1:1
Medium parameters used (interpolated): $f = 150.05$ MHz; $\sigma = 0.807$ S/m; $\epsilon_r = 64.273$; $\rho = 1000$ kg/m³
Phantom section: Flat Section
Measurement Standard: DASY5 (IEEE/IEC/ANSI C63.19-2007)

DASY4 Configuration:

- Probe: ET3DV6 - SN1605; ConvF(7.44, 7.44, 7.44); Calibrated: 2014-01-31;
- Sensor-Surface: 4mm (Mechanical Surface Detection)
- Electronics: DAE4 Sn1417; Calibrated: 2014-01-03
- Phantom: ELI v4.0; Type: QDOVA001BB; Serial: TP:xxxx
- ; SEMCAD X Version 14.6.10 (7331)

NX-5200-K3/Body rear 1ch KNB-L1_26M_D-RING/Area Scan (61x151x1): Interpolated grid: dx=1.500 mm, dy=1.500 mm
Maximum value of SAR (interpolated) = 1.85 W/kg

NX-5200-K3/Body rear 1ch KNB-L1_26M_D-RING/Zoom Scan (5x5x7)/Cube 0: Measurement grid: dx=8mm, dy=8mm, dz=5mm
Reference Value = 42.96 V/m; Power Drift = -0.08 dB
Peak SAR (extrapolated) = 2.51 W/kg
SAR(1 g) = 1.79 W/kg; SAR(10 g) = 1.41 W/kg
Maximum value of SAR (measured) = 1.84 W/kg

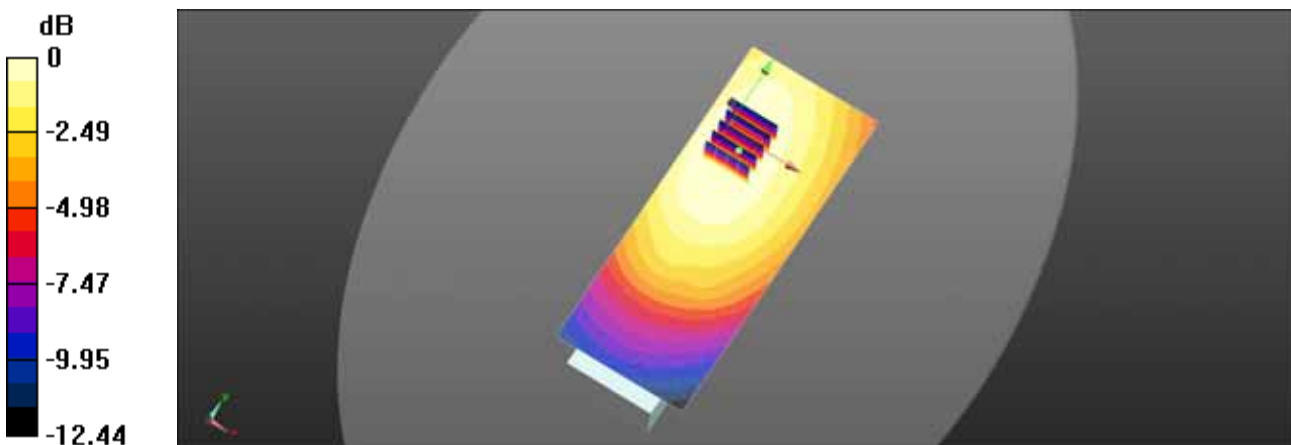

0 dB = 1.85 W/kg = 2.68 dBW/kg

Test Laboratory: HCT CO., LTD
 EUT Type: VHF P25 TRANSCEIVER WITH BLUETOOTH
 Liquid Temperature: 20.6
 Ambient Temperature: 20.8
 Test Date: Oct. 25, 2014
 Plot No.: 14

DUT: NX-5200-K2; Type: bar

Communication System: UID 0, 150MHz FCC (0); Frequency: 150.05 MHz;Duty Cycle: 1:1
 Medium parameters used (interpolated): $f = 150.05 \text{ MHz}$; $\sigma = 0.807 \text{ S/m}$; $\epsilon_r = 64.273$; $\rho = 1000 \text{ kg/m}^3$
 Phantom section: Flat Section
 Measurement Standard: DASY5 (IEEE/IEC/ANSI C63.19-2007)

DASY4 Configuration:

- Probe: ET3DV6 - SN1605; ConvF(7.44, 7.44, 7.44); Calibrated: 2014-01-31;
- Sensor-Surface: 4mm (Mechanical Surface Detection)
- Electronics: DAE4 Sn1417; Calibrated: 2014-01-03
- Phantom: ELI v4.0; Type: QDOVA001BB; Serial: TP:xxxx
- ; SEMCAD X Version 14.6.10 (7331)

NX-5200-K2/Body rear 1ch KNB-L1_26M_D-RING/Area Scan (61x151x1): Interpolated grid: $dx=1.500 \text{ mm}$, $dy=1.500 \text{ mm}$
 Maximum value of SAR (interpolated) = 1.67 W/kg

NX-5200-K2/Body rear 1ch KNB-L1_26M_D-RING/Zoom Scan (5x5x7)/Cube 0: Measurement grid: $dx=8\text{mm}$, $dy=8\text{mm}$, $dz=5\text{mm}$
 Reference Value = 41.33 V/m; Power Drift = -0.10 dB
 Peak SAR (extrapolated) = 2.44 W/kg
SAR(1 g) = 1.74 W/kg; SAR(10 g) = 1.37 W/kg
 Maximum value of SAR (measured) = 1.79 W/kg

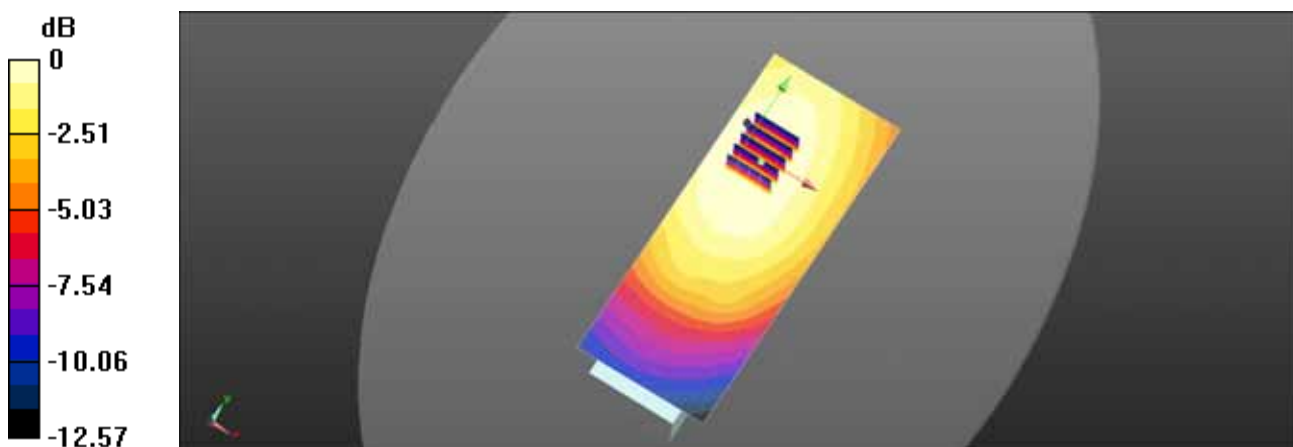

0 dB = 1.67 W/kg = 2.23 dBW/kg

Attachment 2. – Verification Plots

■ Verification Data (150 MHz Head)

Test Laboratory: HCT CO., LTD
 Input Power 100 mW (20 dBm)
 Liquid Temp: 20.3
 Test Date: Oct. 24, 2014

DUT: CLA-150; Type: CLA-150; Serial: 4014

Communication System: UID 0, CW (0); Frequency: 150 MHz; Duty Cycle: 1:1
 Medium parameters used: $f = 150 \text{ MHz}$; $\sigma = 0.746 \text{ S/m}$; $\epsilon_r = 51.889$; $\rho = 1000 \text{ kg/m}^3$
 Phantom section: Flat Section
 Measurement Standard: DASY5 (IEEE/IEC/ANSI C63.19-2007)

DASY4 Configuration:

- Probe: ET3DV6 - SN1605; ConvF(8.22, 8.22, 8.22); Calibrated: 2014-01-31;
- Sensor-Surface: 4mm (Mechanical Surface Detection)
- Electronics: DAE4 Sn1417; Calibrated: 2014-01-03
- Phantom: ELI v4.0; Type: QDOVA001BB; Serial: TP:xxxx
- ; SEMCAD X Version 14.6.10 (7331)

150Mhz SAR Verification/150MHz Verification/Area Scan (81x81x1): Interpolated grid: $dx=1.500 \text{ mm}$, $dy=1.500 \text{ mm}$
 Maximum value of SAR (interpolated) = 0.384 W/kg

150Mhz SAR Verification/150MHz Verification/Zoom Scan (5x5x7)/Cube 0: Measurement grid: $dx=8\text{mm}$, $dy=8\text{mm}$, $dz=5\text{mm}$
 Reference Value = 21.83 V/m; Power Drift = 0.04 dB
 Peak SAR (extrapolated) = 0.652 W/kg
SAR(1 g) = 0.361 W/kg; SAR(10 g) = 0.228 W/kg
 Maximum value of SAR (measured) = 0.381 W/kg

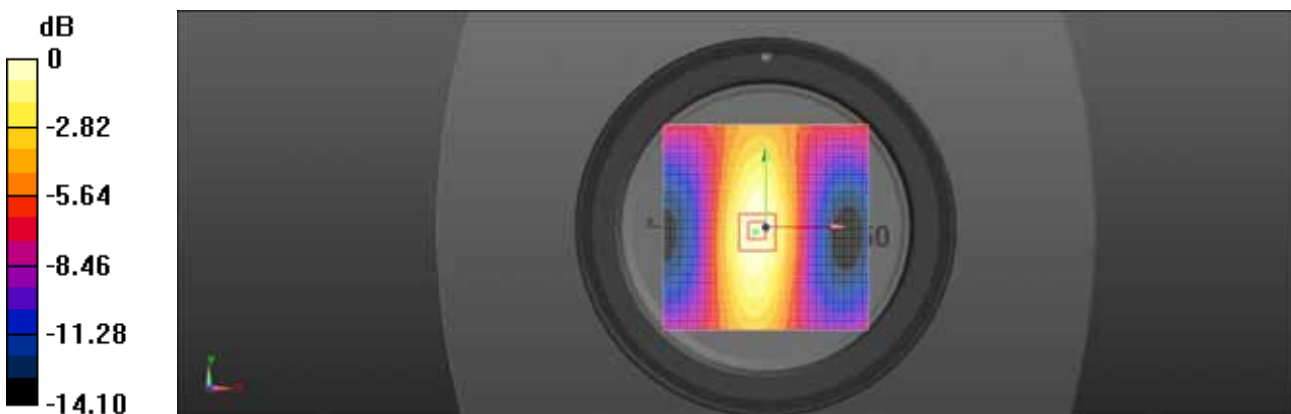

$0 \text{ dB} = 0.384 \text{ W/kg} = -4.16 \text{ dBW/kg}$

■ Verification Data (150 MHz Body)

Test Laboratory: HCT CO., LTD
 Input Power 100 mW (20 dBm)
 Liquid Temp: 20.3
 Test Date: Oct. 24, 2014

DUT: CLA-150; Type: CLA-150; Serial: 4014

Communication System: UID 0, CW (0); Frequency: 150 MHz; Duty Cycle: 1:1
 Medium parameters used: $f = 150 \text{ MHz}$; $\sigma = 0.805 \text{ S/m}$; $\epsilon_r = 64.108$; $\rho = 1000 \text{ kg/m}^3$
 Phantom section: Flat Section
 Measurement Standard: DASY5 (IEEE/IEC/ANSI C63.19-2007)

DASY4 Configuration:

- Probe: ET3DV6 - SN1605; ConvF(7.44, 7.44, 7.44); Calibrated: 2014-01-31;
- Sensor-Surface: 4mm (Mechanical Surface Detection)
- Electronics: DAE4 Sn1417; Calibrated: 2014-01-03
- Phantom: ELI v4.0; Type: QDOVA001BB; Serial: TP:xxxx
- ; SEMCAD X Version 14.6.10 (7331)

150Mhz SAR Verification/150MHz Verification/Area Scan (81x81x1): Interpolated grid: $dx=1.500 \text{ mm}$, $dy=1.500 \text{ mm}$
 Maximum value of SAR (interpolated) = 0.422 W/kg

150Mhz SAR Verification/150MHz Verification/Zoom Scan (5x5x7)/Cube 0: Measurement grid: $dx=8\text{mm}$, $dy=8\text{mm}$, $dz=5\text{mm}$
 Reference Value = 22.76 V/m; Power Drift = 0.02 dB
 Peak SAR (extrapolated) = 0.704 W/kg
SAR(1 g) = 0.398 W/kg; SAR(10 g) = 0.255 W/kg
 Maximum value of SAR (measured) = 0.423 W/kg

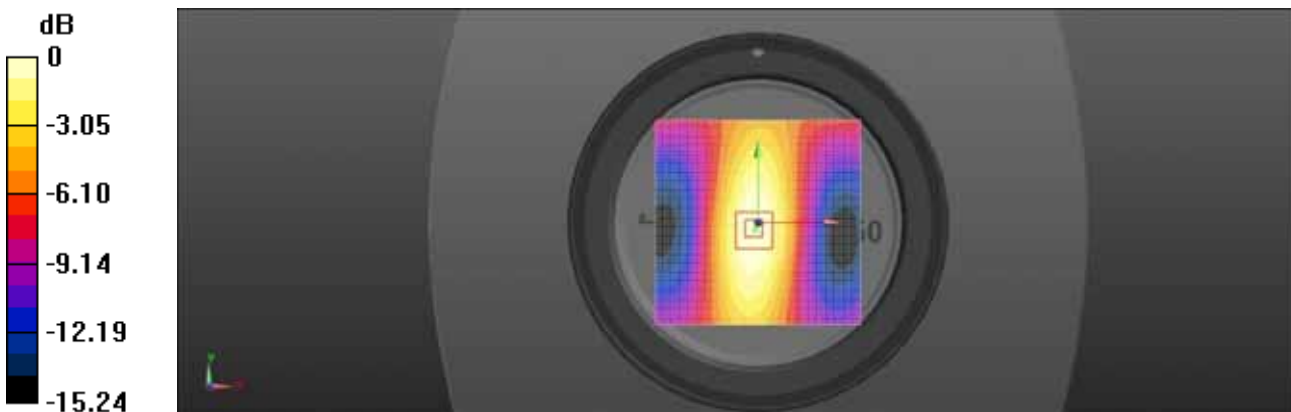

$0 \text{ dB} = 0.422 \text{ W/kg} = -3.75 \text{ dBW/kg}$

■ Verification Data (150 MHz Body)

Test Laboratory: HCT CO., LTD
 Input Power 100 mW (20 dBm)
 Liquid Temp: 20.6
 Test Date: Oct. 25, 2014

DUT: CLA-150; Type: CLA-150; Serial: 4014

Communication System: UID 0, CW (0); Frequency: 150 MHz; Duty Cycle: 1:1
 Medium parameters used: $f = 150 \text{ MHz}$; $\sigma = 0.807 \text{ S/m}$; $\epsilon_r = 64.276$; $\rho = 1000 \text{ kg/m}^3$
 Phantom section: Flat Section
 Measurement Standard: DASy5 (IEEE/IEC/ANSI C63.19-2007)

DASy4 Configuration:

- Probe: ET3DV6 - SN1605; ConvF(7.44, 7.44, 7.44); Calibrated: 2014-01-31;
- Sensor-Surface: 4mm (Mechanical Surface Detection)
- Electronics: DAE4 Sn1417; Calibrated: 2014-01-03
- Phantom: ELI v4.0; Type: QDOVA001BB; Serial: TP:xxxx
- ; SEMCAD X Version 14.6.10 (7331)

150MHz SAR Verification/150MHz Verification/Area Scan (81x81x1): Interpolated grid: $dx=1.500 \text{ mm}$, $dy=1.500 \text{ mm}$
 Maximum value of SAR (interpolated) = 0.418 W/kg

150MHz SAR Verification/150MHz Verification/Zoom Scan (5x5x7)/Cube 0: Measurement grid: $dx=8\text{mm}$, $dy=8\text{mm}$, $dz=5\text{mm}$
 Reference Value = 22.52 V/m; Power Drift = 0.02 dB
 Peak SAR (extrapolated) = 0.702 W/kg
SAR(1 g) = 0.394 W/kg; SAR(10 g) = 0.251 W/kg
 Maximum value of SAR (measured) = 0.418 W/kg

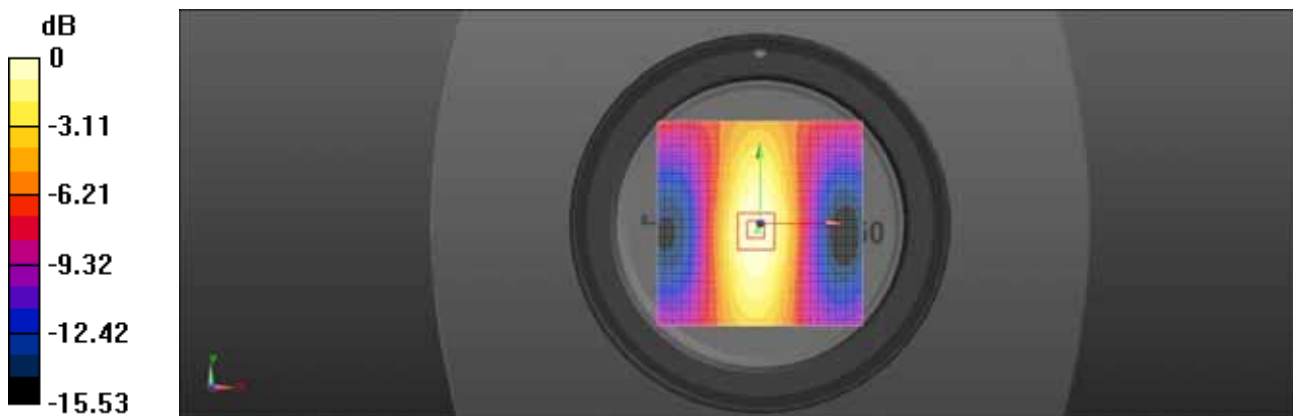

$$0 \text{ dB} = 0.418 \text{ W/kg} = -3.79 \text{ dBW/kg}$$

■ Verification Data (150 MHz Body)

Test Laboratory: HCT CO., LTD
 Input Power 100 mW (20 dBm)
 Liquid Temp: 20.8
 Test Date: Oct. 26, 2014

DUT: CLA-150; Type: CLA-150; Serial: 4014

Communication System: UID 0, CW (0); Frequency: 150 MHz; Duty Cycle: 1:1
 Medium parameters used: $f = 150 \text{ MHz}$; $\sigma = 0.807 \text{ S/m}$; $\epsilon_r = 64.171$; $\rho = 1000 \text{ kg/m}^3$
 Phantom section: Flat Section
 Measurement Standard: DASy5 (IEEE/IEC/ANSI C63.19-2007)

DASy4 Configuration:

- Probe: ET3DV6 - SN1605; ConvF(7.44, 7.44, 7.44); Calibrated: 2014-01-31;
- Sensor-Surface: 4mm (Mechanical Surface Detection)
- Electronics: DAE4 Sn1417; Calibrated: 2014-01-03
- Phantom: ELI v4.0; Type: QDOVA001BB; Serial: TP:xxxx
- ; SEMCAD X Version 14.6.10 (7331)

150MHz SAR Verification/150MHz Verification/Area Scan (81x81x1): Interpolated grid: $dx=1.500 \text{ mm}$, $dy=1.500 \text{ mm}$
 Maximum value of SAR (interpolated) = 0.418 W/kg

150MHz SAR Verification/150MHz Verification/Zoom Scan (5x5x7)/Cube 0: Measurement grid: $dx=8\text{mm}$, $dy=8\text{mm}$, $dz=5\text{mm}$
 Reference Value = 22.58 V/m; Power Drift = 0.04 dB
 Peak SAR (extrapolated) = 0.693 W/kg
SAR(1 g) = 0.393 W/kg; SAR(10 g) = 0.251 W/kg
 Maximum value of SAR (measured) = 0.416 W/kg

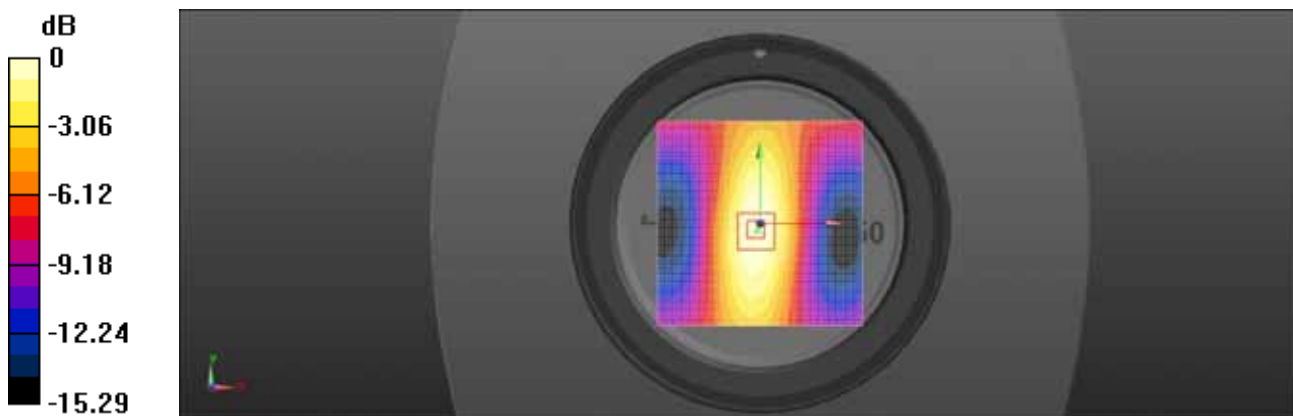

$0 \text{ dB} = 0.418 \text{ W/kg} = -3.79 \text{ dBW/kg}$

Attachment 3. – Probe Calibration Data

**Calibration Laboratory of
Schmid & Partner
Engineering AG**
Zeughausstrasse 43, 8004 Zurich, Switzerland



S Schweizerischer Kalibrierdienst
S Service suisse d'étalonnage
S Servizio svizzero di taratura
S Swiss Calibration Service

Accredited by the Swiss Accreditation Service (SAS)
The Swiss Accreditation Service is one of the signatories to the EA
Multilateral Agreement for the recognition of calibration certificates

Accreditation No.: **SCS 108**

Client **HCT (Dymstec)**

Certificate No: **ET3-1605_Jan14/2**

CALIBRATION CERTIFICATE (Replacement of No: ET3-1605_Jan14)

Object **ET3DV6 - SN:1605**

Calibration procedure(s) **QA CAL-01.v9, QA CAL-12.v9, QA CAL-23.v5, QA CAL-25.v6
Calibration procedure for dosimetric E-field probes**

Calibration date: **January 31, 2014**

This calibration certificate documents the traceability to national standards, which realize the physical units of measurements (SI).
The measurements and the uncertainties with confidence probability are given on the following pages and are part of the certificate.

All calibrations have been conducted in the closed laboratory facility: environment temperature (22 ± 3)°C and humidity < 70%.

Calibration Equipment used (M&TE critical for calibration)

Primary Standards	ID	Cal Date (Certificate No.)	Scheduled Calibration
Power meter E4419B	GB41293874	04-Apr-13 (No. 217-01733)	Apr-14
Power sensor E4412A	MY41496087	04-Apr-13 (No. 217-01733)	Apr-14
Reference 3 dB Attenuator	SN: S5054 (3c)	04-Apr-13 (No. 217-01737)	Apr-14
Reference 20 dB Attenuator	SN: S5277 (20x)	04-Apr-13 (No. 217-01735)	Apr-14
Reference 30 dB Attenuator	SN: S5129 (30b)	04-Apr-13 (No. 217-01738)	Apr-14
Reference Probe ES3DV2	SN: 3013	30-Dec-13 (No. ES3-3013_Dec13)	Dec-14
DAE4	SN: 660	13-Dec-13 (No. DAE4-660_Dec13)	Dec-14
Secondary Standards	ID	Check Date (in house)	Scheduled Check
RF generator HP 8648C	US3642U01700	4-Aug-99 (in house check Apr-13)	In house check: Apr-16
Network Analyzer HP 8753E	US37390565	18-Oct-01 (in house check Oct-13)	In house check: Oct-14

Calibrated by:	Name Jeton Kastrati	Function Laboratory Technician	Signature
Approved by:	Name Katja Pokovic	Function Technical Manager	Signature

Issued: January 31, 2014

This calibration certificate shall not be reproduced except in full without written approval of the laboratory.

**Calibration Laboratory of
Schmid & Partner
Engineering AG**
Zeughausstrasse 43, 8004 Zurich, Switzerland



S Schweizerischer Kalibrierdienst
C Service suisse d'étalonnage
S Servizio svizzero di taratura
S Swiss Calibration Service

Accredited by the Swiss Accreditation Service (SAS)
The Swiss Accreditation Service is one of the signatories to the EA
Multilateral Agreement for the recognition of calibration certificates

Accreditation No.: **SCS 108**

Glossary:

TSL	tissue simulating liquid
NORM _{x,y,z}	sensitivity in free space
ConvF	sensitivity in TSL / NORM _{x,y,z}
DCP	diode compression point
CF	crest factor (1/duty_cycle) of the RF signal
A, B, C, D	modulation dependent linearization parameters
Polarization φ	φ rotation around probe axis
Polarization θ	θ rotation around an axis that is in the plane normal to probe axis (at measurement center), i.e., $\theta = 0$ is normal to probe axis
Connector Angle	information used in DASY system to align probe sensor X to the robot coordinate system

Calibration is Performed According to the Following Standards:

- a) IEEE Std 1528-2013, "IEEE Recommended Practice for Determining the Peak Spatial-Averaged Specific Absorption Rate (SAR) in the Human Head from Wireless Communications Devices: Measurement Techniques", June 2013
- b) IEC 62209-1, "Procedure to measure the Specific Absorption Rate (SAR) for hand-held devices used in close proximity to the ear (frequency range of 300 MHz to 3 GHz)", February 2005

Methods Applied and Interpretation of Parameters:

- **NORM_{x,y,z}:** Assessed for E-field polarization $\theta = 0$ ($f \leq 900$ MHz in TEM-cell; $f > 1800$ MHz: R22 waveguide). NORM_{x,y,z} are only intermediate values, i.e., the uncertainties of NORM_{x,y,z} does not affect the E²-field uncertainty inside TSL (see below ConvF).
- **NORM(f)_{x,y,z} = NORM_{x,y,z} * frequency_response** (see Frequency Response Chart). This linearization is implemented in DASY4 software versions later than 4.2. The uncertainty of the frequency response is included in the stated uncertainty of ConvF.
- **DCP_{x,y,z}:** DCP are numerical linearization parameters assessed based on the data of power sweep with CW signal (no uncertainty required). DCP does not depend on frequency nor media.
- **PAR:** PAR is the Peak to Average Ratio that is not calibrated but determined based on the signal characteristics
- **A_{x,y,z}; B_{x,y,z}; C_{x,y,z}; D_{x,y,z}; VR_{x,y,z}:** A, B, C, D are numerical linearization parameters assessed based on the data of power sweep for specific modulation signal. The parameters do not depend on frequency nor media. VR is the maximum calibration range expressed in RMS voltage across the diode.
- **ConvF and Boundary Effect Parameters:** Assessed in flat phantom using E-field (or Temperature Transfer Standard for $f \leq 800$ MHz) and inside waveguide using analytical field distributions based on power measurements for $f > 800$ MHz. The same setups are used for assessment of the parameters applied for boundary compensation (alpha, depth) of which typical uncertainty values are given. These parameters are used in DASY4 software to improve probe accuracy close to the boundary. The sensitivity in TSL corresponds to NORM_{x,y,z} * ConvF whereby the uncertainty corresponds to that given for ConvF. A frequency dependent ConvF is used in DASY version 4.4 and higher which allows extending the validity from ± 50 MHz to ± 100 MHz.
- **Spherical isotropy (3D deviation from isotropy):** in a field of low gradients realized using a flat phantom exposed by a patch antenna.
- **Sensor Offset:** The sensor offset corresponds to the offset of virtual measurement center from the probe tip (on probe axis). No tolerance required.
- **Connector Angle:** The angle is assessed using the information gained by determining the NORM_x (no uncertainty required).

ET3DV6 – SN:1605

January 31, 2014

Probe ET3DV6

SN:1605

Manufactured: July 27, 2001
Repaired: January 24, 2014
Calibrated: January 31, 2014

Calibrated for DASY/EASY Systems
(Note: non-compatible with DASY2 system!)

ET3DV6- SN:1605

January 31, 2014

DASY/EASY - Parameters of Probe: ET3DV6 - SN:1605

Basic Calibration Parameters

	Sensor X	Sensor Y	Sensor Z	Unc (k=2)
Norm ($\mu\text{V}/(\text{V}/\text{m})^2$) ^A	1.49	1.76	1.49	± 10.1 %
DCP (mV) ^B	97.1	97.1	98.1	

Modulation Calibration Parameters

UID	Communication System Name		A dB	B dB $\sqrt{\mu\text{V}}$	C	D dB	VR mV	Unc ^E (k=2)
0	CW	X	0.0	0.0	1.0	0.00	176.1	±3.5 %
		Y	0.0	0.0	1.0		186.9	
		Z	0.0	0.0	1.0		183.4	

The reported uncertainty of measurement is stated as the standard uncertainty of measurement multiplied by the coverage factor k=2, which for a normal distribution corresponds to a coverage probability of approximately 95%.

^A The uncertainties of NormX,Y,Z do not affect the E²-field uncertainty inside TSL (see Pages 5 and 6).

^B Numerical linearization parameter; uncertainty not required.

^E Uncertainty is determined using the max. deviation from linear response applying rectangular distribution and is expressed for the square of the field value.

ET3DV6- SN:1605

January 31, 2014

DASY/EASY - Parameters of Probe: ET3DV6 - SN:1605

Calibration Parameter Determined in Head Tissue Simulating Media

f (MHz) ^c	Relative Permittivity ^f	Conductivity (S/m) ^f	ConvF X	ConvF Y	ConvF Z	Alpha ^g	Depth ^g (mm)	Unct. (k=2)
150	52.3	0.76	8.22	8.22	8.22	0.10	1.35	± 13.3 %
300	45.3	0.87	8.06	8.06	8.06	0.23	2.40	± 13.3 %
450	43.5	0.87	7.34	7.34	7.34	0.26	2.82	± 13.3 %
750	41.9	0.89	6.88	6.88	6.88	0.31	3.00	± 12.0 %
835	41.5	0.90	6.57	6.57	6.57	0.33	3.00	± 12.0 %
900	41.5	0.97	6.37	6.37	6.37	0.31	3.00	± 12.0 %
1450	40.5	1.20	5.69	5.69	5.69	0.44	2.69	± 12.0 %
1750	40.1	1.37	5.43	5.43	5.43	0.78	2.13	± 12.0 %
1900	40.0	1.40	5.20	5.20	5.20	0.80	2.05	± 12.0 %
1950	40.0	1.40	5.05	5.05	5.05	0.80	2.18	± 12.0 %
2300	39.5	1.67	4.83	4.83	4.83	0.80	1.92	± 12.0 %
2450	39.2	1.80	4.55	4.55	4.55	0.80	1.72	± 12.0 %

^c Frequency validity of ± 100 MHz only applies for DASY v4.4 and higher (see Page 2), else it is restricted to ± 50 MHz. The uncertainty is the RSS of the ConvF uncertainty at calibration frequency and the uncertainty for the indicated frequency band.

^f At frequencies below 3 GHz, the validity of tissue parameters (ϵ and σ) can be relaxed to ± 10% if liquid compensation formula is applied to measured SAR values. At frequencies above 3 GHz, the validity of tissue parameters (ϵ and σ) is restricted to ± 5%. The uncertainty is the RSS of the ConvF uncertainty for indicated target tissue parameters.

^g Alpha/Depth are determined during calibration. SPEAG warrants that the remaining deviation due to the boundary effect after compensation is always less than ± 1% for frequencies below 3 GHz and below ± 2% for frequencies between 3-6 GHz at any distance larger than half the probe tip diameter from the boundary.

ET3DV6- SN:1605

January 31, 2014

DASY/EASY - Parameters of Probe: ET3DV6 - SN:1605

Calibration Parameter Determined in Body Tissue Simulating Media

f (MHz) ^C	Relative Permittivity ^F	Conductivity (S/m) ^F	ConvF X	ConvF Y	ConvF Z	Alpha ^G	Depth ^G (mm)	Unct. (k=2)
150	61.9	0.80	7.44	7.44	7.44	0.15	1.35	± 13.3 %
300	58.2	0.92	7.57	7.57	7.57	0.18	2.03	± 13.3 %
450	56.7	0.94	7.34	7.34	7.34	0.19	2.19	± 13.3 %
750	55.5	0.96	6.45	6.45	6.45	0.27	2.96	± 12.0 %
835	55.2	0.97	6.35	6.35	6.35	0.33	3.00	± 12.0 %
1750	53.4	1.49	4.81	4.81	4.81	0.80	2.59	± 12.0 %
1900	53.3	1.52	4.57	4.57	4.57	0.80	2.39	± 12.0 %
2450	52.7	1.95	3.97	3.97	3.97	0.57	1.04	± 12.0 %

^C Frequency validity of ± 100 MHz only applies for DASY v4.4 and higher (see Page 2), else it is restricted to ± 50 MHz. The uncertainty is the RSS of the ConvF uncertainty at calibration frequency and the uncertainty for the indicated frequency band.

^F At frequencies below 3 GHz, the validity of tissue parameters (ϵ and σ) can be relaxed to ± 10% if liquid compensation formula is applied to measured SAR values. At frequencies above 3 GHz, the validity of tissue parameters (ϵ and σ) is restricted to ± 5%. The uncertainty is the RSS of the ConvF uncertainty for indicated target tissue parameters.

^G Alpha/Depth are determined during calibration. SPEAG warrants that the remaining deviation due to the boundary effect after compensation is always less than ± 1% for frequencies below 3 GHz and below ± 2% for frequencies between 3-6 GHz at any distance larger than half the probe tip diameter from the boundary.

ET3DV6-SN:1605

January 31, 2014

Frequency Response of E-Field (TEM-Cell:ifi110 EXX, Waveguide: R22)

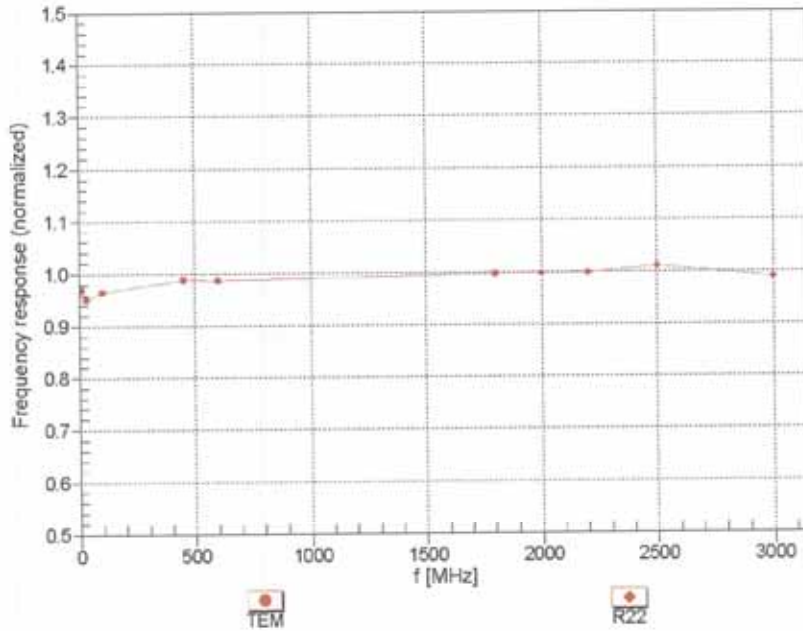

Uncertainty of Frequency Response of E-field: $\pm 6.3\%$ (k=2)

ET3DV6-SN:1605

January 31, 2014

Receiving Pattern (ϕ), $\theta = 0^\circ$

f=600 MHz, TEM

f=1800 MHz, R22

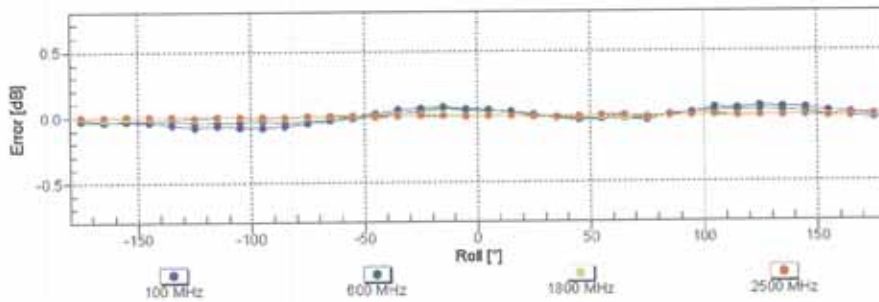
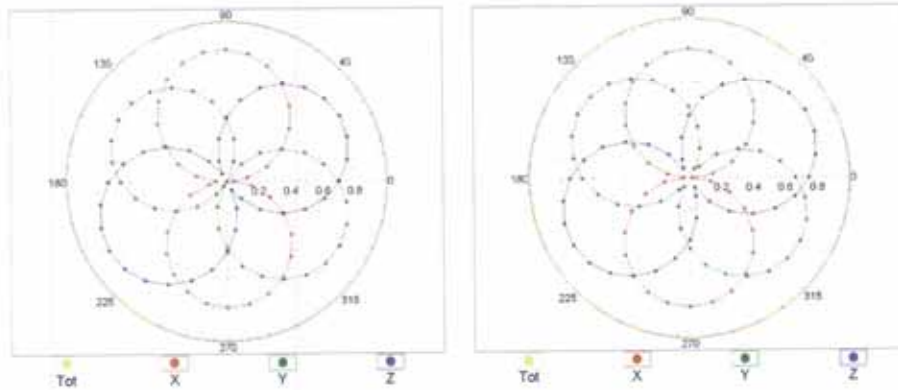

Uncertainty of Axial Isotropy Assessment: $\pm 0.5\%$ (k=2)

ET3DV6- SN:1605

January 31, 2014

Dynamic Range f(SAR_{head}) (TEM cell , f = 900 MHz)

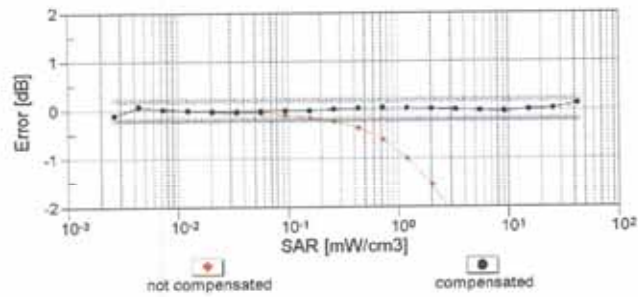
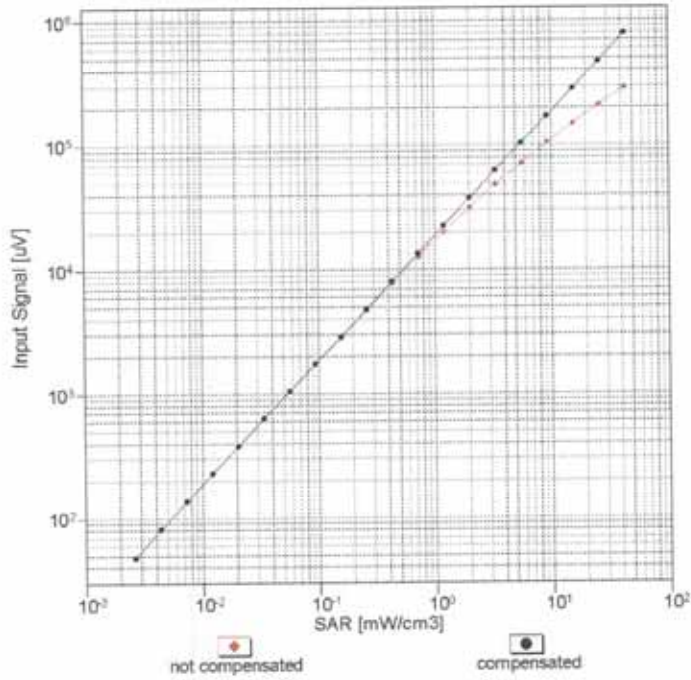

Uncertainty of Linearity Assessment: ± 0.6% (k=2)

ET3DV6- SN:1605

January 31, 2014

Conversion Factor Assessment

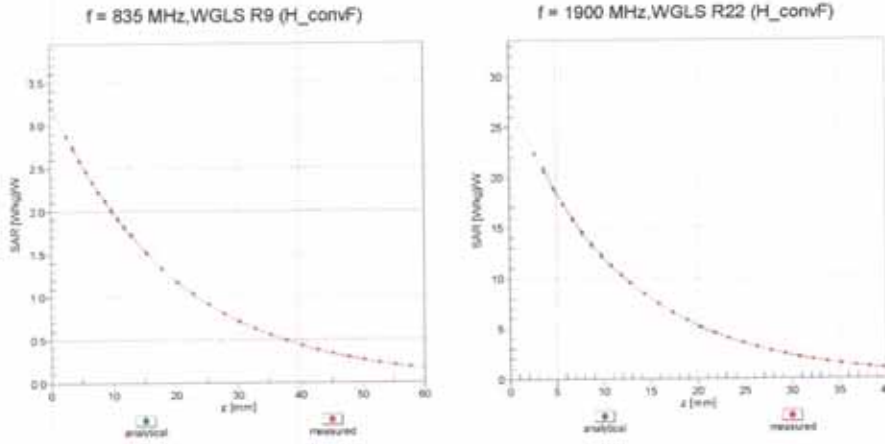

Deviation from Isotropy in Liquid Error (ϕ, θ), f = 900 MHz

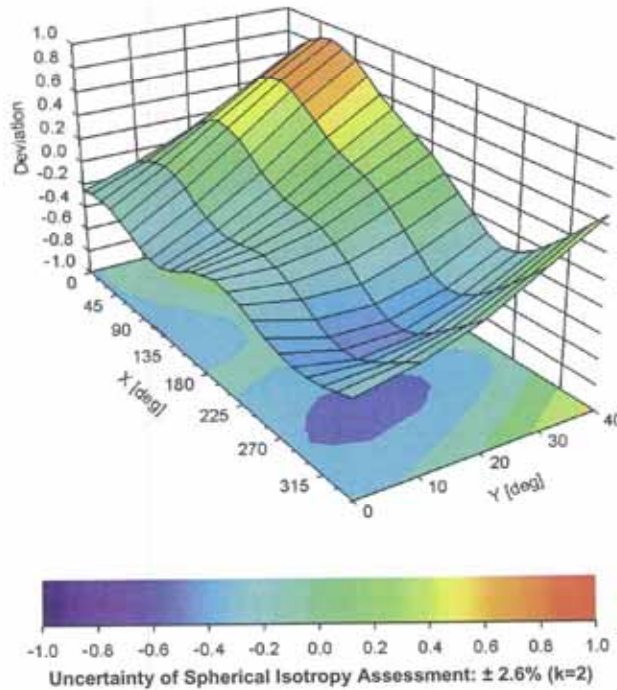

ET3DV6- SN:1605

January 31, 2014

DASY/EASY - Parameters of Probe: ET3DV6 - SN:1605

Other Probe Parameters

Sensor Arrangement	Triangular
Connector Angle (°)	-125
Mechanical Surface Detection Mode	enabled
Optical Surface Detection Mode	disabled
Probe Overall Length	337 mm
Probe Body Diameter	10 mm
Tip Length	10 mm
Tip Diameter	6.8 mm
Probe Tip to Sensor X Calibration Point	2.7 mm
Probe Tip to Sensor Y Calibration Point	2.7 mm
Probe Tip to Sensor Z Calibration Point	2.7 mm
Recommended Measurement Distance from Surface	4 mm

Attachment 4. – Dipole Calibration Data

**Calibration Laboratory of
Schmid & Partner
Engineering AG**
Zeughausstrasse 43, 8004 Zurich, Switzerland



S Schweizerischer Kalibrierdienst
S Service suisse d'étalonnage
C Servizio svizzero di taratura
S Swiss Calibration Service

Accredited by the Swiss Accreditation Service (SAS)
The Swiss Accreditation Service is one of the signatories to the EA
Multilateral Agreement for the recognition of calibration certificates

Accreditation No.: **SCS 108**

Client **HCT (Dymstec)**

Certificate No: **CLA150-4014_Sep14**

CALIBRATION CERTIFICATE

Object: **CLA150 - SN: 4014**

Calibration procedure(s): **QA CAL-15.v8
Calibration procedure for system validation sources below 700 MHz**

Calibration date: **September 04, 2014**

This calibration certificate documents the traceability to national standards, which realize the physical units of measurements (SI).
The measurements and the uncertainties with confidence probability are given on the following pages and are part of the certificate.

All calibrations have been conducted in the closed laboratory facility: environment temperature (22 ± 3)°C and humidity < 70%.

Calibration Equipment used (M&TE critical for calibration)

Primary Standards	ID #	Cal Date (Certificate No.)	Scheduled Calibration
Power meter E4419B	GB41293874	03-Apr-14 (No. 217-01911)	Apr-15
Power sensor E4412A	MY41498087	03-Apr-14 (No. 217-01911)	Apr-15
Reference 3 dB Attenuator	SN: S5054 (3c)	03-Apr-14 (No. 217-01915)	Apr-15
Reference 20 dB Attenuator	SN: S5058 (20k)	03-Apr-14 (No. 217-01918)	Apr-15
Type-N mismatch combination	SN: 5047.2 / 06327	03-Apr-14 (No. 217-01921)	Apr-15
Reference Probe EX3DV4	SN: 3877	06-Jan-14 (No. EX3-3877_Jan14)	Jan-15
DAE4	SN: 654	30-Jun-14 (No. DAE4-654_Jun14)	Jun-15
Secondary Standards	ID #	Check Date (in house)	Scheduled Check
RF generator HP 8648C	US3642U01700	04-Aug-99 (in house check Apr-13)	In house check: Apr-16
Network Analyzer HP 8753E	US37390585 S4206	18-Oct-01 (in house check Oct-13)	In house check: Oct-14

	Name	Function	Signature
Calibrated by:	Jeton Kastrioti	Laboratory Technician	
Approved by:	Katja Pokovic	Technical Manager	

Issued: September 11, 2014

This calibration certificate shall not be reproduced except in full without written approval of the laboratory.

**Calibration Laboratory of
Schmid & Partner
Engineering AG**
Zeughausstrasse 43, 8004 Zurich, Switzerland



S Schweizerischer Kalibrierdienst
C Service suisse d'étalonnage
S Servizio svizzero di taratura
S Swiss Calibration Service

Accredited by the Swiss Accreditation Service (SAS)

The Swiss Accreditation Service is one of the signatories to the EA
Multilateral Agreement for the recognition of calibration certificates

Accreditation No.: **SCS 108**

Glossary:

TSL	tissue simulating liquid
ConvF	sensitivity in TSL / NORM x,y,z
N/A	not applicable or not measured

Calibration is Performed According to the Following Standards:

- IEC 62209-2, "Procedure to measure the Specific Absorption Rate (SAR) for hand-held devices used in close proximity to the ear (frequency range of 300 MHz to 3 GHz)", February 2013
- KDB 865664, "SAR Measurement Requirements for 100 MHz to 6 GHz"

Additional Documentation:

- DASY4/5 System Handbook

Methods Applied and Interpretation of Parameters:

- Measurement Conditions:* Further details are available from the Validation Report at the end of the certificate. All figures stated in the certificate are valid at the frequency indicated.
- Antenna Parameters with TSL:* The source is mounted in a touch configuration below the center marking of the flat phantom.
- Return Loss:* This parameter is measured with the source positioned under the liquid filled phantom (as described in the measurement condition clause). The Return Loss ensures low reflected power. No uncertainty required.
- SAR measured:* SAR measured at the stated antenna input power.
- SAR normalized:* SAR as measured, normalized to an input power of 1 W at the antenna connector.
- SAR for nominal TSL parameters:* The measured TSL parameters are used to calculate the nominal SAR result.

The reported uncertainty of measurement is stated as the standard uncertainty of measurement multiplied by the coverage factor $k=2$, which for a normal distribution corresponds to a coverage probability of approximately 95%.

Measurement Conditions

DASY system configuration, as far as not given on page 1.

DASY Version	DASY5	V52.8.8
Extrapolation	Advanced Extrapolation	
Phantom	ELI4 Flat Phantom	Shell thickness: 2 ± 0.2 mm
EUT Positioning	Touch Position	
Zoom Scan Resolution	dx, dy = 4.0 mm, dz = 1.4 mm	
Frequency	150 MHz ± 1 MHz	

Head TSL parameters

The following parameters and calculations were applied.

	Temperature	Permittivity	Conductivity
Nominal Head TSL parameters	22.0 °C	52.3	0.76 mho/m
Measured Head TSL parameters	(22.0 ± 0.2) °C	51.5 ± 6 %	0.78 mho/m ± 6 %
Head TSL temperature change during test	< 0.5 °C	----	----

SAR result with Head TSL

SAR averaged over 1 cm ³ (1 g) of Head TSL	Condition	
SAR measured	1 W input power	3.77 W/kg
SAR for nominal Head TSL parameters	normalized to 1W	3.72 W/kg ± 18.4 % (k=2)
SAR averaged over 10 cm ³ (10 g) of Head TSL	condition	
SAR measured	1 W input power	2.51 W/kg
SAR for nominal Head TSL parameters	normalized to 1W	2.48 W/kg ± 18.0 % (k=2)

Body TSL parameters

The following parameters and calculations were applied.

	Temperature	Permittivity	Conductivity
Nominal Body TSL parameters	22.0 °C	61.9	0.80 mho/m
Measured Body TSL parameters	(22.0 ± 0.2) °C	61.1 ± 6 %	0.81 mho/m ± 6 %
Body TSL temperature change during test	< 0.5 °C	----	----

SAR result with Body TSL

SAR averaged over 1 cm ³ (1 g) of Body TSL	Condition	
SAR measured	1 W input power	3.86 W/kg
SAR for nominal Body TSL parameters	normalized to 1W	3.81 W/kg ± 18.4 % (k=2)
SAR averaged over 10 cm ³ (10 g) of Body TSL	condition	
SAR measured	1 W input power	2.59 W/kg
SAR for nominal Body TSL parameters	normalized to 1W	2.56 W/kg ± 18.0 % (k=2)

Appendix (Additional assessments outside the scope of SCS108)**Antenna Parameters with Head TSL**

Impedance, transformed to feed point	46.6 Ω - 5.9 j Ω
Return Loss	- 23.0 dB

Antenna Parameters with Body TSL

Impedance, transformed to feed point	48.4 Ω + 6.7 j Ω
Return Loss	- 23.2 dB

Additional EUT Data

Manufactured by	SPEAG
Manufactured on	June 30, 2014

DASY5 Validation Report for Head TSL

Date: 05.09.2014

Test Laboratory: SPEAG, Zurich, Switzerland

DUT: CLA150; Type: CLA150; Serial: CLA150 - SN: 4014

Communication System: UID 0 - CW; Frequency: 150 MHz
 Medium parameters used: $f = 150 \text{ MHz}$; $\sigma = 0.77 \text{ S/m}$; $\epsilon_r = 51.6$; $\rho = 1000 \text{ kg/m}^3$
 Phantom section: Flat Section
 Measurement Standard: DASY5 (IEEE/IEC/ANSI C63.19-2011)

DASY52 Configuration:

- Probe: EX3DV4 - SN3877; ConvF(11.76, 11.76, 11.76); Calibrated: 06.01.2014;
- Sensor-Surface: 2mm (Mechanical Surface Detection), Sensor-Surface: 1.4mm (Mechanical Surface Detection)
- Electronics: DAE4 Sn654; Calibrated: 30.06.2014
- Phantom: ELI v4.0; Type: QDOVA001BB; Serial: TP:1003
- DASY52 52.8.8(1222); SEMCAD X 14.6.10(7331)

CLA Calibration for HSL-LF Tissue/CLA150, touch configuration, Pin=1W/Area Scan (81x81x1): Interpolated grid: $dx=1.500 \text{ mm}$, $dy=1.500 \text{ mm}$
 Maximum value of SAR (interpolated) = 4.74 W/kg

CLA Calibration for HSL-LF Tissue/CLA150, touch configuration, Pin=1W/Zoom Scan, dist=1.4mm (8x9x7)/Cube 0: Measurement grid: $dx=4\text{mm}$, $dy=4\text{mm}$, $dz=1.4\text{mm}$
 Reference Value = 78.54 V/m; Power Drift = -0.04 dB
 Peak SAR (extrapolated) = 7.09 W/kg
SAR(1 g) = 3.77 W/kg; SAR(10 g) = 2.51 W/kg
 Maximum value of SAR (measured) = 5.24 W/kg

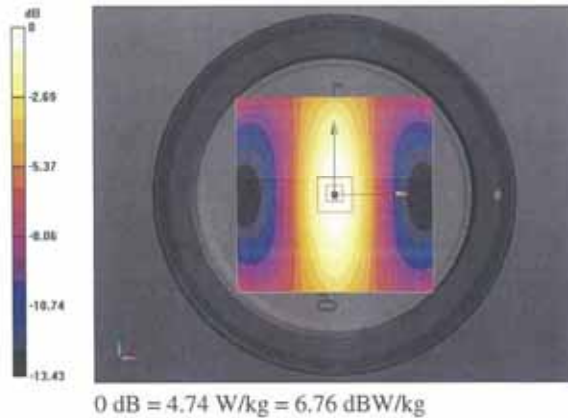

Impedance Measurement Plot for Head TSL

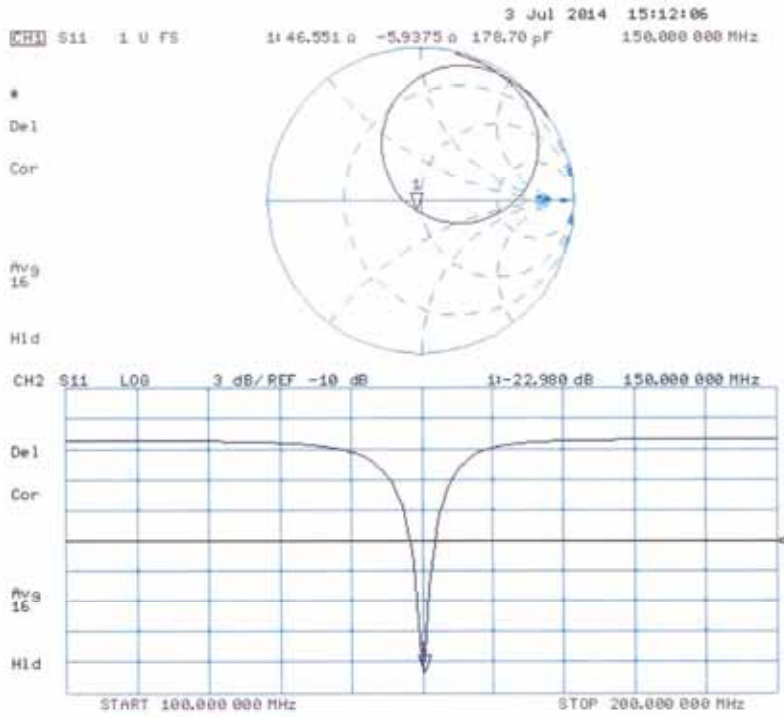

DASY5 Validation Report for Body TSL

Date: 04.09.2014

Test Laboratory: SPEAG, Zurich, Switzerland

DUT: CLA-150; Type: CLA-150; Serial: 4014

Communication System: UID 0 - CW; Frequency: 150 MHz
 Medium parameters used: $f = 150 \text{ MHz}$; $\sigma = 0.81 \text{ S/m}$; $\epsilon_r = 61.1$; $\rho = 1000 \text{ kg/m}^3$
 Phantom section: Flat Section
 Measurement Standard: DASY5 (IEEE/IEC/ANSI C63.19-2011)

DASY52 Configuration:

- Probe: EX3DV4 - SN3877; ConvF(11.45, 11.45, 11.45); Calibrated: 06.01.2014;
- Sensor-Surface: 2mm (Mechanical Surface Detection), Sensor-Surface: 1.4mm (Mechanical Surface Detection)
- Electronics: DAE4 Sn654; Calibrated: 30.06.2014
- Phantom: ELI v4.0; Type: QDOVA001BB; Serial: TP:1003
- DASY52 52.8.8(1222); SEMCAD X 14.6.10(7331)

CLA Calibration for MSL-LF Tissue/CLA150, touch configuration, Pin=1W/Area Scan (81x81x1): Interpolated grid: $dx=1.500 \text{ mm}$, $dy=1.500 \text{ mm}$
 Maximum value of SAR (interpolated) = 4.83 W/kg

CLA Calibration for MSL-LF Tissue/CLA150, touch configuration, Pin=1W/Zoom Scan, dist=1.4mm (8x9x7)/Cube 0: Measurement grid: $dx=4\text{mm}$, $dy=4\text{mm}$, $dz=1.4\text{mm}$
 Reference Value = 77.28 V/m; Power Drift = -0.02 dB
 Peak SAR (extrapolated) = 7.09 W/kg
SAR(1 g) = 3.86 W/kg; SAR(10 g) = 2.59 W/kg
 Maximum value of SAR (measured) = 5.36 W/kg

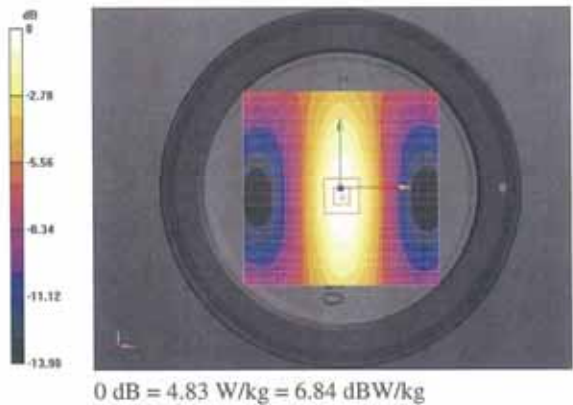

Impedance Measurement Plot for Body TSL

