

7.5 Audio Frequency Response / Audio Low Pass Filter Response

Definition

The audio frequency response is the degree of closeness to which the frequency deviation of the transmitter follows a prescribed characteristic.

TEST CONFIGURATION

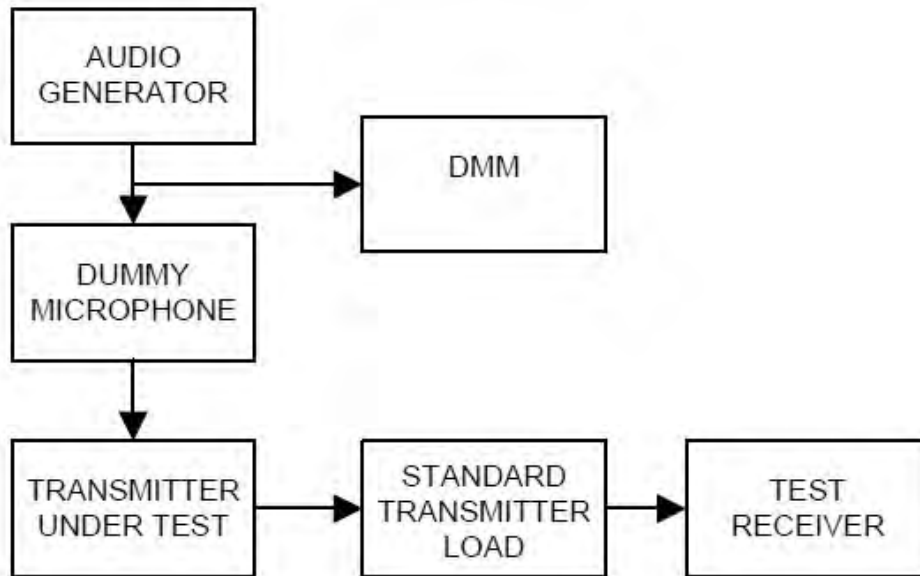

TEST PROCEDURE

According to 2.2.6 in TIA-603-D Standard.

- Connect the equipment as illustrated.
- Set the test receiver to measure peak positive deviation. Set the audio bandwidth for ≤ 50 Hz to $\geq 15,000$ Hz. Turn the de-emphasis function off.
- Set the DMM to measure rms voltage.
- Adjust the transmitter per the manufacturer's procedure for full rated system deviation.
- Apply a 1000 Hz tone and adjust the audio frequency generator to produce 20% of the rated system deviation.
- Set the test receiver to measure rms deviation and record the deviation reading.
- Record the DMM reading as V_{REF} .
- Set the audio frequency generator to the desired test frequency between 300 Hz and 3000 Hz.
- Vary the audio frequency generator output level until the deviation reading that was recorded in step f) is obtained.
- Record the DMM reading as V_{FREQ} .
- Calculate the audio frequency response at the present frequency as:
audio frequency response = $20 * \log_{10}(V_{FREQ}/V_{REF})$
- Repeat steps h) through k) for all the desired test frequencies.

Note

Audio Filter of the above result is substituted with the same structure as Audio Frequency Response.

On the transmission condition below 3kHz, Transceiver shows pre-emphasis condition of transmission function.

On the transmission condition above 3kHz, Transceiver shows Audio Low Pass Filter.

TEST RESULTS

11K0F3E For FCC

Frequency (Hz)	Attenuation Rel. to 1kHz (dB)	Upper limit (dB)	Lower limit (dB)
100	-35.60	-18.93	-42.86
125	-35.44	-17.00	-39.00
300	-12.07	-9.42	-23.84
500	-6.10	-5.00	-9.00
750	-2.46	-1.49	-5.49
1000	-0.02	1.00	-3.00
1250	1.98	2.93	-1.07
1500	3.64	4.51	0.51
2000	6.35	7.00	3.00
2500	8.48	8.93	4.93
3000	8.55	10.51	4.93
4000	-27.93	-	-
5000	-27.81	-	-
6000	-27.93	-	-
7000	-27.81	-	-
8000	-27.81	-	-
9000	-27.87	-	-
10000	-27.81	-	-
20000	-27.68	-	-
30000	-27.81	-	-
40000	-27.74	-	-
50000	-27.87	-	-

11K0F3E_150.05 MHz_HIGH POWER

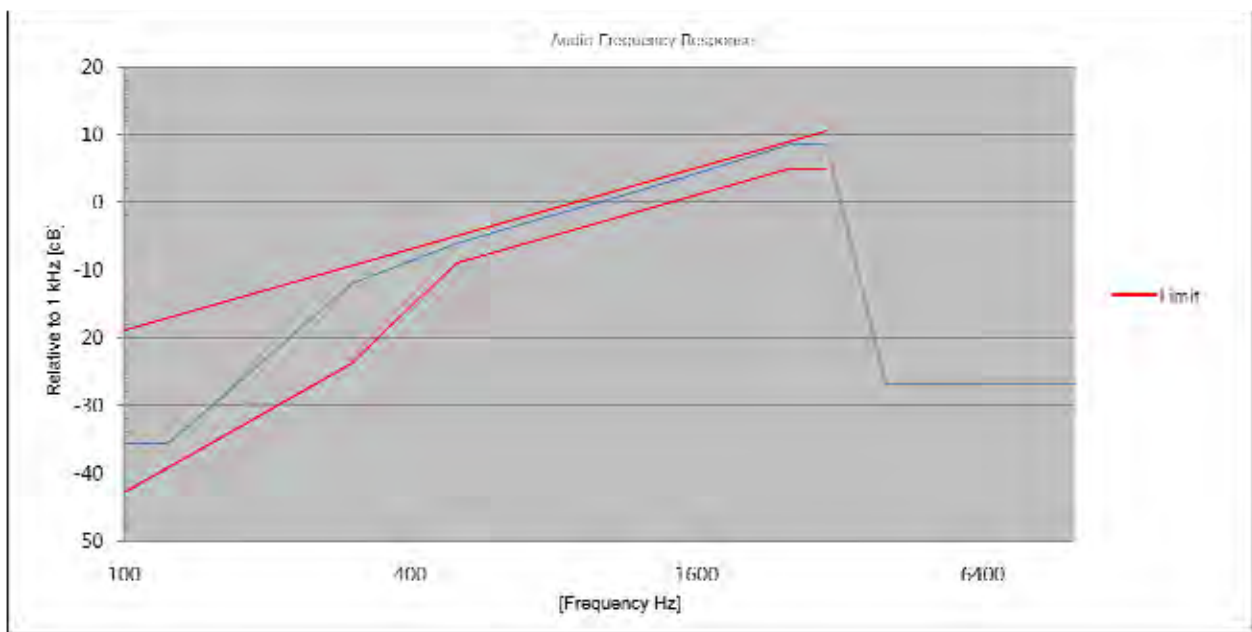

Frequency (Hz)	Attenuation Rel. to 1kHz (dB)	Upper limit (dB)	Lower limit (dB)
100	-34.29	-18.93	-42.86
125	-34.29	-17.00	-39.00
300	-11.96	-9.42	-23.84
500	-6.08	-5.00	-9.00
750	-2.47	-1.49	-5.49
1000	0.00	1.00	-3.00
1250	2.01	2.93	-1.07
1500	3.69	4.51	0.51
2000	6.42	7.00	3.00
2500	8.53	8.93	4.93
3000	8.60	10.51	4.93
4000	-22.76	-	-
5000	-22.76	-	-
6000	-22.94	-	-
7000	-22.79	-	-
8000	-22.83	-	-
9000	-22.79	-	-
10000	-22.76	-	-
20000	-22.79	-	-
30000	-22.83	-	-
40000	-22.79	-	-
50000	-22.86	-	-

11K0F3E_162.05 MHz_HIGH POWER

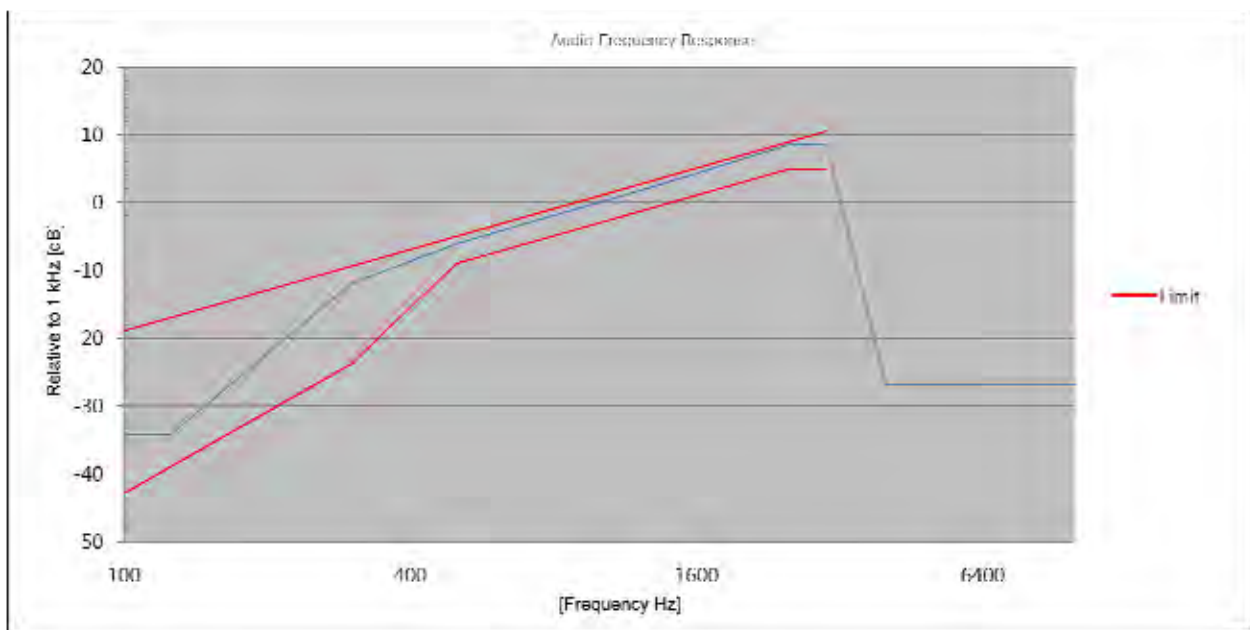

Frequency (Hz)	Attenuation Rel. to 1kHz (dB)	Upper limit (dB)	Lower limit (dB)
100	-34.07	-18.93	-42.86
125	-34.20	-17.00	-39.00
300	-11.89	-9.42	-23.84
500	-6.12	-5.00	-9.00
750	-2.47	-1.49	-5.49
1000	0.00	1.00	-3.00
1250	2.03	2.93	-1.07
1500	3.70	4.51	0.51
2000	6.43	7.00	3.00
2500	8.56	8.93	4.93
3000	8.62	10.51	4.93
4000	-23.20	-	-
5000	-23.12	-	-
6000	-23.12	-	-
7000	-23.09	-	-
8000	-23.16	-	-
9000	-23.16	-	-
10000	-23.16	-	-
20000	-23.12	-	-
30000	-23.31	-	-
40000	-23.12	-	-
50000	-23.09	-	-

11K0F3E_173.95 MHz_HIGH POWER

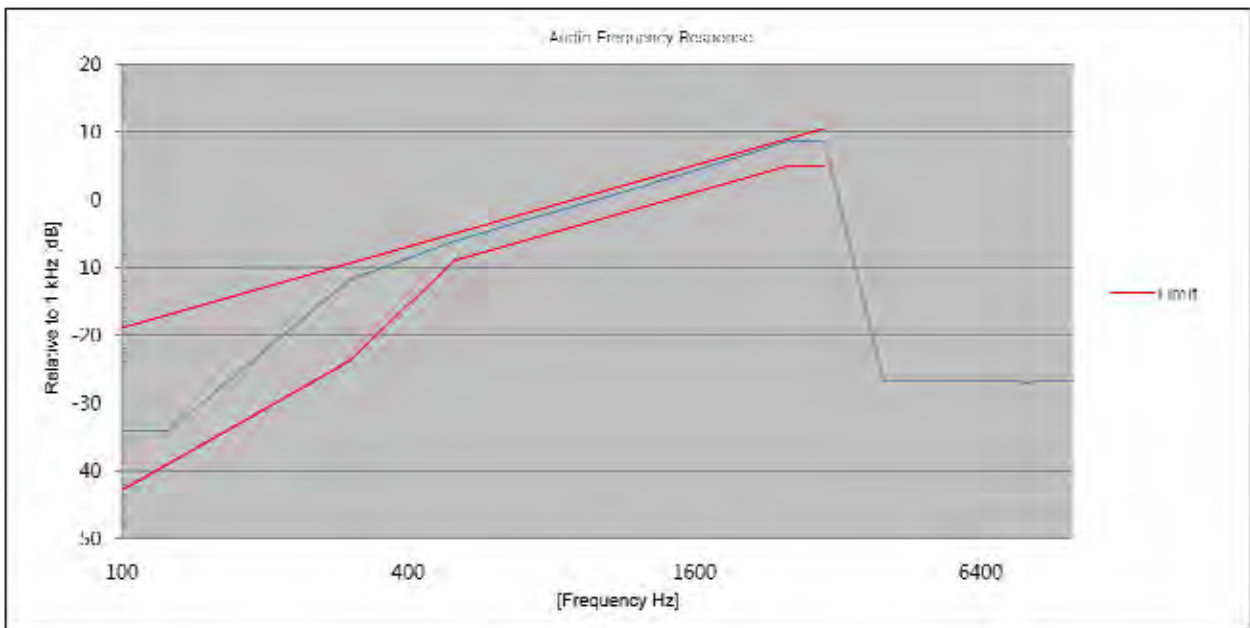

Frequency (Hz)	Attenuation Rel. to 1kHz (dB)	Upper limit (dB)	Lower limit (dB)
100	-35.29	-18.93	-42.86
125	-35.14	-17.00	-39.00
300	-12.09	-9.42	-23.84
500	-6.06	-5.00	-9.00
750	-2.46	-1.49	-5.49
1000	0.00	1.00	-3.00
1250	2.00	2.93	-1.07
1500	3.67	4.51	0.51
2000	6.38	7.00	3.00
2500	8.50	8.93	4.93
3000	8.56	10.51	4.93
4000	-27.66	-	-
5000	-27.59	-	-
6000	-27.79	-	-
7000	-27.72	-	-
8000	-27.79	-	-
9000	-27.66	-	-
10000	-27.72	-	-
20000	-27.79	-	-
30000	-27.72	-	-
40000	-27.79	-	-
50000	-27.79	-	-

11K0F3E_150.05 MHz_LOW POWER

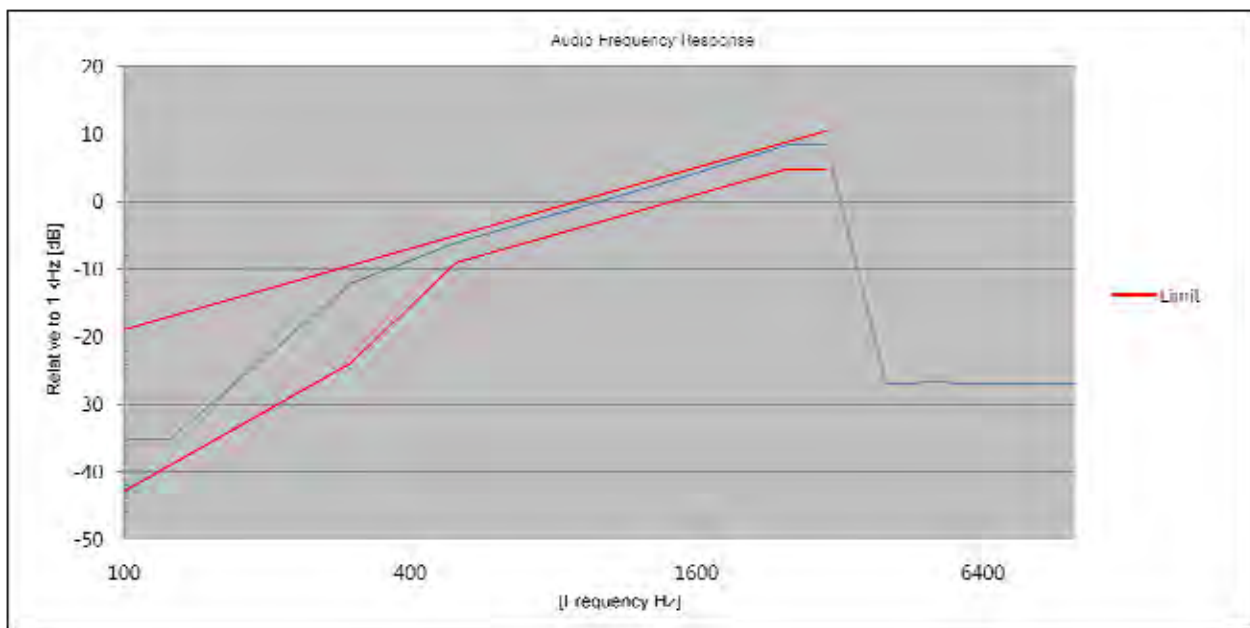

Frequency (Hz)	Attenuation Rel. to 1kHz (dB)	Upper limit (dB)	Lower limit (dB)
100	-34.20	-18.93	-42.86
125	-34.07	-17.00	-39.00
300	-12.02	-9.42	-23.84
500	-6.08	-5.00	-9.00
750	-2.47	-1.49	-5.49
1000	0.00	1.00	-3.00
1250	2.00	2.93	-1.07
1500	3.67	4.51	0.51
2000	6.38	7.00	3.00
2500	8.50	8.93	4.93
3000	8.58	10.51	4.93
4000	-22.85	-	-
5000	-22.78	-	-
6000	-22.89	-	-
7000	-22.89	-	-
8000	-22.78	-	-
9000	-22.78	-	-
10000	-22.85	-	-
20000	-22.71	-	-
30000	-22.78	-	-
40000	-22.71	-	-
50000	-22.78	-	-

11K0F3E_162.05 MHz_LOW POWER

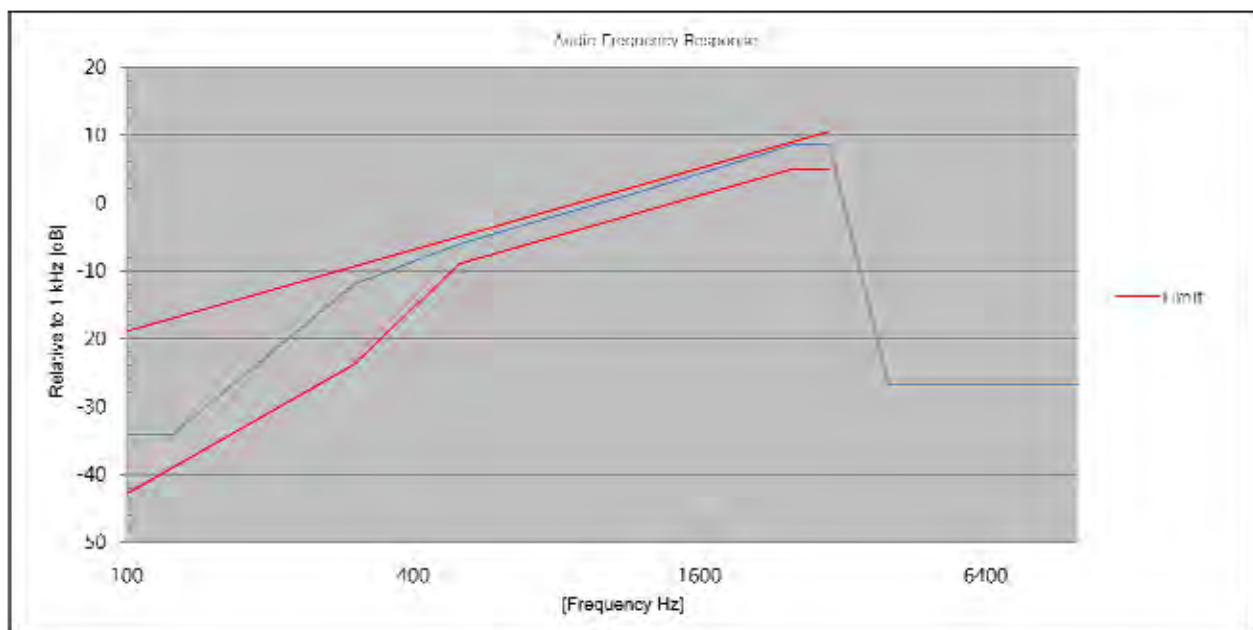

Frequency (Hz)	Attenuation Rel. to 1kHz (dB)	Upper limit (dB)	Lower limit (dB)
100	-33.94	-18.93	-42.86
125	-33.43	-17.00	-39.00
300	-11.99	-9.42	-23.84
500	-6.12	-5.00	-9.00
750	-2.48	-1.49	-5.49
1000	0.03	1.00	-3.00
1250	2.05	2.93	-1.07
1500	3.71	4.51	0.51
2000	6.44	7.00	3.00
2500	8.56	8.93	4.93
3000	8.62	10.51	4.93
4000	-22.97	-	-
5000	-22.90	-	-
6000	-22.90	-	-
7000	-23.05	-	-
8000	-22.97	-	-
9000	-22.97	-	-
10000	-23.01	-	-
20000	-22.97	-	-
30000	-22.94	-	-
40000	-22.90	-	-
50000	-22.97	-	-

11K0F3E_173.95 MHz_LOW POWER

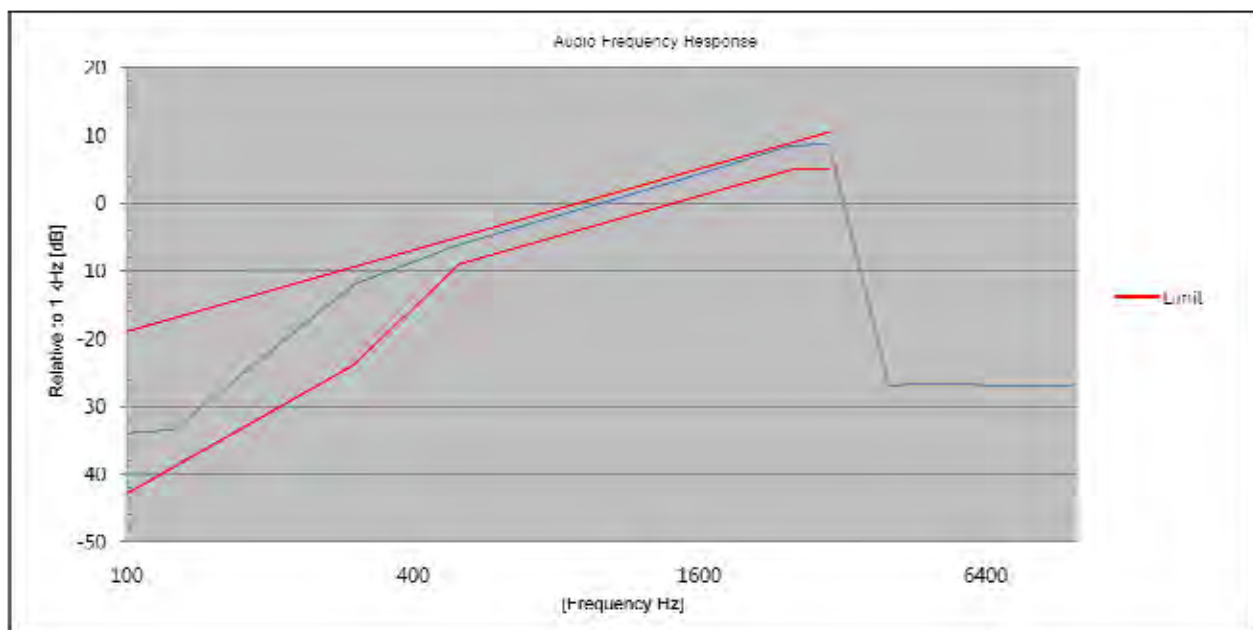

TEST RESULTS

16K0F3E For IC

Frequency (Hz)	Attenuation Rel. to 1kHz (dB)	Upper limit (dB)	Lower limit (dB)
100	-36.36	-18.93	-42.86
125	-36.25	-17.00	-39.00
300	-12.15	-9.42	-23.84
500	-6.18	-5.00	-9.00
750	-2.51	-1.49	-5.49
1000	-0.01	1.00	-3.00
1250	2.03	2.93	-1.07
1500	3.67	4.51	0.51
2000	6.39	7.00	3.00
2500	8.50	8.93	4.93
3000	8.57	10.51	4.93
4000	-31.73	-	-
5000	-31.50	-	-
6000	-31.73	-	-
7000	-31.63	-	-
8000	-31.80	-	-
9000	-31.83	-	-
10000	-31.70	-	-
20000	-31.83	-	-
30000	-31.73	-	-
40000	-31.73	-	-
50000	-31.80	-	-

16K0F3E_138.05 MHz_HIGH POWER

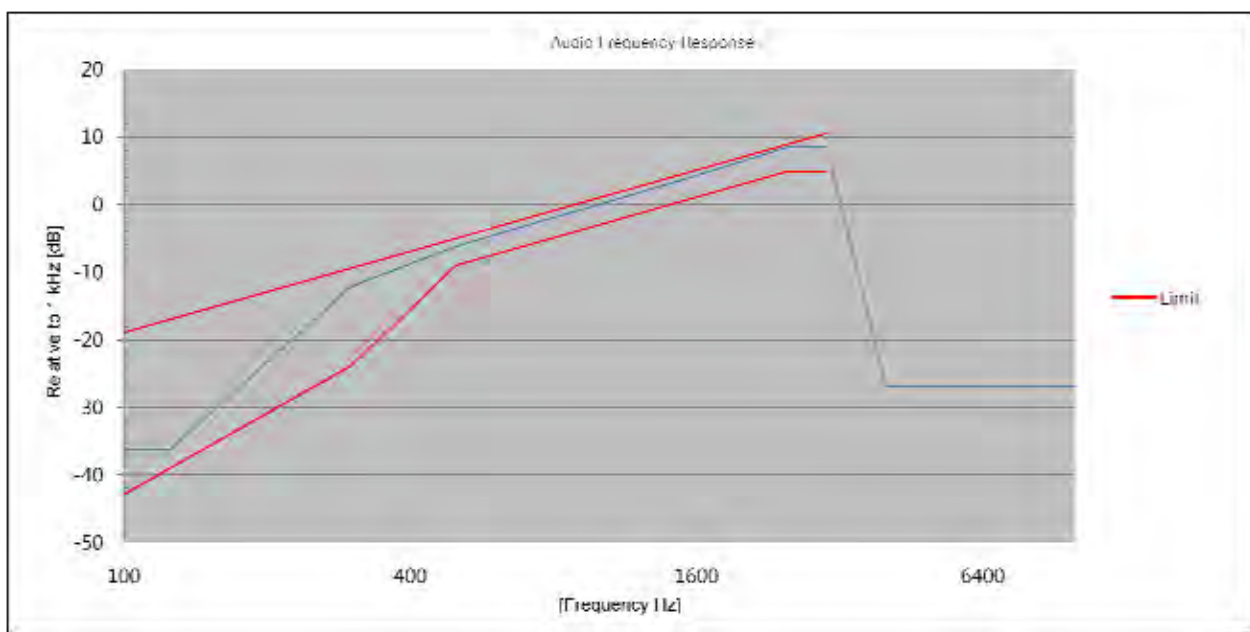

Frequency (Hz)	Attenuation Rel. to 1kHz (dB)	Upper limit (dB)	Lower limit (dB)
100	-36.08	-18.93	-42.86
125	-36.14	-17.00	-39.00
300	-12.12	-9.42	-23.84
500	-6.14	-5.00	-9.00
750	-2.47	-1.49	-5.49
1000	0.03	1.00	-3.00
1250	2.05	2.93	-1.07
1500	3.71	4.51	0.51
2000	6.43	7.00	3.00
2500	8.55	8.93	4.93
3000	8.62	10.51	4.93
4000	-31.94	-	-
5000	-31.77	-	-
6000	-31.90	-	-
7000	-31.94	-	-
8000	-31.90	-	-
9000	-31.94	-	-
10000	-32.04	-	-
20000	-31.94	-	-
30000	-31.83	-	-
40000	-31.90	-	-
50000	-31.80	-	-

16K0F3E_143.95 MHz_HIGH POWER

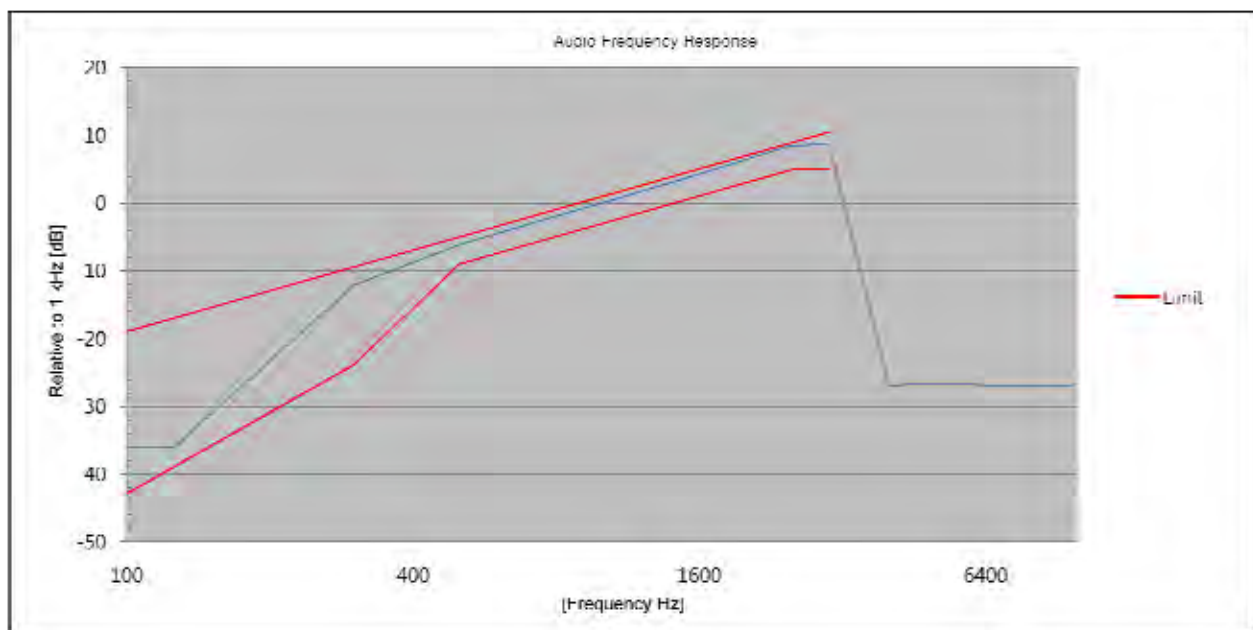

Frequency (Hz)	Attenuation Rel. to 1kHz (dB)	Upper limit (dB)	Lower limit (dB)
100	-36.25	-18.93	-42.86
125	-36.42	-17.00	-39.00
300	-12.11	-9.42	-23.84
500	-6.16	-5.00	-9.00
750	-2.50	-1.49	-5.49
1000	0.00	1.00	-3.00
1250	2.00	2.93	-1.07
1500	3.68	4.51	0.51
2000	6.40	7.00	3.00
2500	8.52	8.93	4.93
3000	8.60	10.51	4.93
4000	-32.22	-	-
5000	-32.04	-	-
6000	-32.18	-	-
7000	-32.32	-	-
8000	-32.18	-	-
9000	-32.29	-	-
10000	-32.18	-	-
20000	-32.22	-	-
30000	-32.22	-	-
40000	-32.32	-	-
50000	-32.15	-	-

16K0F3E_148.05 MHz_HIGH POWER

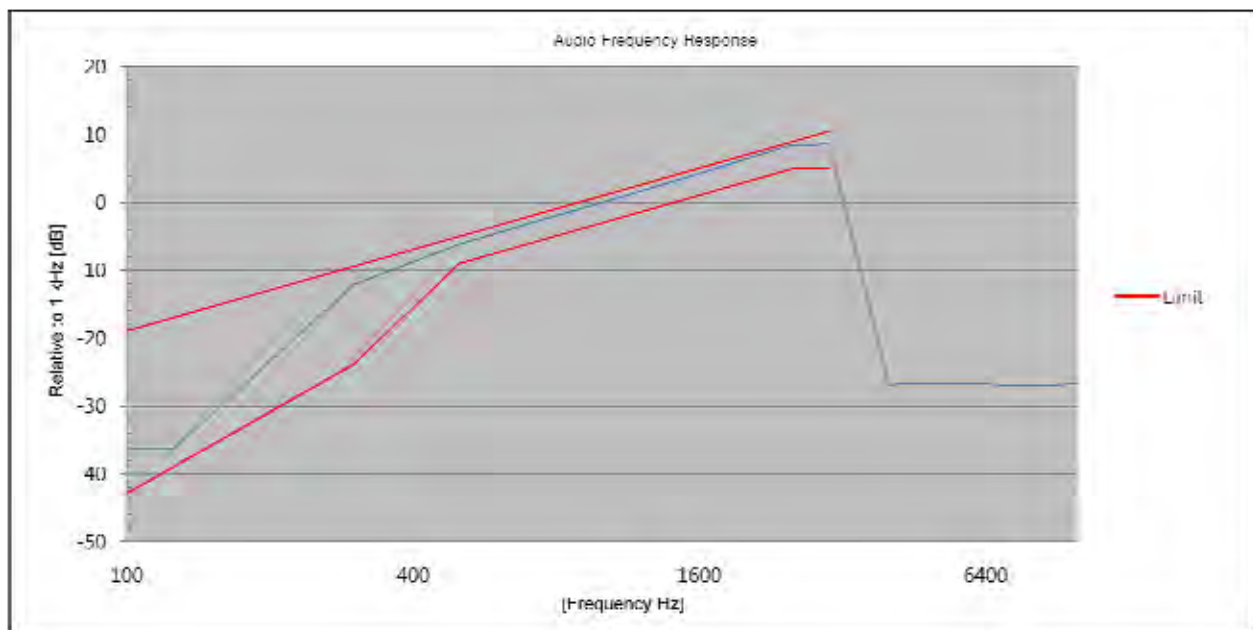

Frequency (Hz)	Attenuation Rel. to 1kHz (dB)	Upper limit (dB)	Lower limit (dB)
100	-35.54	-18.93	-42.86
125	-35.54	-17.00	-39.00
300	-12.01	-9.42	-23.84
500	-6.12	-5.00	-9.00
750	-2.49	-1.49	-5.49
1000	0.00	1.00	-3.00
1250	2.04	2.93	-1.07
1500	3.70	4.51	0.51
2000	6.41	7.00	3.00
2500	8.53	8.93	4.93
3000	8.60	10.51	4.93
4000	-31.37	-	-
5000	-31.18	-	-
6000	-31.37	-	-
7000	-31.47	-	-
8000	-31.37	-	-
9000	-31.53	-	-
10000	-31.53	-	-
20000	-31.44	-	-
30000	-31.53	-	-
40000	-31.53	-	-
50000	-31.44	-	-

16K0F3E_138.05 MHz_LOW POWER

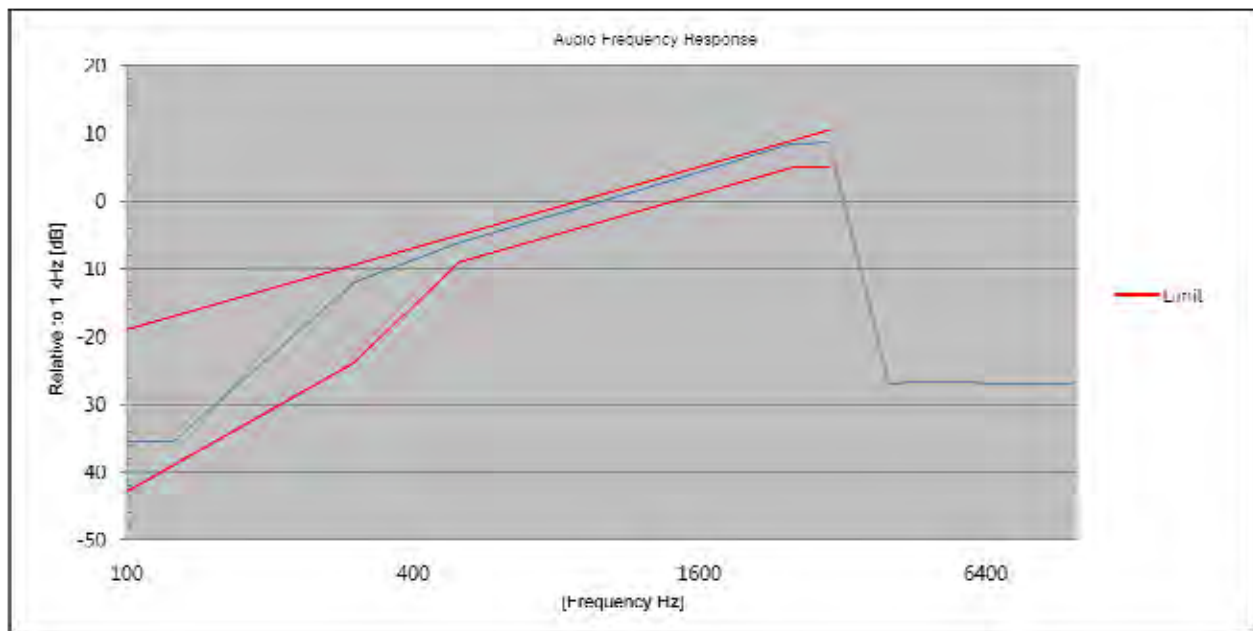

Frequency (Hz)	Attenuation Rel. to 1kHz (dB)	Upper limit (dB)	Lower limit (dB)
100	-35.44	-18.93	-42.86
125	-35.60	-17.00	-39.00
300	-12.08	-9.42	-23.84
500	-6.12	-5.00	-9.00
750	-2.51	-1.49	-5.49
1000	0.01	1.00	-3.00
1250	2.06	2.93	-1.07
1500	3.69	4.51	0.51
2000	6.41	7.00	3.00
2500	8.54	8.93	4.93
3000	8.61	10.51	4.93
4000	-31.70	-	-
5000	-31.47	-	-
6000	-31.77	-	-
7000	-31.70	-	-
8000	-31.70	-	-
9000	-31.70	-	-
10000	-31.80	-	-
20000	-31.57	-	-
30000	-31.77	-	-
40000	-31.70	-	-
50000	-31.77	-	-

16K0F3E_143.95 MHz_LOW POWER

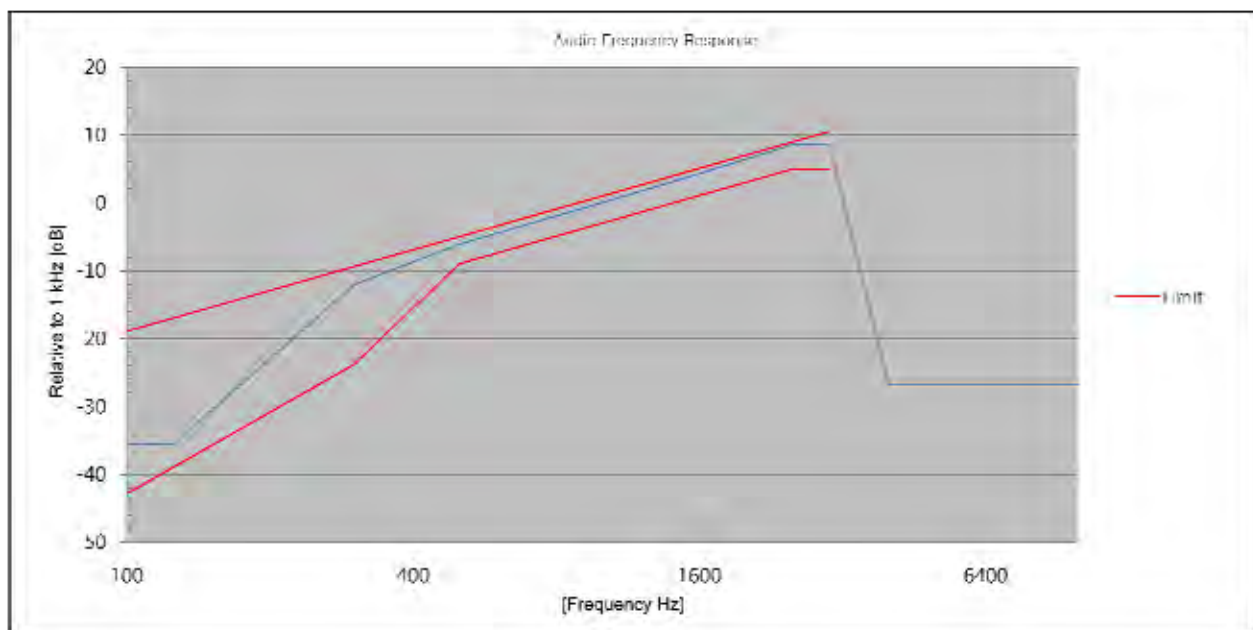

Frequency (Hz)	Attenuation Rel. to 1kHz (dB)	Upper limit (dB)	Lower limit (dB)
100	-35.39	-18.93	-42.86
125	-35.70	-17.00	-39.00
300	-12.03	-9.42	-23.84
500	-6.16	-5.00	-9.00
750	-2.50	-1.49	-5.49
1000	0.00	1.00	-3.00
1250	2.02	2.93	-1.07
1500	3.68	4.51	0.51
2000	6.41	7.00	3.00
2500	8.54	8.93	4.93
3000	8.60	10.51	4.93
4000	-31.94	-	-
5000	-31.57	-	-
6000	-31.87	-	-
7000	-31.87	-	-
8000	-31.94	-	-
9000	-31.97	-	-
10000	-31.94	-	-
20000	-31.83	-	-
30000	-31.73	-	-
40000	-31.94	-	-
50000	-31.97	-	-

16K0F3E_148.05 MHz_LOW POWER

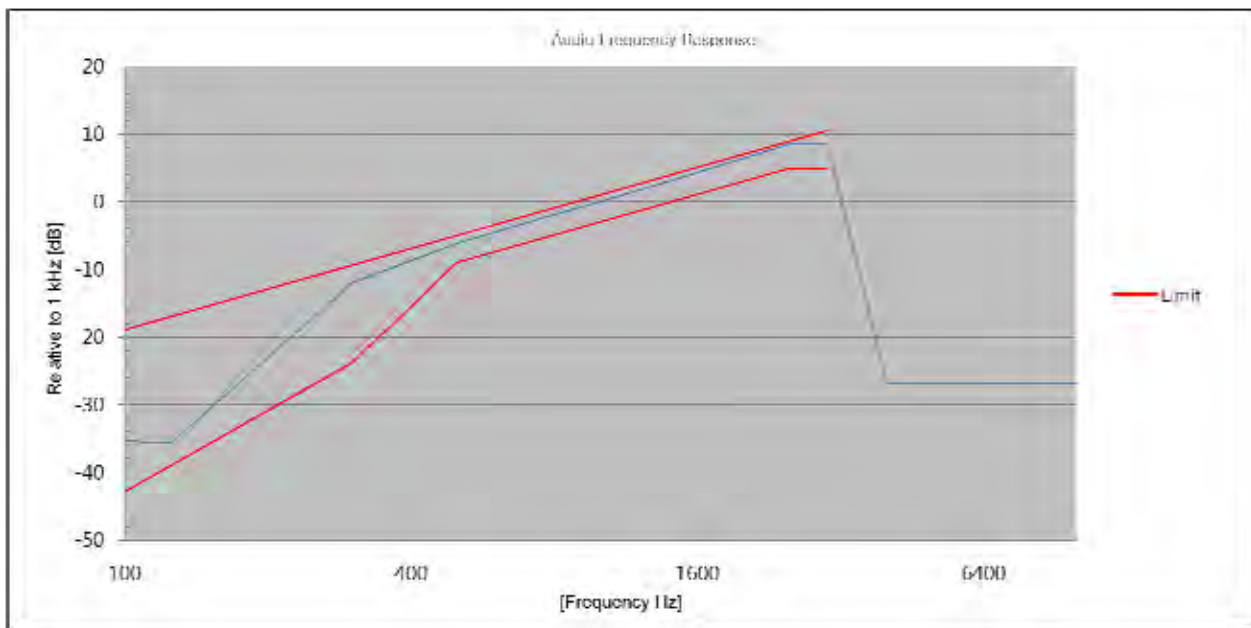

11K0F3E For IC

Frequency (Hz)	Attenuation Rel. to 1kHz (dB)	Upper limit (dB)	Lower limit (dB)
100	-35.24	-18.93	-42.86
125	-35.54	-17.00	-39.00
300	-12.10	-9.42	-23.84
500	-6.08	-5.00	-9.00
750	-2.47	-1.49	-5.49
1000	0.00	1.00	-3.00
1250	2.04	2.93	-1.07
1500	3.67	4.51	0.51
2000	6.41	7.00	3.00
2500	8.52	8.93	4.93
3000	8.59	10.51	4.93
4000	-26.84	-	-
5000	-26.75	-	-
6000	-26.80	-	-
7000	-26.84	-	-
8000	-26.90	-	-
9000	-26.84	-	-
10000	-26.80	-	-
20000	-26.84	-	-
30000	-26.90	-	-
40000	-26.84	-	-
50000	-26.75	-	-

11K0F3E_138.05 MHz_HIGH POWER

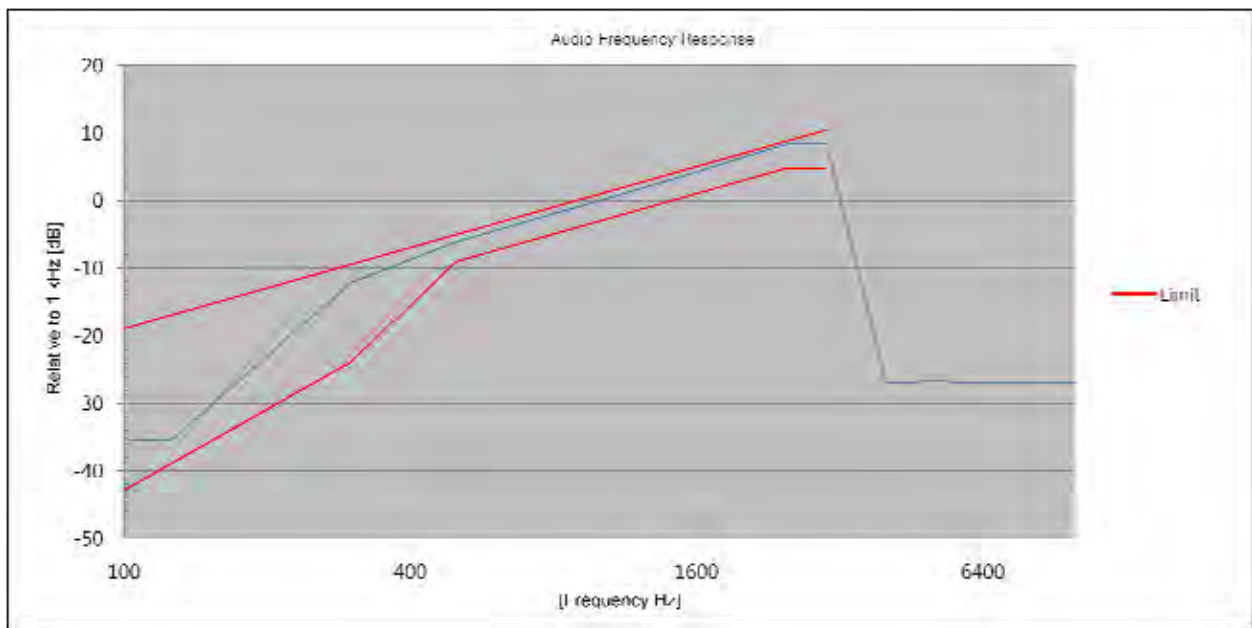

Frequency (Hz)	Attenuation Rel. to 1kHz (dB)	Upper limit (dB)	Lower limit (dB)
100	-35.09	-18.93	-42.86
125	-35.19	-17.00	-39.00
300	-12.09	-9.42	-23.84
500	-6.08	-5.00	-9.00
750	-2.44	-1.49	-5.49
1000	0.03	1.00	-3.00
1250	2.07	2.93	-1.07
1500	3.69	4.51	0.51
2000	6.44	7.00	3.00
2500	8.55	8.93	4.93
3000	8.62	10.51	4.93
4000	-27.05	-	-
5000	-27.05	-	-
6000	-26.99	-	-
7000	-27.05	-	-
8000	-27.11	-	-
9000	-27.05	-	-
10000	-26.99	-	-
20000	-27.05	-	-
30000	-27.11	-	-
40000	-27.05	-	-
50000	-27.05	-	-

11K0F3E_143.95 MHz_HIGH POWER

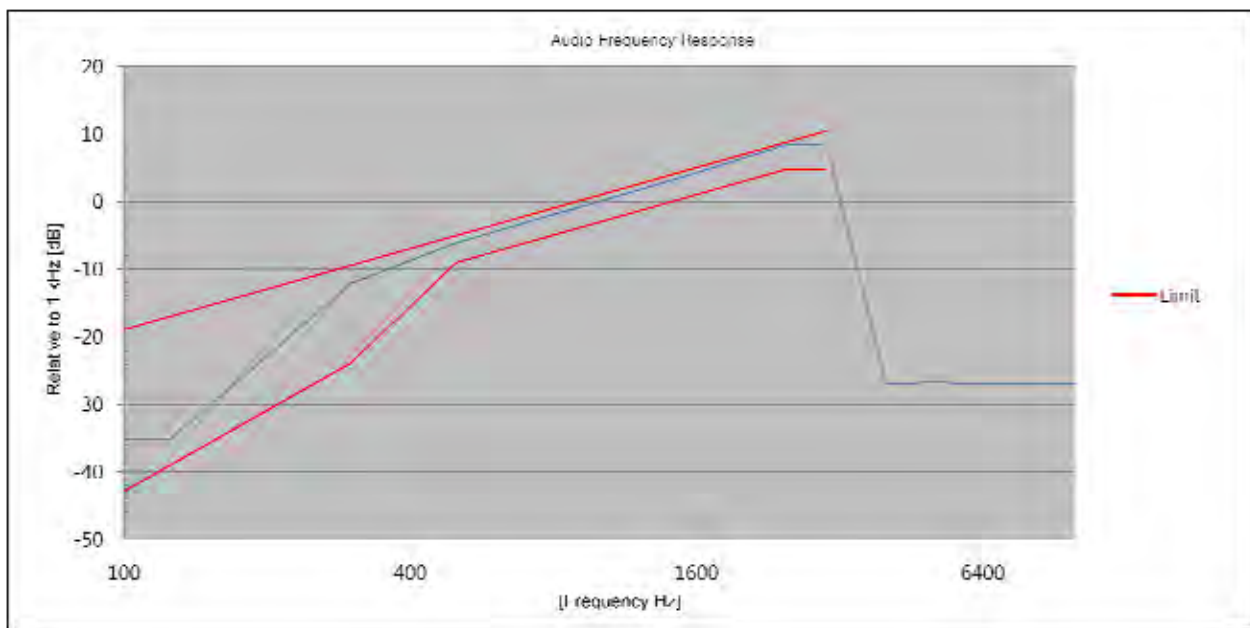

Frequency (Hz)	Attenuation Rel. to 1kHz (dB)	Upper limit (dB)	Lower limit (dB)
100	-34.52	-18.93	-42.86
125	-35.09	-17.00	-39.00
300	-11.94	-9.42	-23.84
500	-6.09	-5.00	-9.00
750	-2.47	-1.49	-5.49
1000	0.00	1.00	-3.00
1250	2.00	2.93	-1.07
1500	3.68	4.51	0.51
2000	6.42	7.00	3.00
2500	8.54	8.93	4.93
3000	8.59	10.51	4.93
4000	-27.62	-	-
5000	-27.37	-	-
6000	-27.43	-	-
7000	-27.49	-	-
8000	-27.49	-	-
9000	-27.55	-	-
10000	-27.43	-	-
20000	-27.49	-	-
30000	-27.49	-	-
40000	-27.43	-	-
50000	-27.49	-	-

11K0F3E_148.05 MHz_HIGH POWER

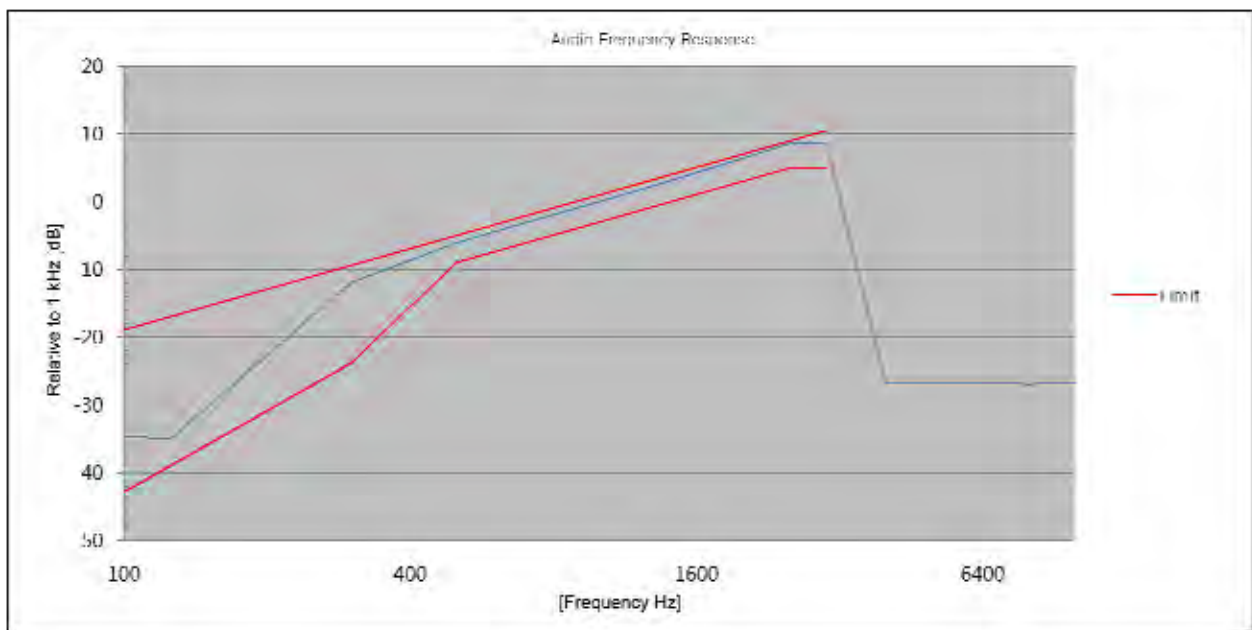

Frequency (Hz)	Attenuation Rel. to 1kHz (dB)	Upper limit (dB)	Lower limit (dB)
100	-34.24	-18.93	-42.86
125	-34.24	-17.00	-39.00
300	-12.03	-9.42	-23.84
500	-6.06	-5.00	-9.00
750	-2.46	-1.49	-5.49
1000	0.00	1.00	-3.00
1250	2.02	2.93	-1.07
1500	3.67	4.51	0.51
2000	6.41	7.00	3.00
2500	8.53	8.93	4.93
3000	8.58	10.51	4.93
4000	-26.52	-	-
5000	-26.58	-	-
6000	-26.80	-	-
7000	-26.69	-	-
8000	-26.80	-	-
9000	-26.75	-	-
10000	-26.80	-	-
20000	-26.63	-	-
30000	-26.63	-	-
40000	-26.52	-	-
50000	-26.75	-	-

11K0F3E_138.05 MHz_LOW POWER

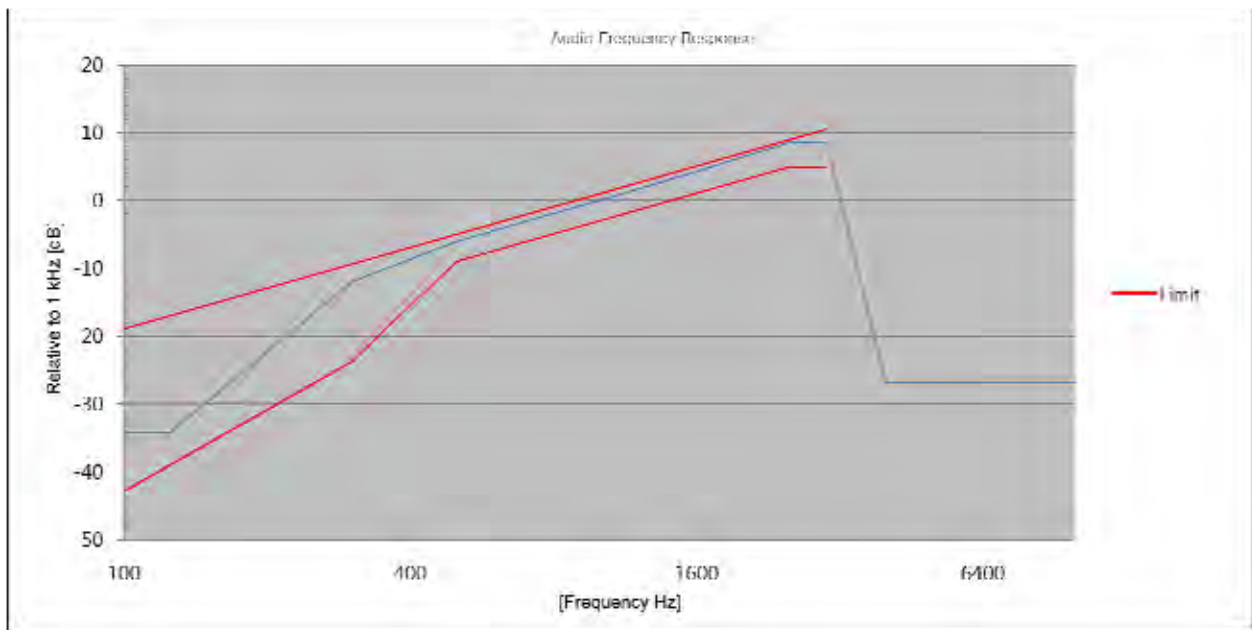

Frequency (Hz)	Attenuation Rel. to 1kHz (dB)	Upper limit (dB)	Lower limit (dB)
100	-34.52	-18.93	-42.86
125	-34.52	-17.00	-39.00
300	-12.05	-9.42	-23.84
500	-6.11	-5.00	-9.00
750	-2.49	-1.49	-5.49
1000	0.00	1.00	-3.00
1250	2.00	2.93	-1.07
1500	3.67	4.51	0.51
2000	6.42	7.00	3.00
2500	8.54	8.93	4.93
3000	8.59	10.51	4.93
4000	-27.01	-	-
5000	-26.80	-	-
6000	-26.90	-	-
7000	-26.95	-	-
8000	-27.07	-	-
9000	-27.01	-	-
10000	-26.90	-	-
20000	-27.01	-	-
30000	-27.07	-	-
40000	-27.01	-	-
50000	-27.07	-	-

11K0F3E_143.95 MHz_LOW POWER

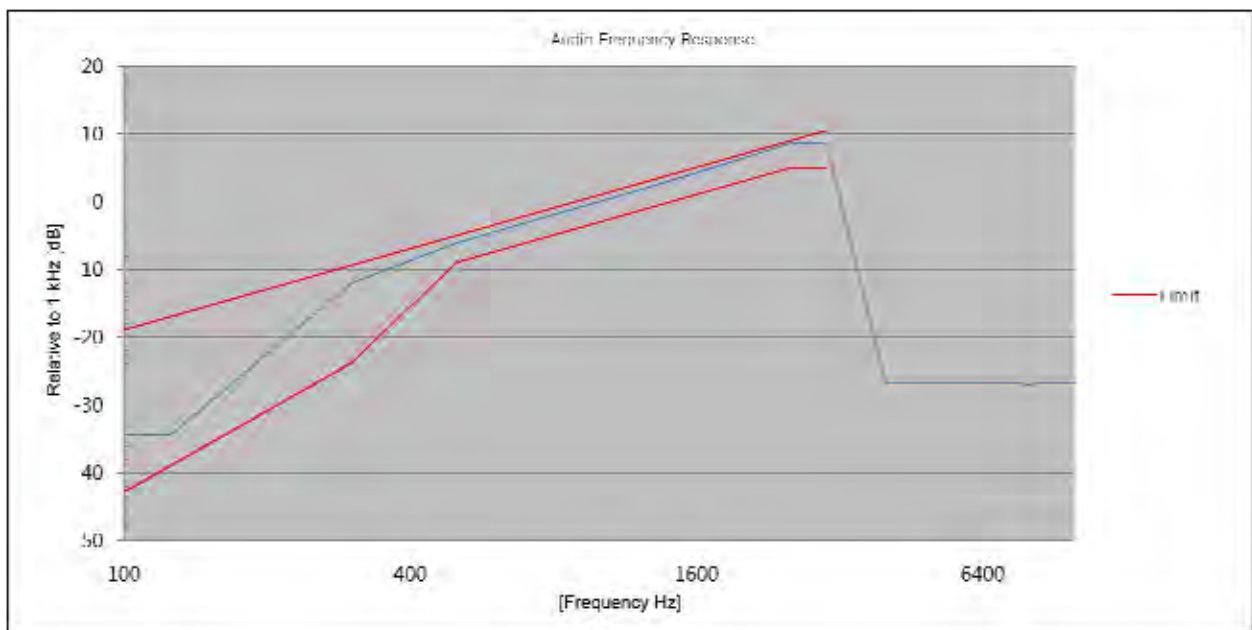

Frequency (Hz)	Attenuation Rel. to 1kHz (dB)	Upper limit (dB)	Lower limit (dB)
100	-34.38	-18.93	-42.86
125	-34.66	-17.00	-39.00
300	-12.02	-9.42	-23.84
500	-6.13	-5.00	-9.00
750	-2.46	-1.49	-5.49
1000	0.00	1.00	-3.00
1250	2.02	2.93	-1.07
1500	3.68	4.51	0.51
2000	6.41	7.00	3.00
2500	8.54	8.93	4.93
3000	8.60	10.51	4.93
4000	-27.43	-	-
5000	-27.37	-	-
6000	-27.31	-	-
7000	-27.37	-	-
8000	-27.31	-	-
9000	-27.31	-	-
10000	-27.31	-	-
20000	-27.43	-	-
30000	-27.37	-	-
40000	-27.25	-	-
50000	-27.31	-	-

11K0F3E_148.05 MHz_LOW POWER

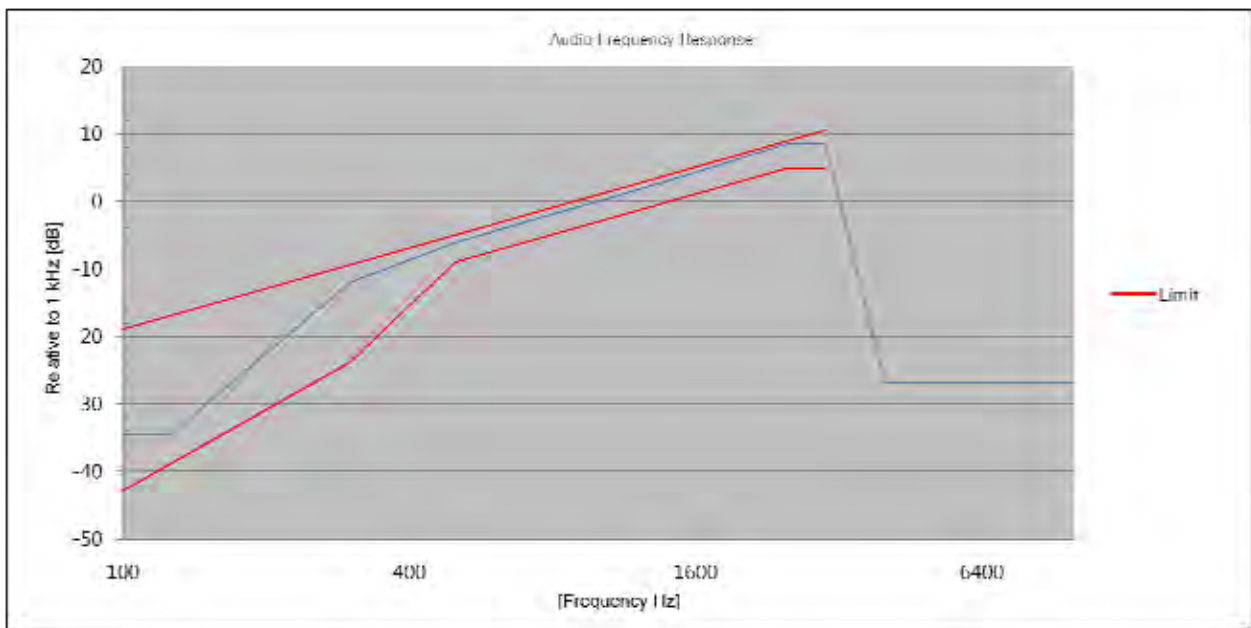

7.6 Emission Mask

Definition

The transmitter sideband spectrum denotes the sideband power produced at a discrete frequency separation from the carrier up to the test bandwidth (see 1.3.4.4) due to all sources of unwanted noise within the transmitter in a modulated condition.

TEST CONFIGURATION

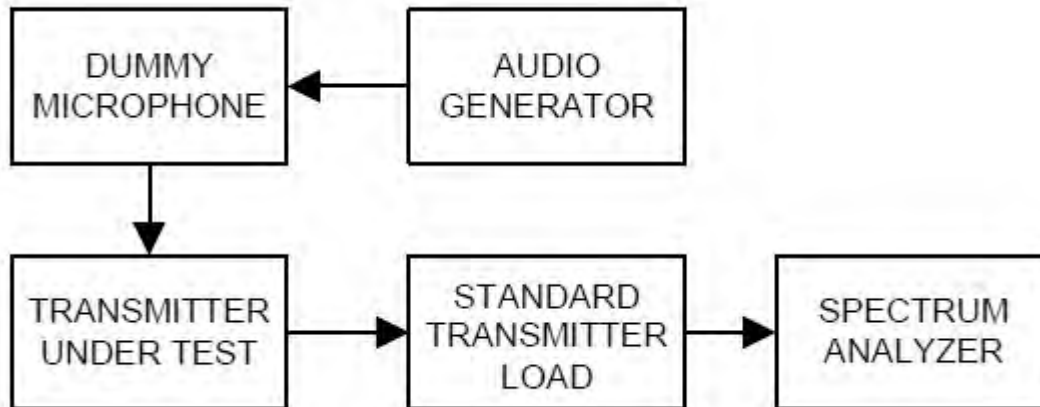

TEST PROCEDURE

According to 2.2.11 in TIA-603-D Standard.

- a) Connect the equipment as illustrated. Use the table to determine the spectrum analyzer resolution bandwidth:

Spectrum Analyzer Resolution Bandwidth

Frequency Band (MHz)	Mask for Equipment with Audio Low Pass Filter	Mask for Equipment without Low Pass Filter	Spectrum Analyzer Resolution Bandwidth (Hz)
25-50	B	C	300
72-76	B	C	300
138-174	NTIA	NTIA	300
150-174	B	C	300
150-174	D or E	D or E	100
406-420	NTIA	NTIA	300
421-512	B	C	300
421-512	D or E	D or E	100
806-821/851-866	B or EA	G or EA	300
821-824/866-869	B	H	300
896-901/935-940	I	J	300

- b) Adjust the spectrum analyzer for the following settings:
 - 1) Resolution Bandwidth per the above table
 - 2) Video Bandwidth at least 10 times the resolution bandwidth.
 - 3) Sweep Speed slow enough to maintain measurement calibration.
 - 4) Detector Mode = Positive Peak.
 - 5) Span that will allow proper viewing of the test bandwidth (see 1.3.4.4).
- c) Set the center frequency of the spectrum analyzer to the assigned transmitter frequency. Key the transmitter, and set the level of the unmodulated carrier to a full scale reference line.
This is the 0 dB reference for the measurement.
- d) Modulate the transmitter with a 2500 Hz sine wave at an input level 16 dB greater than that necessary to produce 50% of rated system deviation. The input level shall be established at the frequency of maximum response of the audio modulating circuit. Transmitters employing digital modulation techniques that bypass the limiter and the audio low-pass filter shall be modulated as specified by the manufacturer.
- e) Record the resulting spectrum analyzer presentation of the emission level with an on-line recording device or in a photograph. It is recommended that the emission limit (as given in 3.2.11) be drawn on the plotted graph or photograph. The spectrum analyzer presentation is the sideband spectrum.

Plots of Emission Mask FCC

(11K0F3E _ 150.05 MHz)_High

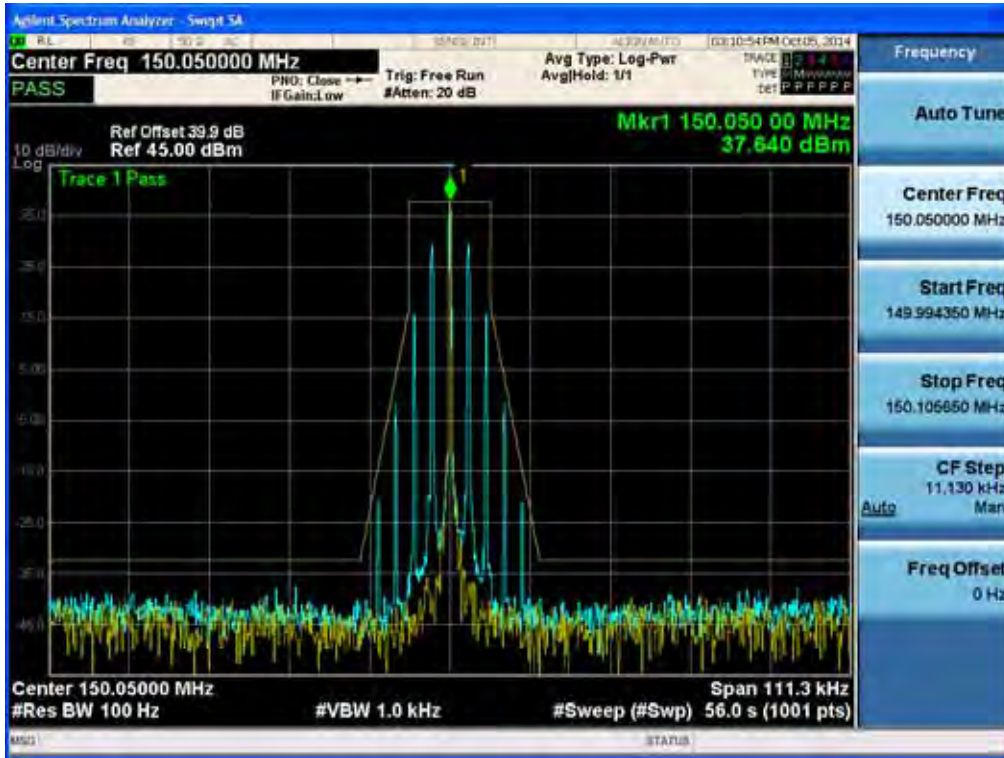

(11K0F3E _ 162.05 MHz)_High

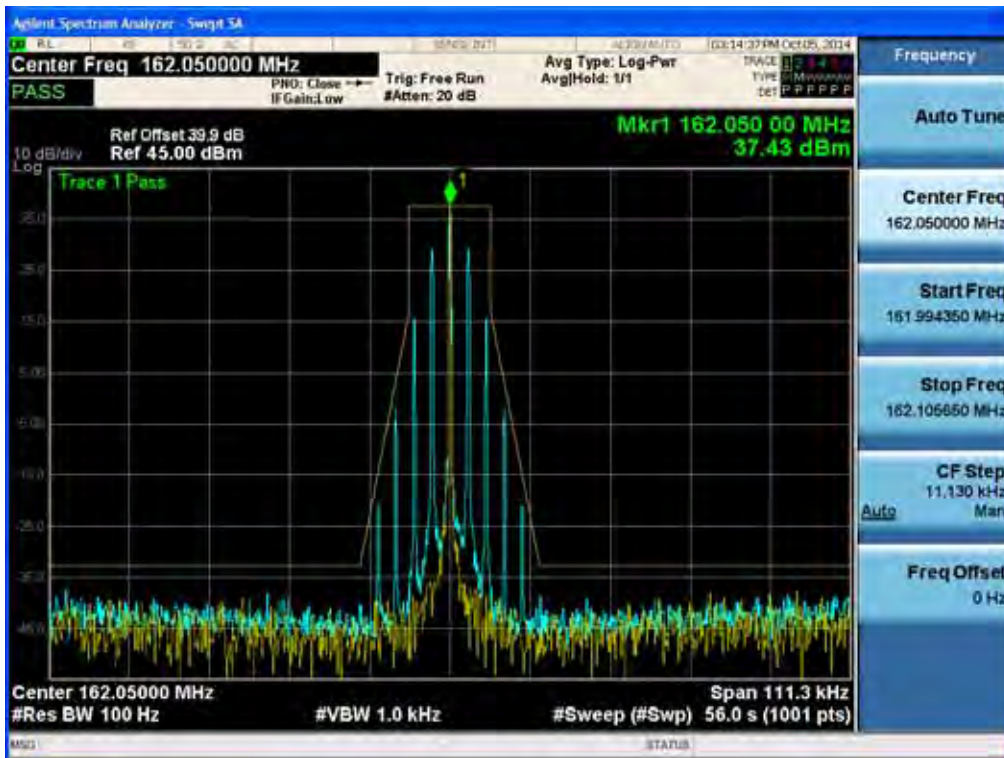

(11K0F3E _ 173.95 MHz)_High

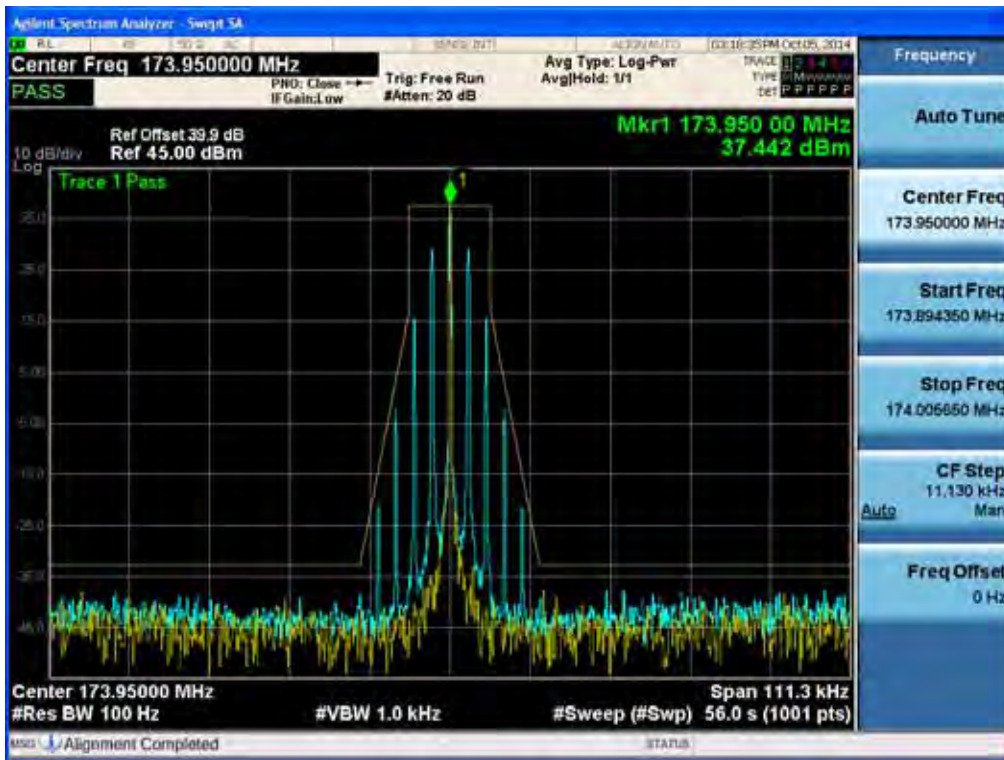

(11K0F3E _ 150.05 MHz)_Low

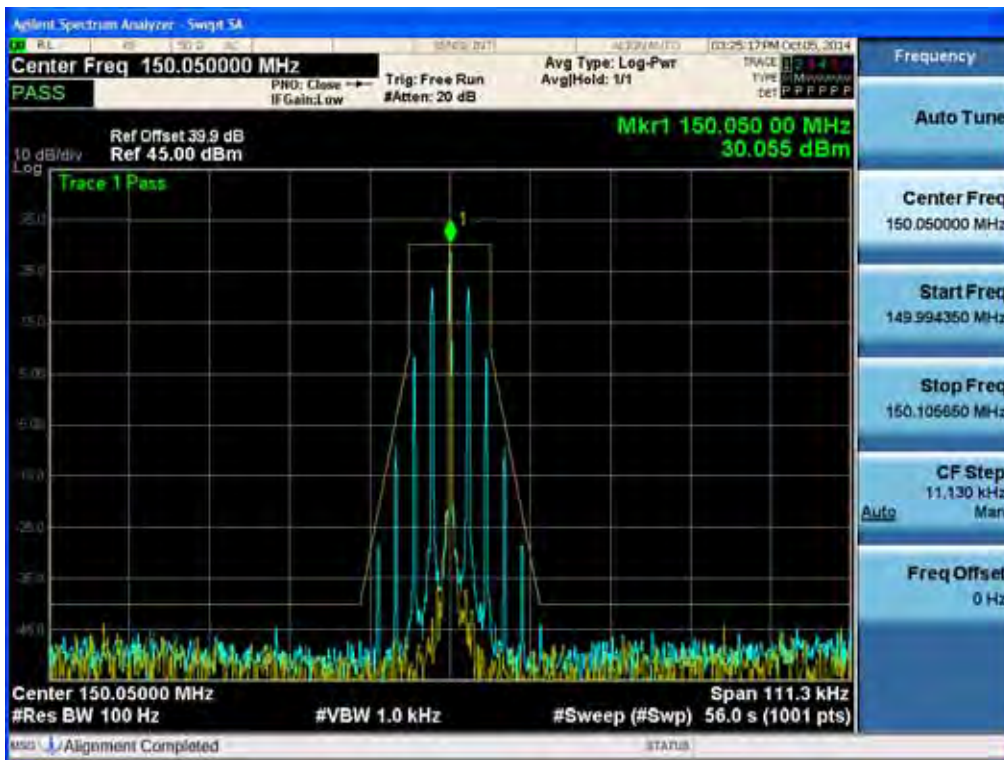

(11K0F3E _ 162.05 MHz)_Low

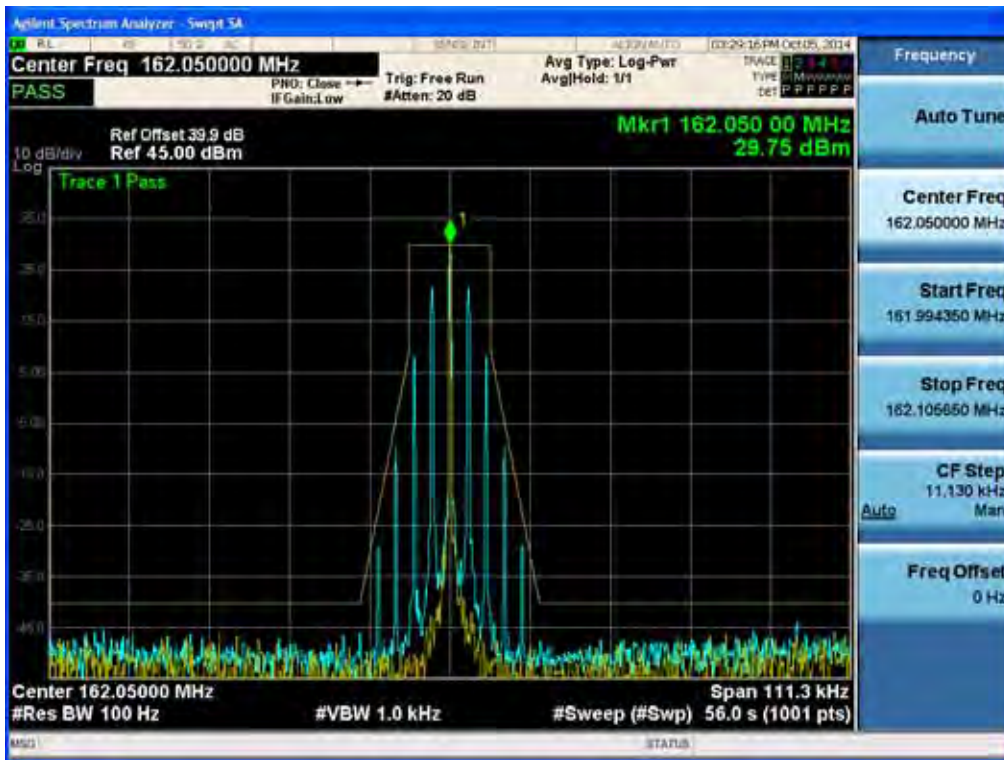

(11K0F3E _ 173.95 MHz)_Low

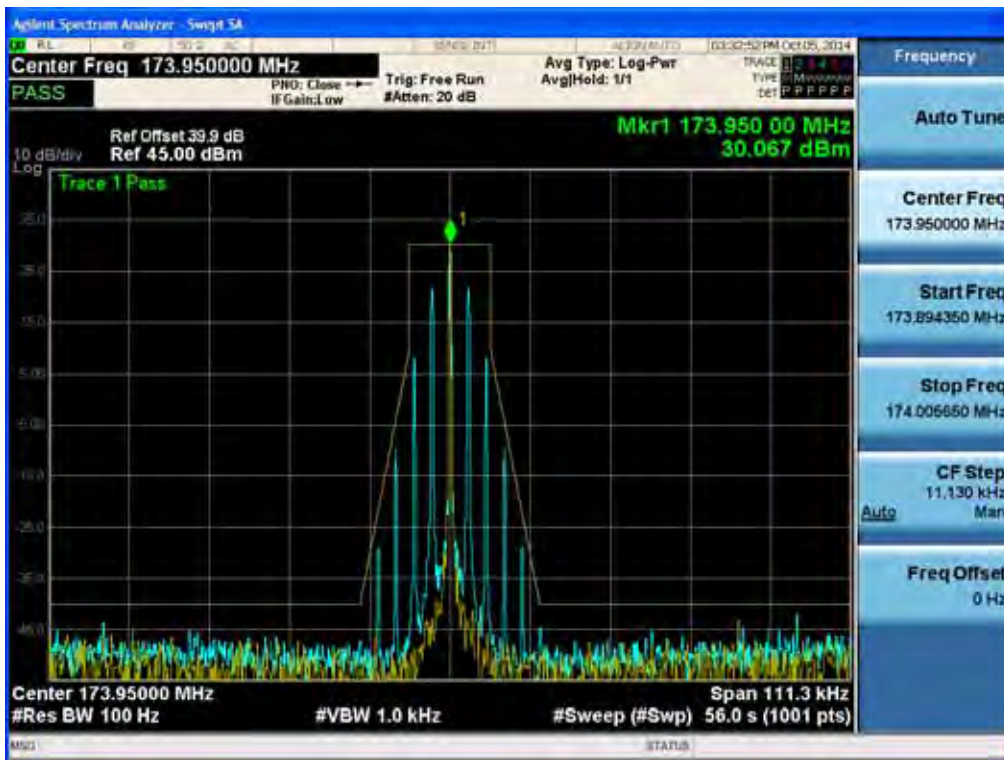

(8K10F1E, 8K10F1D _ 150.05 MHz)_High

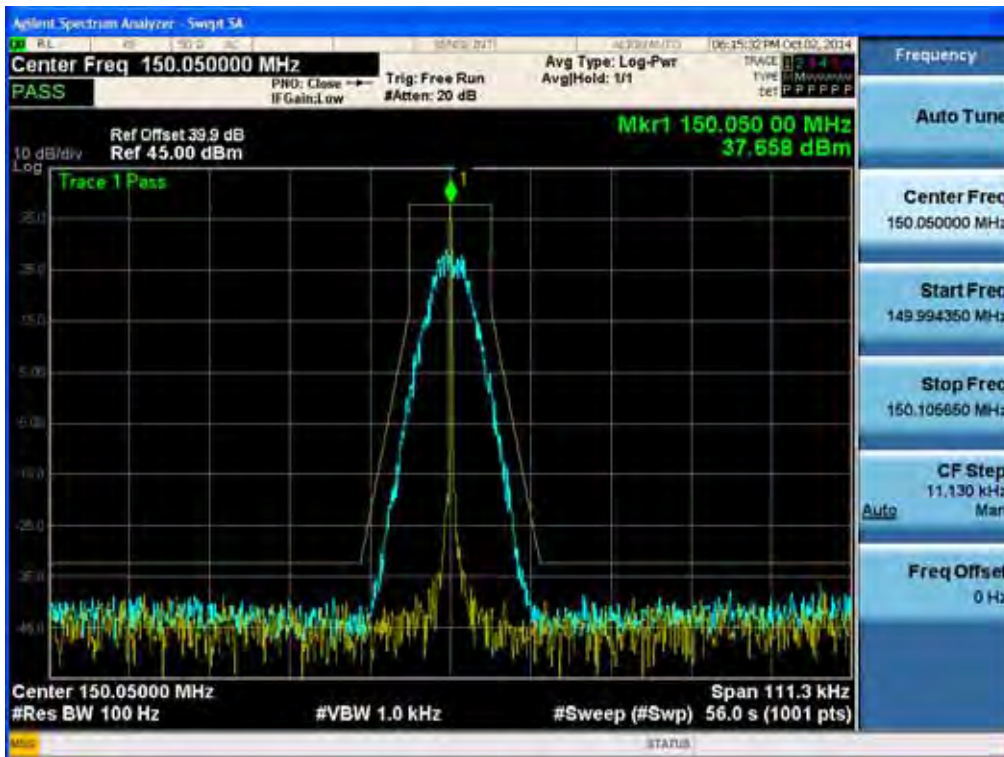

(8K10F1E, 8K10F1D _ 162.05 MHz)_High

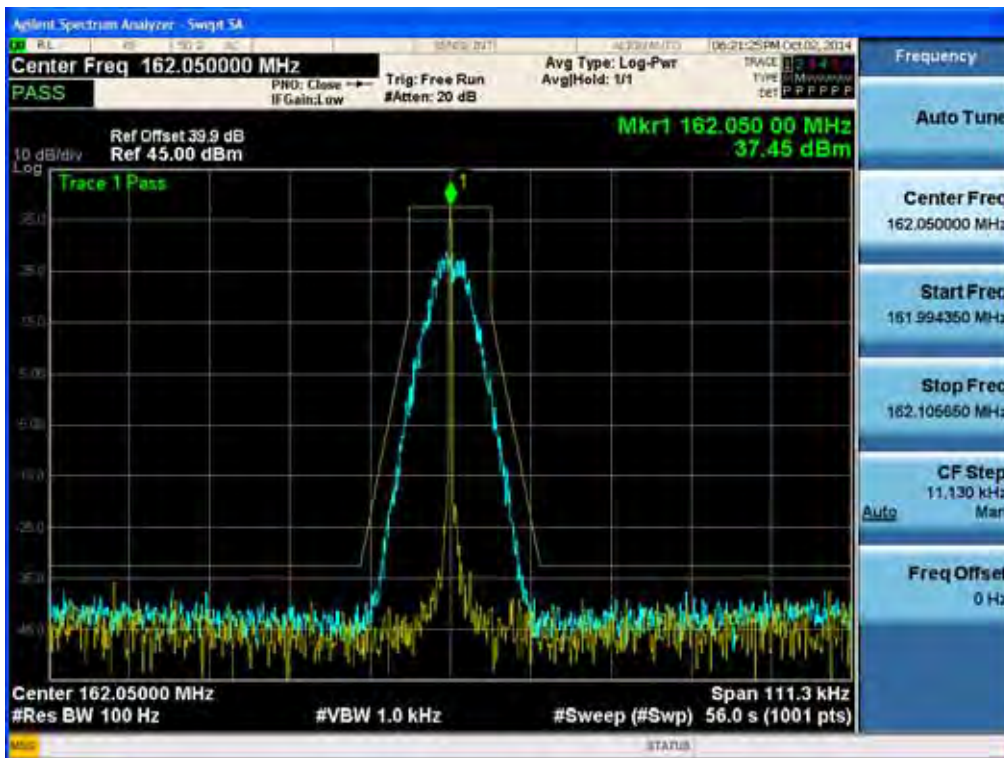

(8K10F1E, 8K10F1D _ 173.95 MHz)_High

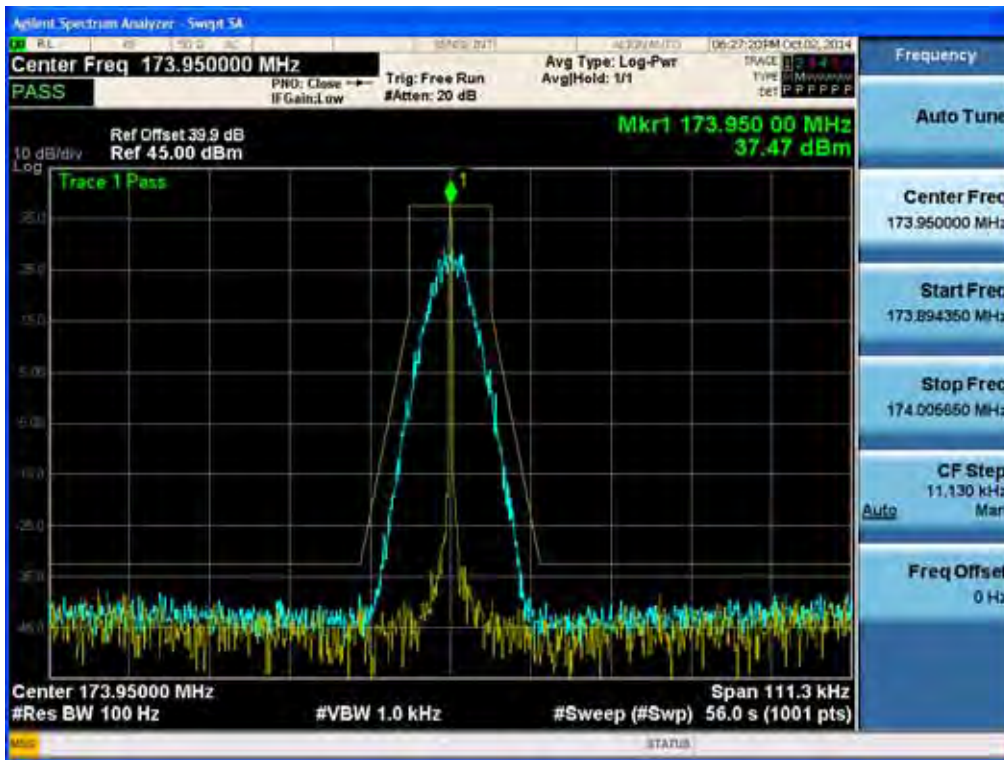

(8K10F1E, 8K10F1D _ 150.05 MHz)_Low

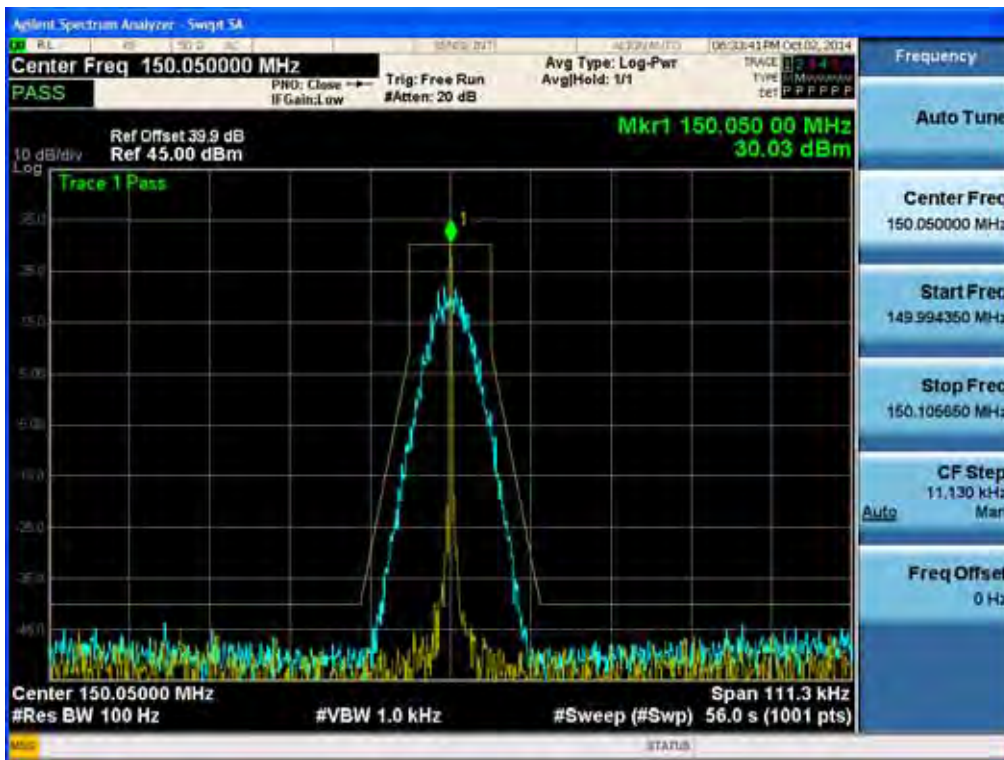

(8K10F1E, 8K10F1D _ 162.05 MHz)_Low

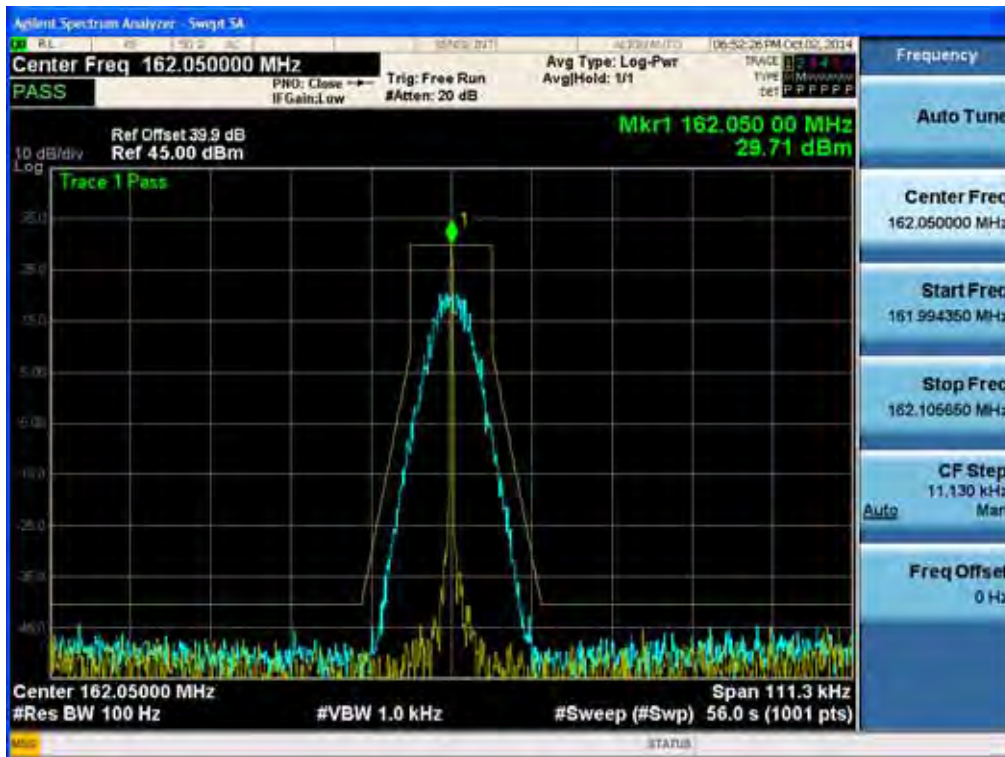

(8K10F1E, 8K10F1D _ 173.95 MHz)_Low

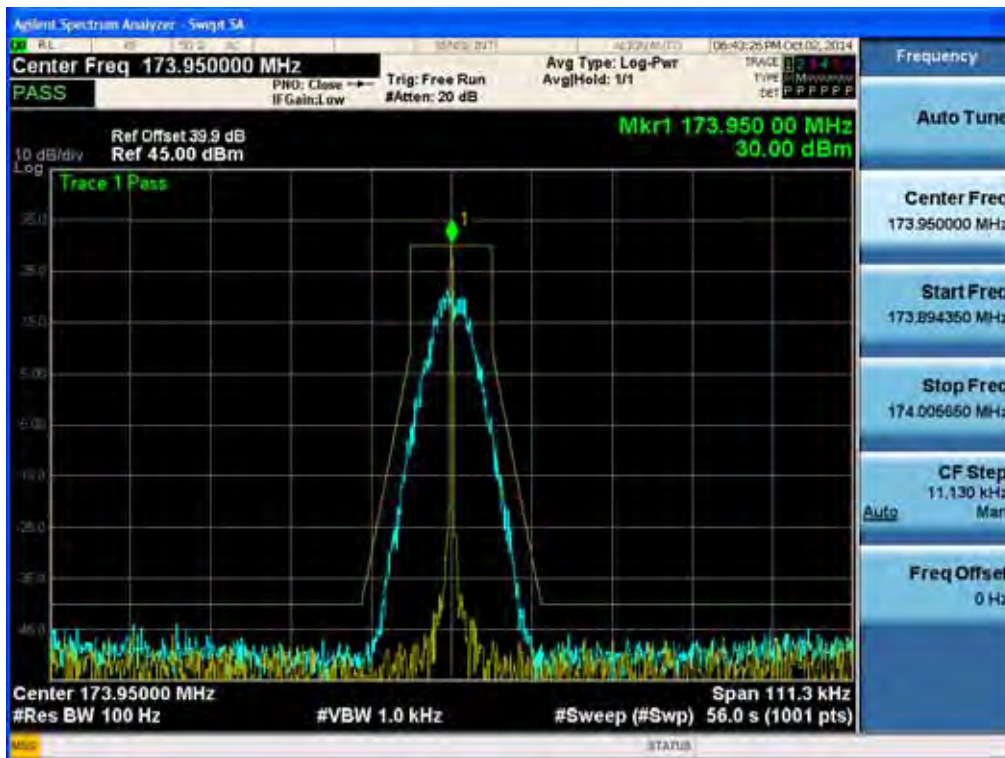

(8K10F1W _ 150.05 MHz)_High

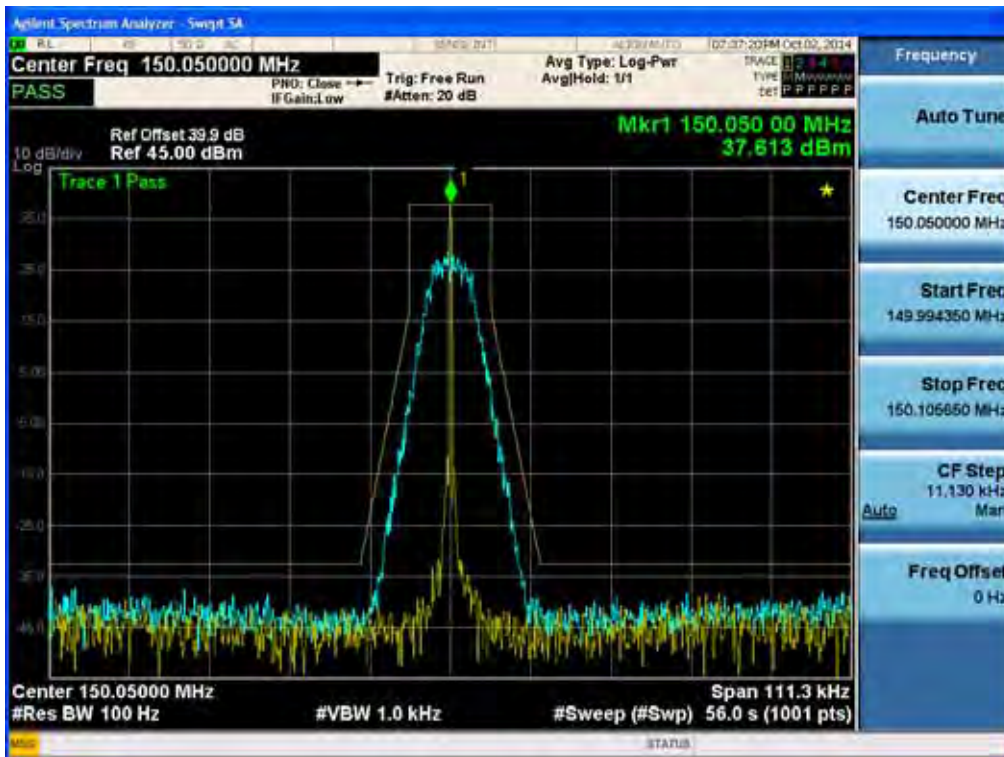

(8K10F1W _ 162.05 MHz)_High

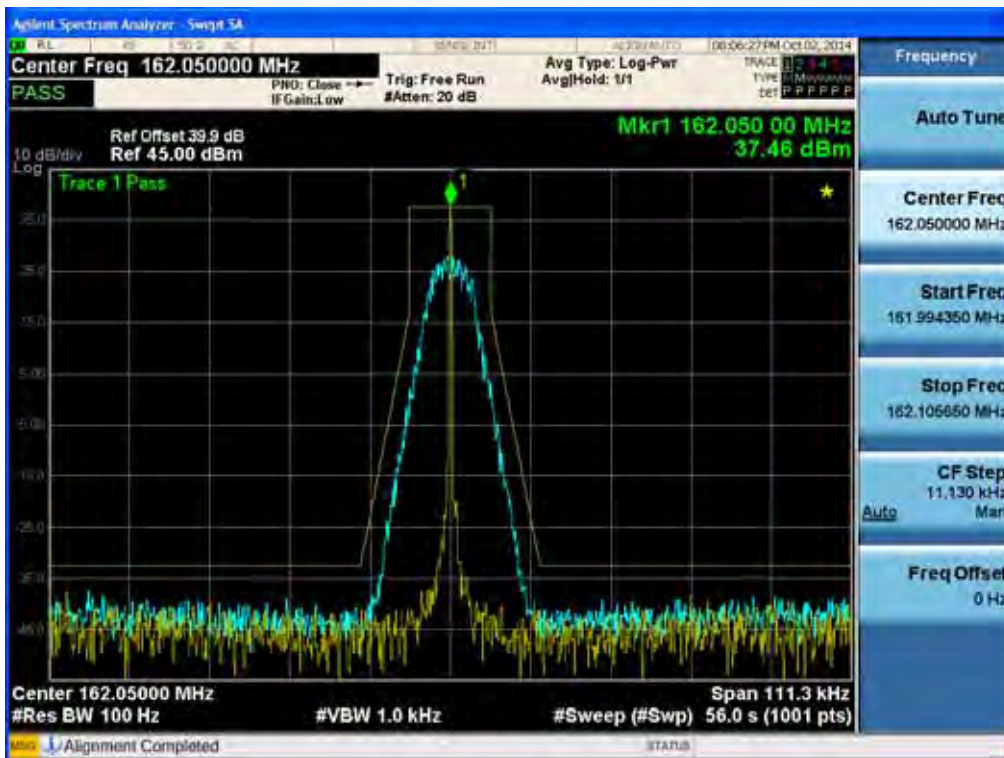

(8K10F1W _ 173.95 MHz)_High

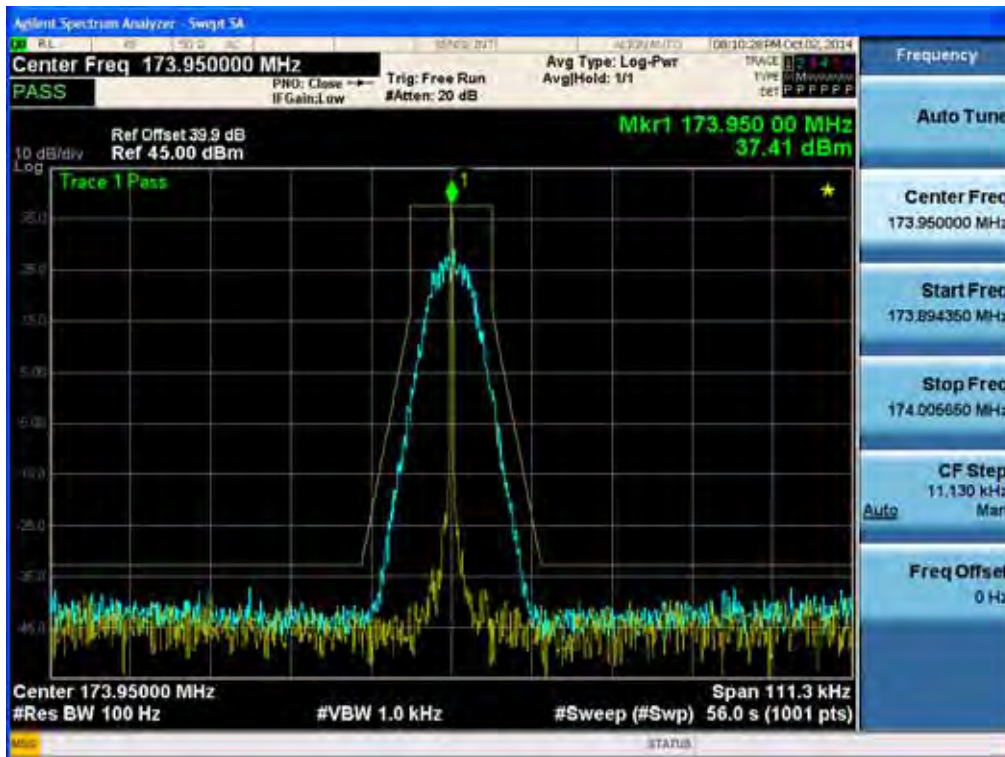

(8K10F1W _ 150.05 MHz)_Low

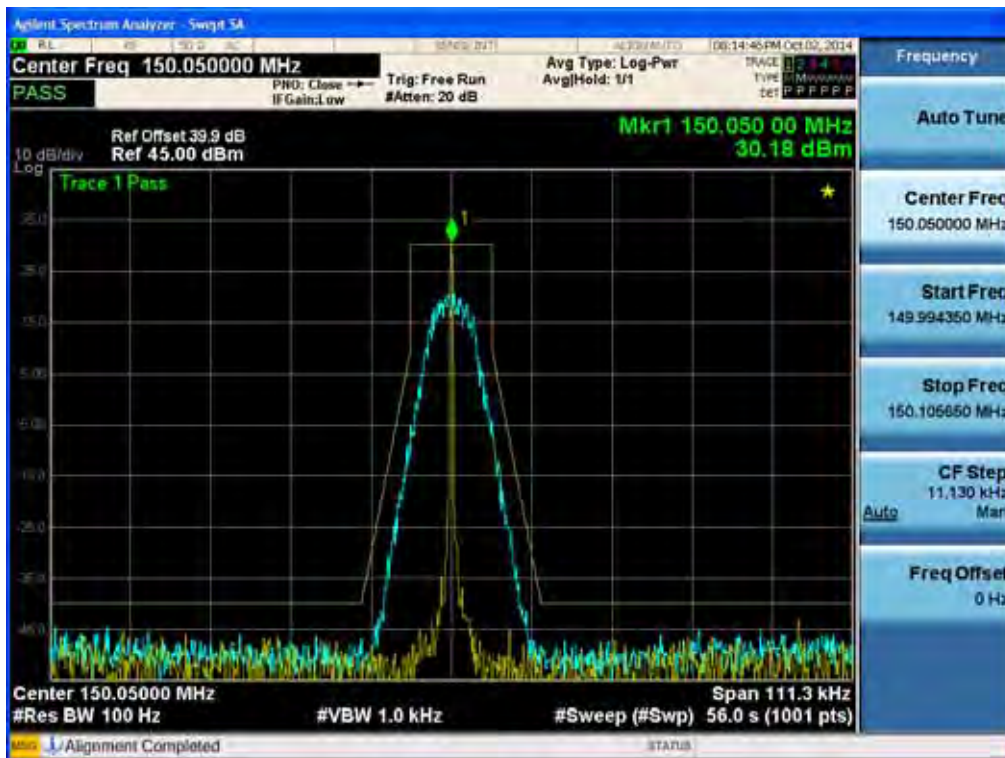

(8K10F1W _ 162.05 MHz)_Low

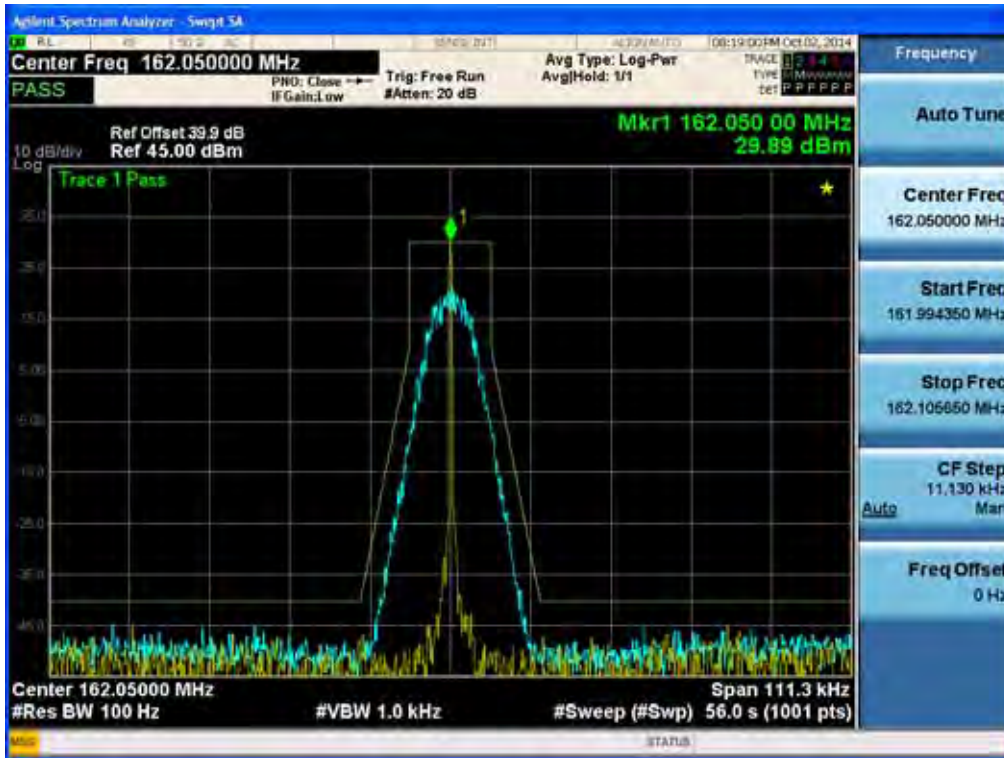

(8K10F1W _ 173.95 MHz)_Low

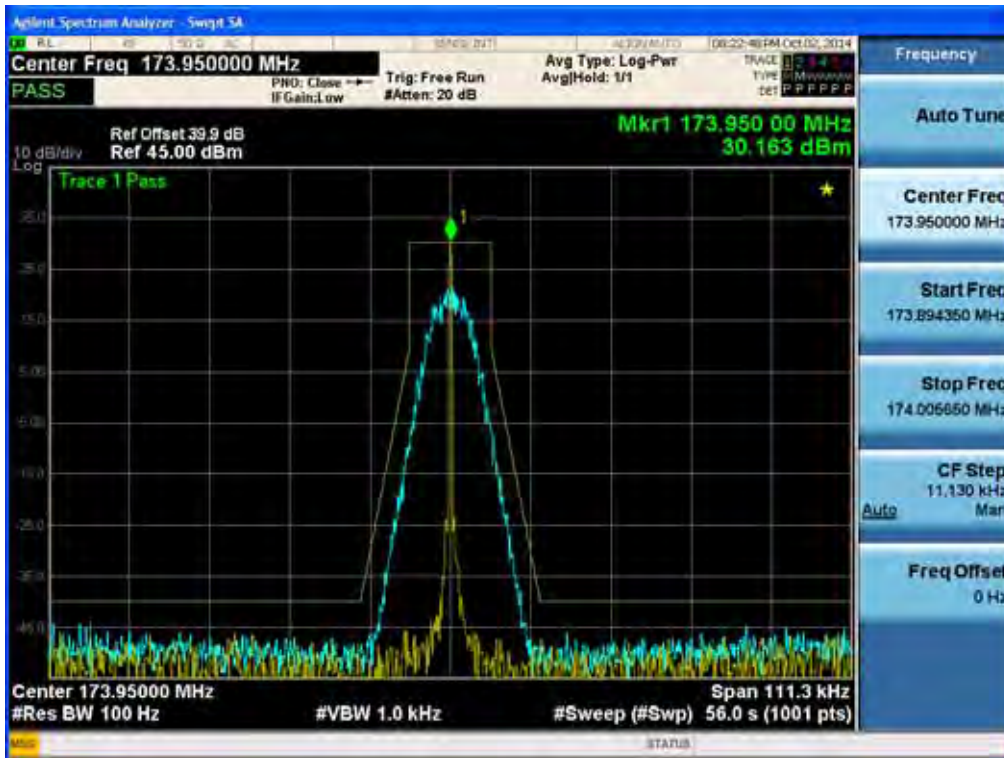

(8K30F1E, 8K30F1D, 8K30F7W _ 150.05 MHz)_High

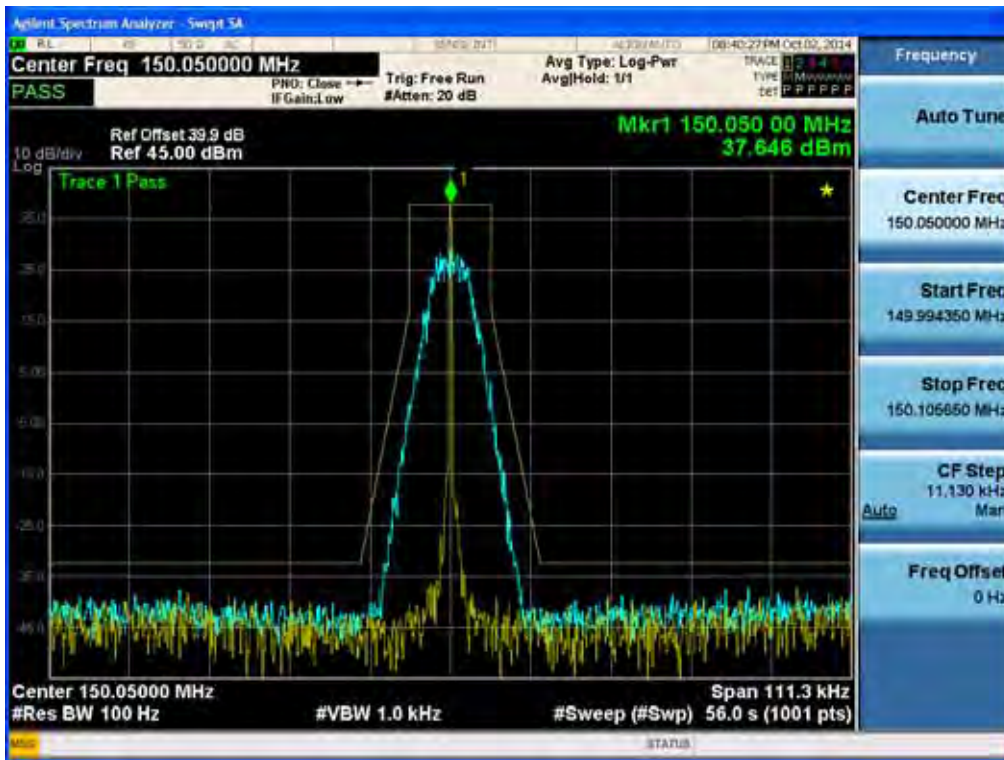

(8K30F1E, 8K30F1D, 8K30F7W _ 162.05 MHz)_High

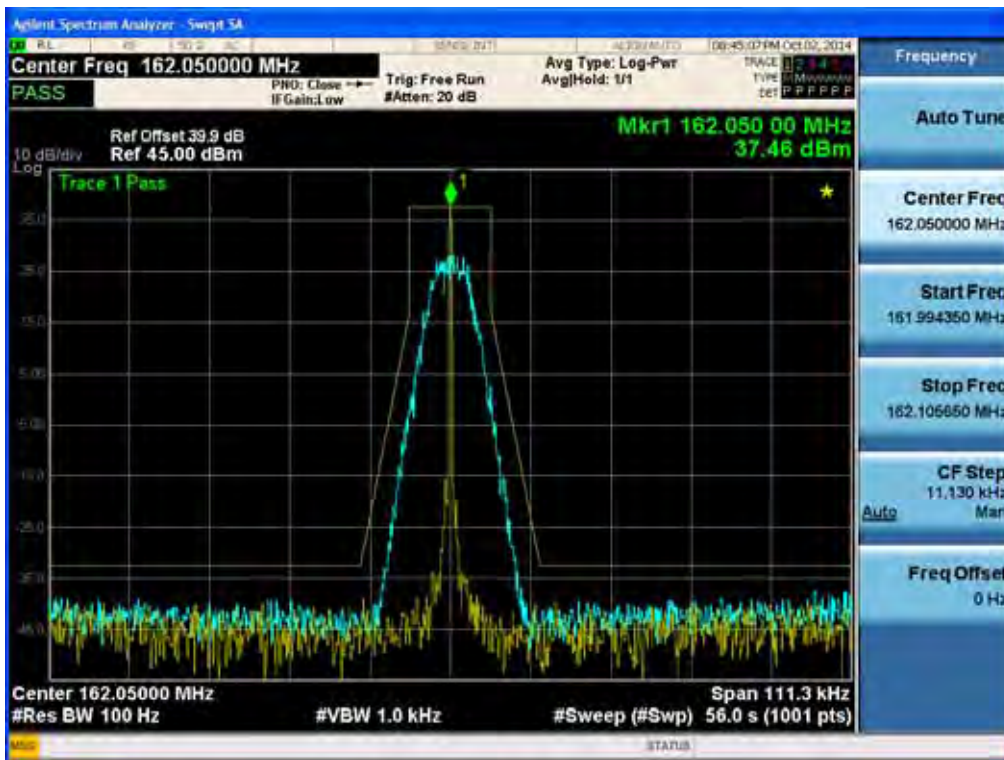

(8K30F1E, 8K30F1D, 8K30F7W _ 173.95 MHz)_High

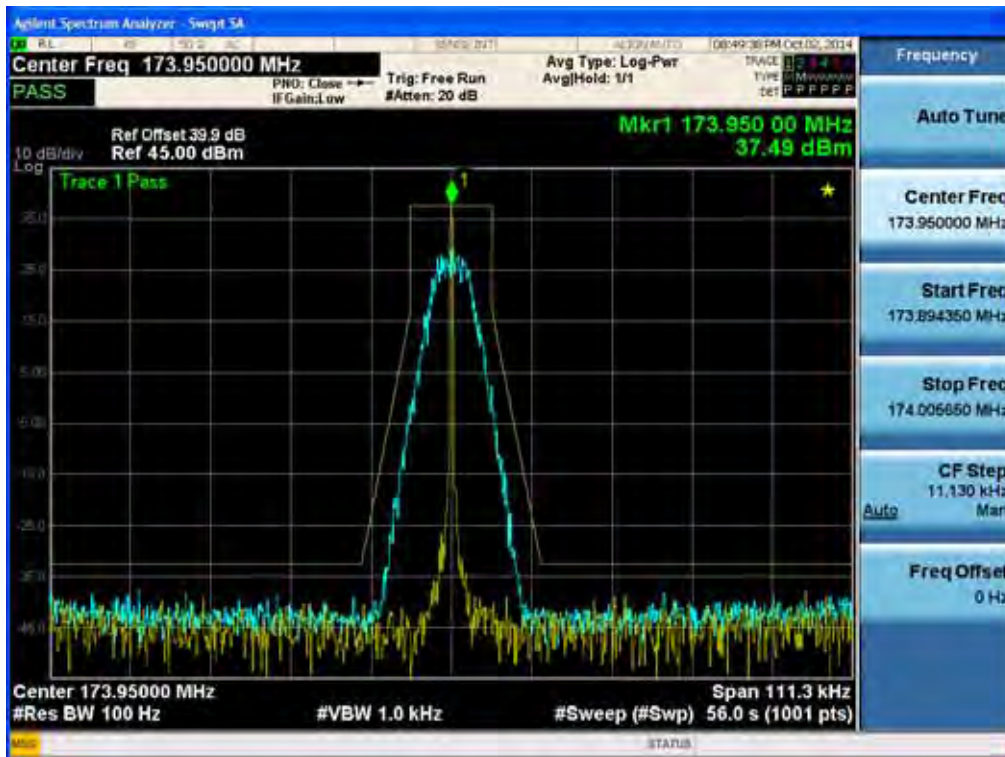

(8K30F1E, 8K30F1D, 8K30F7W _ 150.05 MHz)_Low

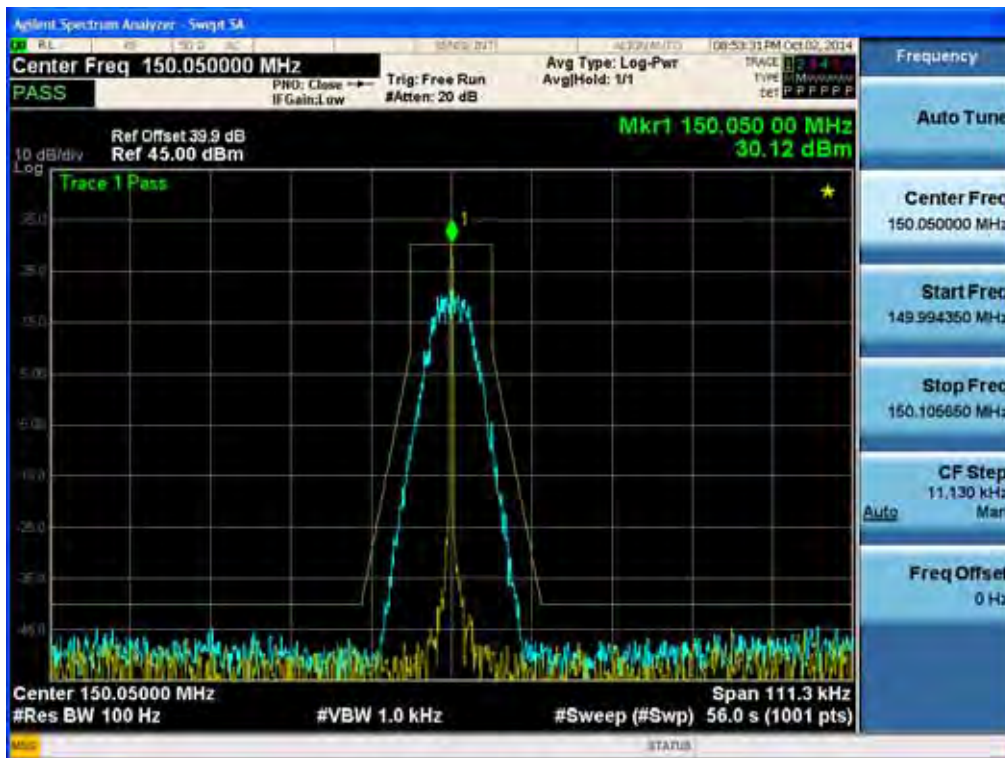

(8K30F1E, 8K30F1D, 8K30F7W _ 162.05 MHz)_Low



(8K30F1E, 8K30F1D, 8K30F7W _ 173.95 MHz)_Low

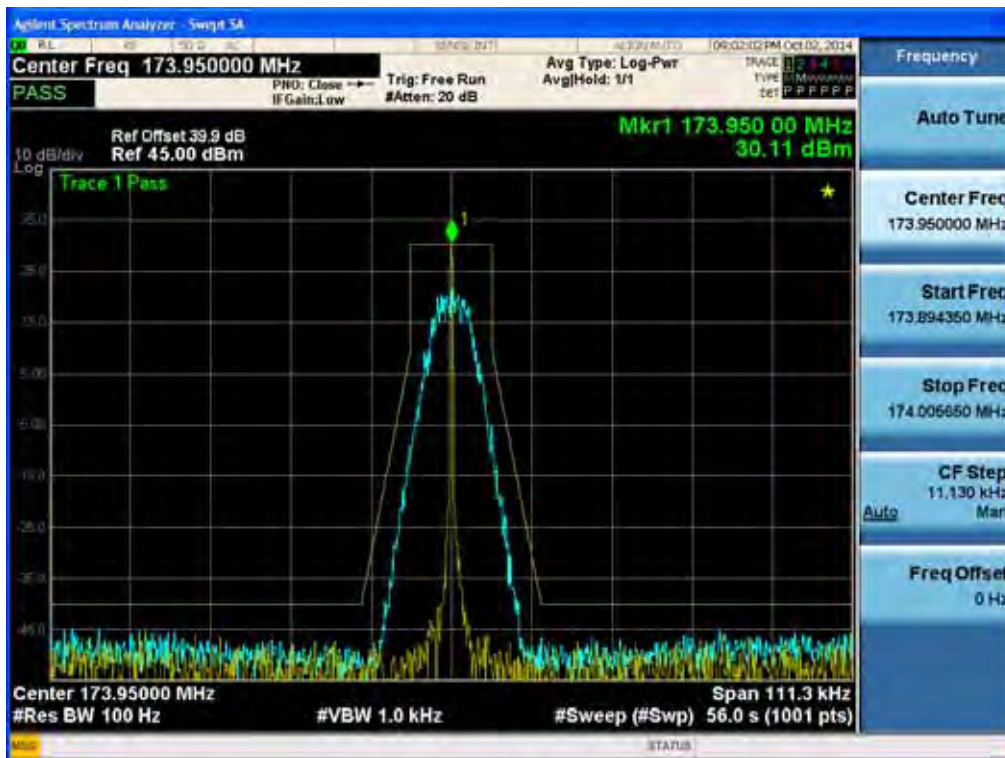

(4K00F1E, 4K00F1D, 4K00F7W _ 150.05 MHz)_High

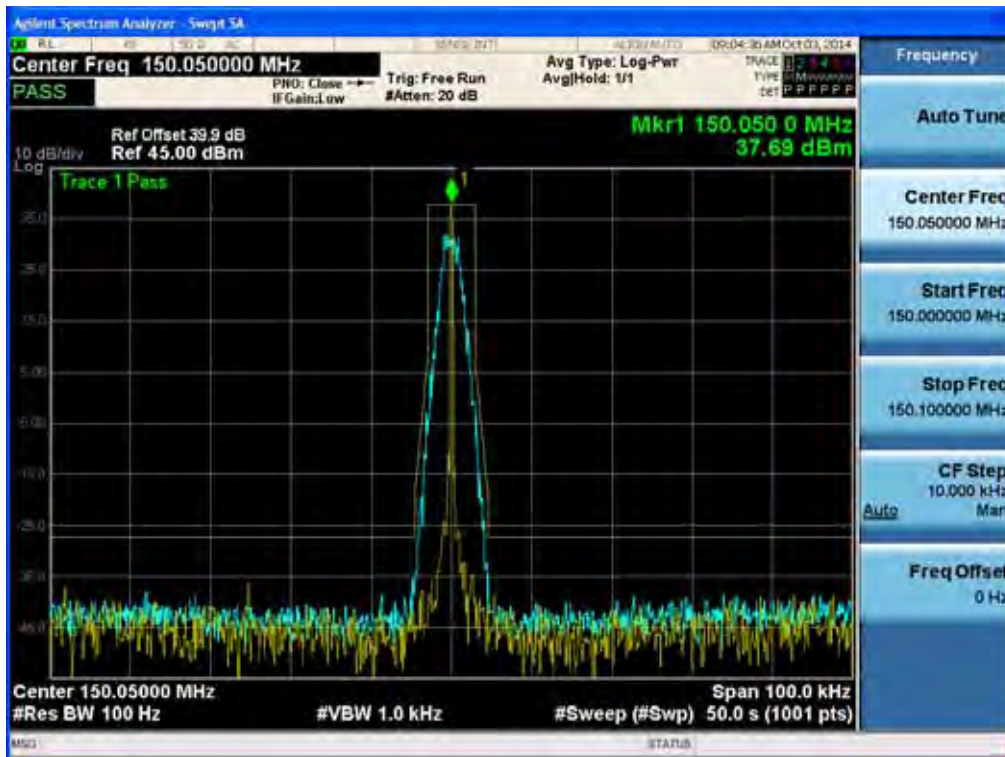

(4K00F1E, 4K00F1D, 4K00F7W _ 162.05 MHz)_High

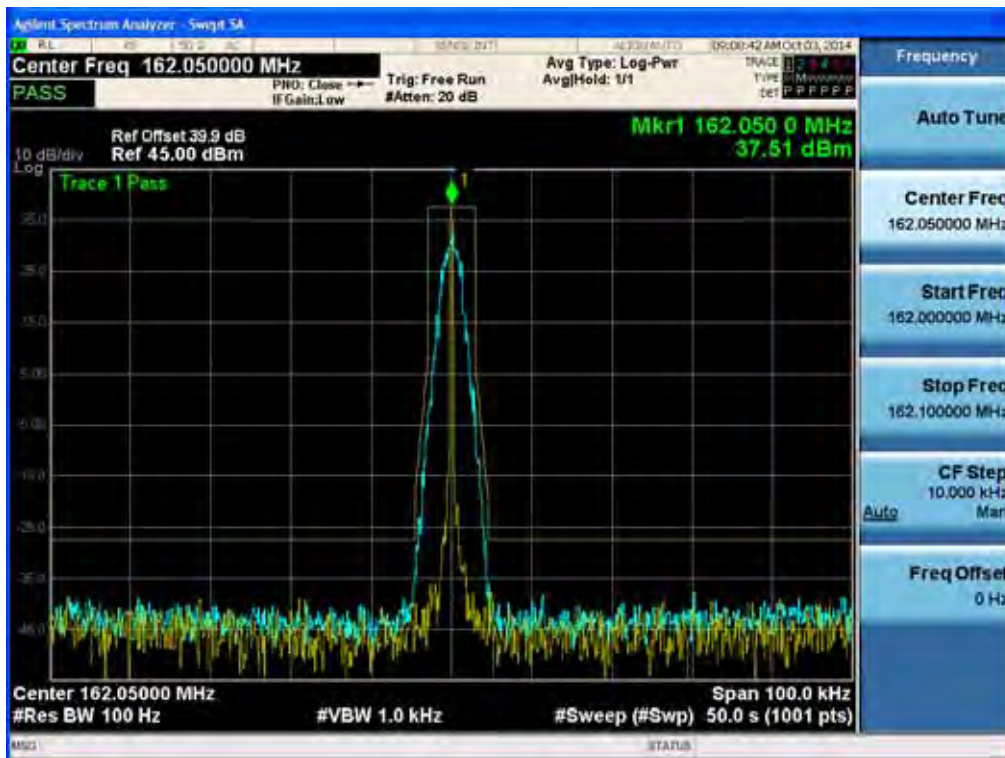

(4K00F1E, 4K00F1D, 4K00F7W _ 173.95 MHz)_High

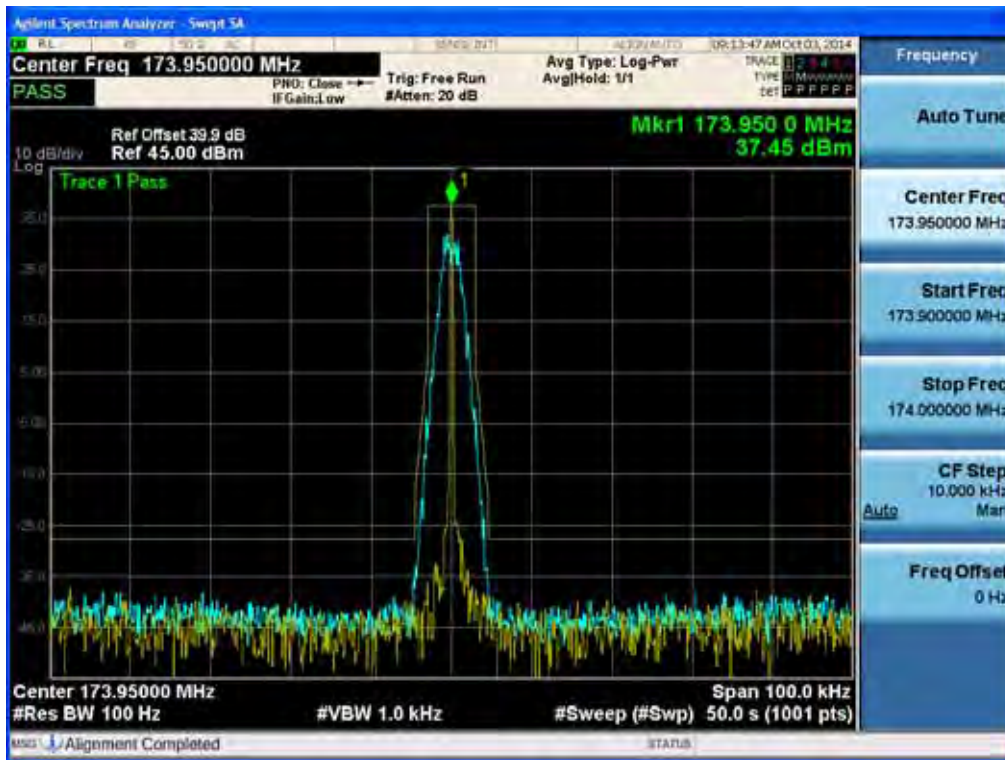

(4K00F1E, 4K00F1D, 4K00F7W _ 150.05 MHz)_Low

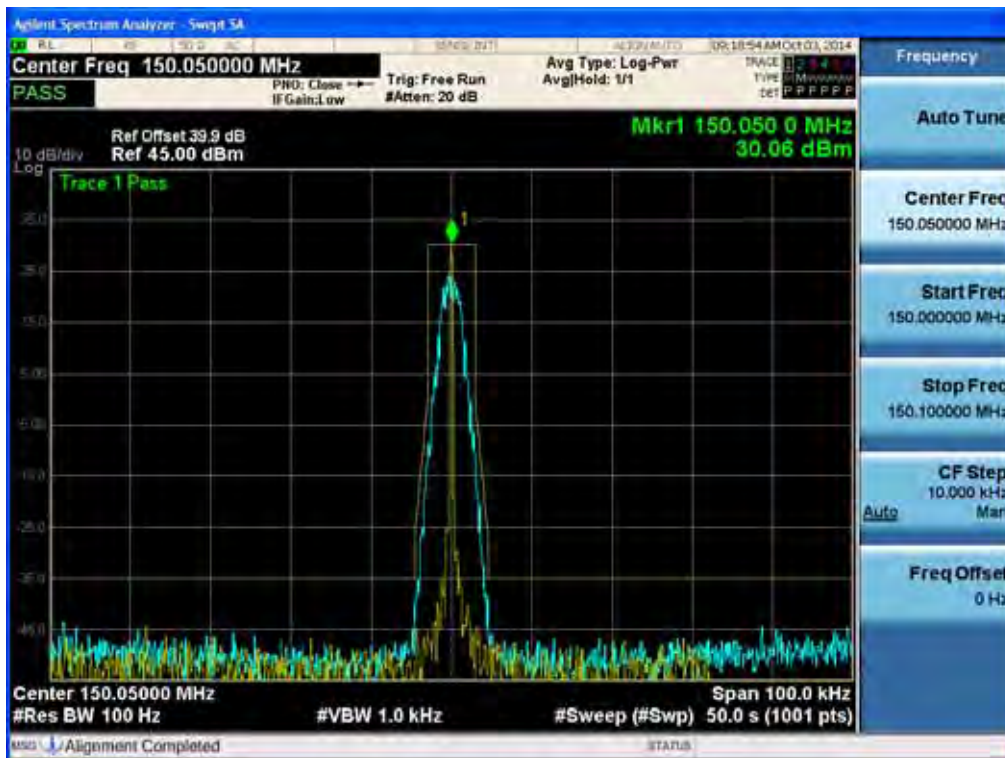

(4K00F1E, 4K00F1D, 4K00F7W _ 162.05 MHz)_Low



(4K00F1E, 4K00F1D, 4K00F7W _ 173.95 MHz)_Low

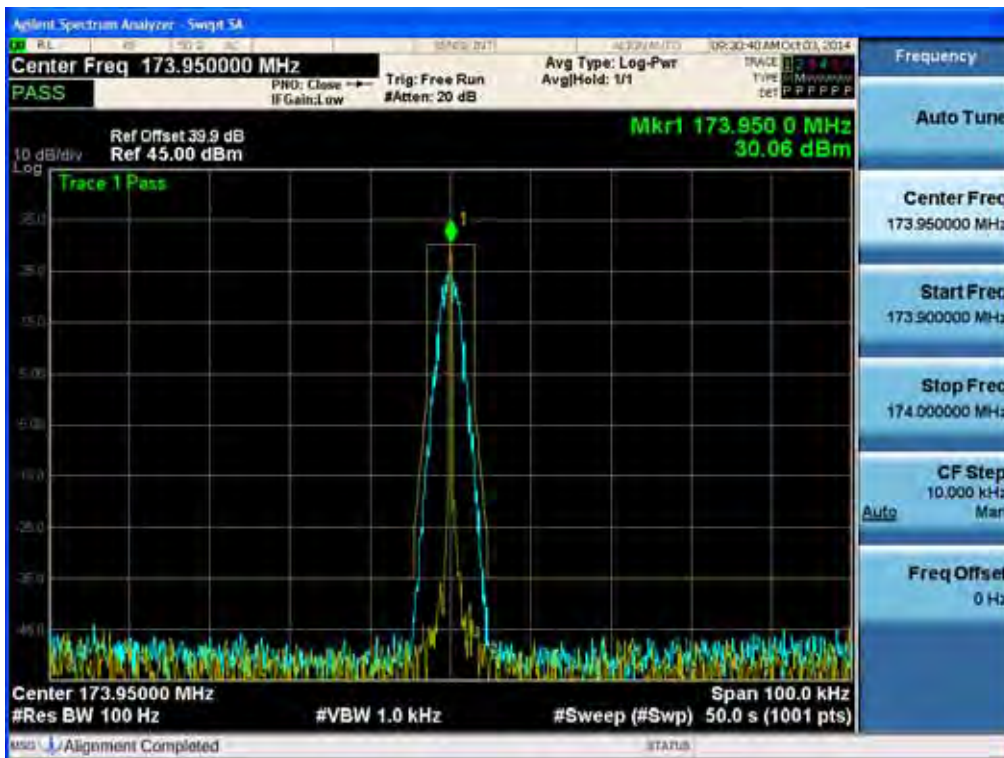

(4K00F2D _ 150.05 MHz)_Low

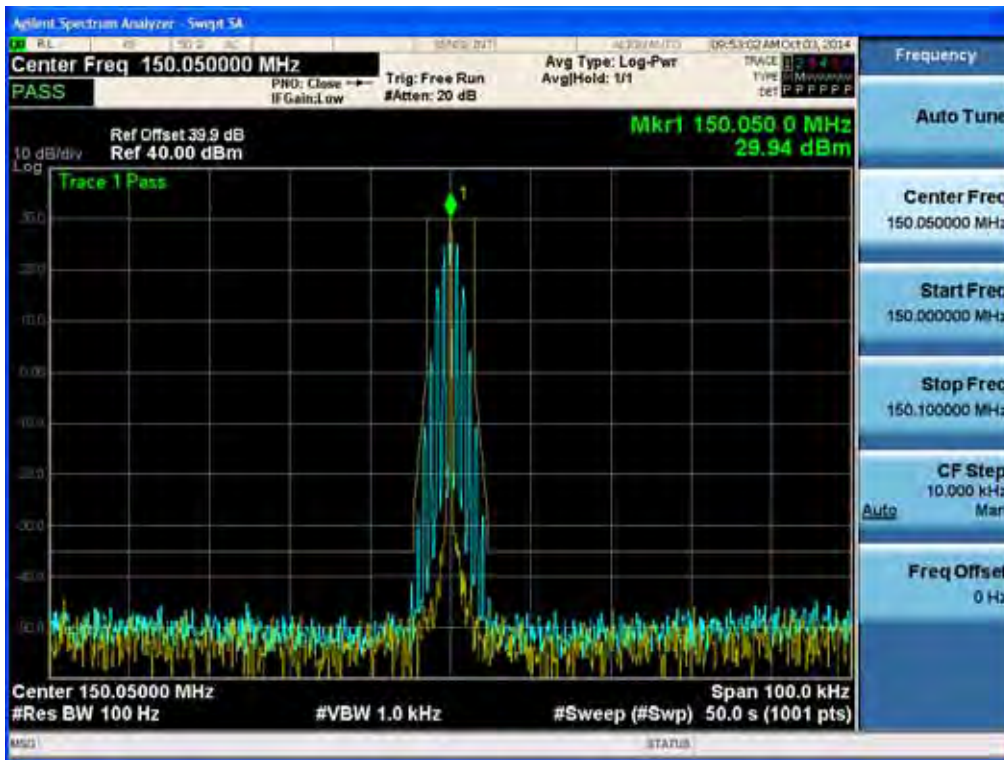

(4K00F2D _ 162.05 MHz)_Low

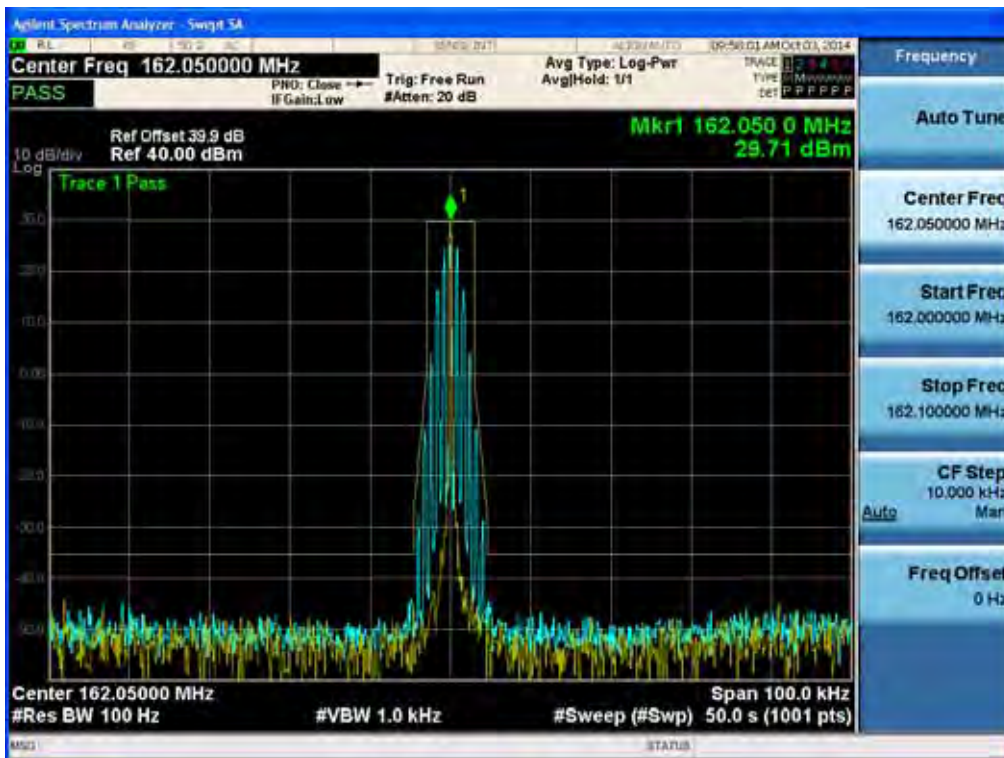

(4K00F2D _ 173.95 MHz)_Low

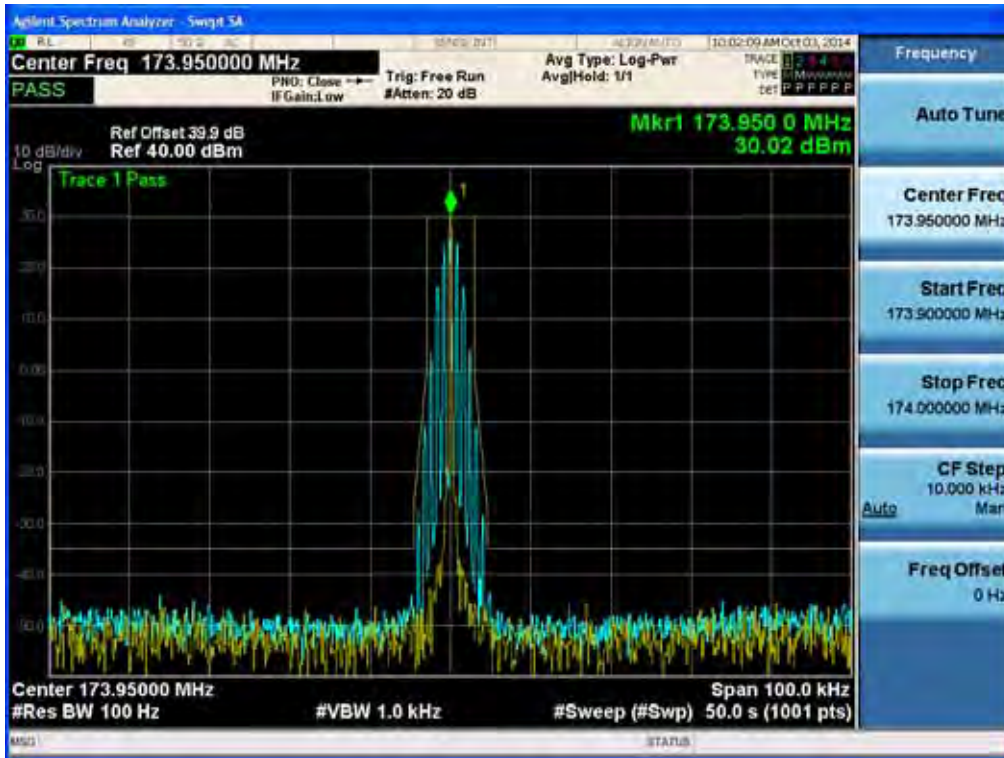

Plots of Emission Mask IC

(16K0F3E _ 138.05 MHz)_High

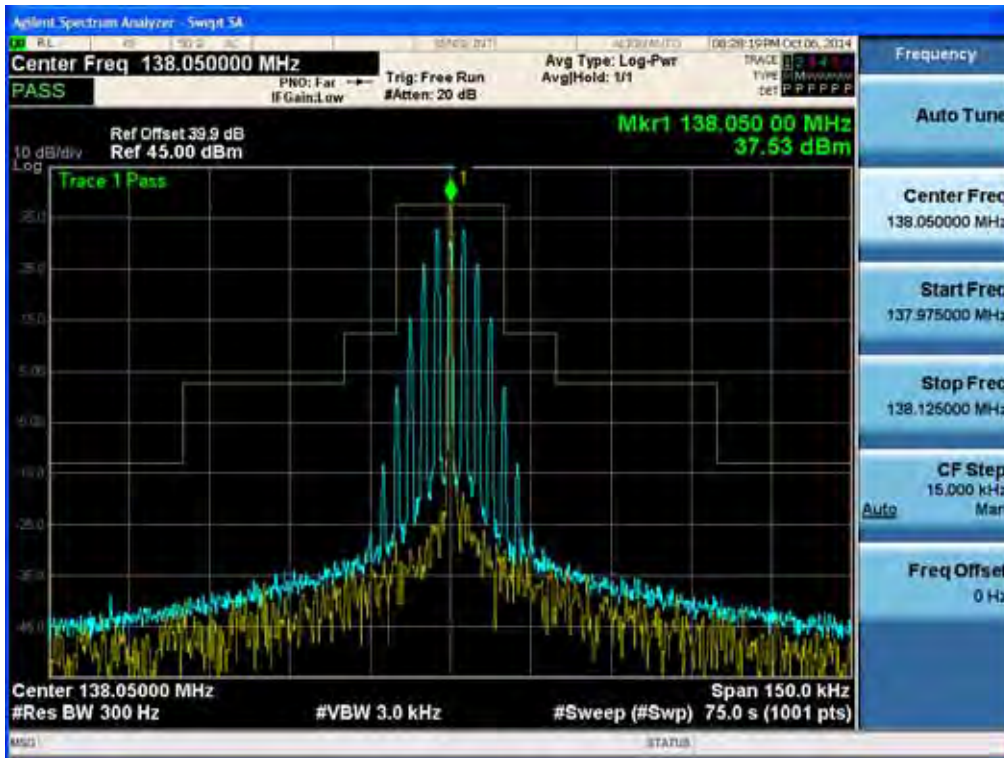

(16K0F3E _ 143.95 MHz)_High

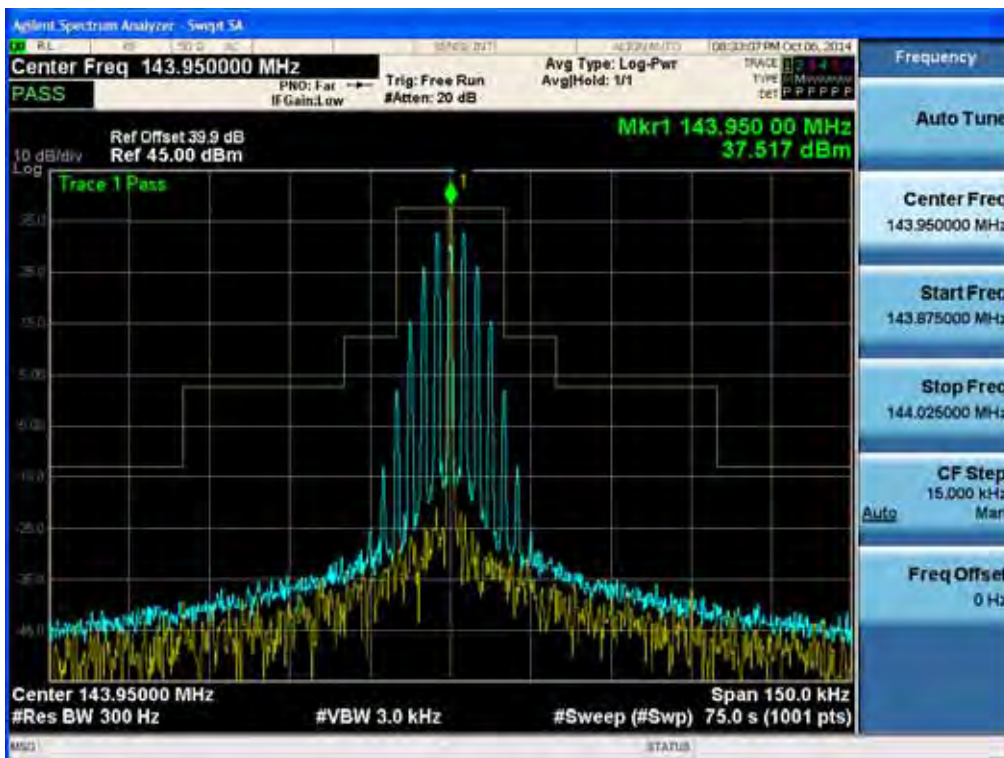

(16K0F3E _ 148.05 MHz)_High

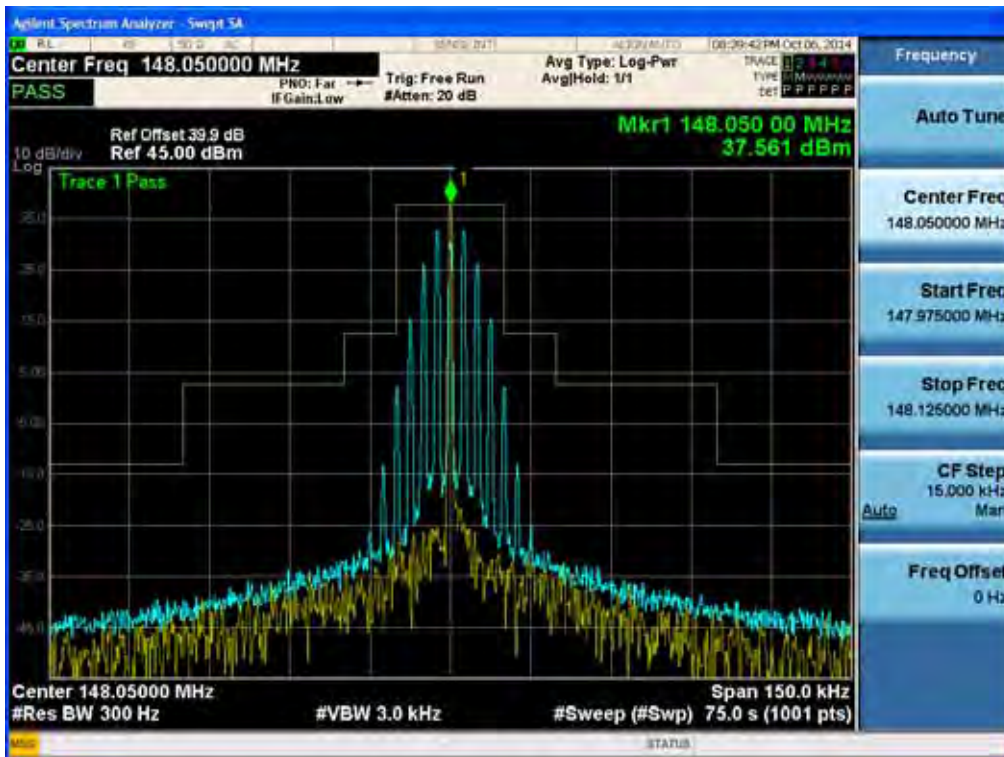

(16K0F3E _ 138.05 MHz)_Low

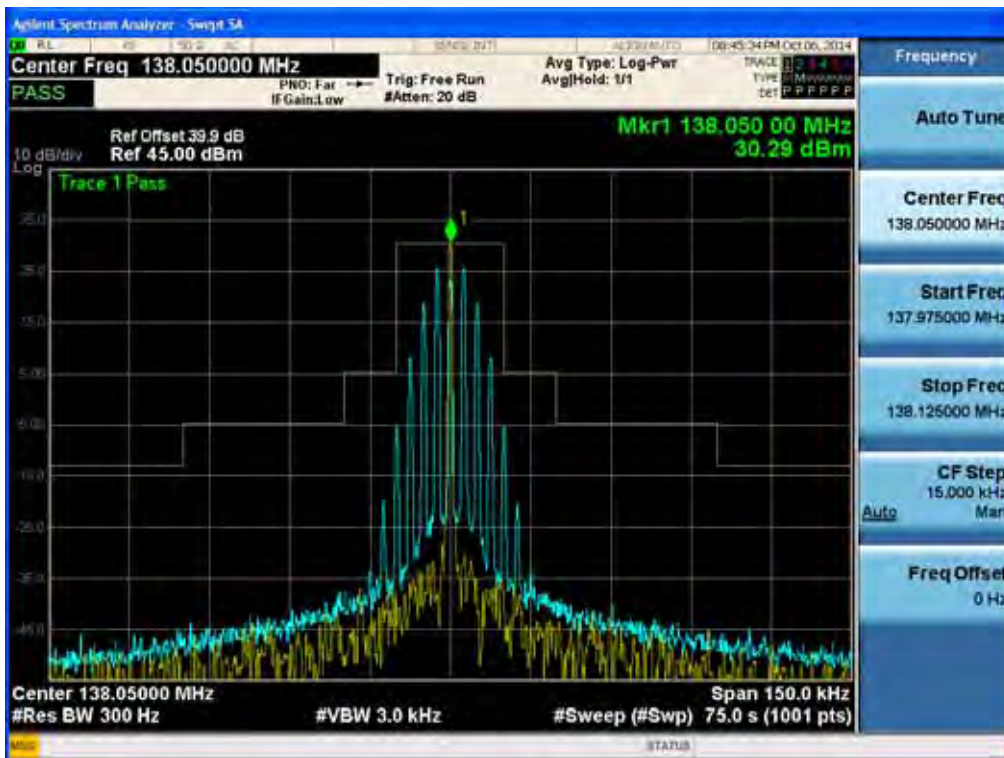

(16K0F3E _ 143.95 MHz)_Low

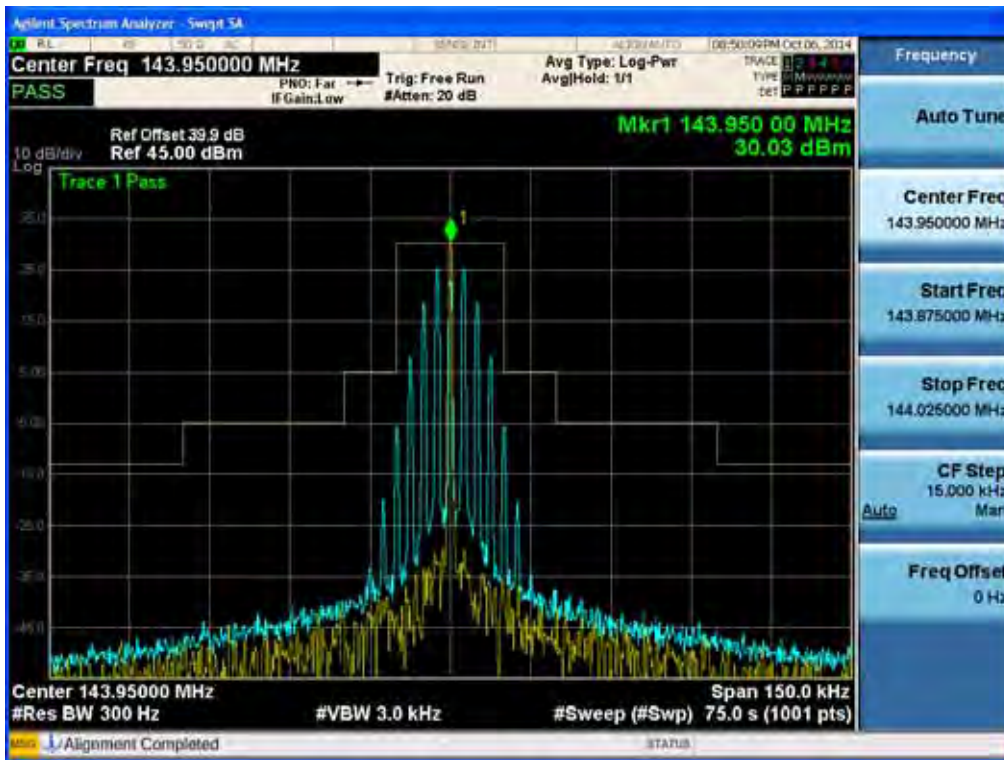

(16K0F3E _ 148.05 MHz)_Low

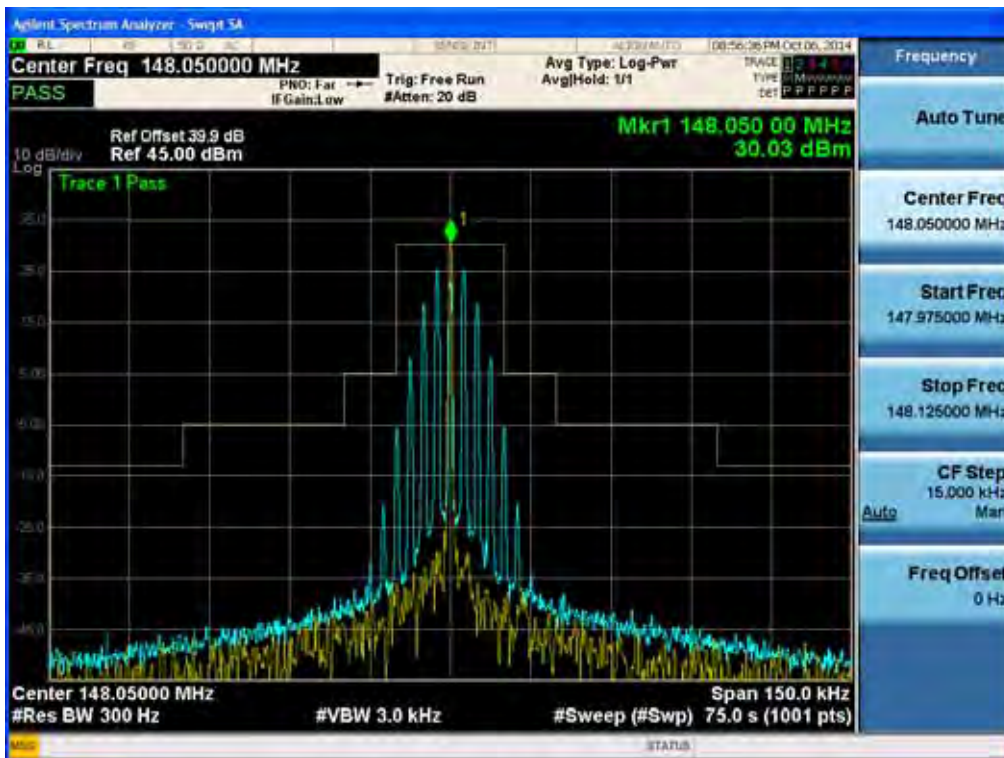

(11K0F3E _ 138.05 MHz)_High

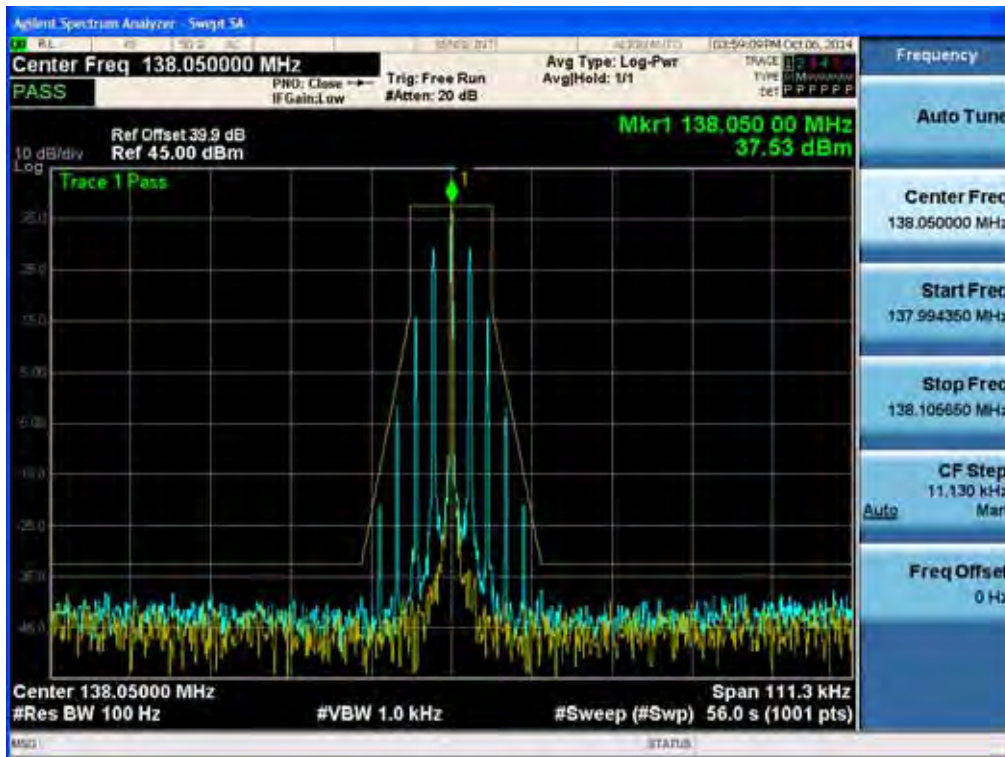

(11K0F3E _ 143.95 MHz)_High

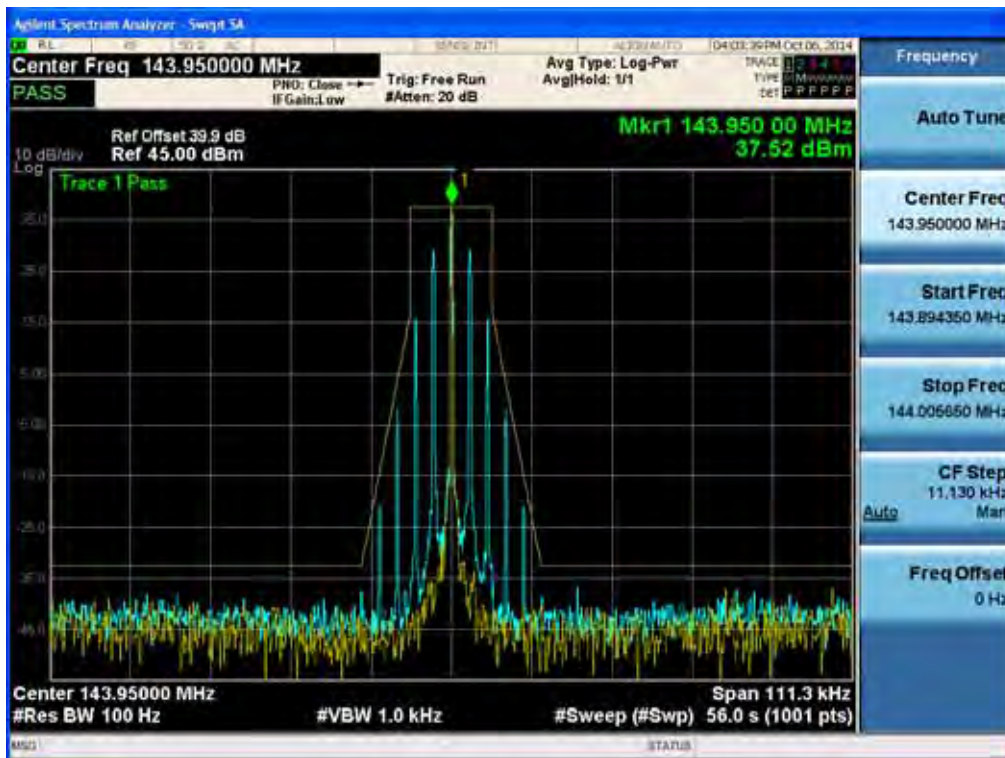

(11K0F3E _ 148.05 MHz)_High

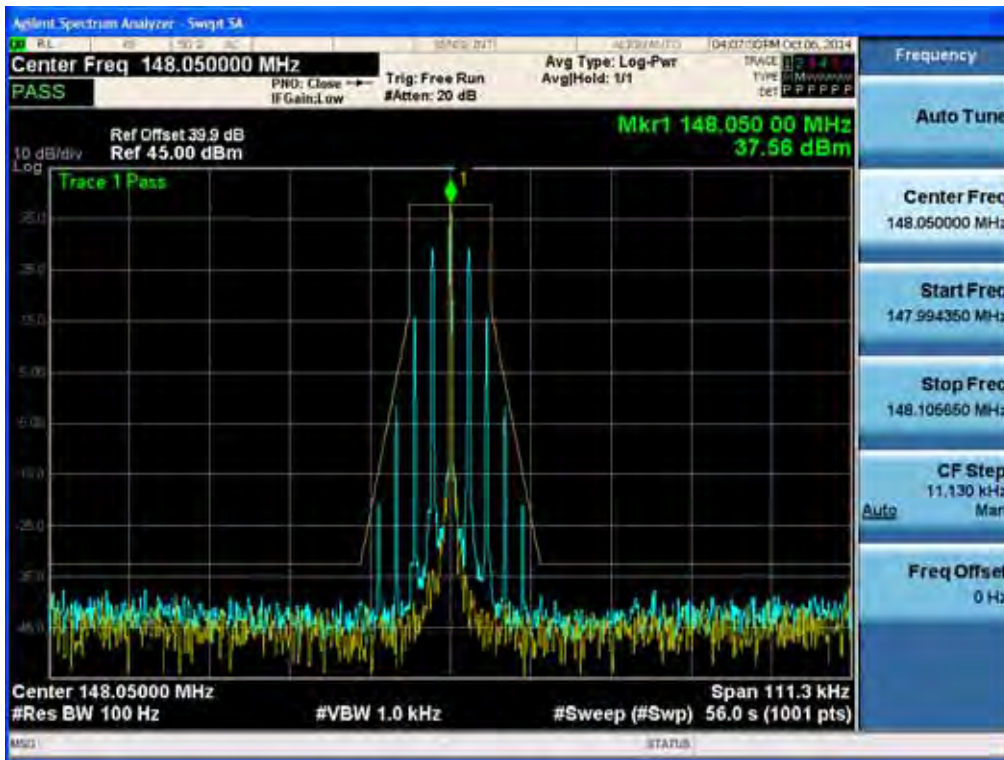

(11K0F3E _ 138.05 MHz)_Low

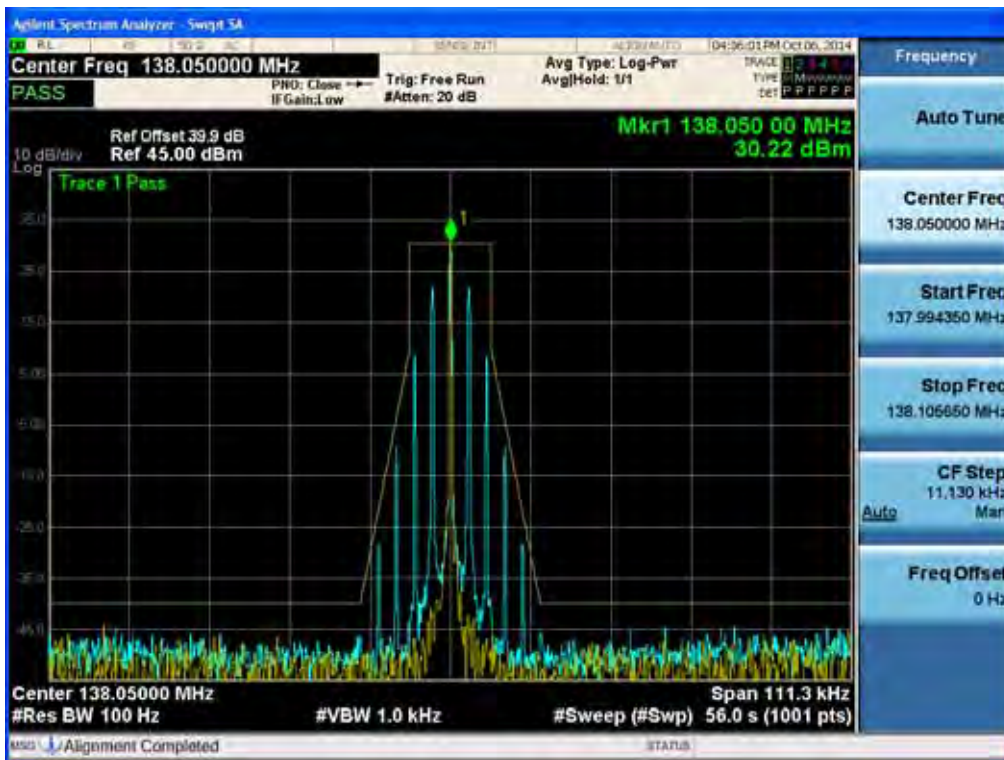

(11K0F3E _ 143.95 MHz)_Low

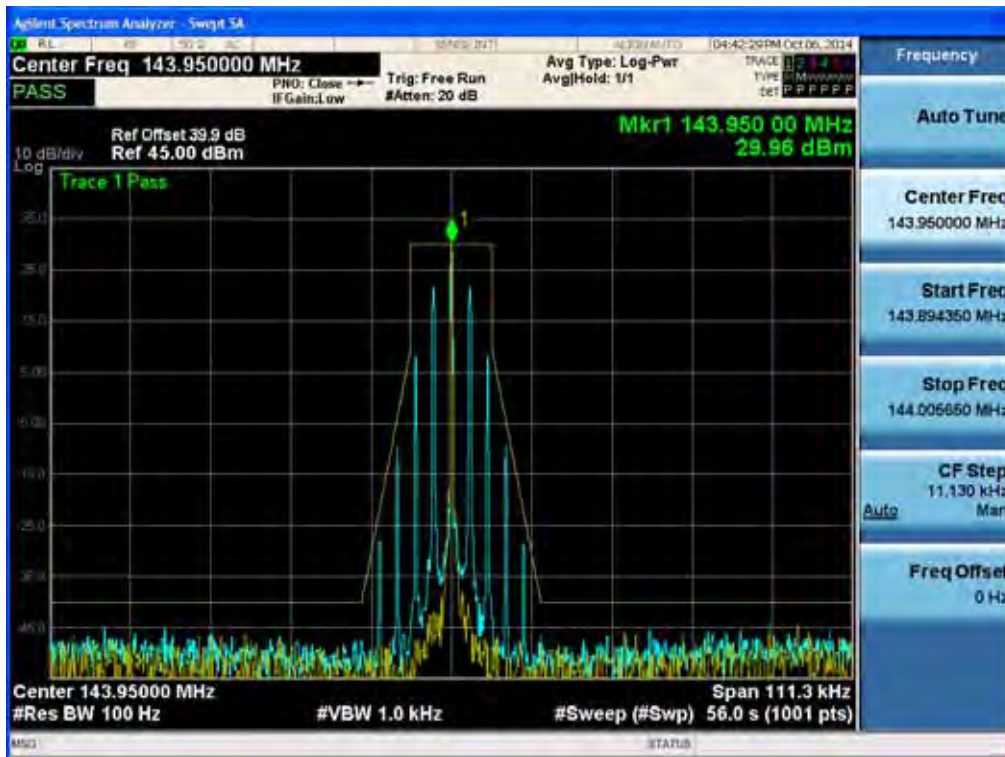

(11K0F3E _ 148.05 MHz)_Low

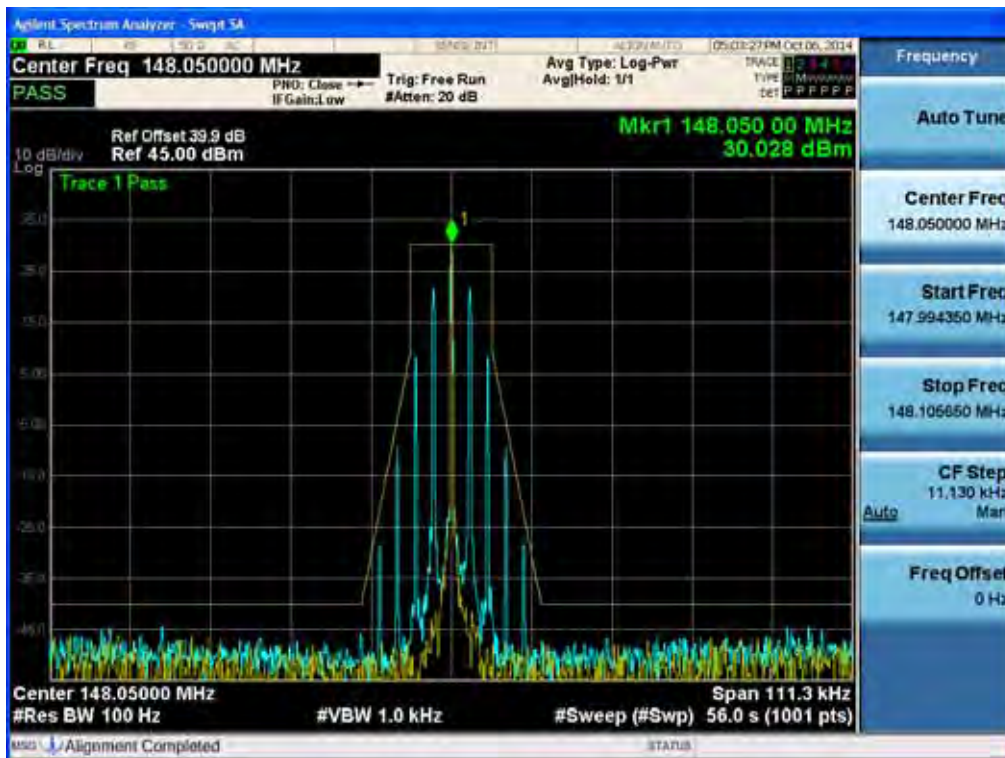

(8K10F1E, 8K10F1D _ 138.05 MHz)_High

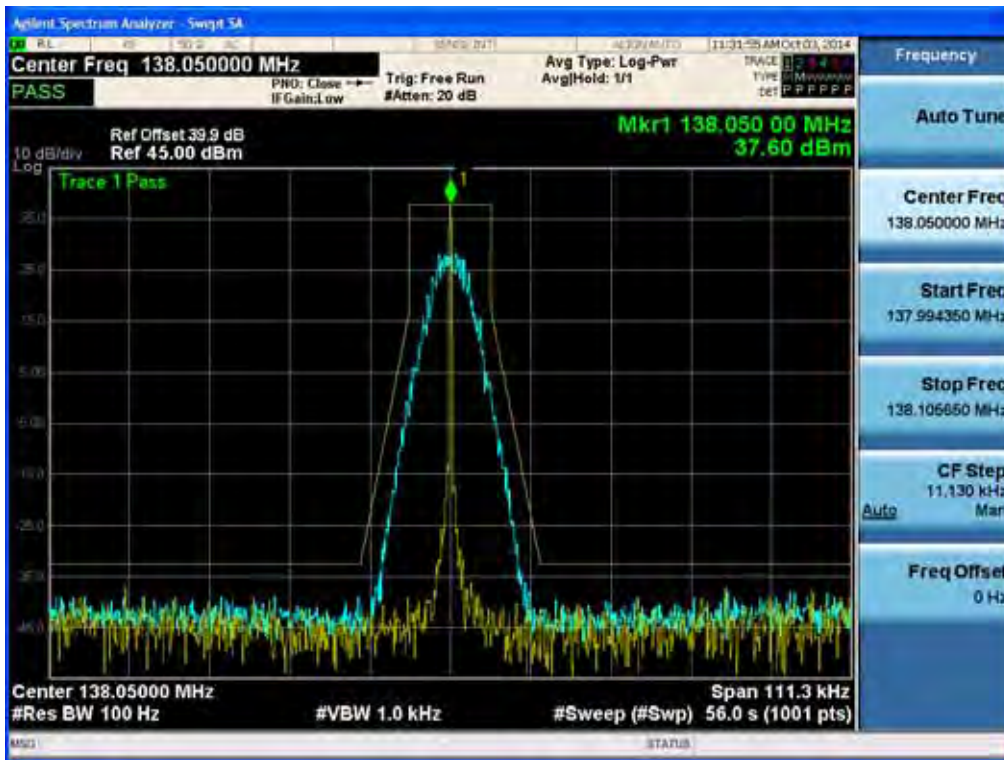

(8K10F1E, 8K10F1D _ 143.95 MHz)_High

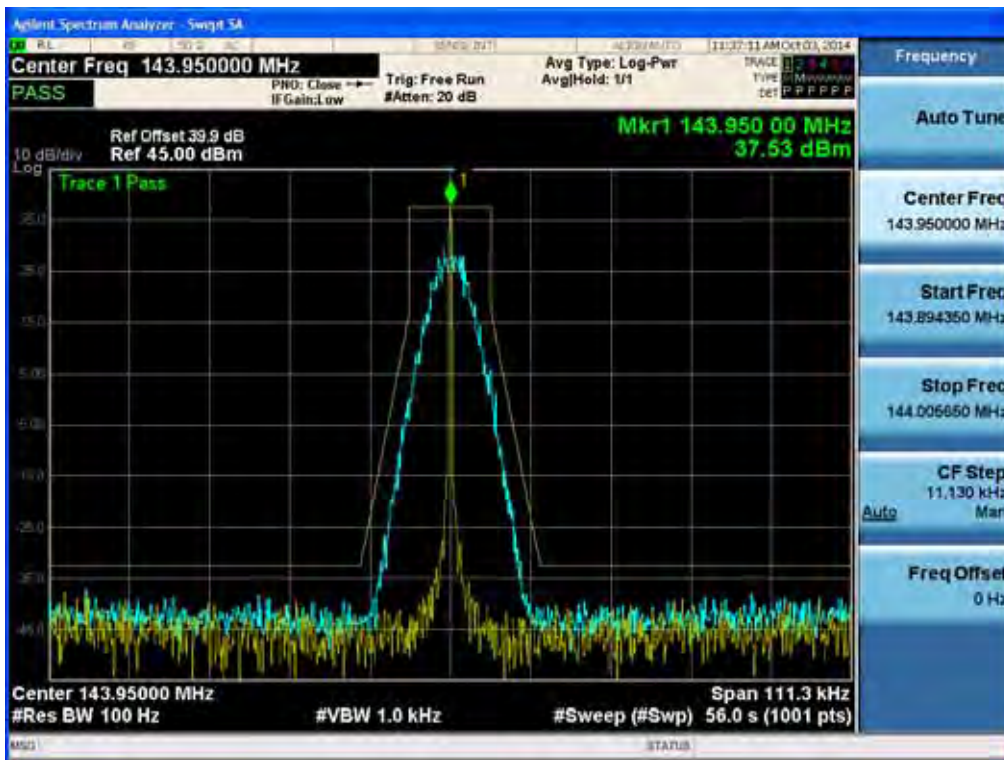

(8K10F1E, 8K10F1D _ 148.05 MHz)_High

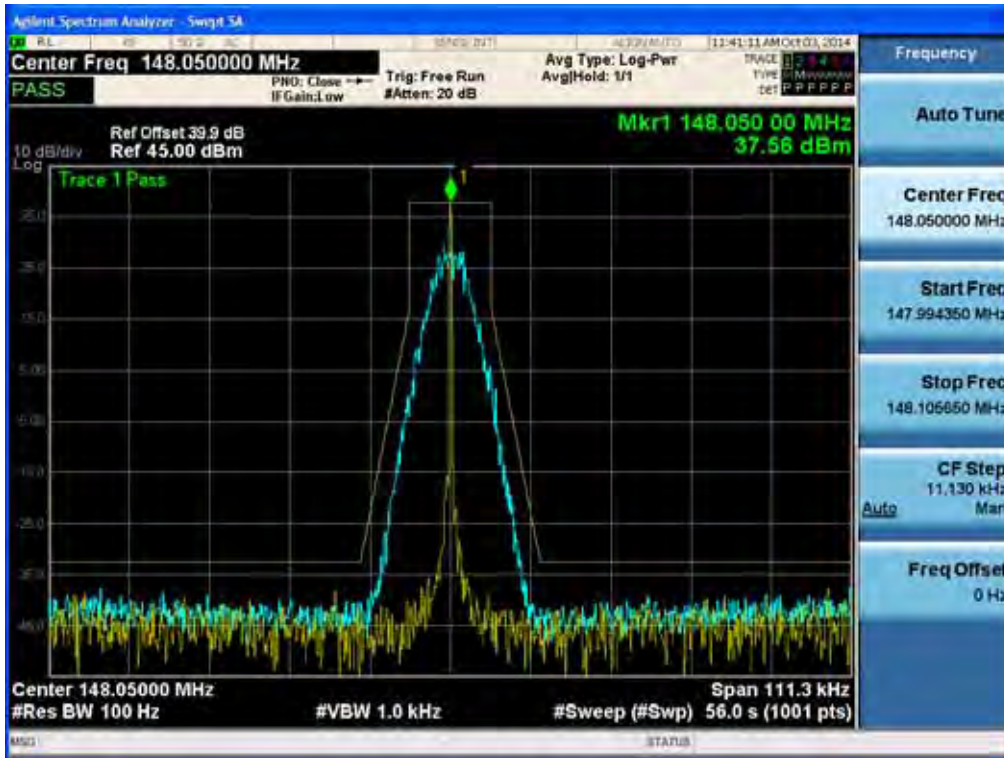

(8K10F1E, 8K10F1D _ 138.05 MHz)_Low

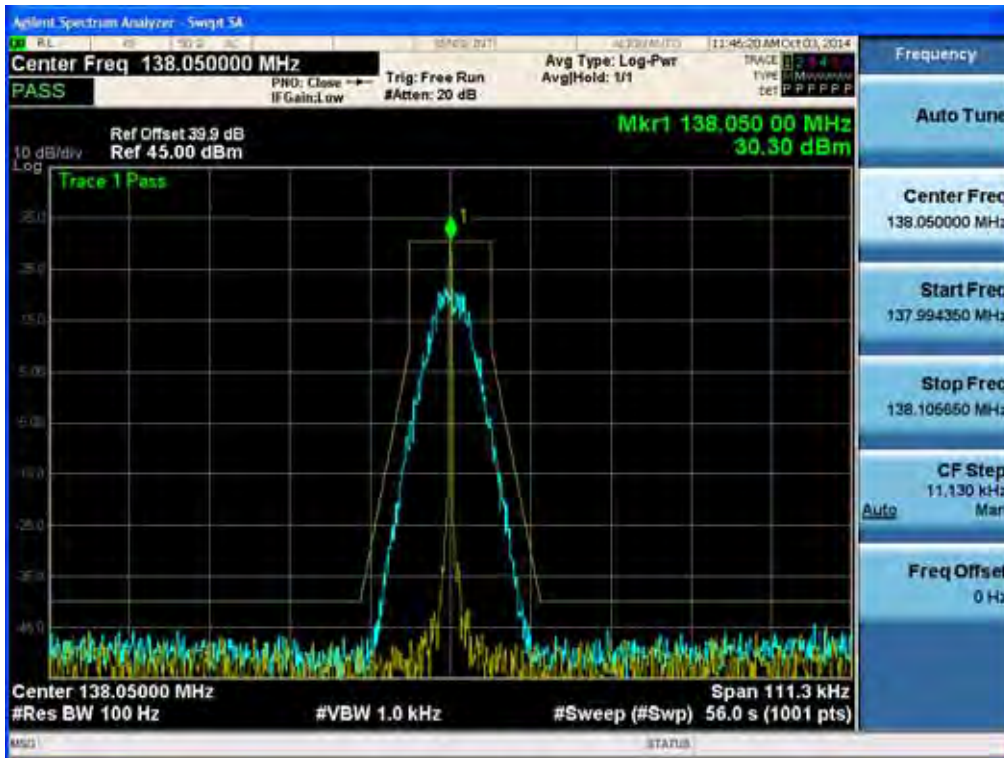

(8K10F1E, 8K10F1D _ 143.95 MHz)_Low

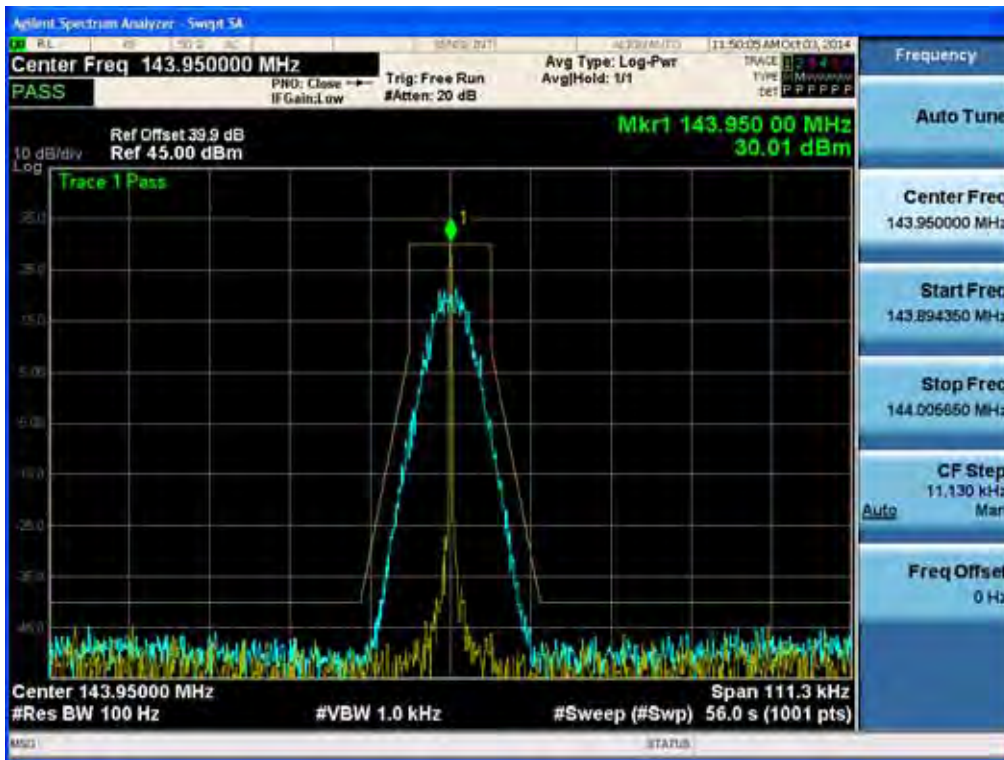

(8K10F1E, 8K10F1D _ 148.05 MHz)_Low

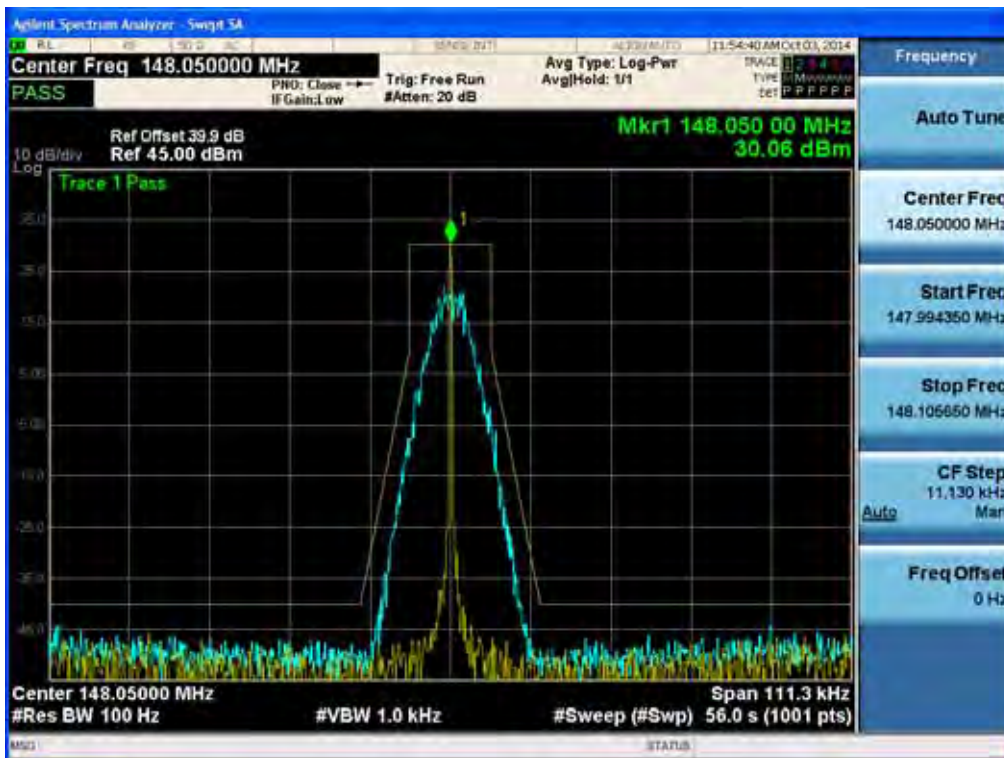

(8K10F1W _ 138.05 MHz)_High

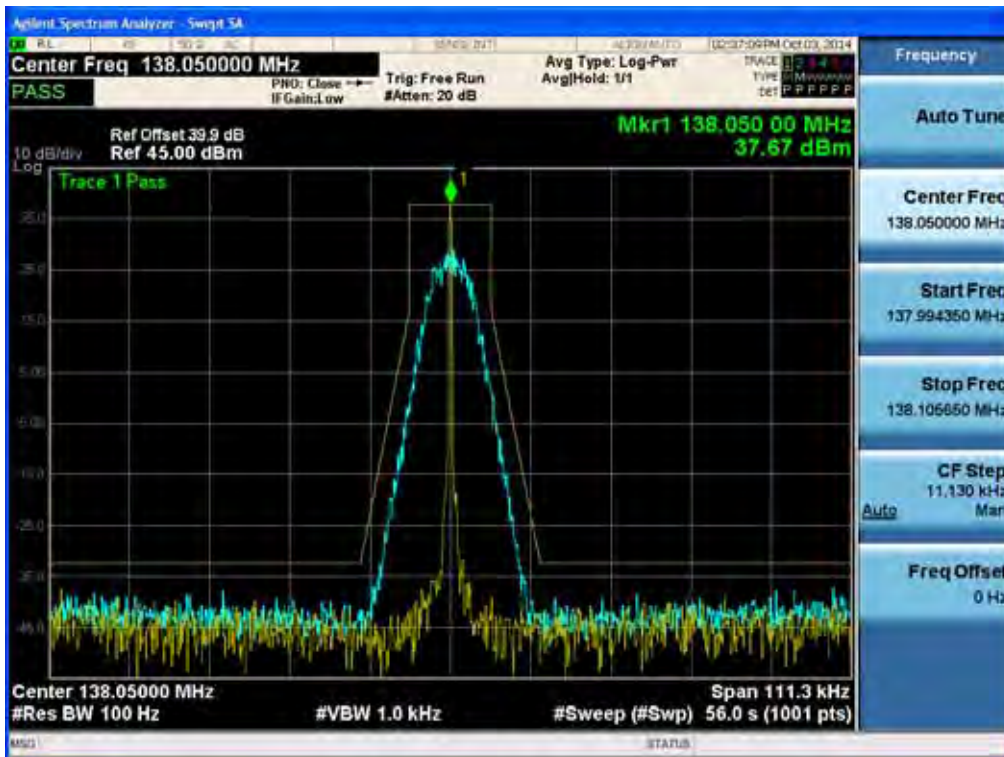

(8K10F1W _ 143.95 MHz)_High

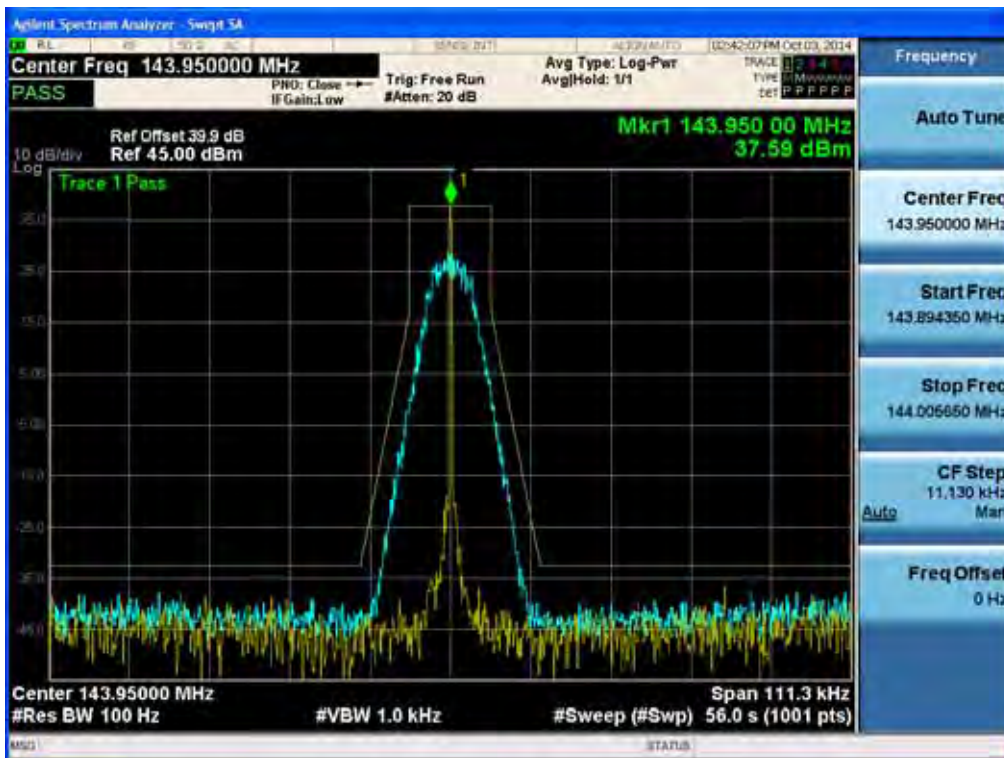

(8K10F1W _ 148.05 MHz)_High

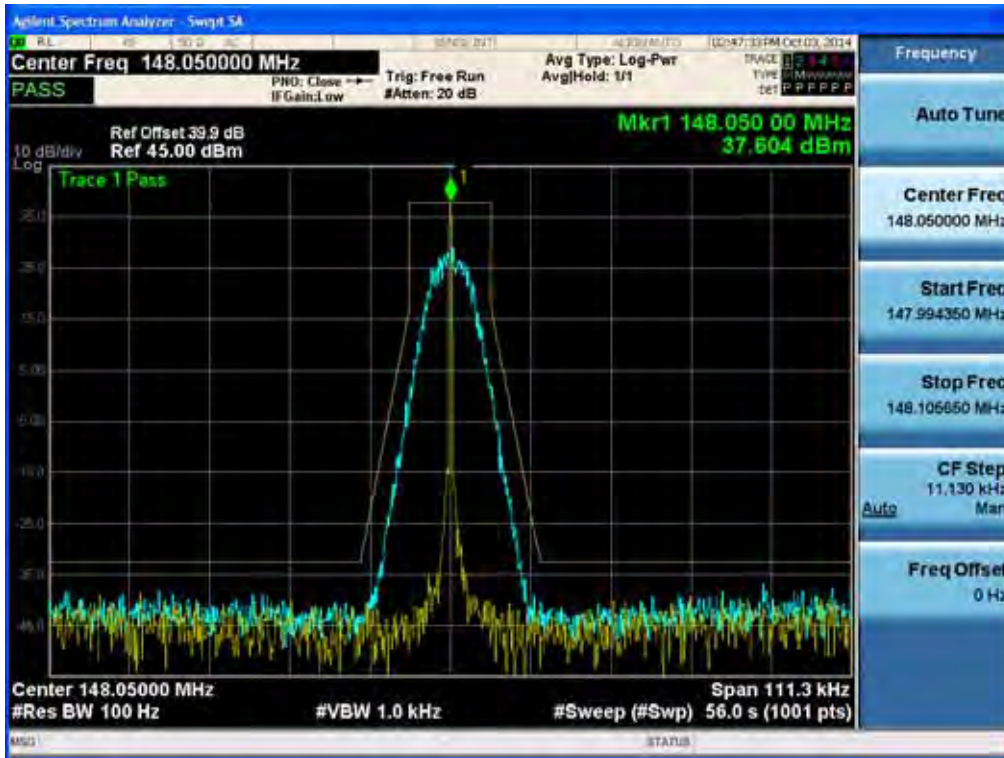

(8K10F1W _ 138.05 MHz)_Low

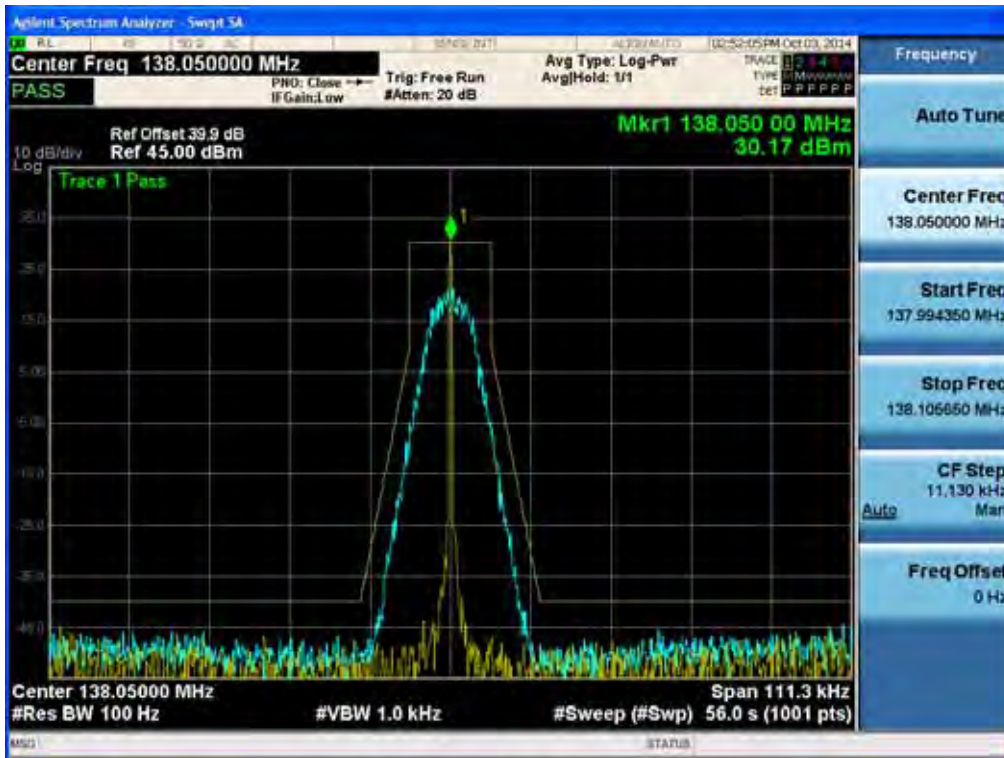

(8K10F1W _ 143.95 MHz)_Low

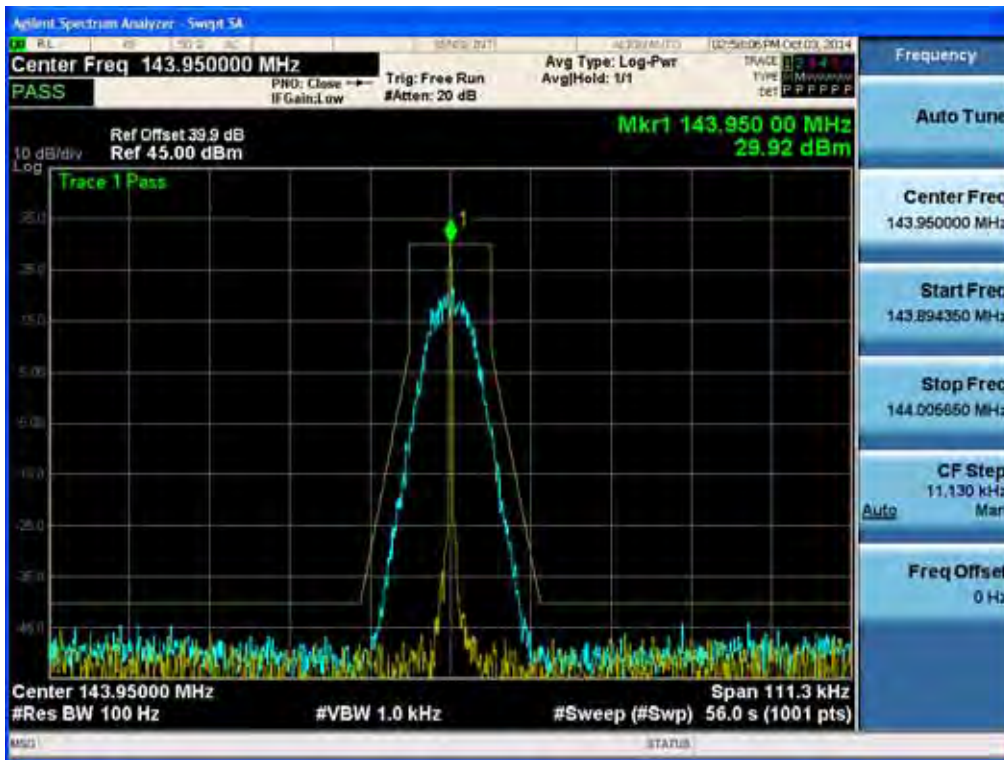

(8K10F1W _ 148.05 MHz)_Low

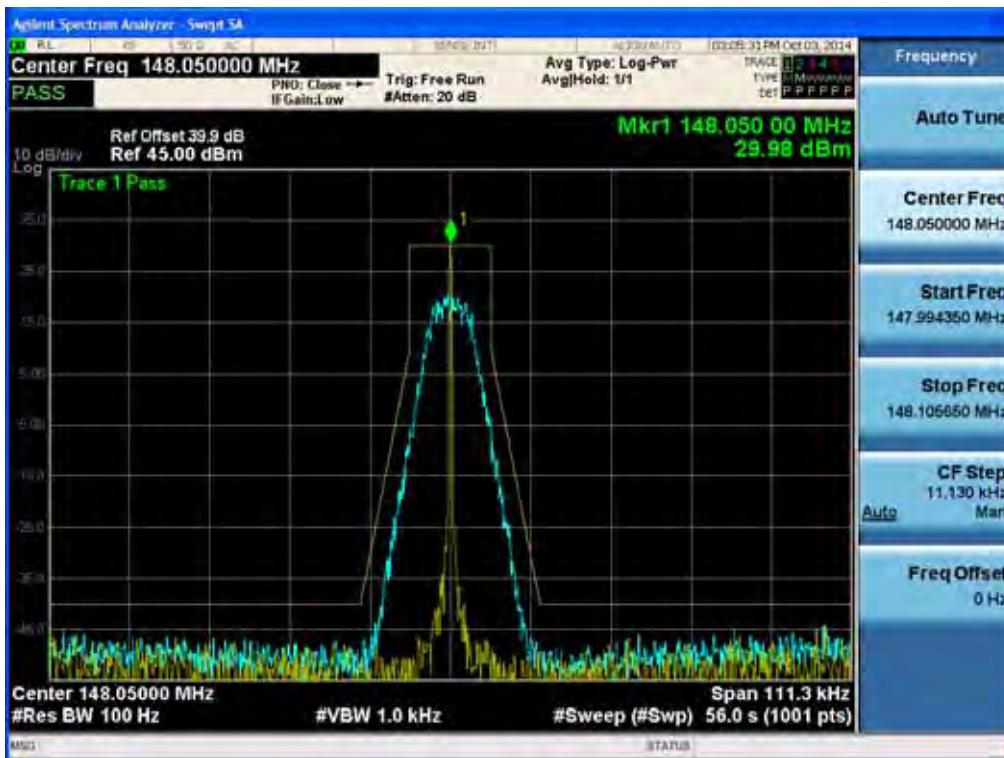

(8K30F1E, 8K30F1D, 8K30F7W _ 138.05 MHz)_High

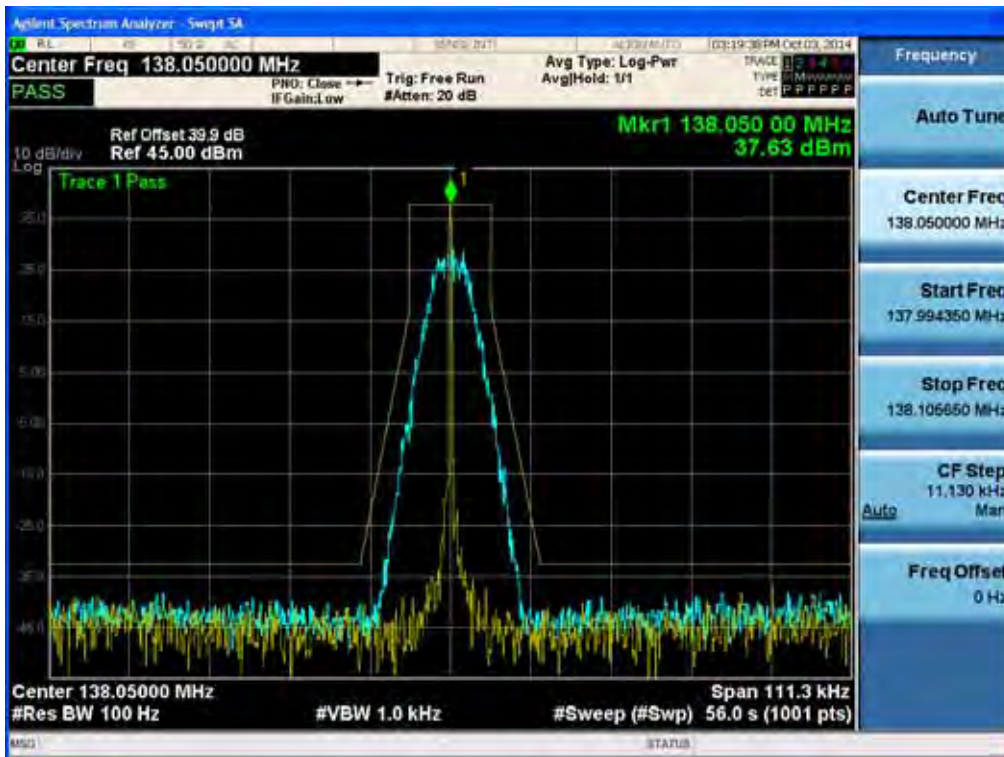

(8K30F1E, 8K30F1D, 8K30F7W _ 143.95 MHz)_High

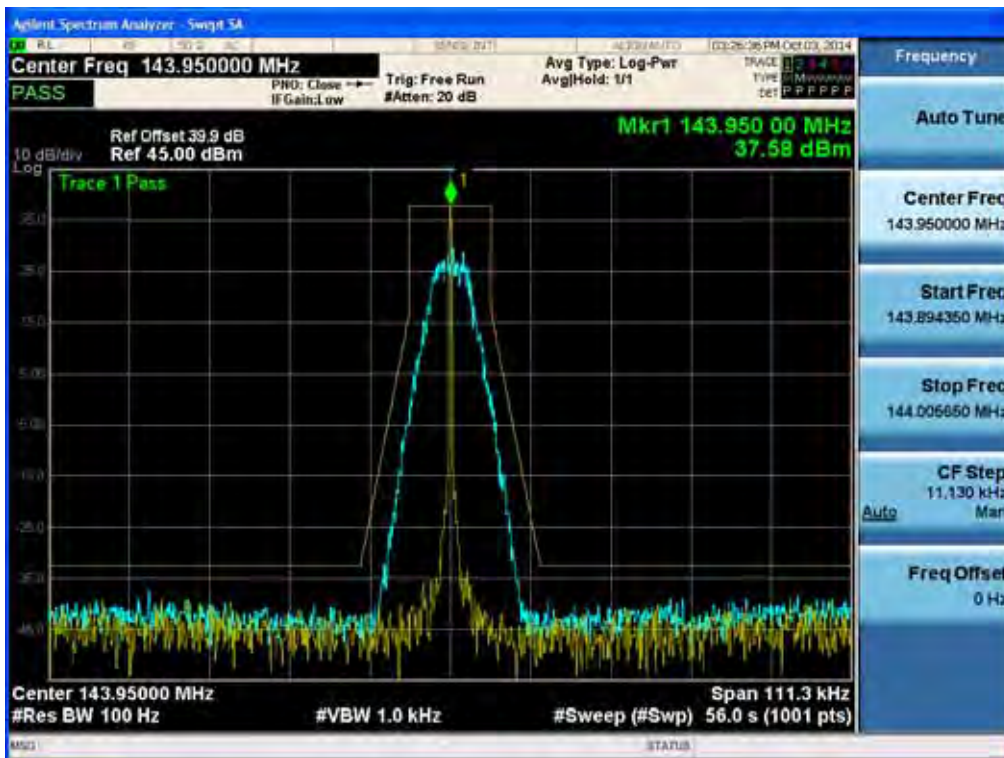

(8K30F1E, 8K30F1D, 8K30F7W _ 148.05 MHz)_High

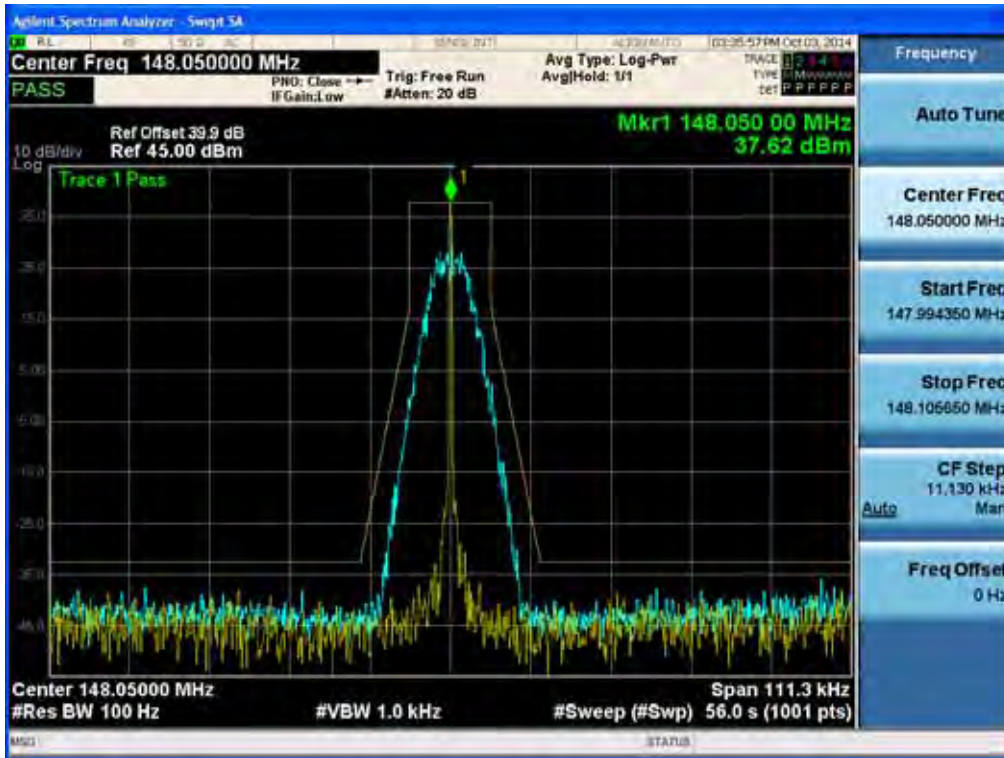

(8K30F1E, 8K30F1D, 8K30F7W _ 138.05 MHz)_Low

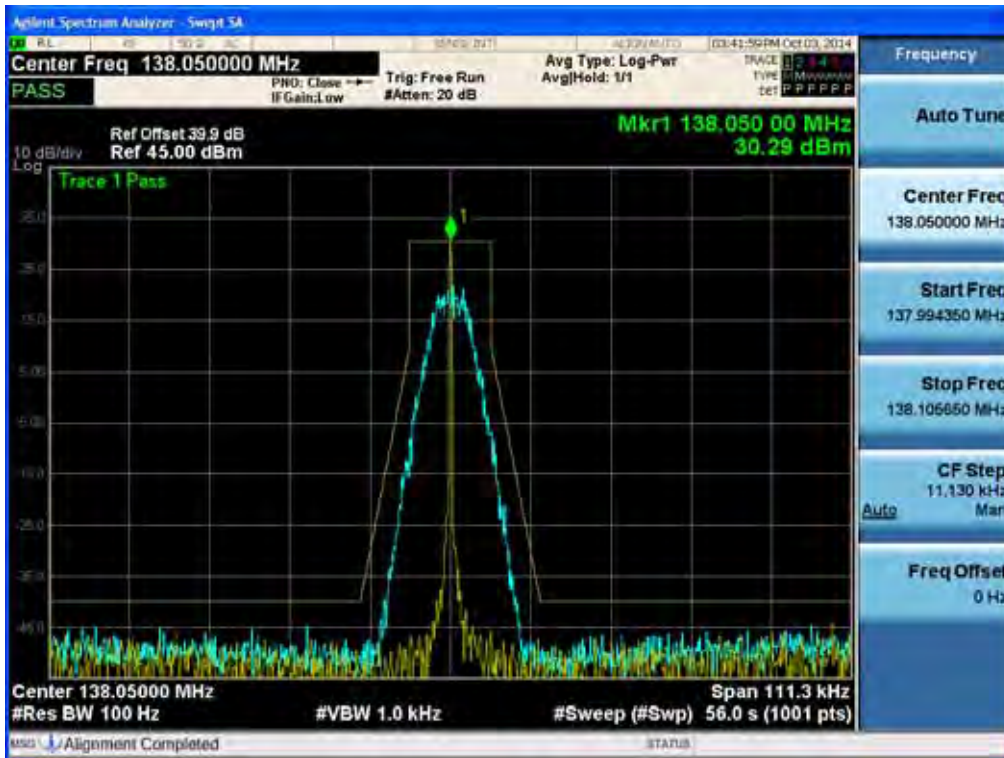

(8K30F1E, 8K30F1D, 8K30F7W _ 143.95 MHz)_Low

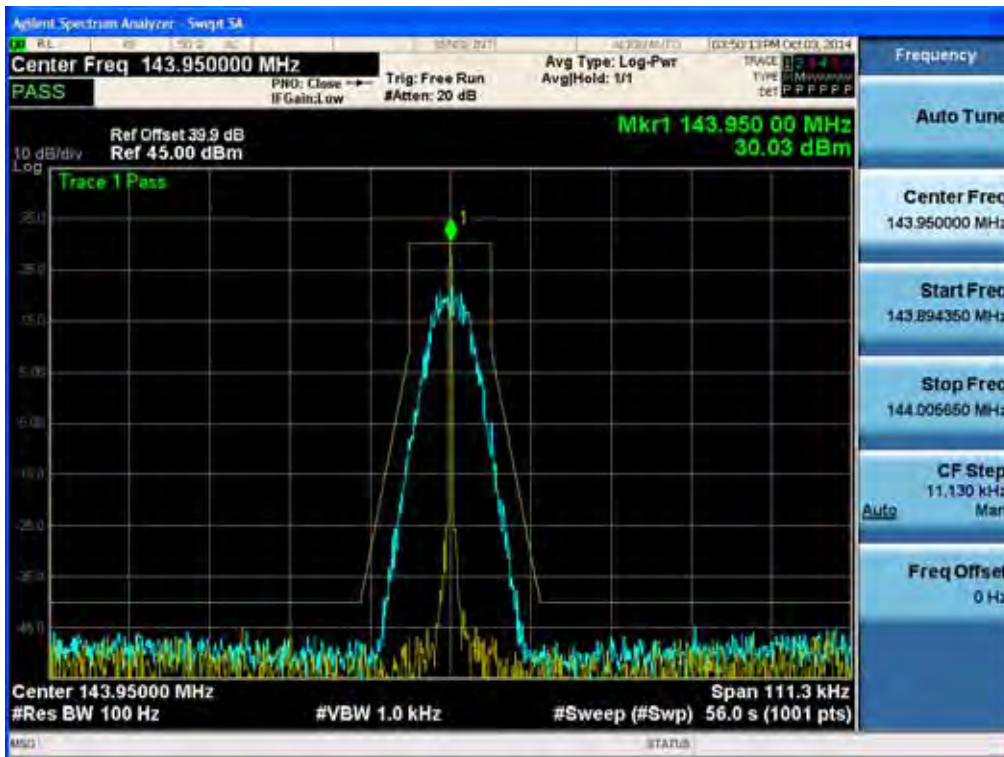

(8K30F1E, 8K30F1D, 8K30F7W _ 148.05 MHz)_Low

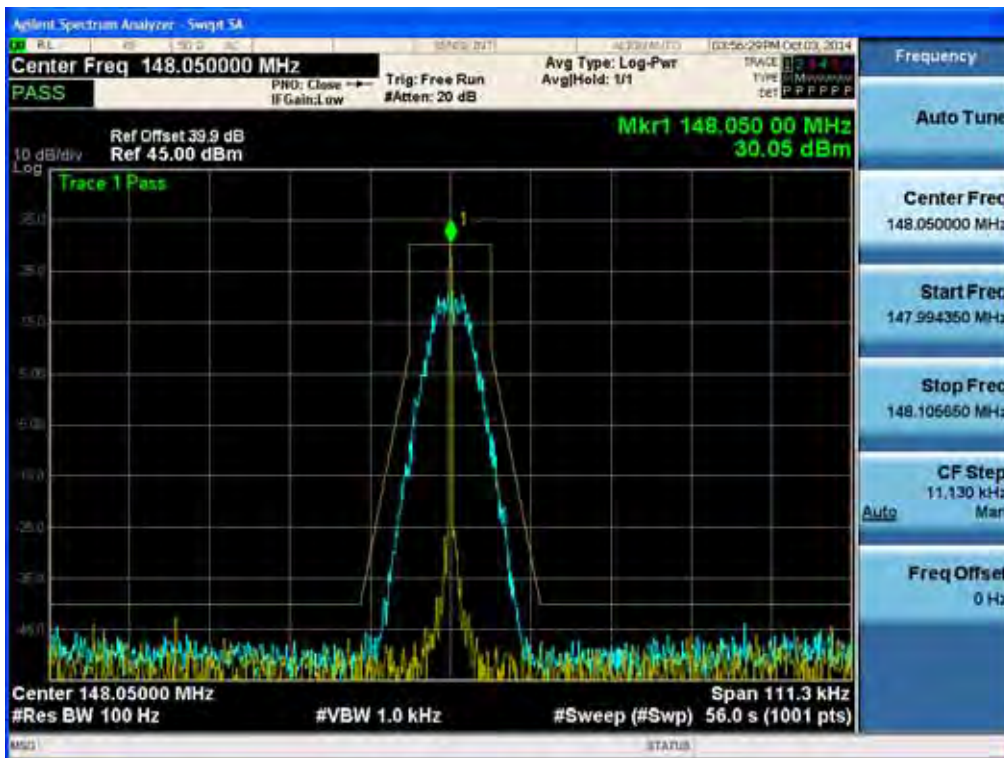

(4K00F1E, 4K00F1D, 4K00F7W _ 138.05 MHz)_High

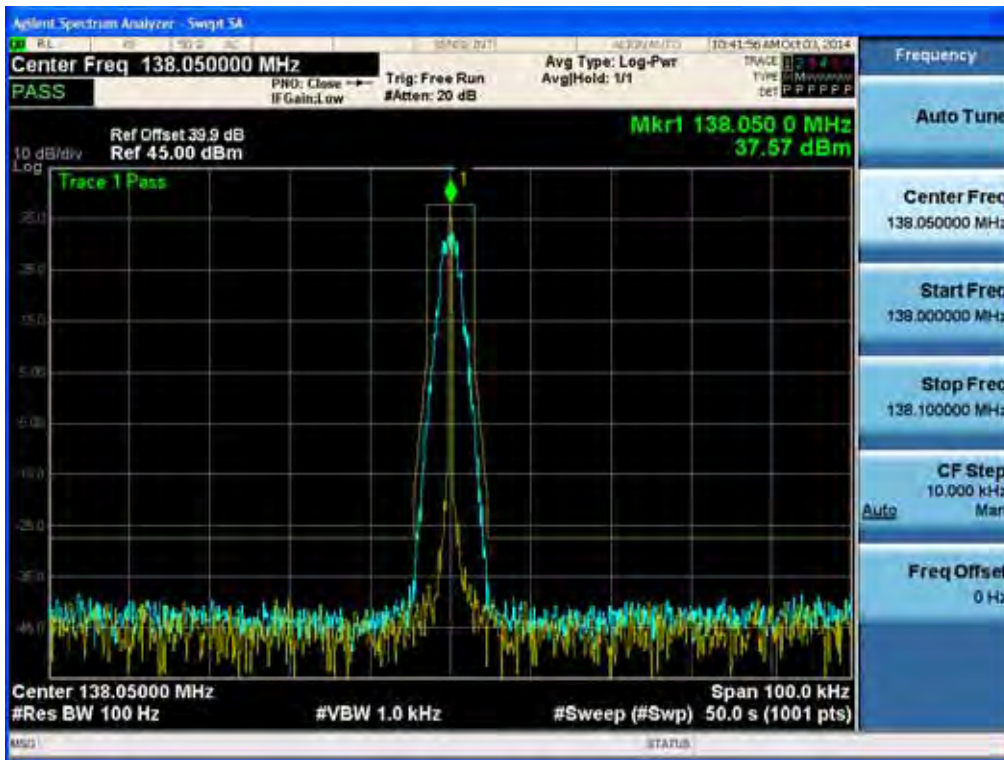

(4K00F1E, 4K00F1D, 4K00F7W _ 143.95 MHz)_High

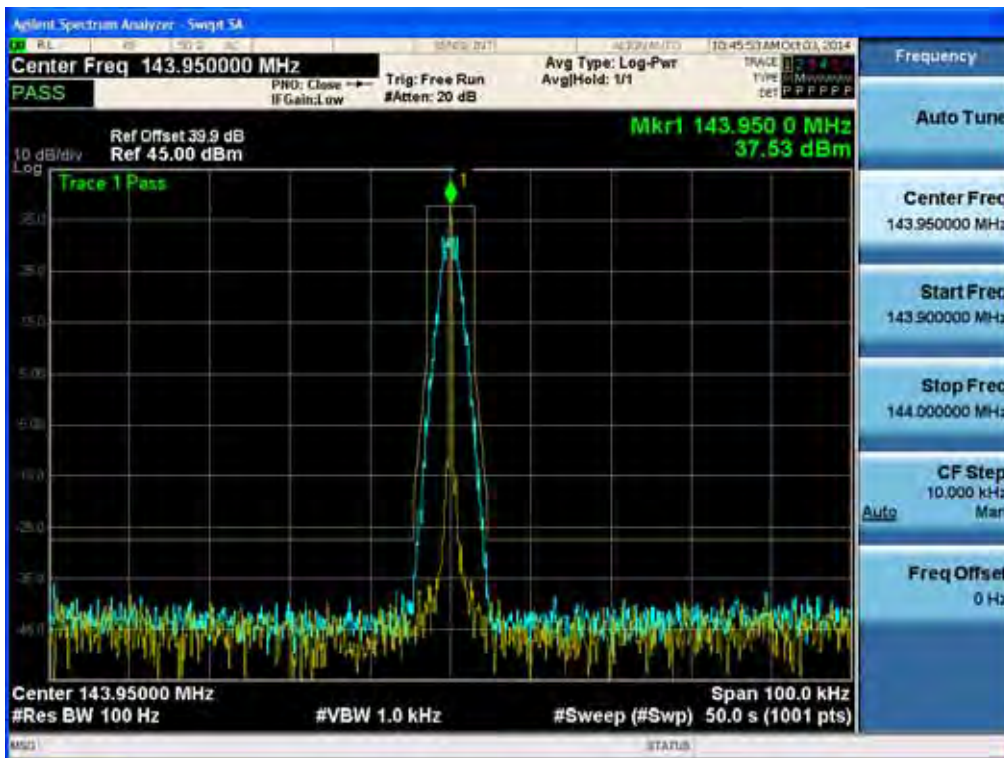

(4K00F1E, 4K00F1D, 4K00F7W _ 148.05 MHz)_High

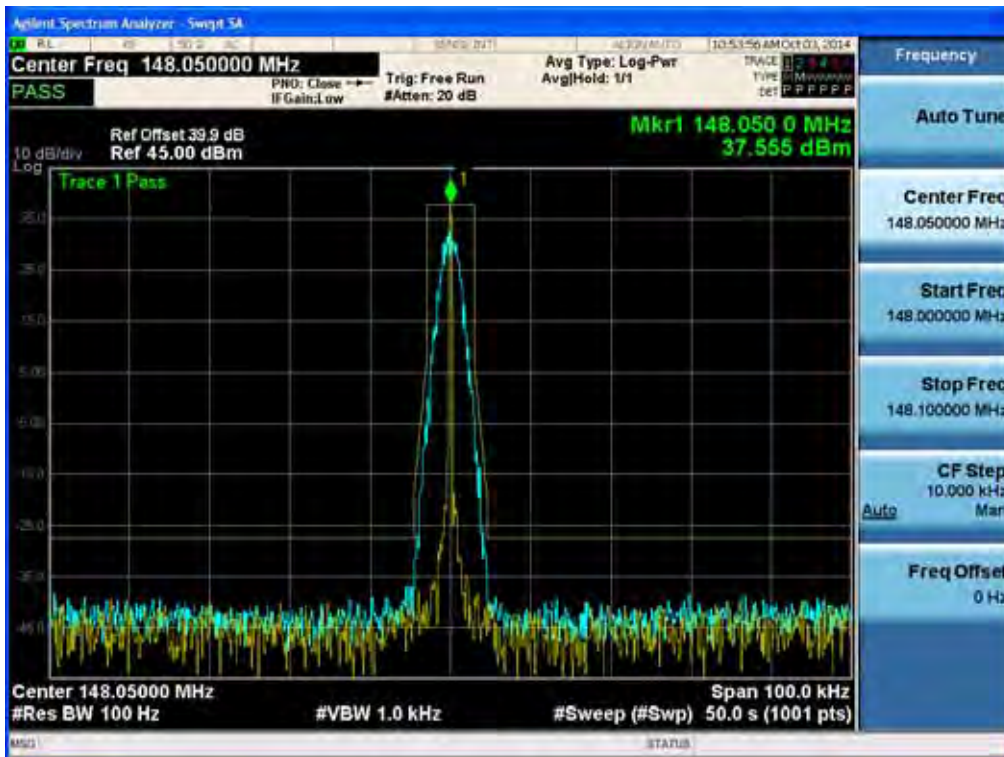

(4K00F1E, 4K00F1D, 4K00F7W _ 138.05 MHz)_Low

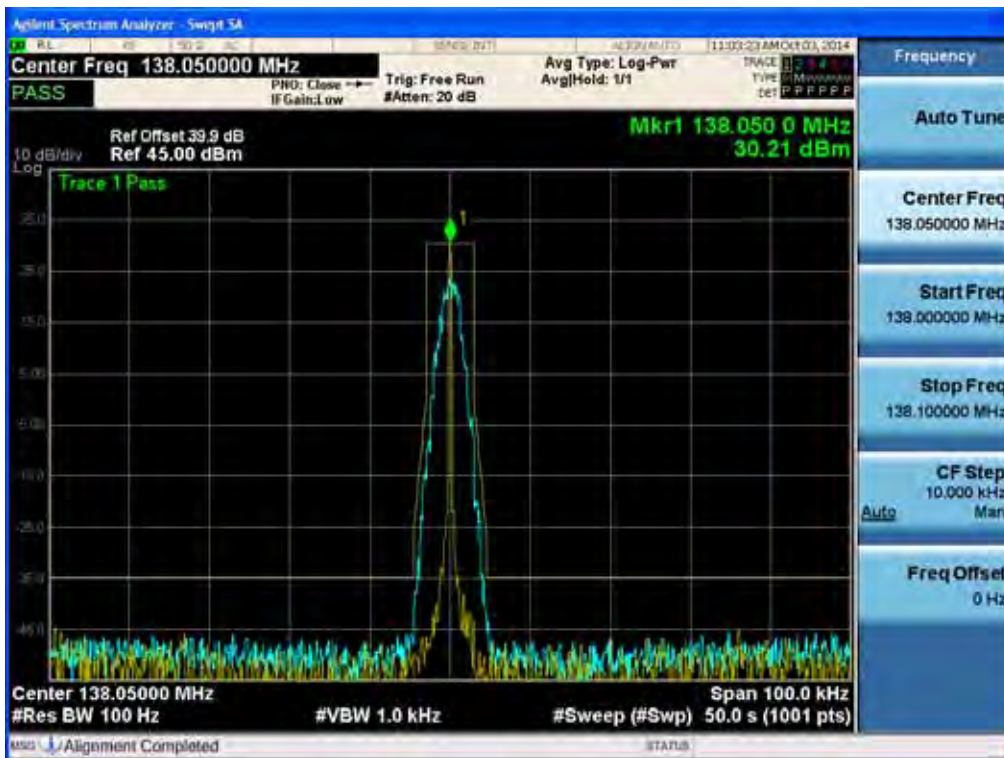

(4K00F1E, 4K00F1D, 4K00F7W _ 143.95 MHz)_Low



(4K00F1E, 4K00F1D, 4K00F7W _ 148.05 MHz)_Low

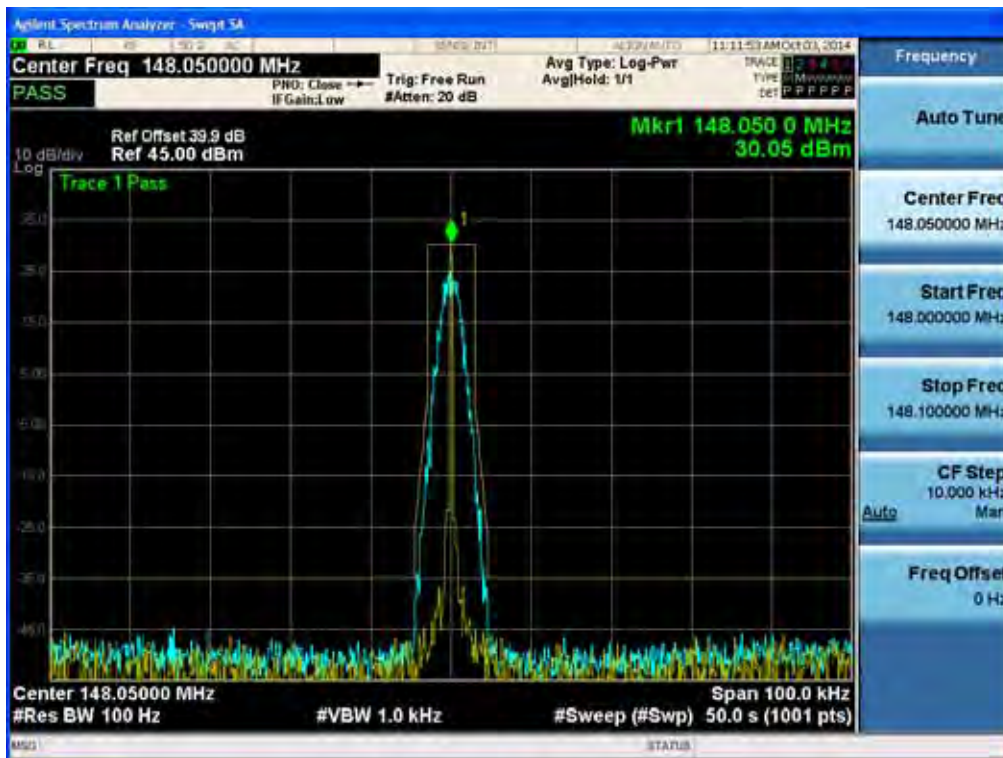

(4K00F2D _ 138.05 MHz)_Low

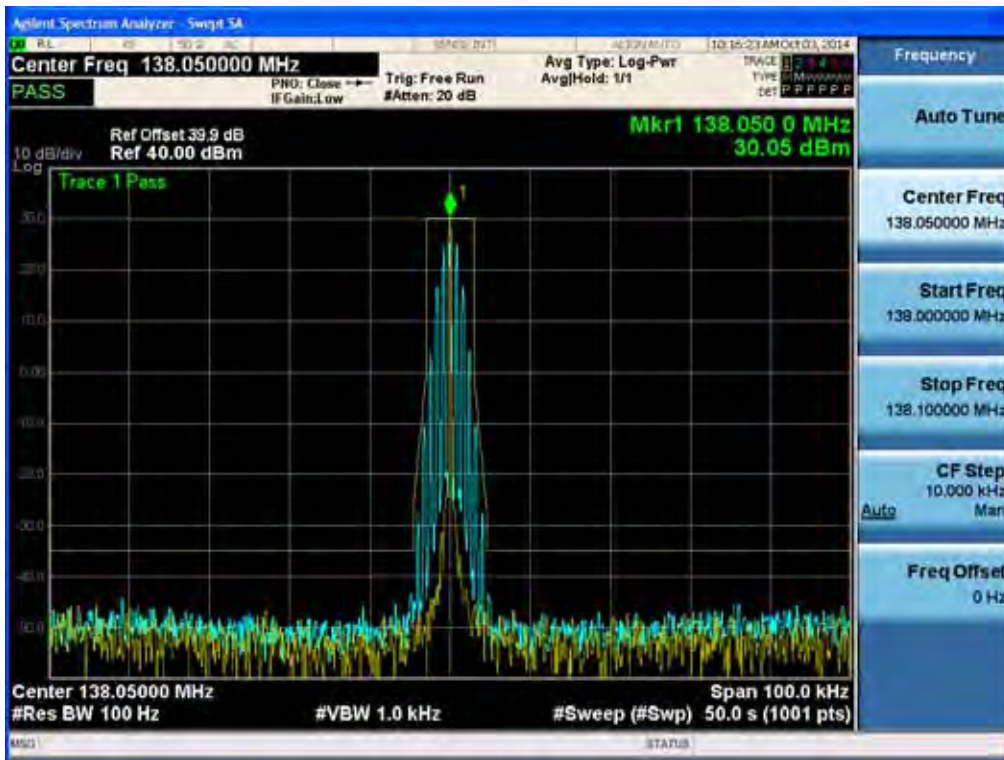

(4K00F2D _ 143.95 MHz)_Low

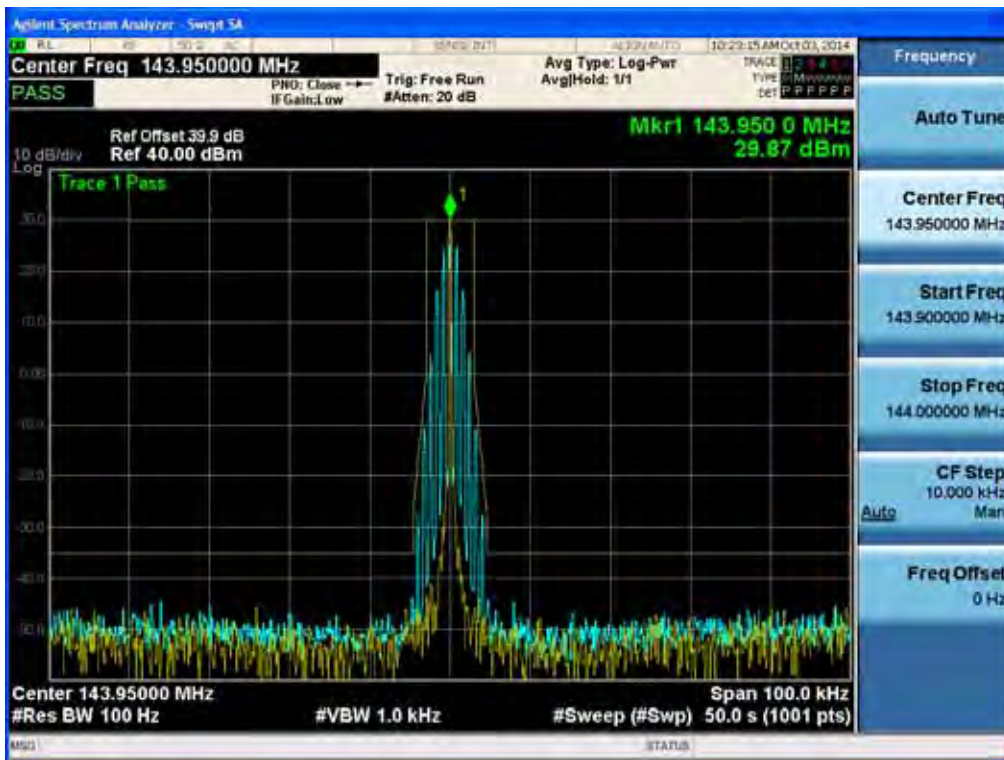

(4K00F2D _ 148.05 MHz)_Low

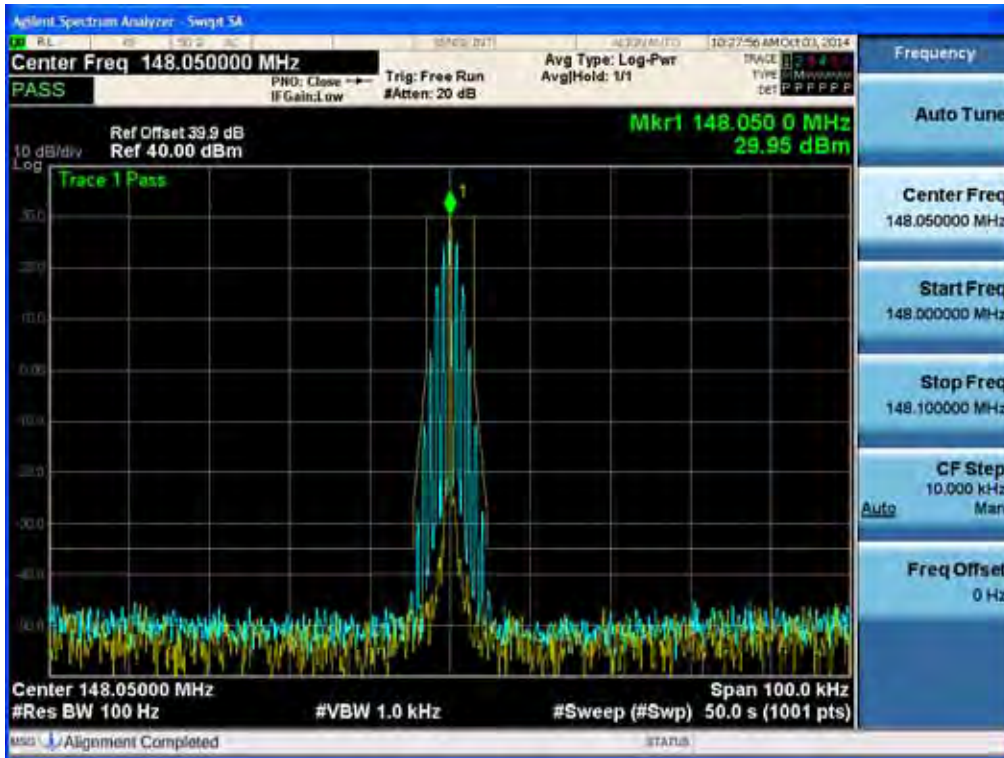

7.7 Transient Frequency Behavior

Definition

Transient frequency behavior is a measure of the difference, as a function in time, of the actual transmitter frequency to the assigned transmitter frequency when the transmitted RF output power is switched on or off.

TEST CONFIGURATION

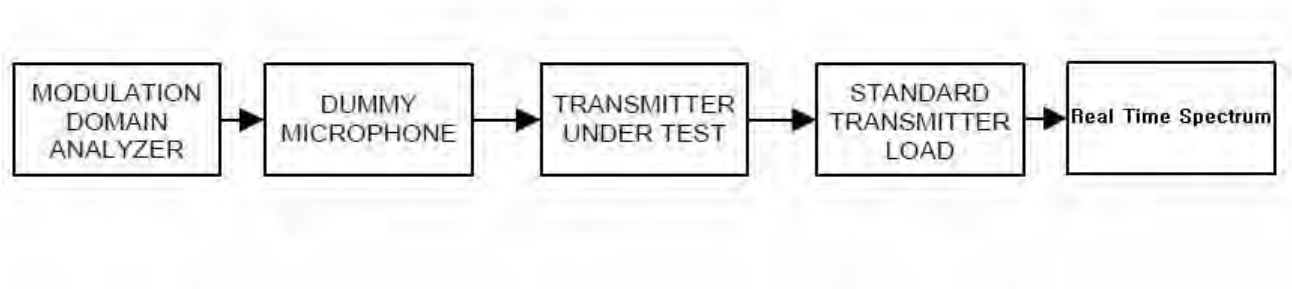

TEST PROCEDURE

According to 2.2.19 in TIA-603-D Standard.

- a) Connect the equipment as illustrated.
- b) Connect the output of the standard transmitter load to the RF power meter.
Supply sufficient attenuation via the RF attenuator to provide a level that is approximately 40 dB below the maximum allowable input to the modulation domain analyzer.
- c) Unkey the transmitter.
- d) Disconnect the RF power meter and connect the modulation domain analyzer in its place.
Set the envelope trigger of the modulation domain analyzer to the minimum level that will trigger when the transmitter is keyed.
- e) Reduce the attenuation of the RF attenuator so that the input to the modulation domain analyzer is increased by 30 dB when the transmitter is keyed.
- f) Set the modulation domain analyzer to trigger on the rising edge of the waveform in order to capture a single-shot turn-on of the transmitter signal.
- g) Adjust the display of the modulation domain analyzer for proper viewing of the transmitter transient behavior. Set the time base reference to the left for observing the transmitter turn-on transient.
- h) Key the transmitter.
- i) Observe the stored display of the modulation domain analyzer.
The signal trace shall be maintained within the allowable limits during the periods t_1 and t_2 , and shall also remain within limits following t_2 .
- j) Adjust the modulation domain analyzer to trigger on the falling edge of the transmitter waveform in order to capture a single-shot turn-off transient of the transmitter signal.

- k) Adjust the display of the modulation domain analyzer for proper viewing of the transmitter transient behavior. Set the time base reference to the right for observing the transmitter turn-off transient.
- l) Unkey the transmitter.
- m) Observe the stored display of the modulation domain analyzer. The signal trace shall be maintained within the allowable limits during the period t_3 .

Plots of Transient Frequency Behavior FCC

(11K0F3E _ 150.05 MHz)_High

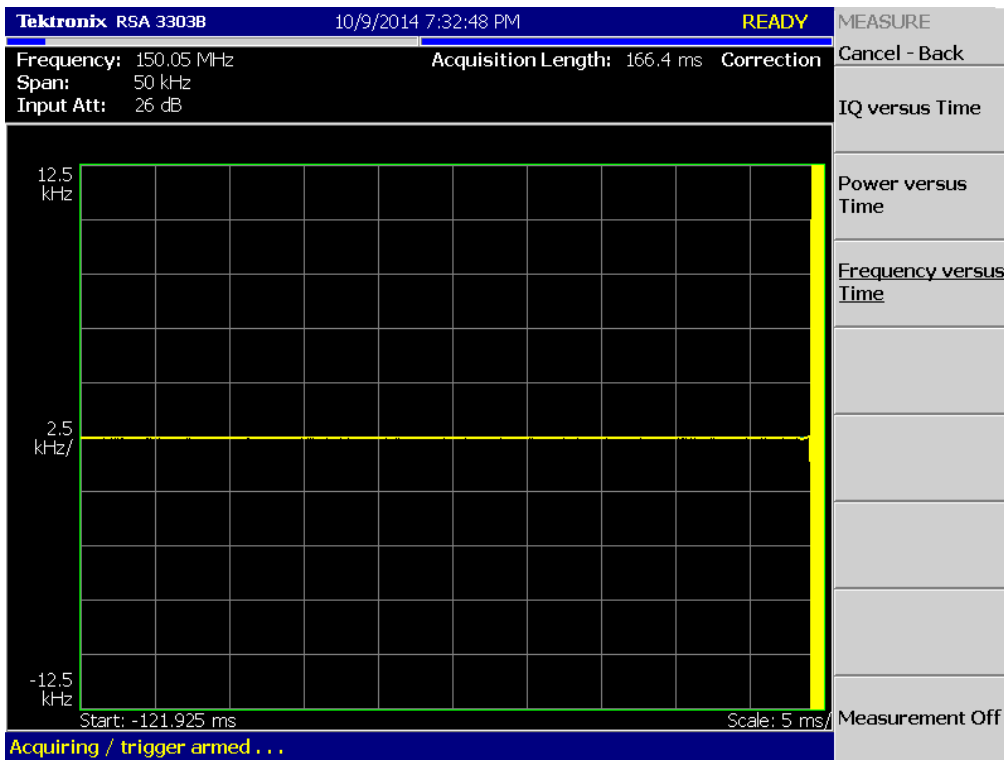
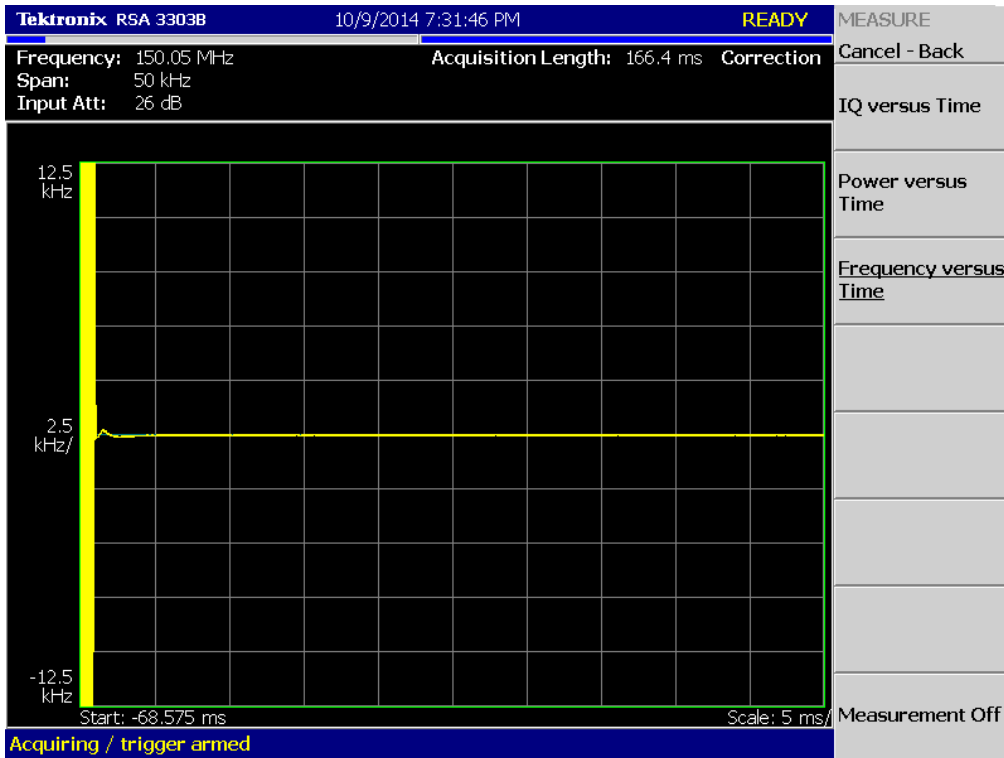

(11K0F3E _ 162.05 MHz)_High

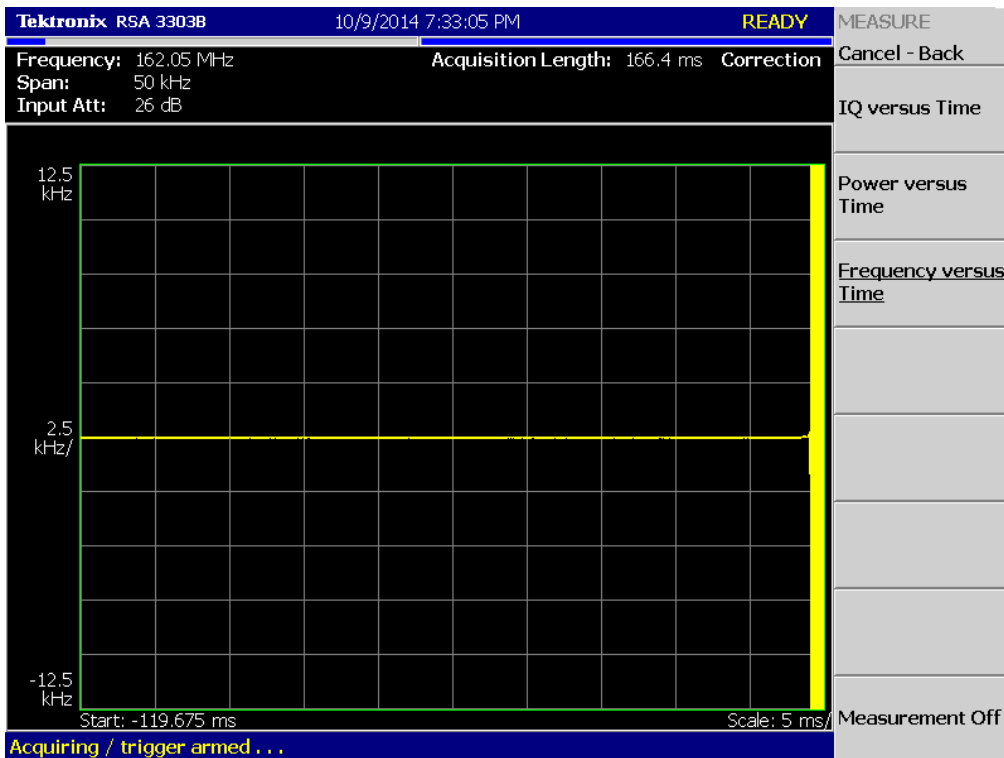
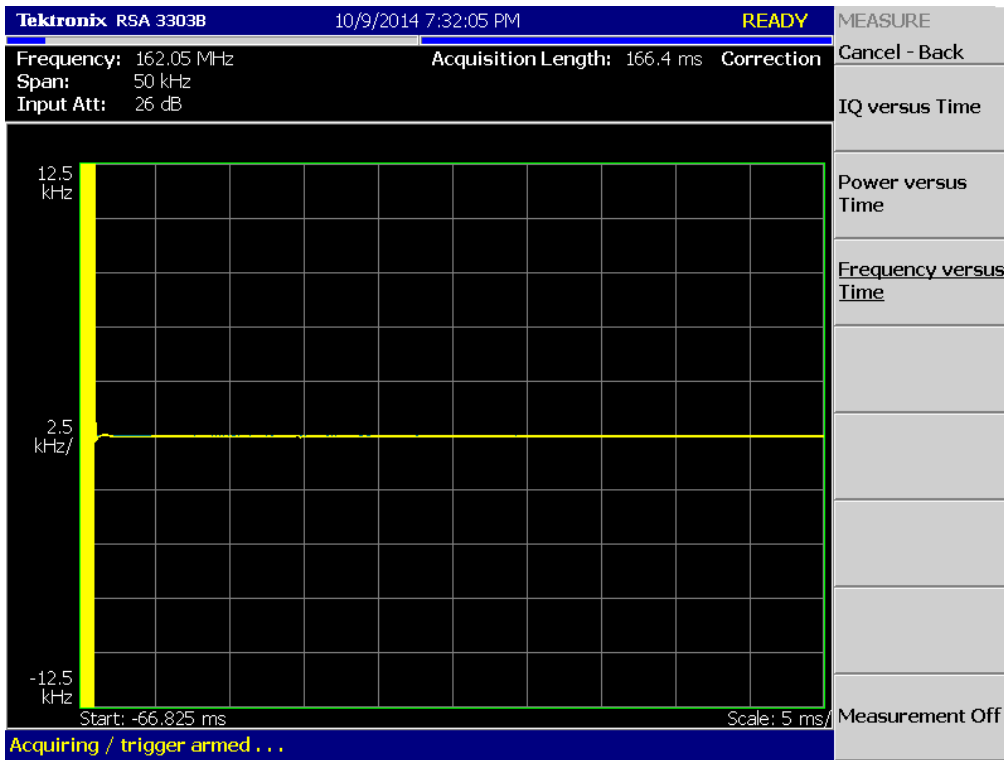

(11K0F3E _ 173.95 MHz)_High

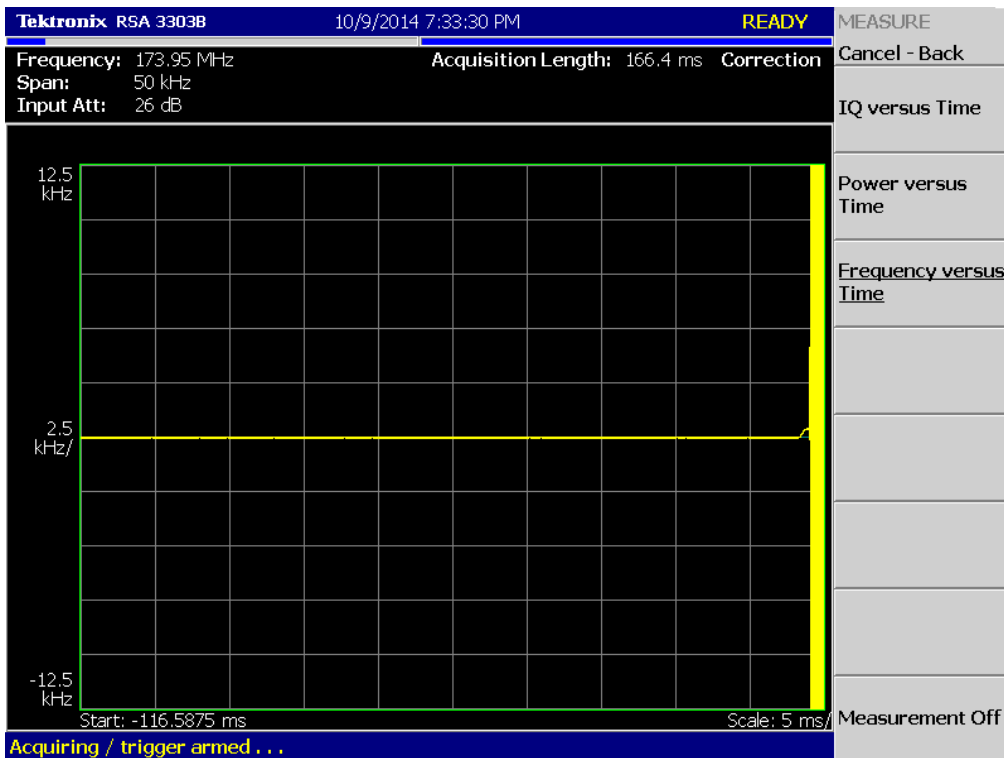
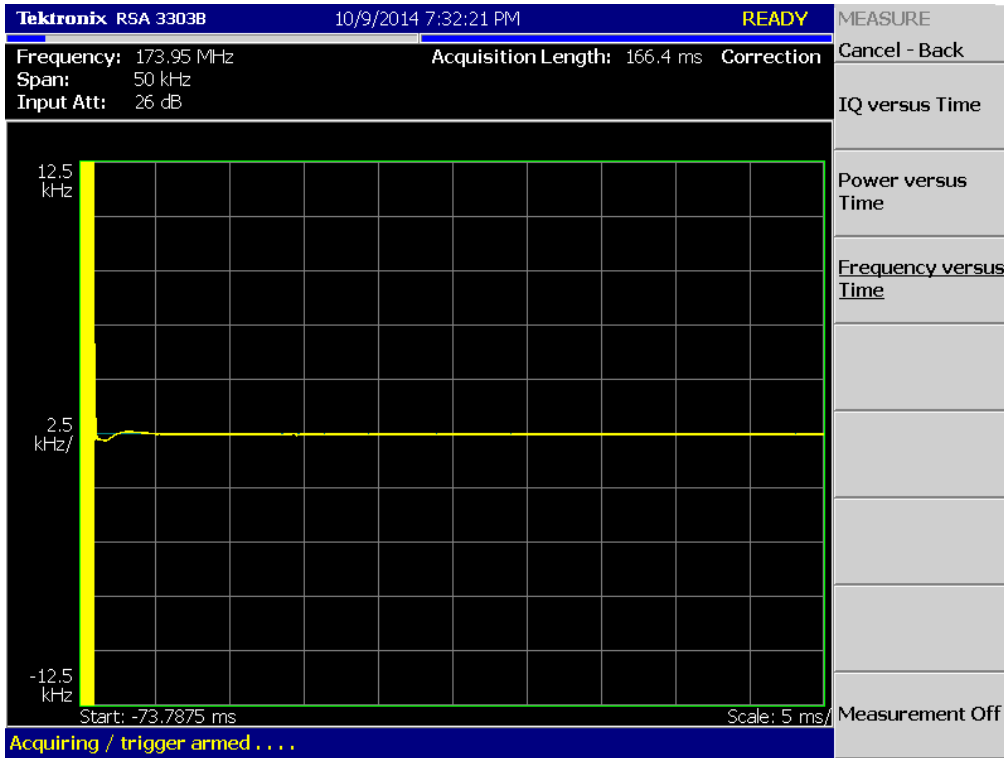

(11K0F3E _ 150.05 MHz)_Low

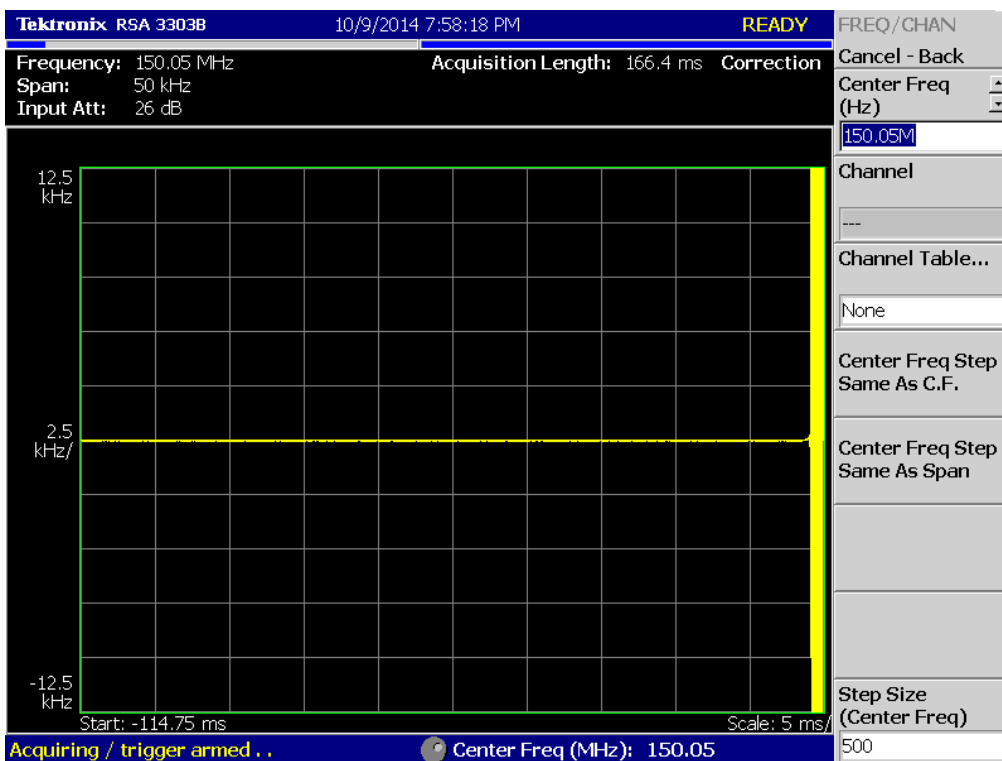
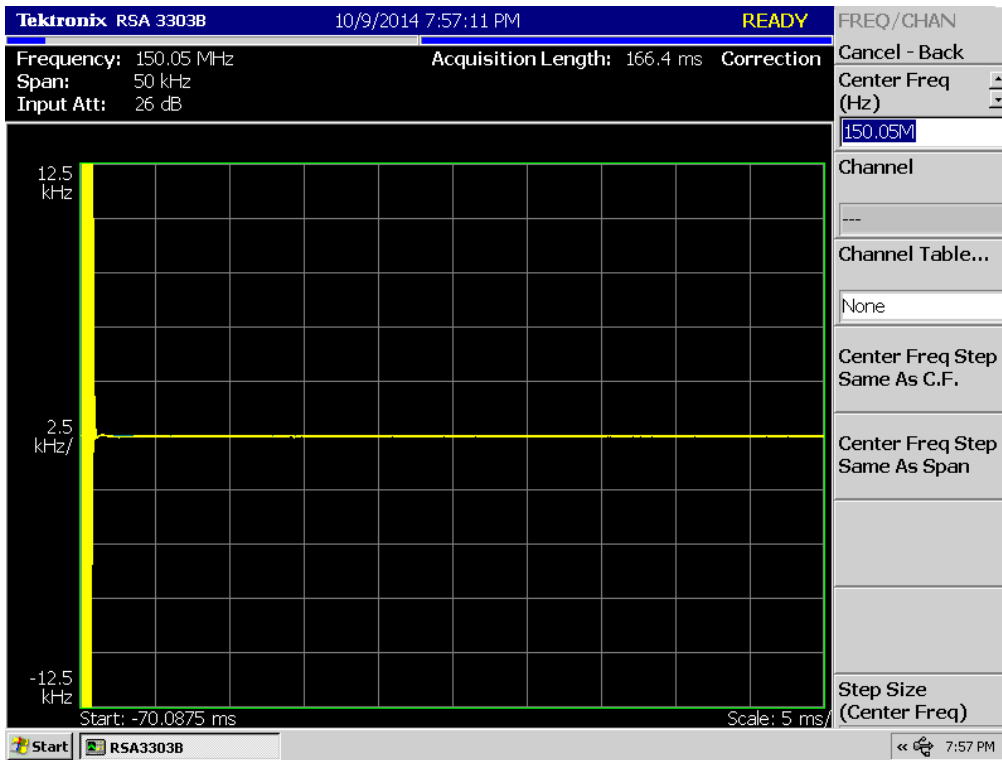

(11K0F3E _ 162.05 MHz)_Low

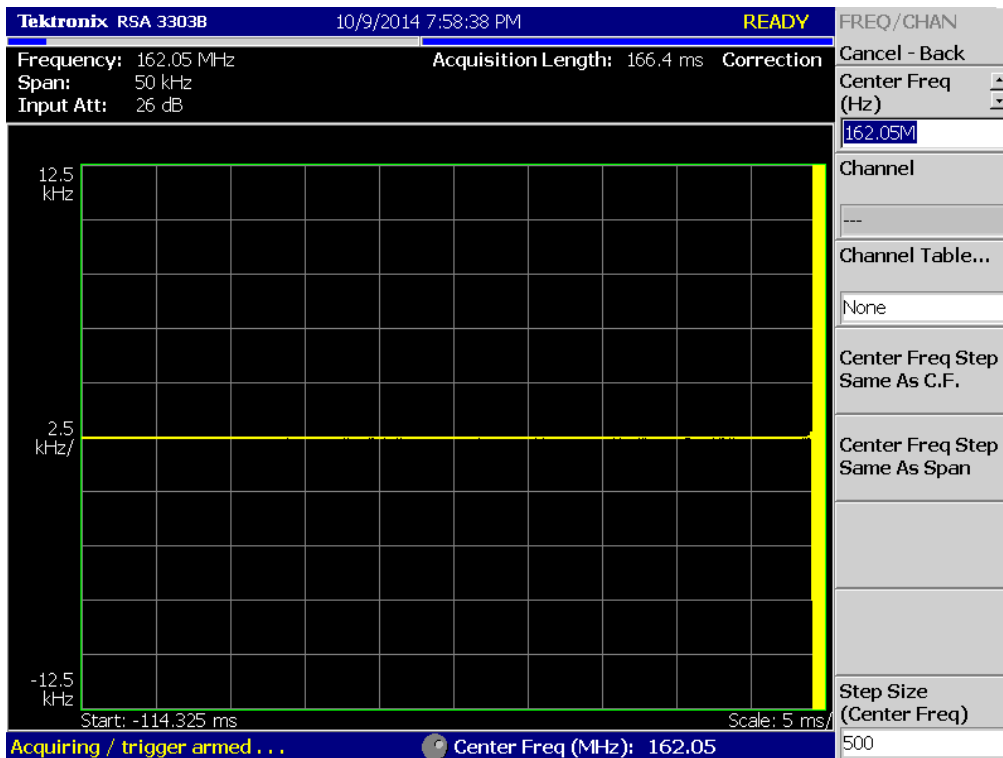
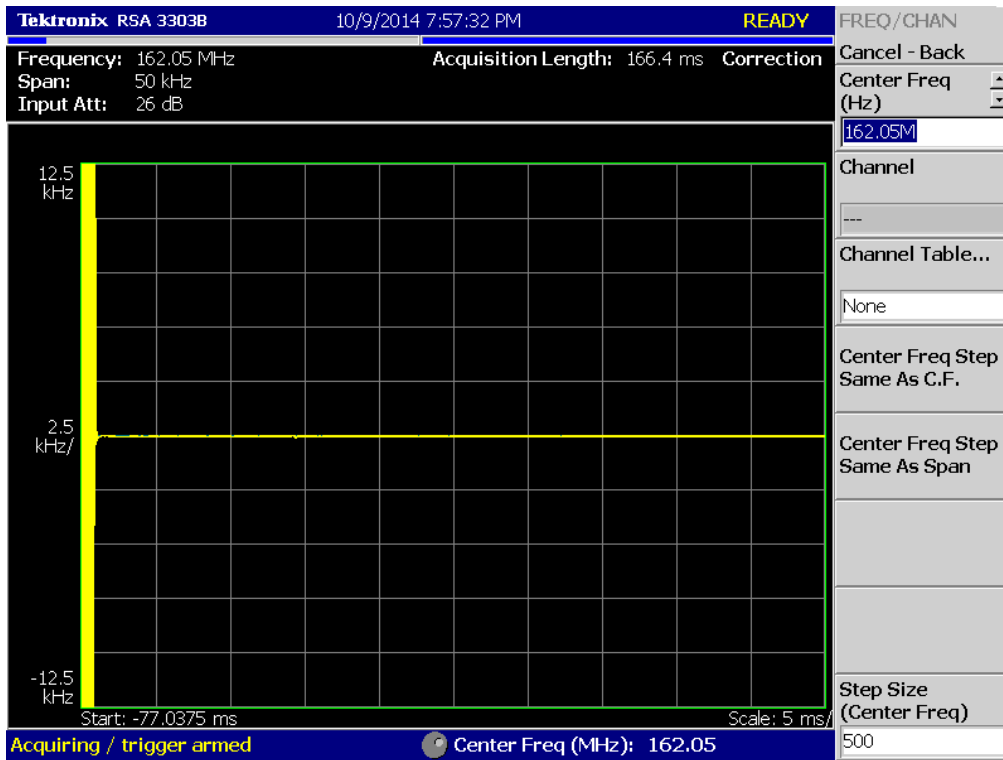

(11K0F3E _ 173.95 MHz)_Low

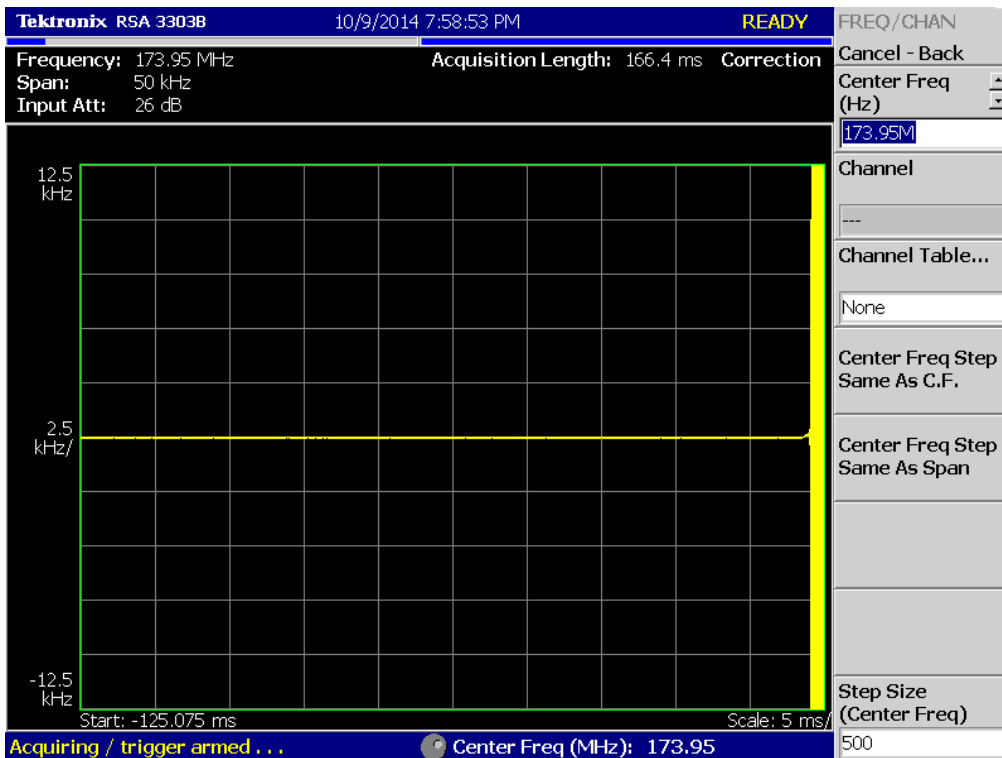
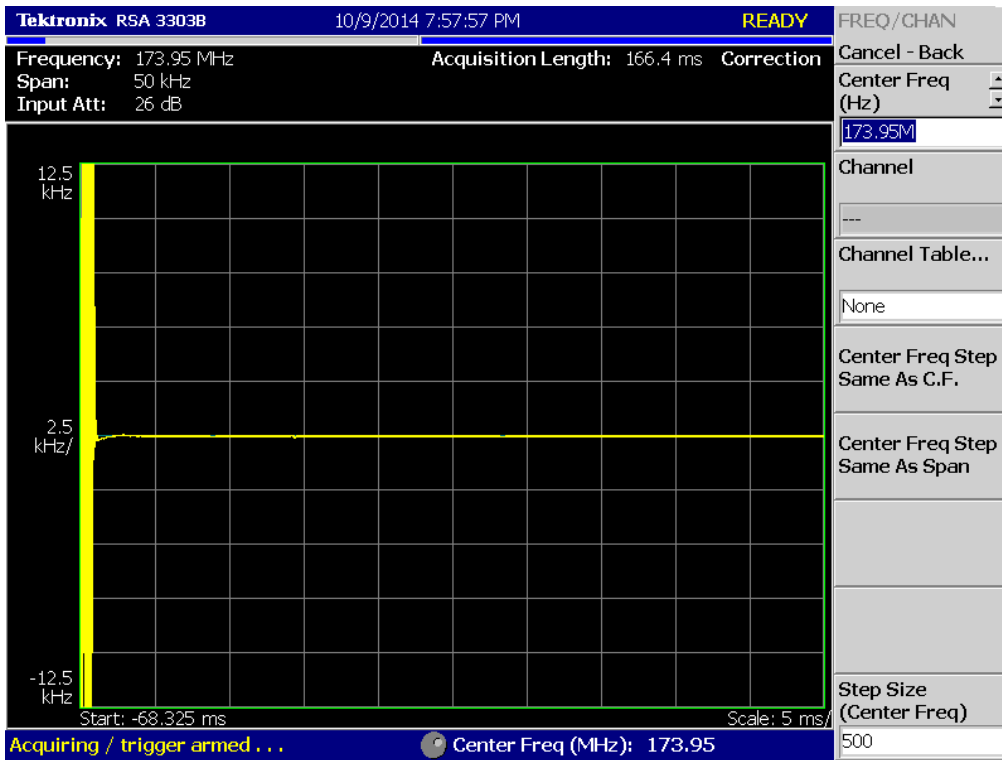

(8K10F1E, 8K10F1D _ 150.05 MHz)_High

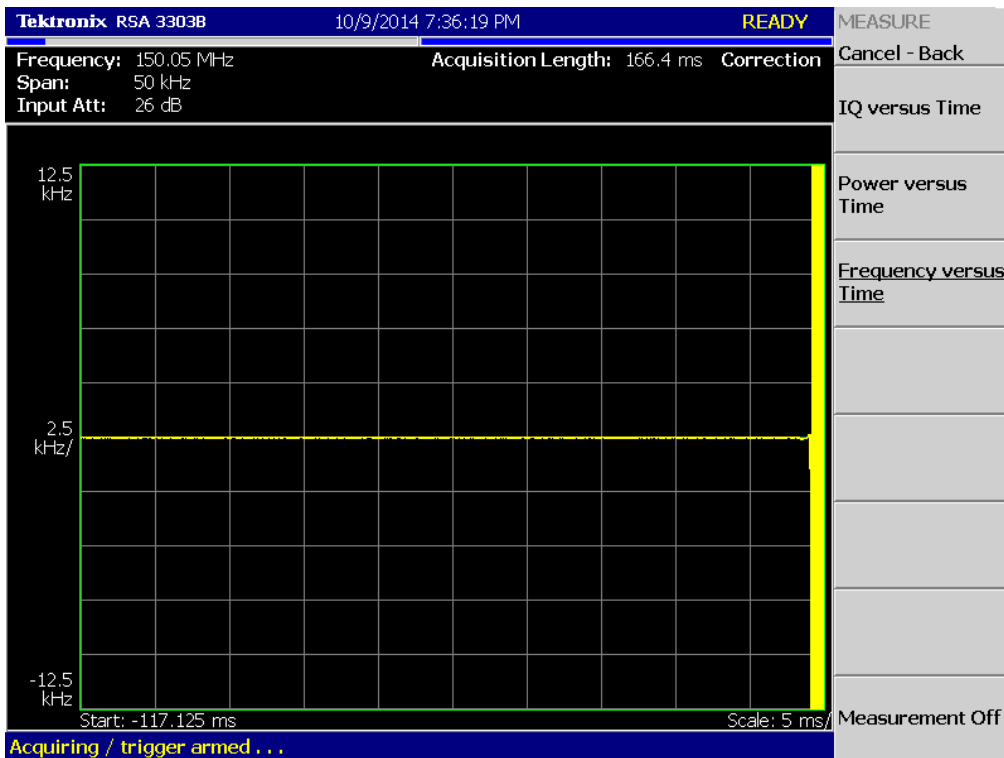
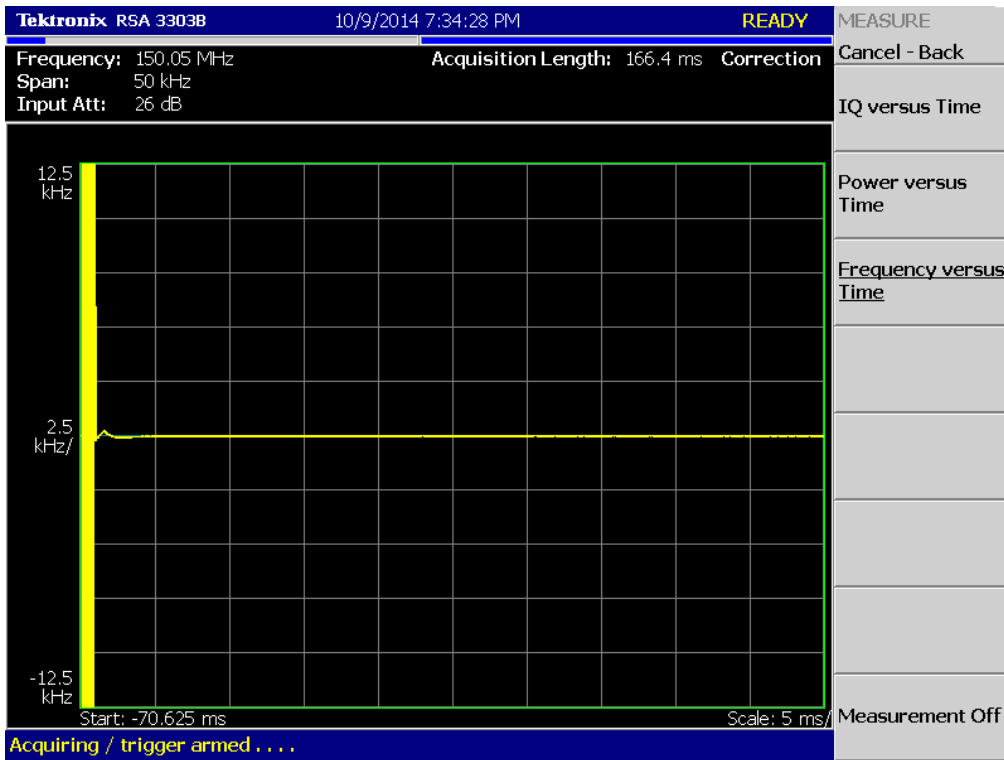

(8K10F1E, 8K10F1D _ 162.05 MHz)_High

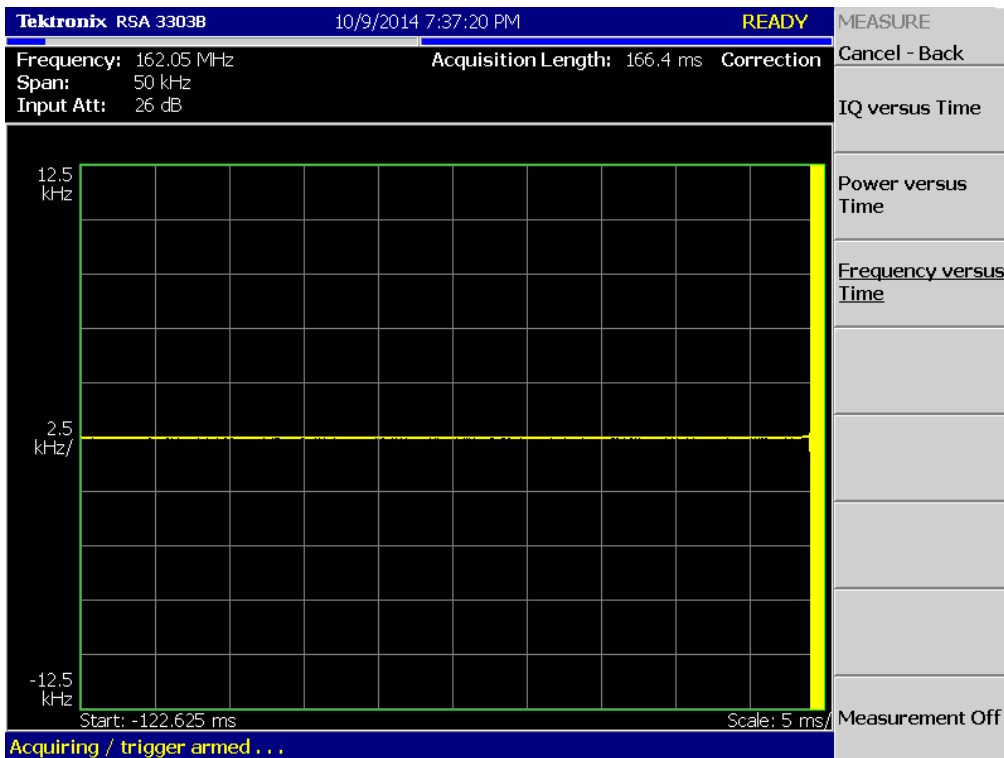
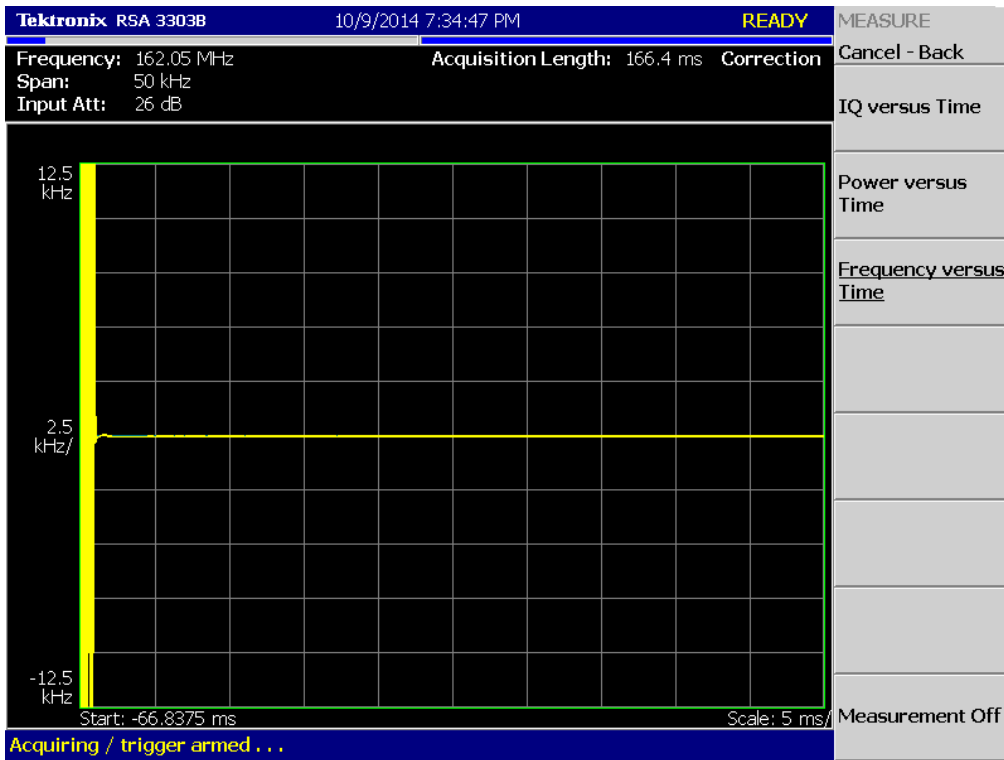

(8K10F1E, 8K10F1D _ 173.95 MHz)_High

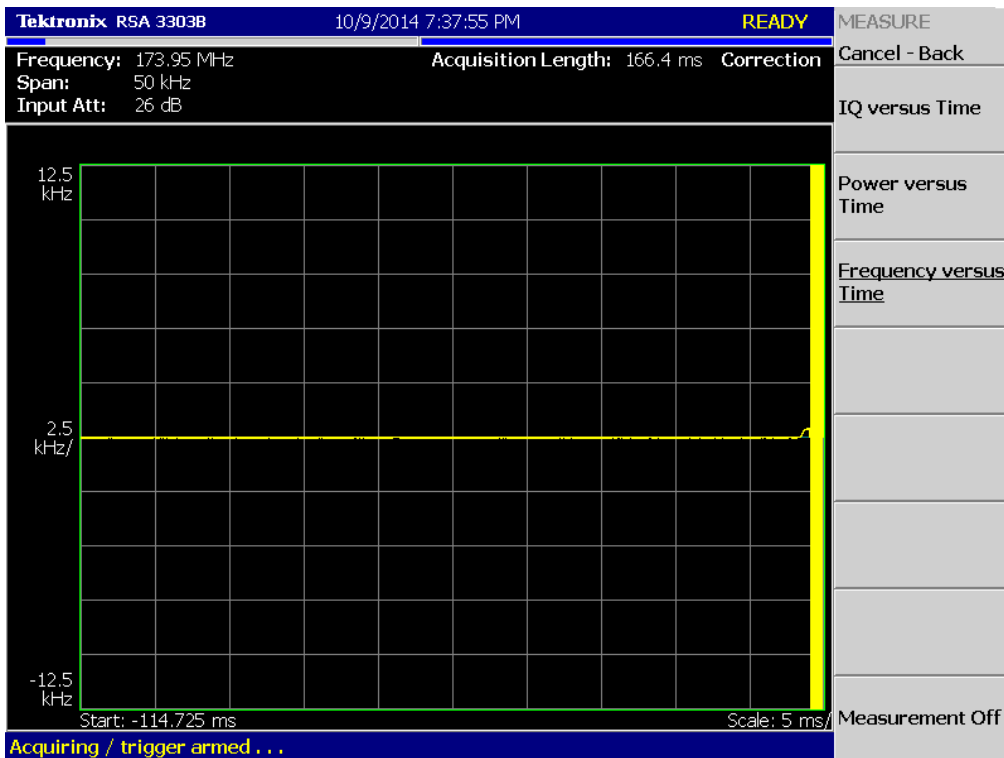
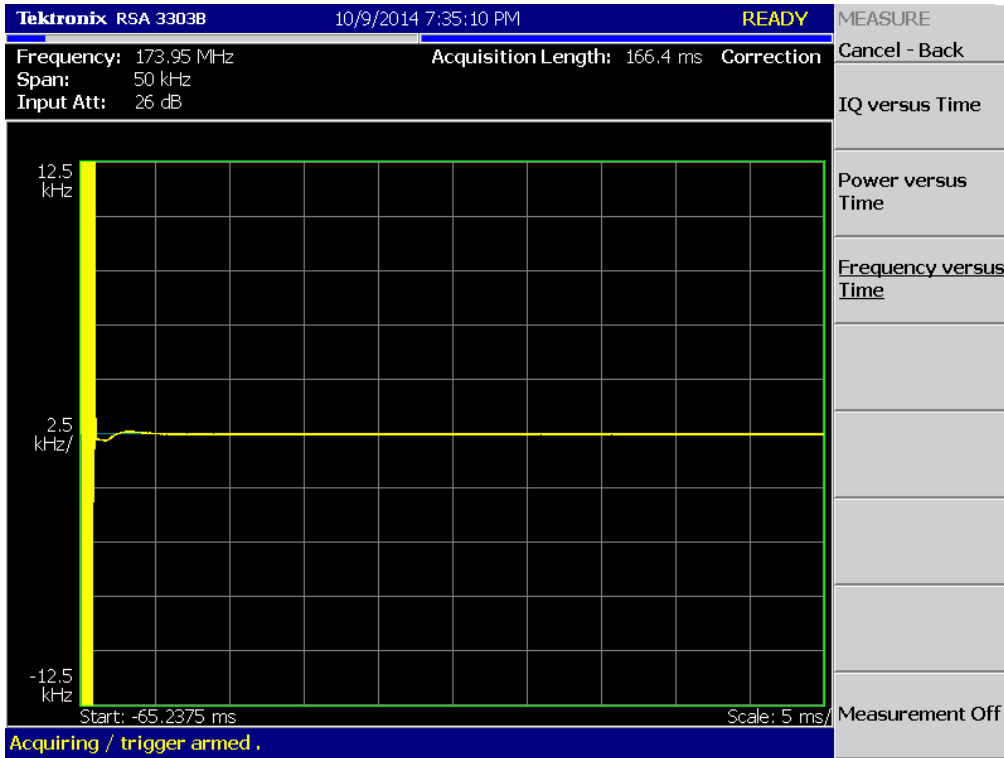

(8K10F1E, 8K10F1D _ 150.05 MHz)_Low

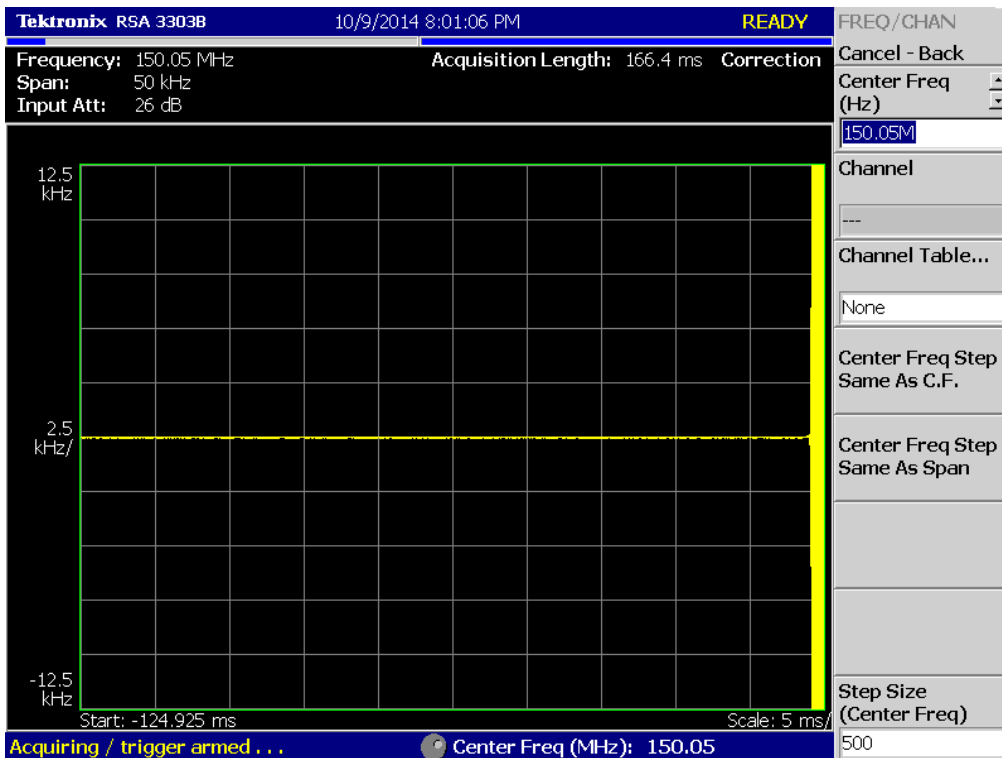
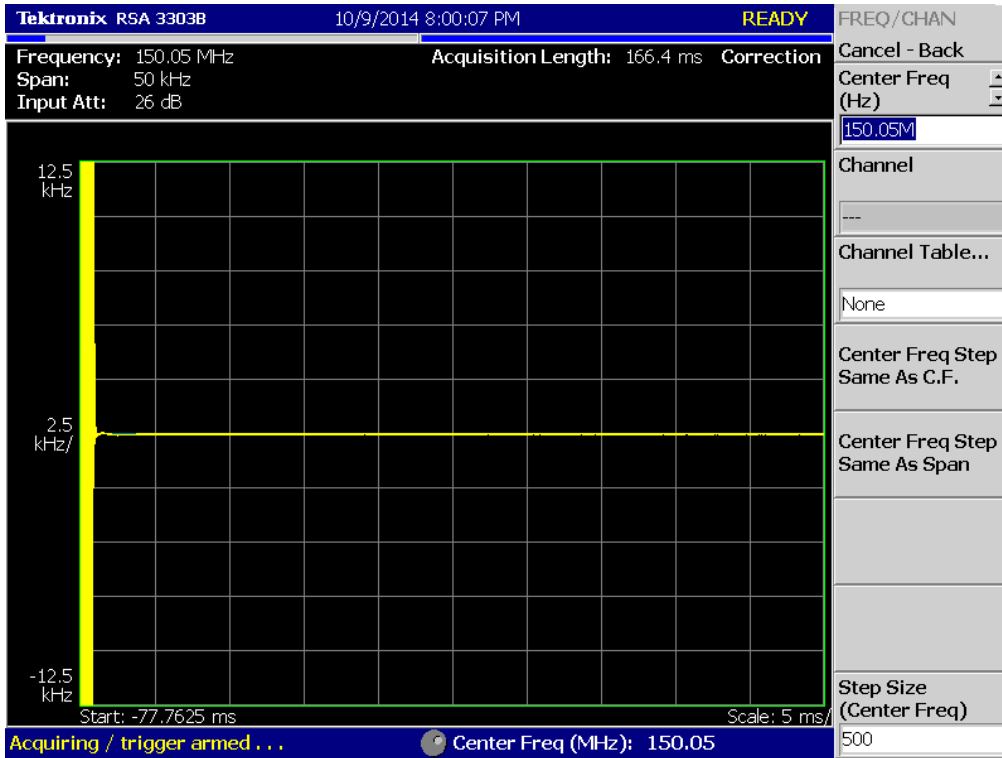

(8K10F1E, 8K10F1D _ 162.05 MHz)_Low

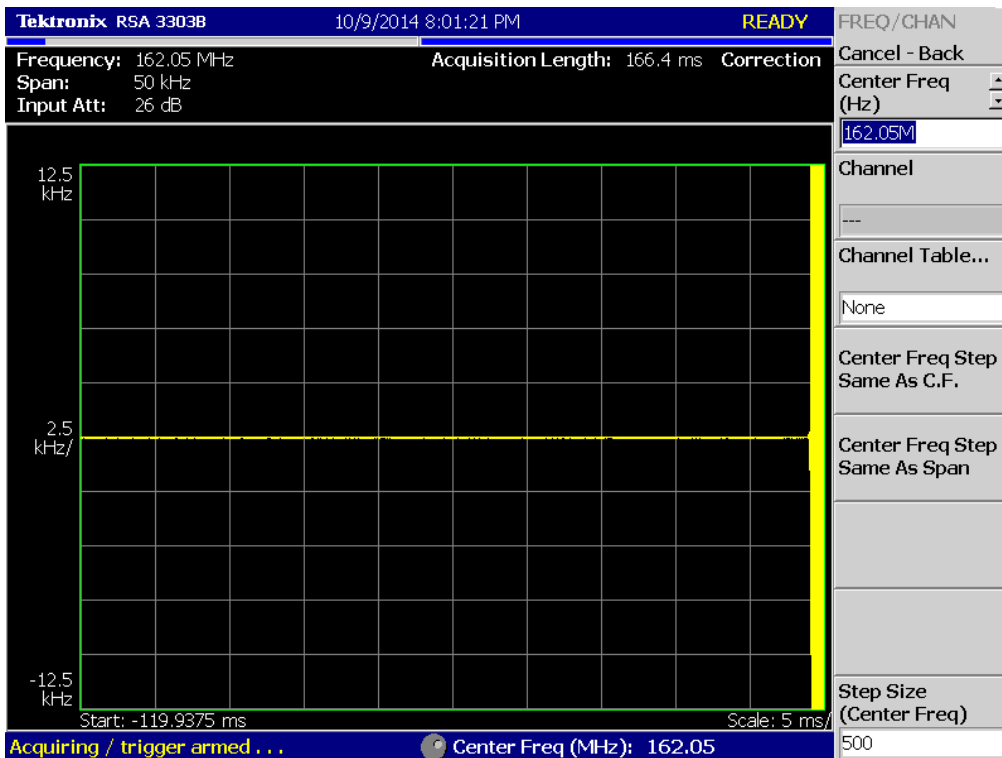
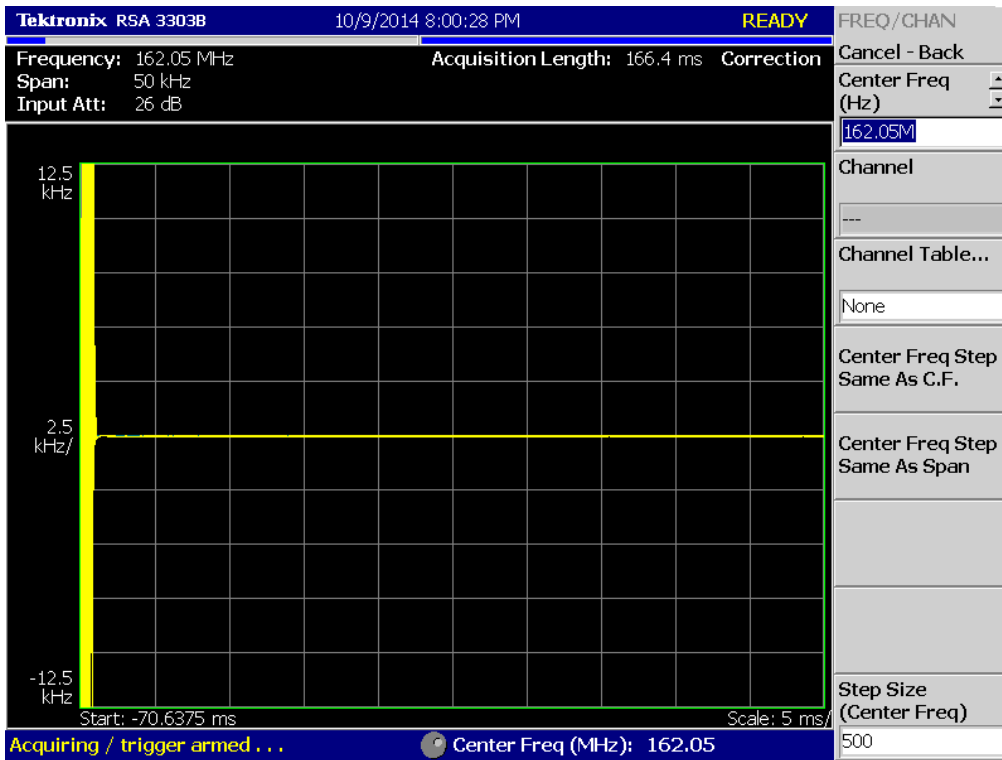

(8K10F1E, 8K10F1D _ 173.95 MHz)_Low

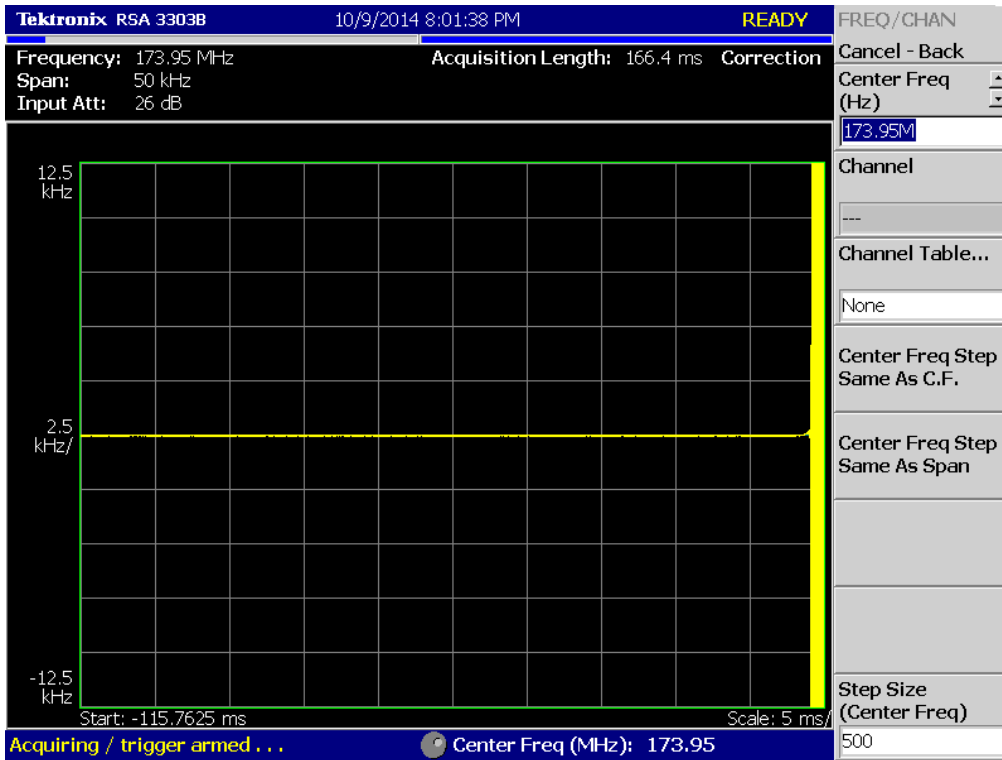
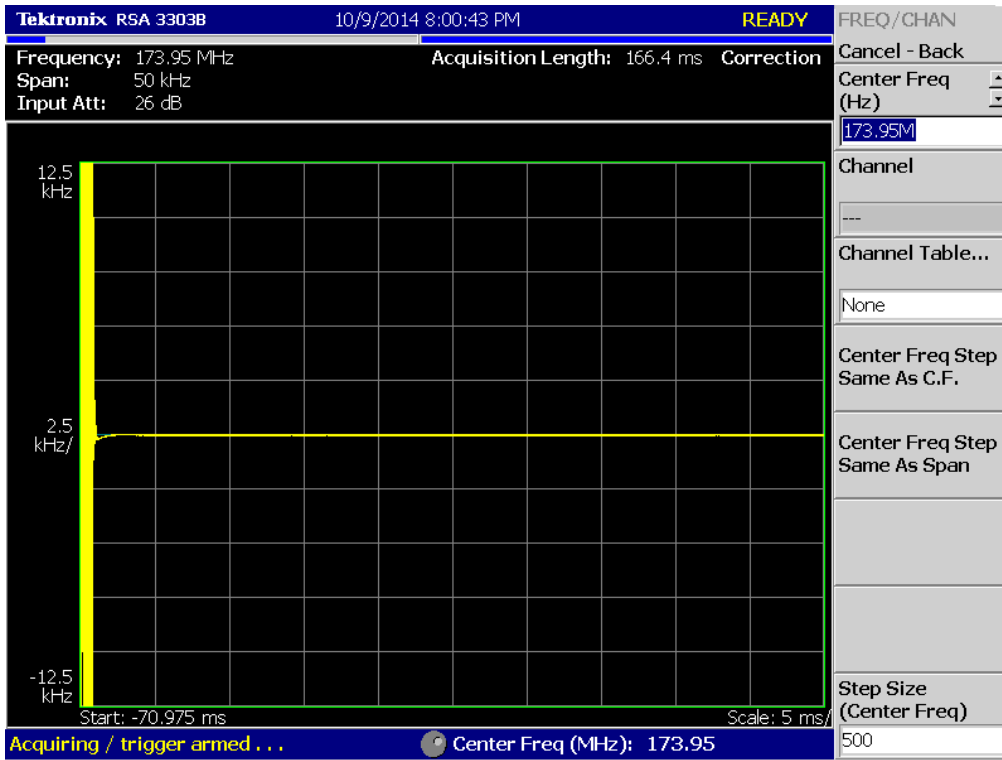

(8K10F1W _ 150.05 MHz)_High

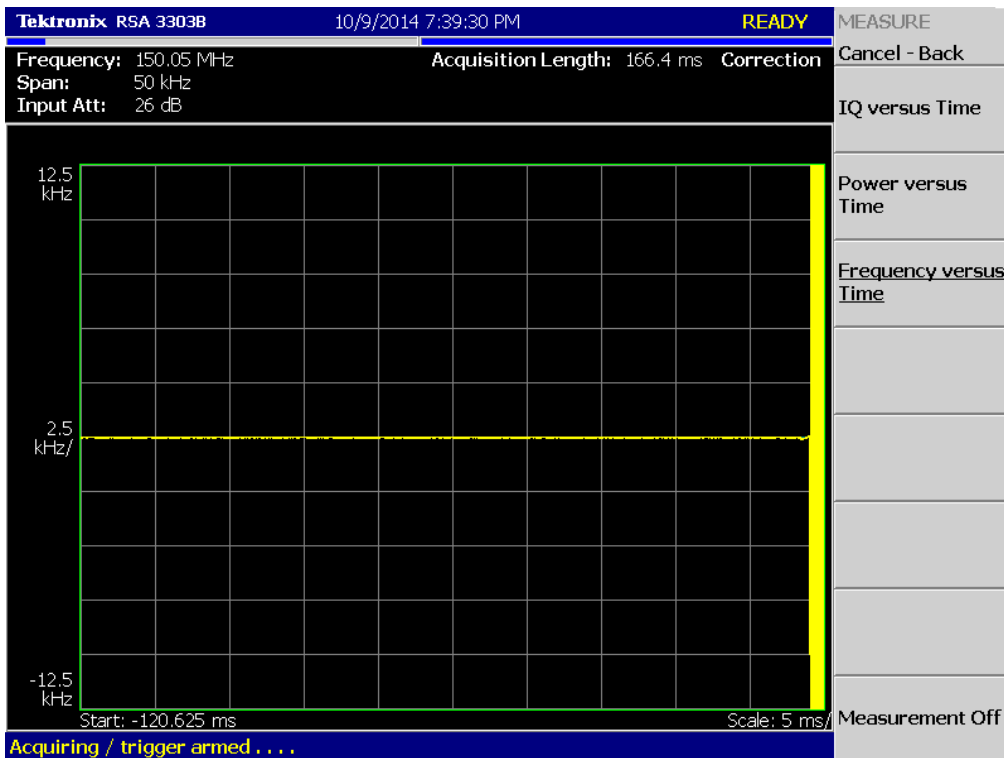
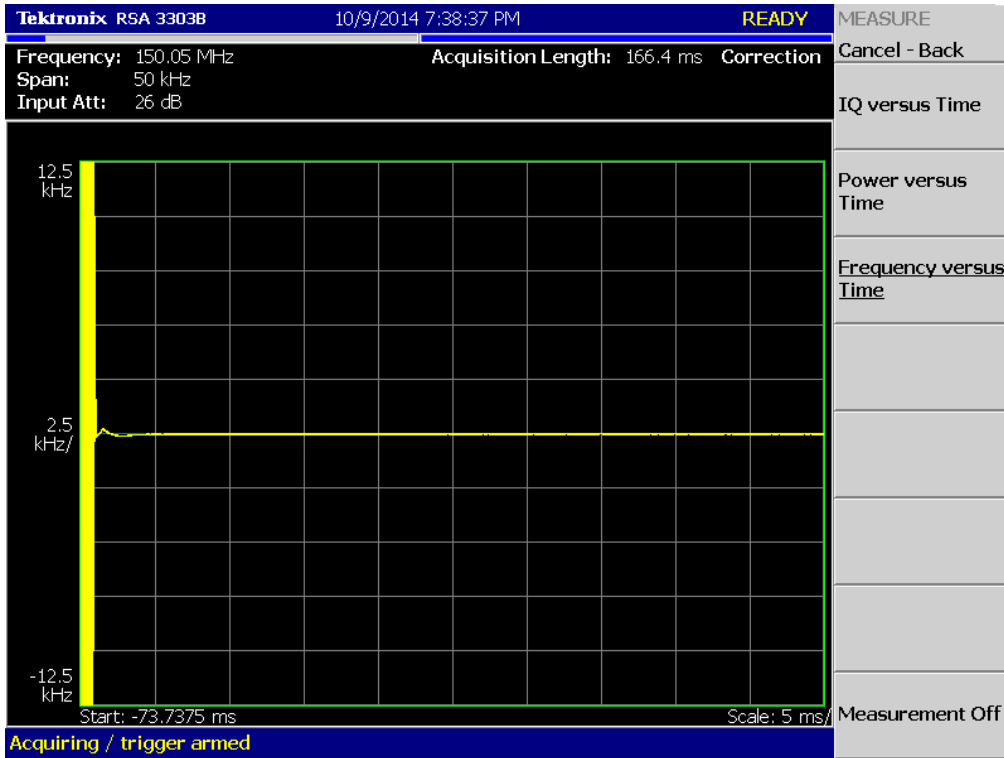

(8K10F1W _ 162.05 MHz)_High

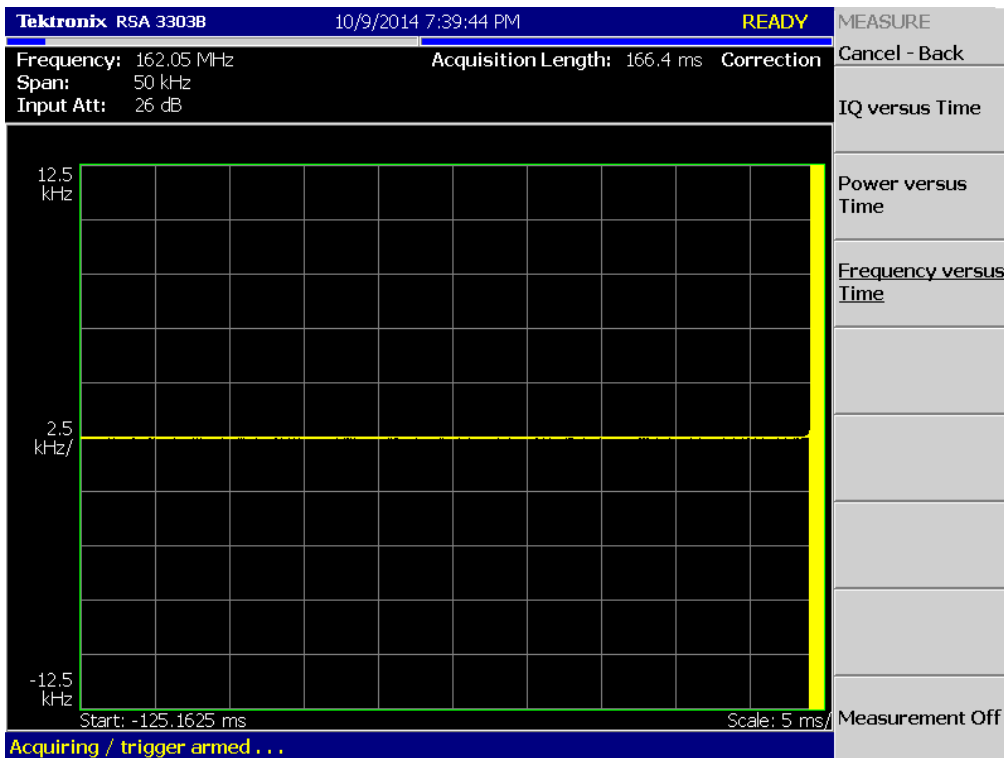
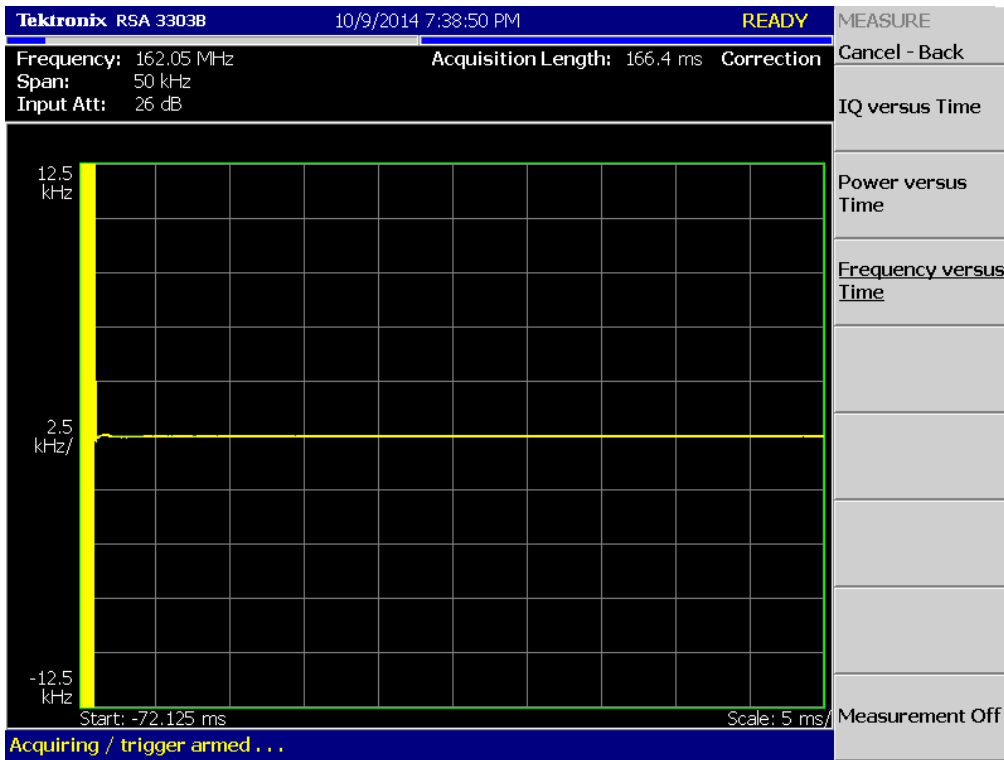

(8K10F1W _ 173.95 MHz)_High

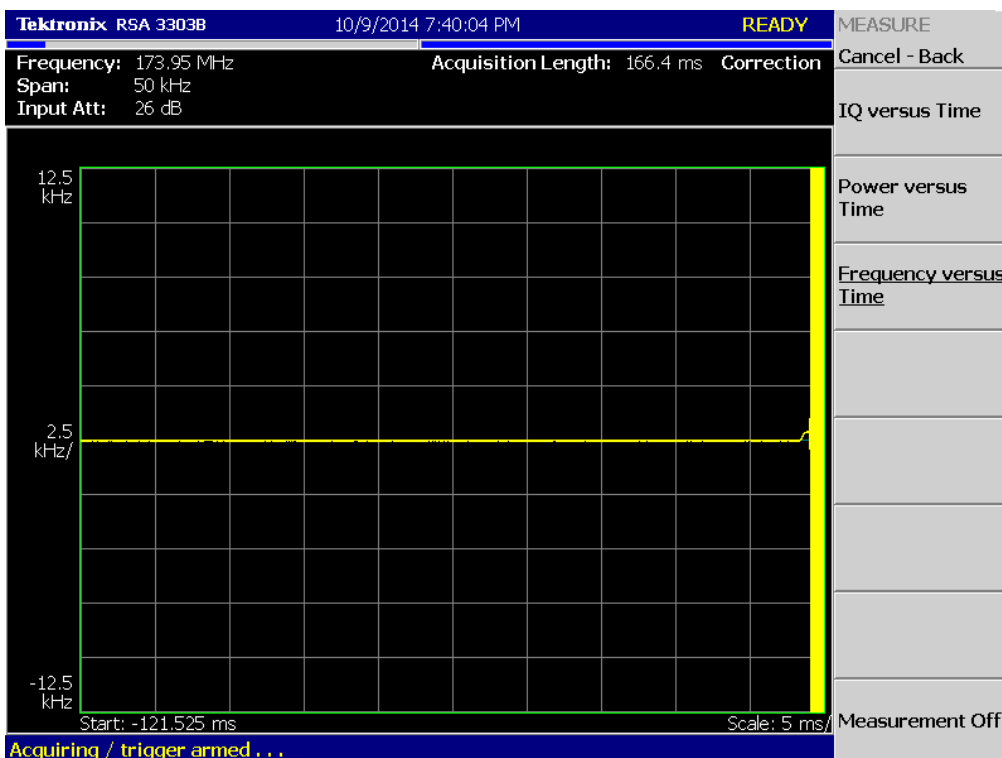
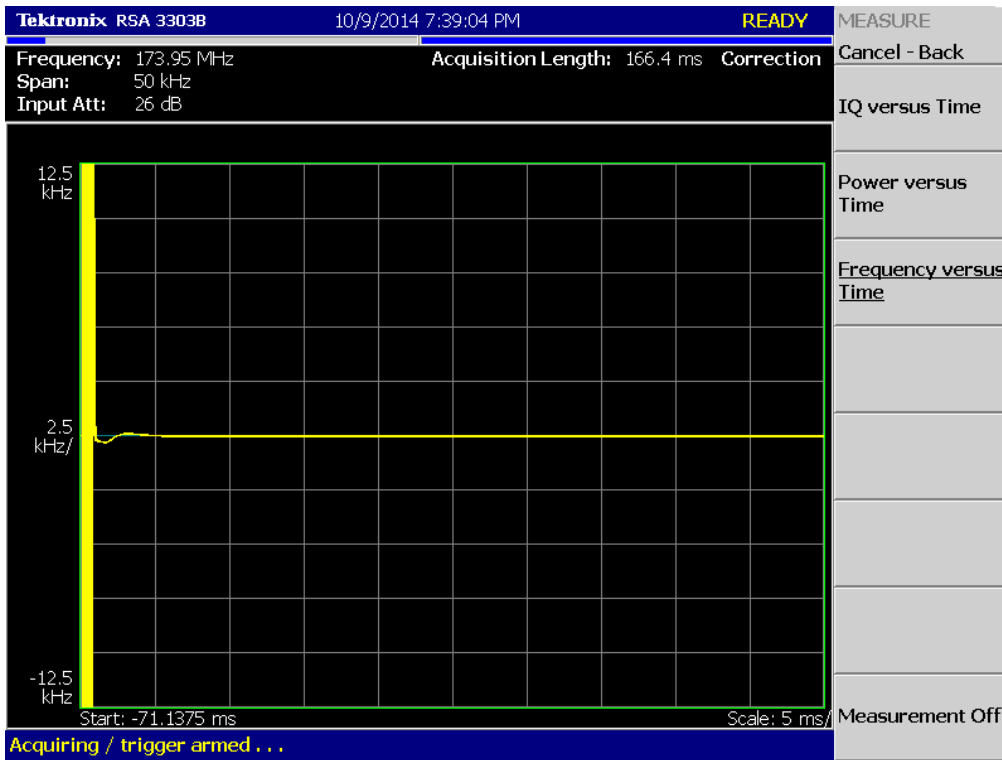

(8K10F1W _ 150.05 MHz)_Low

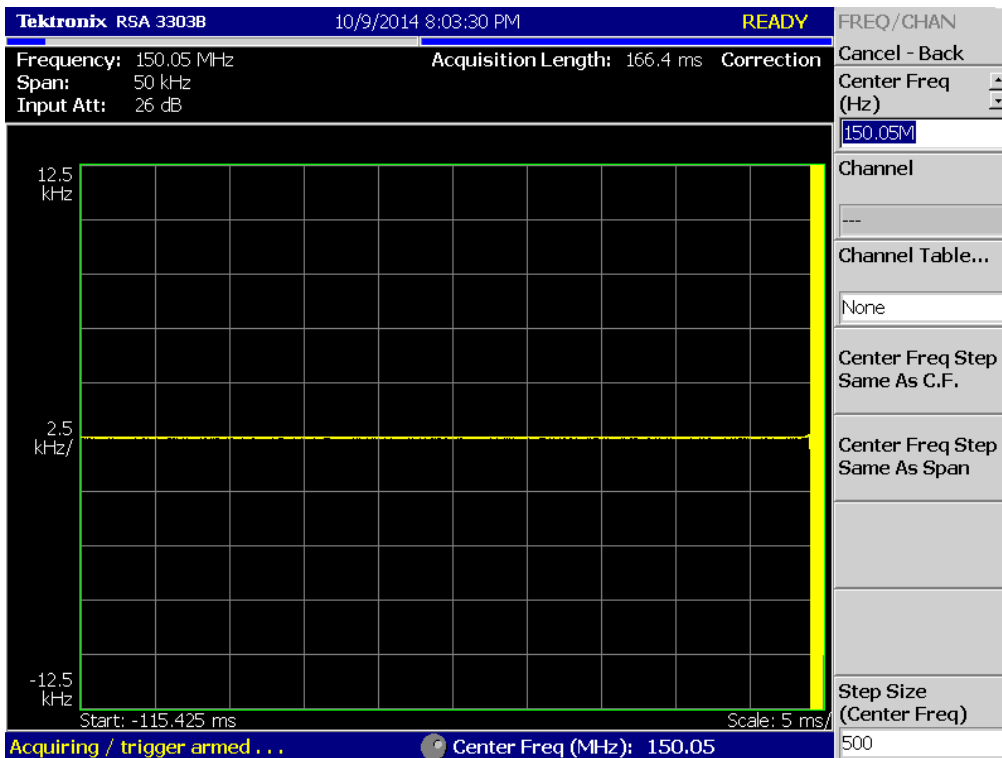
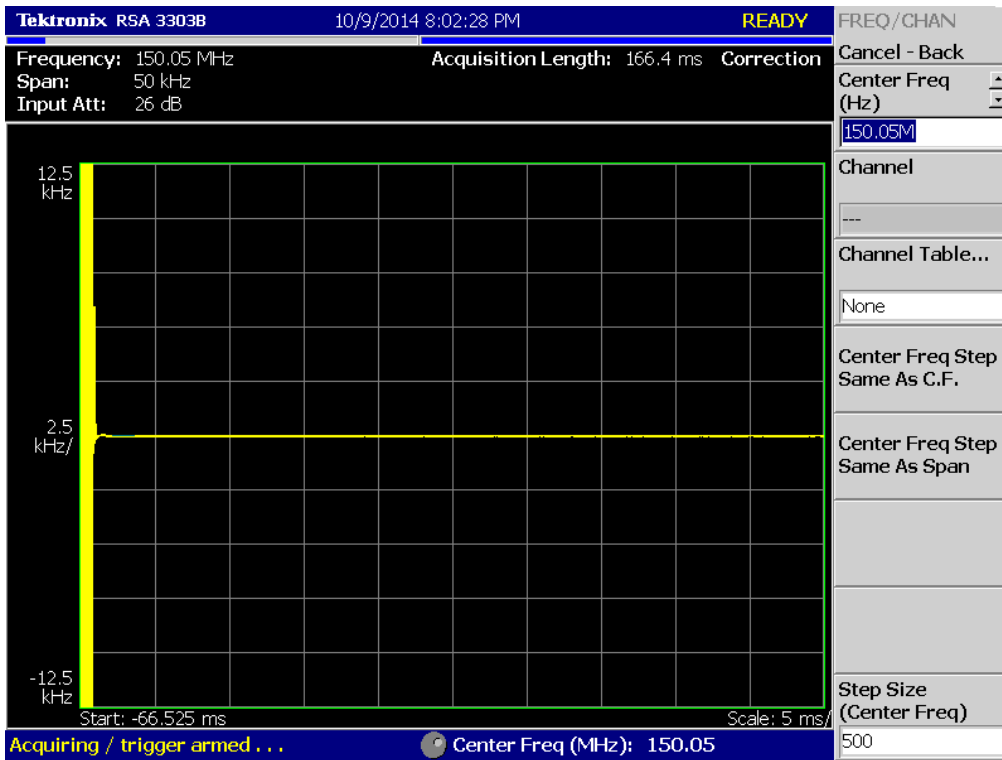

(8K10F1W _ 162.05 MHz)_Low

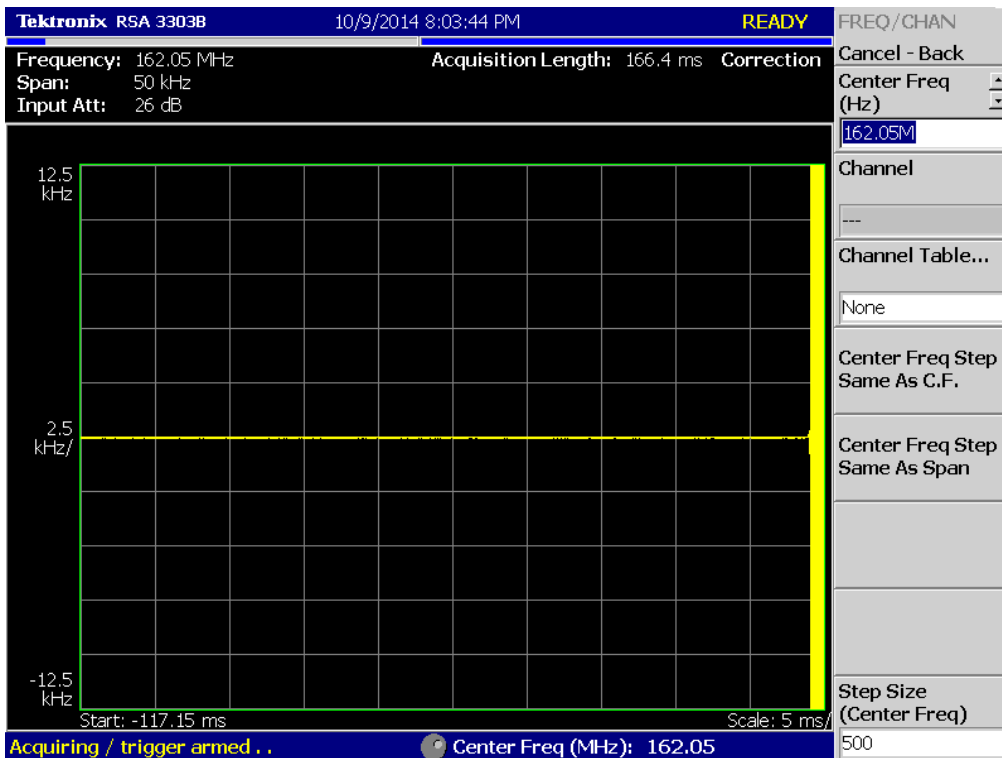
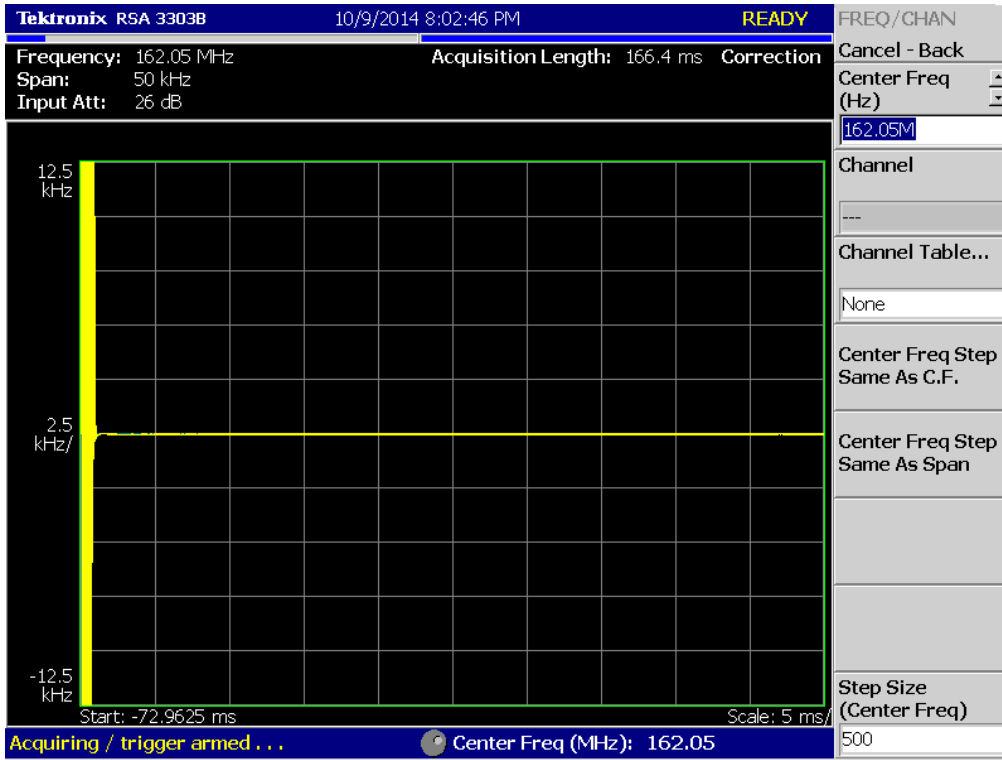

(8K10F1W _ 173.95 MHz)_Low

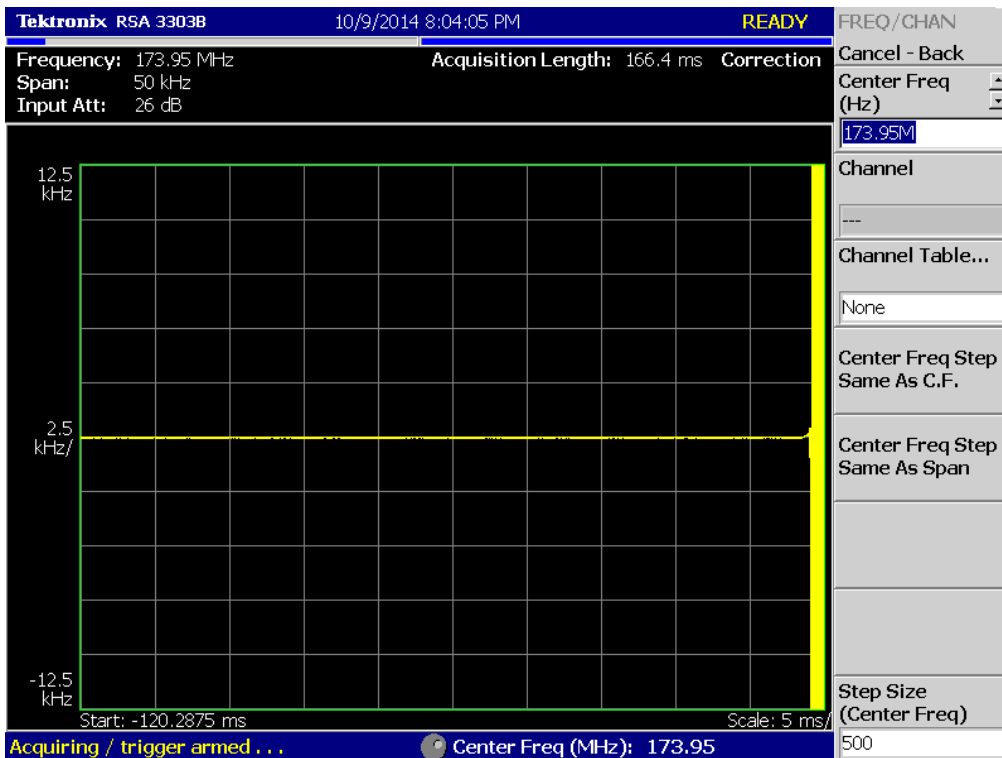
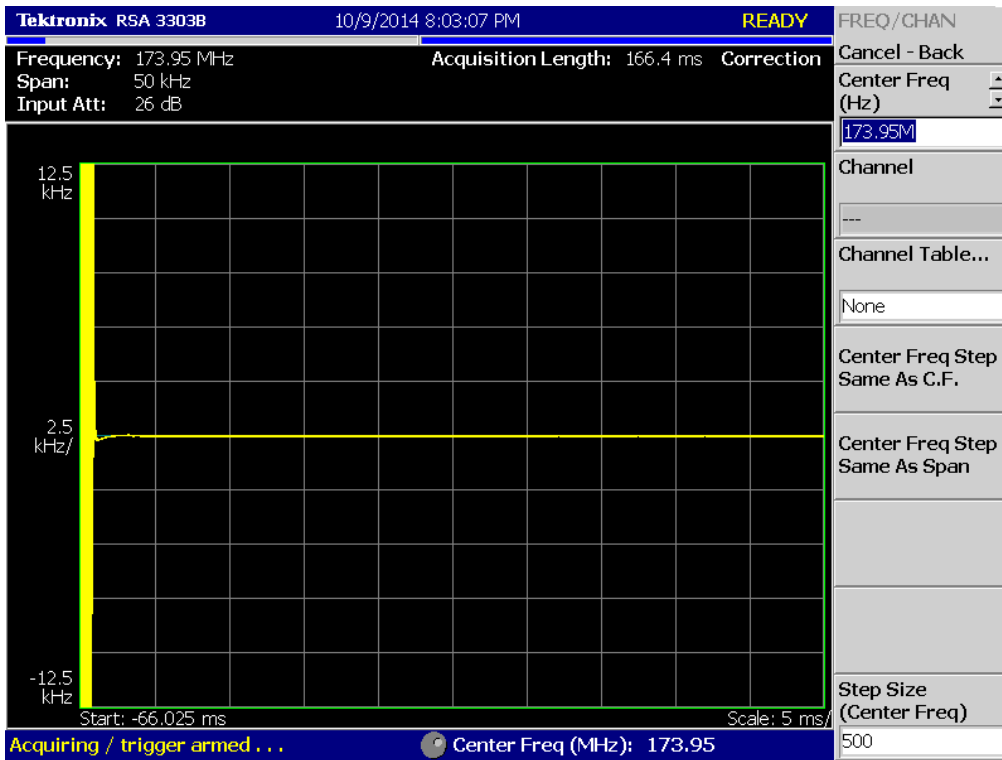

(8K30F1E, 8K30F1D, 8K30F7W _ 150.05 MHz)_High

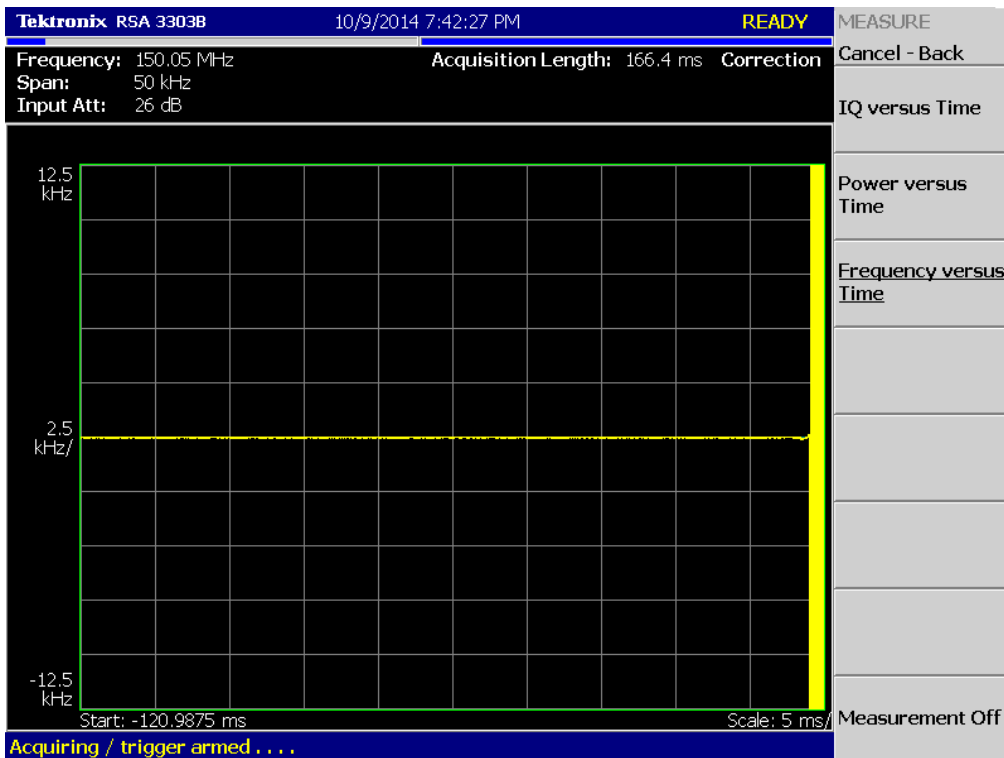
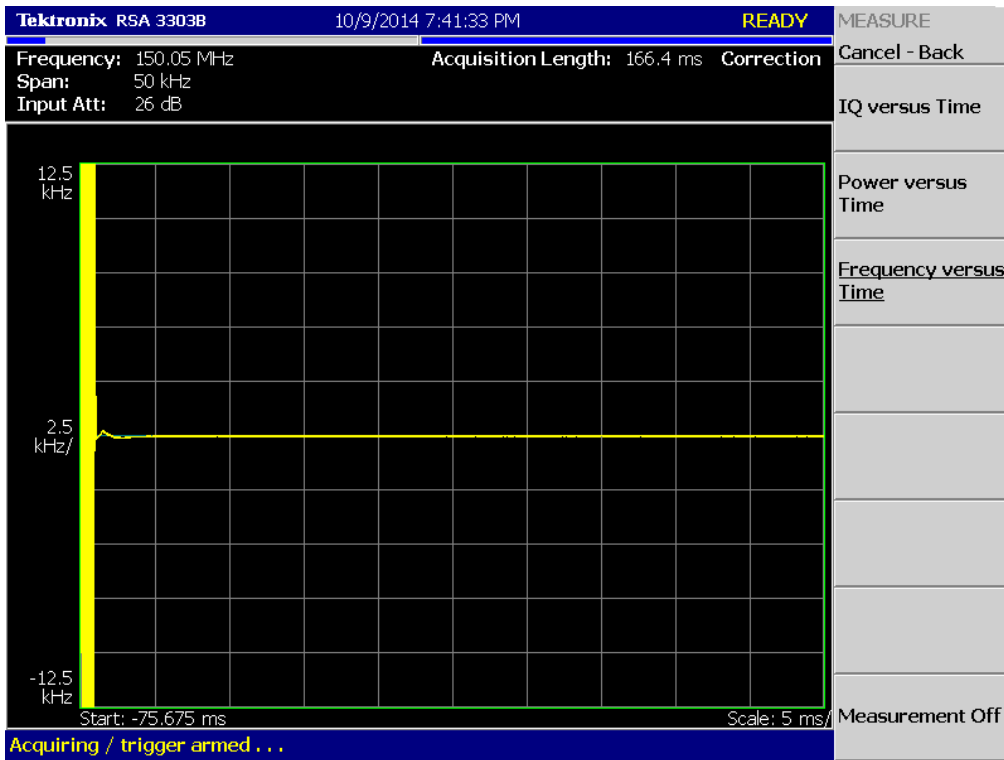

(8K30F1E, 8K30F1D, 8K30F7W _ 162.05 MHz)_High

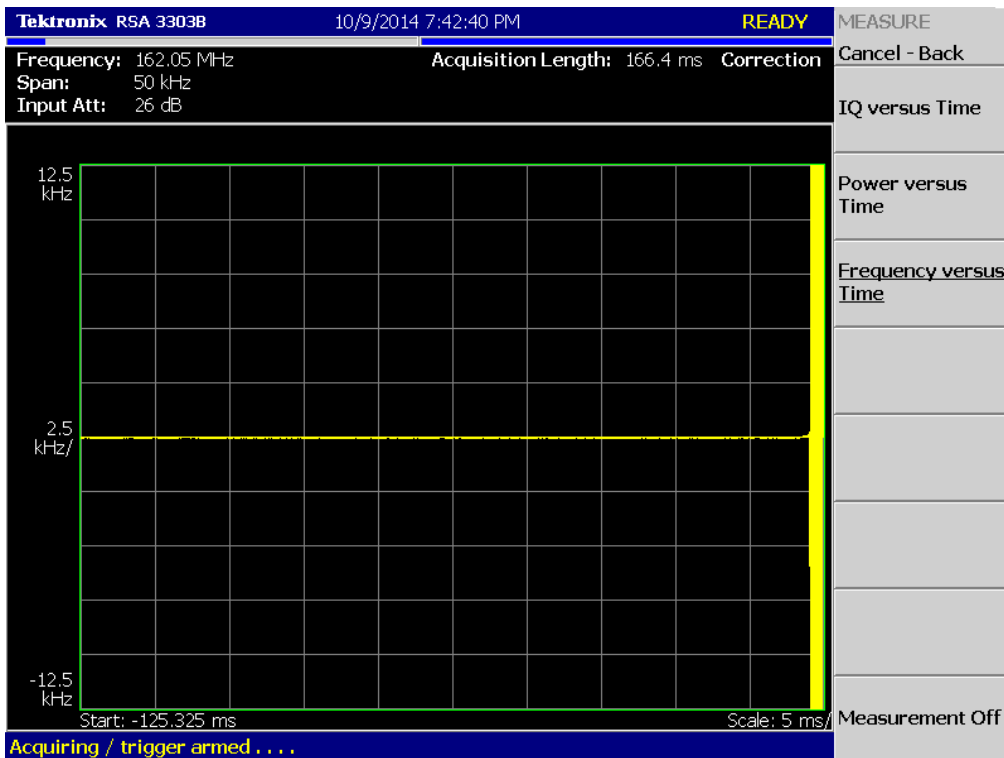
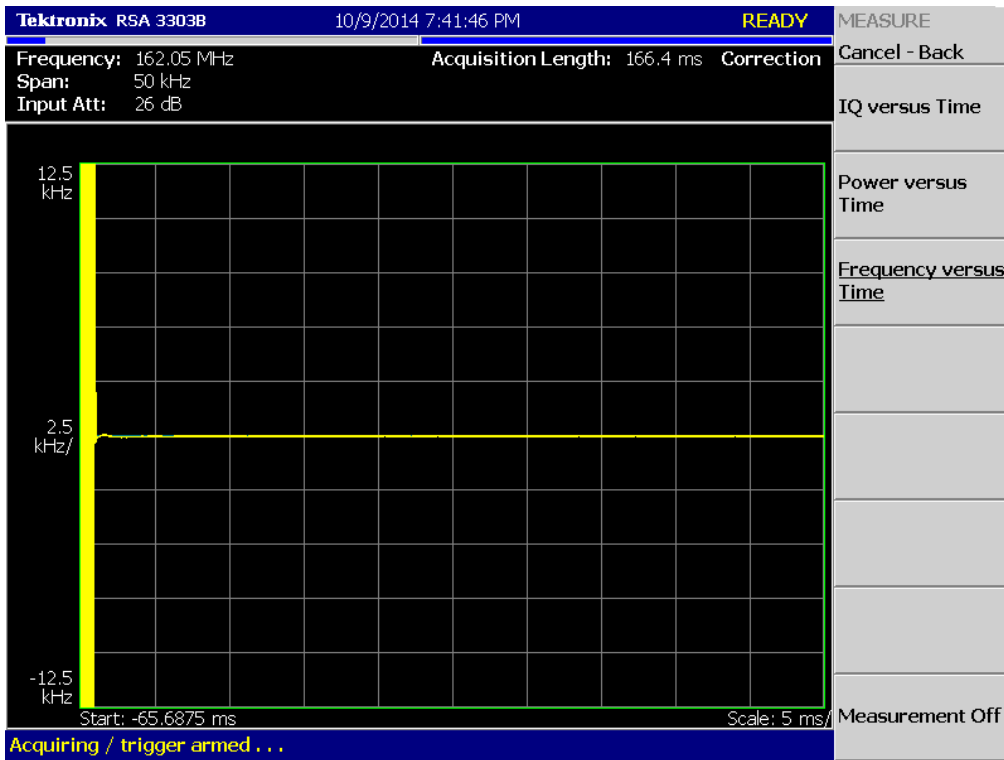

(8K30F1E, 8K30F1D, 8K30F7W _ 173.95 MHz)_High

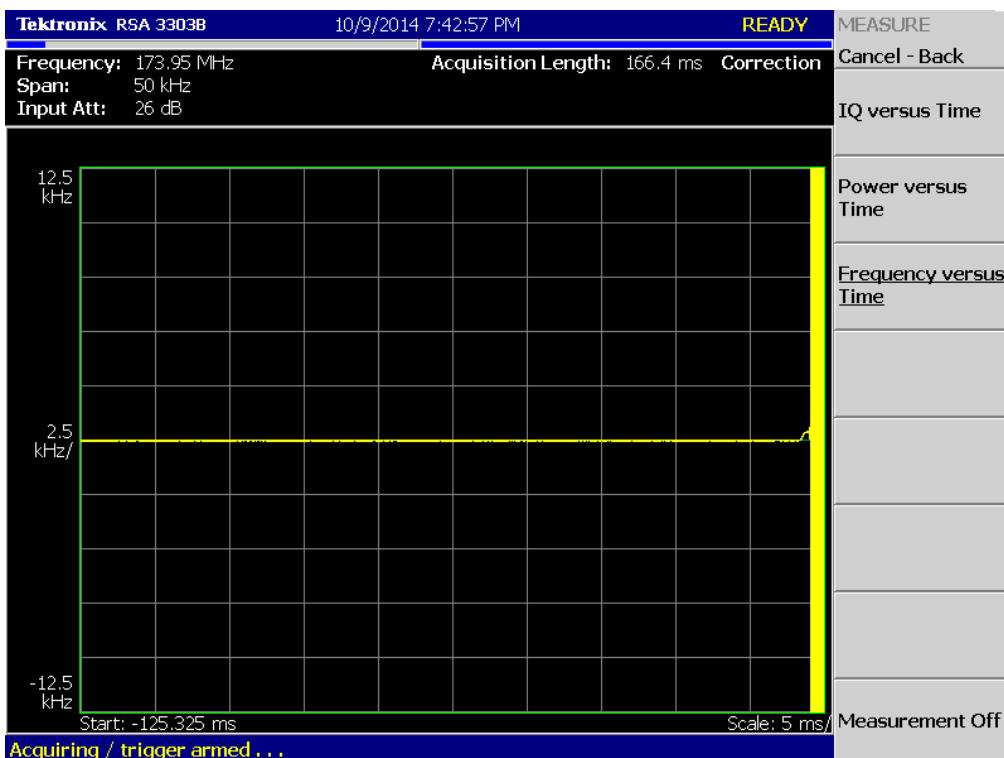
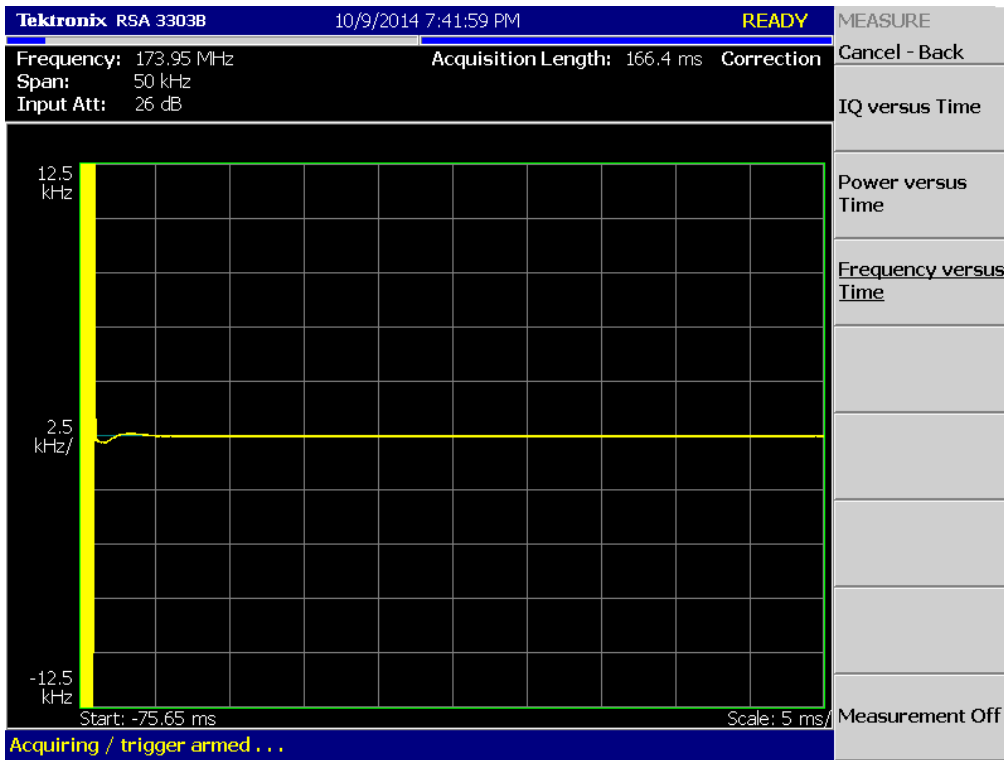

(8K30F1E, 8K30F1D, 8K30F7W _ 150.05 MHz)_Low

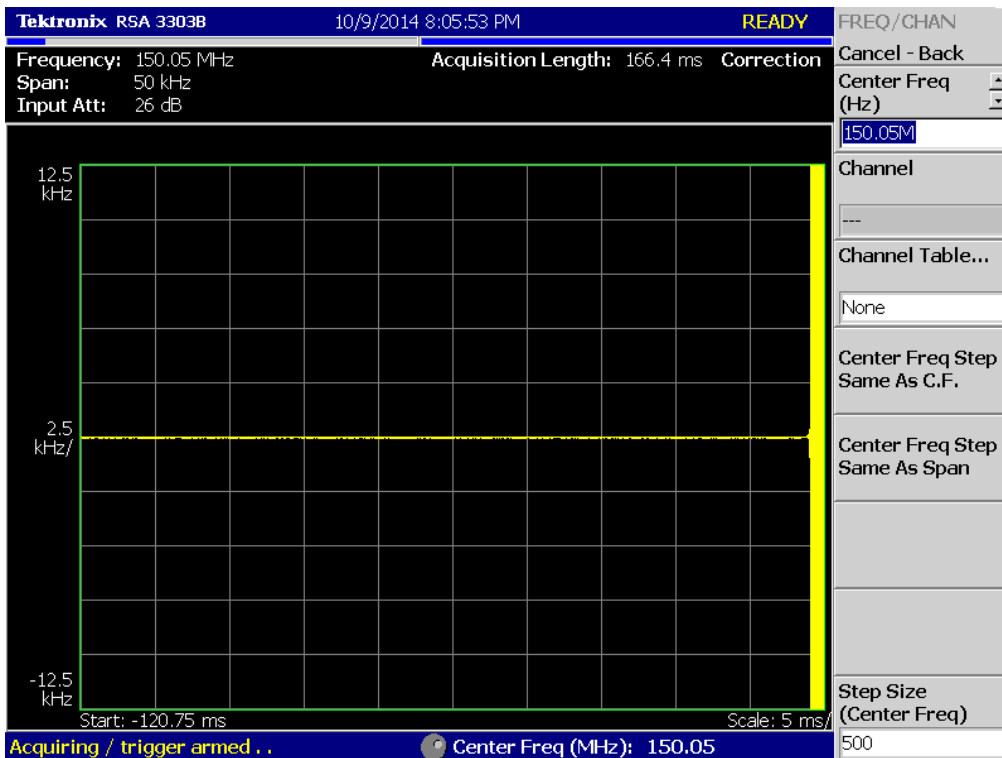
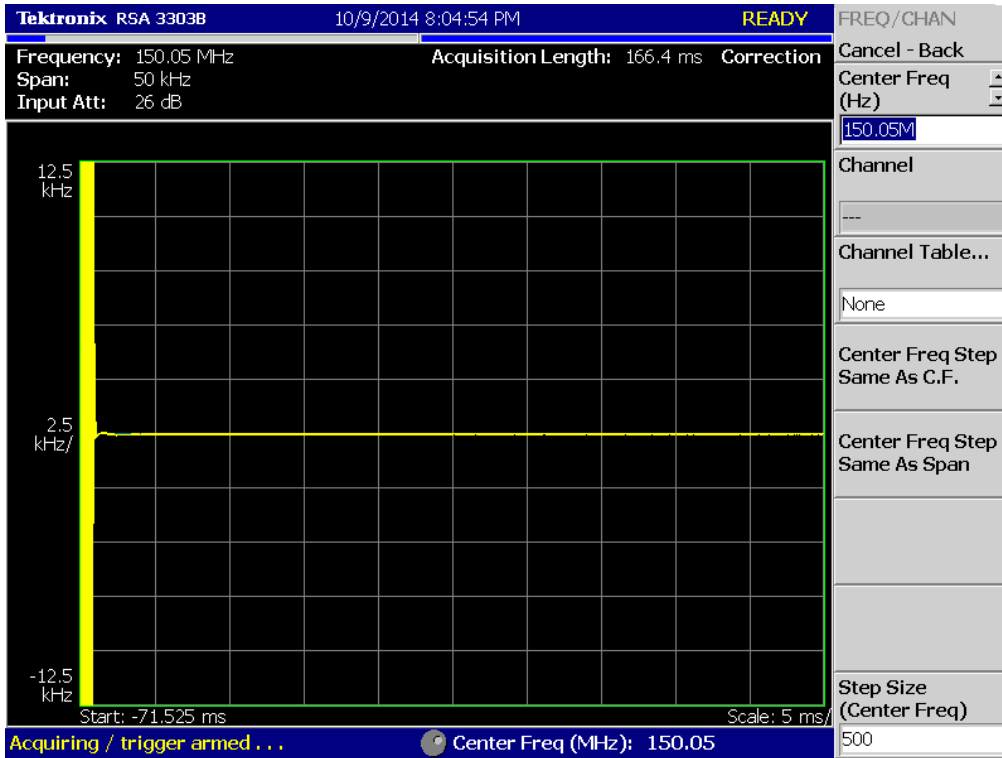

(8K30F1E, 8K30F1D, 8K30F7W _ 162.05 MHz)_Low

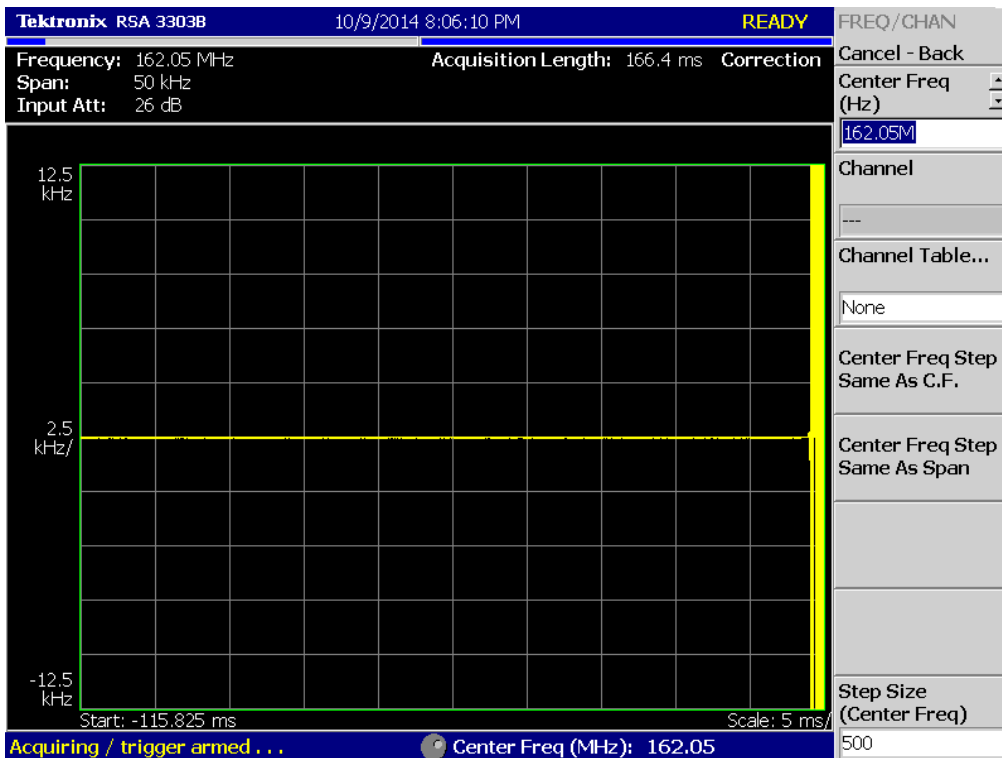
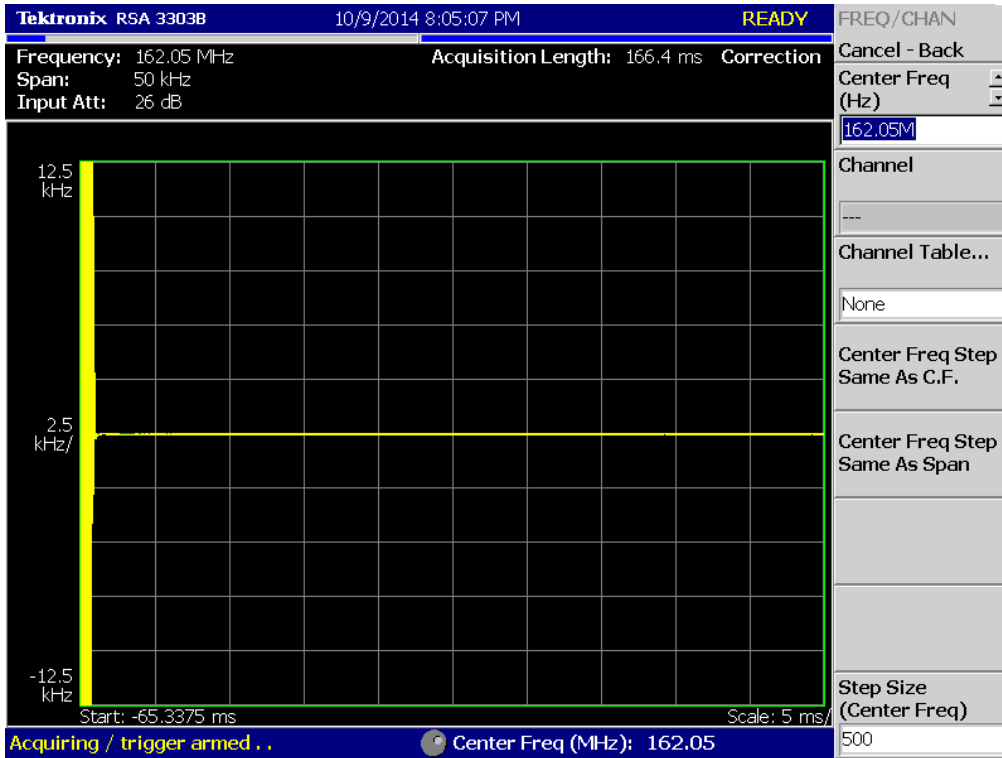

(8K30F1E, 8K30F1D, 8K30F7W _ 173.95 MHz)_Low

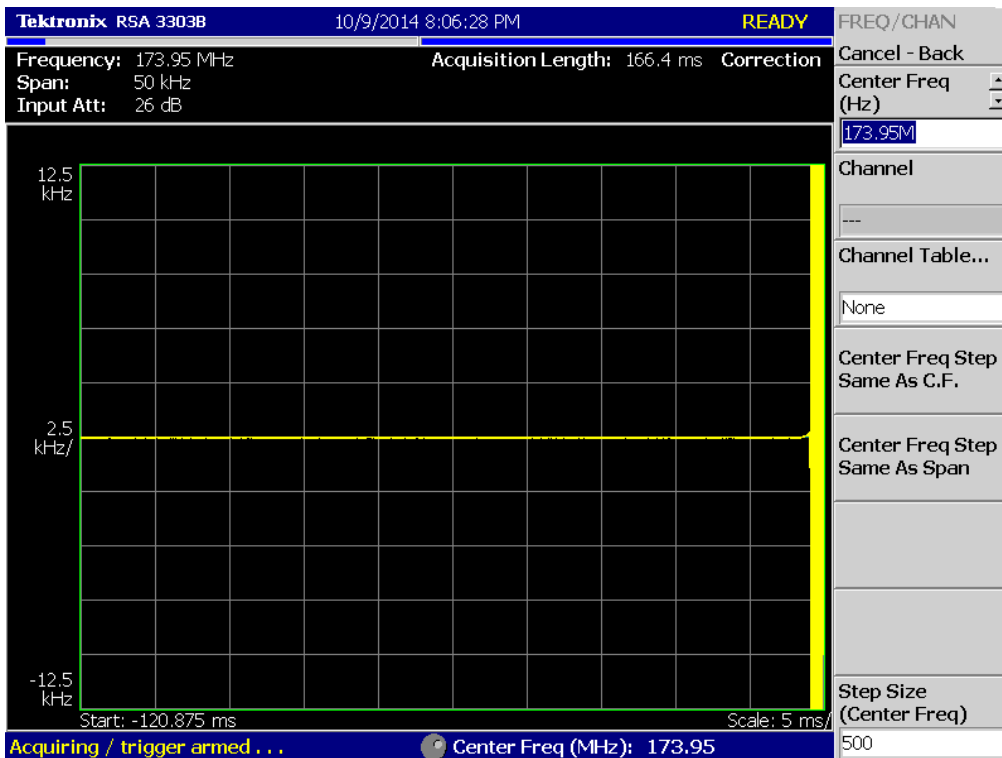
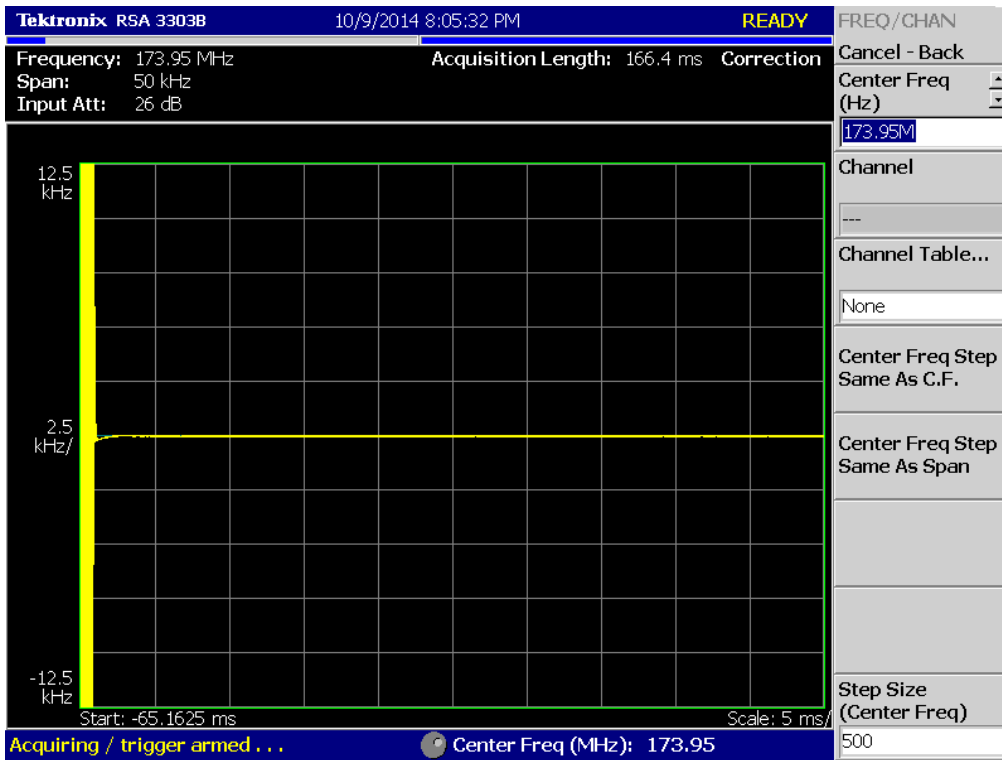

(4K00F1E, 4K00F1D, 4K00F7W _ 150.05 MHz)_High

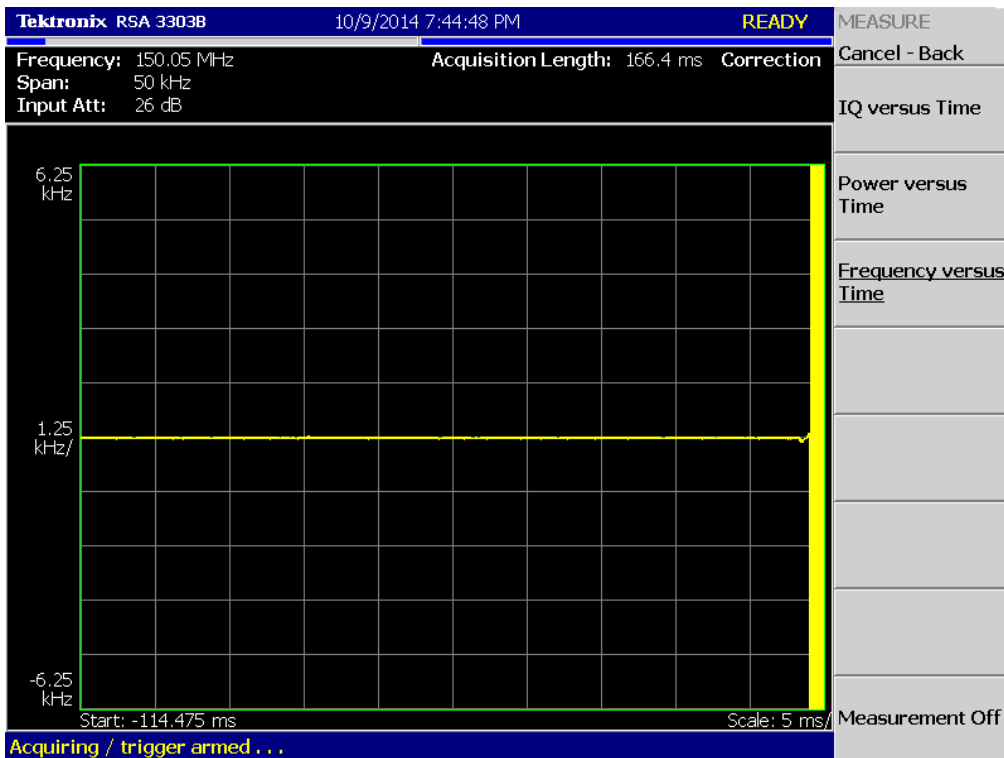
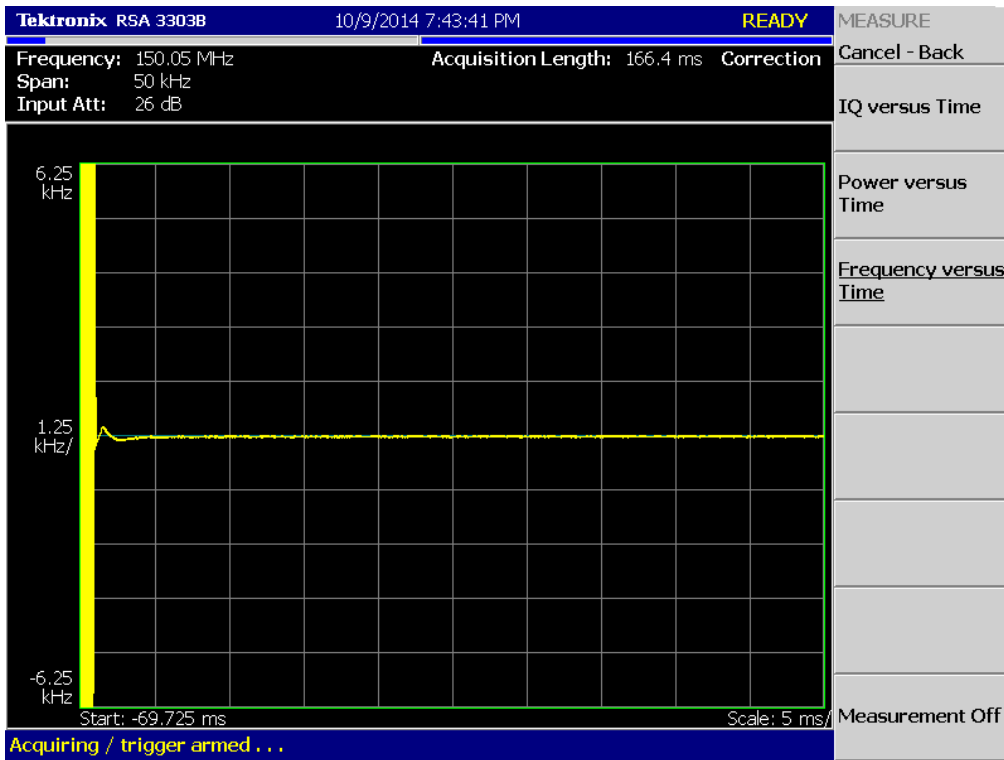

(4K00F1E, 4K00F1D, 4K00F7W _ 162.05 MHz)_High

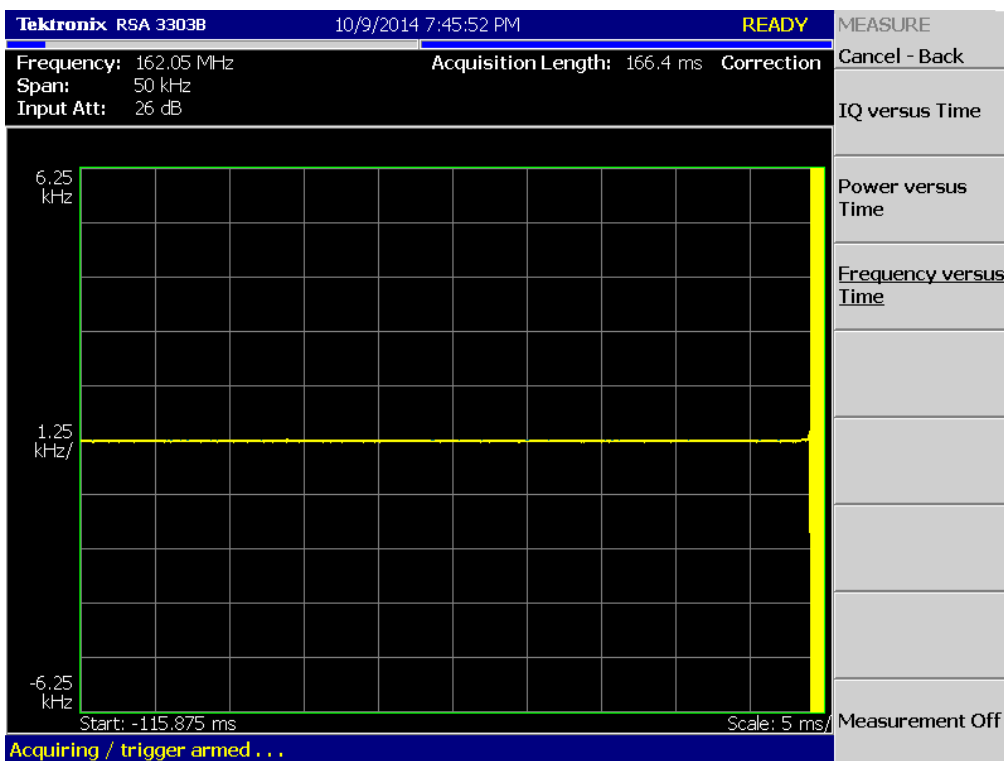
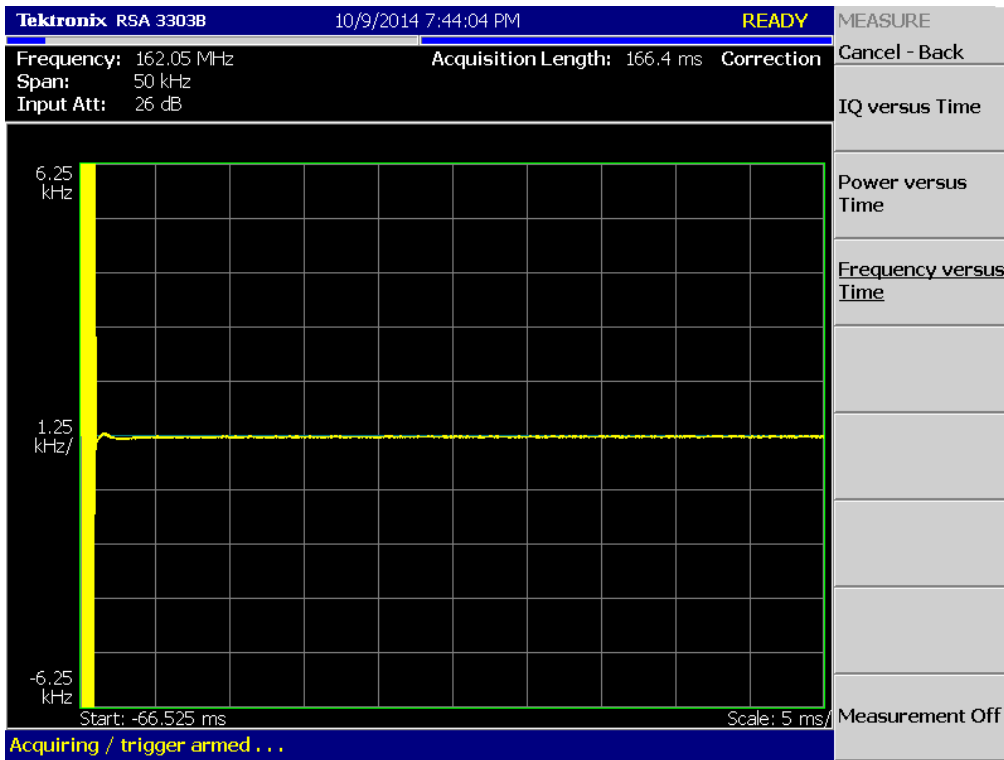

(4K00F1E, 4K00F1D, 4K00F7W _ 173.95 MHz)_High

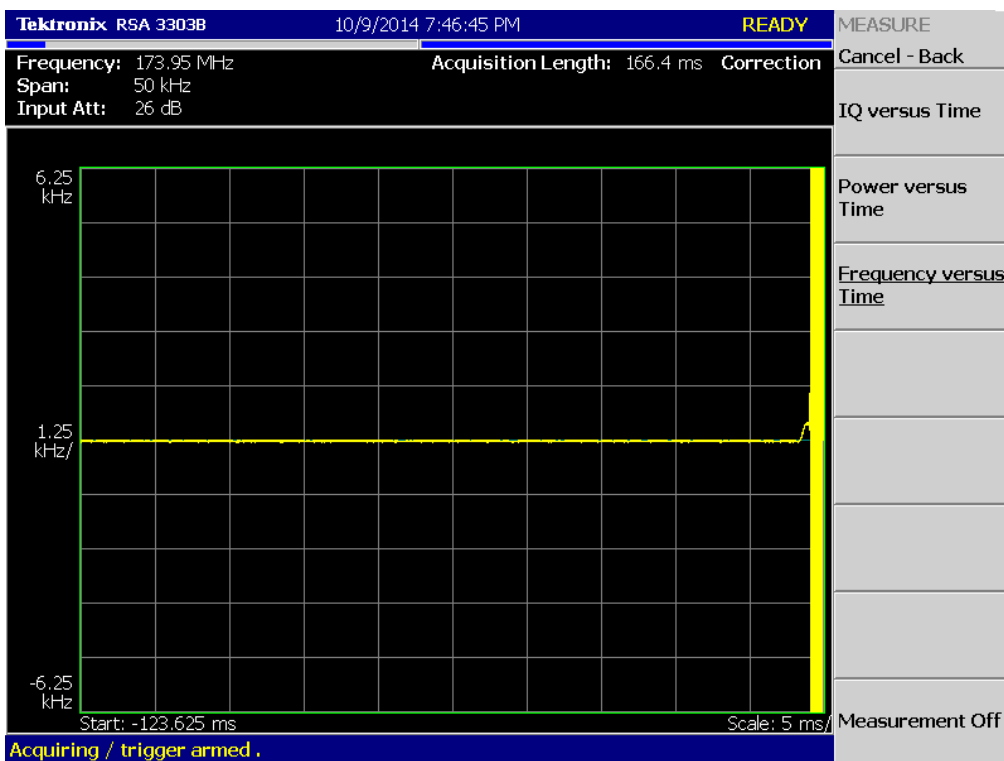
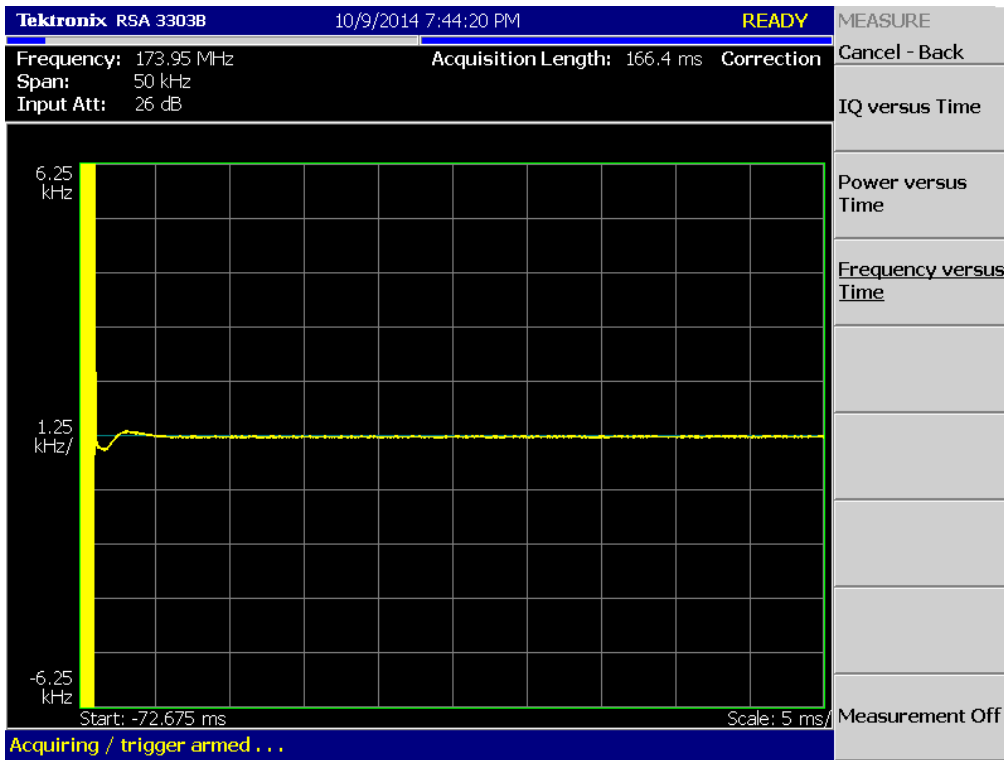

(4K00F1E, 4K00F1D, 4K00F7W _ 150.05 MHz)_Low

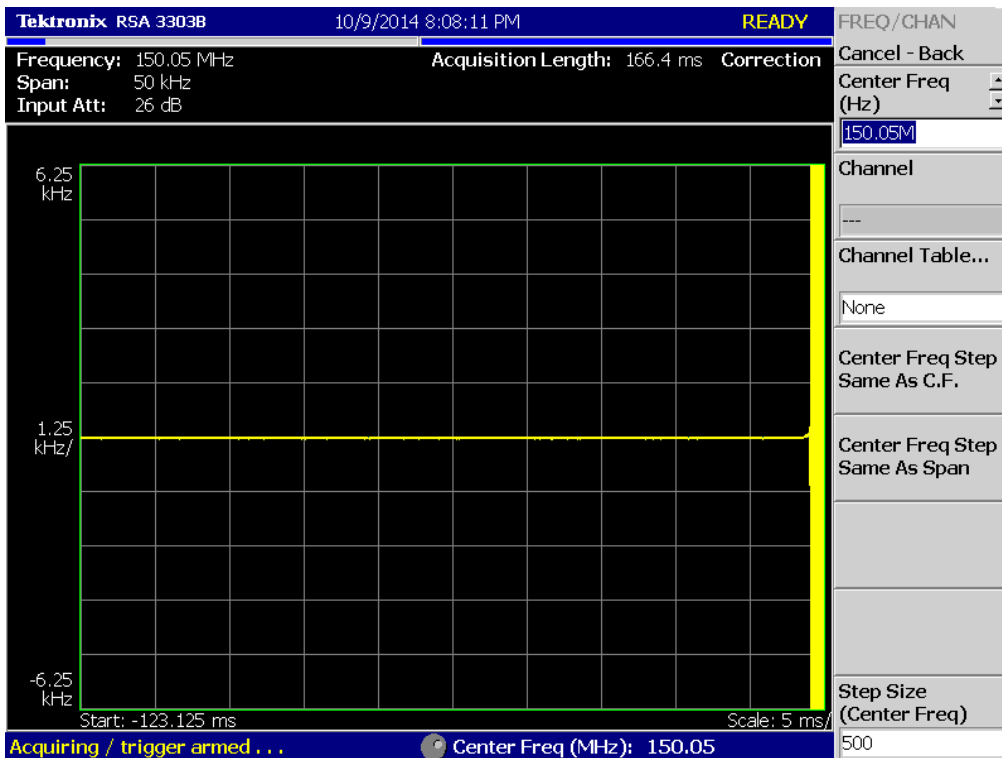
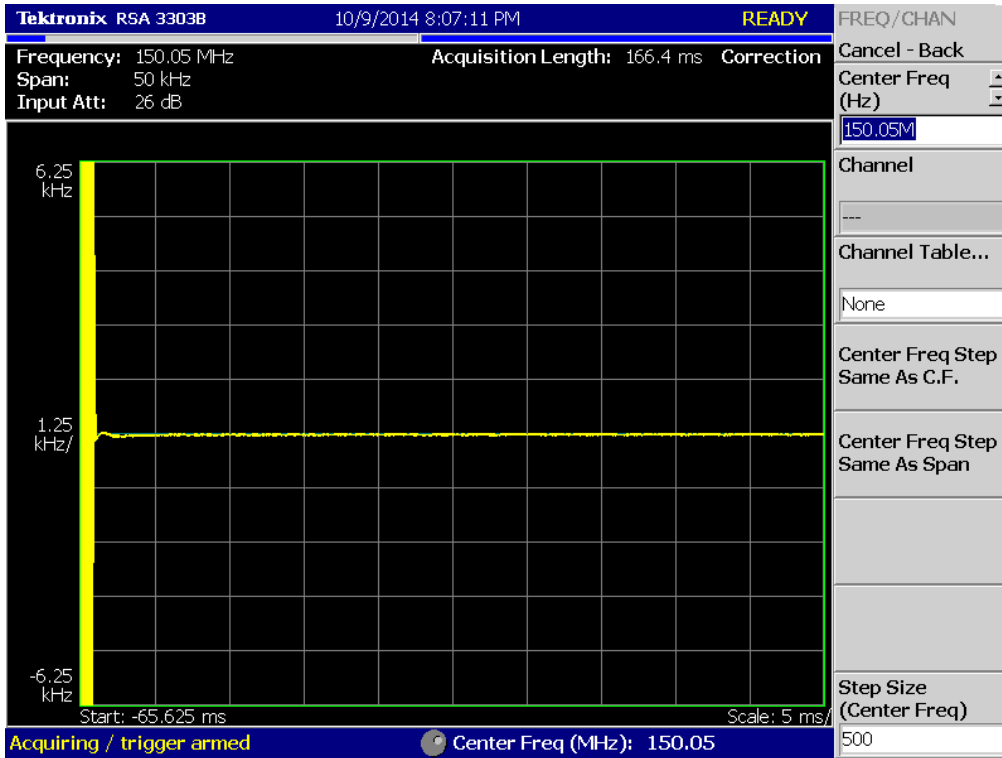

(4K00F1E, 4K00F1D, 4K00F7W _ 162.05 MHz)_Low

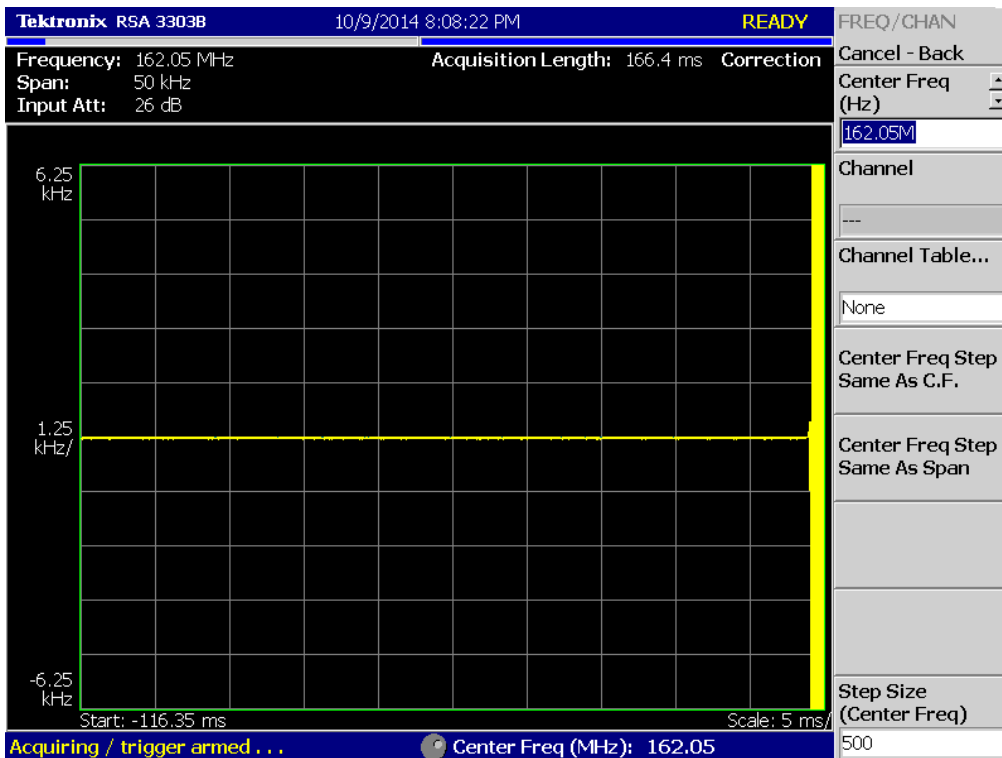
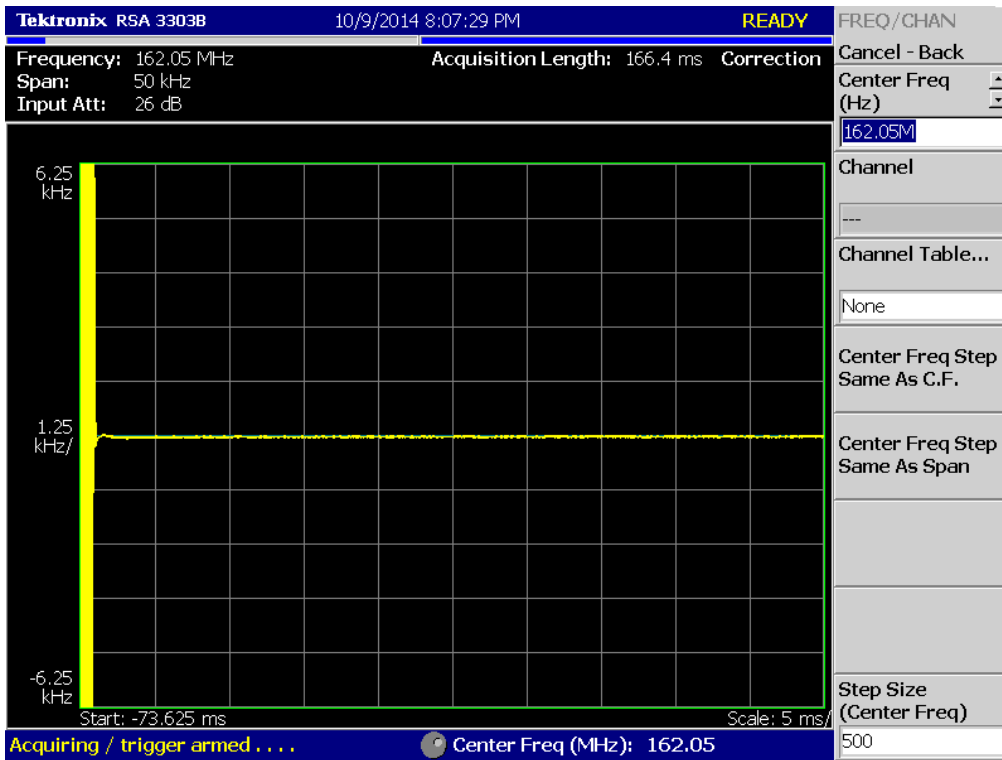

(4K00F1E, 4K00F1D, 4K00F7W _ 173.95 MHz)_Low

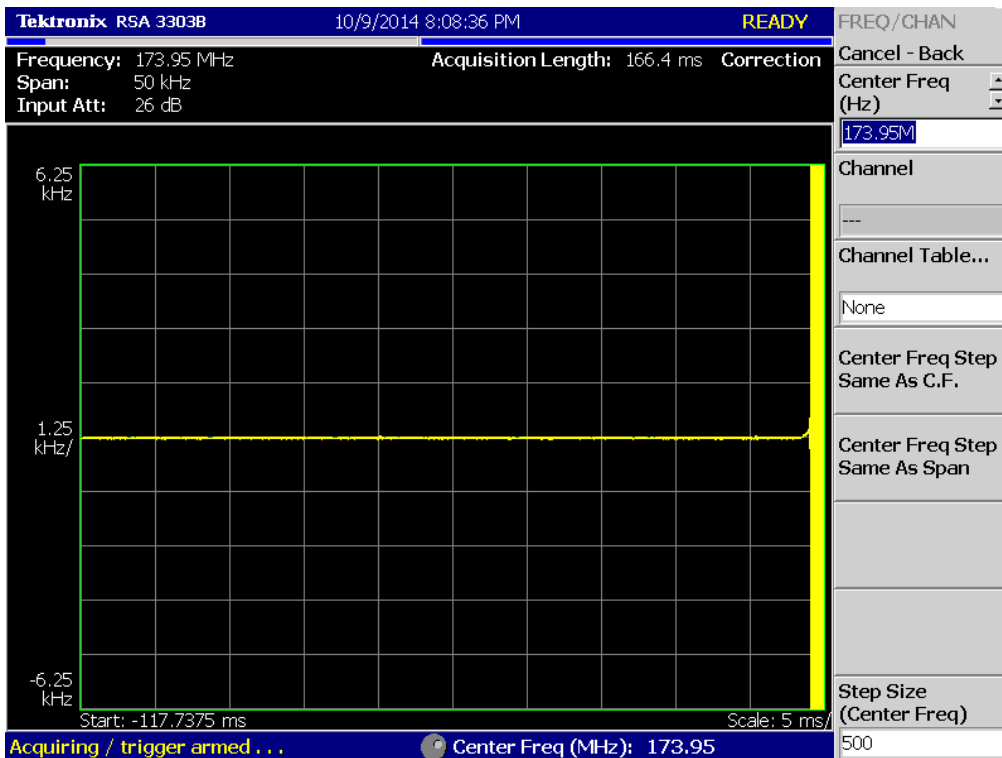
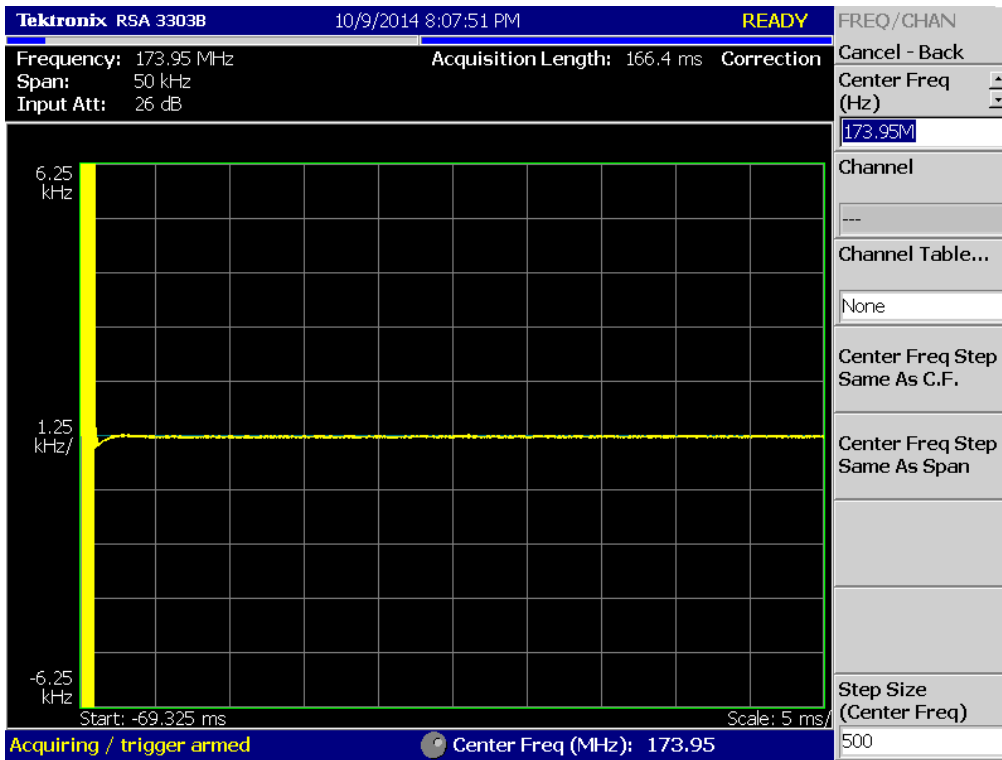

(4K00F2D _ 150.05 MHz)_Low

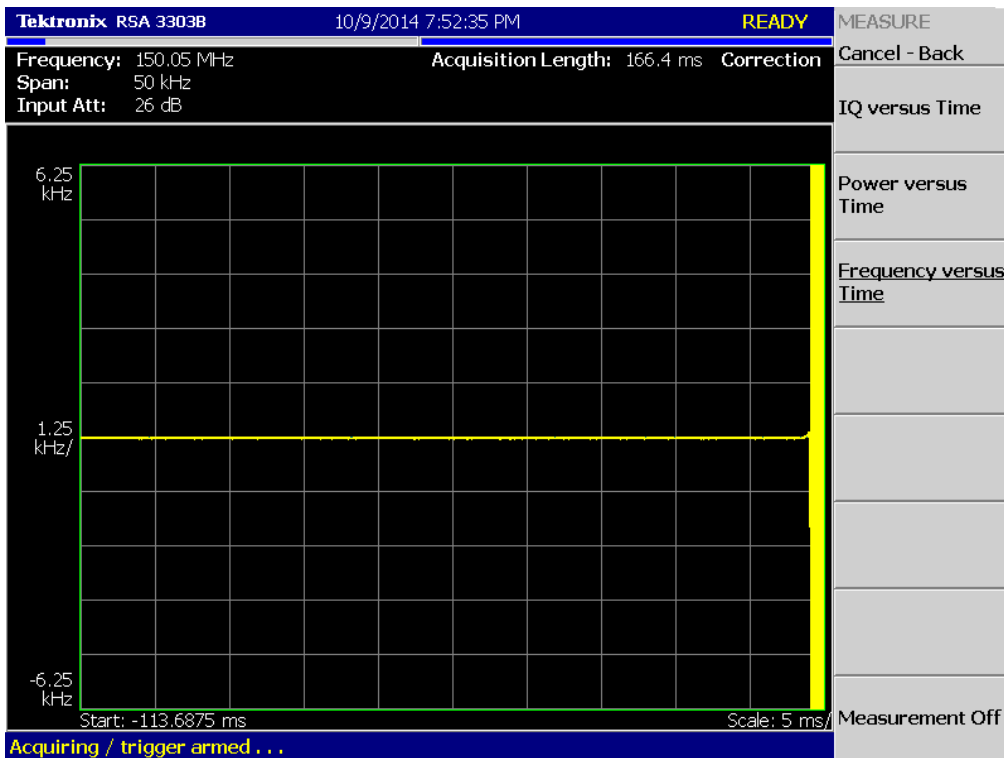
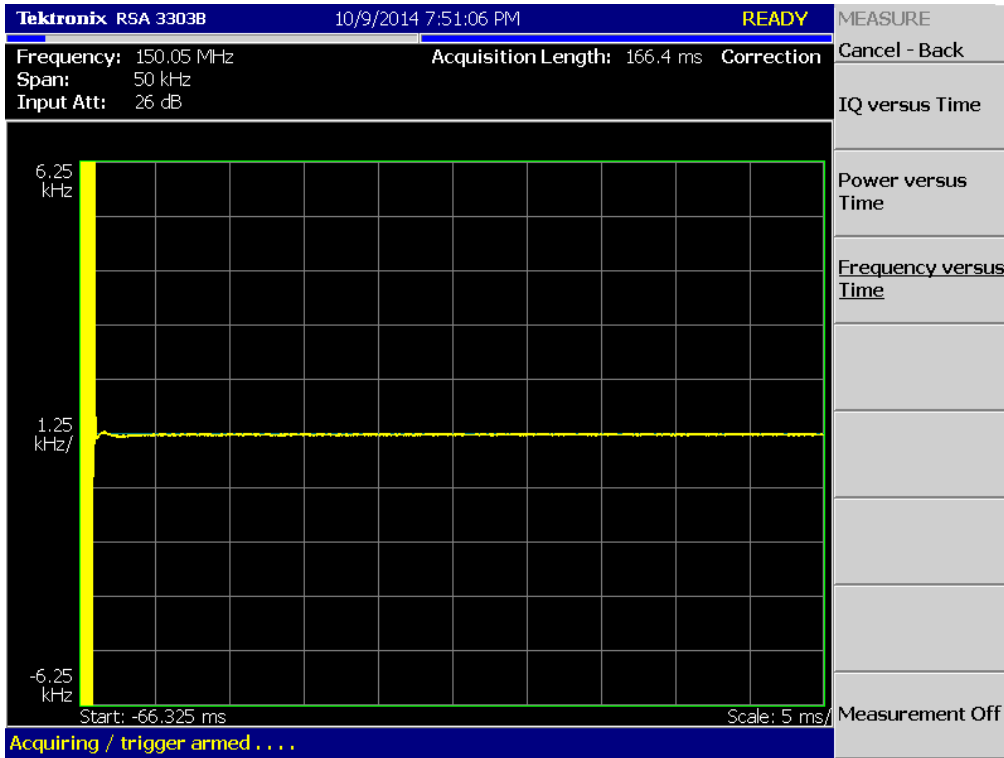

(4K00F2D _ 162.05 MHz)_Low

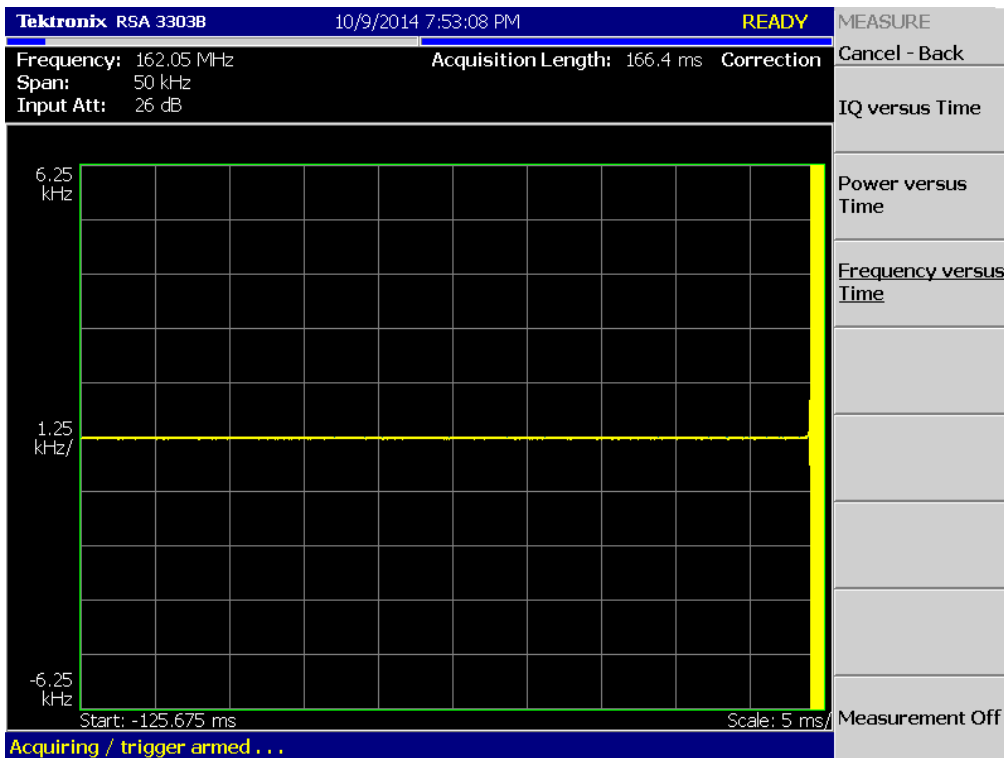
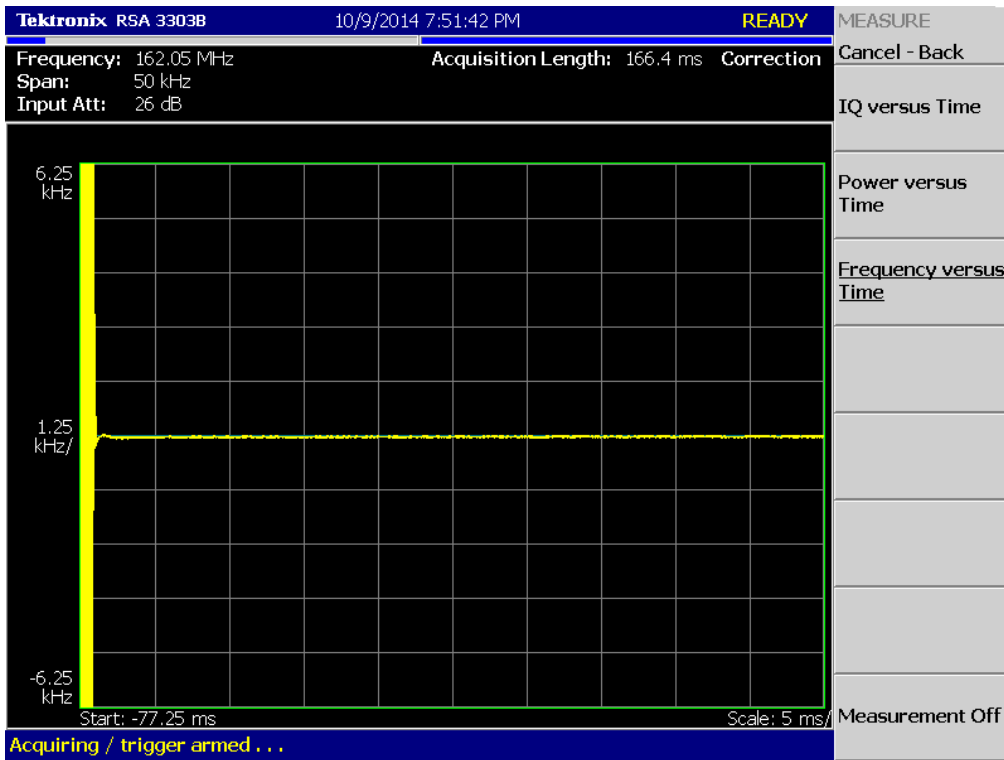

(4K00F2D _ 173.95 MHz)_Low

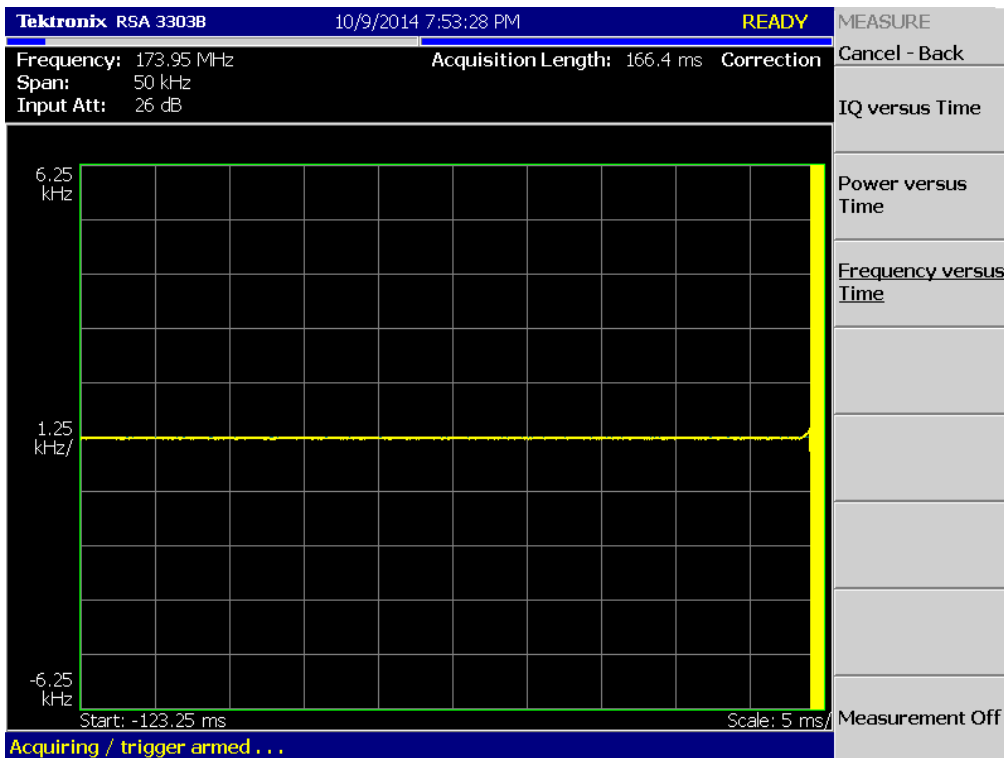
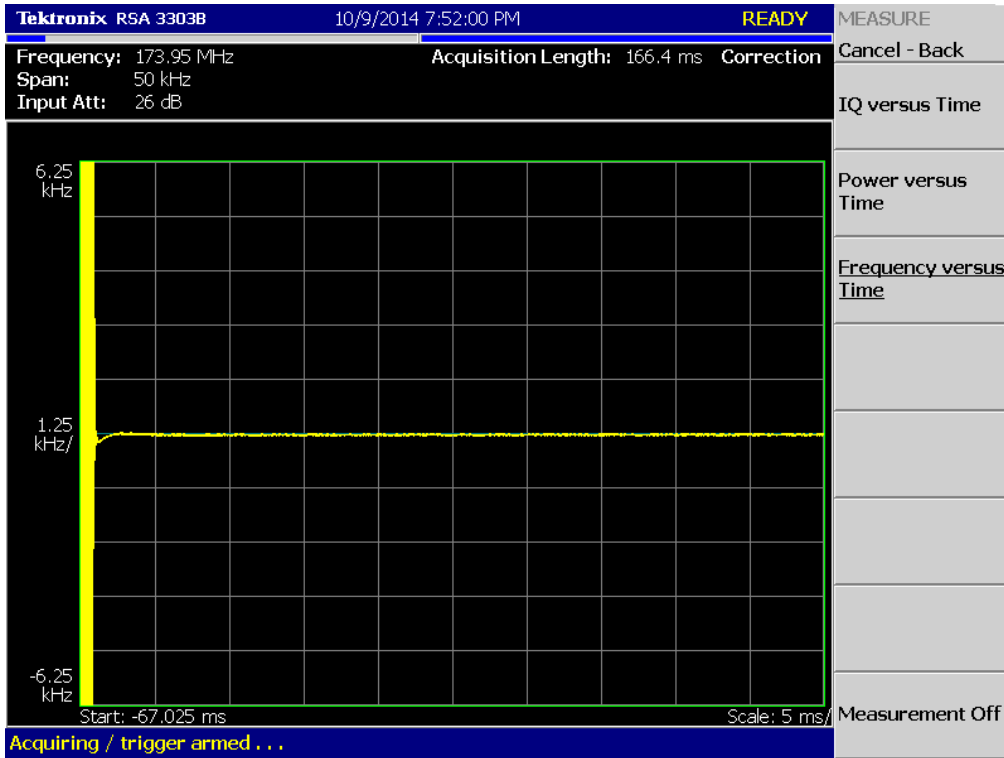

Plots of Transient Frequency Behavior IC

(16K0F3E _ 138.05 MHz)_High

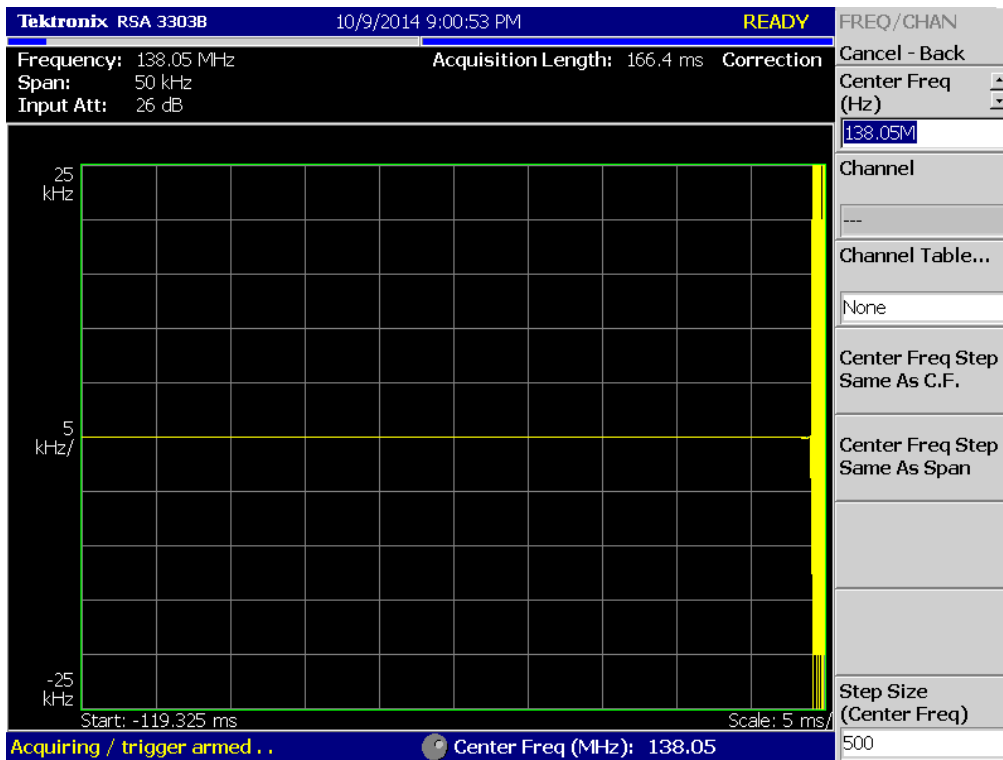
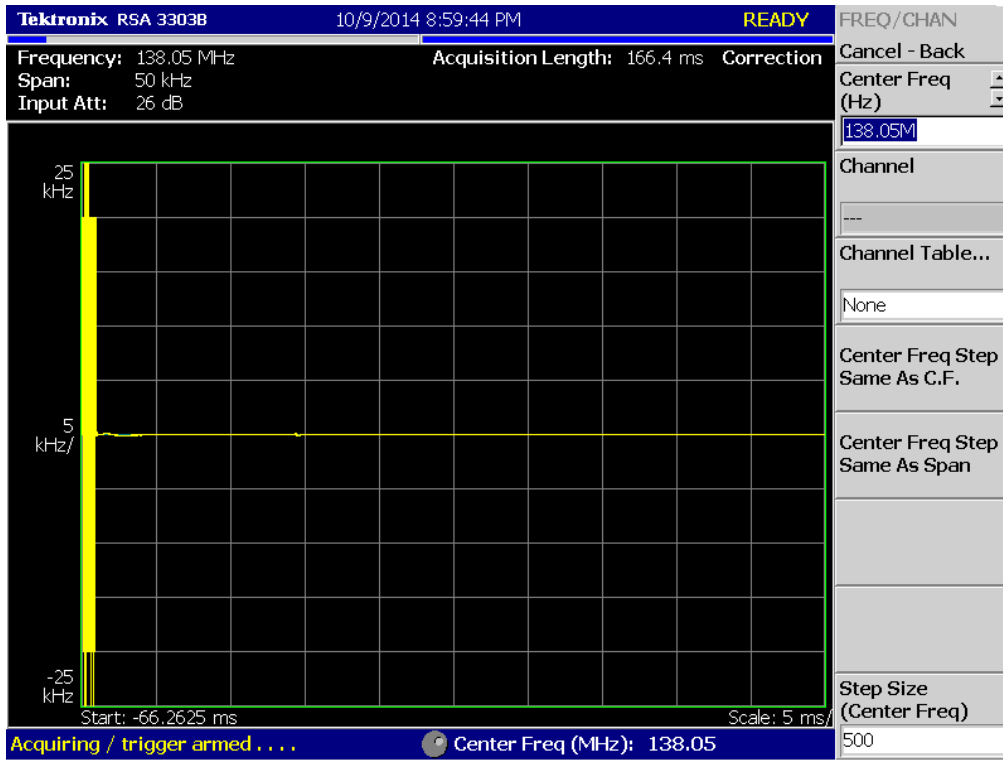

(16K0F3E _ 143.95 MHz)_High

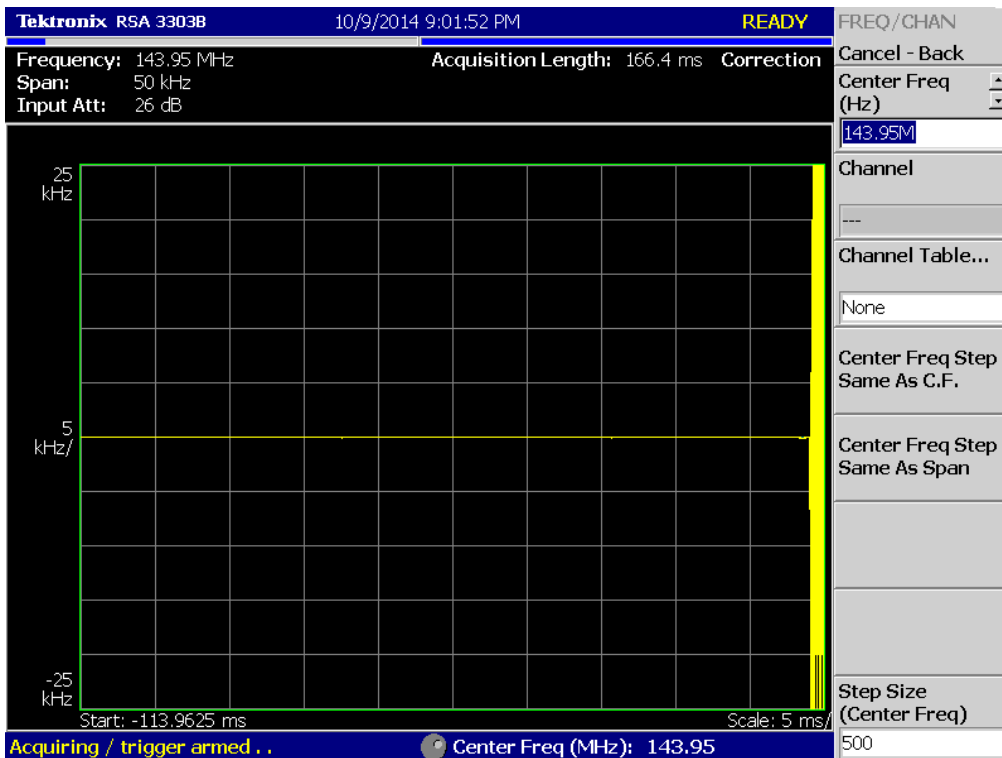
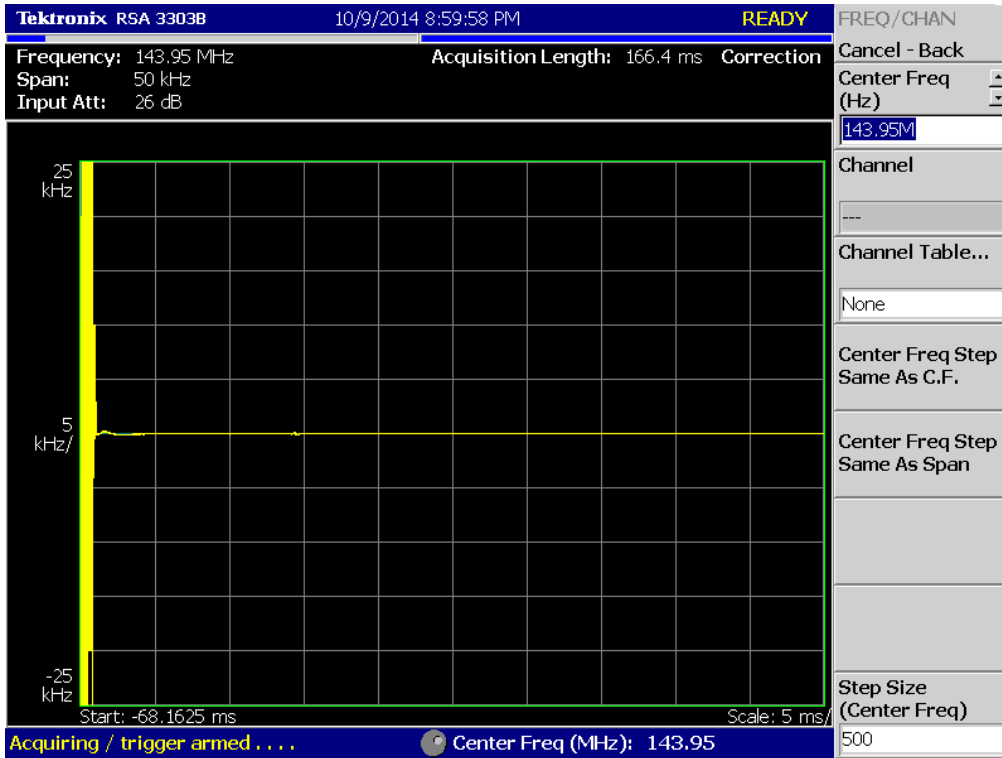

(16K0F3E _ 148.05 MHz)_High

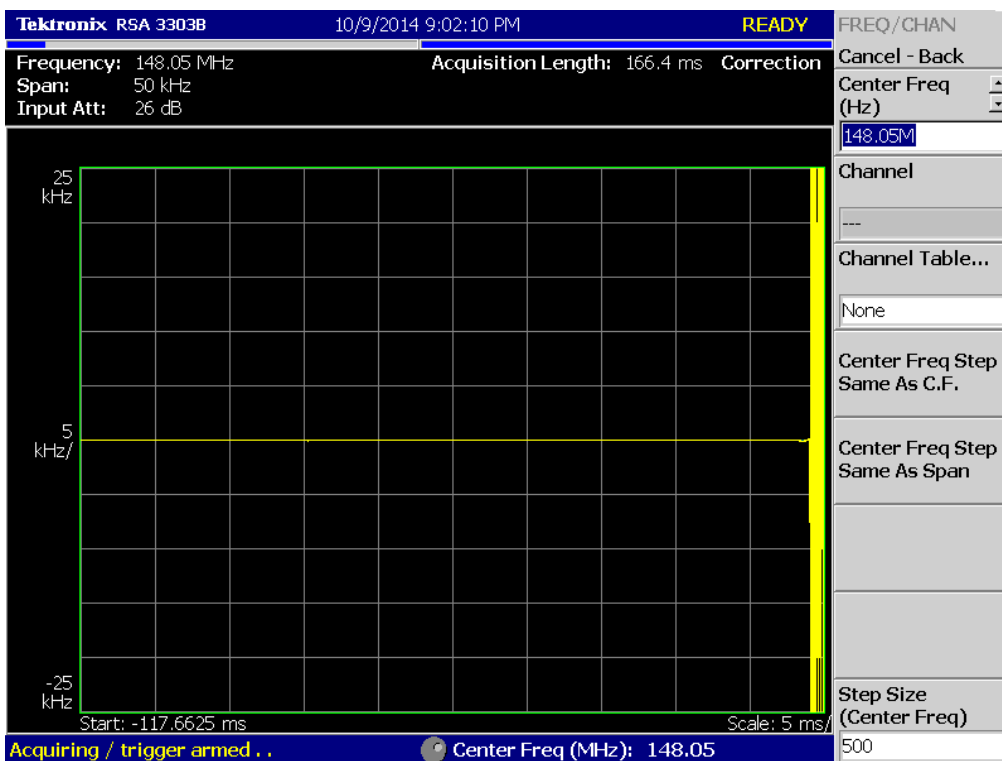
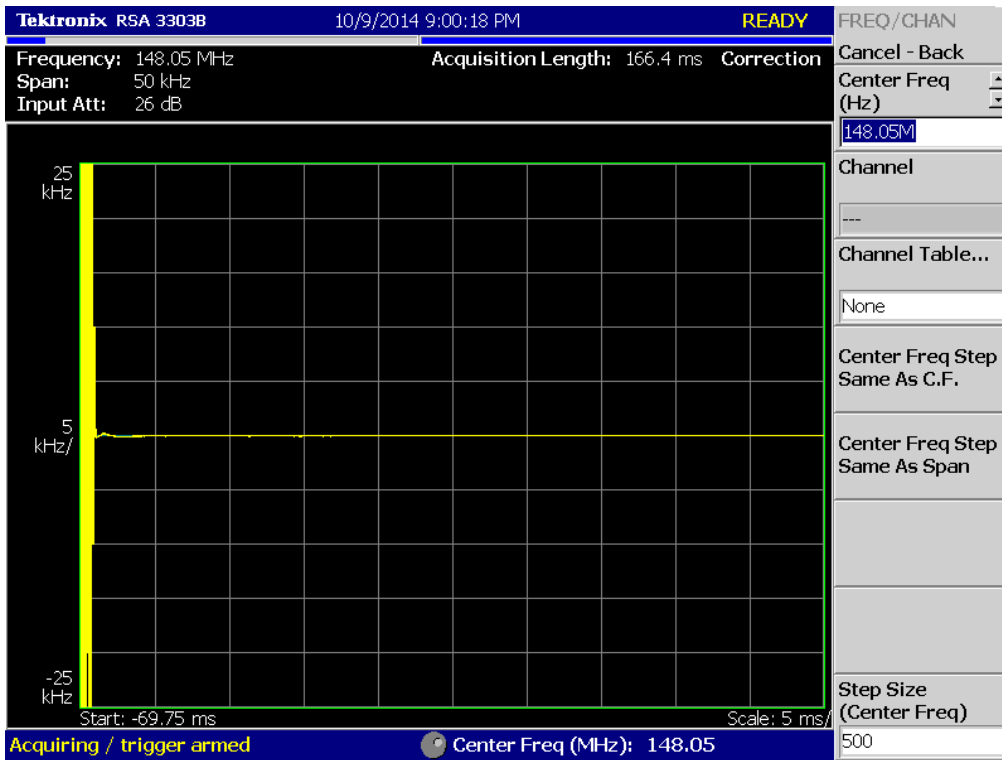

(16K0F3E _ 138.05 MHz)_Low

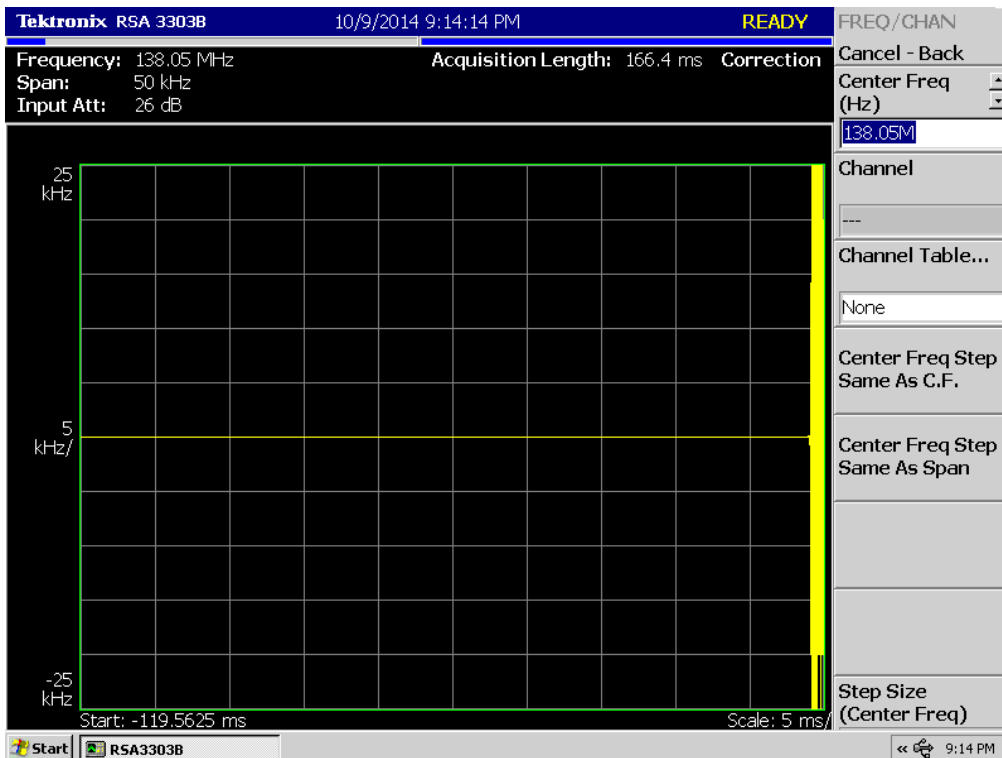
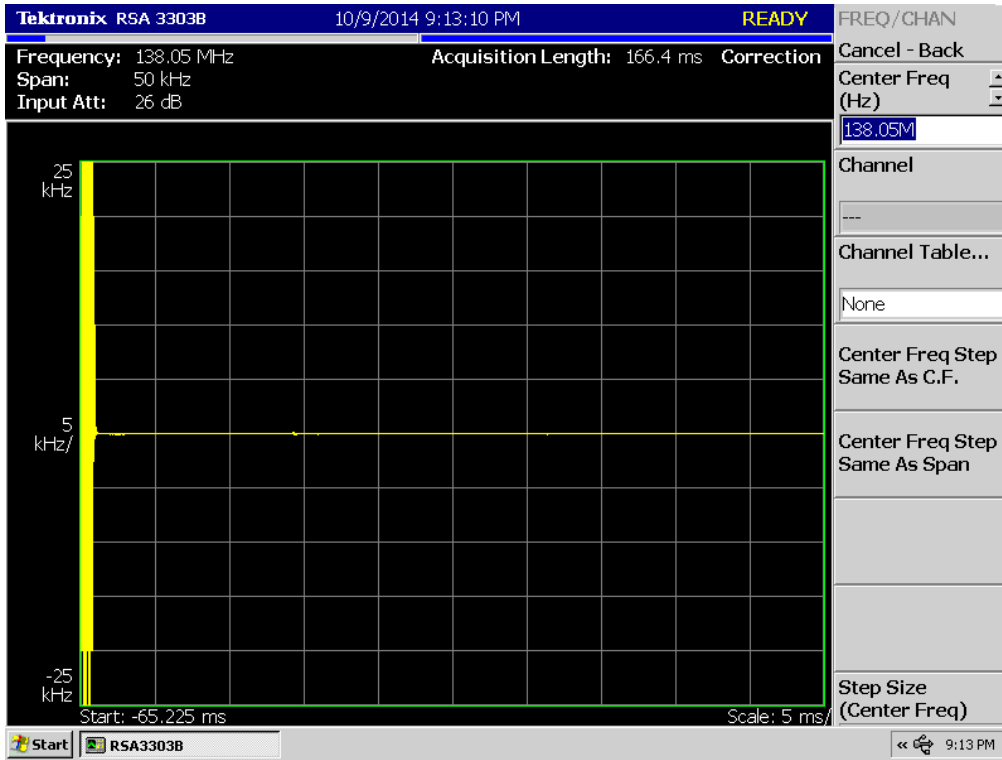

(16K0F3E _ 143.95 MHz)_Low

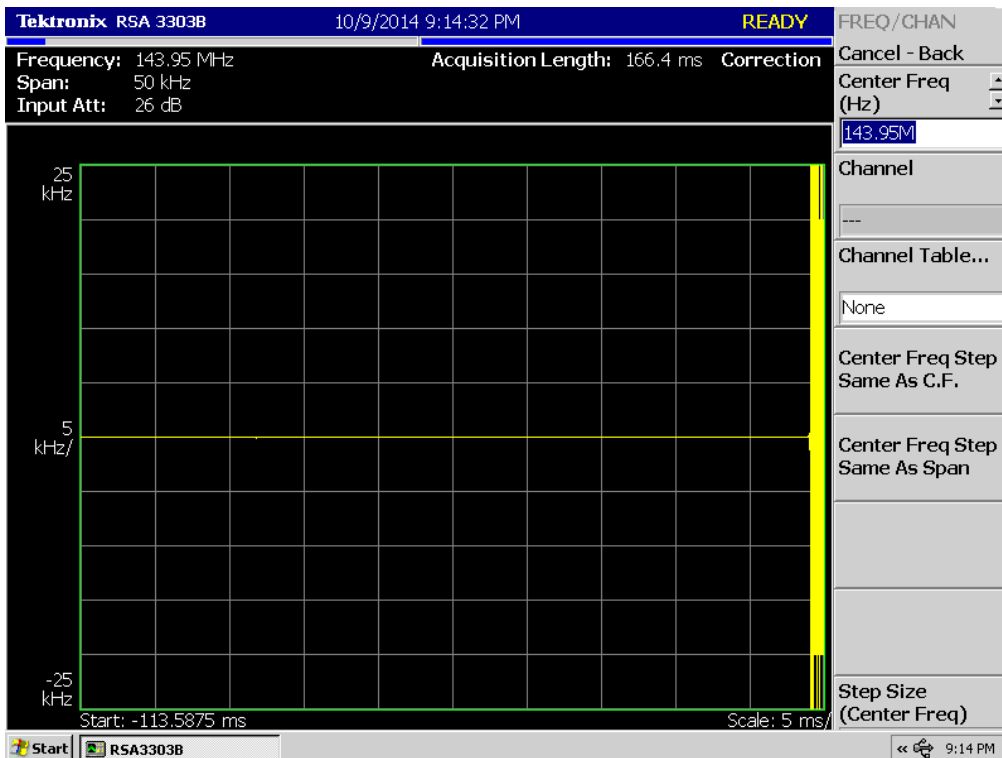
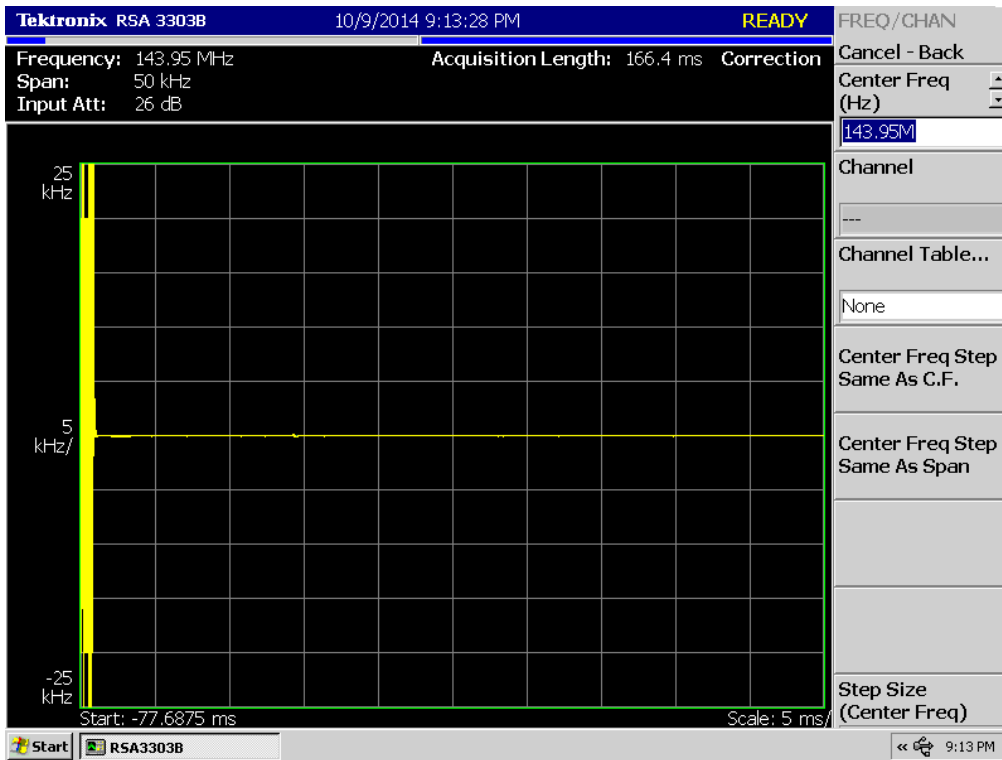

(16K0F3E _ 148.05 MHz)_Low

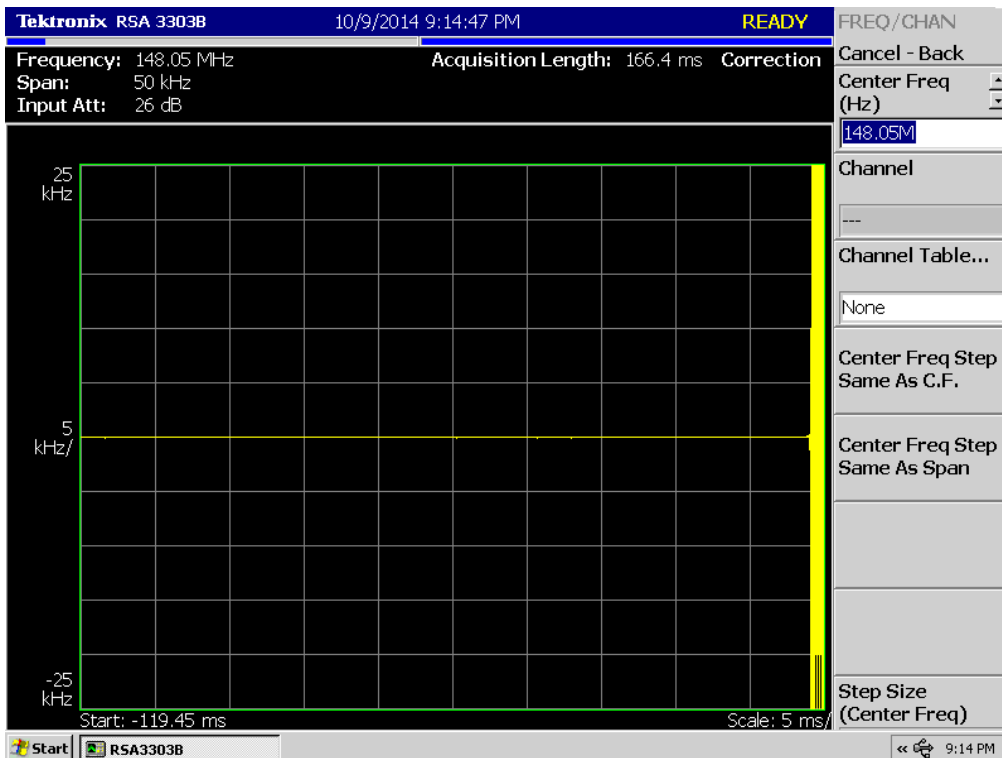
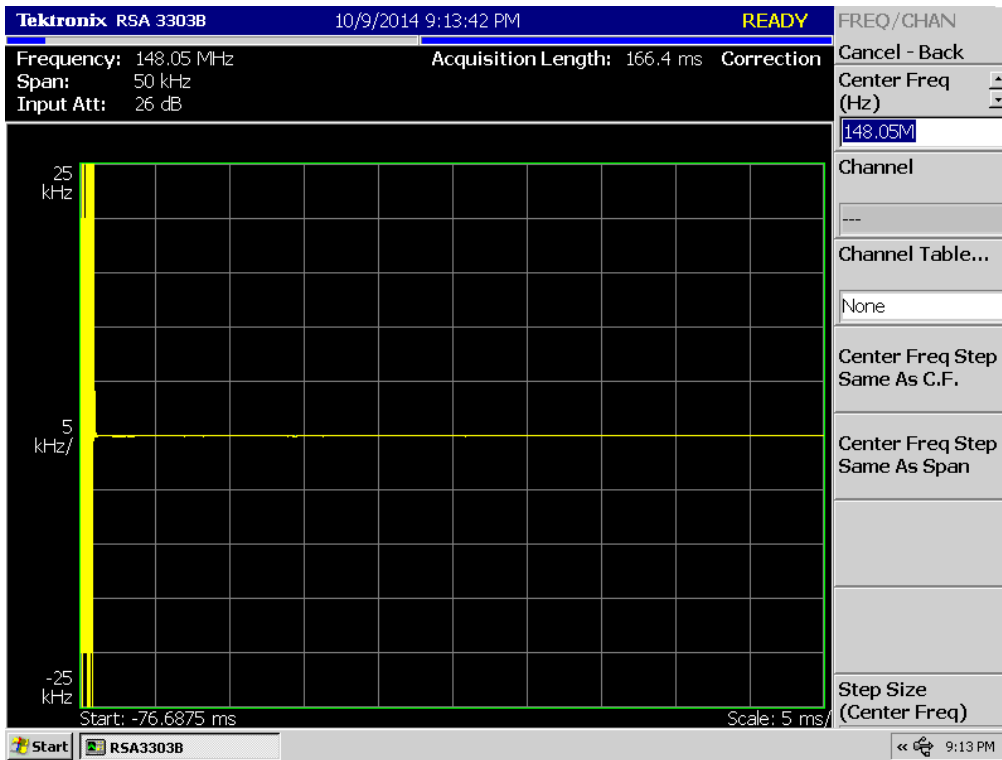

(11K0F3E _ 138.05 MHz)_High

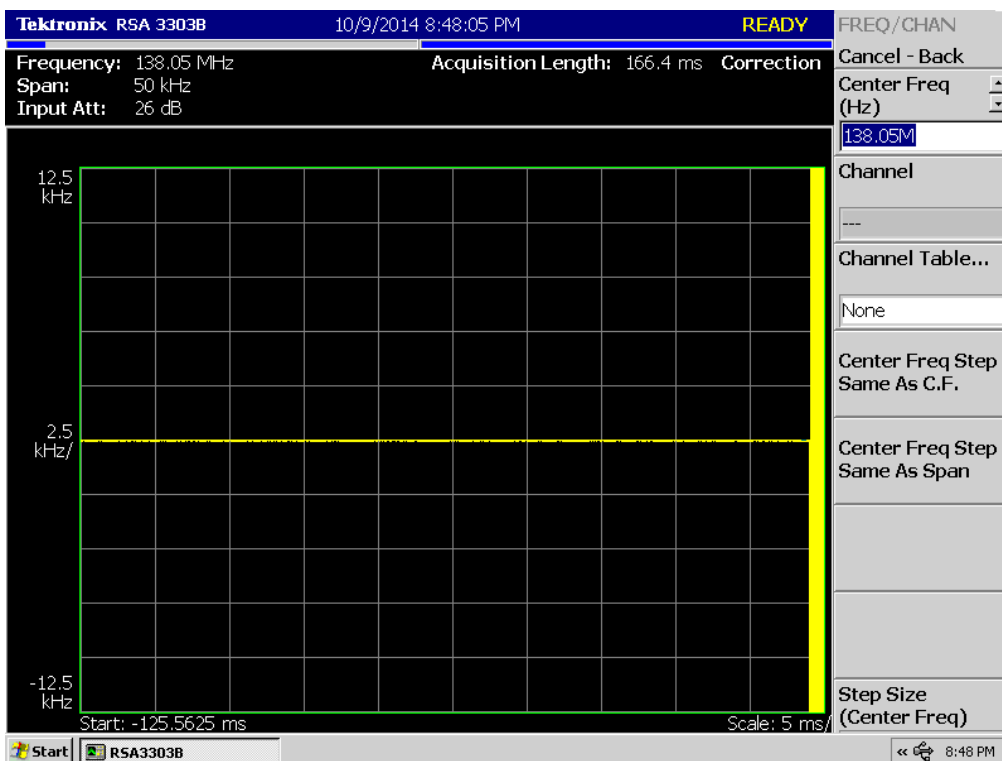
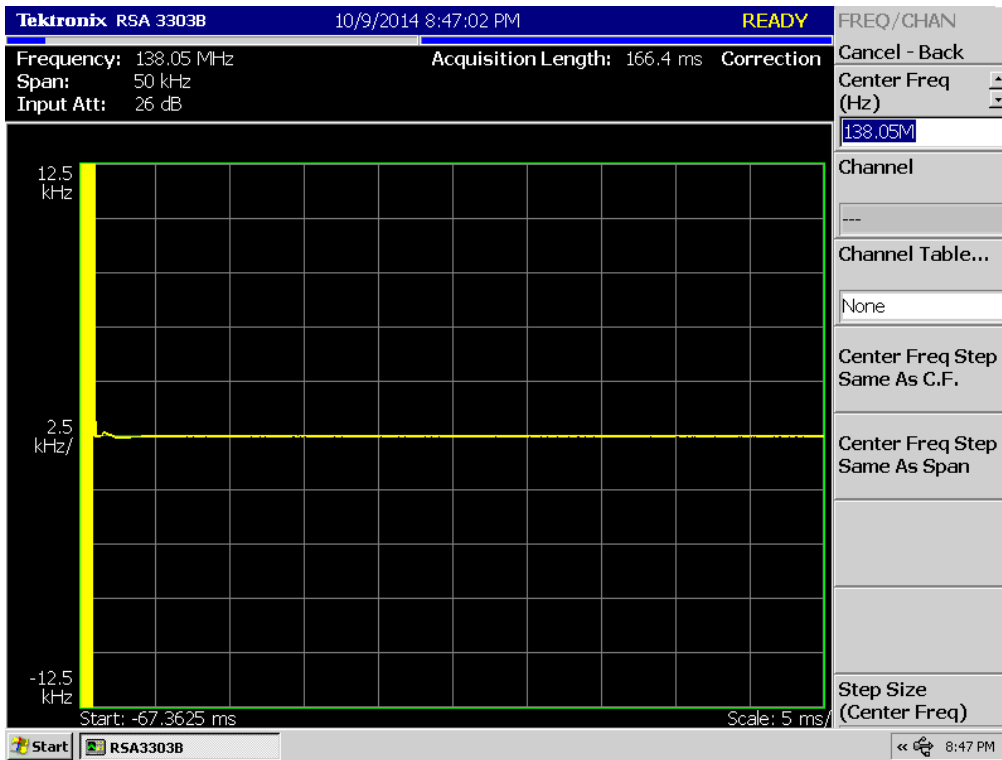

(11K0F3E _ 143.95 MHz)_High

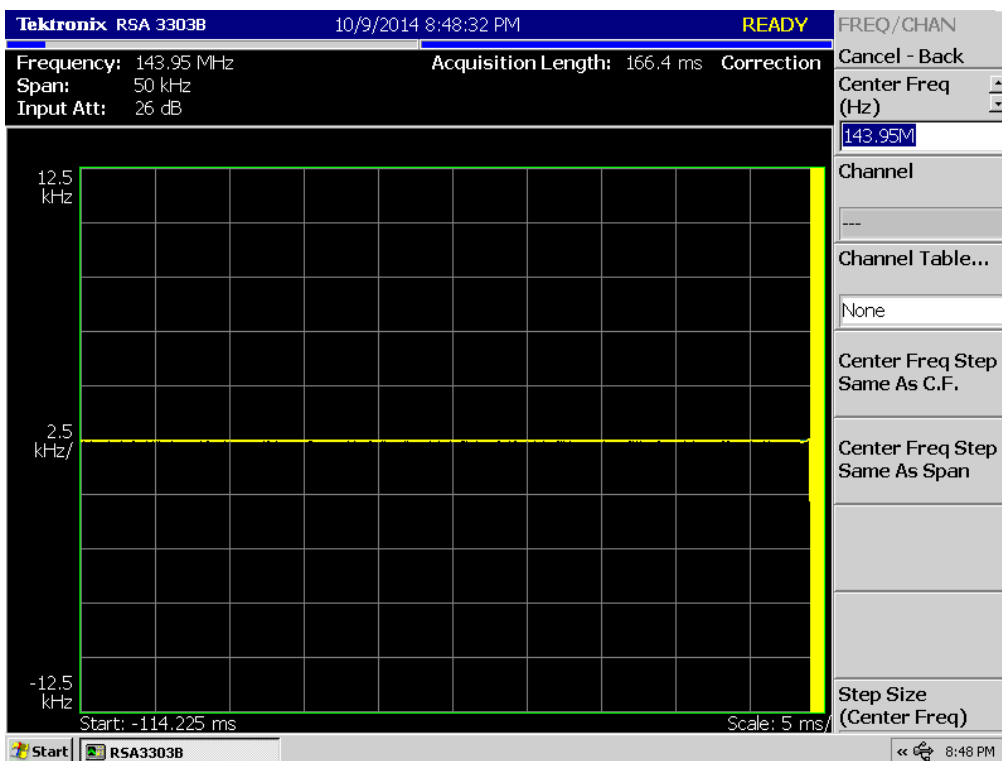
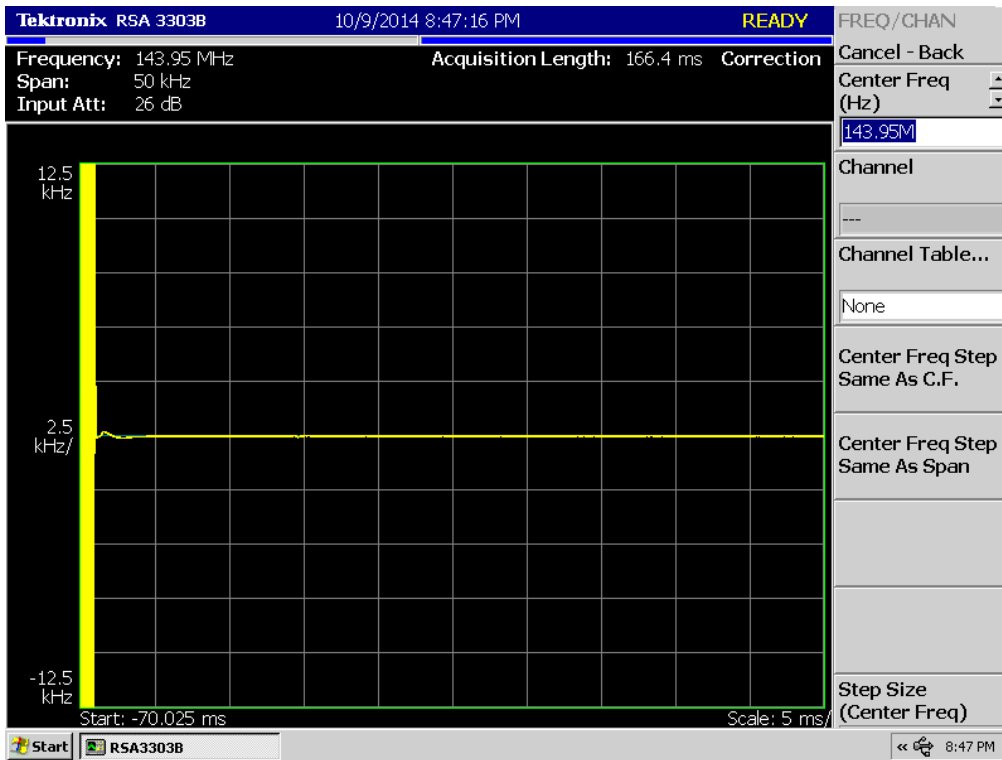

(11K0F3E _ 148.05 MHz)_High

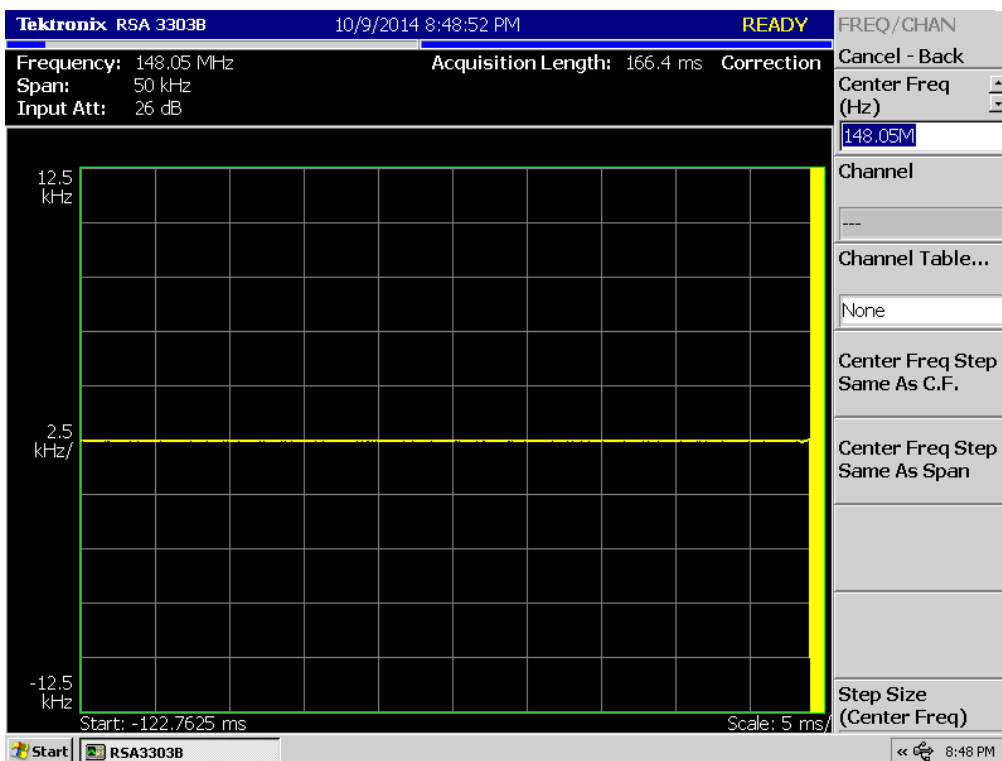
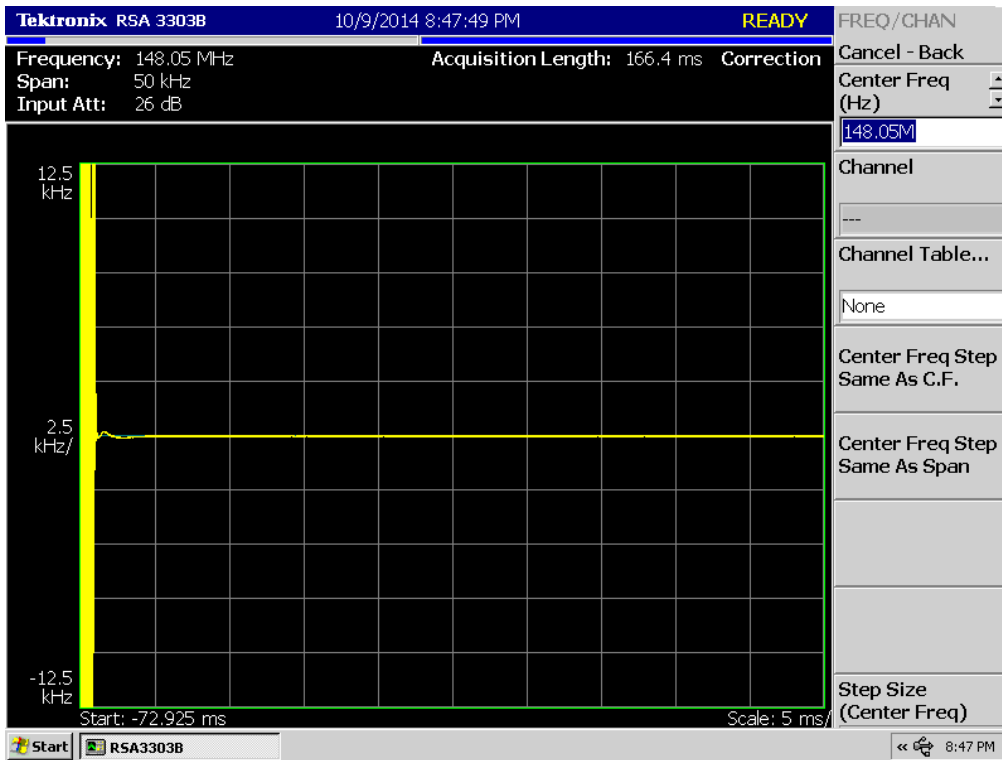

(11K0F3E _ 138.05 MHz)_Low

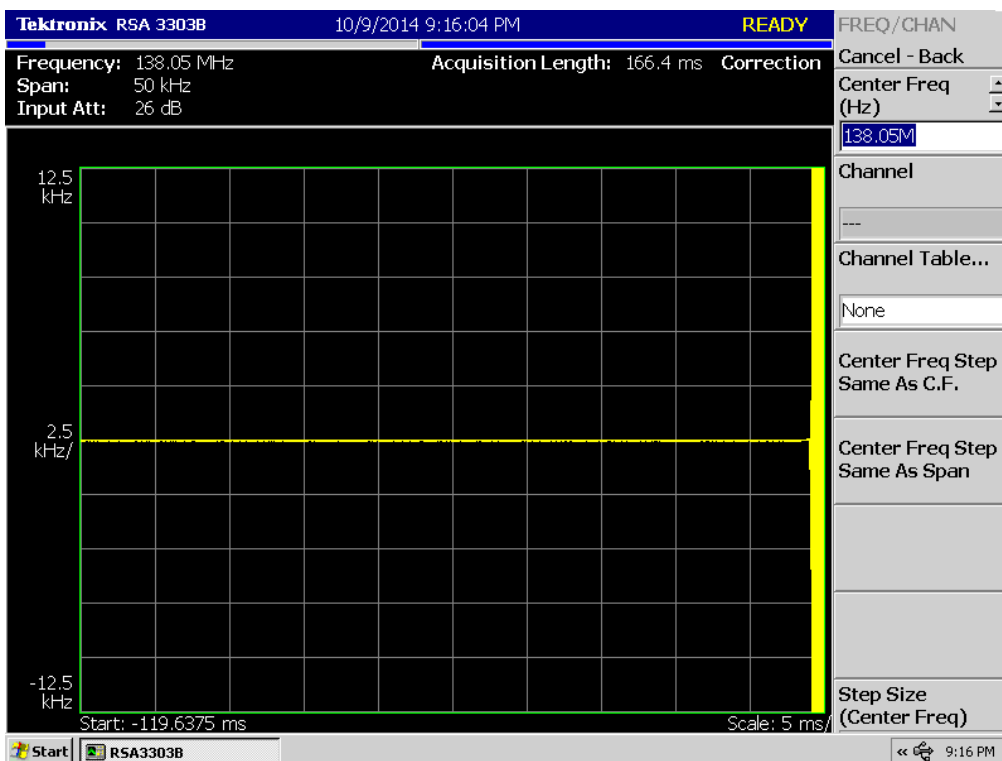
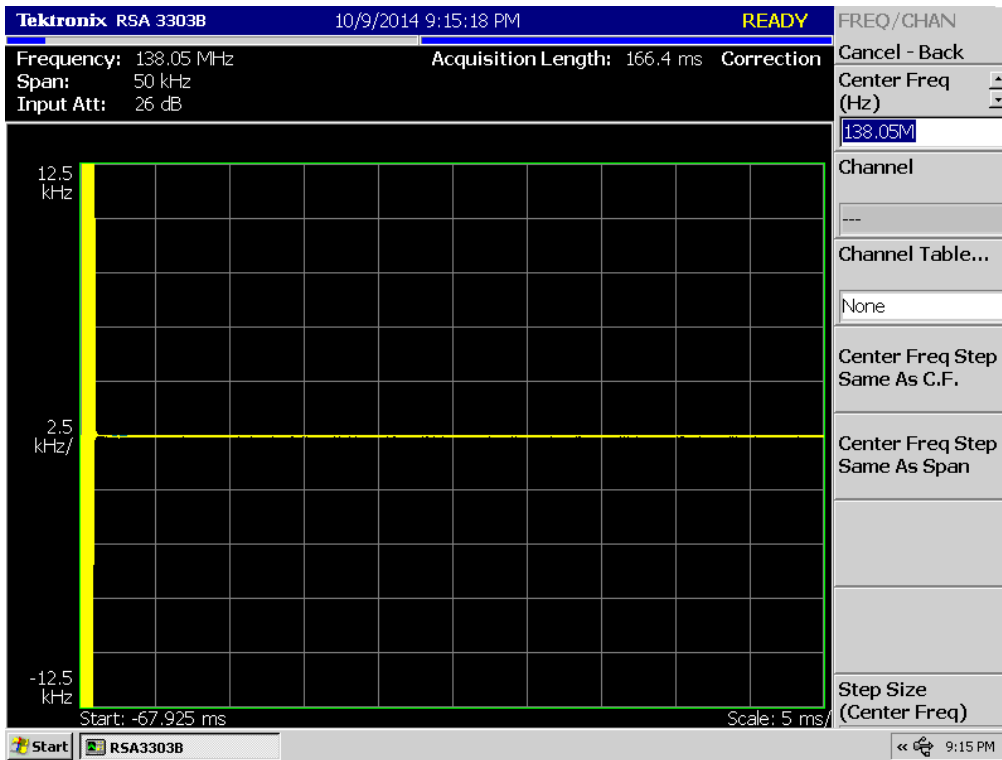

(11K0F3E _ 143.95 MHz)_Low

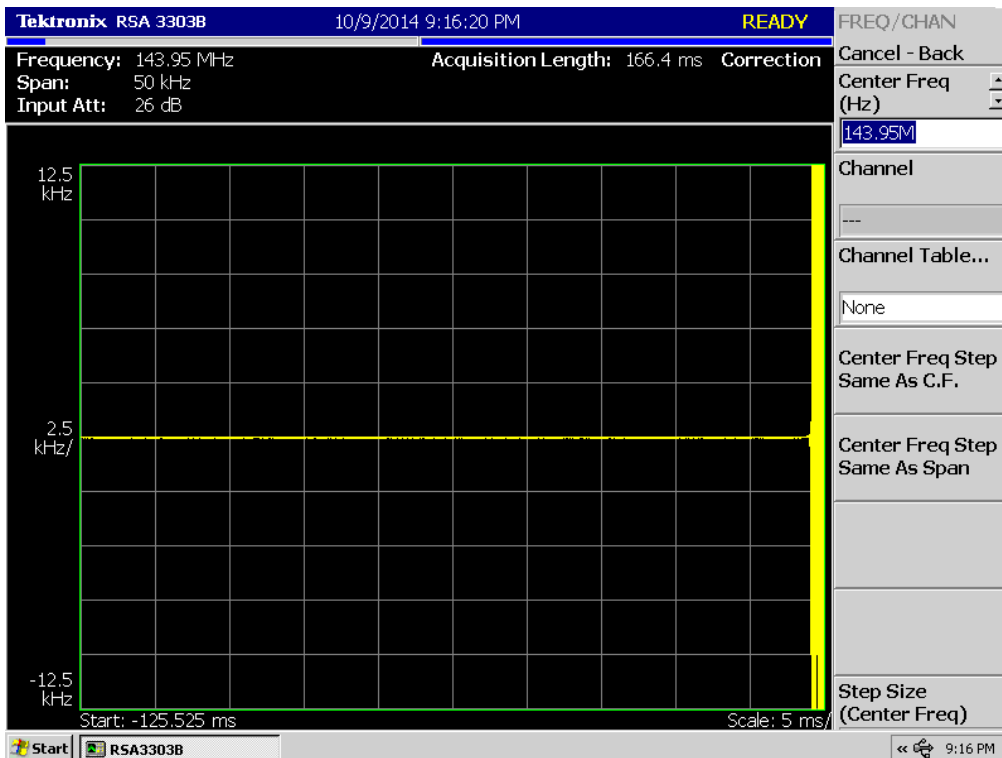
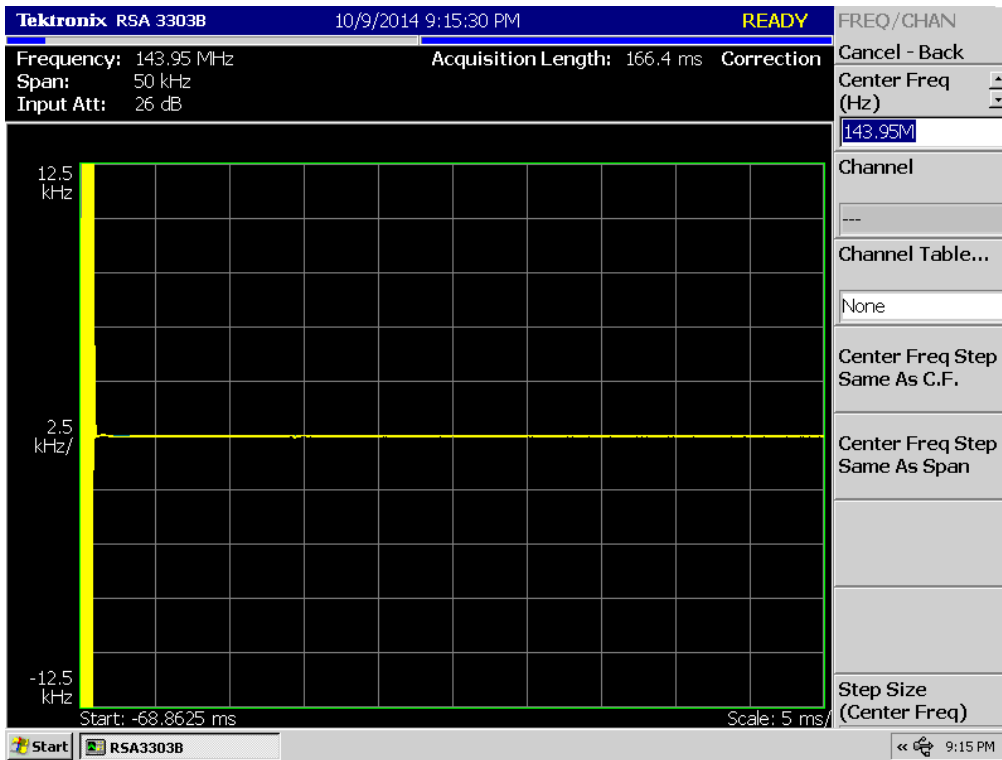

(11K0F3E _ 148.05 MHz)_Low

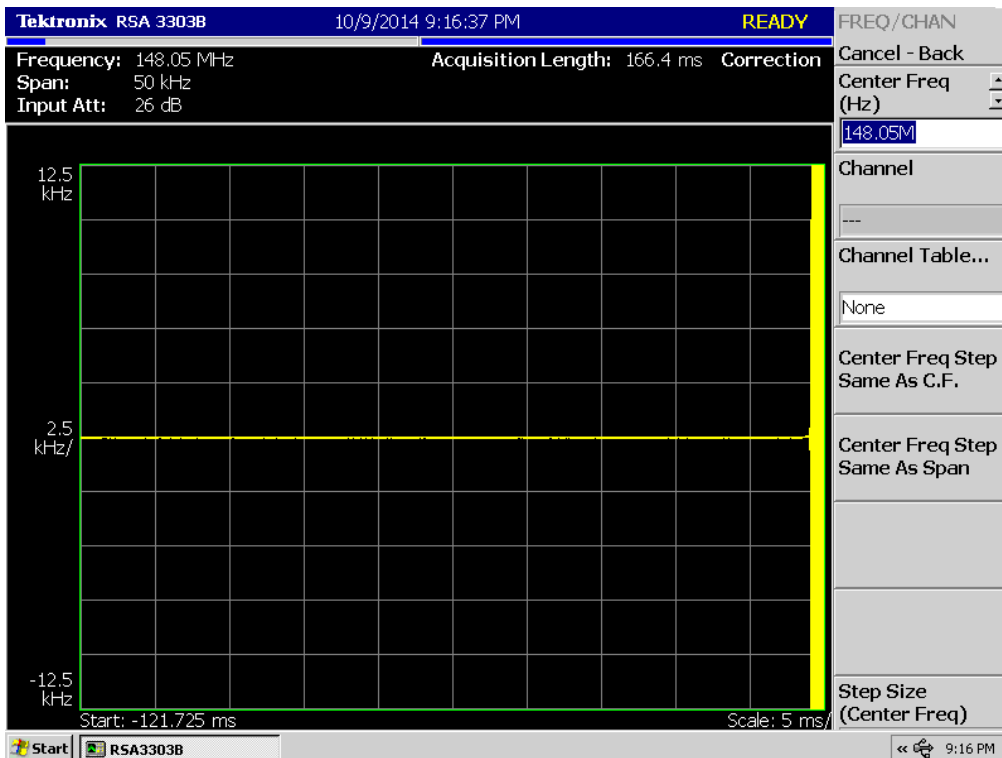
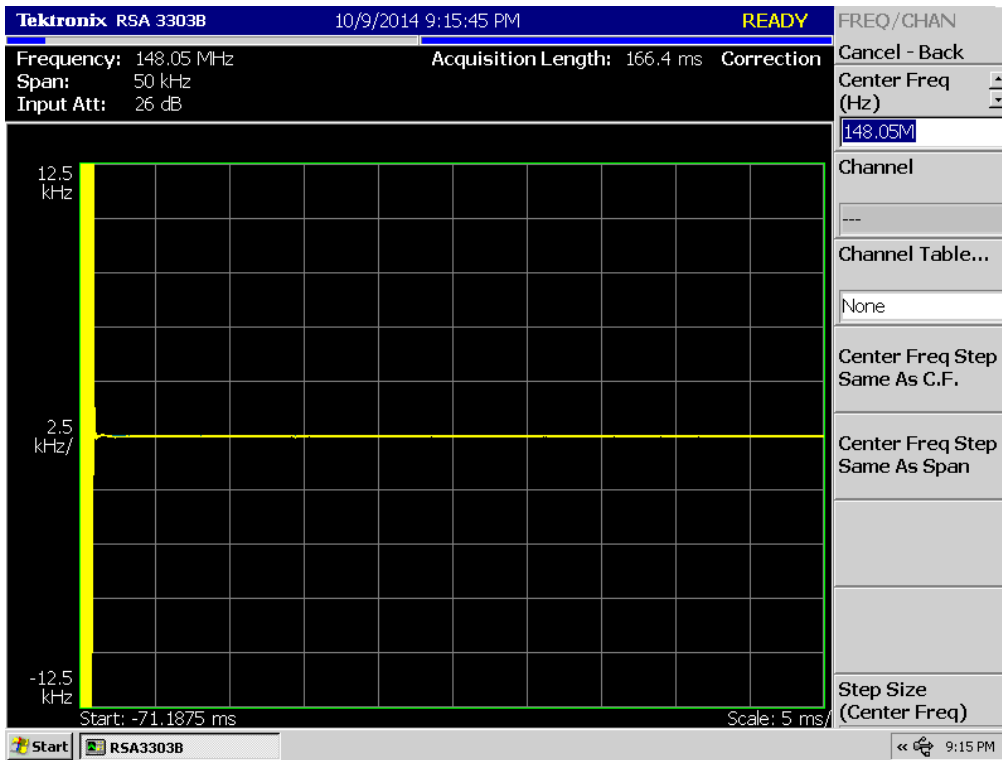

(8K10F1E, 8K10F1D _ 138.05 MHz)_High

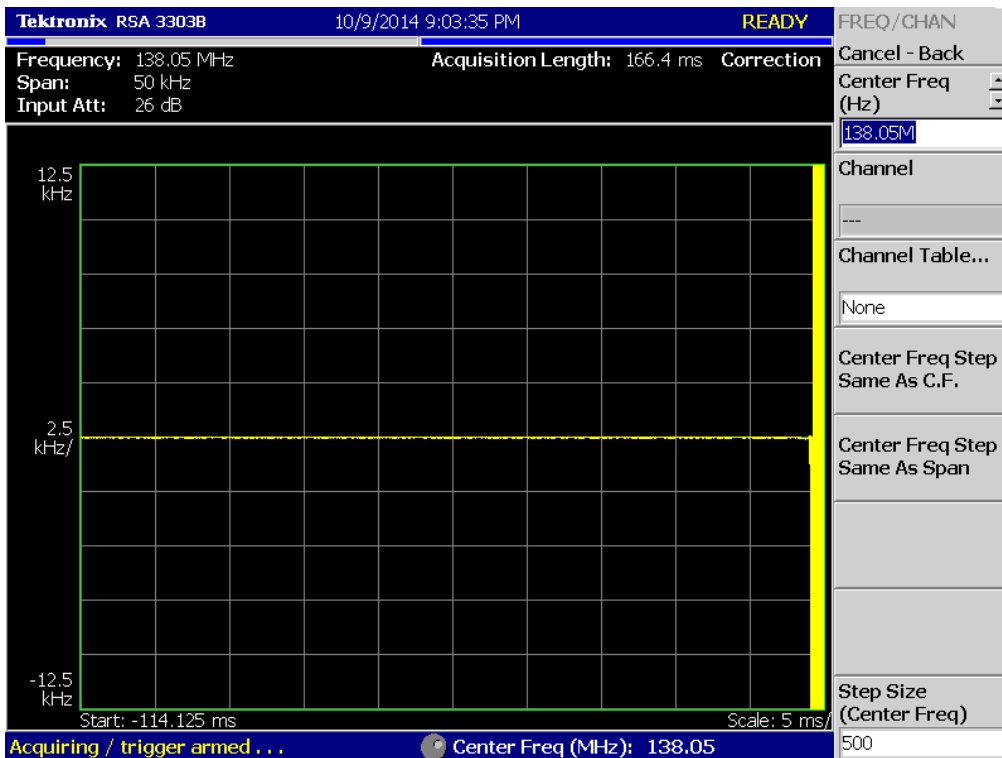
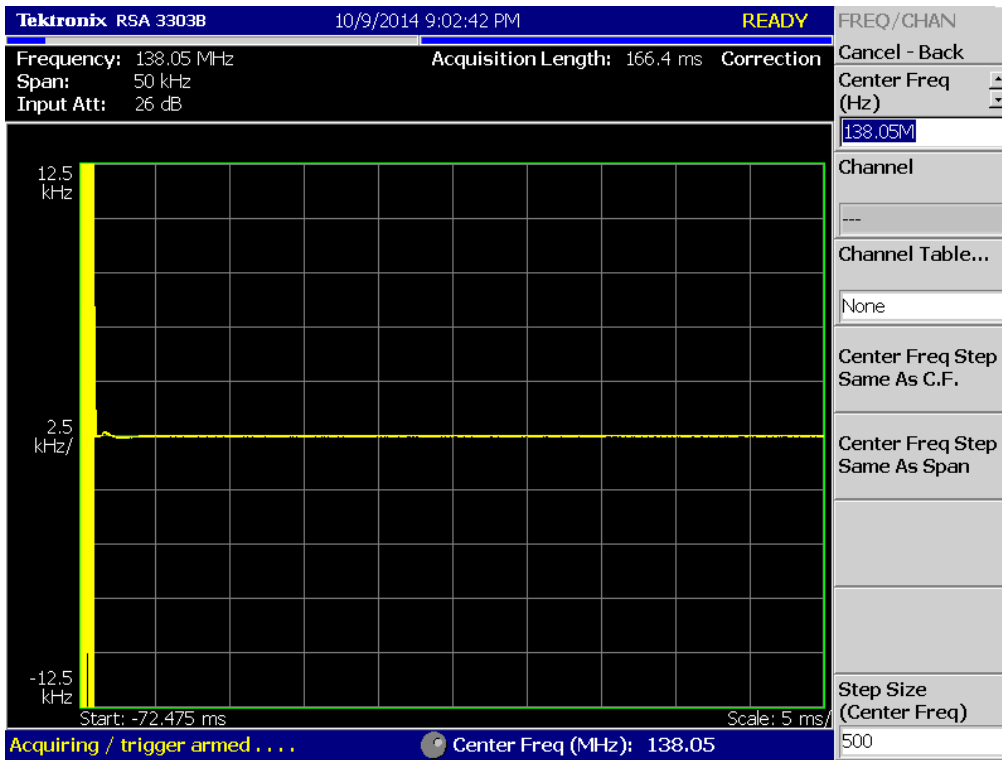

(8K10F1E, 8K10F1D _ 143.95 MHz)_High

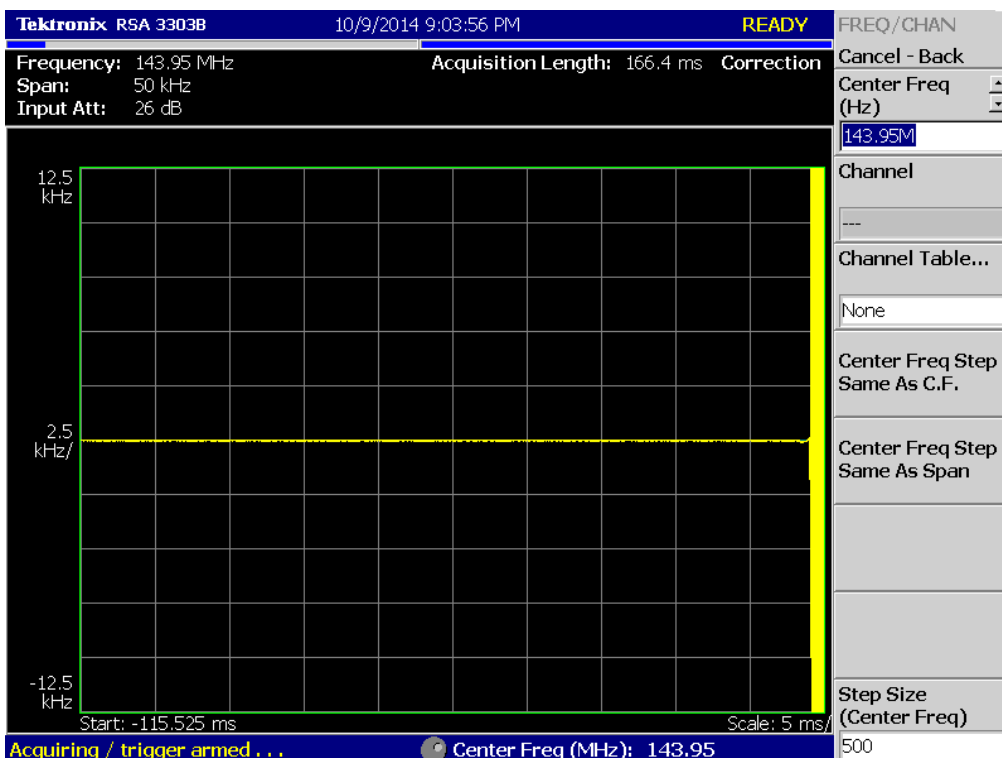
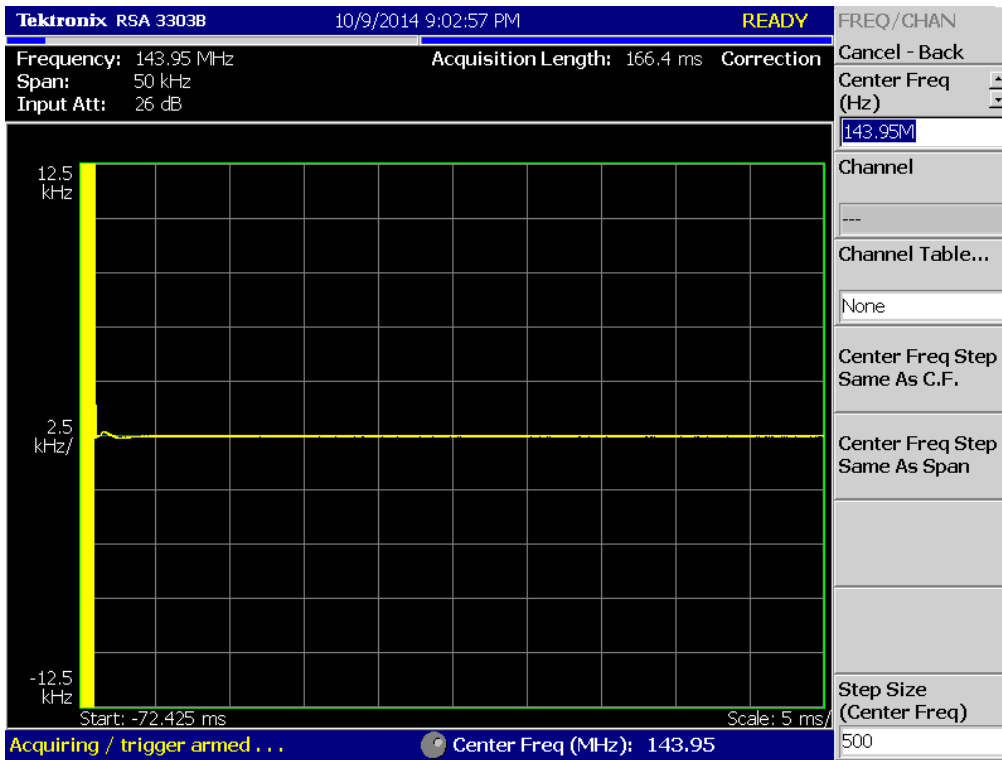

(8K10F1E, 8K10F1D _ 148.05 MHz)_High

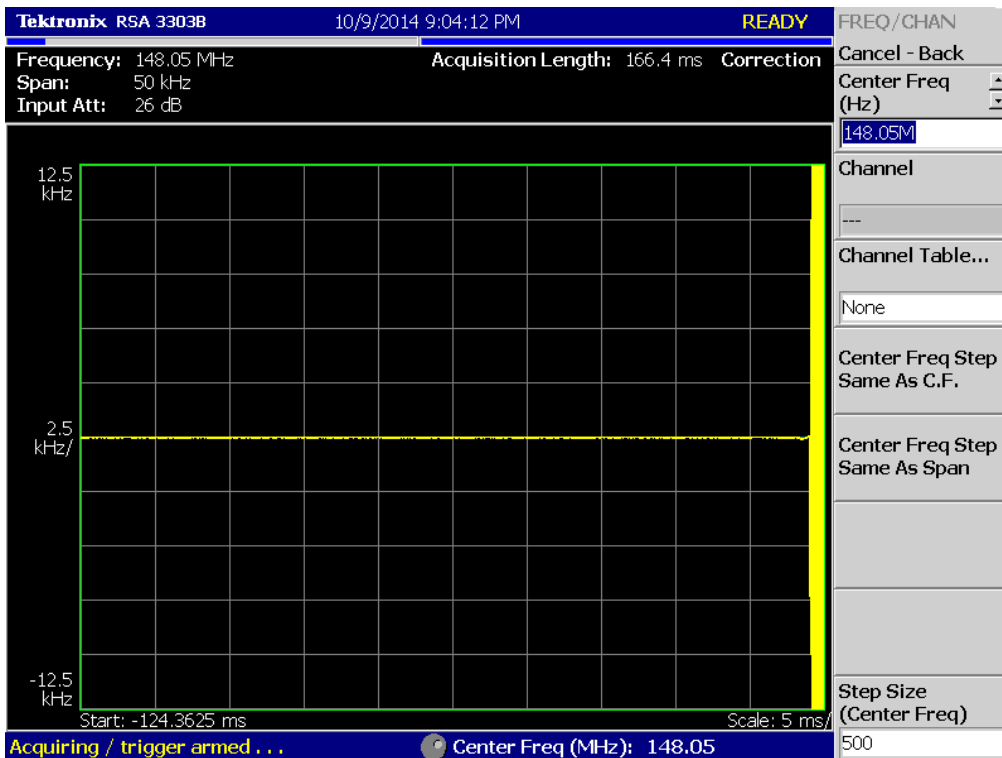
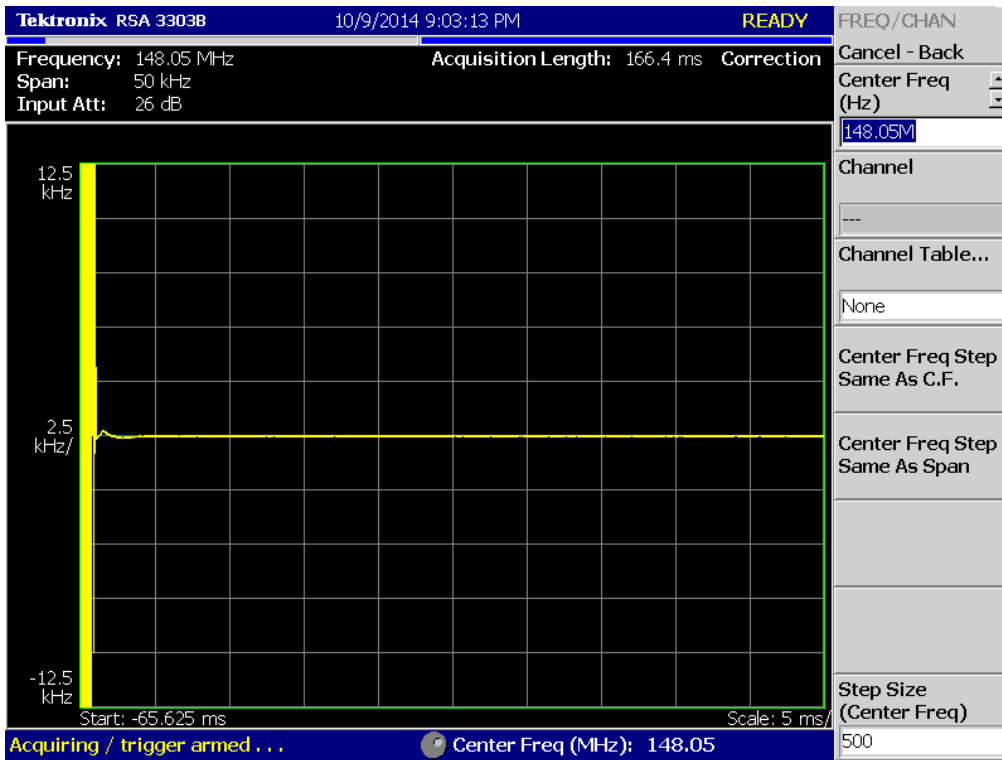

(8K10F1E, 8K10F1D _ 138.05 MHz)_Low

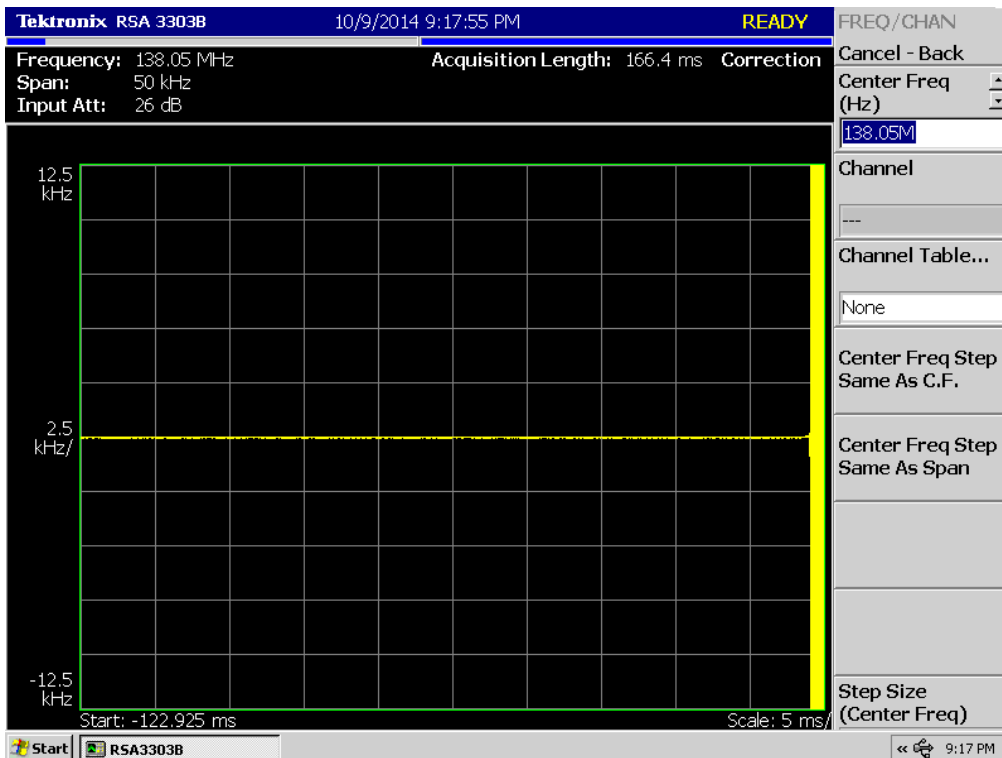
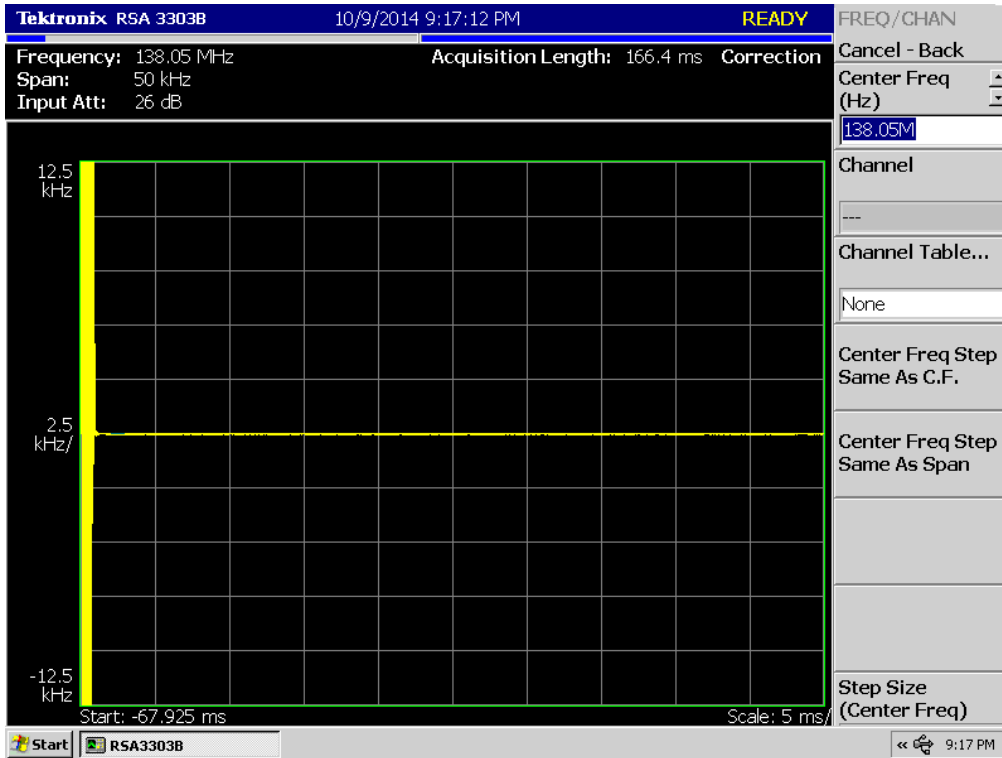

(8K10F1E, 8K10F1D _ 143.95 MHz)_Low

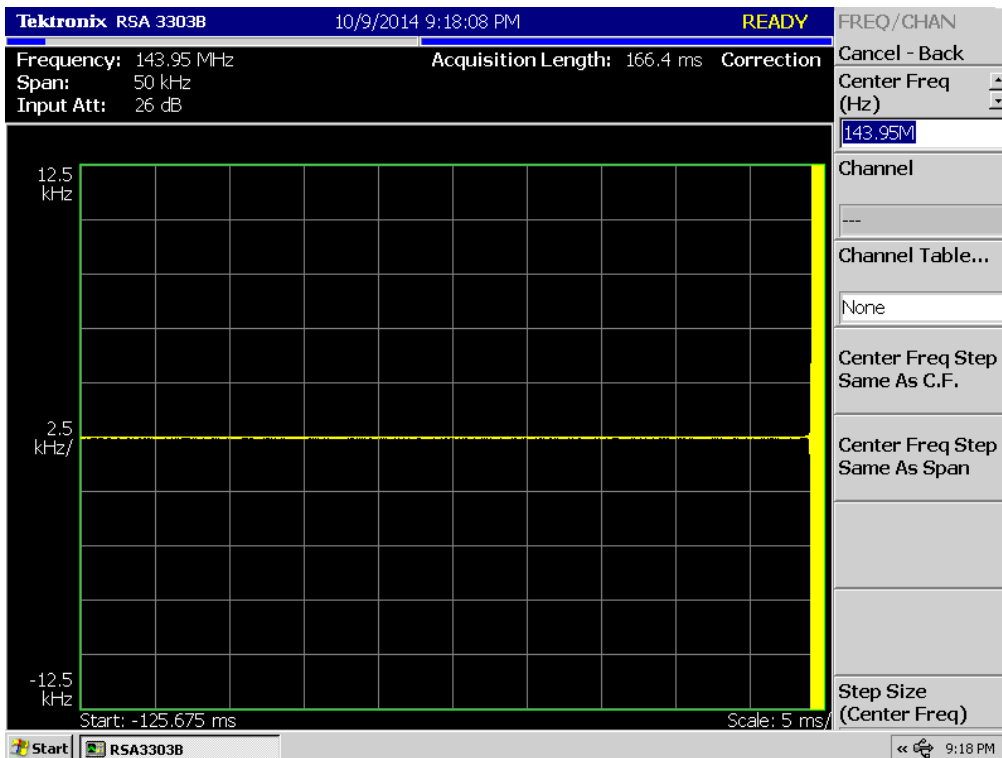
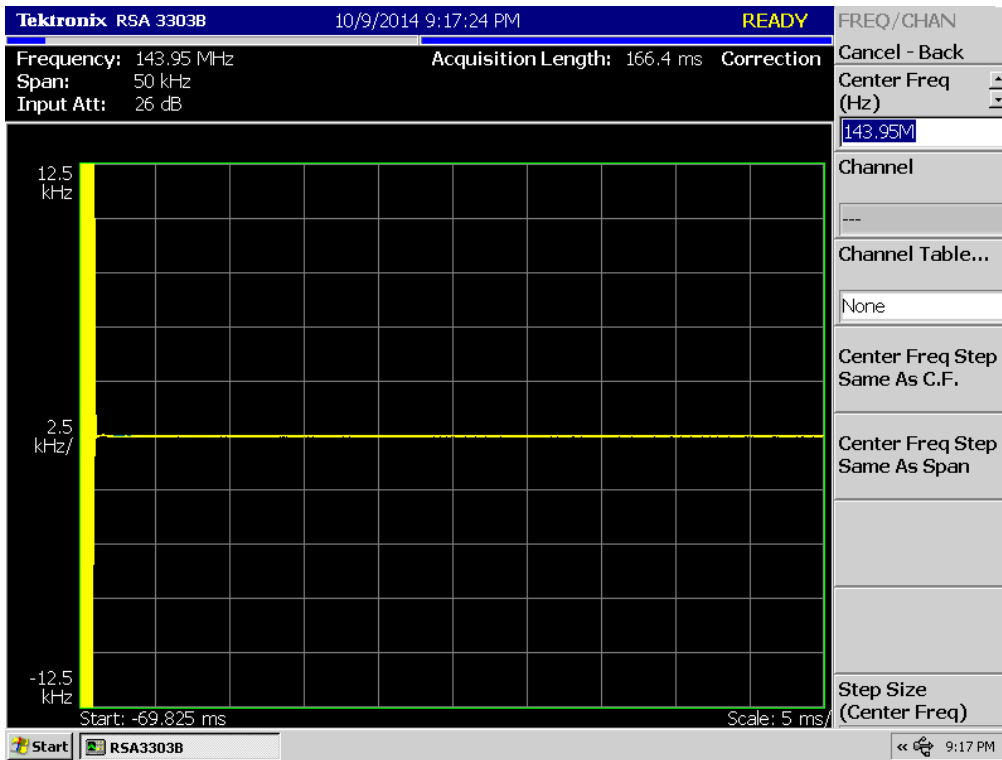

(8K10F1E, 8K10F1D _ 148.05 MHz)_Low

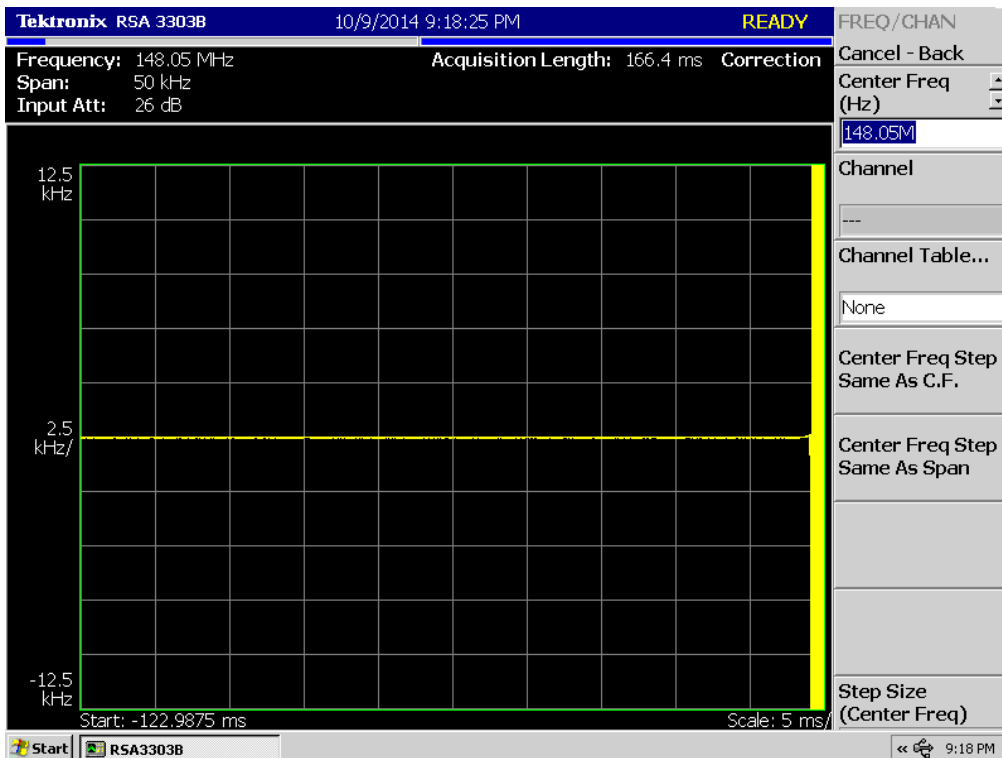
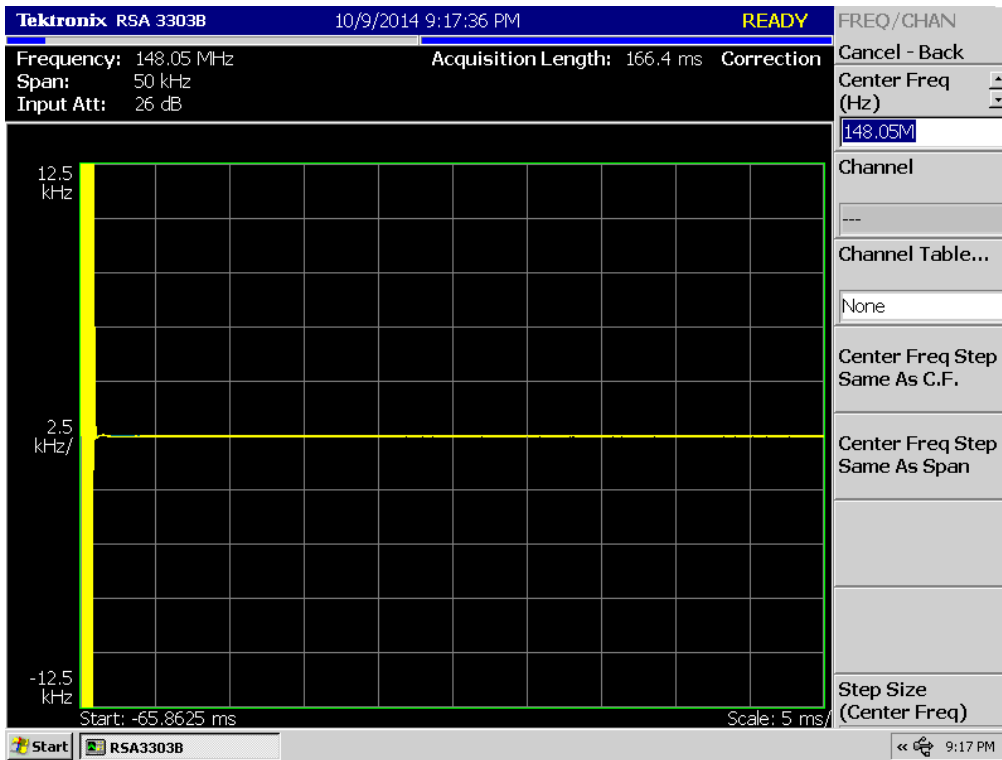

(8K10F1W _ 138.05 MHz)_High

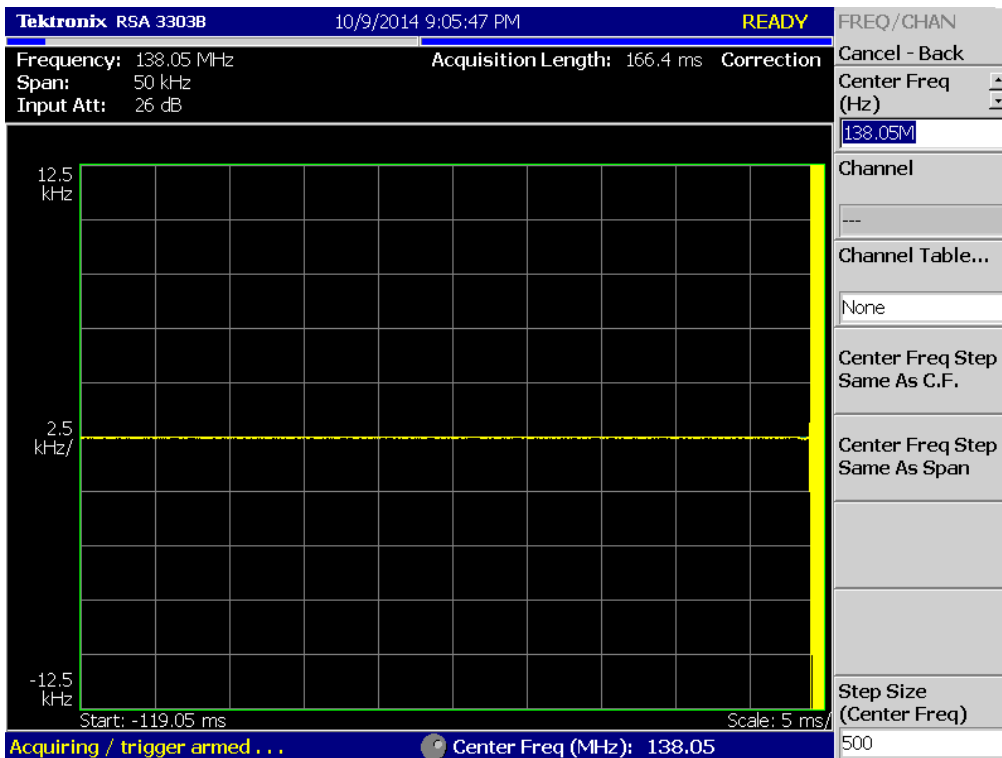
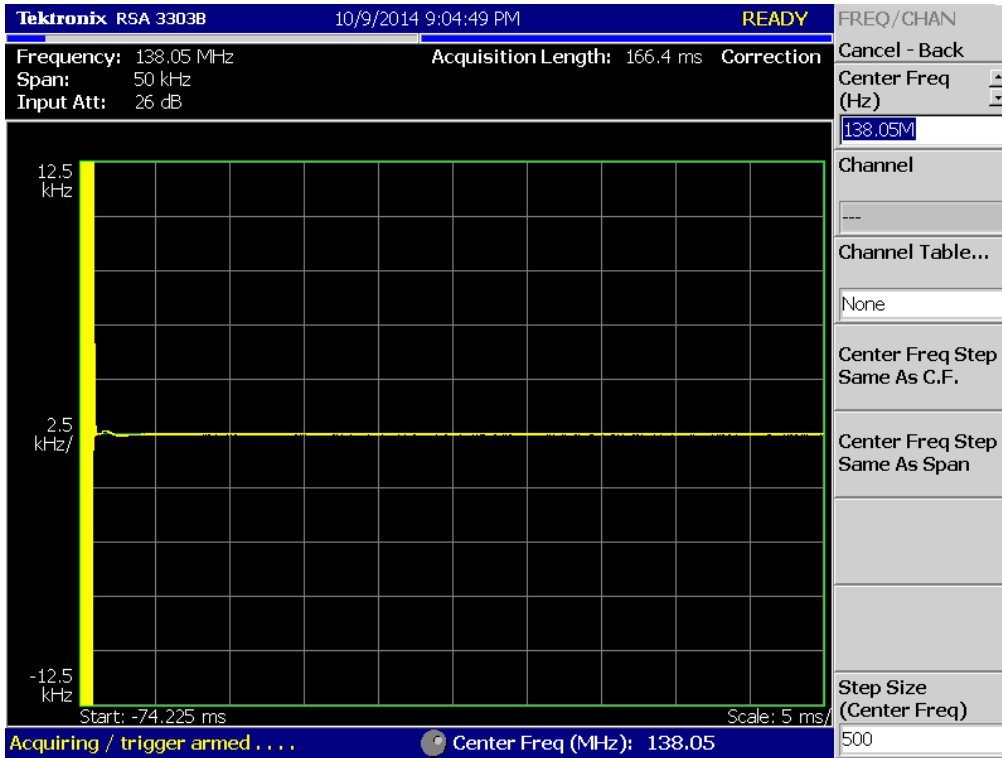

(8K10F1W _ 143.95 MHz)_High

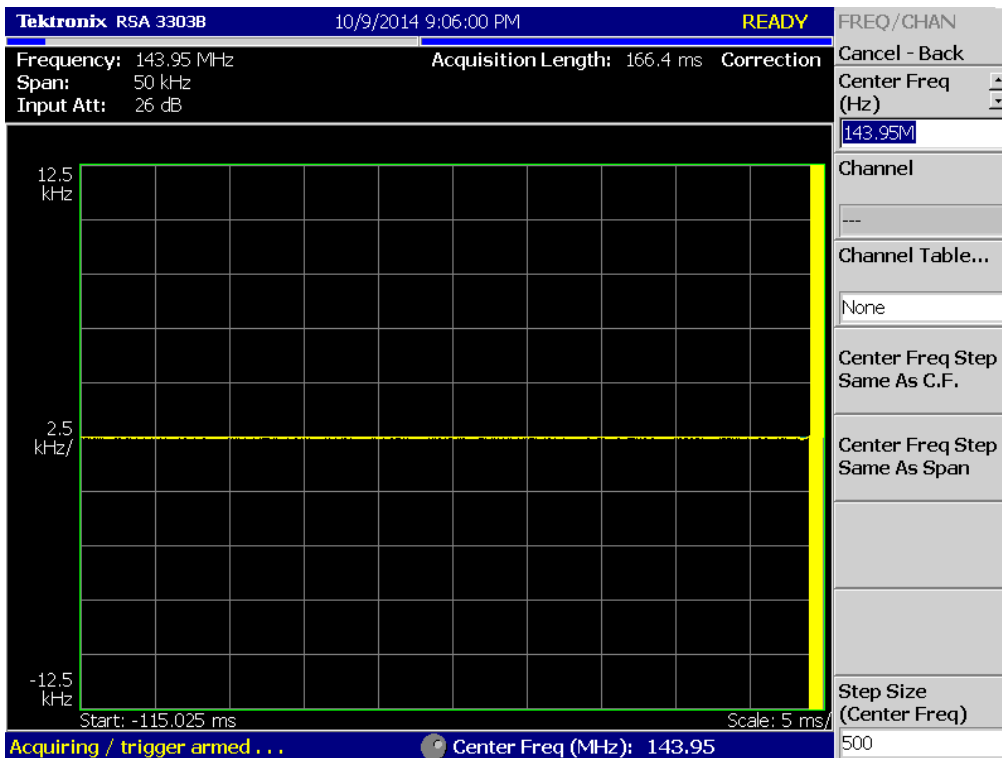
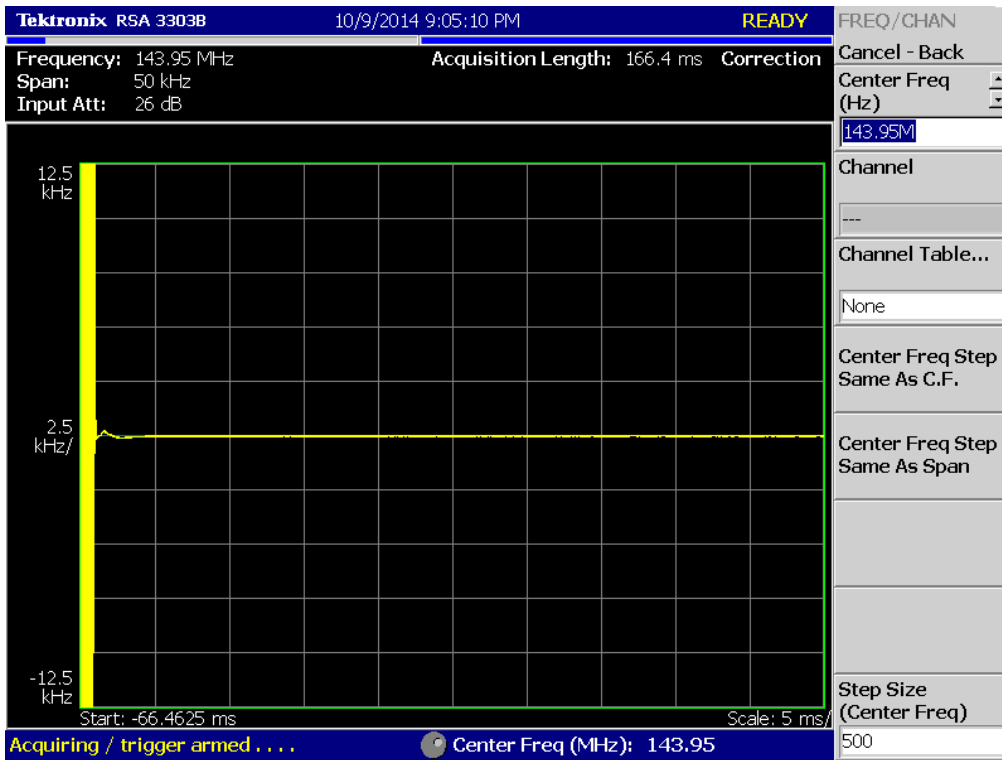

(8K10F1W _ 148.05 MHz)_High

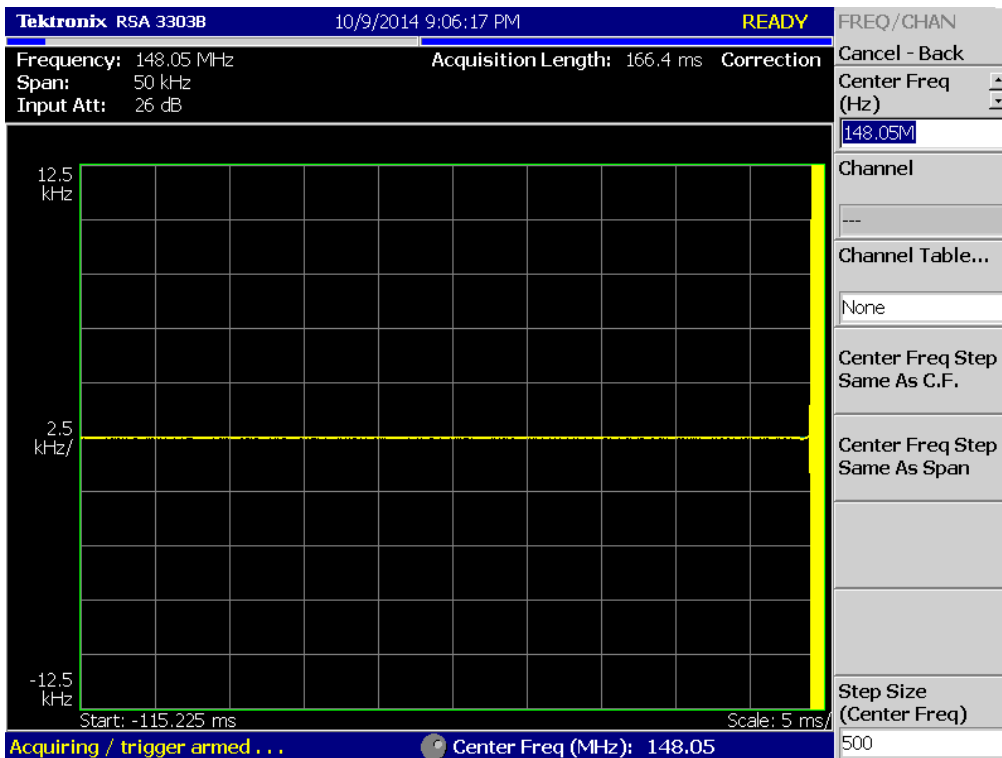
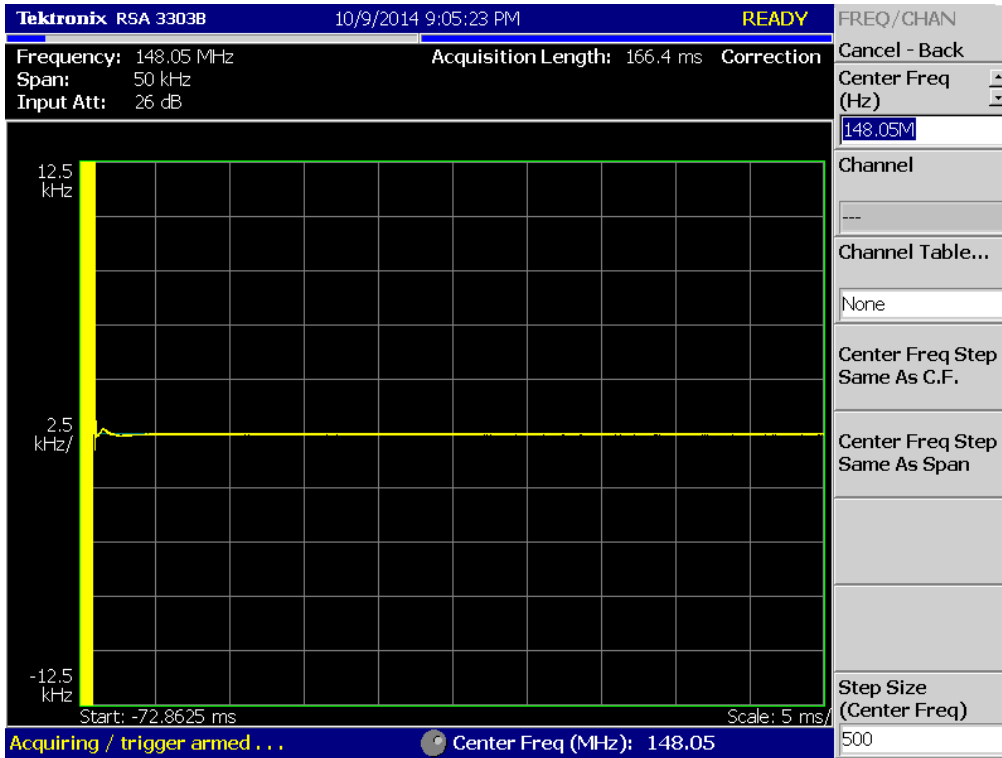

(8K10F1W _ 138.05 MHz)_Low

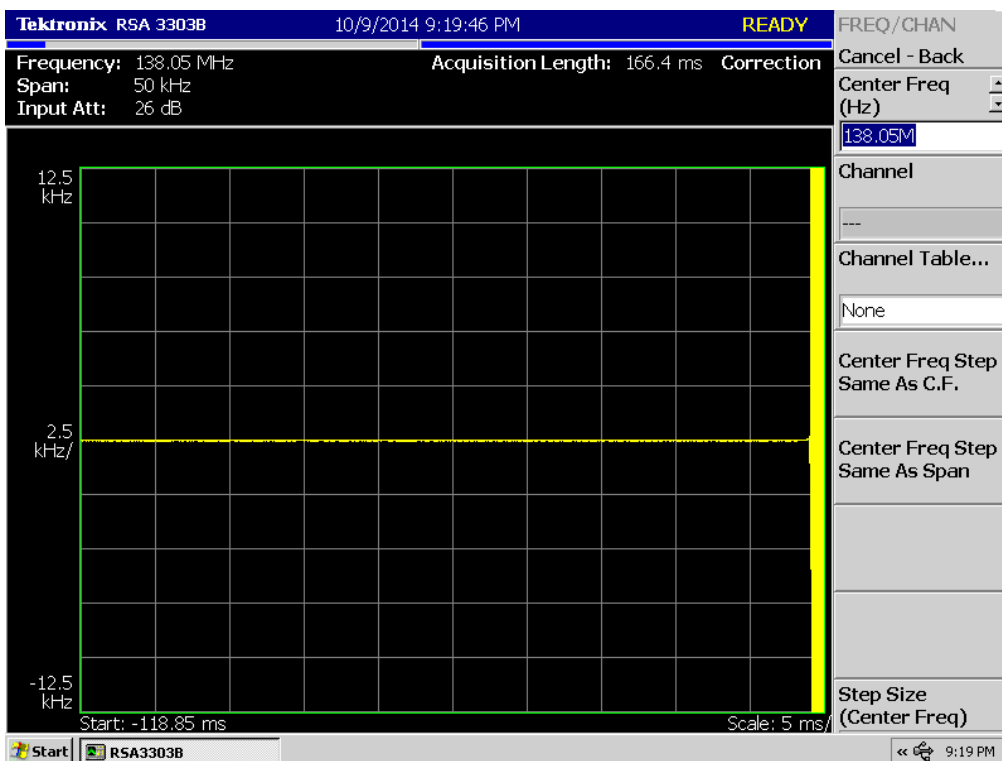
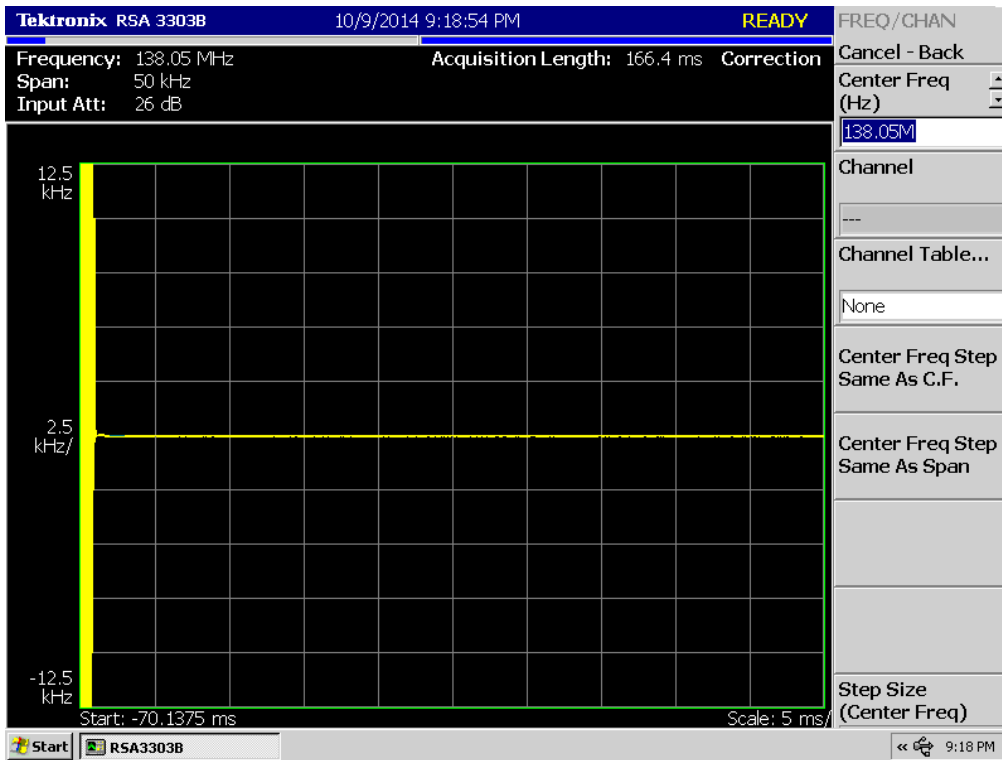

(8K10F1W _ 143.95 MHz)_Low

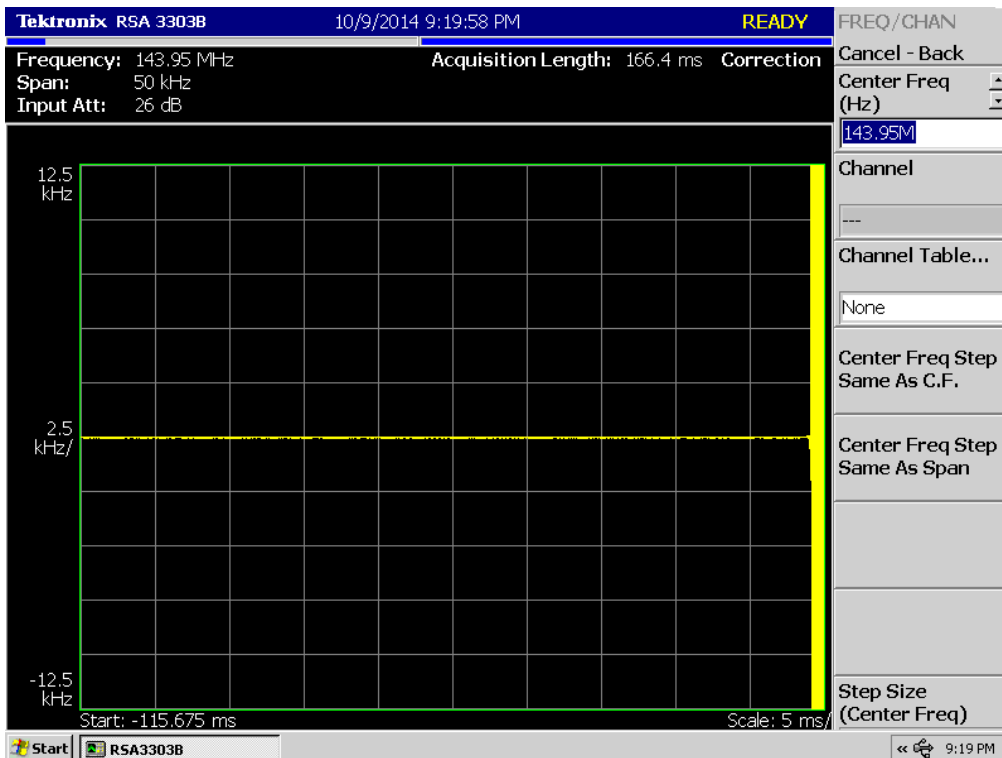
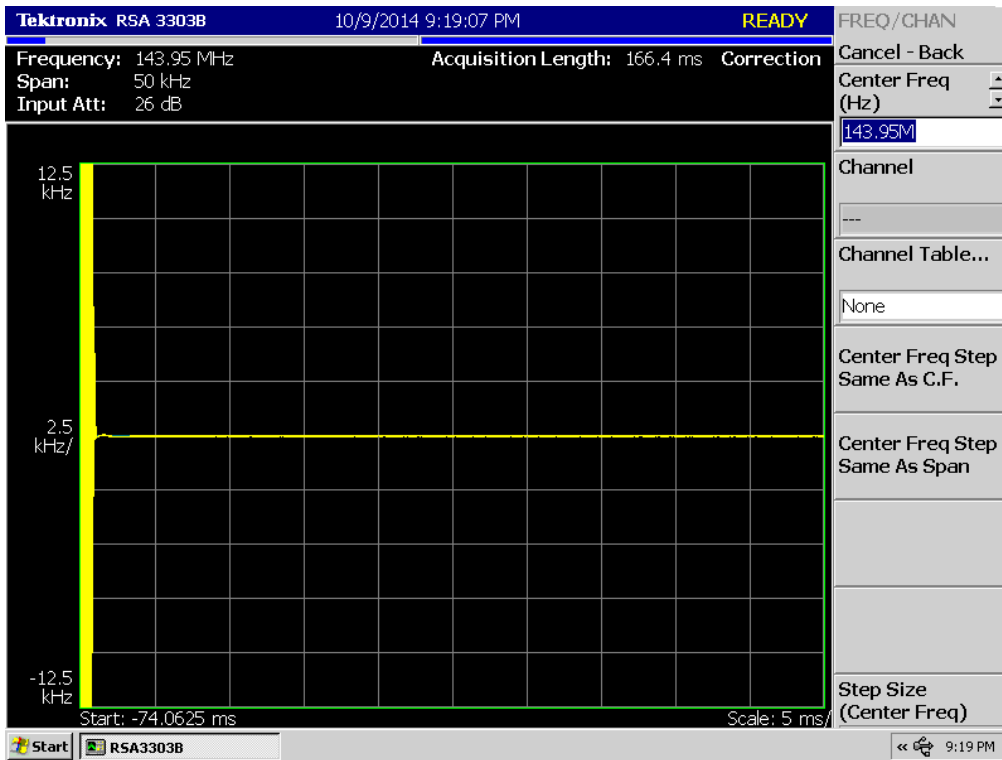

(8K10F1W _ 148.05 MHz)_Low

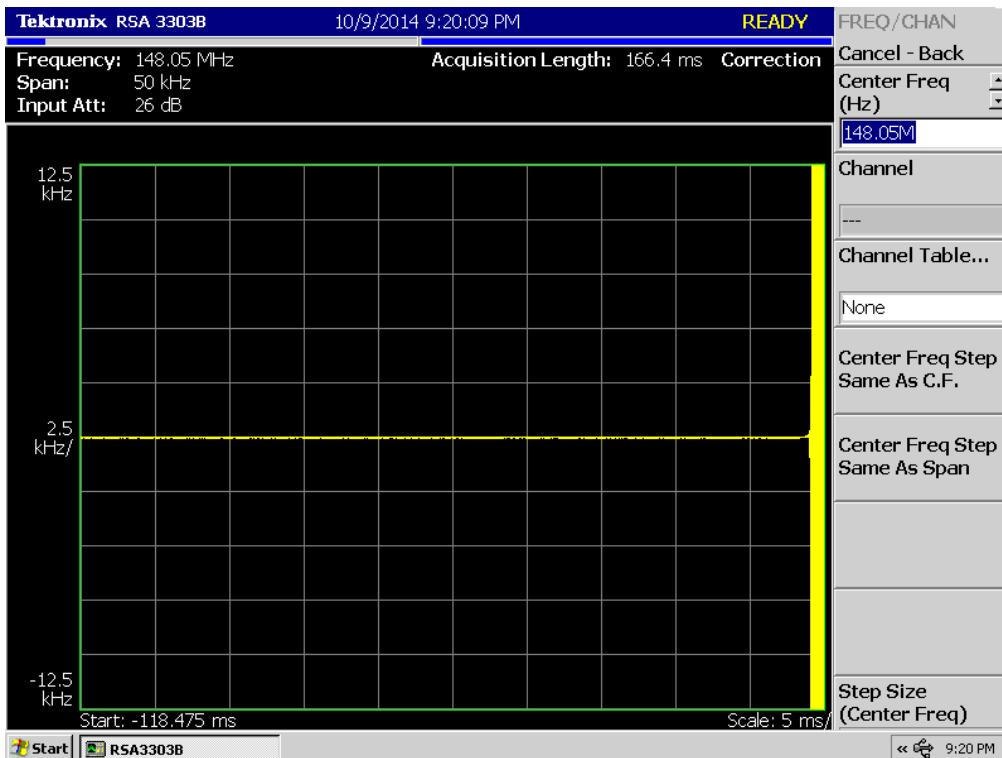
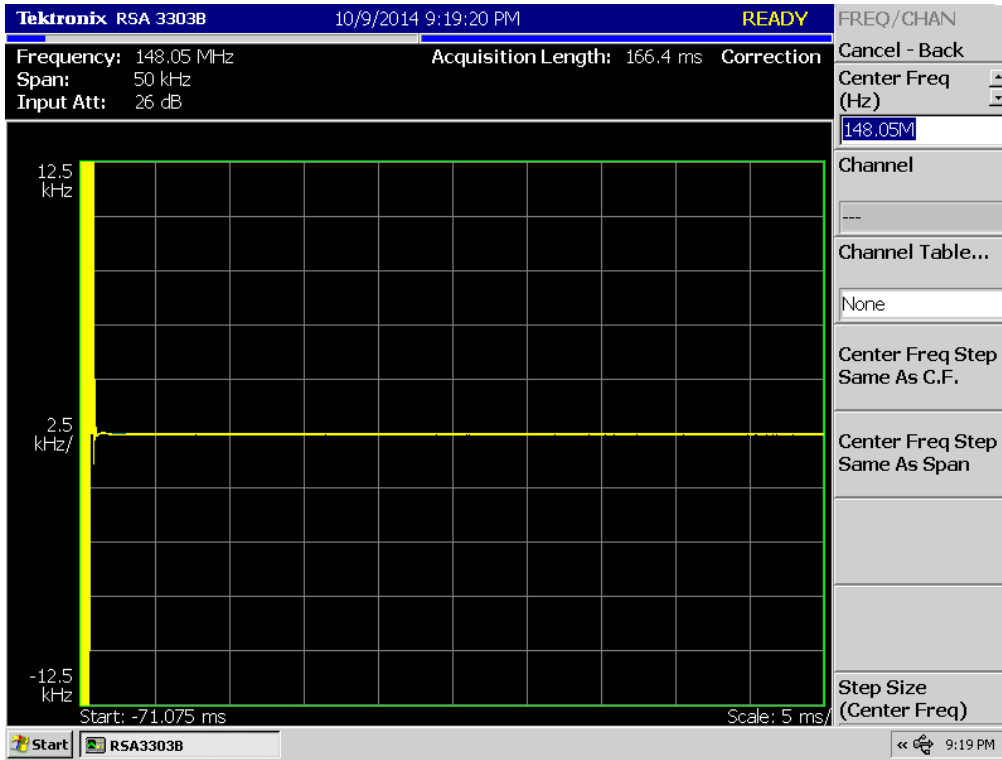

(8K30F1E, 8K30F1D, 8K30F7W _ 138.05 MHz)_High

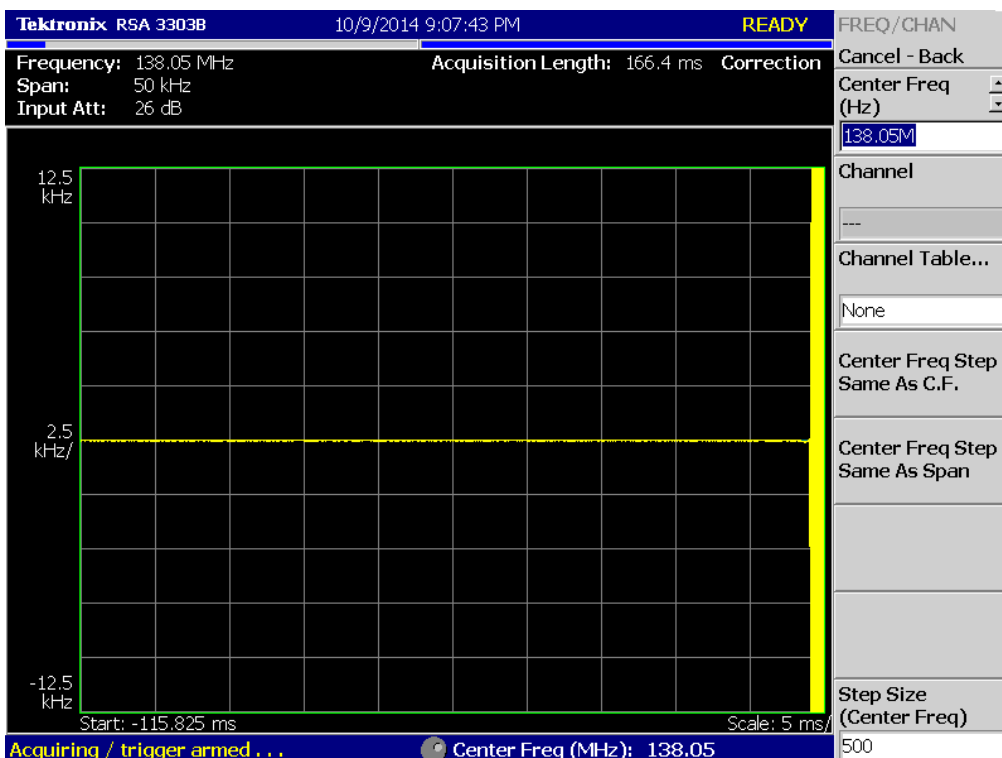
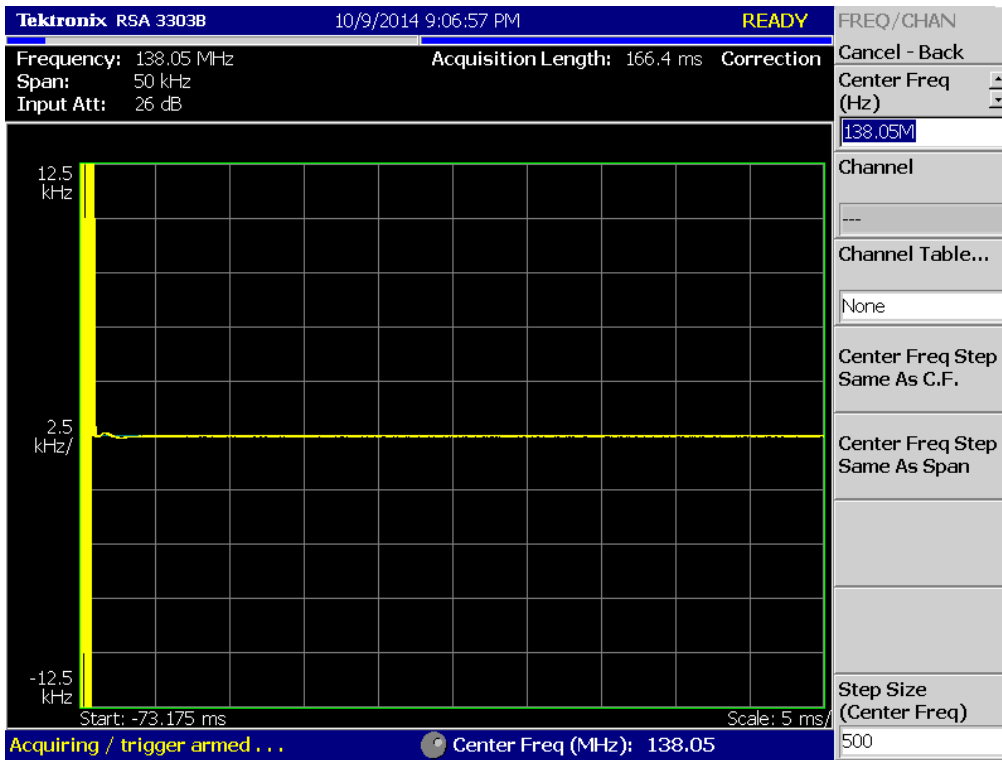

(8K30F1E, 8K30F1D, 8K30F7W _ 143.95 MHz)_High

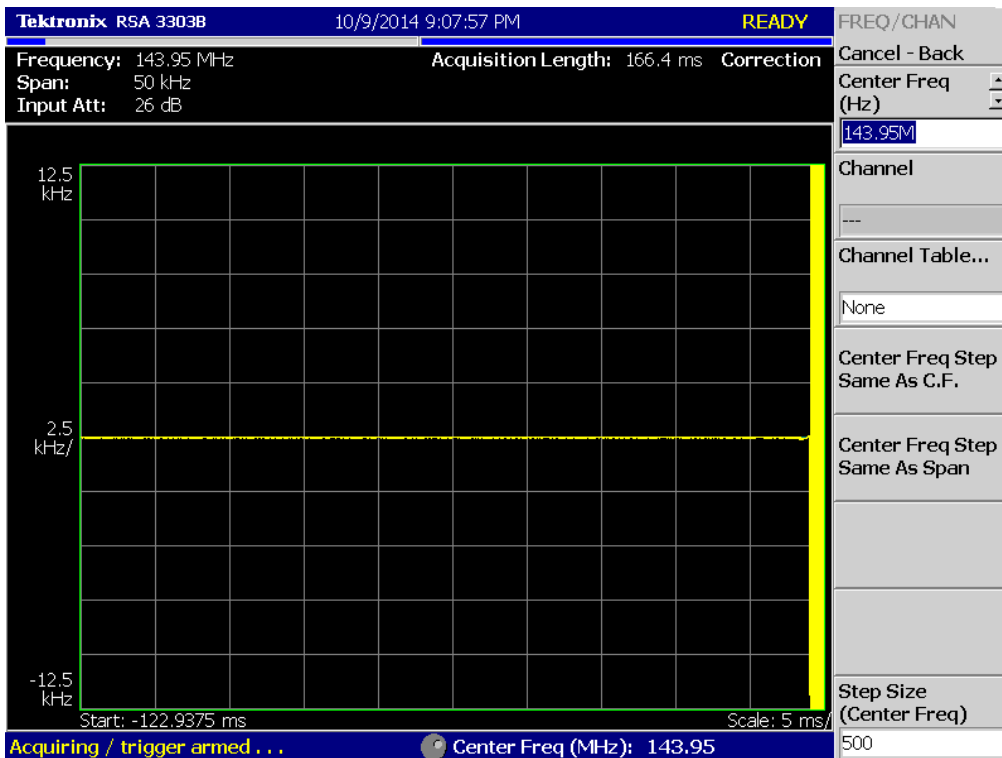
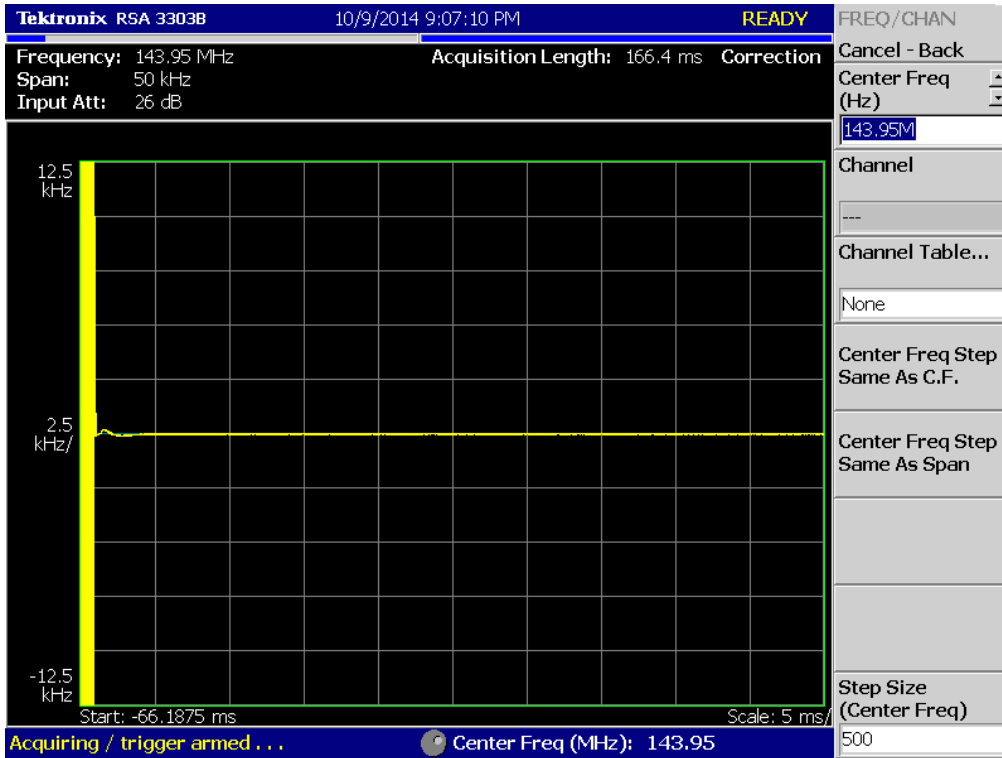

(8K30F1E, 8K30F1D, 8K30F7W _ 148.05 MHz)_High

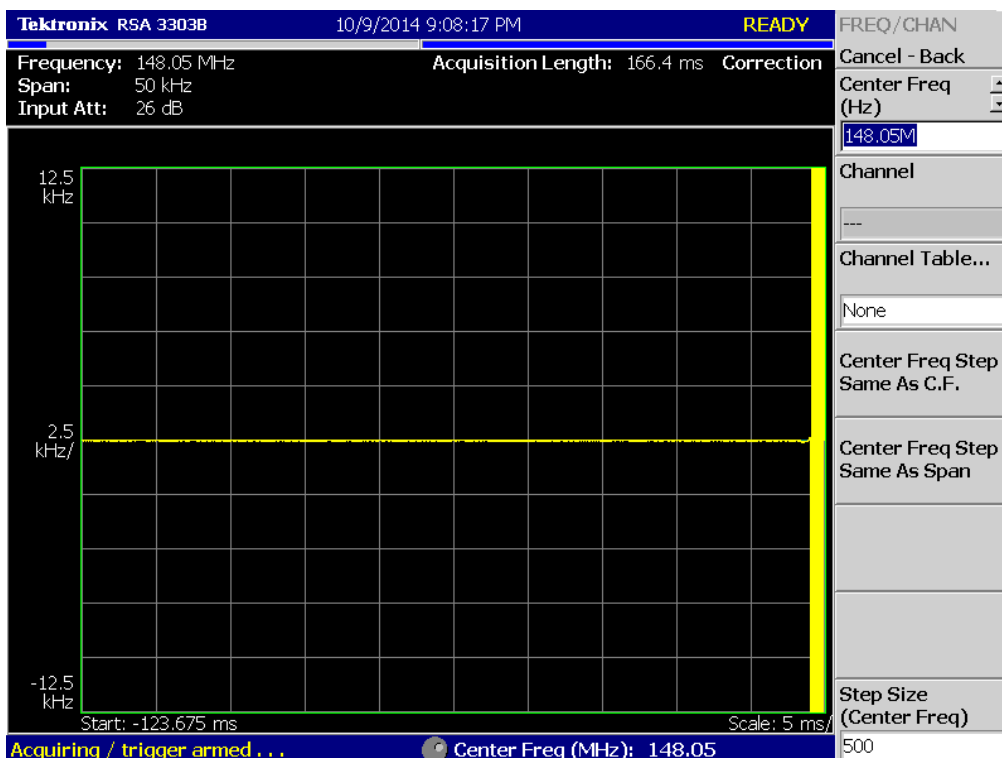
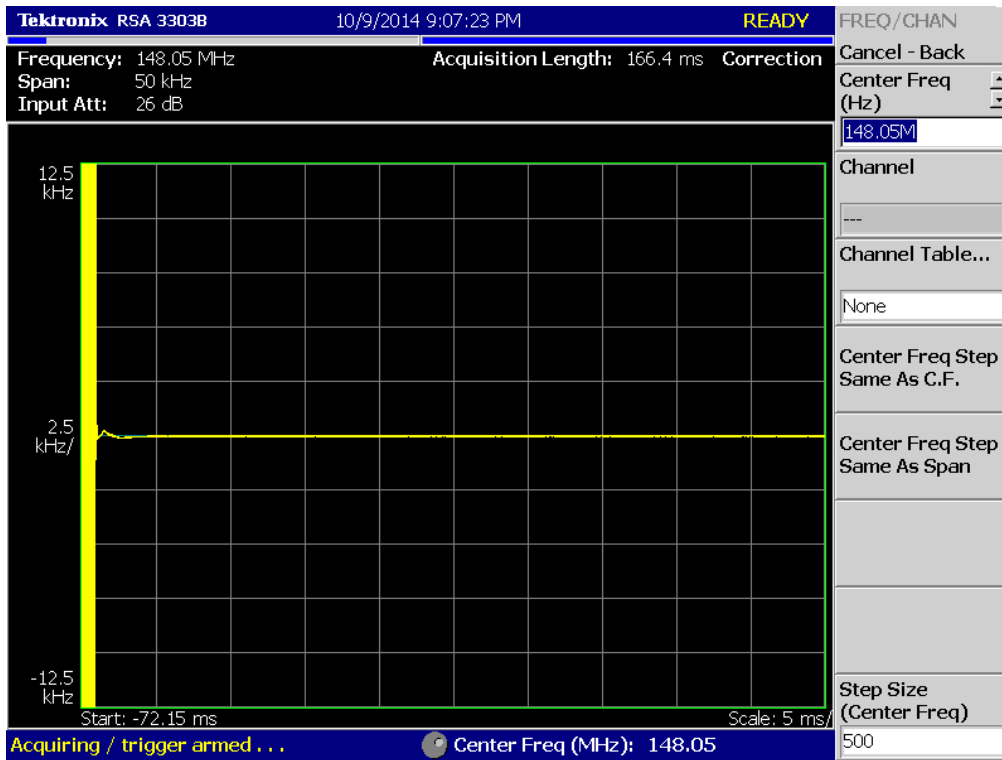

(8K30F1E, 8K30F1D, 8K30F7W _ 138.05 MHz)_Low

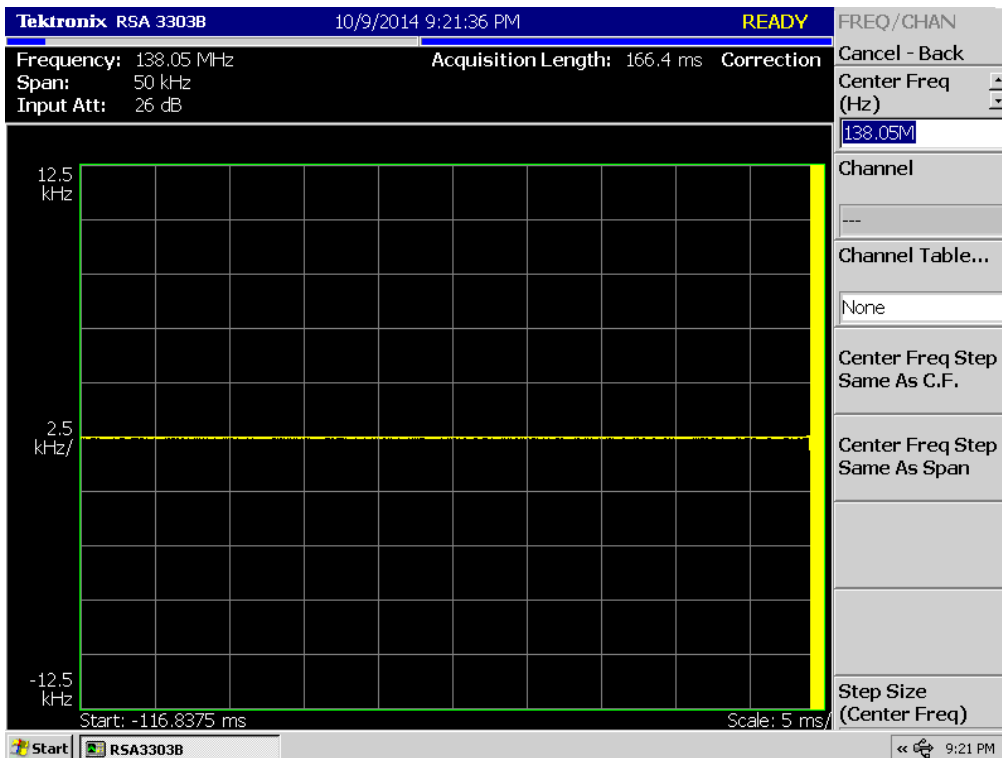
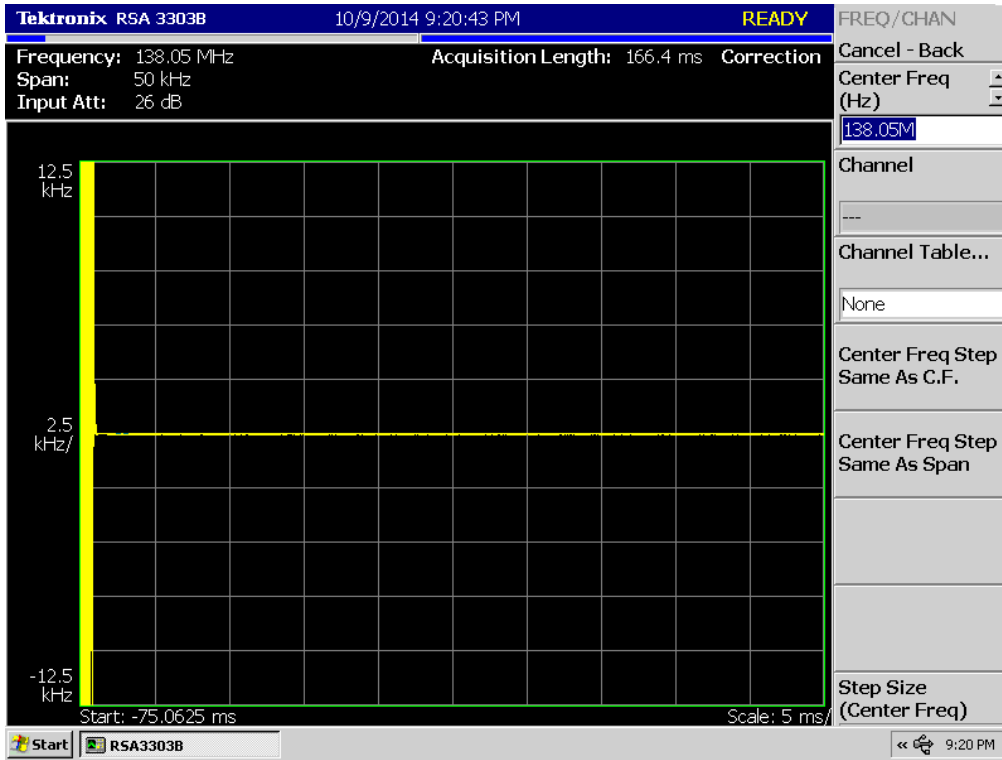

(8K30F1E, 8K30F1D, 8K30F7W _ 143.95 MHz)_Low

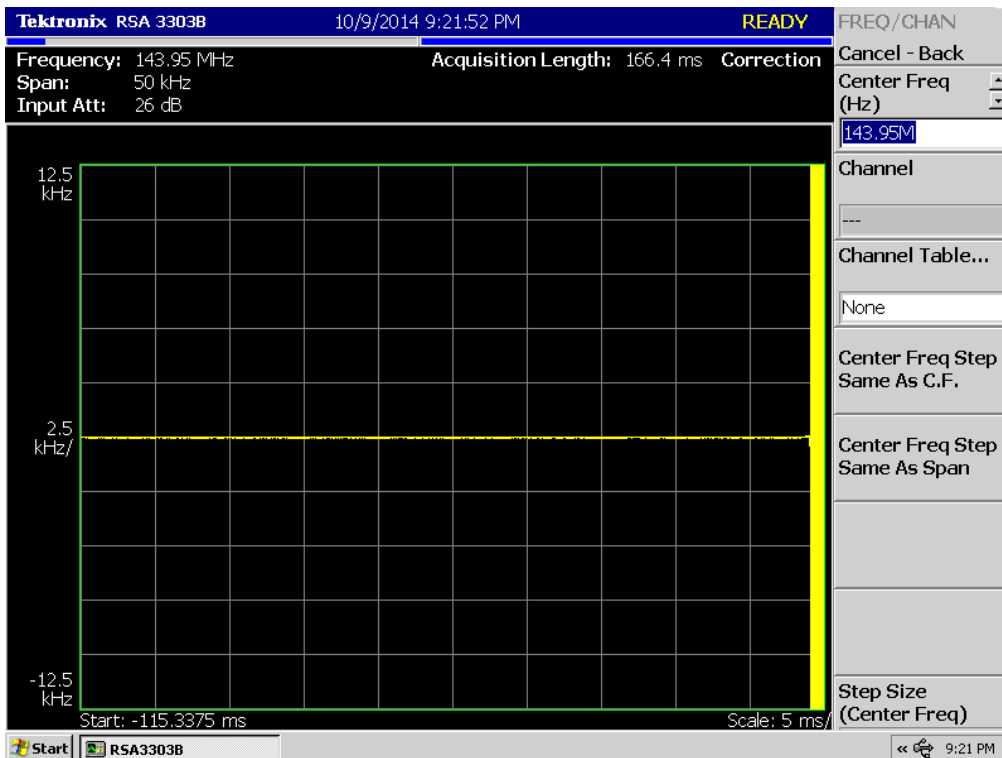
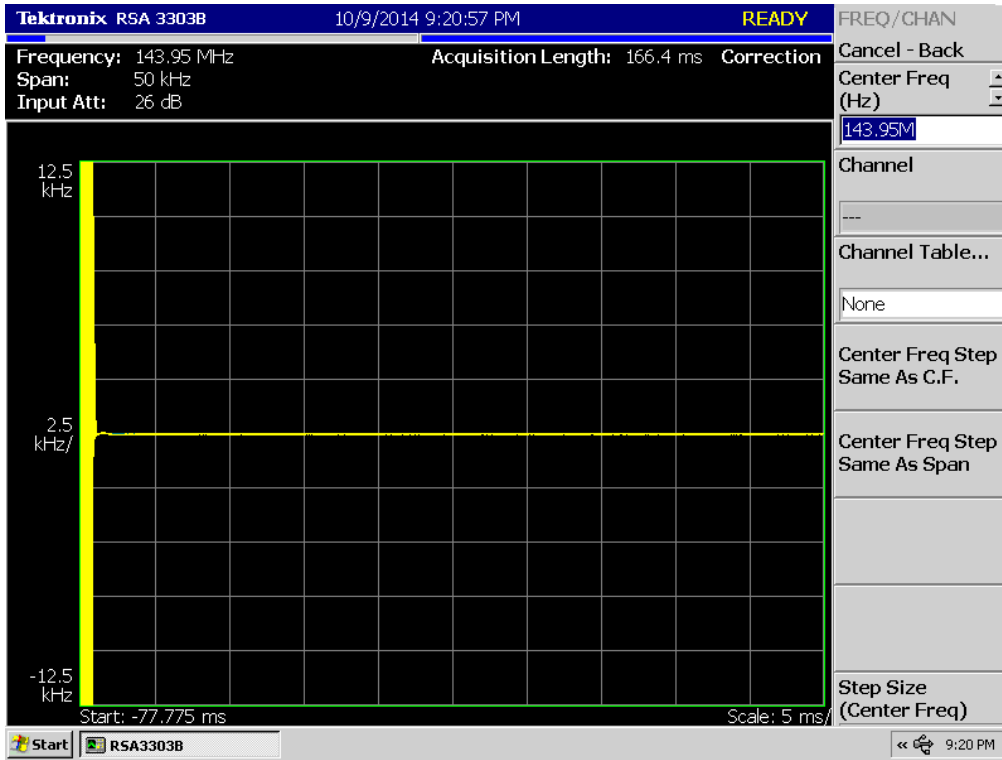

(8K30F1E, 8K30F1D, 8K30F7W _ 148.05 MHz)_Low

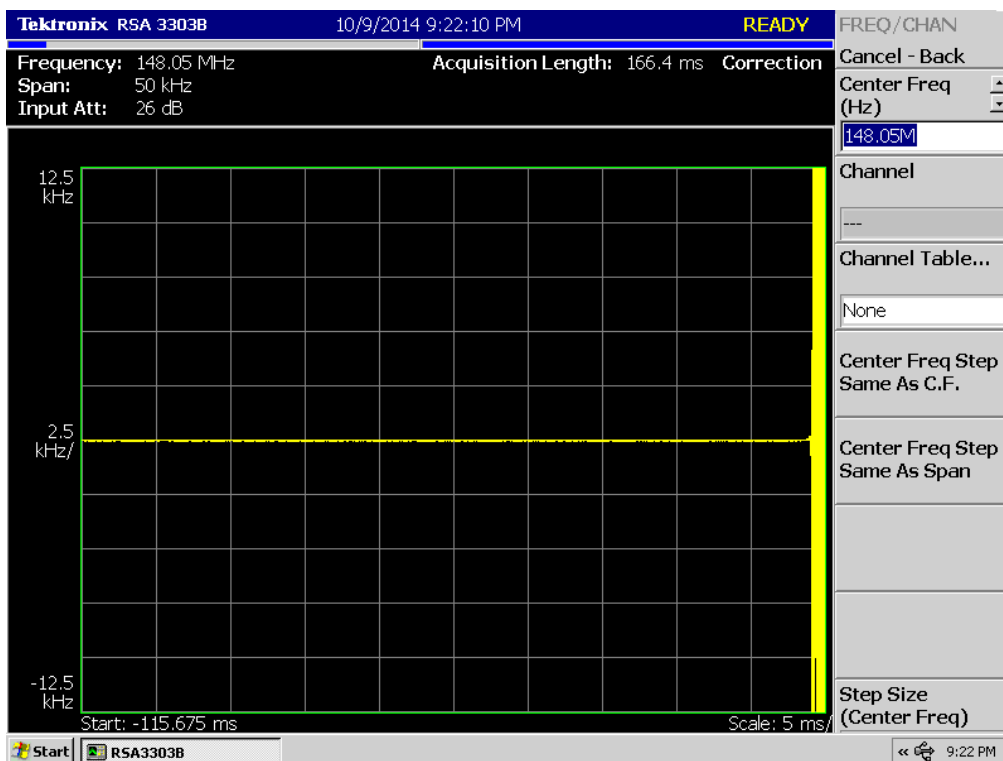
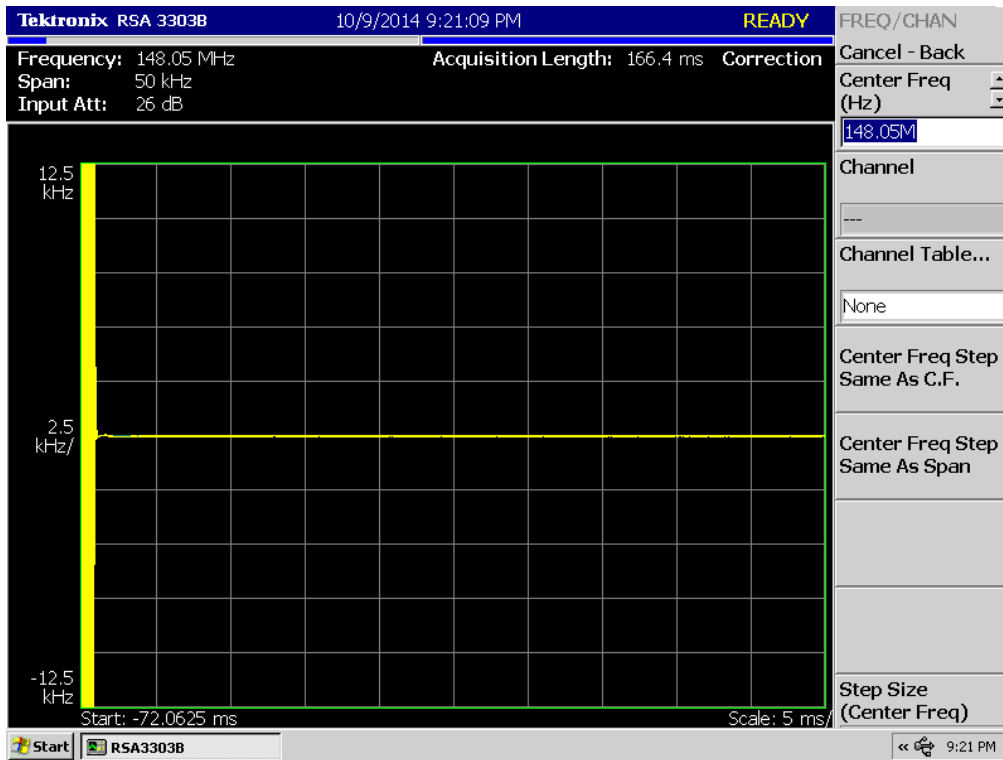

(4K00F1E, 4K00F1D, 4K00F7W _ 138.05 MHz)_High

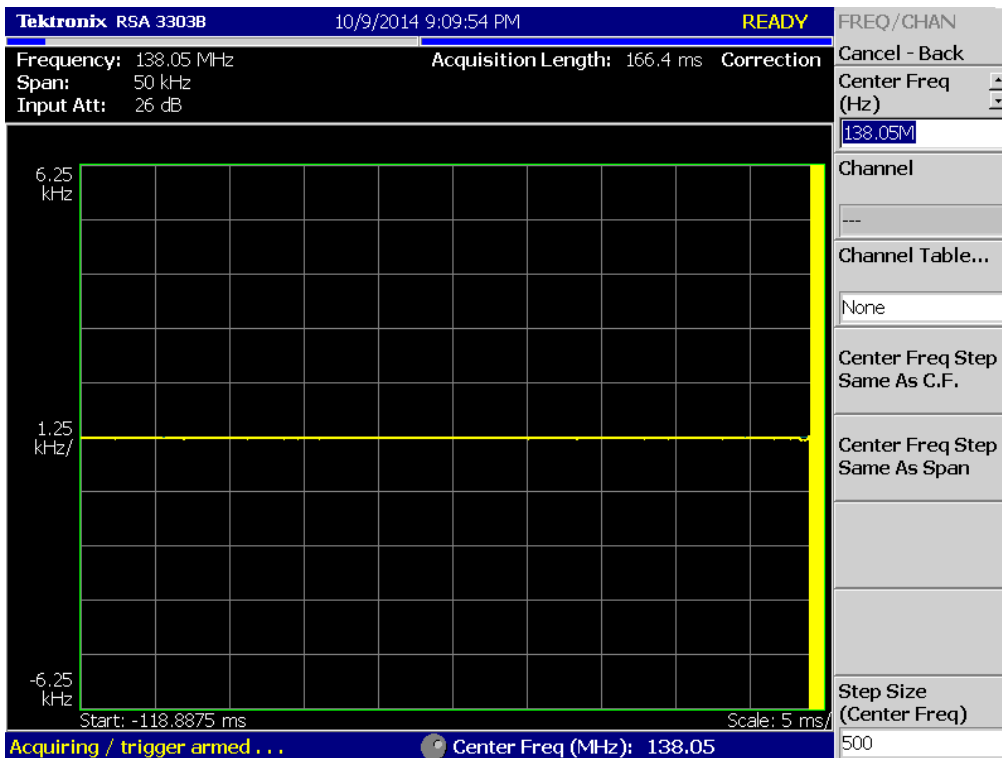
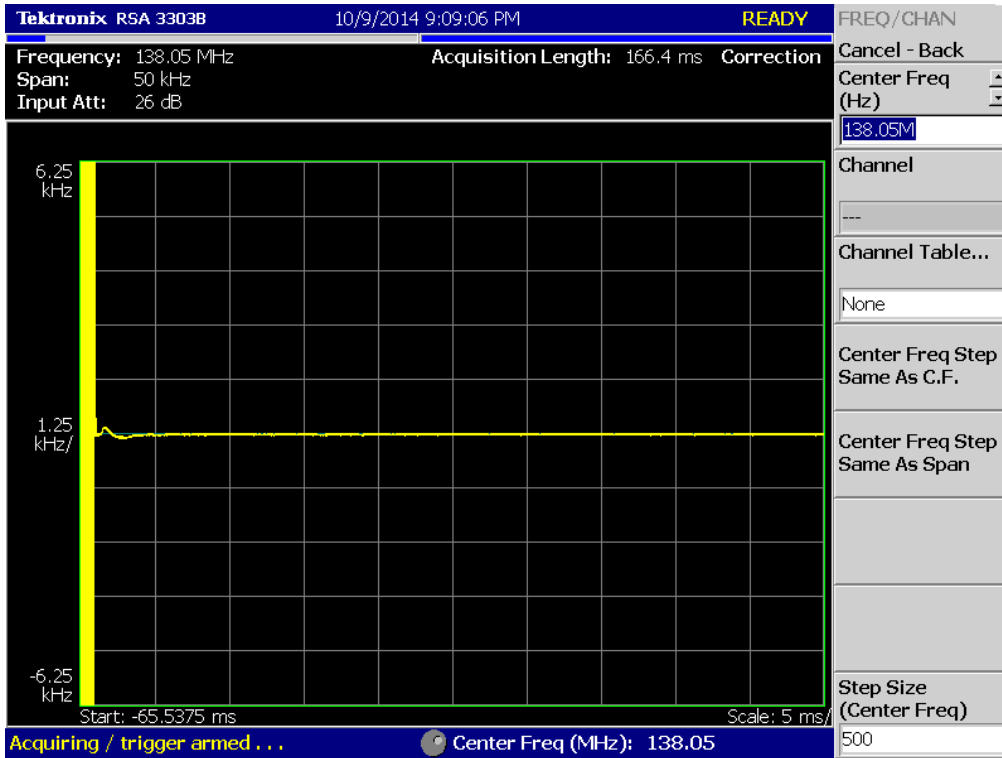

(4K00F1E, 4K00F1D, 4K00F7W _ 143.95 MHz)_High

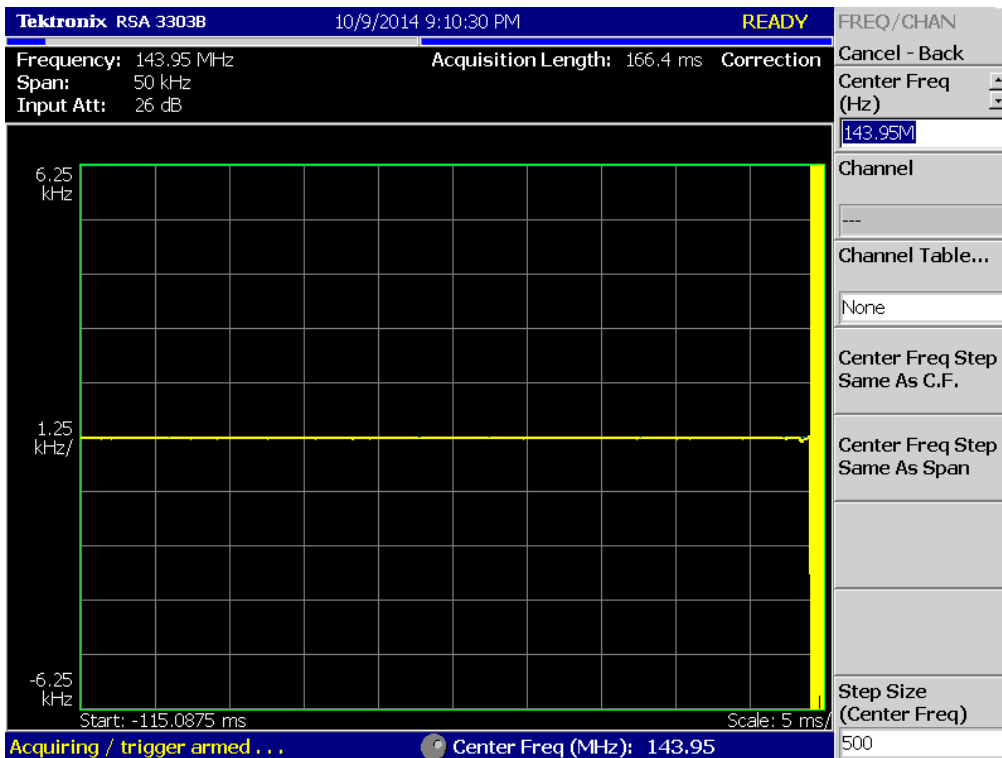
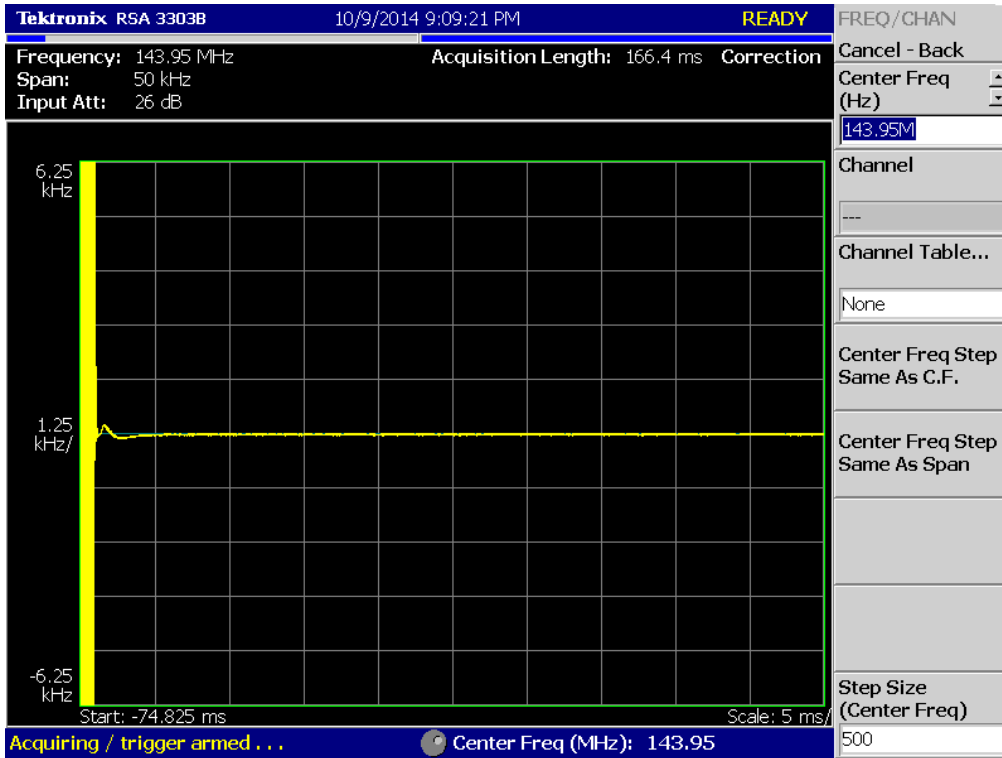

(4K00F1E, 4K00F1D, 4K00F7W _ 148.05 MHz)_High

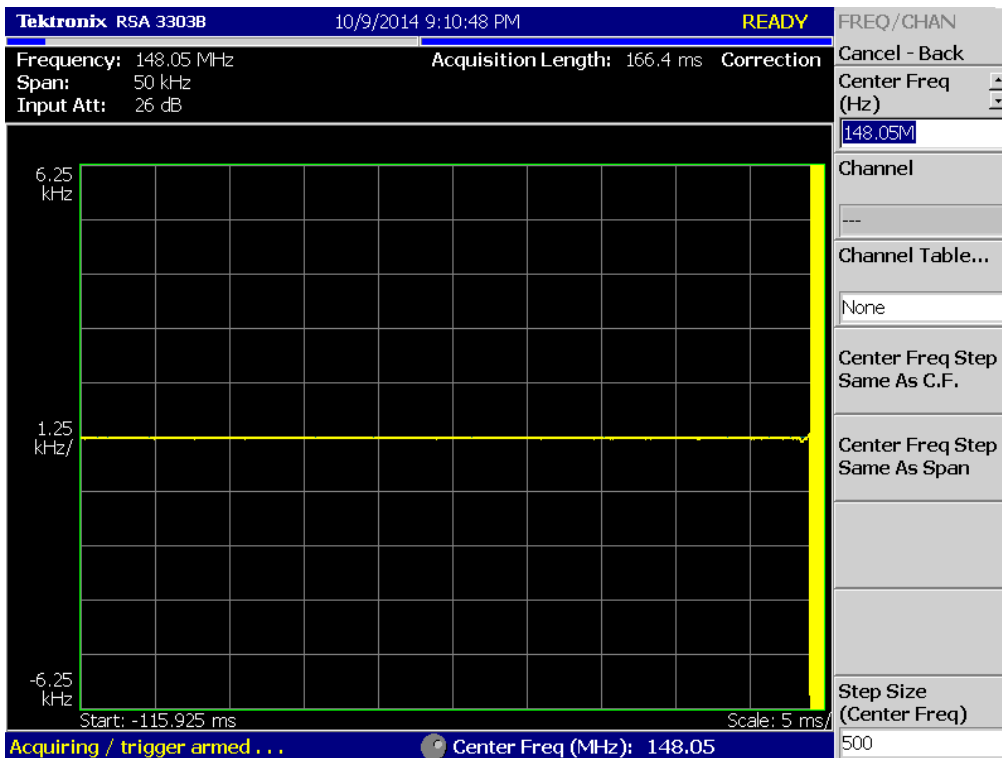
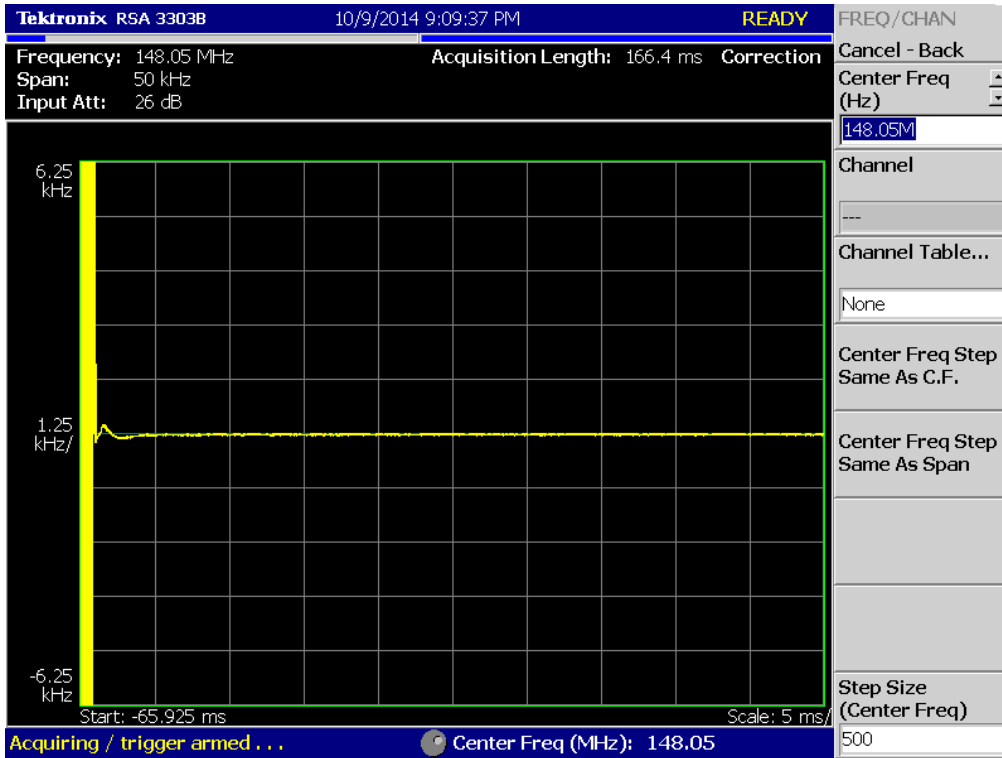

(4K00F1E, 4K00F1D, 4K00F7W _ 138.05 MHz)_Low

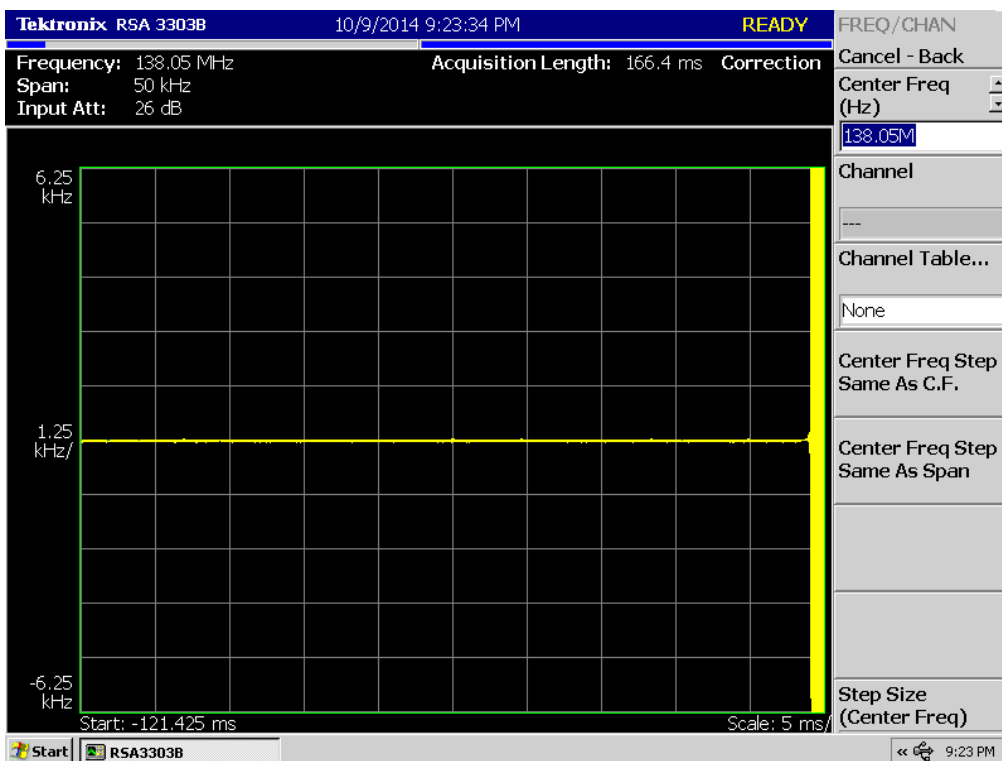
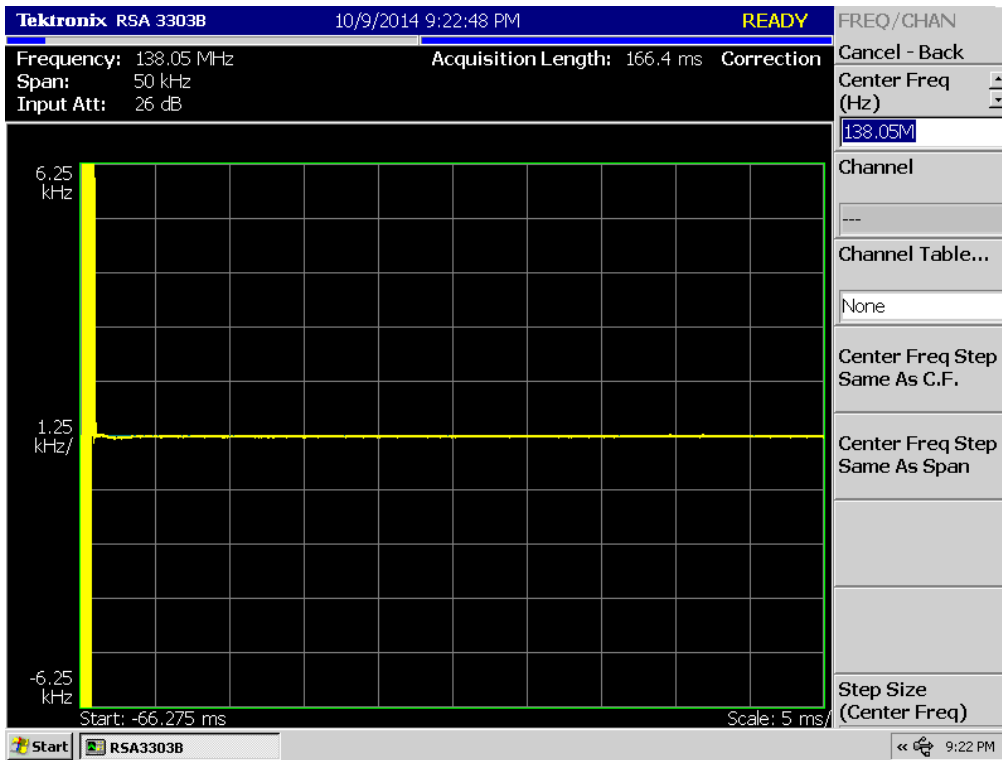

(4K00F1E, 4K00F1D, 4K00F7W _ 143.95 MHz)_Low

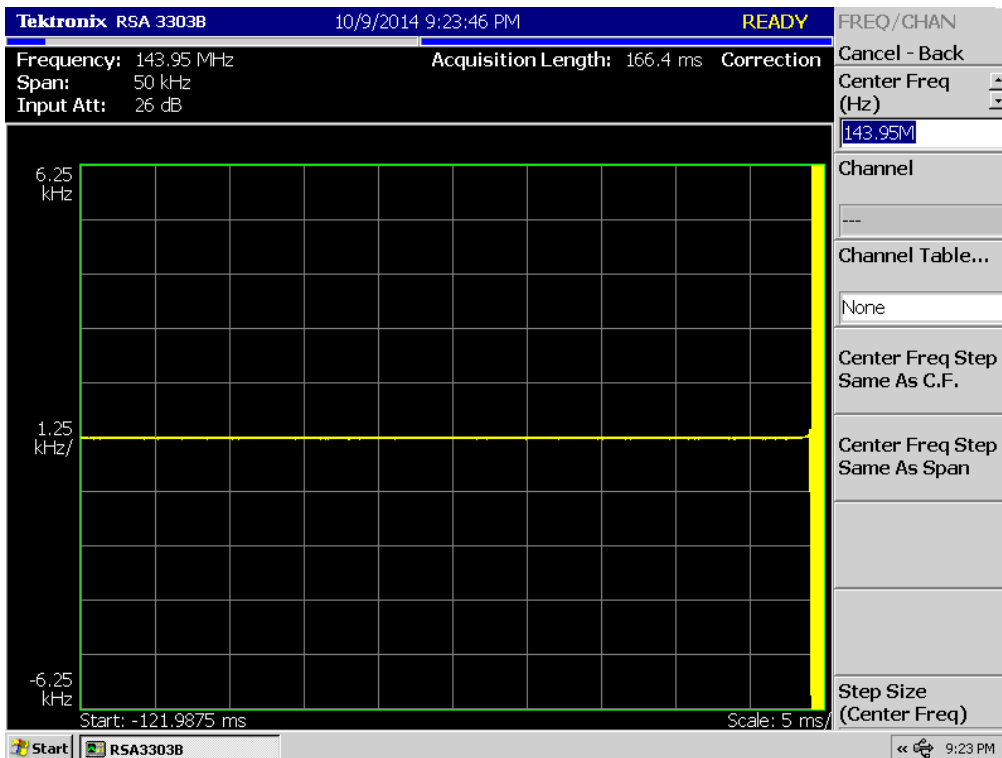
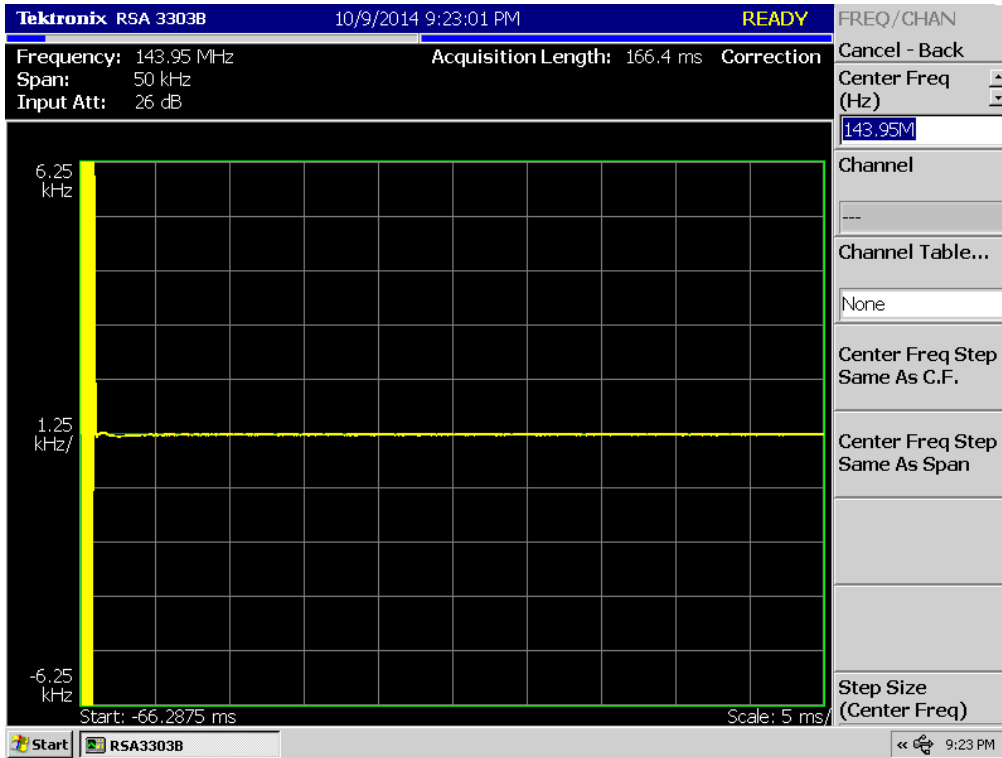

(4K00F1E, 4K00F1D, 4K00F7W _ 148.05 MHz)_Low

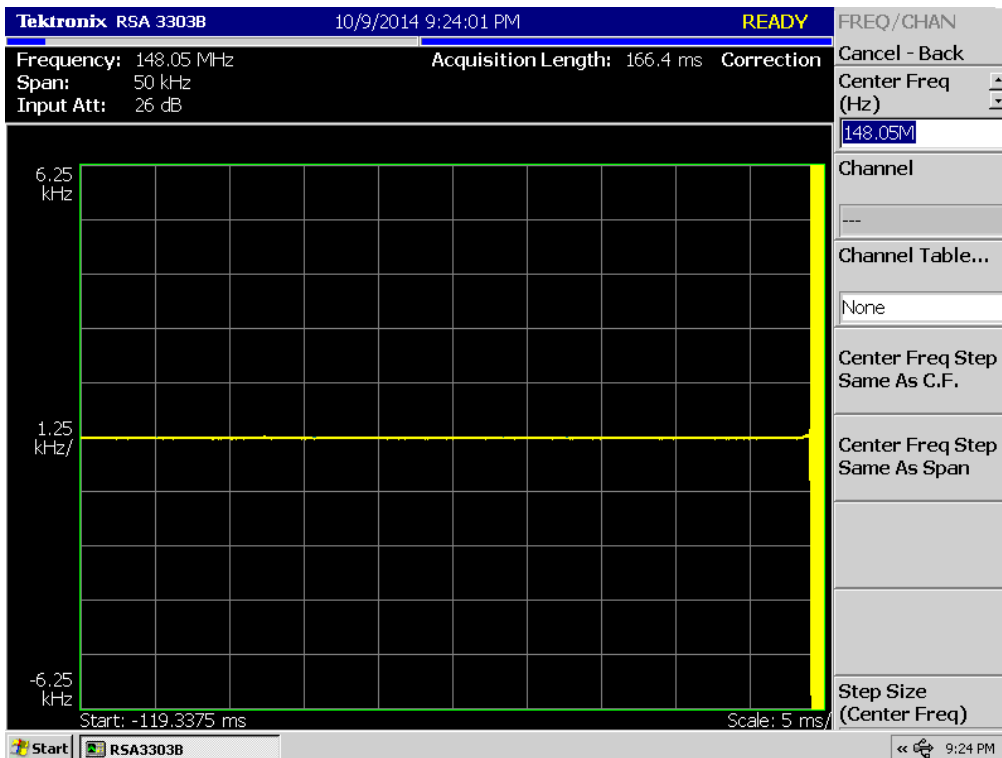
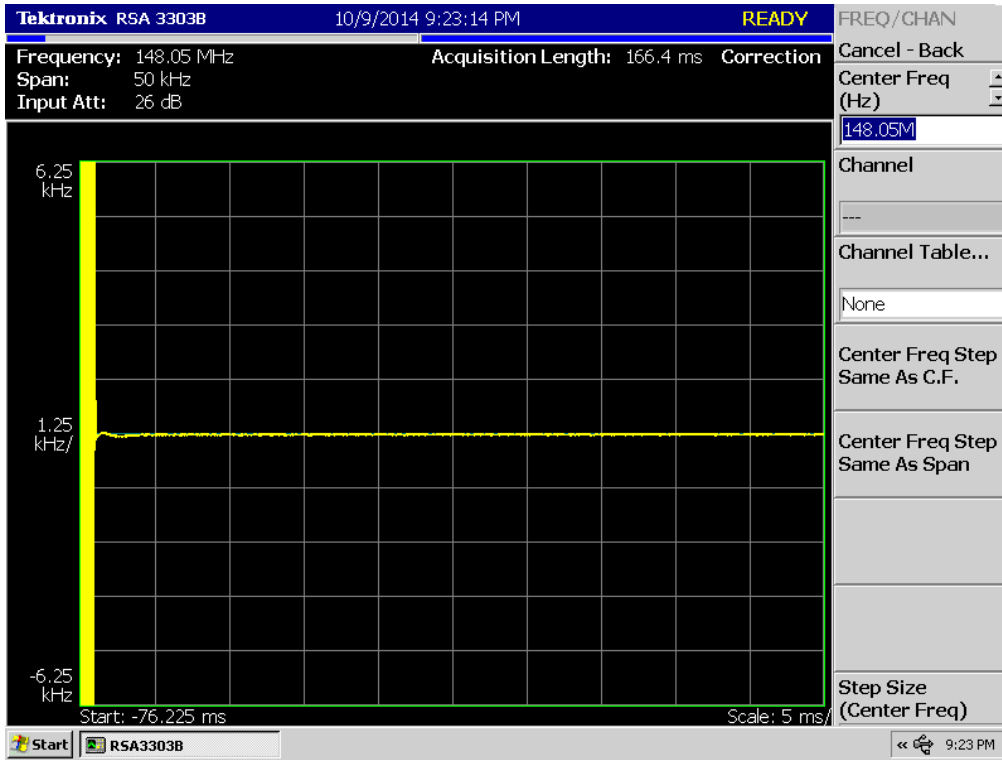

(4K00F2D _ 138.05 MHz)_Low

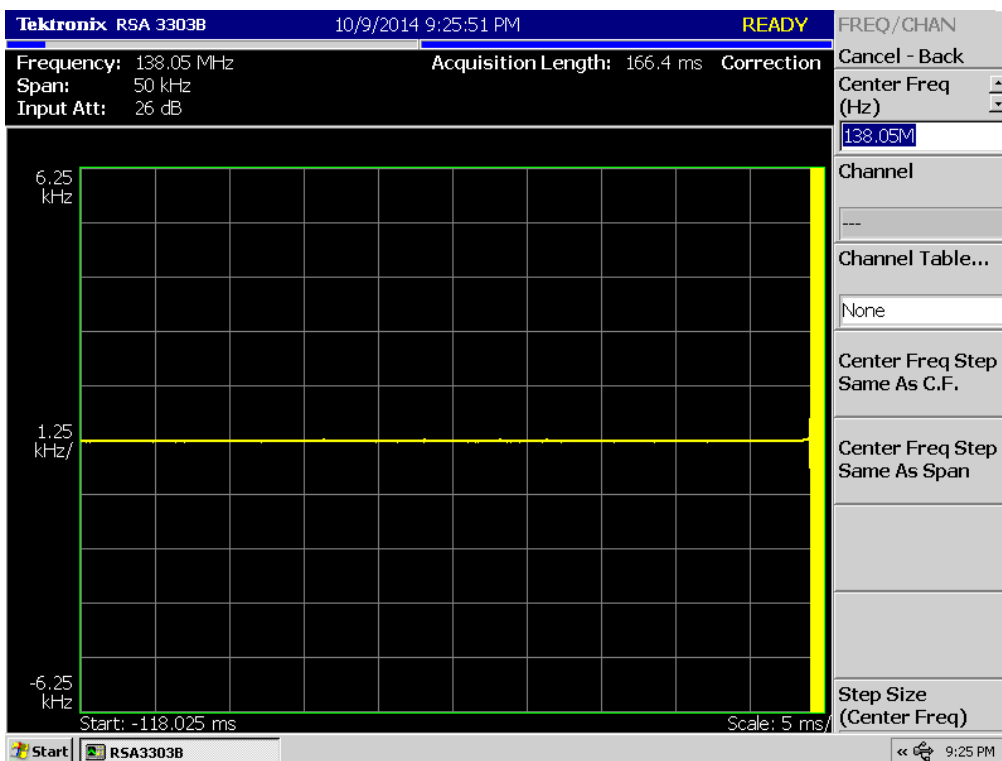
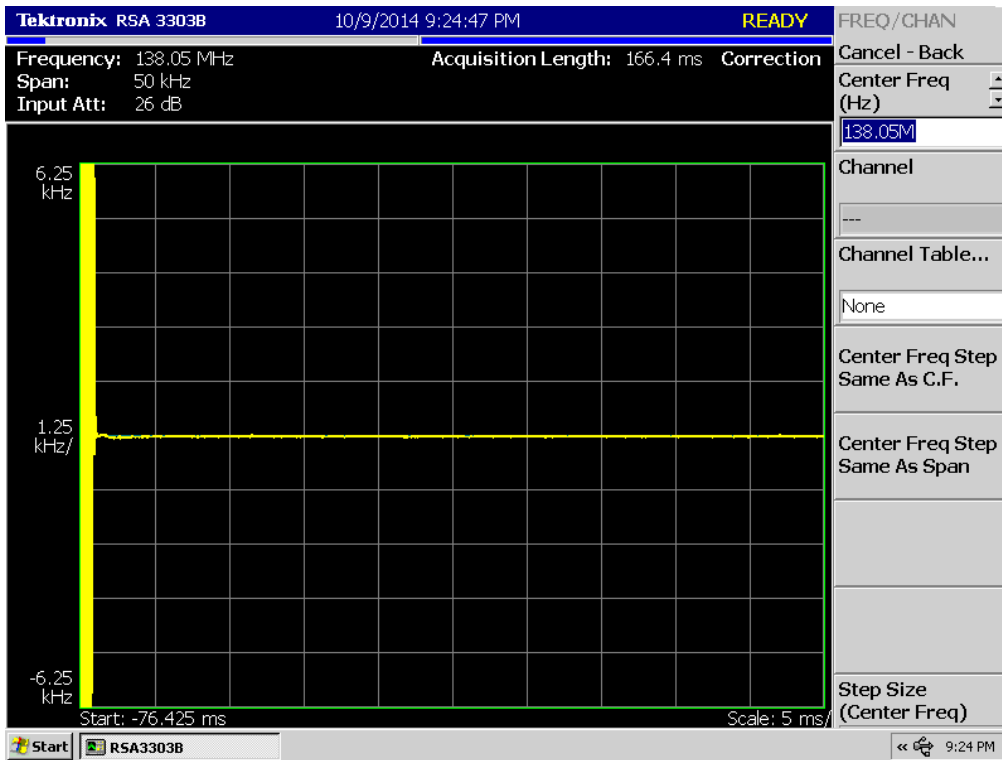

(4K00F2D _ 143.95 MHz)_Low

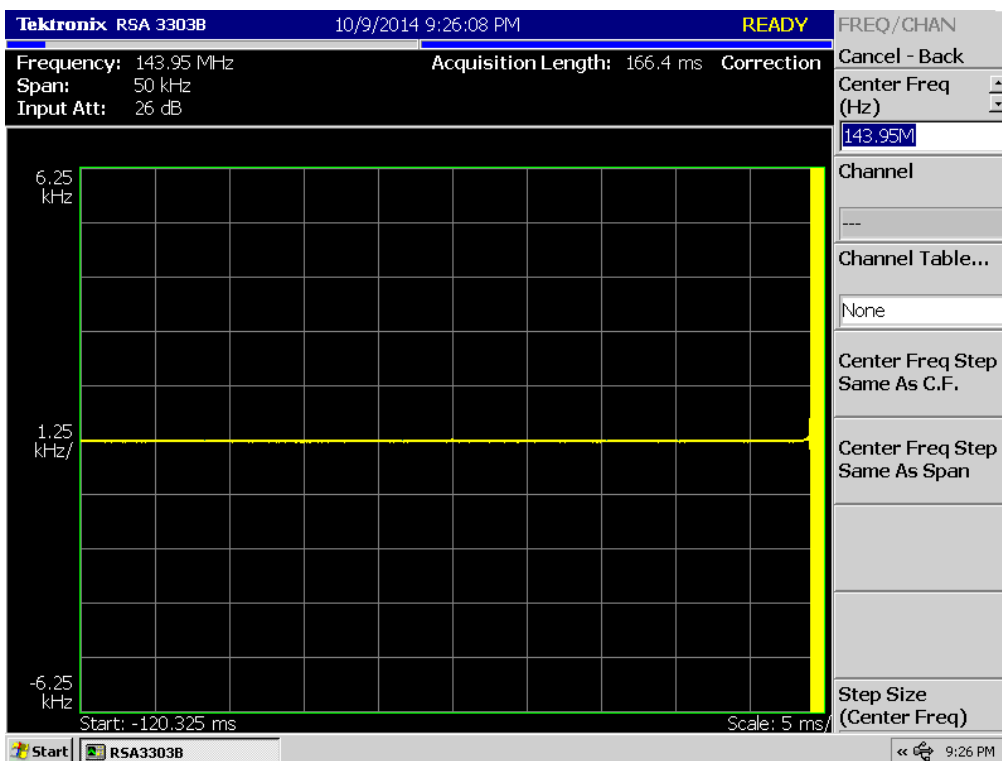
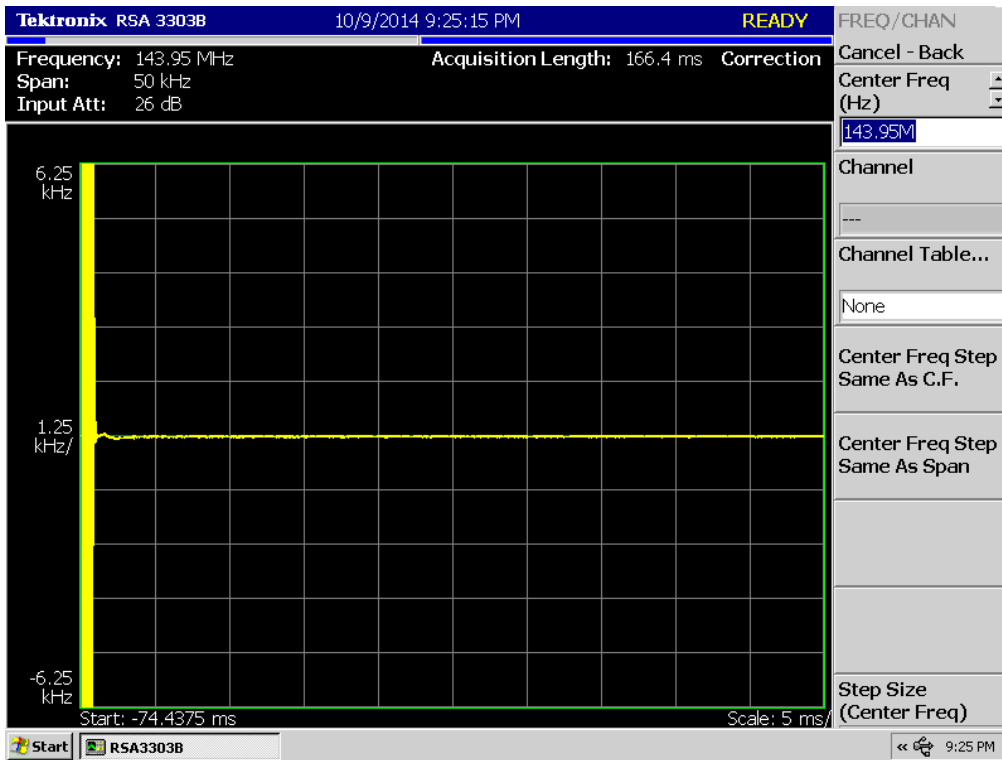

(4K00F2D _ 148.05 MHz)_Low

