



TEST REPORT

REGULATION : FCC Part 2, 90
 RSS-119 Issue 12

Applicant	Testing Laboratory
JVC KENWOOD Corporation 1-16-2, Hakusan, Midori-ku, Yokohama-shi Kanagawa, 226-8525 Japan Tel.: +81 45 939 6254 Fax.: +81 45 939 6261	Intertek Japan K.K. Kashima Laboratory URL: http://www.japan.intertek-etlsemko.com (No.12 Test site) 298-6 Sada, Kashima, Ibaraki 314-0027 Japan Tel. +81 299 82 8464 (No.1 Test site) 3-2 Sunayama, Kamisu, Ibaraki 314-0255 Japan Tel. +81 479 40 1097

Equipment type	UHF DIGITAL TRANSCEIVER
Trademark	KENWOOD
FCC Model(s)	NX-800H-K, NX-800-K, TK-5820-K
IC Model(s)	NX-800H-K, NX-800-K, TK-5820-K (HVIN:NX-800H-K-17, NX-800-K-17, TK-5820-K-17)
Serial No.	20
FCC ID	K44378704
IC CN and UPN	282F-378704
Test Result	Complied
Report Number	17030289JKA-003
Original Issue Date	June 05, 2017

This report is for the exclusive use of Intertek's Client and is provided pursuant to the agreement between Intertek and its Client. Intertek's responsibility and liability are limited to the terms and conditions of the agreement. Intertek assumes no liability to any party, other than to the Client in accordance with the agreement, for any loss, expense or damage occasioned by the use of this report. Only the Client is authorized to permit copying or distribution of this report and then only in its entirety. Any use of the Intertek name or one of its marks for the sale or advertisement of the tested material, product or service must first be approved in writing by Intertek. The observations and test results in this report are relevant only to the sample tested. This report by itself does not imply that the material, product, or service is or has ever been under an Intertek certification program.

Approved by

Hideaki Kosemura

[Technical Manager]

Tested by

Koichi Wagatsuma

[Engineer]



In Accordance with FCC Rules and Regulations, Volume II, Part 2 and 90

Sub-part 2.1033

Applicant and Manufacture Information	
APPLICANT	
Company	: JVC KENWOOD Corporation
Address	: 1-16-2, Hakusan, Midori-ku, Yokohama-shi Kanagawa, 226-8525 Japan
Contact Person	: Tamaki Shimamura Manager, Communications Systems Division
MANUFACTURER	
Company	: JVC KENWOOD Corporation
Address	: 1-16-2, Hakusan, Midori-ku, Yokohama-shi Kanagawa, 226-8525 Japan
(c)(2) FCC ID	
FCC ID	: K44378704
Model number	: NX-800H-K, NX-800-K, TK-5820-K
Serial number	: 20
Instruction Manual(S)	
Instruction manual(s)	: Please refer to attached Exhibits F
Type of Emission	
Emission Designation	: 16K0F3E(Wide) , 14K4F1D(Wide) 16K0F3E and 14K4F1D are IC (450 to 470MHz) and FCC(470 to 512MHz) Only. 11K0F3E(Narrow) 8K30F1E(Narrow) / 8K30F1D(Narrow) / 8K30F7W(Narrow) 8K10F1E(Narrow) / 8K10F1D(Narrow) 4K00F1E(Very Narrow) / 4K00F1D(Very Narrow) / 4K00F7W(Very Narrow) 4K00F2D(Very Narrow)
Frequency range	
Frequency Range	: FCC: 450 to 512 MHz IC: 450 to 470 MHz
Power Rating	
Output Power	: 1 to 45 W
Type	: Continuously Variable
Maximum Power Rating	
Output Power	: 45W
Voltages & currents in all elements in final RF stage, including final transistor or solid-state device	
Collector Current, A	: 13.0 A Maximum
Collector Voltage, Vdc	: 13.6 Vdc
Supply Voltage, Vdc	: 13.6 Vdc
Other Information	
Number of Channel	: Zone 128max. Cannels 250 max.(per Zone)
Maximum Deviation	: ± 5 kHz (16K0F3E), ± 2.5 kHz (11K0F3E)
Frequency Stability	: 1.0 ppm
	:
Antenna Impedance	: 50 Ω Norminal
Note	

TABLE OF CONTENTS

	Page
SECTION 1. GENERAL INFORMATION	4
SECTION 2. SUMMARY OF TEST RESULT	5
SECTION 3. TEST AND MEASUREMENT DATA	6
SECTION 4. INFORMATION ABOUT EUT AND SUPPORT EQUIPMENT(S)	7
SECTION 5. SUPPORT EQUIPMENT	8
SECTION 6. USED CABLE(S)	9
SECTION 7. TEST CONFIGURATION	10
SECTION 8. OPERATING CONDITION	11
SECTION 9. MEASUREMENT UNCERTAINTY	12
SECTION 10. TEST DATA	
10.1 Carrier Output Power (Conducted)	13
10.2 Unwanted Emissions (Transmitter Conducted)	16
10.3 Field Strength of Spurious Radiation	19
10.4 Emission Masks (Occupied Bandwidth)	23
10.5 Transient Frequency Behavior	40
10.6 Audio Frequency Response / Audio Low Pass Filter (Voice Input)	51
10.7 Modulation Limiting	55
10.8 Frequency Stability (Temperature Variation)	61
10.9 Frequency Stability (Voltage Variation)	64
10.10 Receiver Spurious Emissions(Radiated)	66
10.11 Necessary Bandwidth and Emission Bandwidth	70
10.12 99% Occupied Bandwidth	72
APPENDIX PHOTOGRAPHS	

SECTION 1. GENERAL INFORMATION**TEST PERFORMED**

Location	Kashima No.1 Test Site and No.12 Test Site		
EUT Received	April 14, 2017		
Date of Test	April 18, 2017	to	May 26, 2017
Standard Applied	FCC Part 2, 90 RSS-119 Issue 12		
Measurement Method	ANSI/TIA-603-D-2010 / RSS-119 Issue 12(2015), RSS-Gen Issue 4(2014)		
Deviation from Standard(s)	Not applicable		

QUALIFICATIONS OF TESTING LABORATORY (Kashima Lab.)

ACCREDITATION	SCOPE	LAB. CODE	Remarks
VLAC	EMC Testing	VLAC-008-1	JAPAN
FILING			
VCCI	EMC Testing	A-0126	JAPAN
FCC	EMC Testing	JP0008	
IC	EMC Testing	IC-2042K-3, IC-2042Q-12	CANADA
CB-Scheme	EMC Testing	TL222	IECEE

ABBREVIATIONS

EUT	Equipment Under Test	DoC	Declaration of Conformity
AMN	Artificial Mains Network	ISN	Impedance Stabilization Network
LISN	Line Impedance Stabilization Network	Q-P	Quasi-peak
AMP	Amplifier	AVG	Average
ATT	Attenuator	PK	Peak
ANT	Antenna	Cal	Calibration
BBA	Broadband Antenna	N/A	Not applicable or Not available
DIP	Dipole Antenna	LCD	Liquid-Crystal Display
AE	Associated Equipment	4LEVEL FSK	4LEVEL Frequency Shift Key
GMSK	Gaussian Maximum Shift Key	CW ID	Continuously Repeating bit stream
FM	Frequency Modulation	C4FM	Constant envelope 4 Level FM
PTT	Push to Talk	AFC	Automatic frequency control

Revision Summary

Revised Date	Section	Description of Changes

SECTION 2. SUMMARY OF TEST RESULT

FCC Part2	Part90	IC RSS-119	TEST ITEM	RESULTS	Comments
2.1046 (a)	-	5.4	Carrier Output Power (Conducted)	PASS	
2.1051	90.210	5.8	Unwanted Emissions (Transmitter Conducted)	PASS	
2.1053 (a)	90.210	5.8	Field Strength of Spurious Radiation	PASS	
2.1049 (c) (1)	90.210	5.5	Emission Masks (Occupied Bandwidth)	PASS	
-	90.214	5.9	Transient Frequency Behavior	PASS	
2.1047 (a)	-	-	Audio Low Pass Filter (Voice Input)	PASS	
2.1047 (a)	-	-	Audio Frequency Response	PASS	
2.1047 (b)	-	-	Modulation Limiting	PASS	
2.1055 (a) (1)	90.213 (a)	5.3	Frequency Stability (Temperature Variation)	PASS	
2.1055 (d) (1)	90.213 (a)	5.3	Frequency Stability (Voltage Variation)	PASS	
-	-	RSS-Gen 7.1	Receiver Spurious Emissions	PASS	
-	90.203 (j)(3)	-	Certification required (FCC Part 90.203(j)(3))	Complied	
-	90.203 (j)(4)	-	Certification required (FCC Part 90.203(j)(4))	Complied	
-	90.203 (j)(5)	-	Certification required (FCC Part 90.203(j)(5))	Complied	
-	90.203 (e)	-	Certification required (FCC Part 90.203(e))	Complied	
-	-	5.5	99% Occupied Bandwidth	PASS	

Limitation on Results

The test result of this report is effective equipment under test itself and under the test configuration described on the report. This test report does not assure that whether the test result taken in other testing laboratory is compatible or reproducible to the test result on this report or not.

Note:

As for the FCC Part 15 Support B-Unintentional Radiators, the EUT has been measured and declared as Verification by JVC Kenwood Corporation.

SECTION 3. TEST AND MEASUREMENT DATA

All test and measurements indicated in this document were performed in accordance with the Code of Federal Regulations Title 47 Part 2, Sub-part J and Industry Canada as the following individual parts:

FCC Rule	Test Item	Tested
Part 24	Personal Communications Services	N.A.
Part 80	Stations in the Maritime Services	N.A.
Part 90	Private Land Mobile radio Services	YES

IC Rule	Test Item	Tested
RSS-119	Radio Transmitters and Receivers Operating in the Land Mobile and Fixed Services in the Frequency Range 27.4-960 MHz	YES
RSS-134	900MHz Narrowband Personal Communication Service	N.A.
RSS-Gen	General Requirements for Compliance of Radio Apparatus	YES

SECTION 4. INFORMATION ABOUT EUT AND SUPPORT EQUIPMENT(S)**4.1 List of System Configuration**

Symbol	Item	Model No.	HVIN	Serial No.	Manufacture	Remarks
A	UHF DIGITAL TRANSCEIVER	NX-800H-K NX-800-K TK-5820-K	NX-800H-K-17 NX-800-K-17 TK-5820-K-17	20	JVC KENWOOD Corporation	EUT
Power Ratings of EUT :			DC 13.6V \pm 20%	13.0 A Maximum		
Power Supply :			DC 13.6 V			
Condition of Equipment			Proto type			
Type			Mobile type			
Suppression Devices			No Modifications by the laboratory were made to the device			

4.2 Port(s)/Connector(s)

Port Name	Connector Type	Connector Pin	Remarks
ACC	D-sub	25 pin	
External Speaker	3.5 ϕ	2 pin	
RF Antenna	M	2 pin	
Microphone	RJ-45	8 pin	
Ignition sense	Original	2 pin	

4.3 Highest Frequency Oscillator(s)/Crystal(s)

Operating Frequency	Board Name	Remarks
512 MHz	TXRX UNIT	

SECTION 5. SUPPORT EQUIPMENT

The EUT was supported by the following equipment during the test.

Symbol	Item	Model No.	Serial No.	Manufacture	FCC ID
B	CONTROL HEAD REMOTE KIT	KRK-10	None	JVC KENWOOD	N/A
C	KEYPAD MICROPHONE	KMC-36	None	JVC KENWOOD	N/A
D	External Speaker	KES-3	None	JVC KENWOOD	N/A
E	Dummy Load	CT-03NP	1037408	TME	N/A
F	DC Power Supply	PMC35-3A	LE000716	KIKUSUI	N/A
G	VOICE GUIDE & STORAGE UNIT	VGS-1	None	JVC KENWOOD	N/A
H	SECURE CRYPTOGRAPHIC MODULE	KWD-AE31	None	JVC KENWOOD	N/A
I	CONTROL HEAD REMOTE KIT	KRK-10	None	JVC KENWOOD	N/A
Supplied Power:					
F	AC	100V,60Hz			

SECTION 6. USED CABLE(S)

The following cable(s) was used for the test.

No.	Name	Length (m)	Shield	Metal Connector	Ferrite core
1	KEYPAD MICROPHONE CABLE	0.50	No	No	
2	CONTROL HEAD REMOTE KIT CABLE	7.00	Yes	Yes	
3	Speaker cable	2.90	No	No	
4	Ignition sense cable	0.12	No	Yes	
5	Ignition sense cable (KCT-46)	3.20	No	Yes	
6	ACC Cable	1.70	Yes	Yes	
7	DC cable	0.25	No	No	
8	DC cable	3.00	No	No	
9	Power cable for DC Power Supply	2.00	No	No	

SECTION 7. TEST CONFIGURATION

Details of Configuration and Connection

Example: Case of Section 10.10Test

- * : EUT
- : Ferrite core
- : Joint Connector

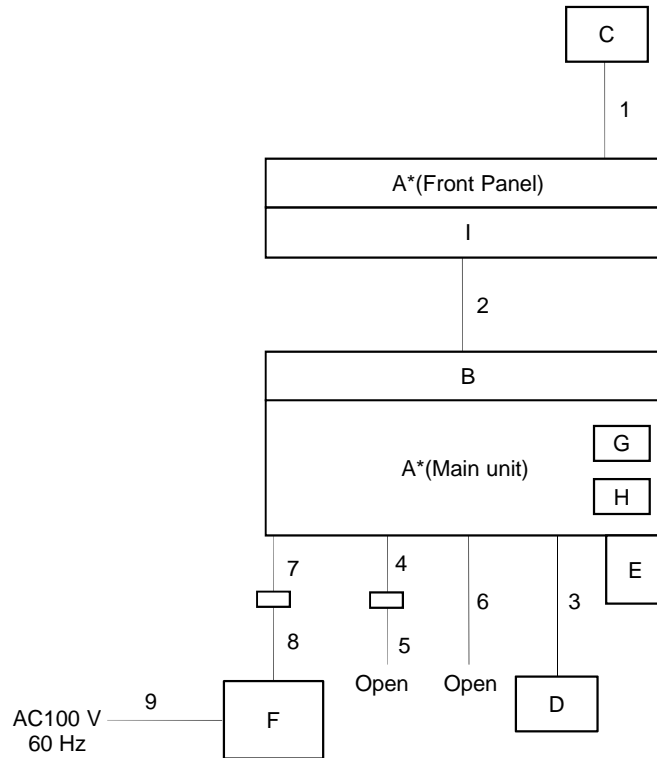

SECTION 8. OPERATING CONDITION

The EUT was operated under the following condition during the test.

8.1 Operating Condition

The test was carried out under Transmit mode.

(FCC:450.05MHz, 481.05MHz, 511.95MHz,
16K0F3E and 14K0F1D are 470.05MHz, 491.05MHz, 511.95MHz)

(RSS:450.05MHz, 460.05MHz, 469.95MHz)

(High Power : 45W, Low Power : 1 W)

The test was carried out under Receive mode.

(450.05MHz, 460.05MHz, 469.95MHz)

EUT was examined in the operating conditions that had maximum emissions.

8.2 Operating Flow [Transmit mode]

Following operations were performed continuously.

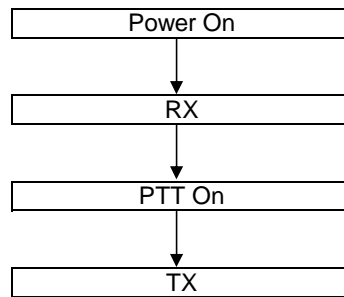

8.3 Operating Flow [Receive mode]

Following operations were performed continuously.

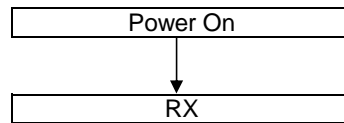

SECTION 9. MEASUREMENT UNCERTAINTY

Carrier Output Power (Conducted)	U _{lab}	Utia-603-d
	+/- 0.29dB (k = 2)	+/- 0.59 dB
Unwanted Emissions (Transmitter Conducted)		
	+/- 2.19 dB (k = 2)	+/- 1.1 dB
Field Strength of Spurious Radiation		
	+/- 2.78dB (k = 2)	+/- 3.3 dB
Emission Masks (Occupied Bandwidth)		
	+/- 0.5dB (k = 2)	+/- 2.1 dB
Transient Frequency Behavior		
	+/- 1.10% (k = 2)	+/- 21.6 %
Audio Low Pass Filter (Voice Input)		
	+/- 0.1dB (k = 2)	+/- 1.2 dB
Audio Frequency Response		
	+/- 0.1dB (k = 2)	+/- 1.2 dB
Modulation Limiting		
	+/- 1% (k = 2)	+/- 1.0 %
Frequency Stability (Temperature Variation)		
	+/- 10.1Hz (k=2)	+/-34.2 Hz
Frequency Stability (Voltage Variation)		
	+/- 10.1Hz (k=2)	+/-34.2 Hz
Receiver Spurious Emissions	U _{lab}	U _{cispr}
30-1000MHz	+/- 4.05dB (k = 2)	+/- 6.3 dB
abobe 1GHz	+/- 4.79dB (k = 2)	+/- 5.2 dB
Bandwidth		
	+/- 1.02% (k = 2)	-

SECTION 10. TEST DATA

10.1 Carrier Output Power (Conducted)

REGULATIONS	: FCC Part 2 Section 1046 (a) / RSS-119 Section 5.4
TEST METHOD/GUIDE	: ANSI/TIA-603-D Section 2.2.1.2 / RSS-119 Section 4.1

Test Procedure

- 1 The EUT and test equipment were set up as shown on the following page.
- 2 The EUT was conducted to a resistive coaxial attenuator of normal load impedance.
 $RF\ Power\ (dBm) = Power\ Meter\ reading\ (dBm) + Attenuator\ Loss\ (dB) + Cable\ Loss\ (dB)$
 $RF\ Power\ (W) = 10^{(RF\ Power\ (dBm)/10)}/1000$
- 3 Modulate the transmitter with a 2.5 kHz sine wave at an input Level of 16 dB greater than that necessary to produce 50 % of rated system deviation.(Only as for the test of RSS)

Measuring Equipments

No.	Equipment	Manufacture	Model No.	Serial No.	Cal. Interval	Effective period
1	Power Meter	Hewlett Packard	E4418B	GB38410265	1Y	May. 31, 17
2	Power Sensor	Hewlett Packard	8482A	US37292237	1Y	May. 31, 17
3	Attenuator (20dB)	Aeroflex/Wenshel	66-20-34	BY4357	1Y	May. 31, 17
4	Attenuator (30dB)	Weinschel	WA-29-30-34	8923	1Y	May. 31, 17
5	Modulation Analyzer	Hewlett Packard	8901B	3403A04852	1Y	Dec. 31, 17
6	Audio Generator	Anritsu	MG443B	M70150	1Y	May. 31, 17
7	DC Power Supply	Daiichi denpa kogyo	GZV4000	90290931	None	None
8	DC Power Supply 2	Kikusui	PMC35-3A	LE000716	None	None
9	Digital Multi Meter	FLUKE	8846A	9642018	1Y	Sep. 30, 17
10	JIG1	Anritsu	MD6420A	6200552647	None	None
11	JIG2	Kenwood	Modem	None	None	None

Measuring Cables

No.	Cable	Manufacturer	Model No.	Serial No.	Cal. Interval	Effective period
W2	Balance Cable	Nicoon	3D-2V	KSR00092	1Y	Mar. 31, 18
W3	Coaxial Cable	Pacific custom	RG-58 C/U	AM90C04	1Y	Feb. 28, 18

Measuring Equipment Configuration

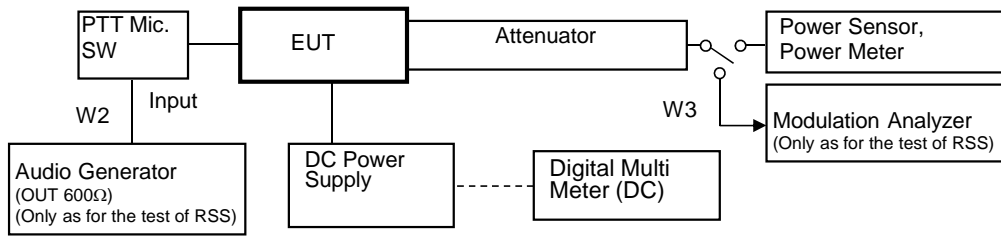

Note: Configuration of other Modulation test is composed without the Audio Generator.

<14K4F1D Modulation Case>

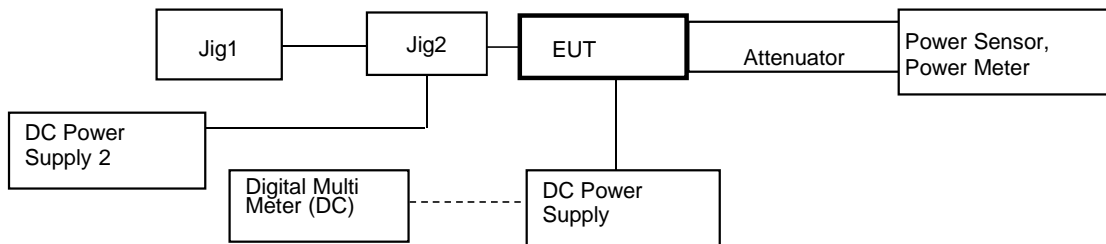

Test Results

Test date	Apr. 18, 2017		
Location	Kashima No.12 Test Site		
temperature	23.0	[degree C]	
Humidity Variation	50.0	[%]	
Atmospheric Pressure	98.9	[kPa]	
Test Engineer	Koichi Wagatsuma		

Test was carried out for all the Authorized Bandwidth.
 State the worst case (below).

No.	Frequency (MHz)	Band	Setting	RF Power (W)
1	450.05 (FCC/RSS)	Low	High Power	45
2	481.05 (FCC)	Middle	High Power	45
3	511.95 (FCC)	High	High Power	45
4	470.05 (FCC)	Low (For 16K0F3E, 14K4F1D)	High Power	45
5	491.05 (FCC)	Middle (For 16K0F3E, 14K4F1D)	High Power	45
6	460.05 (RSS)	Middle	High Power	45
7	469.95 (RSS)	High	High Power	45
8	450.05 (FCC/RSS)	Low	Low Power	1
9	481.05 (FCC)	Middle	Low Power	1
10	511.95 (FCC)	High	Low Power	1
11	470.05 (FCC)	Low (For 16K0F3E, 14K4F1D)	Low Power	1
12	491.05 (FCC)	Middle (For 16K0F3E, 14K4F1D)	Low Power	1
13	460.05 (RSS)	Middle	Low Power	1
14	469.95 (RSS)	High	Low Power	1

RF Power: Peak reading

10.2 Unwanted Emissions (Transmitter Conducted)

REGULATIONS	: FCC Part 2 Section 1051, Part 90 Section 210 / RSS-119 Section 5.8
TEST METHOD/GUIDE	: ANSI/TIA-603-D Section 2.2.13.2 / RSS-119 Section 4.2

Test Procedure

- 1 The EUT and test equipment were set up as shown on the following page.
- 2 Modulate the transmitter with a 2.5 kHz sine wave at an input Level of 16 dB greater than that than necessary to produce 50 % of rated system deviation.
- 3 Adjust the spectrum analyzer for the following setting:
 - a) RBW : 100 kHz (< 1 GHz), 1 MHz (> 1 GHz).
 - b) VBW : 300 kHz (< 1 GHz), 3 MHz (> 1 GHz).
 - c) Detector mode : Average power (FM Modulation) , Positive peak with peak hold (Digital Modulation)
- 4 The emissions were measured for the worst case as follows:
 - a) : within a band of frequencies defined by the carrier frequency plus and minus one channel.
 - b) : from the lowest frequency generated in the EUT and to at least the 10th harmonic of the carrier frequency, or 40 GHz, whichever is lower.

Measuring Equipments

No.	Equipment	Manufacture	Model No.	Serial No.	Cal. Interval	Effective period
1	Attenuator (20dB)	Aeroflex/Wenshel	66-20-34	BY4357	1Y	May. 31, 17
2	Attenuator (30dB)	Weinschel	WA-29-30-34	8923	1Y	May. 31, 17
3	Highpass Filter	Anritsu	MP526D	6200220657	1Y	Jan. 31, 18
4	Modulation Analyzer	Hewlett Packard	8901B	3403A04852	1Y	Dec. 31, 17
5	Signal Generator	Rohde&Schwarz	SMB 100A	105709	1Y	Apr. 30, 18
6	Audio Generator	Anritsu	MG443B	M70150	1Y	May. 31, 17
7	Spectrum Analyzer	Agilent	N9030A	US51350220	1Y	Feb. 28, 18
8	DC Power Supply	Daiichi denpa kogyo	GZV4000	90290931	None	None
9	DC Power Supply 2	Kikusui	PMC35-3A	LE000716	None	None
10	Digital Multi Meter	FLUKE	8846A	9642018	1Y	Sep. 30, 17
11	JIG1	Anritsu	MD6420A	6200552647	None	None
12	JIG2	Kenwood	Modem	None	None	None

Measuring Cables

No.	Cable	Manufacture	Model No.	Serial No.	Cal. Interval	Effective period
W3	Balance Cable	Nicoon	3D-2V	KSR00092	1Y	Mar. 31, 18
W4	Coaxial Cable	Pacific custom	RG-58 C/U	AM90C04	1Y	Feb. 28, 18
W2	Coaxial Cable	Suhner	SUCOFLEX104	KSR00217	1Y	May. 31, 17

Measuring Equipment Configuration

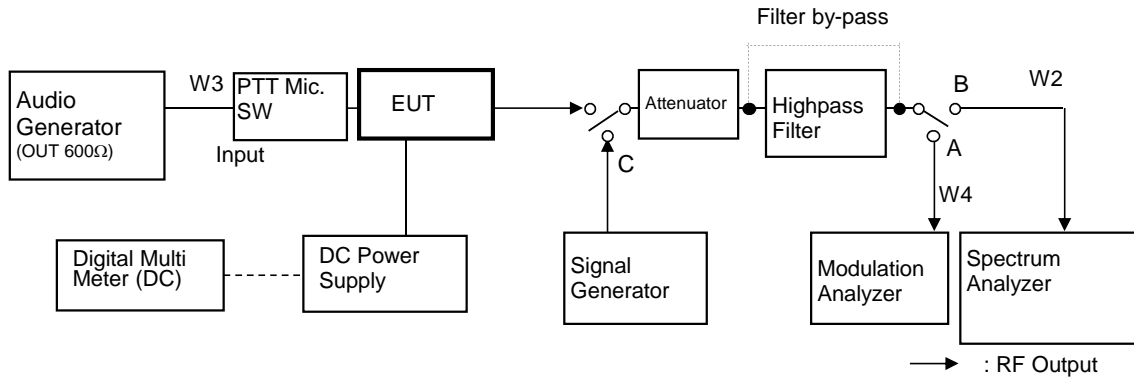

Note: Configuration of other Modulation test is composed without the Audio Generator.

<14K4F1D Modulation Case>

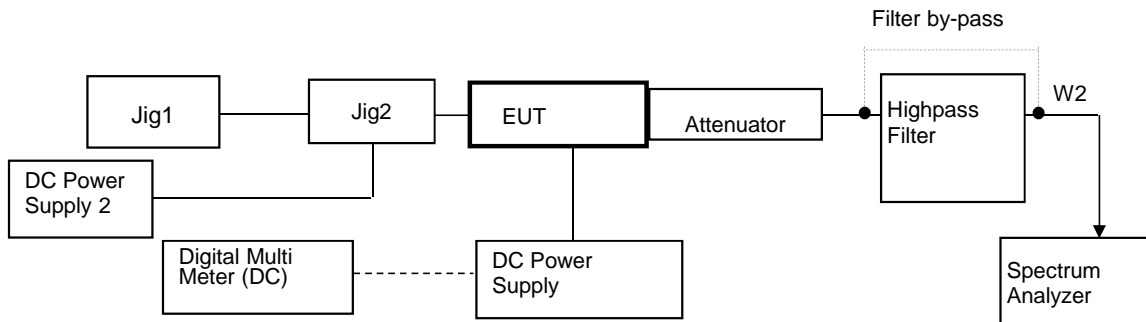

Test Results

Test date	May. 26, 2017
Location	Kashima No.12 Test Site
temperature	25 [degree C]
Humidity Variation	61 [%]
Atmospheric Pressure	99.9 [kPa]
Test Engineer	Koichi Wagatsuma

Test was carried out for all the frequency band of section 10.1
 State the worst case (below).

State : High Power / Authorized Bandwidth 11.25 kHz

No.	Tuned Frequency (MHz)	Band	Spurious Frequency (MHz)	Correct Level (dBm)	Emission Level (dBc)	Mask D Limit (dBc)	Margin (dB)
1	450.05 (FCC/RSS)	Low	900.10	-36.76	-83.29	-66.5	16.8
2	481.05 (FCC)	Middle	962.10	-37.32	-83.85	-66.5	17.4
3	511.95 (FCC)	High	No Point detected	-	-	-66.5	-
4	460.05 (RSS)	Middle	920.10	-37.35	-83.88	-66.5	17.4
5	469.95 (RSS)	High	939.90	-38.00	-84.53	-66.5	18.0

There is the margin of 20dB over except for the above points.

Mask D Limit (dBc) = $-(50+10\log(P))$
 Correct Level (dBm) = Substitute SG Level (dBm)
 Emission Level (dBc) = Correct Level (dBm) - $10\log(P*1000)$
 P = Carrier Level (W)
 " - " = Measurement Limit

State : Low Power / Authorized Bandwidth 6 kHz

No.	Tuned Frequency (MHz)	Band	Spurious Frequency (MHz)	Correct Level (dBm)	Emission Level (dBc)	Mask E Limit (dBc)	Margin (dB)
1	450.05 (FCC/RSS)	Low	No Point detected	-	-	-55.0	-
2	481.05 (FCC)	Middle	No Point detected	-	-	-55.0	-
3	511.95 (FCC)	High	No Point detected	-	-	-55.0	-
4	460.05 (RSS)	Middle	No Point detected	-	-	-55.0	-
5	469.95 (RSS)	High	No Point detected	-	-	-55.0	-

There is the margin of 20dB over except for the above points.

Mask E Limit (dBc) = whichever is the lesser attenuation ; $-(55+10\log(P))$ or -65
 Correct Level (dBm) = Substitute SG Level (dBm)
 Emission Level (dBc) = Correct Level (dBm) - $10\log(P*1000)$
 P = Carrier Level (W)
 " - " = Measurement Limit

10.3 Field Strength of Spurious Radiation

REGULATIONS	: FCC Part 2 Section 1053 (a), Part 90 Section 210 / RSS-119 Section 5.8
TEST METHOD/GUIDE	: ANSI/TIA-603-D Section 2.2.12.2 / RSS-119 Section 4.2

Test Procedure

- 1 The EUT and test equipment were set up as shown on the following page.
- 2 Adjust the spectrum analyzer for the following setting:
 - a) RBW : 100 kHz (< 1 GHz), 1 MHz (> 1 GHz).
 - b) VBW : 300 kHz (< 1 GHz), 3 MHz (> 1 GHz).
 - c) Detector mode : Positive Peak
- 3 The transmitter was placed on a wooden turntable, and it was transmitting into non-radiating load which was also placed on the turntable.
- 4 The measurement antenna was placed at a distance of 3 meters from the EUT. During the tests, the antenna height and polarization as well as EUT azimuth were varied in order to identify the maximum level of emissions from the EUT. The test was performed by placing the EUT on 3-orthogonal axis.
- 5 The frequency range up to tenth harmonic of the fundamental frequency was investigated.
- 6 Remove the EUT and replace it with substitution antenna. A signal generator was connected to the substitution antenna by a non-radiating cable. The absolute levels of the spurious emissions were measured by the substitution.
- 7 Spurious emissions in dB = 10 Log (TX power in Watts/0.001) – the absolute level

Measuring Equipments

No.	Equipment	Manufacture	Model No.	Serial No.	Cal. Interval	Effective period
1	Attenuator(10dB)	HUBER+SUHNER	6810.17B	5061	1Y	Feb. 28, 18
2	Dummy Load	TME	CT-150NP	1138693	1Y	Feb. 28, 18
3	Signal Generator	Rohde&Schwarz	SMB 100A	105709	1Y	Apr. 30, 18
4	Spectrum Analyzer	Agilent	N9000A	MY51260520	1Y	May. 31, 17
5	D.R.G Antenna(RX)	Schwarzbeck	3115	5045	1Y	Mar. 31, 18
6	D.R.G Antenna(TX)	ETS LINDGREN	3117	00055157	1Y	May. 31, 17
7	Dipole Antenna(TX)	Schwarzbeck	UHA9105	AM0082002	1Y	Aug. 31, 17
8	Dipole Antenna(TX)	Schwarzbeck	VHA9103	C01082007	1Y	Aug. 31, 17
9	Tri-log Antenna(RX)	Schwarzbeck	VULB9168WP	126	1Y	Dec. 31, 17
10	DC Power Supply	Daiichi denpa kogyo	GZV4000	90290931	None	None
11	Digital Multi Meter	FLUKE	8846A	9642018	1Y	Sep. 30, 17
12	Amplifier	TOYO	TPA0118-30	0402	1Y	Apr. 30, 18
13	Attenuator	HUBER + SUHNER	6803.17.B	5111	1Y	Apr. 30, 18
14	Amplifier	Intertek Japan	ZX60-3018G	005	1Y	Feb. 28, 18
15	Attenuator	TAMAGAWA	CFA-01	A00040805	1Y	Feb. 28, 18
16	RF Switch	Intertek Japan	ACX-150-1	A12301501	1Y	Feb. 28, 18

Measuring Cables

No.	Cable	Manufacturer	Model No.	Serial No.	Cal. Interval	Effective period
R11	Coaxial Cable	FUJIKURA	5D-2W	R11	1Y	Feb. 28, 18
R1	Coaxial Cable	FUJIKURA	5D-2W	R1	1Y	Feb. 28, 18
R3	Coaxial Cable	FUJIKURA	10D-2W	R3	1Y	Feb. 28, 18
R5	Coaxial Cable	FUJIKURA	RG-5A/U	R5	1Y	Feb. 28, 18
R7	Coaxial Cable	MIYAZAKI	5D-2W	R7	1Y	Feb. 28, 18
R10	Coaxial Cable	FUJIKURA	5D-2W	R10	1Y	Feb. 28, 18
R13	Coaxial Cable	SUHNER	SUCOFLEX 104	229603	1Y	Apr. 30, 18
R12	Coaxial Cable	Candox	5B-048-98-98-5000	111130	1Y	Apr. 30, 18
W13	Coaxial Cable	Suhner	SUCOFLEX106	KSR00207	1Y	Feb. 28, 18

Measuring Equipment Configuration

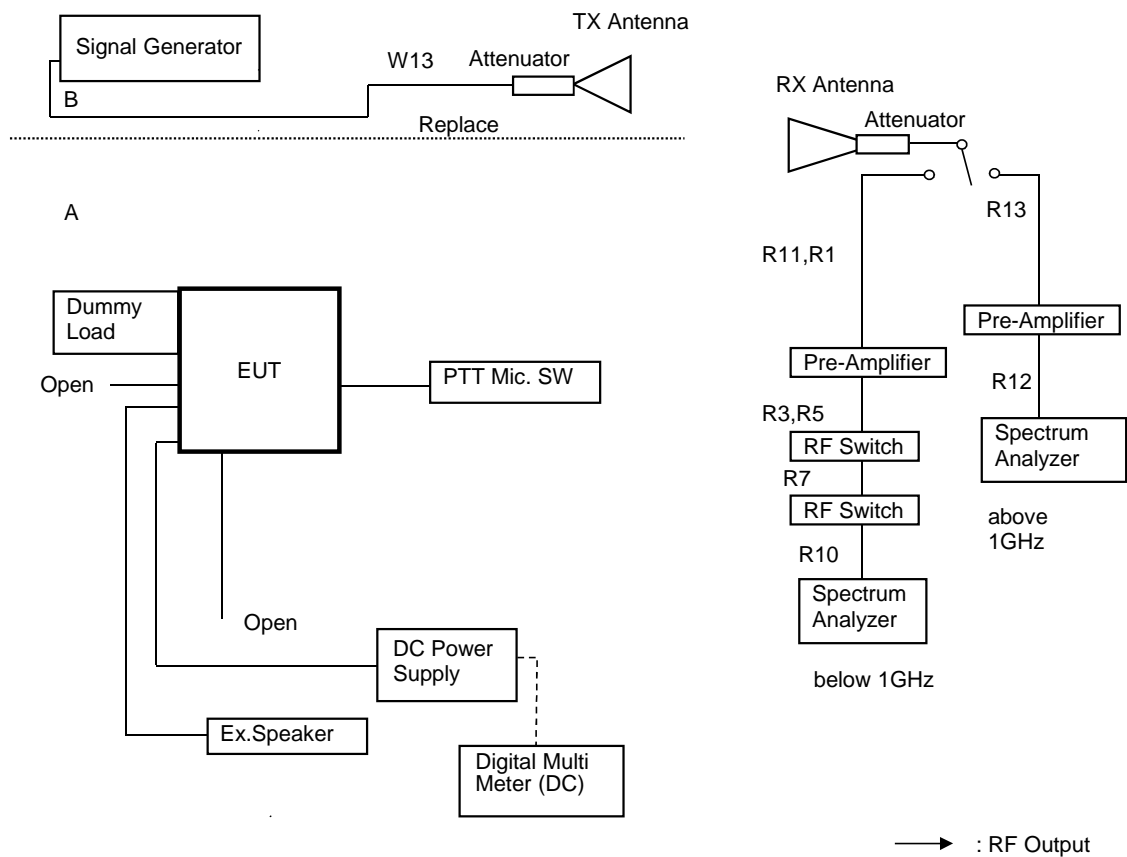

Test Results

Test date	Apr 29, 2017 to May 01, 2017
Location	Kashima No.12 Test Site
temperature	20.0 to 21.5 [degree C]
Humidity Variation	30 to 40 [%]
Atmospheric Pressure	101 to 102 [kPa]
Test Engineer	Koichi Wagatsuma

Test was carried out for all the frequency band of section 10.1
State the worst case (below).

State : High Power / Authorized Bandwidth 11.25 kHz / 450.05MHz(FCC /RSS)

No	Frequency (MHz)	Pol	Reading Level (dBm)	SG Out Level (dBm)	Antenna Gain (dBd)	Loss (dB)	Correct Level (dBm)	Emission Level (dBc)	MASK D Limit Level (dBc)	Margin (dB)
1	900.10	Hor.	-55.49	-20.79	0.00	12.42	-33.2	-79.7	-66.5	13.2
		Ver.	-54.51	-18.54	0.00	12.42	-31.0	-77.5	-66.5	11.0
2	1350.15	Hor.	-52.02	-38.28	3.03	12.97	-48.2	-94.7	-66.5	28.2
		Ver.	-48.46	-33.97	3.03	12.97	-43.9	-90.4	-66.5	23.9
3	1800.20	Hor.	-61.63	-45.88	3.40	13.48	-56.0	-102.5	-66.5	36.0
		Ver.	-57.87	-40.84	3.40	13.48	-50.9	-97.5	-66.5	31.0
4	2250.25	Hor.	-60.14	-43.96	3.34	13.93	-54.5	-101.1	-66.5	34.6
		Ver.	-59.35	-41.57	3.34	13.93	-52.1	-98.7	-66.5	32.2
5	2700.30	Hor.	-60.50	-42.97	4.05	14.32	-53.2	-99.8	-66.5	33.3
		Ver.	-61.21	-42.46	4.05	14.32	-52.7	-99.3	-66.5	32.8
6	3150.35	Hor.	-60.23	-41.07	5.11	14.70	-50.7	-97.2	-66.5	30.7
		Ver.	-57.73	-37.47	5.11	14.70	-47.1	-93.6	-66.5	27.1
7	3600.40	Hor.	-60.69	-40.05	6.00	15.03	-49.1	-95.6	-66.5	29.1
		Ver.	-60.70	-39.63	6.00	15.03	-48.7	-95.2	-66.5	28.7
8	4050.45	Hor.	-55.68	-33.91	6.43	15.35	-42.8	-89.4	-66.5	22.9
		Ver.	-53.98	-32.35	6.43	15.35	-41.3	-87.8	-66.5	21.3
9	4500.50	Hor.	-61.33	-38.11	7.02	15.60	-46.7	-93.2	-66.5	26.7
		Ver.	-59.85	-37.14	7.02	15.60	-45.7	-92.3	-66.5	25.8

There is the margin of 20dB over except for the above points.

Mask D Limit (dBc) = whichever is the lesser attenuation ; $-(50+10\log(P))$ or -70

Correct Level (dBm) = Substitute SG Level (dBm) + ANT Gain (dBd) - Loss (Cable, Attenuator) (dB)

Emission Level (dBc) = Correct Level (dBm) - $10\log(P*1000)$

P = Carrier Level (W)

" - " = Measurement Limit

State : Low Power / Authorized Bandwidth 6 kHz / 450.05MHz(FCC /RSS)

No	Frequency (MHz)	Pol	Reading Level (dBm)	SG Out Level (dBm)	Antenna Gain (dBd)	Loss (dB)	Correct Level (dBm)	Emission Level (dBc)	MASK E Limit Level (dBc)	Margin (dB)
1	900.10	Hor.	-56.99	-22.29	0.00	12.42	-34.7	-64.7	-55.0	9.7
		Ver.	-54.65	-18.67	0.00	12.42	-31.1	-61.1	-55.0	6.1
2	1350.15	Hor.	-52.37	-38.62	3.03	12.97	-48.6	-78.6	-55.0	23.6
		Ver.	-51.52	-37.02	3.03	12.97	-47.0	-77.0	-55.0	22.0
3	1800.20	Hor.	-62.65	-46.90	3.40	13.48	-57.0	-87.0	-55.0	32.0
		Ver.	-60.93	-43.90	3.40	13.48	-54.0	-84.0	-55.0	29.0
4	2250.25	Hor.	-59.65	-43.47	3.34	13.93	-54.1	-84.1	-55.0	29.1
		Ver.	-58.99	-41.21	3.34	13.93	-51.8	-81.8	-55.0	26.8
5	2700.30	Hor.	-59.42	-41.89	4.05	14.32	-52.2	-82.2	-55.0	27.2
		Ver.	-61.32	-42.58	4.05	14.32	-52.9	-82.9	-55.0	27.9
6	3150.35	Hor.	-	-	5.11	14.70	-	-	-55.0	-
		Ver.	-59.72	-39.46	5.11	14.70	-49.1	-79.1	-55.0	24.1
7	3600.40	Hor.	-	-	6.00	15.03	-	-	-55.0	-
		Ver.	-	-	6.00	15.03	-	-	-55.0	-
8	4050.45	Hor.	-	-	6.43	15.35	-	-	-55.0	-
		Ver.	-	-	6.43	15.35	-	-	-55.0	-
9	4500.50	Hor.	-	-	7.02	15.60	-	-	-55.0	-
		Ver.	-	-	7.02	15.60	-	-	-55.0	-

There is the margin of 20dB over except for the above points.

Mask E Limit (dBc) = whichever is the lesser attenuation ; $-(55+10\log(P))$ or -65

Correct Level (dBm) = Substitute SG Level (dBm) + ANT Gain (dBd) - Loss (Cable, Attenuator) (dB)

Emission Level (dBc) = Correct Level (dBm) - $10\log(P*1000)$

P = Carrier Level (W)

" - " = Measurement Limit

10.4 Emission Masks (Occupied Bandwidth)

REGULATIONS	: FCC Part 2 Section 1049 (c) (1), Part 90 Section 210 RSS-119 Section 5.5
TEST METHOD/GUIDE	: ANSI/TIA-603-D Section 2.2.11.2 / RSS-119 Section 5.8

Test Procedure

- 1 The EUT and test equipment were set up as shown on the following page.
- 2 For EUT supporting audio modulation, the audio signal generator was adjusted to the frequency of maximum response and with output level set for +/- 2.5 kHz deviation (or 50 % modulation). (FM modulation).
- 3 With level constant, the signal level was increased 16 dB.
- 4 For EUT supporting digital modulation, the digital modulation mode was operated to its maximum extent.
- 5 Adjust the spectrum analyzer for the following setting:
 - a) RBW : 100Hz (Non modulation and Authorized Band 6 kHz),
100Hz (Non modulation and Authorized Band 11.25 kHz),
300Hz (Non modulation and Authorized Band 20 kHz).
 - b) VBW : 10times the RBW (Non modulation , Authorized Band 6kHz, 11.25 kHz and 20 kHz).
 - c) RBW and VBW : 30 kHz (Non modulation(Digital Modulation)).
- 6 The occupied Bandwidth was measured with the Spectrum Analyzer controls set as shown on the test results.

The selection of Emission Mask

No.	Frequency	Audio Filter	Channel Bandwidth (kHz)	Authorized Bandwidth (kHz)	Selection of Emission Mask	
	(MHz)				FCC	IC
Emission Designation :		16K0F3E				
1	450.05 (RSS)	With	25	20	-	B
2	460.05 (RSS)	With	25	20	-	B
3	469.95 (RSS)	With	25	20	-	B
4	470.05 (FCC)	With	25	20	B	-
5	491.05 (FCC)	With	25	20	B	-
6	511.95 (FCC)	With	25	20	B	-
Emission Designation :		14K4F1D				
1	450.05 (RSS)	Without	25	20	-	C
2	460.05 (RSS)	Without	25	20	-	C
3	469.95 (RSS)	Without	25	20	-	C
4	470.05 (FCC)	Without	25	20	C	-
5	491.05 (FCC)	Without	25	20	C	-
6	511.95 (FCC)	Without	25	20	C	-
Emission Designation :		11K0F3E				
1	450.05 (FCC/RSS)	With	12.5	11.25	D	D
2	460.05 (RSS)	With	12.5	11.25	-	D
3	469.95 (RSS)	With	12.5	11.25	-	D
4	481.05 (FCC)	With	12.5	11.25	D	-
5	511.95 (FCC)	With	12.5	11.25	D	-
Emission Designation :		8K30F1E/F1D/F7W				
1	450.05 (FCC/RSS)	Without	12.5	11.25	D	D
2	460.05 (RSS)	Without	12.5	11.25	-	D
3	469.95 (RSS)	Without	12.5	11.25	-	D
4	481.05 (FCC)	Without	12.5	11.25	D	-
5	511.95 (FCC)	Without	12.5	11.25	D	-
Emission Designation :		8K10F1E / F1D				
1	450.05 (FCC/RSS)	Without	12.5	11.25	D	D
2	460.05 (RSS)	Without	12.5	11.25	-	D
3	469.95 (RSS)	Without	12.5	11.25	-	D
4	481.05 (FCC)	Without	12.5	11.25	D	-
5	511.95 (FCC)	Without	12.5	11.25	D	-
Emission Designation :		4K00F1E / F1D / F7W				
1	450.05 (FCC/RSS)	Without	6.25	6	E	E
2	460.05 (RSS)	Without	6.25	6	-	E
3	469.95 (RSS)	Without	6.25	6	-	E
4	481.05 (FCC)	Without	6.25	6	E	-
5	511.95 (FCC)	Without	6.25	6	E	-
Emission Designation :		4K00F2D				
1	450.05 (FCC/RSS)	Without	6.25	6	E	E
2	460.05 (RSS)	Without	6.25	6	-	E
3	469.95 (RSS)	Without	6.25	6	-	E
4	481.05 (FCC)	Without	6.25	6	E	-
5	511.95 (FCC)	Without	6.25	6	E	-

Measuring Equipments

No.	Equipment	Manufacture	Model No.	Serial No.	Cal. Interval	Effective period
1	Attenuator (20dB)	Aeroflex/Wenshel	66-20-34	BY4357	1Y	May. 31, 17
2	Attenuator (30dB)	Weinschel	WA-29-30-34	8923	1Y	May. 31, 17
3	Modulation Analyzer	Hewlett Packard	8901B	3403A04852	1Y	Dec. 31, 17
4	Audio Generator	Anritsu	MG443B	M70150	1Y	May. 31, 17
5	Spectrum Analyzer	Agilent	N9030A	US51350220	1Y	Feb. 28, 18
6	DC Power Supply	Daiichi denpa kogyo	GZV4000	90290931	None	None
7	DC Power Supply 2	Kikusui	PMC35-3A	LE000716	None	None
8	Digital Multi Meter	FLUKE	8846A	9642018	1Y	Sep. 30, 17
9	JIG1	Anritsu	MD6420A	6200552647	None	None
10	JIG2	Kenwood	Modem	None	None	None

Measuring Cables

No.	Cable	Manufacture	Model No.	Serial No.	Cal. Interval	Effective period
W3	Balance Cable	Nicoon	3D-2V	KSR00092	1Y	Mar. 31, 18
W4	Coaxial Cable	Pacific custom	RG-58 C/U	AM90C04	1Y	Feb. 28, 18
W2	Coaxial Cable	Suhner	SUCOFLEX104	KSR00217	1Y	May. 31, 17

Measuring Equipment Configuration

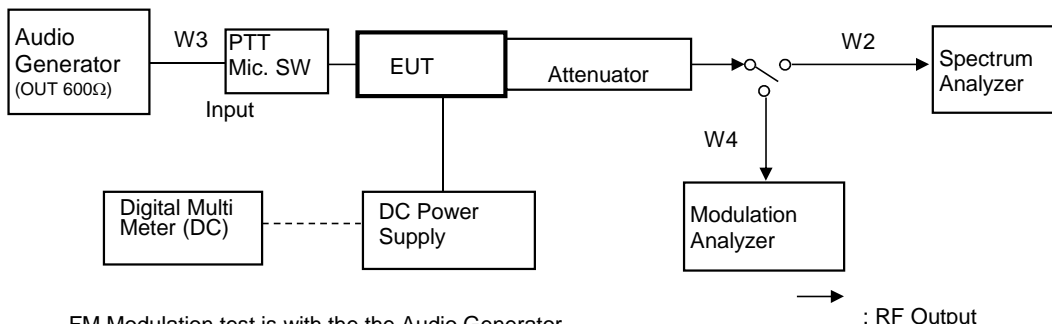

FM Modulation test is with the the Audio Generator. : RF Output
 Configuration of other Modulation test is composed without the Audio Generator.

<14K4F1D Modulation Case>

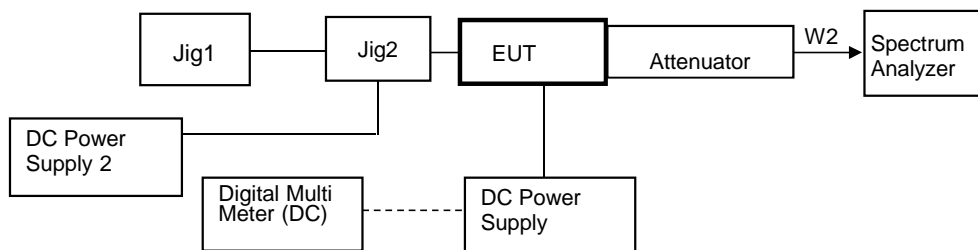

Test Results

Test date	May. 08, 2017 and May. 26, 2017
Location	Kashima No.12 Test Site
temperature	21.1 to 23.4 [degree C]
Humidity Variation	60 to 60 [%]
Atmospheric Pressure	100.2 to 100.4 [kPa]
Test Engineer	Koichi Wagatsuma

Test was carried out for all the frequency band of section 10.1
 State the worst case (below).

State : High Power / Authorized Bandwidth 20 kHz/ 16K0F3E / 491.05 MHz(FCC)
 Limit : Mask B

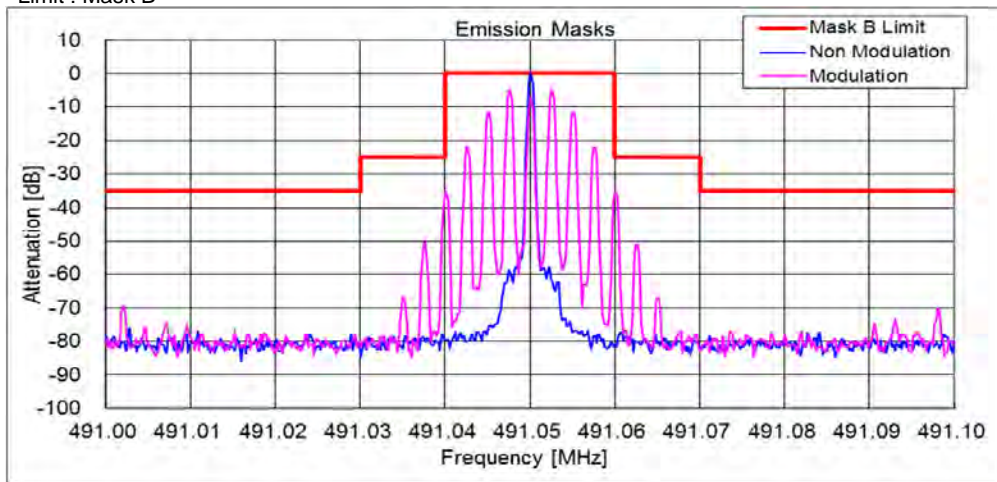

State : High Power / Authorized Bandwidth 20 kHz/ 16K0F3E / 469.95 MHz(RSS)
 Limit : Mask B

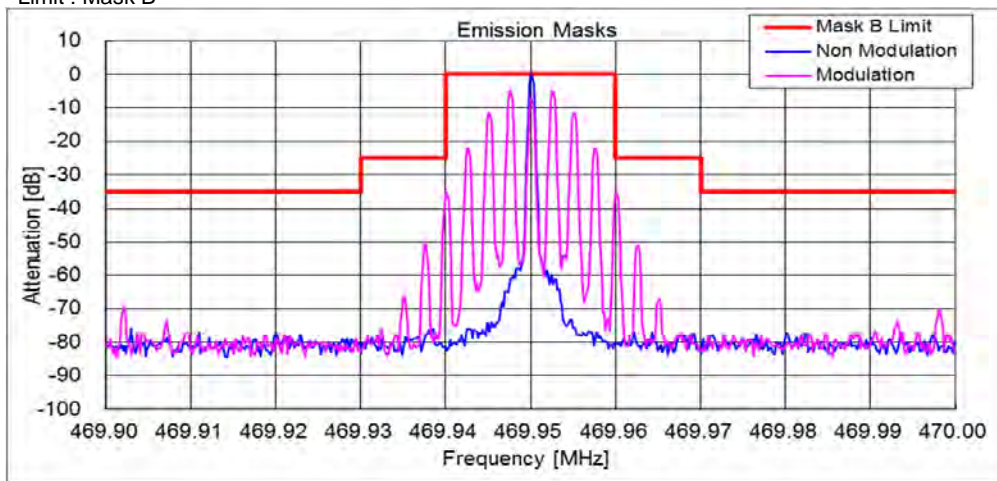

State : High Power / Authorized Bandwidth 20 kHz/ 14K4F1D / 491.05 MHz(FCC)
Limit : Mask C

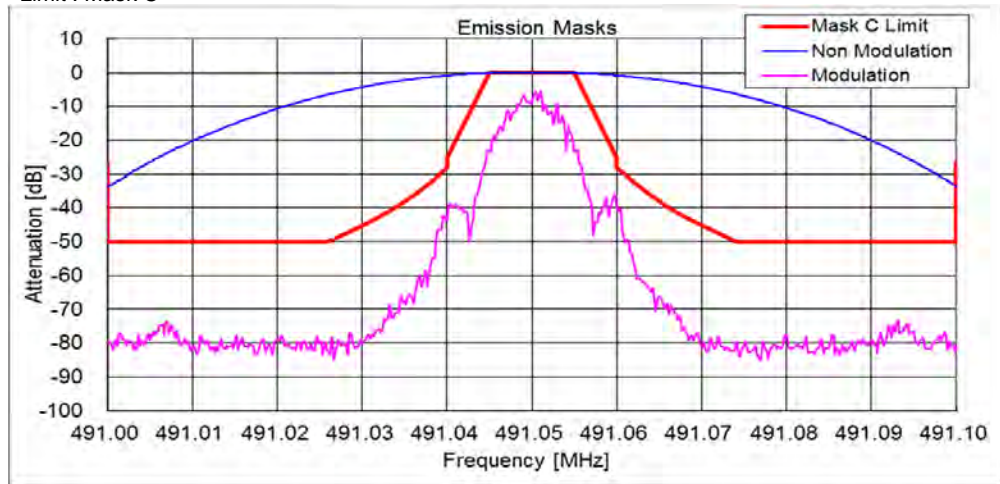

State : High Power / Authorized Bandwidth 20 kHz/ 14K4F1D / 469.95 MHz(RSS)
Limit : Mask C

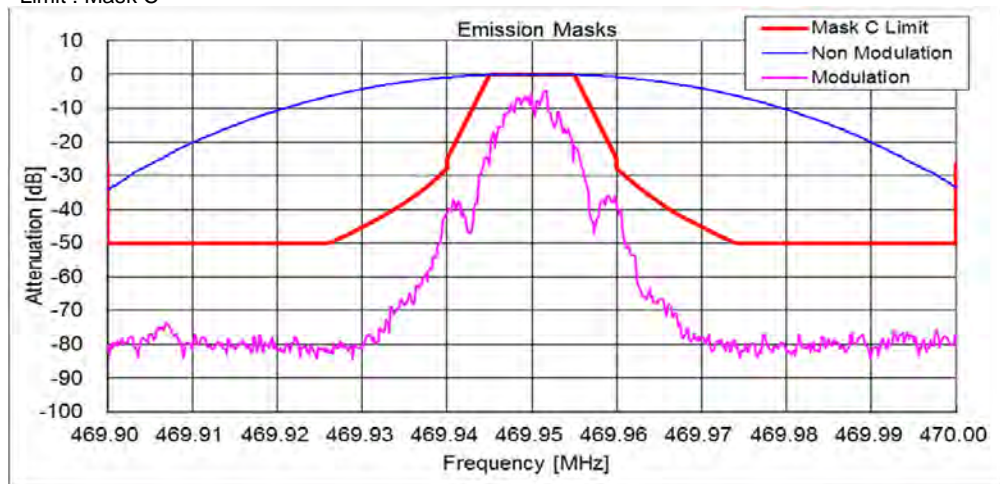

State : High Power / Authorized Bandwidth 11.25 kHz/ 11K0F3E / 481.05 MHz(FCC)
Limit : Mask D

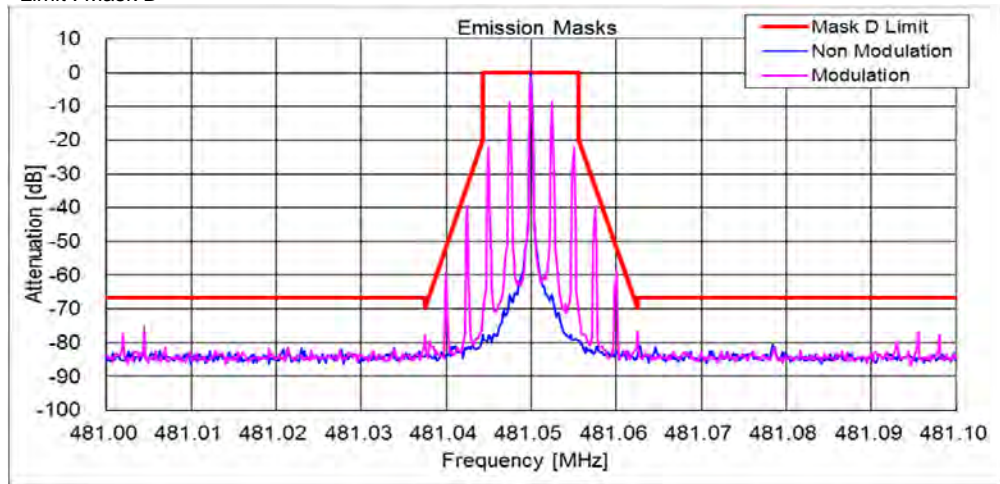

State : High Power / Authorized Bandwidth 11.25 kHz/ 11K0F3E / 460.05 MHz(RSS)
Limit : Mask D

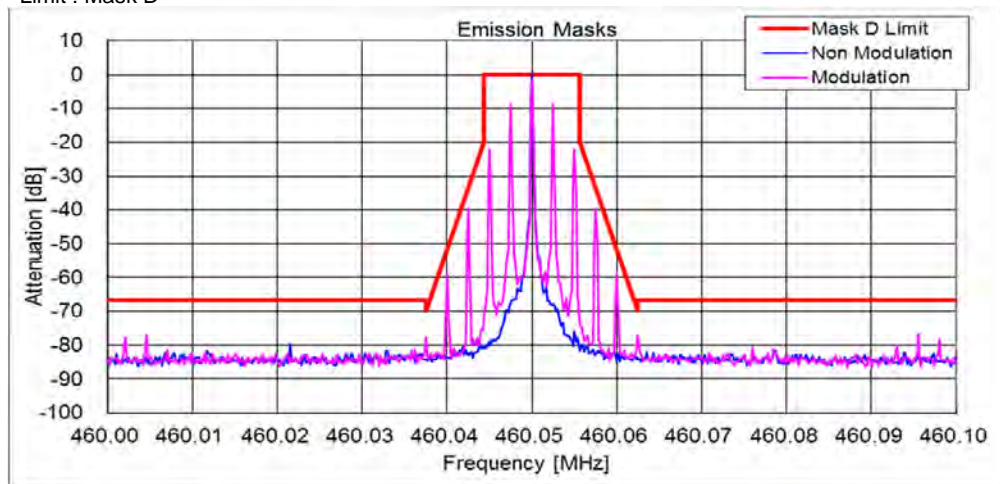

State : High Power / Authorized Bandwidth 11.25 kHz/ 8K30F1E/F1D/F7W / 511.95 MHz(FCC)
Limit : Mask D

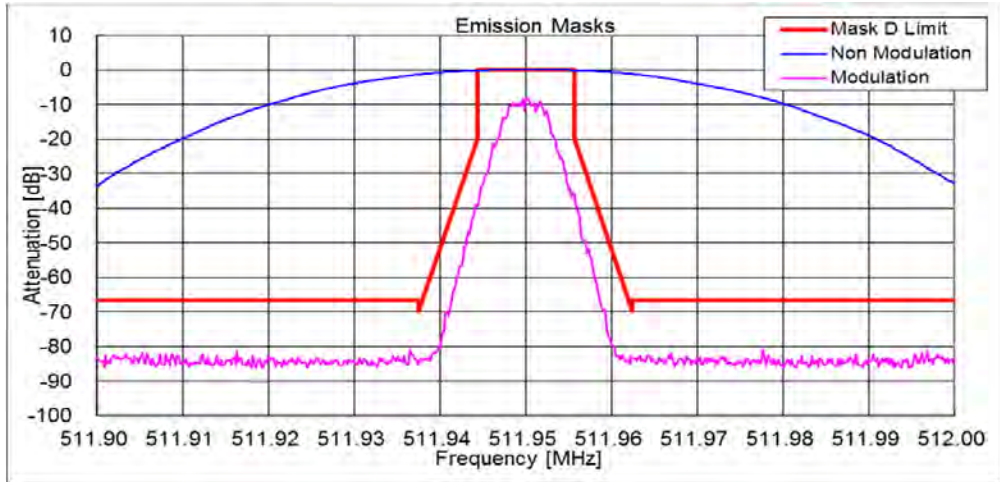

State : High Power / Authorized Bandwidth 11.25 kHz/ 8K30F1E/F1D/F7W / 469.95 MHz(RSS)
Limit : Mask D

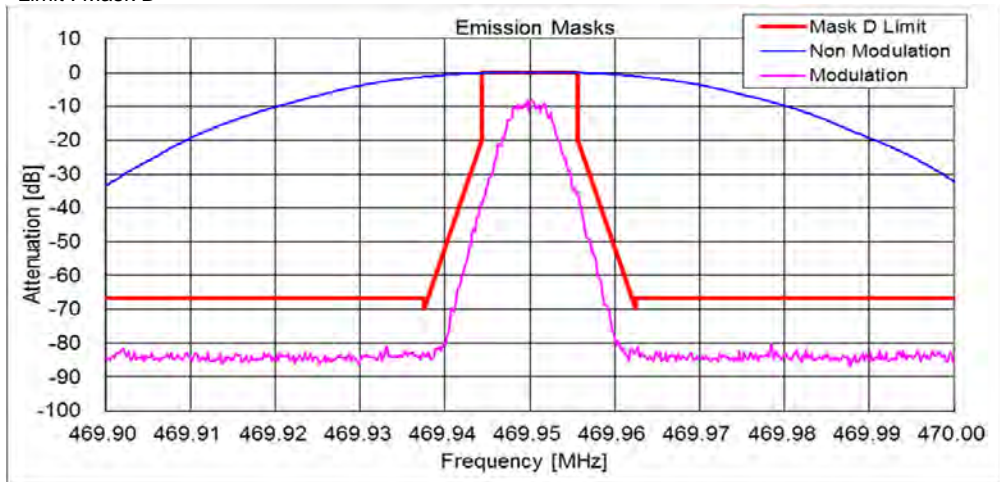

State : High Power / Authorized Bandwidth 11.25 kHz/ 8K10F1E / F1D / 450.05 MHz(FCC/RSS)
Limit : Mask D

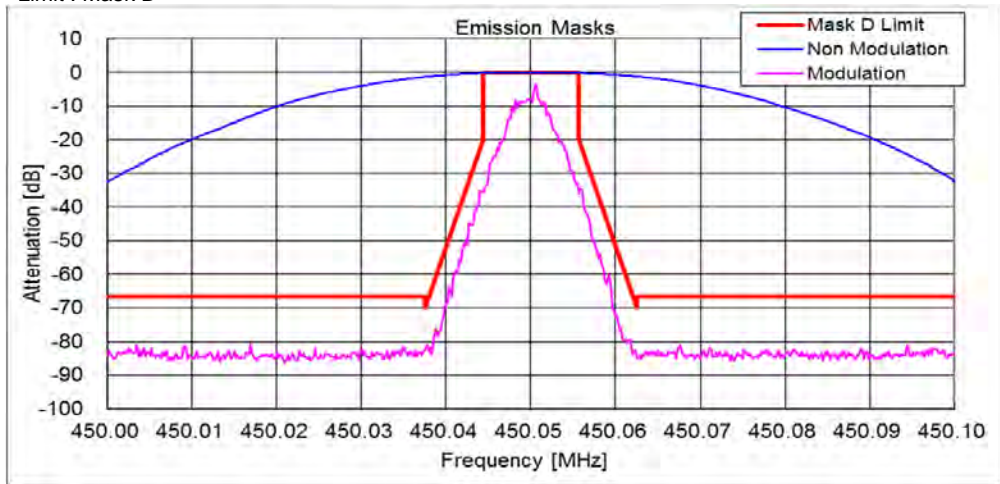

State : High Power / Authorized Bandwidth 6 kHz/ 4K00F1E / F1D / F7W / 481.05 MHz(FCC)
Limit : Mask E

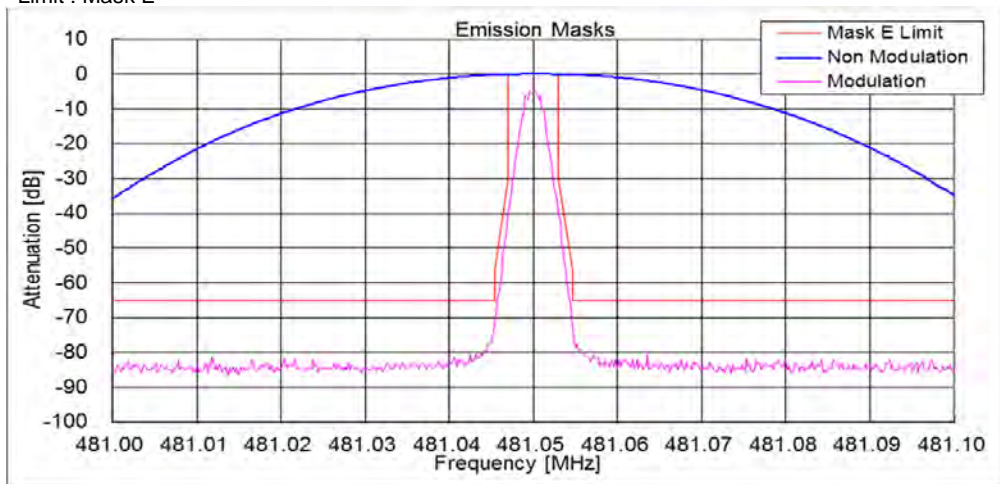

State : High Power / Authorized Bandwidth 6 kHz/ 4K00F1E / F1D / F7W / 450.05 MHz(RSS)
Limit : Mask E

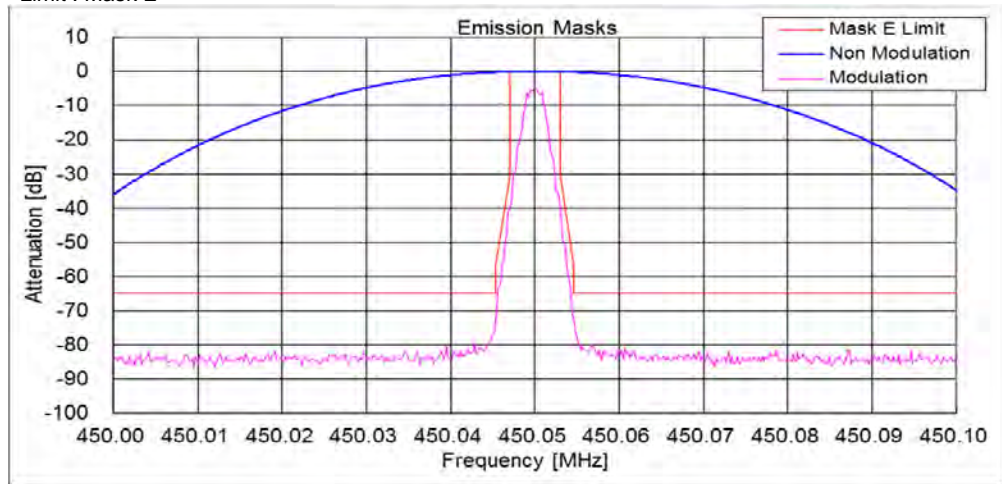

State : High Power / Authorized Bandwidth 6 kHz/ 4K00F2D / 511.95 MHz(FCC)
Limit : Mask E

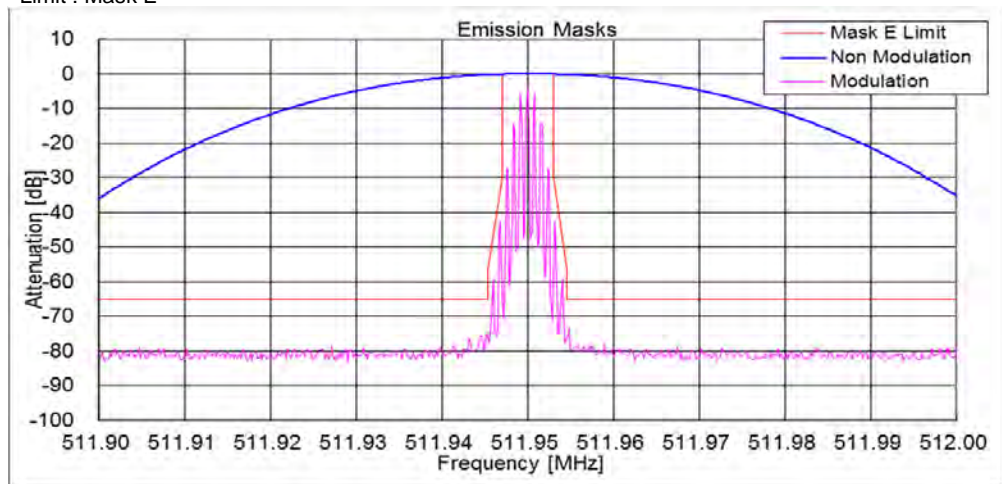

State : High Power / Authorized Bandwidth 6 kHz/ 4K00F2D / 460.05 MHz(RSS)
Limit : Mask E

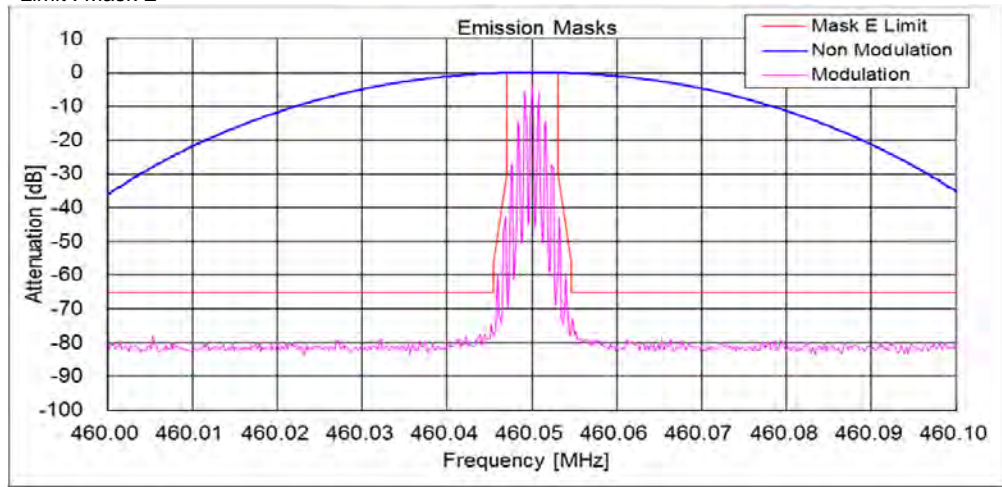

State : Low Power / Authorized Bandwidth 20 kHz/ 16K0F3E / 491.05 MHz(FCC)
Limit : Mask B

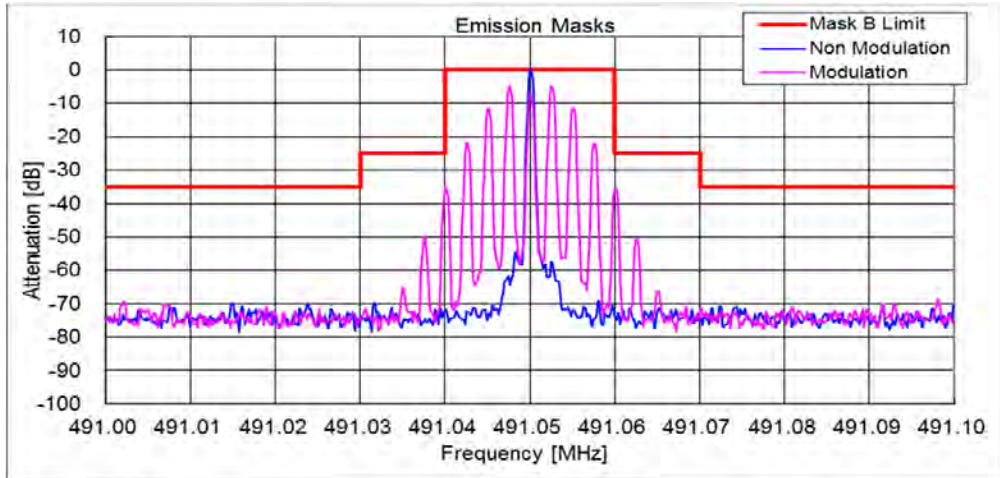

State : Low Power / Authorized Bandwidth 20 kHz/ 16K0F3E / 469.95 MHz(RSS)
Limit : Mask B

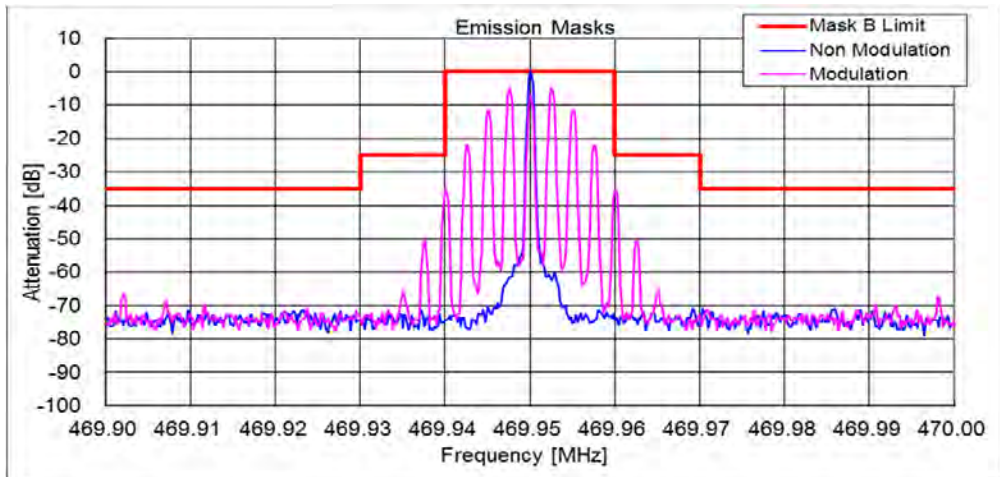

State : Low Power / Authorized Bandwidth 11.25 kHz/ 14K4F1D / 511.95 MHz(FCC)
Limit : Mask C

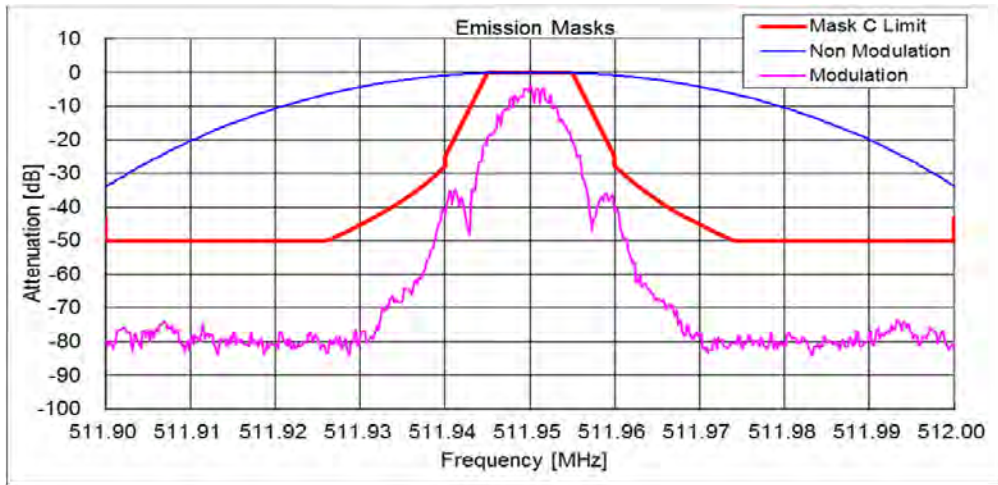

State : Low Power / Authorized Bandwidth 11.25 kHz/ 14K4F1D / 460.05 MHz(RSS)
Limit : Mask C

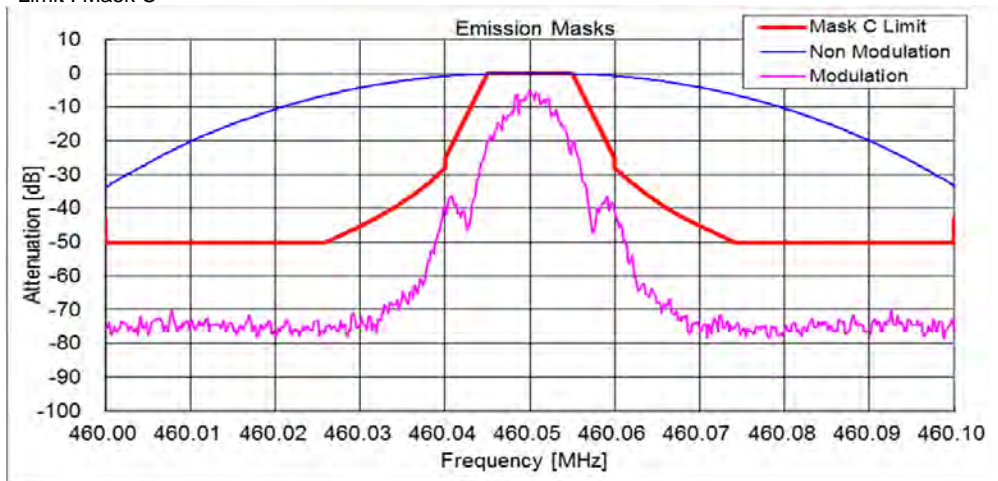

State : Low Power / Authorized Bandwidth 11.25 kHz/ 11K0F3E / 511.95 MHz(FCC)
Limit : Mask D

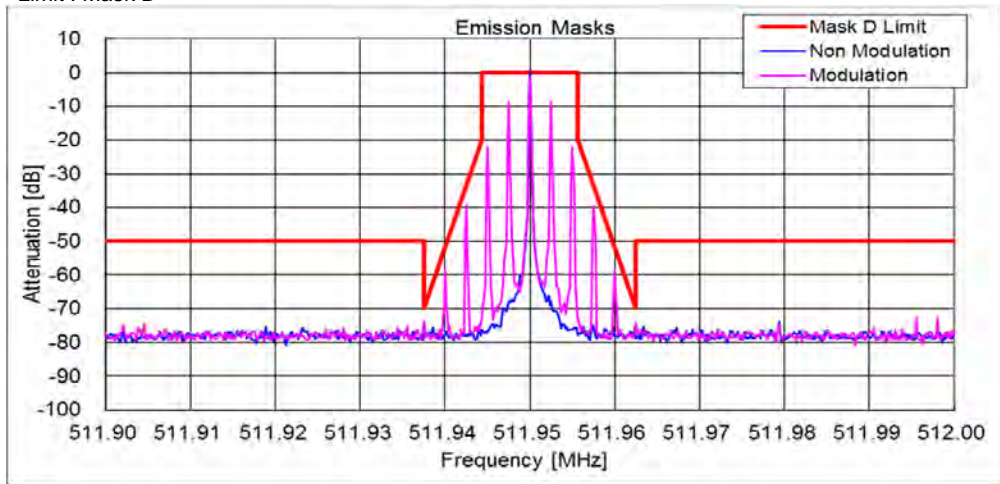

State : Low Power / Authorized Bandwidth 11.25 kHz/ 11K0F3E / 460.05 MHz(RSS)
Limit : Mask D

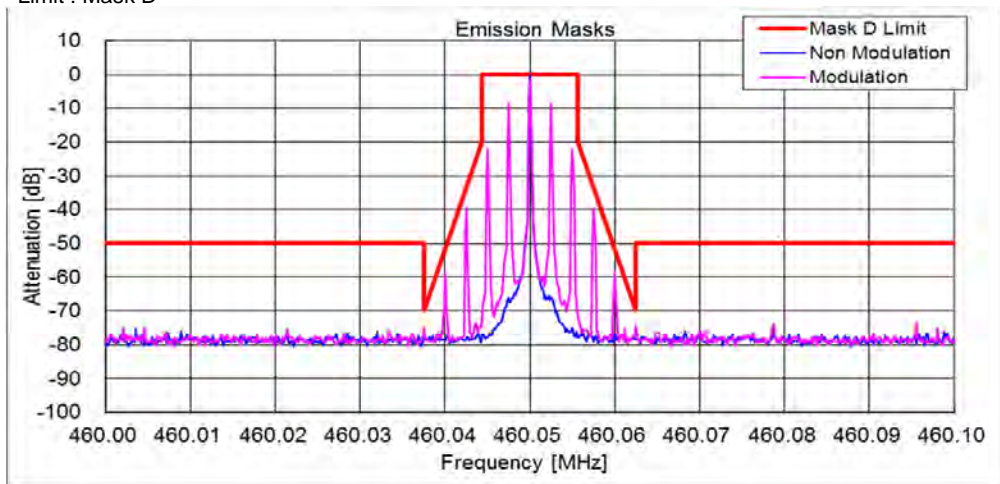

State : Low Power / Authorized Bandwidth 11.25 kHz/ 8K30F1E/F1D/F7W / 450.05 MHz(FCC/RSS)
Limit : Mask D

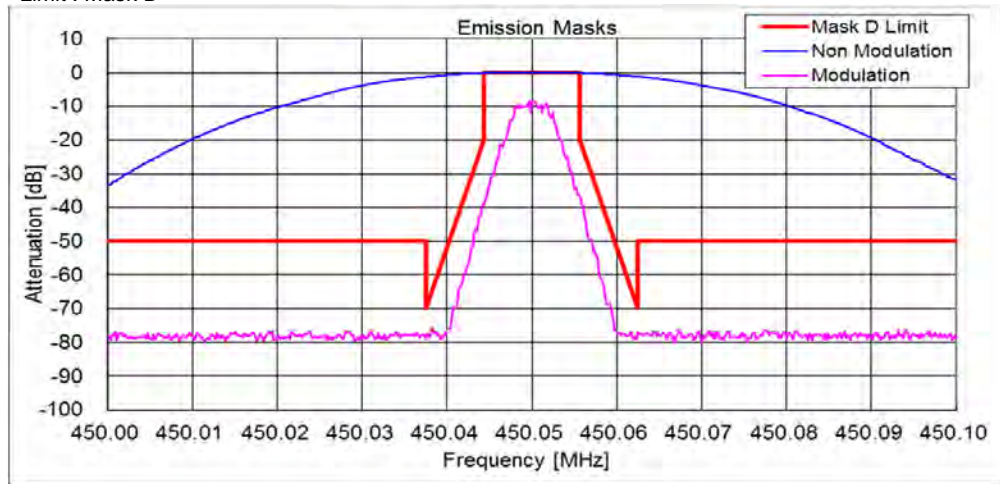

State : Low Power / Authorized Bandwidth 11.25 kHz/ 8K10F1E / F1D / 511.95 MHz(FCC)
Limit : Mask D

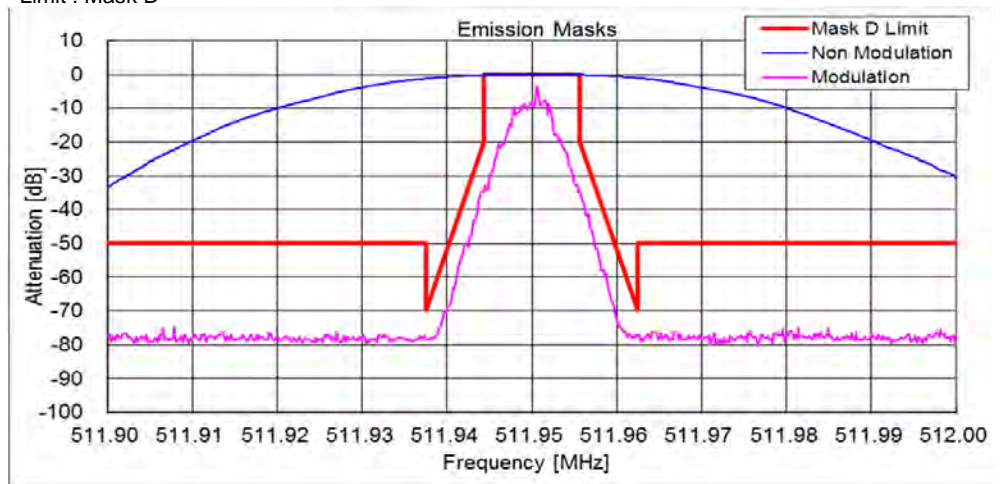

State : Low Power / Authorized Bandwidth 11.25 kHz/ 8K10F1E / F1D / 460.05 MHz(RSS)
Limit : Mask D

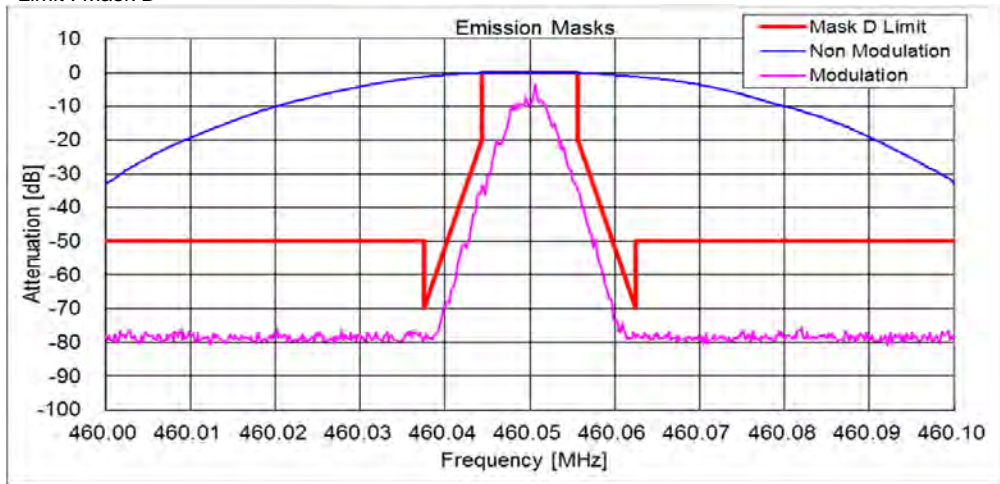

State : Low Power / Authorized Bandwidth 6 kHz/ 4K00F1E / F1D / F7W / 450.05 MHz(FCC)
Limit : Mask E

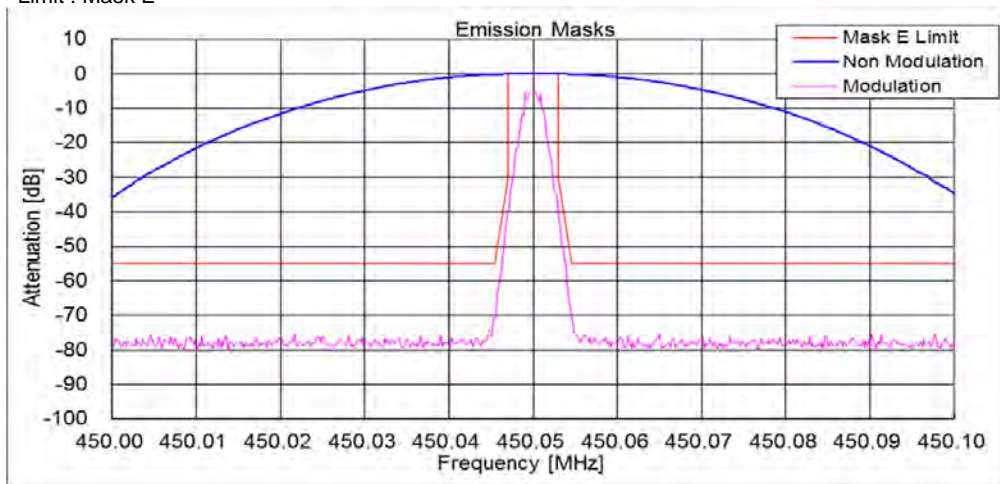

State : Low Power / Authorized Bandwidth 6 kHz/ 4K00F1E / F1D / F7W / 469.95 MHz(RSS)
Limit : Mask E

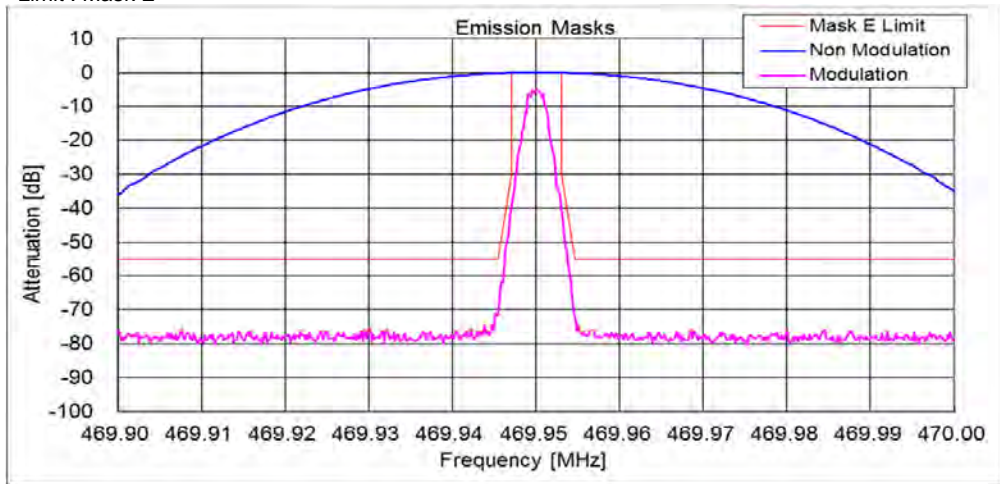

State : Low Power / Authorized Bandwidth 6 kHz/ 4K00F2D / 450.05 MHz(FCC)
Limit : Mask E

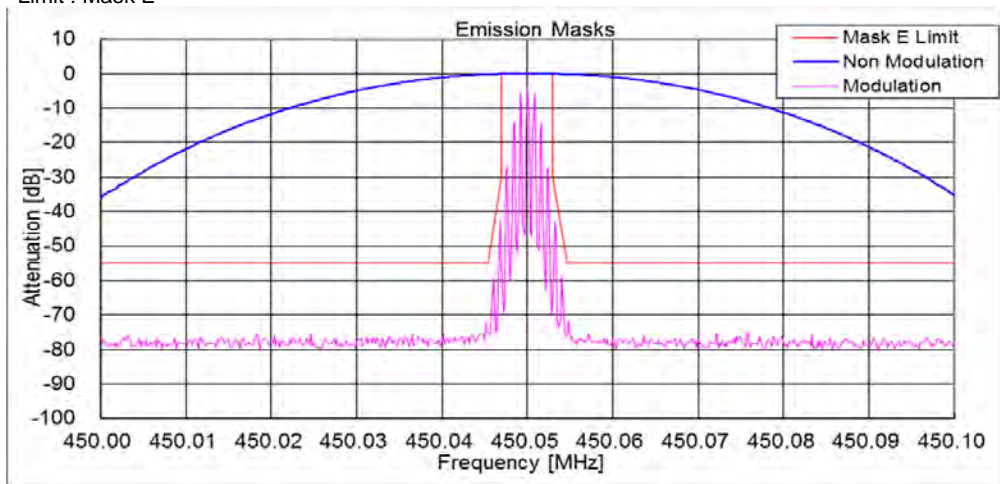

State : Low Power / Authorized Bandwidth 6 kHz/ 4K00F2D / 460.05 MHz(RSS)
Limit : Mask E

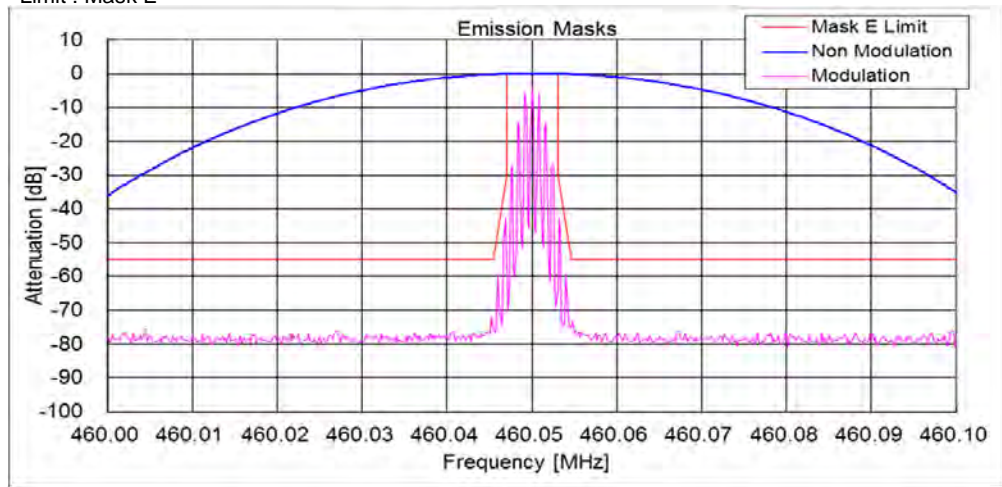

10.5 Transient Frequency Behavior

REGULATIONS : FCC Part 90 Section 214

TEST METHOD/GUIDE : ANSI/TIA-603-D, Section 2.2.19.3

Test Procedure

- 1 The EUT and test equipment were set up as shown on the following page.
- 2 The transmitter was turned on.
- 3 The transmitter carrier level was measured at the output of the combiner .
- 4 The transmitter was turned off.
- 5 An RF signal generator (1) modulated with a 1 kHz tone at either 25 kHz or 12.5 kHz or 6.25 kHz deviation, and set to the same frequency as the assigned transmitter frequency, (2) was adjusted to a level -30 dB below the level recorded in Procedure 3, as measured at the output of the combiner.
This level was then fixed for the remainder of the test and is recorded at step h.
- 6 The oscilloscope was setup using TIA-603 steps j and k as a guide, however 1000 Hz tone was adjusted at +- 2.5 /div vertically centered on the display.
- 7 The transmitter was turned on, and the level of the carrier at the output of the combiner was recorded as step l.
- 8 The carrier on-time as referenced in TIA-603 steps m, n, and o was captured and plotted.
- 9 The carrier off-time as referenced in TIA-603 steps p, q, r, and s was captured and plotted.

No.	Equipment	Manufacture	Model No.	Serial No.	Cal. Interval	Effective period
1	Power Meter	Hewlett Packard	E4418B	GB38410265	1Y	May. 31, 17
2	Power Sensor	Hewlett Packard	8482A	US37292237	1Y	May. 31, 17
3	Attenuator (20dB)	Aeroflex/Wenshel	66-20-34	BY4357	1Y	May. 31, 17
4	Attenuator (3dB)	TME	CFA-20NPJ-3	679701	1Y	May. 31, 17
5	Attenuator (30dB)	Weinschel	WA-29-30-34	8923	1Y	May. 31, 17
6	Step Attenuator	Hewlett Packard	8494B	272614515	1Y	Jan. 31, 18
7	Combiner(1)	Anritsu	Z-164A	M89249	1Y	Jan. 31, 18
8	Combiner(2)	Anritsu	Z-164A	M89549	1Y	Jan. 31, 18
9	Modulation Analyzer	Hewlett Packard	8901B	3403A04852	1Y	Dec. 31, 17
10	Signal Generator	Rohde&Schwarz	SMB 100A	105709	1Y	Apr. 30, 18
11	Oscilloscope	Tektronix	TDS 680B	B010292	1Y	Feb. 28, 18
12	DC Power Supply	Daiichi denpa kogyo	GZV4000	90290931	None	None
13	Digital Multi Meter	FLUKE	8846A	9642018	1Y	Sep. 30, 17

Measuring Cables

No.	Cable	Manufacture	Model No.	Serial No.	Cal. Interval	Effective period
W2	Coaxial Cable	Pacific custom	RG-58 C/U	KSR00097	1Y	Jan. 31, 18
W4	Coaxial Cable	Daiyu Densen	3D-2V	KSR00101	1Y	Feb. 28, 18
W5	Coaxial Cable	Pacific custom	RG-58 C/U	AM90C04	1Y	Feb. 28, 18
W3	Coaxial Cable	Pacific custom	RG-58 C/U	KSR00041	1Y	Feb. 28, 18

Measuring Equipment Configuration

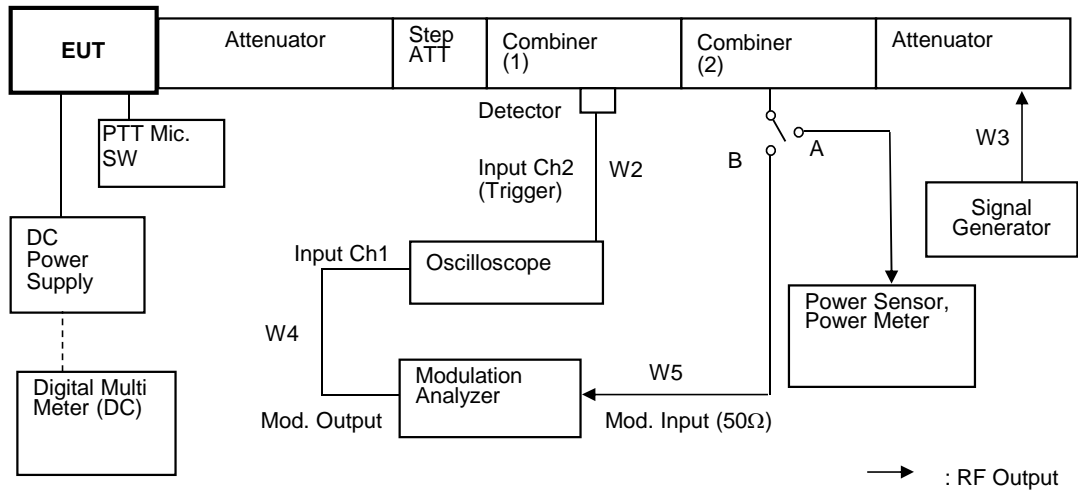

Test Results

Test date	Apr 19, 2017	
Location	Kashima No.12 Test Site	
temperature	20	[degree C]
Humidity Variation	51	[%]
Atmospheric Pressure	102	[kPa]
Test Engineer	Koichi Wagatsuma	

Test was carried out for all the frequency band of section 10.1
 State the worst case (below).

State : High Power / Authorized Bandwidth 20 kHz / 16K0F3E / 511.95 MHz (FCC)/ PTT:OFF -ON

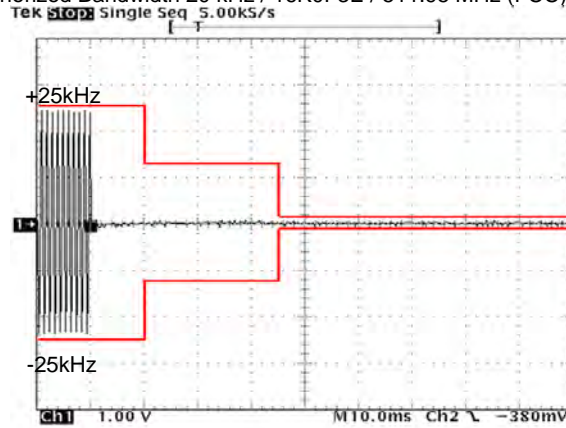

State : High Power / Authorized Bandwidth 20 kHz / 16K0F3E / 511.95 MHz (FCC)/ PTT:ON -OFF

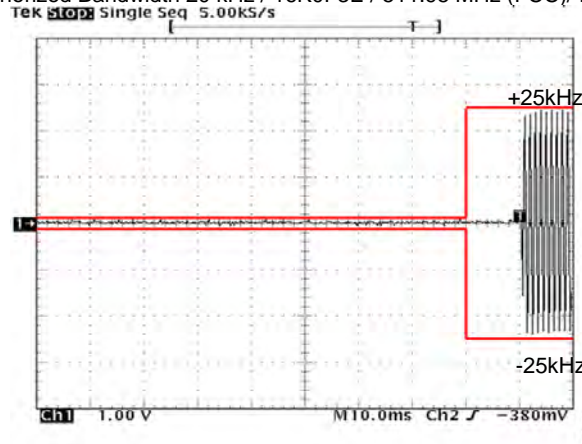

State : High Power / Authorized Bandwidth 20 kHz / 16K0F3E / 460.05 MHz (RSS)/ PTT:OFF -ON

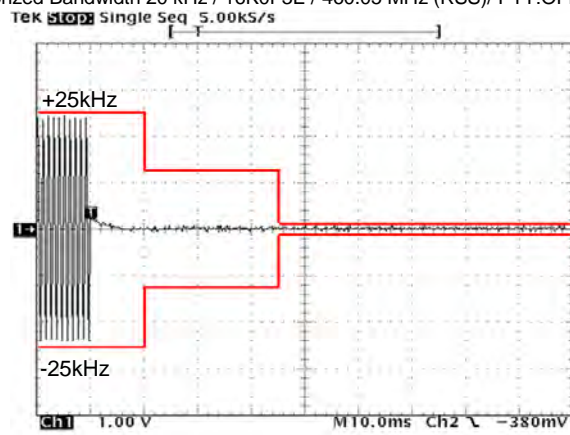

State : High Power / Authorized Bandwidth 20 kHz / 16K0F3E / 460.05 MHz (RSS)/ PTT:ON-OFF

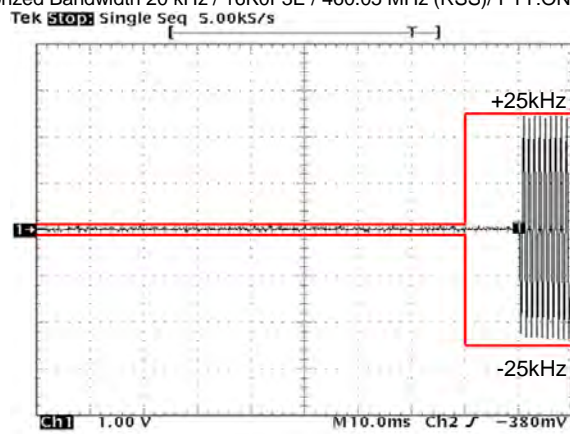

State : High Power / Authorized Bandwidth 20 kHz / 14K4F1D / 511.95 MHz (FCC)/ PTT:OFF -ON

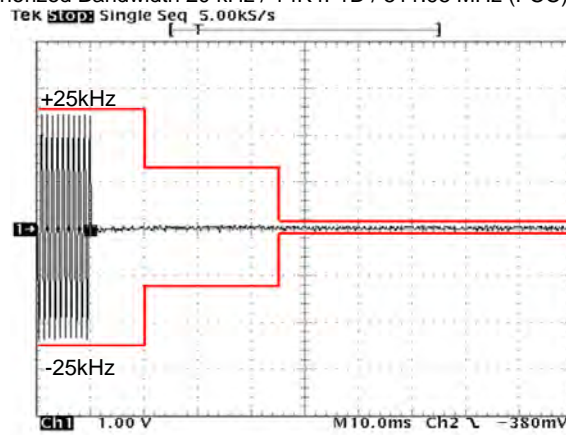

State : High Power / Authorized Bandwidth 20 kHz / 14K4F1D / 511.95 MHz (FCC)/ PTT:ON -OFF

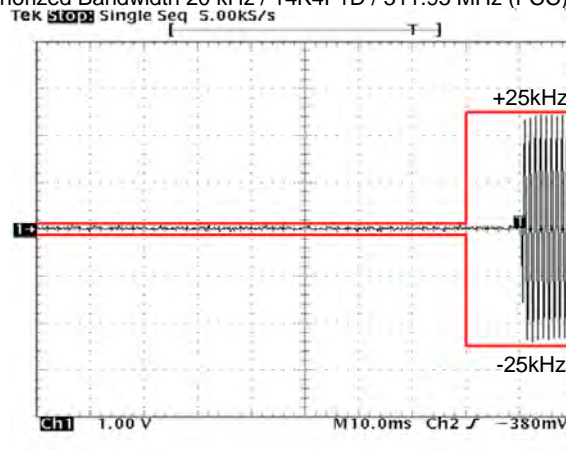

State : High Power / Authorized Bandwidth 20 kHz / 14K4F1D / 460.05 MHz (RSS)/ PTT:OFF -ON

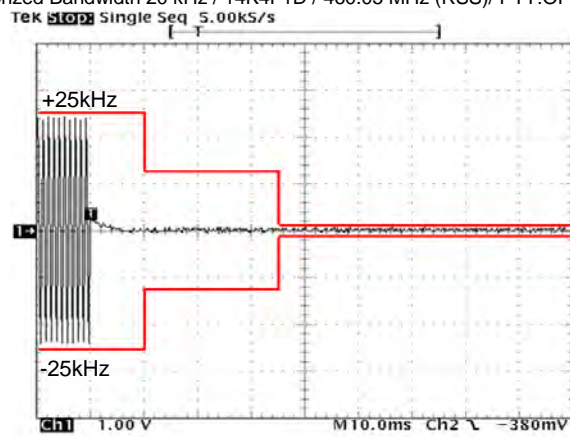

State : High Power / Authorized Bandwidth 20 kHz / 14K4F1D / 460.05 MHz (RSS)/ PTT:ON-OFF

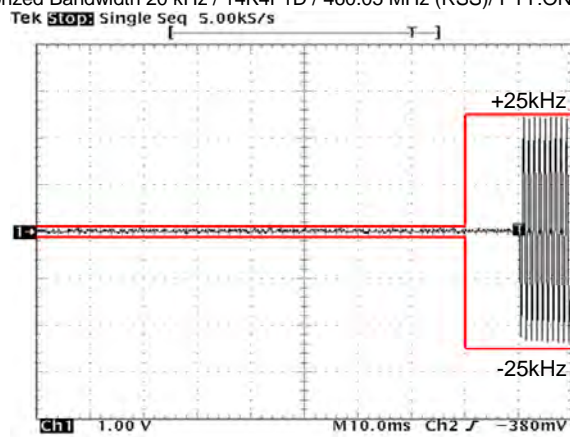

State : High Power / Authorized Bandwidth 11.25 kHz / 11K0F3E / 450.05 MHz (FCC/RSS)/ PTT:OFF -ON

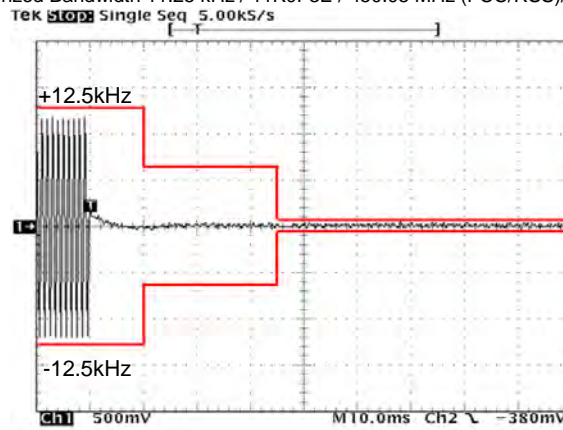

State : High Power / Authorized Bandwidth 11.25 kHz / 11K0F3E / 450.05 MHz (FCC/RSS)/ PTT:ON-OFF

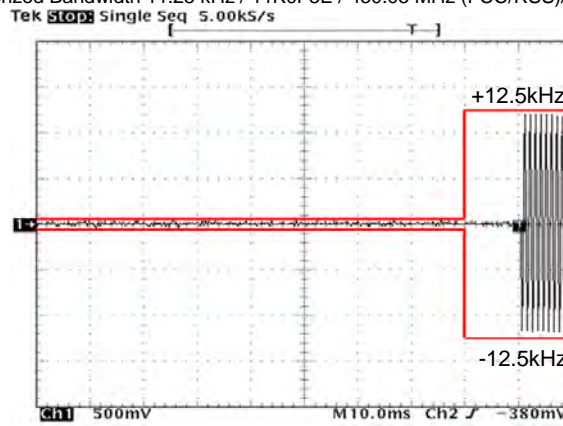

State : High Power / Authorized Bandwidth 11.25 kHz / 8K30F1E/F1D/F7W / 450.05 MHz (FCC/RSS)/ PTT:OFF -ON

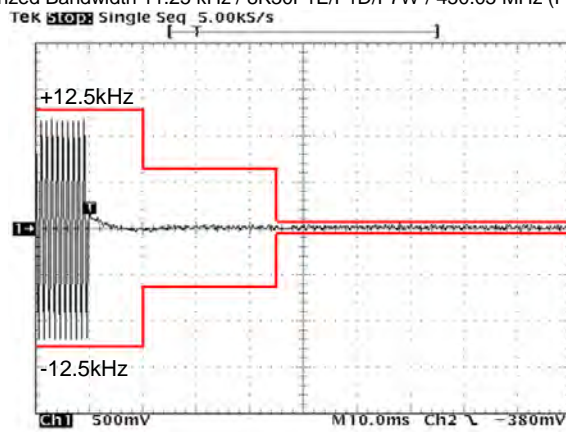

State : High Power / Authorized Bandwidth 11.25 kHz / 8K30F1E/F1D/F7W / 450.05 MHz (FCC/RSS)/ PTT:ON-OFF

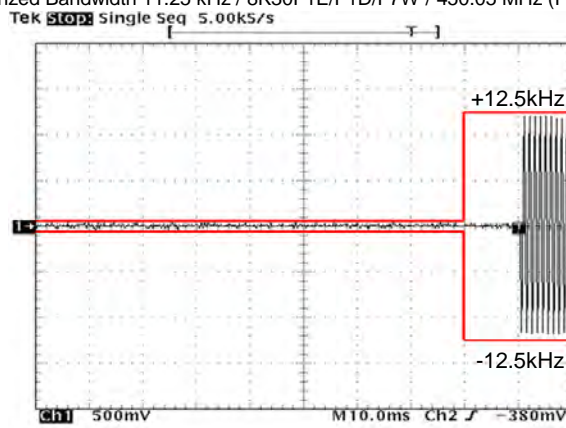

State : High Power / Authorized Bandwidth 11.25 kHz / 8K10F1E / F1D / 450.05 MHz (FCC/RSS)/ PTT:OFF -ON

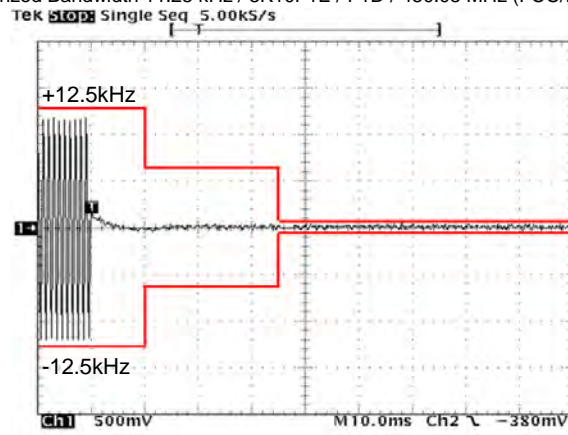

State : High Power / Authorized Bandwidth 11.25 kHz / 8K10F1E / F1D / 450.05 MHz (FCC/RSS)/ PTT:ON-OFF

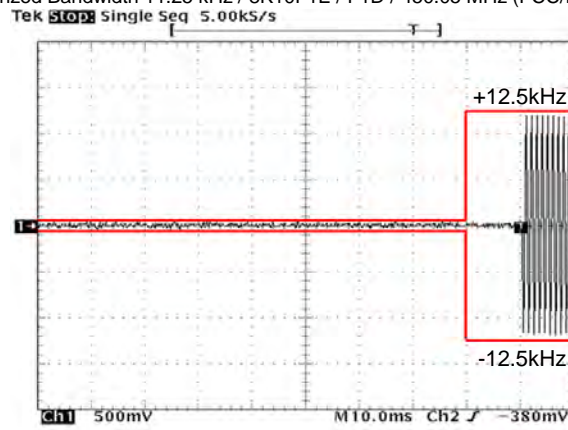

State : High Power / Authorized Bandwidth 6 kHz / 4K00F1E / F1D / F7W / 450.05 MHz (FCC/RSS)/ PTT:OFF -ON

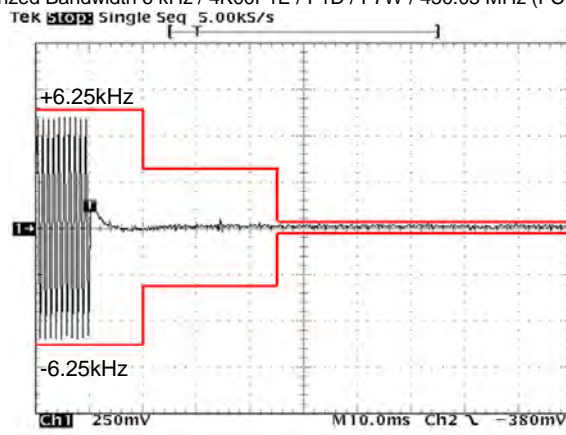

State : High Power / Authorized Bandwidth 6 kHz / 4K00F1E / F1D / F7W / 450.05 MHz (FCC/RSS)/ PTT:ON-OFF

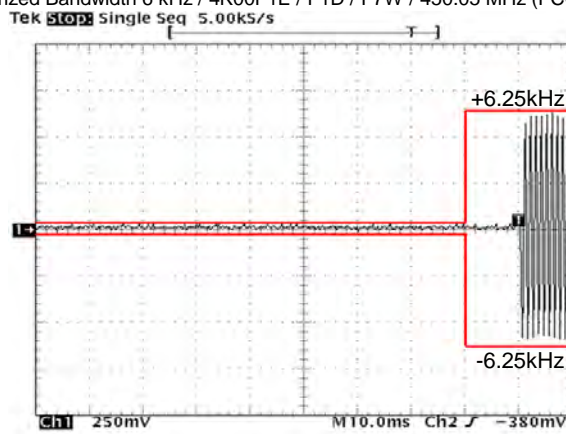

State : High Power / Authorized Bandwidth 6 kHz / 4K00F2D / 450.05 MHz (FCC/RSS)/ PTT:OFF -ON

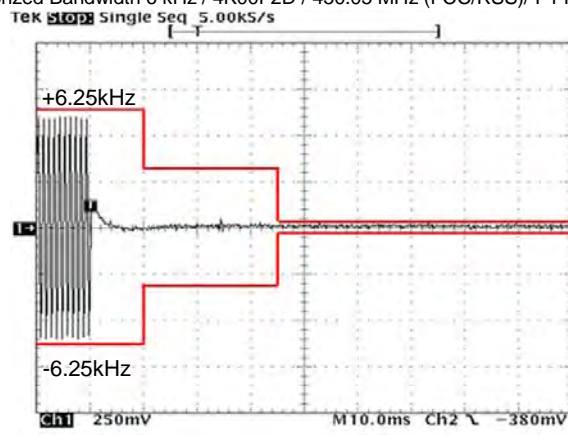

State : High Power / Authorized Bandwidth 6 kHz / 4K00F2D / 450.05 MHz (FCC/RSS)/ PTT:ON-OFF

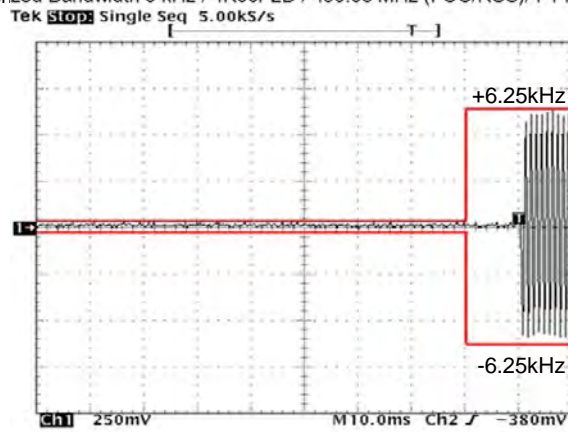

10.6 Audio Frequency Response / Audio Low Pass Filter (Voice Input)

REGULATIONS	: FCC Part 2 Section 1047 (a)
TEST METHOD/GUIDE	: ANSI/TIA-603-D Section 2.2.6.2.2, 3.2.6.2

Test Procedure

- 1 The EUT and test equipment were set up as shown on the following page.
- 2 Adjust the Modulation Analyzer for the following setting:
 - a) High-pass filter : 50 Hz
 - b) Low-pass filter : 15 kHz
 - c) Detector : positive peak
 - d) Function : FM
- 3 The audio signal input was adjusted to obtain 20 % modulation at 1 kHz, and this point was taken as the 0 dB reference level.
- 4 With input levels held constant and below limiting at all frequencies, the audio signal generator was varied from 100 Hz to 5 kHz.
- 5 The response in dB relative to 1 kHz was then measured, using the Modulation Analyzer.

Measuring Equipments

No.	Equipment	Manufacture	Model No.	Serial No.	Cal. Interval	Effective period
1	Attenuator (20dB)	Aeroflex/Wenschel	66-20-34	BY4357	1Y	May. 31, 17
2	Attenuator (30dB)	Weinschel	WA-29-30-34	8923	1Y	May. 31, 17
3	Modulation Analyzer	Hewlett Packard	8901B	3403A04852	1Y	Dec. 31, 17
4	Audio Generator	Anritsu	MG443B	M70150	1Y	May. 31, 17
5	Audio Analyzer	Hewlett Packard	8903B	2948A07326	1Y	Sep. 30, 17
6	DC Power Supply	Daiichi denpa kogyo	GZV4000	90290931	None	None
7	Digital Multi Meter	FLUKE	8846A	9642018	1Y	Sep. 30, 17

Measuring Cables

No.	Cable	Manufacture	Model No.	Serial No.	Cal. Interval	Effective period
W2	Balance Cable	Nicoon	3D-2V	KSR00092	1Y	Mar. 31, 18
W4	Coaxial Cable	Daiyu Densen	3D-2V	KSR00101	1Y	Feb. 28, 18
W3	Coaxial Cable	Pacific custom	RG-58 C/U	AM90C04	1Y	Feb. 28, 18

Measuring Equipment Configuration

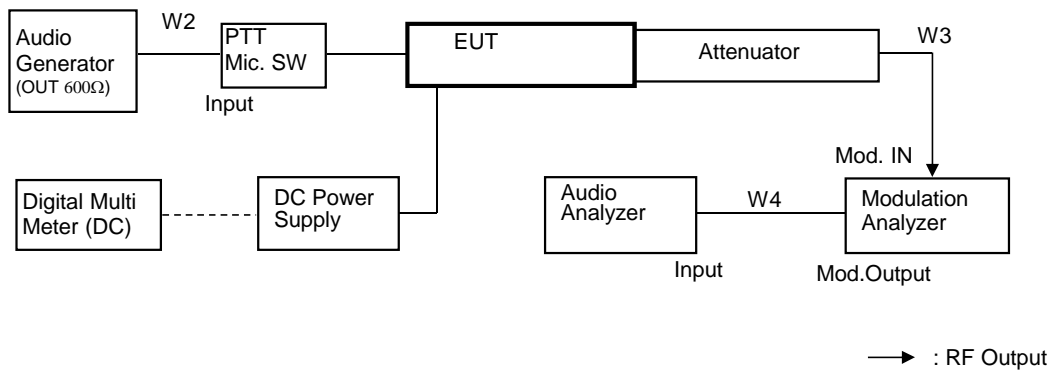

Test Results

Test date	Apr 18, 2017	
Location	Kashima No.12 Test Site	
temperature	23	[degree C]
Humidity Variation	50	[%]
Atmospheric Pressure	98.9	[kPa]
Test Engineer	Koichi Wagatsuma	

Test was carried out for all the frequency band of section 10.1
 State the worst case (below).

State : High Power / Authorized Bandwidth 20 kHz / 16K0F3E / 511.95 MHz(FCC)

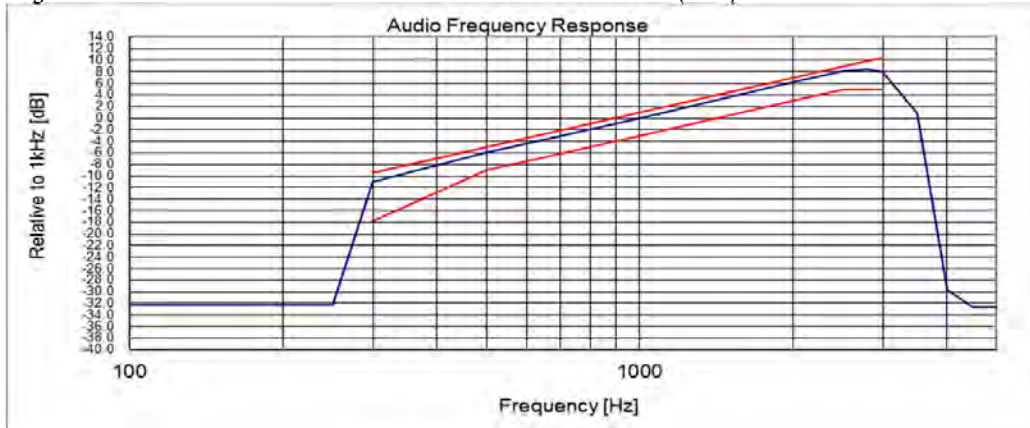

Note:

Audio Filter of the above result is substituted with the same structure as Audio Frequency Response.
 On the transmission condition below 3kHz,
 Transceiver shows pre-emphasis condition of transmission function.
 On the transmission condition above 3kHz, Transceiver shows Audio Low Pass Filter.

State : High Power / Authorized Bandwidth 20 kHz / 16K0F3E / 450.05 MHz(RSS)

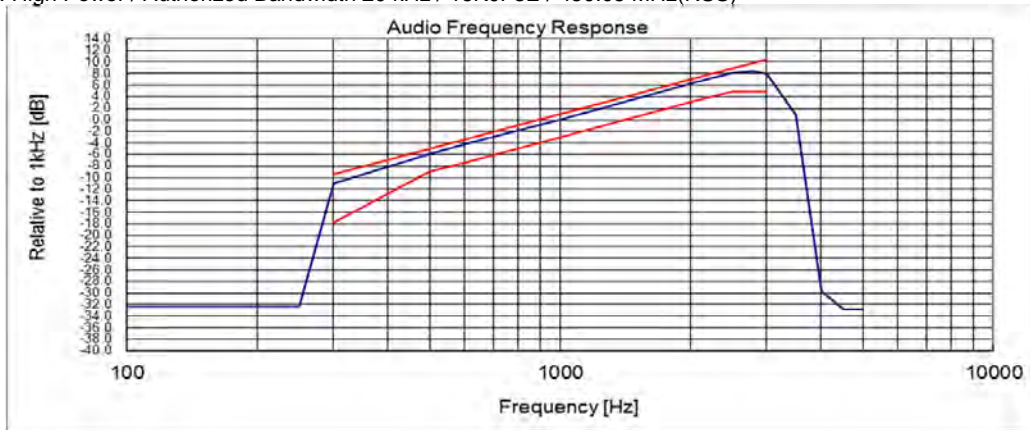

Note:

Audio Filter of the above result is substituted with the same structure as Audio Frequency Response.

On the transmission condition below 3kHz,

Transceiver shows pre-emphasis condition of transmission function.

On the transmission condition above 3kHz, Transceiver shows Audio Low Pass Filter.

State : High Power / Authorized Bandwidth 11.25 kHz / 11K0F3E / 450.05 MHz(FCC / RSS)

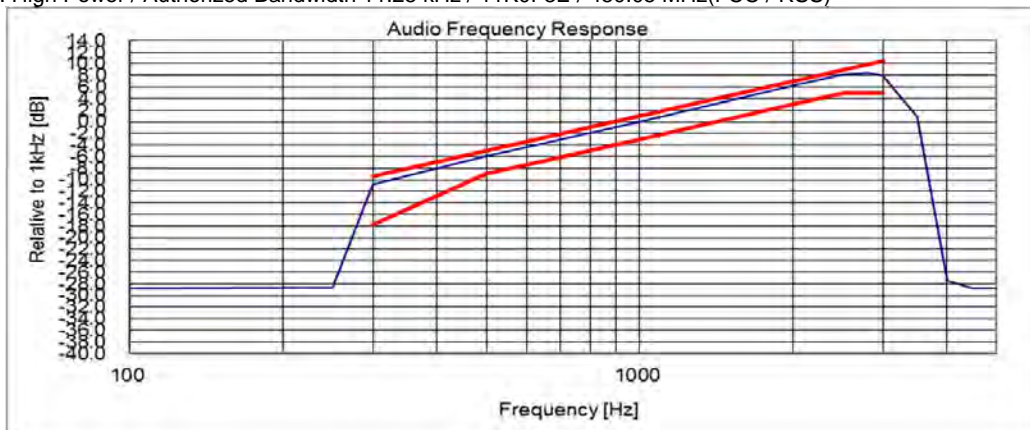

Note:

Audio Filter of the above result is substituted with the same structure as Audio Frequency Response.

On the transmission condition below 3kHz,

Transceiver shows pre-emphasis condition of transmission function.

On the transmission condition above 3kHz, Transceiver shows Audio Low Pass Filter.

10.7 Modulation Limiting

REGULATIONS	: FCC Part 2 Section 1047 (b)
TEST METHOD/GUIDE	: ANSI/TIA-603-D Section 2.2.3.2, 1.3.4.4

Test Procedure

- 1 The EUT and test equipment were set up as shown on the following page.
- 2 Adjust the Modulation Analyzer for the following setting:
 - a) High-pass filter : off
 - b) Low-pass filter : 15 kHz
 - c) Detector : positive peak
 - d) Function : FM
- 3 Apply a 1kHz modulation signal to the transmitter from the audio generator, and adjust the level to obtain 60% of full rated system deviation.
- 4 Measure the modulation frequency that was showed on the Modulation Analyzer when the output levels of the Audio Generator were changed from -20 dB to +50 dB by 10 dB.
- 5 Set the output frequencies of the Audio Generator 300 Hz and 3 kHz, and repeat test procedure 4.
- 6 Set the Detector of the Modulation Analyzer Negative Peak.
- 7 Repeat test procedure 4 and 5.

Measuring Equipments

No.	Equipment	Manufacture	Model No.	Serial No.	Cal. Interval	Effective period
1	Attenuator (20dB)	Aeroflex/Wenshel	66-20-34	BY4357	1Y	May. 31, 17
2	Attenuator (30dB)	Weinschel	WA-29-30-34	8923	1Y	May. 31, 17
3	Modulation Analyzer	Hewlett Packard	8901B	3403A04852	1Y	Dec. 31, 17
4	Audio Generator	Anritsu	MG443B	M70150	1Y	May. 31, 17
5	DC Power Supply	Daiichi denpa kogyo	GZV4000	90290931	None	None
4	Digital Multi Meter	FLUKE	8846A	9642018	1Y	Sep. 30, 17

Measuring Cables

No.	Cable	Manufacture	Model No.	Serial No.	Cal. Interval	Effective period
W2	Balance Cable	Nicoon	3D-2V	KSR00092	1Y	Mar. 31, 18
W3	Coaxial Cable	Pacific custom	RG-58 C/U	AM90C04	1Y	Feb. 28, 18

Measuring Equipment Configuration

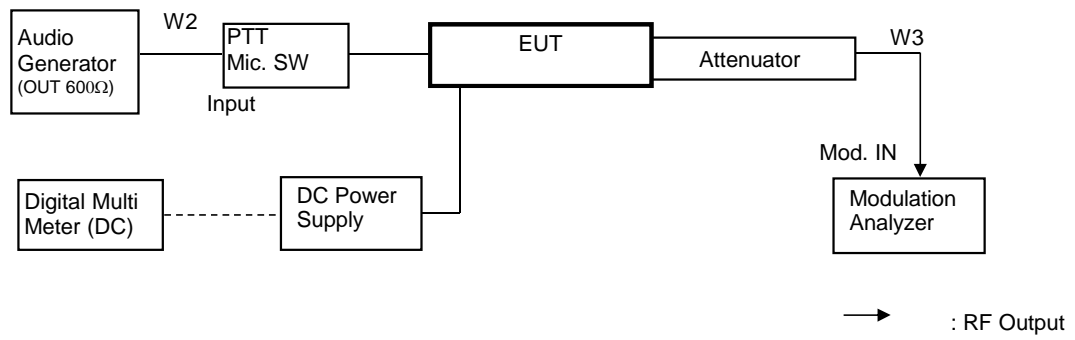

Test Results

Test date	Apr. 18, 2017	
Location	Kashima No.12 Test Site	
temperature	23	[degree C]
Humidity Variation	50	[%]
Atmospheric Pressure	98.9	[kPa]
Test Engineer	Koichi Wagatsuma	

Test was carried out for all the frequency band of section 10.1
 State the worst case (below).

State : High Power / Authorized Bandwidth 20 kHz / 16K0F3E / 491.05 MHz(FCC)

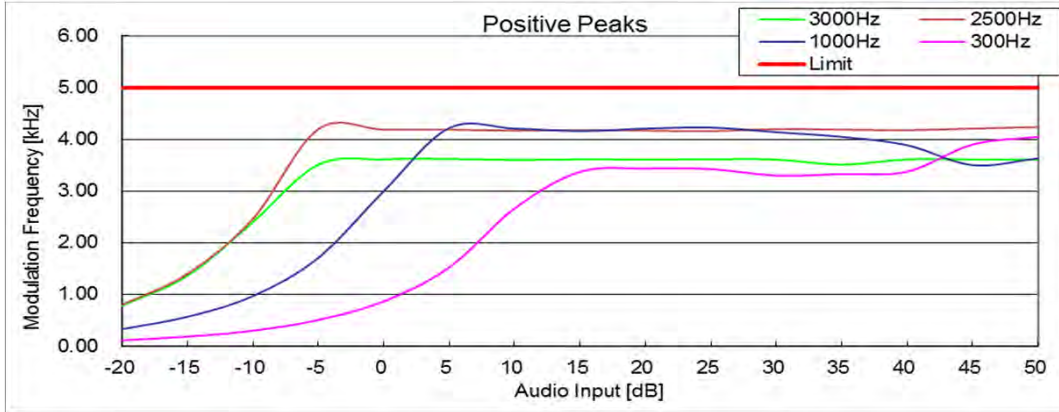

State : High Power / Authorized Bandwidth 20 kHz / 16K0F3E / 491.05 MHz(FCC)

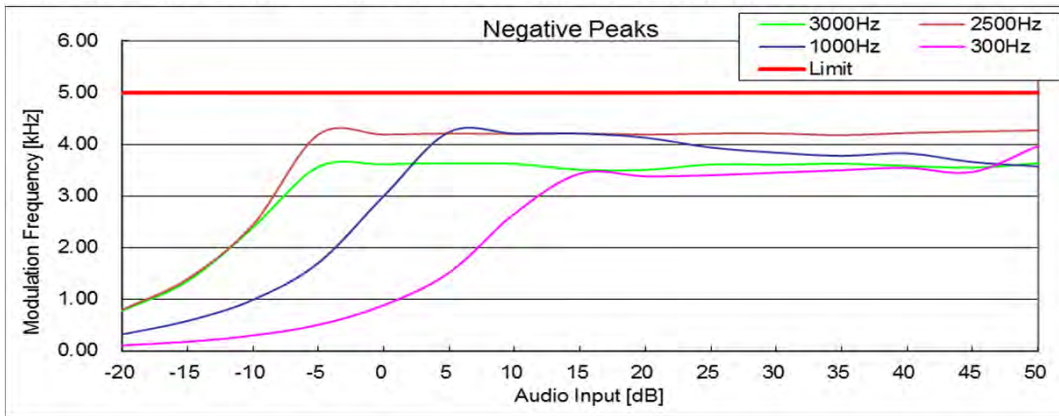

State : High Power / Authorized Bandwidth 20 kHz / 16K0F3E / 469.95 MHz(RSS)

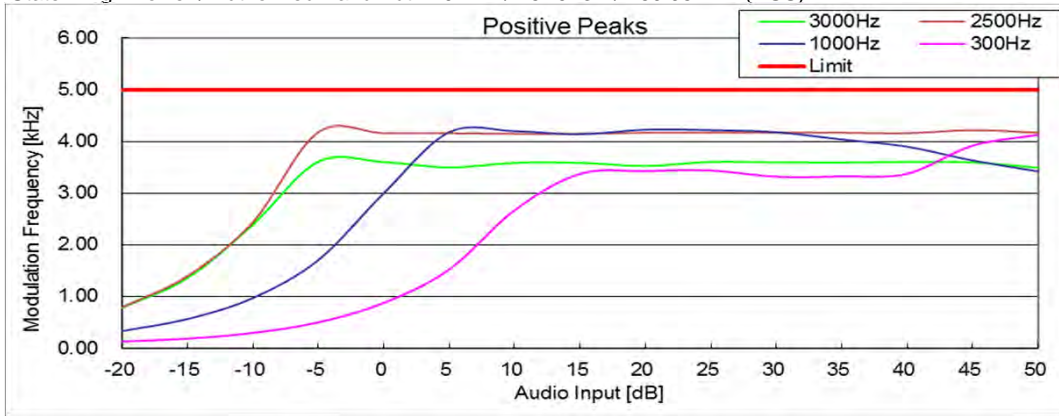

State : High Power / Authorized Bandwidth 20 kHz / 16K0F3E / 469.95 MHz(RSS)

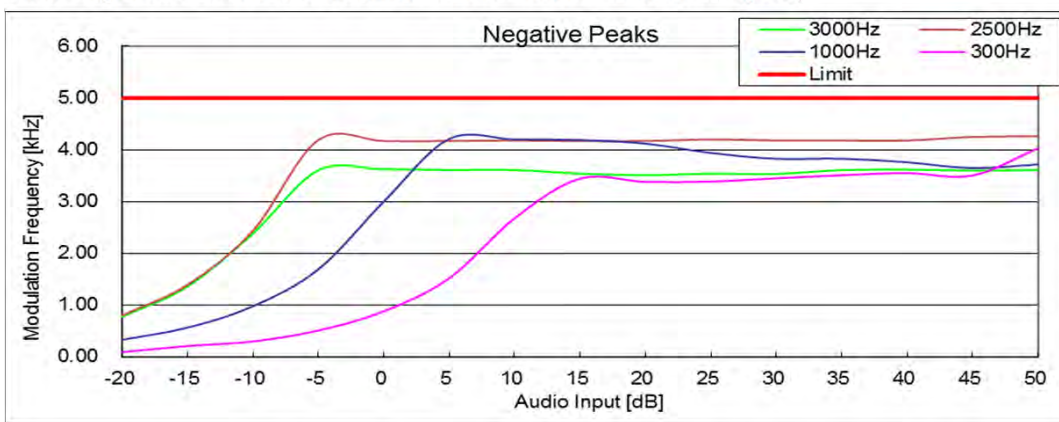

State : High Power / Authorized Bandwidth 11.25 kHz / 11K0F3E / 481.05 MHz(FCC)

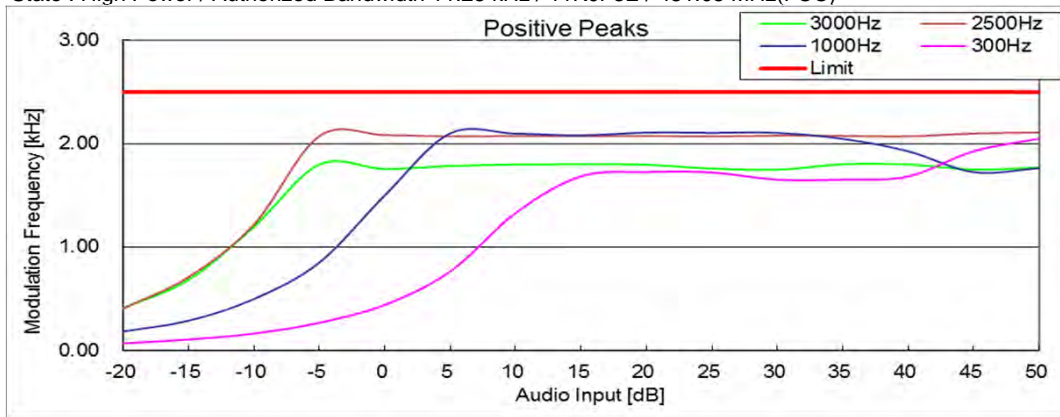

State : High Power / Authorized Bandwidth 11.25 kHz / 11K0F3E / 481.05 MHz(FCC)

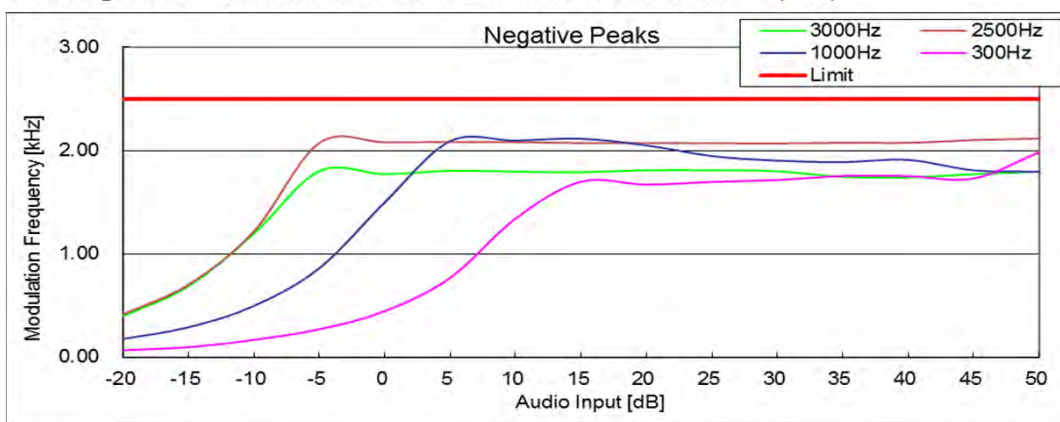

State : High Power / Authorized Bandwidth 11.25 kHz / 11K0F3E / 469.95 MHz(RSS)

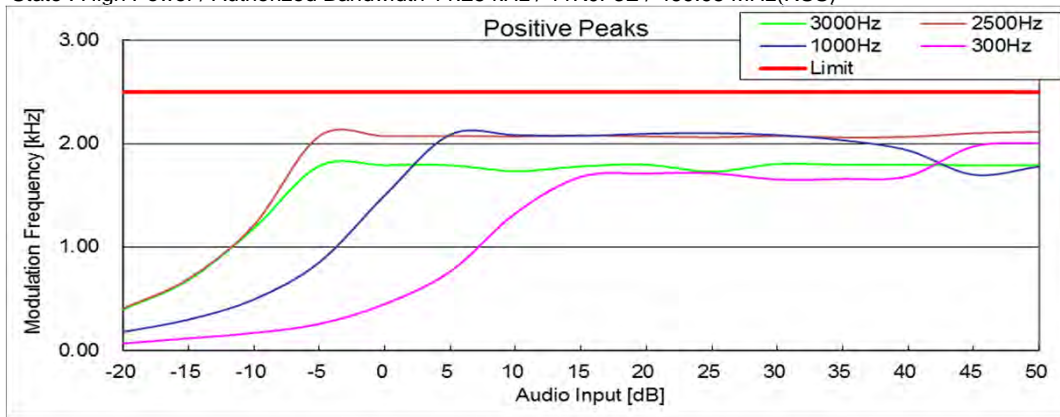

State : High Power / Authorized Bandwidth 11.25 kHz / 11K0F3E / 469.95 MHz(RSS)

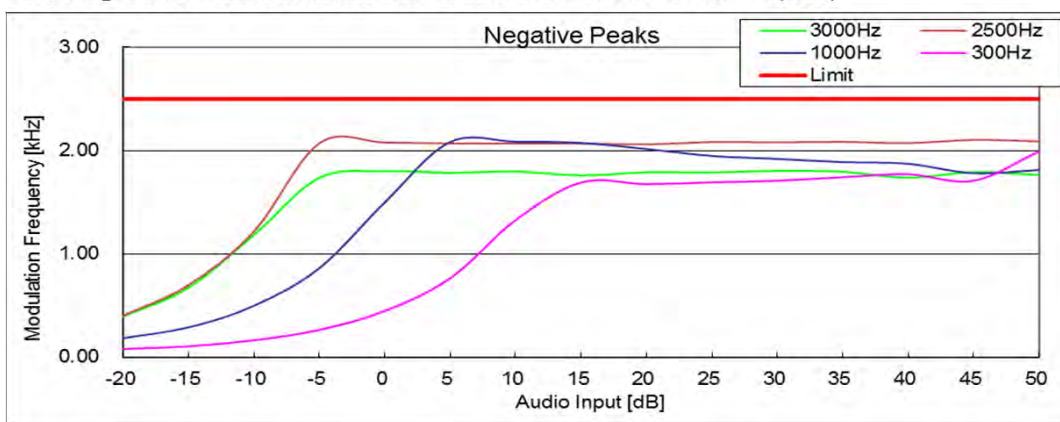

10.8 Frequency Stability (Temperature Variation)

REGULATIONS	: FCC Part 2 Section 1055 (a) (1), Part 90 Section 213(a) RSS-119 Section 5.3
TEST METHOD/GUIDE	: ANSI/TIA-603-D Section 2.2.2.2 RSS-Gen Section 4.7(a)

Test Procedure

- 1 The EUT and test equipment were set up as shown on the following page.
- 2 Set the temperature -30 degrees C.
- 3 Leave the EUT for 1 hour after it became the temperature that was set up.
- 4 Make the EUT the transmitting state.
measure the output frequency.
- 5 Make the EUT the receiving state.
- 6 Set the temperature 50 degrees C by 10 degrees C.
And repeat test procedure 4 to 6.

Measuring Equipments

No.	Equipment	Manufacture	Model No.	Serial No.	Cal. Interval	Effective period
1	Attenuator (20dB)	Aeroflex/Wenshel	66-20-34	BY4357	1Y	May. 31, 17
2	Attenuator (30dB)	Weinschel	WA-29-30-34	8923	1Y	May. 31, 17
3	Modulation Analyzer	Hewlett Packard	8901B	3403A04852	1Y	Dec. 31, 17
4	DC Power Supply	Takasago	GP035-20R	1014199060	None	None
5	Digital Multi Meter	FLUKE	8846A	9642018	1Y	Sep. 30, 17
6	Temperature Chamber	Tabai	PL-3F	5103661	None	None
7	Temperature Meter	Sato	PC-5000TRH-II	A11999972	1Y	Feb. 28, 18
8	GPS Receiver	Hewlett Packard	HP Z3801A	3542A02414	None	None

Measuring Cables

No.	Cable	Manufacture	Model No.	Serial No.	Cal. Interval	Effective period
W2	Coaxial Cable	Pacific custom	RG-58 C/U	KSR00041	1Y	Feb. 28, 18
W1	Coaxial Cable	Suhner	SUCOFLEX104	KSR00042	1Y	May. 31, 17

Measuring Equipment Configuration

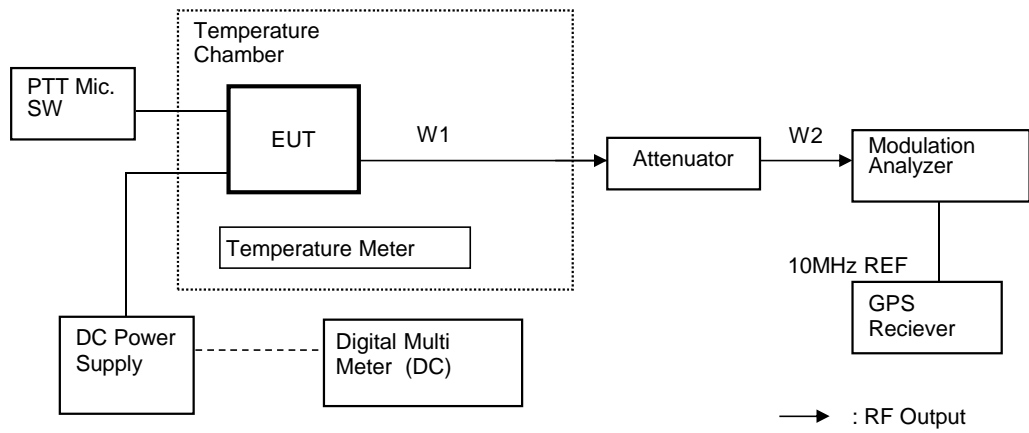

Test Results

Test date	May. 23, 2017
Location	Kashima No.1 Test Site
Test Engineer	Koichi Wagatsuma

Test was carried out for all the frequency band of section 10.1
 State the worst case (below).

State : High Power / Authorized Bandwidth 11.25 kHz / 450.05 MHz (FCC / RSS)
 Reference Frequency: 450.050000 MHz(FCC Stability)
 450.049960 MHz(RSS Stability)

No.	Temperature (Degree C)	Frequency (MHz)	FCC Stability (ppm)	RSS Stability (ppm)	Limit (+/- ppm)	Min. Margin (ppm)
1	-30	450.049670	-0.73	-0.64	1.0	0.27
2	-20	450.049830	-0.38	-0.29	1.0	0.62
3	-10	450.049870	-0.29	-0.20	1.0	0.71
4	0	450.049880	-0.27	-0.18	1.0	0.73
5	10	450.049900	-0.22	-0.13	1.0	0.78
6	20	450.049960	-0.09	0.00	1.0	0.91
7	30	450.050000	0.00	0.09	1.0	0.91
8	40	450.050080	0.18	0.27	1.0	0.73
9	50	450.050100	0.22	0.31	1.0	0.69

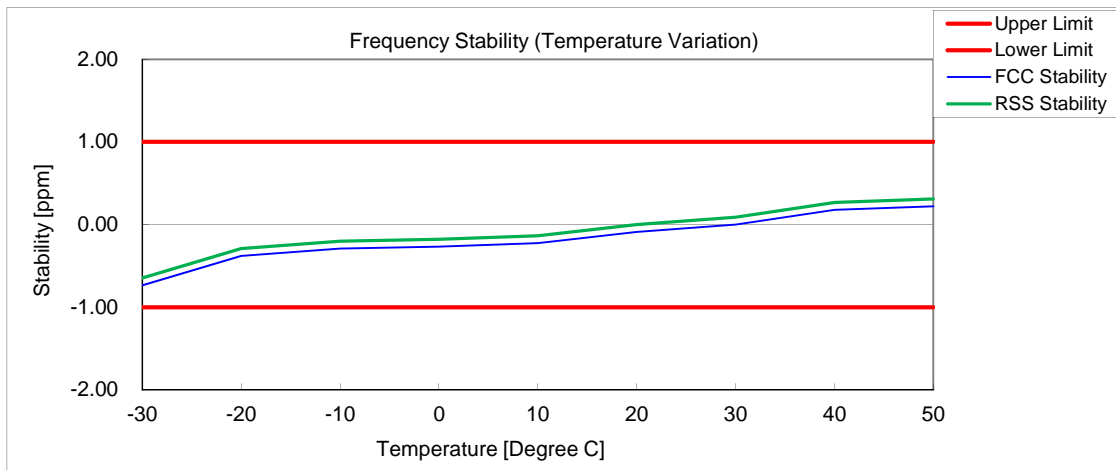

10.9 Frequency Stability (Voltage Variation)

REGULATIONS	: FCC Part 2 Section 1055 (a) (1), Part 90 Section 213(a) RSS-119 Section 5.3
TEST METHOD/GUIDE	: ANSI/TIA-603-D Section 2.2.2.2 RSS-Gen Section 4.7(a)

Test Procedure

- 1 The EUT and test equipment were set up as shown on the following page.
- 2 The power supply voltage to the EUT was varied from 85 % to 115 % of the nominal value measured at the input to the EUT.

Measuring Equipments

No.	Equipment	Manufacture	Model No.	Serial No.	Cal. Interval	Effective period
1	Attenuator (20dB)	Aeroflex/Wenshel	66-20-34	BY4357	1Y	May. 31, 17
2	Attenuator (30dB)	Weinschel	WA-29-30-34	8923	1Y	May. 31, 17
3	Modulation Analyzer	Hewlett Packard	8901B	3403A04852	1Y	Dec. 31, 17
4	DC Power Supply	Takasago	GP035-20R	1014199060	None	None
5	Digital Multi Meter	FLUKE	8846A	9642018	1Y	Sep. 30, 17
6	Temperature Chamber	Tabai	PL-3F	5103661	None	None
7	Temperature Meter	Sato	PC-5000TRH-II	A11999972	1Y	Feb. 28, 18
8	GPS Receiver	Hewlett Packard	HP Z3801A	3542A02414	None	None

Measuring Cables

No.	Cable	Manufacture	Model No.	Serial No.	Cal. Interval	Effective period
W2	Coaxial Cable	Pacific custom	RG-58 C/U	KSR00041	1Y	Feb. 28, 18
W1	Coaxial Cable	Suhner	SUCOFLEX104	KSR00042	1Y	May. 31, 17

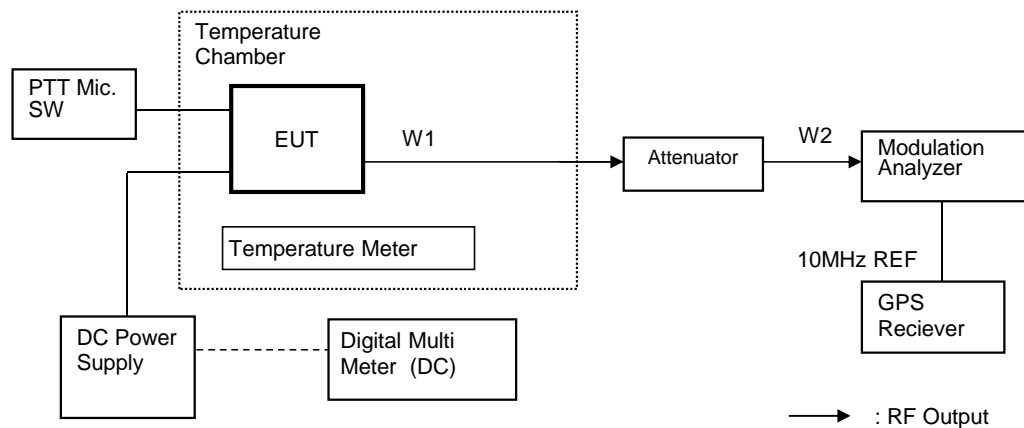
Measuring Equipment Configuration

Test Results

Test date	May 23, 2017
Location	Kashima No.1 Test Site
Test Engineer	Koichi Wagatsuma

Test was carried out for all the frequency band of section 10.1
State the worst case (below).

State : High Power / Authorized Bandwidth 11.25 kHz / 450.05 MHz (FCC / RSS)

Reference Frequency: 450.049960 MHz

No.	Temperature (Degree C)	Diviation (%)	Voltage (V)	Frequency (MHz)	Stability (ppm)	Limit +/- (ppm)	Margin (ppm)
1	20+/-5	85	11.56	450.049970	0.02	1.0	0.98
2	20+/-5	100	13.60	450.049960	0.00	1.0	1.00
3	20+/-5	115	15.64	450.049980	0.04	1.0	0.96

10.10 Receiver Spurious Emissions(Radiated)

REGULATIONS	:	RSS-Gen Section 7
TEST METHOD/GUIDE	:	RSS-Gen Section 7

TEST PROCEDURE

- 1 The EUT and test equipment were set up as shown on the following page.
- 2 Tabletop Equipment
EUT is placed on the wooden table, the top of which is 0.8meter above the metal ground plane(turntable).
- 3 Interconnecting Cables
Excess part of the interconnecting cables longer than 1 meter are bundled in the center.
Cables that hang closer than 40 cm to the ground plane is folded back and forth forming bundle 30 to 40 cm long, hanging approx, in the middle between ground plane and table.
- 4 Measuring Instruments
Measuring instruments list and their calibration schedule are shown on Measurement Equipment Configuration.
The brief description are as follows;
- 5 Antennas
The broadband Bi-cog antenna or Biconical and Log periodic antenna is used for measurement on the frequency range 30 – 1000 MHz.
The Double ridged guide antenna is used for frequency higher than 1000 MHz.
- 6 Pre-amplifier
The broadband pre-amplifier is used for radiated emission measurement.
The signal to noise ratio is improved by using pre-amplifier.
- 7 Spectrum Analyzer
The spectrum analyzer is used for preliminary measurement of frequency range 30 – 1000 MHz, and also used for final measurement of higher than 1000 MHz (RBW : 1 MHz).
- 8 EMI Test Receiver
The Quasi-peak detector (IF bandwidth : 120 kHz) built in test receiver is used for final measurement of the frequency 30 – 1000 MHz.
The test receiver is complied with the specification of the CISPR publication 16.
- 9 Turntable
The turntable is capable for EUT weight and rotatable 0 to 360 degree horizontally by remote control in the test room.
- 10 Antenna Mast
The antenna mast is attachable to all antennas described on antenna height is adjustable 1 to 4 meters continuously by remote control at the test room, and antenna polarization is also changed by the remote control.
- 11 Preliminary Measurement
EUT is tested on all operating conditions.
The spectrum analyzer is set max-hold mode and swept during turntable was rotated 0 to 360 degree. Then spectrum chart are plotted out to find the worst emission conditions in configuration, operating mode, or ambient noise notation.

12 Final Measurement

The EUT operated in the condition where maximum emission is found in the preliminary test.
 The turntable azimuth(EUT direction) and antenna height are adjusted the position so that maximum field strength is obtained for each frequency spectrum to be measured.
 The equipment and cables are arranged or manipulated within the range of the test standard in the above condition.
 When the uncertain result was obtained, the measurement is retried by using the half wave dipole antenna instead of the broadband antenna.

TEST EQUIPMENTS

No.	Equipment	Manufacture	Model No.	Serial No.	Cal. Interval	Effective period
1	Broad Band antenna	Schwarzbeck	Tri-Log VULB916	126	1Y	Dec. 31, 17
2	6 dB Attenuator	TAMAGAWA	UFA-01	None(A000408)	1Y	Feb. 28, 18
3	Amplifier	Intertek	ZX60-3018G	005	1Y	Feb. 28, 18
4	RF Switch	Intertek	ACX-150	None(A123015)	1Y	Feb. 28, 18
5	EMI Test receiver	Agilent	N9038A	MY51210201	1Y	Oct. 31, 17
6	Site Attenuation				1Y	Feb. 28, 18
7	Double Ridged antenna	Schwarzbeck	3115	5045	1Y	Mar. 31, 18
8	3 dB Attenuator	SUHNER	6803.17.B	KSR00089	1Y	Apr. 30, 18
9	Amplifier (1-18 GHz)	TOYO	TPA0118-30	0402	1Y	Apr. 30, 18
10	SVSWR				1Y	Oct. 31, 17
11	Testing Software	emiT (Version 3,0,0,0)			-	-

USED CABLES

No.	Cable	Manufacture	Model No.	Serial No.	Cal. Interval	Effective period
R11	Coaxial cable	FUJIKURA	5D-2W	R11	1Y	Feb. 28, 18
R1	Coaxial cable	FUJIKURA	5D-2W	R1	1Y	Feb. 28, 18
R3	Coaxial cable	FUJIKURA	10D-2W	R3	1Y	Feb. 28, 18
R5	Coaxial cable	FUJIKURA	RG-5A/U	R5	1Y	Feb. 28, 18
R7	Coaxial cable	FUJIKURA	RG-5A/U	R7	1Y	Feb. 28, 18
R10	Coaxial cable	FUJIKURA	5D-2W	R10	1Y	Feb. 28, 18
G1	Coaxial cable	SUHNER	SUCOFLEX 104	229603/4	1Y	Apr. 30, 18
G2	Coaxial cable	Candox	5B-048-98-98-5000	111130	1Y	Apr. 30, 18

MEASUREMENT EQUIPMENT CONFIGURATION

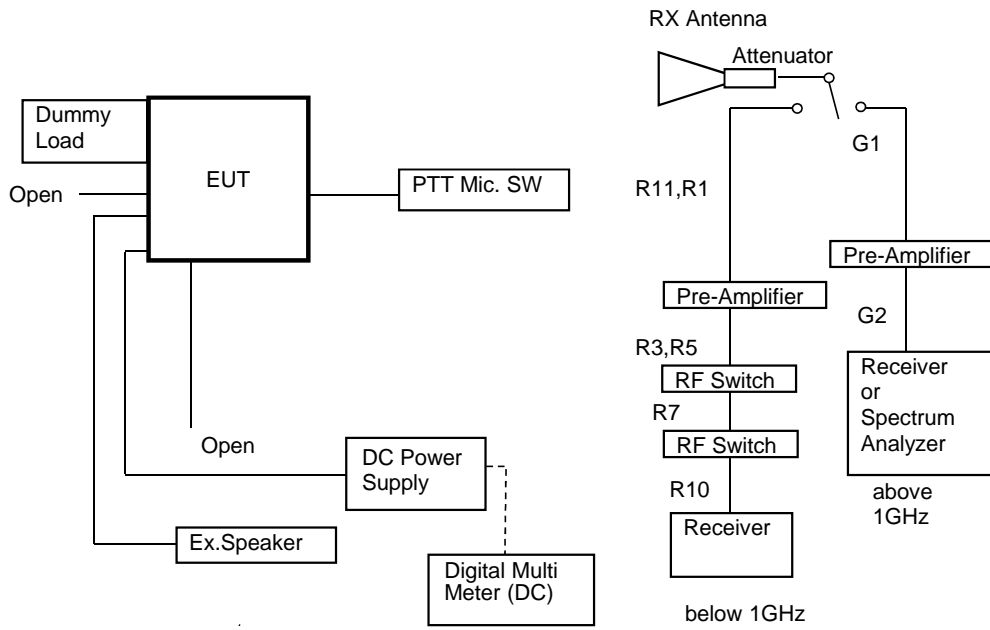

TEST RESULTS

Test date	Apr. 21, 2017 to Apr. 22, 2017
Location	Kashima No.12 Test Site
temperature	18.6 to 20 [degree C]
Humidity Variation	40 to 45 [%]
Atmospheric Pressure	99.4 to 100.1 [kPa]
Test Engineer	Koichi Wagatsuma

Test was carried out for the frequency band of section 10.1
 State the worst case (below).

State : 469.95 MHz Receiver Condition

No.	Frequency (MHz)	Pol	Mode	Reading Level (dBuv)	Factor* (dB)	Emission Level (dBuV/m)	Limit Level (dBuV/m)	Margin (dB)
1	261.38	Hor.	Ver.	-	0.6	-	46.0	-
				23.7	0.6	24.3	46.0	21.7
2	316.40	Hor.	Ver.	26.0	2.5	28.5	46.0	17.5
				27.2	2.5	29.7	46.0	16.3
3	318.69	Hor.	Ver.	24.9	2.6	27.5	46.0	18.5
				26.4	2.6	29.0	46.0	17.0
4	334.72	Hor.	Ver.	23.8	3.3	27.1	46.0	18.9
				22.9	3.3	26.2	46.0	19.8
5	335.38	Hor.	Ver.	21.7	3.3	25.0	46.0	21.0
				-	3.3	-	46.0	-
6	337.04	Hor.	Ver.	24.2	3.3	27.5	46.0	18.5
				-	3.3	-	46.0	-
7	823.80	Hor.	Ver.	-	15.1	-	46.0	-
				12.5	15.1	27.6	46.0	18.4
8	1235.70	Hor.	AVG	30.1	2.7	32.8	54.0	21.2
			Ver.	AVG	30.2	2.7	32.9	54.0
9	2883.30	Hor.	AVG	27.3	8.4	35.7	54.0	18.3
			Ver.	AVG	27.2	8.4	35.6	54.0

There is the margin of 20dB over except for the above points.
 * Factor = Antenna,Antenna Pad,Cable,Preamp,(Dist. Conversion)
 Emission Level = Reading Level + Factor

Note:

- 1 Measurement distance is 3 metres. (Above 1GHz is 6.5 meters)
- 2 Scanned frequency are 30 to 5000 MHz.
- 3 Highest frequency is 512 MHz.

10.11 Necessary Bandwidth and Emission Bandwidth

REGULATIONS	: FCC Part 2 Section 202 (g) & Federal Register/ Vol.68, No236 TRC 43
-------------	--

Calculation Results

State : 16K0F3E (Authorized Bandwidth 20 kHz)

Item	Mark		
Maximum Modulation	(M)	3	kHz
Maximum Deviation	(D)	5	kHz
Constant Factor	(K)	1	
Necessary Bandwidth	(Bn)	16	kHz

$$B_n = (2 \times M) + (2 \times D \times K)$$

- 1.types of modulation of the main carrier : F= Frequency modulation
 2.nature of signal(s) modulating the main carrier: 3= A single channel containing analog information
 3.type of information to be transmitted: E= Telephony (including sound broadcasting)

State : 14K4F1D (GMSK / 9600bps, Authorized Bandwidth 20 kHz)

Item	Mark		
Digital information rate	(R)	9600	bps
Peak frequency deviation	(D)	2.4	kHz
Signaling states	(S)	2	
Numerical factor	(K)	1	
Necessary Bandwidth	(Bn)	14.4	kHz

$$B_n = (R / \log_2 S) + 2 \times D \times K$$

- 1.types of modulation of the main carrier : F= Frequency modulation
 2.nature of signal(s) modulating the main carrier: 1= A single channel containing quantized or digital information without the use of a modulating sub-carrier
 3.type of information to be transmitted: D= Data transmission, telemetry, telecommand

State : 11K0F3E (Authorized Bandwidth 11.25 kHz)

Item	Mark		
Maximum Modulation	(M)	3	kHz
Maximum Deviation	(D)	2.5	kHz
Constant Factor	(K)	1	
Necessary Bandwidth	(Bn)	11	kHz

$$B_n = (2 \times M) + (2 \times D \times K)$$

- 1.types of modulation of the main carrier : F= Frequency modulation
 2.nature of signal(s) modulating the main carrier: 3= A single channel containing analog information
 3.type of information to be transmitted: E= Telephony (including sound broadcasting)

State: 8K10F1E / 8K10F1D (9600bps, Authorized Bandwidth 11.25 kHz)

Item	Mark		
Digital information rate	(R)	9600	bps
Peak frequency deviation	(D)	3.111	kHz
Signaling states	(S)	4	
Numerical factor	(K)	1	
Necessary Bandwidth	(Bn)	8.1	kHz Measurements were done*

*Measurements per Rule 47CFR Part 2.202(c)(4) were done because Part 2.202(g) Table III-A.1. formulation produces an excessive result using the value of K recommended in th Table. Therefore the 99% energy rule (title 47CFR 2.202(a)) was used for digital mode and is more accurate than Carson's rule. It basically states that 99% of the modulation energy falls within X kHz, in this case, 8.10kHz Measurements were performed in accordance with TIA/EIA 102.CAAB Section 2.2.5.2. The emission mask was obtained from 47CFR 90.210(d).

- 1.types of modulation of the main carrier : F= Frequency modulation
 2.nature of signal(s) modulating the main carrier: 1= A single channel containing quantized or digital information without the use of a modulating sub-carrier
 3.type of information to be transmitted: E= Telephony (including sound broadcasting)
 D= Data transmission, telemetry, telecommand

State : 8K30F1E / 8K30F1D / 8K30F7W (4Level FSK / 9600bps, Authorized Bandwidth 11.25 kHz)

Item	Mark		
Digital information rate	(R)	9600	bps
Peak frequency deviation	(D)	3.391	kHz
Signaling states	(S)	4	
Numerical factor	(K)	0.516	
Necessary Bandwidth	(Bn)	8.3	kHz

$$B_n = (R/\log_2 S) + 2x D x K$$

- 1.types of modulation of the main carrier : F= Frequency modulation
 2.nature of signal(s) modulating the main carrier: 1= A single channel containing quantized or digital information without the use of a modulating sub-carrier
 7= Two or more channels containing quantized or digital information
 3.type of information to be transmitted: E= Telephony (including sound broadcasting)
 D= Data transmission, telemetry, telecommand
 W= Combination of the above

State : 4K00F1E / 4K00F1D / 4K00F7W (4Level FSK / 4800bps, Authorized Bandwidth 6 kHz)

Item	Mark		
Digital information rate	(R)	4800	bps
Peak frequency deviation	(D)	1.55	kHz
Signaling states	(S)	4	
Numerical factor	(K)	0.516	
Necessary Bandwidth	(Bn)	4	kHz

$$B_n = (R/\log_2 S) + 2x D x K$$

- 1.types of modulation of the main carrier : F= Frequency modulation
 2.nature of signal(s) modulating the main carrier: 1= A single channel containing quantized or digital information without the use of a modulating sub-carrier
 7= Two or more channels containing quantized or digital information
 3.type of information to be transmitted: E= Telephony (including sound broadcasting)
 D= Data transmission, telemetry, telecommand
 W= Combination of the above

State : 4K00F2D (CWID, Authorized Bandwidth 6 kHz)

Item	Mark		
Maximum Modulation	(M)	0.8	kHz
Maximum Deviation	(D)	1.2	kHz
Numerical factor	(K)	1	
Necessary Bandwidth	(Bn)	4	kHz

$$B_n = (2xM) + (2x D x K)$$

- 1.types of modulation of the main carrier : F= Frequency modulation
 2.nature of signal(s) modulating the main carrier: 2= A single channel containing quantized or digital information with the
 3.type of information to be transmitted: D= Data transmission, telemetry, telecommand

10.12 99% Occupied Bandwidth

REGULATIONS	:	RSS-119 Section 5.5
TEST METHOD/GUIDE	:	RSS-Gen Section 6.6

Test Procedure

- 1 The EUT and test equipment were set up as shown on the following page.
- 2 Adjust the test instrument for the following setting:
 - RBW : 1 % to 5 % of the Necessary bandwidth
 - VBW : at least 3 times the RBW
 - Detector : Peak
 - Sweep Time : Auto
 - Trace mode : Max Hold
- 3 Allow trace to fully stabilize.
- 4 Use "Occupied Bandwidth Measurement" function to measure the 99% Occupied Bandwidth.
- 5 Modulate the transmitter with a 2.5 kHz sine wave at an input Level of 16 dB greater than that necessary to produce 50 % of rated system deviation.(Only 16K0F3E, 11K0F3E)

Measuring Equipments

No.	Equipment	Manufacture	Model No.	Serial No.	Cal. Interval	Effective period
1	Attenuator (20dB)	Aeroflex/Wenshel	66-20-34	BY4357	1Y	May. 31, 17
2	Attenuator (30dB)	Weinschel	WA-29-30-34	8923	1Y	May. 31, 17
3	Modulation Analyzer	Hewlett Packard	8901B	3403A04852	1Y	Dec. 31, 17
4	Audio Generator	Anritsu	MG443B	M70150	1Y	May. 31, 17
5	Spectrum Analyzer	Agilent	N9030A	US51350220	1Y	Feb. 28, 18
6	DC Power Supply	Daiichi denpa kogyo	GZV4000	90290931	None	None
7	DC Power Supply 2	Kikusui	PMC35-3A	LE000716	None	None
8	Digital Multi Meter	FLUKE	8846A	9642018	1Y	Sep. 30, 17
9	JIG1	Anritsu	MD6420A	6200552647	None	None
10	JIG2	Kenwood	Modem	None	None	None
11	Balance Cable	Nicoon	3D-2V	KSR00092	1Y	Mar. 31, 18
12	Coaxial Cable	Pacific custom	RG-58 C/U	AM90C04	1Y	Feb. 28, 18
13	Coaxial Cable	Suhner	SUCOFLEX104	KSR00217	1Y	May. 31, 17

Measuring Equipment Configuration

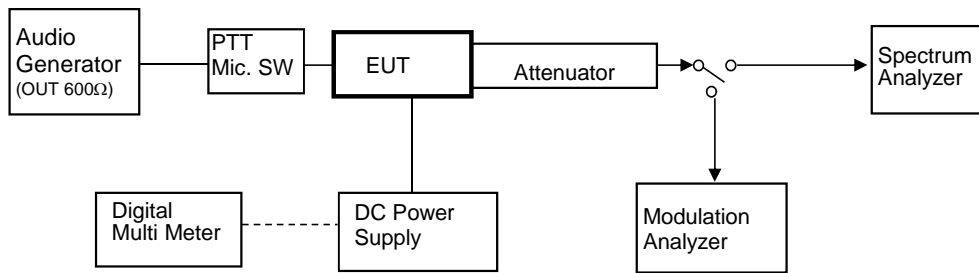

<14K4F1D Modulation Case>

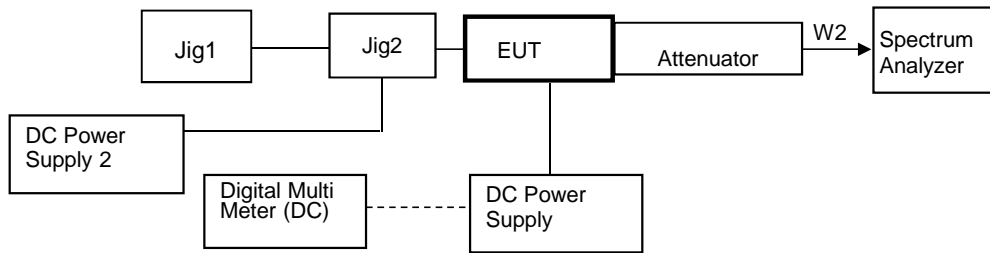

Test Results

Test date	Feb 23, 2017 and May 26, 2017
Location	Kashima No.12 Test Site
temperature	20.0 to 23.4 [degree C]
Humidity Variation	60.0 to 60.0 [%]
Atmospheric Pressure	101.0 to 100.4 [kPa]
Test Engineer	Koichi Wagatsuma

Emission Designation	Frequency (MHz)	99% Occupied Bandwidth (kHz)	Authorized bandwidth (kHz)
16K0F3E	450.05	14.755	20
	460.05	14.752	
	469.95	14.778	
14K4F1D	450.05	9.816	20
	460.05	9.780	
	469.95	9.870	
11K0F3E	450.05	9.834	11.25
	460.05	9.914	
	469.95	9.907	
8K30F1E/F1D/F7W	450.05	7.558	11.25
	460.05	7.588	
	469.95	7.595	
8K10F1E/F1D	450.05	7.944	11.25
	460.05	7.910	
	469.95	7.982	
4K00F1E / F1D / F7W	450.05	3.490	6
	460.05	3.507	
	469.95	3.516	
4K00F2D	450.05	3.328	6
	460.05	3.320	
	469.95	3.319	

Ferquency (MHz)	Emission Designation	
	16K0F3E	14K4F1D
450.05	<p>Center Freq 450.050000 MHz Center Freq: 450.050000 MHz Trig: Free Run ArglHld: 0000 Radio Stk: None Radio Device: BTS</p> <p>Center: 450.1 MHz #Res BW: 300 Hz VBW: 3 kHz Span: 50 kHz Sweep: 512.8 ms</p> <p>Occupied Bandwidth: 14.755 kHz Total Power: -1.62 dBm Transmit Freq Error: 34 Hz OBW Power: 99.00 % x dB Bandwidth: 15.36 kHz x dB</p>	<p>Center Freq 450.050000 MHz Center Freq: 450.050000 MHz Trig: Free Run ArglHld: 0000 Radio Stk: None Radio Device: BTS</p> <p>Center: 450.1 MHz #Res BW: 300 Hz VBW: 3 kHz Span: 50 kHz Sweep: 512.8 ms</p> <p>Occupied Bandwidth: 9.916 kHz Total Power: -3.64 dBm Transmit Freq Error: 32 Hz OBW Power: 99.00 % x dB Bandwidth: 11.14 kHz x dB</p>
460.05	<p>Center Freq 460.050000 MHz Center Freq: 460.050000 MHz Trig: Free Run ArglHld: 0000 Radio Stk: None Radio Device: BTS</p> <p>Center: 460.1 MHz #Res BW: 300 Hz VBW: 3 kHz Span: 50 kHz Sweep: 512.8 ms</p> <p>Occupied Bandwidth: 14.752 kHz Total Power: -1.66 dBm Transmit Freq Error: 79 Hz OBW Power: 99.00 % x dB Bandwidth: 15.36 kHz x dB</p>	<p>Center Freq 460.050000 MHz Center Freq: 460.050000 MHz Trig: Free Run ArglHld: 0000 Radio Stk: None Radio Device: BTS</p> <p>Center: 460.1 MHz #Res BW: 300 Hz VBW: 3 kHz Span: 50 kHz Sweep: 512.8 ms</p> <p>Occupied Bandwidth: 9.780 kHz Total Power: -3.71 dBm Transmit Freq Error: 41 Hz OBW Power: 99.00 % x dB Bandwidth: 11.09 kHz x dB</p>
469.95	<p>Center Freq 469.950000 MHz Center Freq: 469.950000 MHz Trig: Free Run ArglHld: 0000 Radio Stk: None Radio Device: BTS</p> <p>Center: 470 MHz #Res BW: 300 Hz VBW: 3 kHz Span: 50 kHz Sweep: 512.8 ms</p> <p>Occupied Bandwidth: 14.778 kHz Total Power: -1.75 dBm Transmit Freq Error: 94 Hz OBW Power: 99.00 % x dB Bandwidth: 15.37 kHz x dB</p>	<p>Center Freq 469.950000 MHz Center Freq: 469.950000 MHz Trig: Free Run ArglHld: 0000 Radio Stk: None Radio Device: BTS</p> <p>Center: 470 MHz #Res BW: 300 Hz VBW: 3 kHz Span: 50 kHz Sweep: 512.8 ms</p> <p>Occupied Bandwidth: 9.870 kHz Total Power: -3.62 dBm Transmit Freq Error: 43 Hz OBW Power: 99.00 % x dB Bandwidth: 11.13 kHz x dB</p>

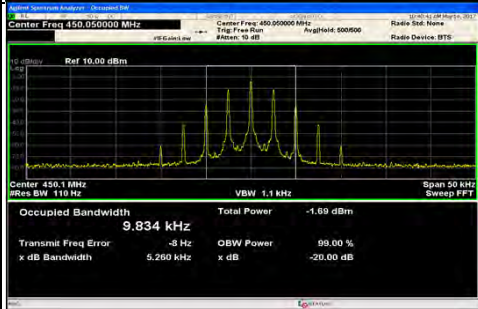
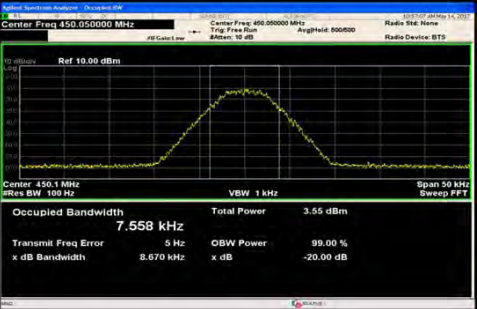
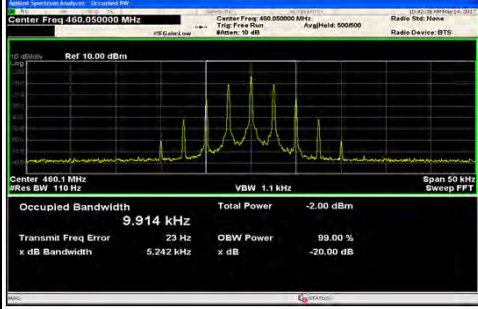
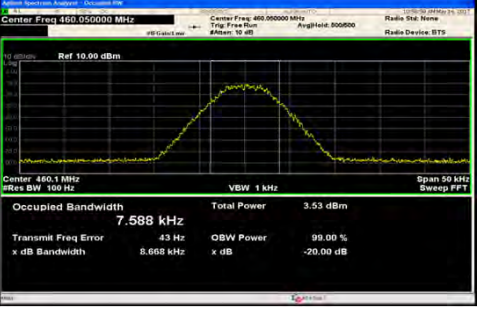
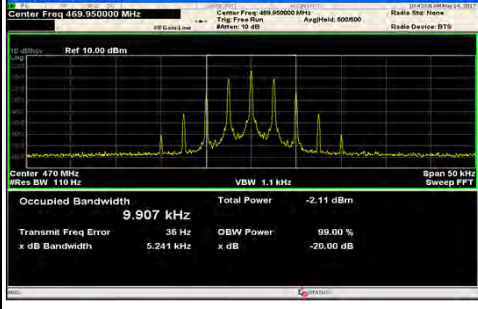
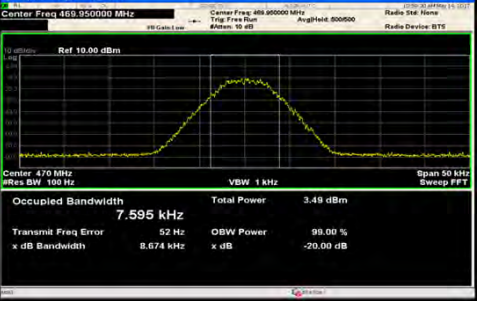
Ferquency (MHz)	Emission Designation	
	11K0F3E	8K30F1E/F1D/F7W
450.05	 <p>Center Freq 450.050000 MHz Res BW 110 Hz VBW 1.1 kHz Span 50 kHz Sweep FFT</p> <p>Occupied Bandwidth 9.834 kHz Total Power -1.69 dBm Transmit Freq Error -8 Hz x dB Bandwidth 5.260 kHz</p> <p>OBW Power 99.00 % x dB -20.00 dB</p>	 <p>Center Freq 450.050000 MHz Res BW 100 Hz VBW 1 kHz Span 50 kHz Sweep FFT</p> <p>Occupied Bandwidth 7.558 kHz Total Power -3.55 dBm Transmit Freq Error 5 Hz x dB Bandwidth 8.670 kHz</p> <p>OBW Power 99.00 % x dB -20.00 dB</p>
460.05	 <p>Center Freq 460.050000 MHz Res BW 110 Hz VBW 1.1 kHz Span 50 kHz Sweep FFT</p> <p>Occupied Bandwidth 9.914 kHz Total Power -2.00 dBm Transmit Freq Error 23 Hz x dB Bandwidth 5.242 kHz</p> <p>OBW Power 99.00 % x dB -20.00 dB</p>	 <p>Center Freq 460.050000 MHz Res BW 100 Hz VBW 1 kHz Span 50 kHz Sweep FFT</p> <p>Occupied Bandwidth 7.588 kHz Total Power -3.53 dBm Transmit Freq Error 43 Hz x dB Bandwidth 8.668 kHz</p> <p>OBW Power 99.00 % x dB -20.00 dB</p>
469.95	 <p>Center Freq 469.950000 MHz Res BW 110 Hz VBW 1.1 kHz Span 50 kHz Sweep FFT</p> <p>Occupied Bandwidth 9.907 kHz Total Power -2.11 dBm Transmit Freq Error 36 Hz x dB Bandwidth 5.241 kHz</p> <p>OBW Power 99.00 % x dB -20.00 dB</p>	 <p>Center Freq 469.950000 MHz Res BW 100 Hz VBW 1 kHz Span 50 kHz Sweep FFT</p> <p>Occupied Bandwidth 7.595 kHz Total Power -3.49 dBm Transmit Freq Error 52 Hz x dB Bandwidth 8.674 kHz</p> <p>OBW Power 99.00 % x dB -20.00 dB</p>

Ferquency (MHz)	Emission Designation	
	8K10F1E/F1D	4K00F1E / F1D / F7W
450.05	<p>Center Freq 450.050000 MHz Center Freq 450.050000 MHz Trig Free Run AltHeld: 000000 Radio Stk: None Radio Device: BTS</p> <p>Center 450.1 MHz #Res BW 100 Hz VBW 1 kHz Span 50 kHz Sweep</p> <p>Occupied Bandwidth 7.944 kHz Total Power 5.63 dBm Transmit Freq Error -67 Hz x dB Bandwidth 8.402 kHz OBW Power 99.00 % x dB -20.00 dB</p>	<p>Center Freq 450.050000 MHz Center Freq 450.050000 MHz Trig Free Run AltHeld: 000000 Radio Stk: None Radio Device: BTS</p> <p>Center 450.1 MHz #Res BW 100 Hz VBW 1 kHz Span 50 kHz Sweep FFT</p> <p>Occupied Bandwidth 3.490 kHz Total Power 4.16 dBm Transmit Freq Error -31 Hz x dB Bandwidth 4.178 kHz OBW Power 99.00 % x dB -20.00 dB</p>
460.05	<p>Center Freq 460.050000 MHz Center Freq 460.050000 MHz Trig Free Run AltHeld: 000000 Radio Stk: None Radio Device: BTS</p> <p>Center 460.1 MHz #Res BW 100 Hz VBW 1 kHz Span 50 kHz Sweep FFT</p> <p>Occupied Bandwidth 7.910 kHz Total Power 5.66 dBm Transmit Freq Error 103 Hz x dB Bandwidth 8.215 kHz OBW Power 99.00 % x dB -20.00 dB</p>	<p>Center Freq 460.050000 MHz Center Freq 460.050000 MHz Trig Free Run AltHeld: 000000 Radio Stk: None Radio Device: BTS</p> <p>Center 460.1 MHz #Res BW 100 Hz VBW 1 kHz Span 50 kHz Sweep FFT</p> <p>Occupied Bandwidth 3.507 kHz Total Power 4.20 dBm Transmit Freq Error -10 Hz x dB Bandwidth 4.209 kHz OBW Power 99.00 % x dB -20.00 dB</p>
469.95	<p>Center Freq 469.950000 MHz Center Freq 469.950000 MHz Trig Free Run AltHeld: 000000 Radio Stk: None Radio Device: BTS</p> <p>Center 470 MHz #Res BW 100 Hz VBW 1 kHz Span 50 kHz Sweep</p> <p>Occupied Bandwidth 7.982 kHz Total Power 5.66 dBm Transmit Freq Error -11 Hz x dB Bandwidth 8.509 kHz OBW Power 99.00 % x dB -20.00 dB</p>	<p>Center Freq 469.950000 MHz Center Freq 469.950000 MHz Trig Free Run AltHeld: 000000 Radio Stk: None Radio Device: BTS</p> <p>Center 470 MHz #Res BW 100 Hz VBW 1 kHz Span 50 kHz Sweep FFT</p> <p>Occupied Bandwidth 3.516 kHz Total Power 4.16 dBm Transmit Freq Error 1 Hz x dB Bandwidth 4.204 kHz OBW Power 99.00 % x dB -20.00 dB</p>

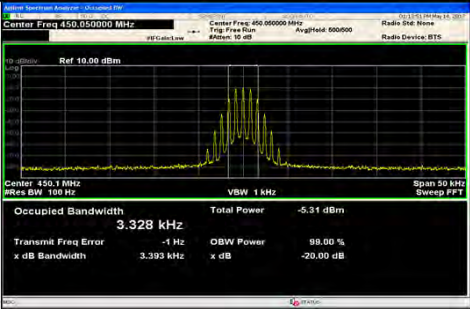
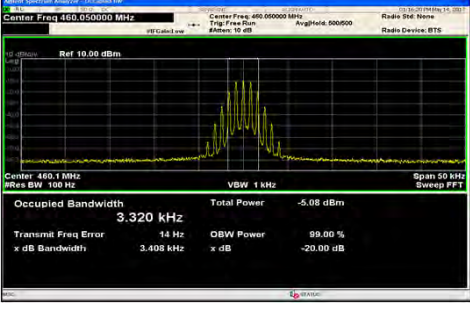
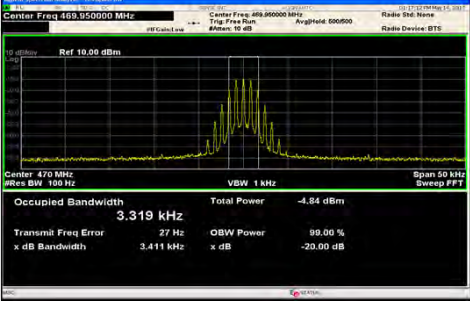
Ferquency (MHz)	Emission Designation	
450.05	<p style="text-align: center;">4K00F2D</p>  <p>Center Freq 450.050000 MHz Center Freq: 450.050000 MHz Trig: Free Run Avg Hold: 500000 Radio Dev: BTS</p> <p>Center: 450.1 MHz Res BW: 100 Hz VBW: 1 kHz Span: 50 kHz Sweep: FFT</p> <p>Occupied Bandwidth: 3.328 kHz Total Power: -5.31 dBm Transmit Freq Error: -1 Hz OBW Power: 99.00 % x dB Bandwidth: 3.393 kHz x dB: -20.00 dB</p>	
460.05	 <p>Center Freq 460.050000 MHz Center Freq: 460.050000 MHz Trig: Free Run Avg Hold: 500000 Radio Dev: BTS</p> <p>Center: 460.1 MHz Res BW: 100 Hz VBW: 1 kHz Span: 50 kHz Sweep: FFT</p> <p>Occupied Bandwidth: 3.320 kHz Total Power: -5.08 dBm Transmit Freq Error: 44 Hz OBW Power: 99.00 % x dB Bandwidth: 3.408 kHz x dB: -20.00 dB</p>	
469.95	 <p>Center Freq 469.950000 MHz Center Freq: 469.950000 MHz Trig: Free Run Avg Hold: 500000 Radio Dev: BTS</p> <p>Center: 470 MHz Res BW: 100 Hz VBW: 1 kHz Span: 50 kHz Sweep: FFT</p> <p>Occupied Bandwidth: 3.319 kHz Total Power: -4.84 dBm Transmit Freq Error: 27 Hz OBW Power: 99.00 % x dB Bandwidth: 3.411 kHz x dB: -20.00 dB</p>	