



TEST REPORT

REPORT NUMBER : ANKK-104323
APPLICANT : KENWOOD CORPORATION
MODEL NUMBER : TS-480HX
FCC ID : K4433101210
REGULATION : FCC Part15B – Scanning Receiver
: FCC Part15B Class B
: Canada ICES-003 Class B

Conducted Emission Test
Radiated Emission Test
Antenna Power Conducted Test
38dB Rection Test



NVLAP accreditation is valid for FCC Part15 (Digital Devices), CISPR22 and AS/NZS CISPR22. NVLAP accreditation does not cover ICES-003. (Antenna Power Conducted Test and 38dB Rejection Test)

Akzo Nobel K. K.
EMC Division
Kashima Site

1, Oaza Sunayama, Hasaki-machi, Kashima-gun
Ibaraki-ken, 314-0255 Japan
Tel.: +81 479 40 1097 Fax.: +81 479 46 1788

TABLE OF CONTENTS

	Page
ABBREVIATIONS.....	3
SECTION 1. TEST CERTIFICATION	4
SECTION 2. CONCLUSION.....	5
SECTION 3. EQUIPMENT UNDER TEST	6
SECTION 4. SUPPORT EQUIPMENT USED	8
SECTION 5. CABLE (S) USED	9
SECTION 6. CONSTRUCTION OF EQUIPMENT	10
SECTION 7. OPERATING CONDITIONS	12
SECTION 8. TEST PROCEDURE(S)	13
SECTION 9. EVALUATION OF TEST RESULTS.....	20
SECTION 10. INSTRUMENTS USED FOR FINAL TEST	46
SECTION 11. MEASUREMENT UNCERTAINTY	48
SECTION 12. DESCRIPTION OF TEST LABORATORY	49

ABBREVIATIONS

LISN = Line Impedance Stabilization Network

AMN = Artificial Mains Network

ISN = Impedance Stabilization Network

CDN = Coupling Decoupling Network

ANT = Antenna

BBA = Broadband Antenna

DIP = Dipole Antenna

AMP = Amplifier

ATT = Attenuator

EUT = Equipment Under Test

AE = Associated Equipment

Q-P = Quasi-peak

AVG = Average

RX = Receive

SECTION 1. TEST CERTIFICATION**APPLICANT INFORMATION**

Company	: KENWOOD CORPORATION
Address	: 1-16-2, Hakusan, Midori-ku, Yokohama-shi, Kanagawa, 226-8525 Japan
Telephone number	: +81 45 939 6254
Fax number	: +81 45 939 7093

DESCRIPTION OF TEST ITEM

Kind of equipment	: HF / 50MHz All Mode Transceiver
Condition of equipment	: Prototype
Category	: Scanning Receiver & Peripherals
Trademark	: KENWOOD
FCC ID	: K4433101210
Model number	: TS-480HX
Serial number	: None

TEST PERFORMED

Location	: Kashima No. 1 Test Site (FCC Reg. :90433)
EUT received	: September 1, 2004
Test started	: November 10, 2004
Test completed	: November 18, 2004
Purpose of test	: FCC Docket 87-389 and Canadian Interference-Causing Equipment Regulations
Regulation	: FCC Part15B - Scanning Receiver FCC Part15B Class B - Peripherals and Canada ICES-003 Class B
Test setup	: ANSI C63.4-2003

Report issue date : November 24, 2004

Test engineer : Kazuo Masuda



Report approved by : Takeshi Yamanaka
[Site Manager]

Note

- a. The test result of this report is effective for equipment under test itself and under the test configuration described on the report.
- b. This test report does not assure that whether the test result taken in other testing laboratory is compatible or reproducible to the test result on this report or not.
- c. This test report shall not be reproduced except in full, without issuer's permission.

SECTION 2. CONCLUSION

This test report clearly shows that the EUT is in compliance with the FCC Part15B (– Scanning Receiver) and FCC Part15B Class B (– Peripheral with Canada ICES-003 Class B) specification.

Traceability to national standards of test result is achieved by means of calibration traceability to national standards.

The minimum margins to the limits are as follows:

Conducted Voltages on Mains Port

Tuned Point 54.0MHz (PSU1) 5.4 dB at 2.8547 MHz

Radiated Electric Field

Tuned Point 54.0MHz 7.1 dB at 381.28 MHz

Conducted Power on Antenna Port

Tuned Point 54.0MHz (ANT1) 24.4 dB at 381.29 MHz

38dB Rejection Test (15.121(b))

VFO Scan

No frequency of response was detected.

– Passed –

Note : See Section 9 for details.

SECTION 3. EQUIPMENT UNDER TEST

The equipment under test (EUT) consisted of the following equipment.
Indication in the following left side column corresponds to Section 6.

Symbol	Item	Model No.	Serial No.	FCC ID / DoC	Manufacturer	Remarks
A)	All Mode Transceiver	TS-480HX	None	K4433101210	KENWOOD	EUT
B)	Remote Control Panel	None	None	N.A.	KENWOOD	EUT
C)	Microphone	None	None	N.A.	KENWOOD	EUT
D)	Headphone	HS-5	None	N.A.	KENWOOD	Option
E)	Speaker	SP-50B	None	N.A.	KENWOOD	Option
F)	DC Power Supply Unit	PS-53	50400013	N.A.	KENWOOD	Option
G)	DC Power Supply Unit	PS-53	50400025	N.A.	KENWOOD	Option

Power ratings of EUT : DC 13.8V × 2, 41.0A (Max)

3.1 Overview of EUT :

Frequency Ranges : 0.030 – 60.000 MHz
Receiver Type : Double Conversion Super-heterodyne
Triple Conversion Super-heterodyne (FM mode only)
Mode of Operation : J3E, A1A, A3E, F1D, F3E

3.2 Port(s)/Connector(s) :

Port name	Connector type	Connector pin	Remarks
PANEL	RJ11	6 pin	
MIC	RJ45	8pin	
EXP.SP	Mini jack (3.5φ)	1pin	
COM	D-sub	9pin	
ANT1 / ANT2	M type	1pin	
REMOTE	DIN	8pin	
DATA	DIN	6pin	
AT	wire to wire connector	5pin	

3.3 Oscillator(s)/Crystal(s) :

Oscillator	Operating frequency	Board name	Remarks
12.288 MHz	98.304 MHz	TX/RXunit (DSP)	
22.1184 MHz	22.1184 MHz	TX/RXunit (CPU)	
15.6 MHz	31.2 MHz	TX/RXunit	
	62.4 MHz	TX/RXunit	
11.0592 MHz	11.0592 MHz	Panel (CPU)	
11.0592 MHz	11.0592 MHz	Option VGS1 (CPU)	

3.4 Operation Ranges :

RX Frequency	0.030000	to	1.705000 MHz
	1.705000	to	24.500000 MHz
	24.500000	to	30.000000 MHz
	30.000000	to	50.000000 MHz
	50.000000	to	60.000000 MHz
1st LO	73.125000	to	74.800000 MHz
	74.800000	to	97.595000 MHz
	97.595000	to	103.095000 MHz
	103.095000	to	123.095000 MHz
	123.095000	to	133.095000 MHz

3.5 Intermediate Frequencies :

1st	:	73.095 MHz (Upper)
2nd	:	10.695 MHz (Lower)
3rd	:	455 kHz (Upper)

SECTION 4. SUPPORT EQUIPMENT USED

The EUT was supported by the following equipment during the test. Indication in the following left side column corresponds to Section 6.

Symbol	Item	Model No.	Serial No.	FCC ID / DoC	Manufacturer	Remarks
H)	Computer	Dimension2100 MCM	3V5W41S	DoC	Dell Computer	
I)	CRT Display	E551	044NEK	DoC	Dell Computer	
J)	Keyboard	RT7D00	054EXM	AQ6- 7D0080C0B	Dell Computer	
K)	Mouse	M-S34	LNA13038374	DZL211029	Dell Computer	
L)	Printer	C3941A	JPCD204480	B94C3941A	Hewlett Packard	

DoC : Device was tested and authorized under a Declaration of Conformity to the applicable FCC rules.

SECTION 5. CABLE (S) USED

The following cable(s) was used for the test.

Indication number in the following left side column corresponds to Section 6.

Number	Name	Length	Shield	Connector	Core
1)	Panel cable	2.00 m	None	Plastic	
2)	Extension Panel cable	4.00 m	None	Plastic	Fixed × 1
3)	Mic cable	1.40 m	None	Plastic	
4)	Extension Mic cable	4.00 m	None	Plastic	Fixed × 1
5)	Headphone cable	2.00 m	None	Metal	
6)	Speaker cable	2.60 m	None	Metal	
7)	RS-232C	1.00 m	Yes	Metal	
8)	Antenna cable	0.20 m	Yes	Metal	
9)	Antenna cable	0.20 m	Yes	Metal	
10)	CRT Display cable	1.50 m	Yes	Metal	Fixed × 1
11)	Keyboard cable	2.00 m	Yes	Metal	
12)	Mouse cable	1.80 m	Yes	Metal	
13)	Printer cable	2.50 m	Yes	Metal	
14)	Power cord for EUT (DC)	7.00 m	None		
15)	Power cord for EUT (DC)	7.00 m	None		
16)	Power cord for DC Supply Unit (AC)	1.80 m	None		
17)	Power cord for DC Supply Unit (AC)	1.80 m	None		
18)	Power cable for Computer	2.30 m	None		
19)	Power cable for CRT Display	2.10 m	None		
20)	Power cable for Printer	1.80 m	None		

Note : a. No.2 and No.4 cables are supplied together with EUT by the applicant.

SECTION 6. CONSTRUCTION OF EQUIPMENT

The construction of EUT during the test was as follows.

**6.1 Conducted Voltages on Mains Port
Radiated Electric Field
Conducted Power on Antenna Port**

System configuration

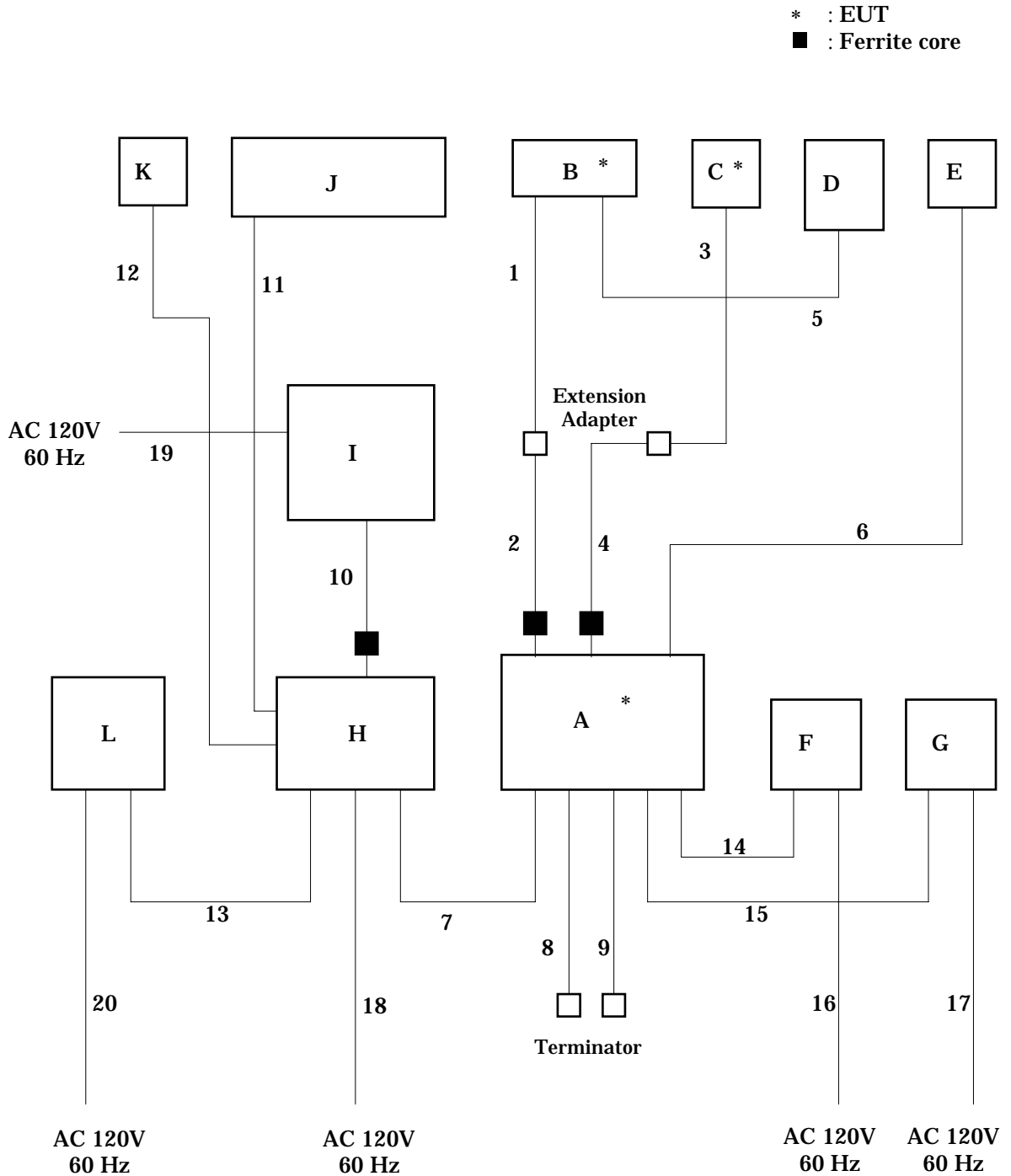

Symbols or numbers assigned to equipment or cables on this diagram are corresponded to the symbols or numbers assigned to equipment or cables on tables in Sections 3 to 5.

6.2 38dB Rejection

System configuration

* : EUT

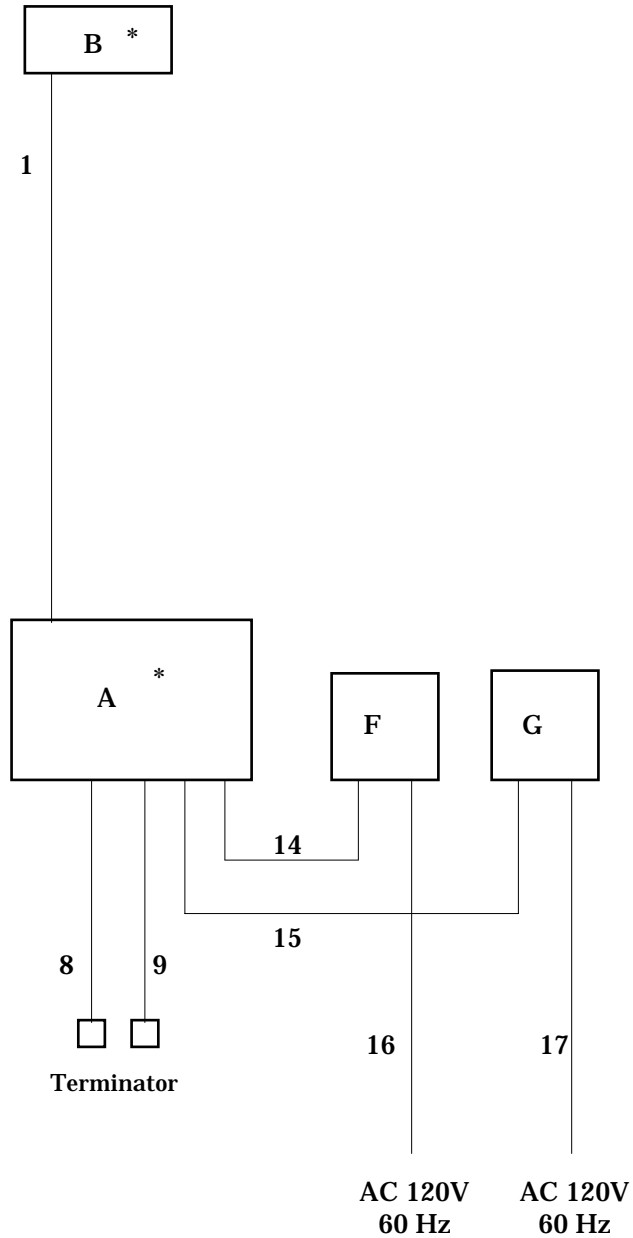

Symbols or numbers assigned to equipment or cables on this diagram are corresponded to the symbols or numbers assigned to equipment or cables on tables in Sections 3 to 5.

SECTION 7. OPERATING CONDITIONS

The EUT was operated under the following conditions during the test.

7.1 Operating condition

The test was carried out under Tuned Point mode and VFO Scan mode.
EUT was examined in the operating conditions that had maximum disturbances.

7.2 Operating flow

Following operations were performed continuously.

7.2.1 Tuned Point mode

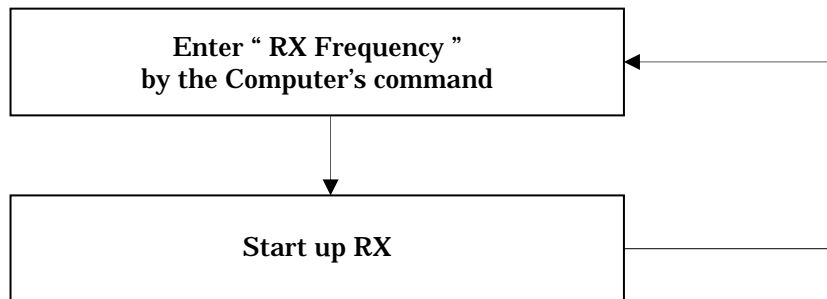

7.2.2 VFO Scan mode

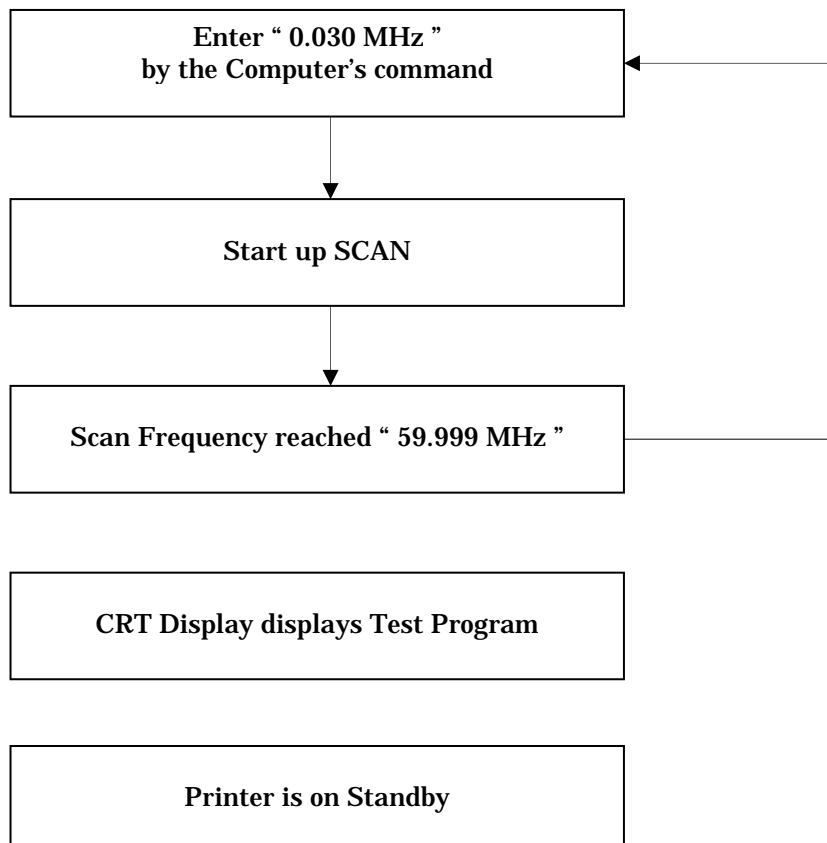

SECTION 8. TEST PROCEDURE(S)

Test was carried out under the following conditions.

Test was carried out with no deviations from standards and test methods.

Subject	Scanned frequency
Conducted Voltages on Mains Port	0.15 – 30 MHz
Radiated Electric Field	30 – 2000 MHz

Schema for the conducted voltages on mains port measurement

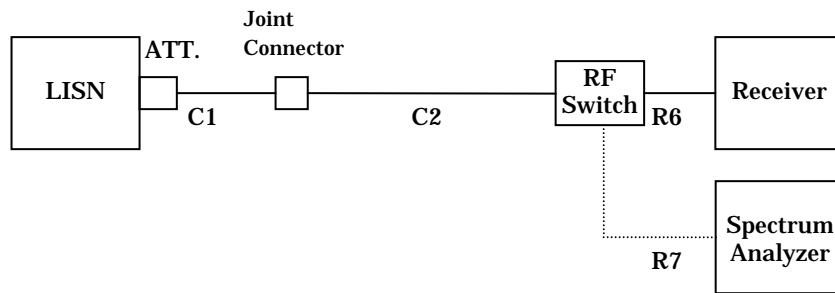

Schema for the radiated electric field measurement

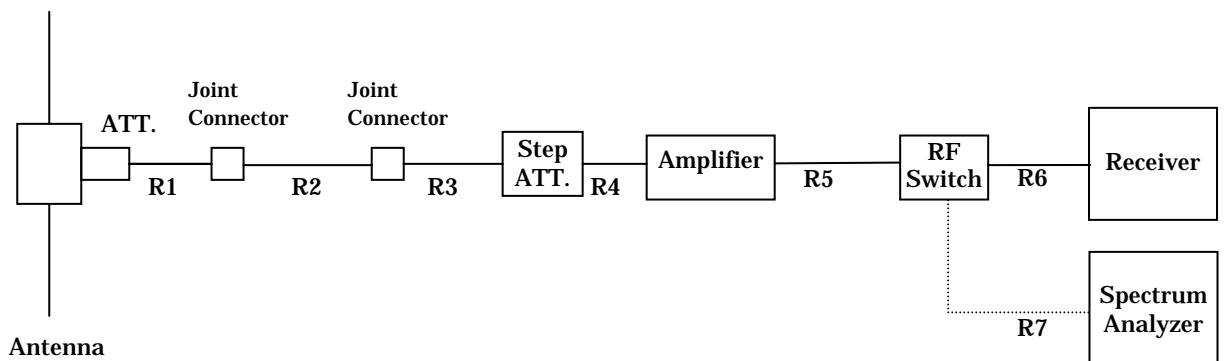

Above 1GHz

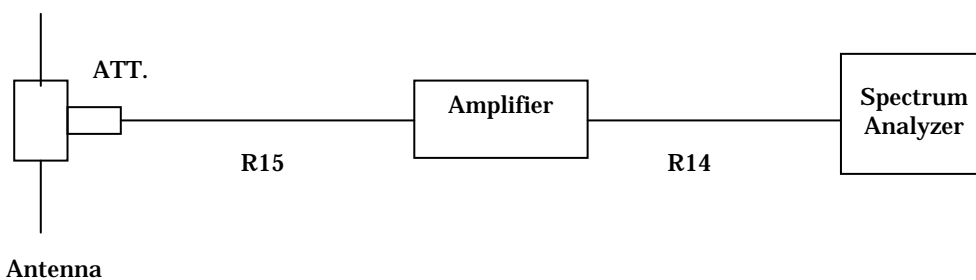

Test was carried out under the following conditions.

Test was carried out with no deviations from standards and test methods.

Subject	Scanned frequency
Conducted Power on Antenna Port	30 – 1000 MHz
38dB Rejection	0.030 – 60 MHz

Schema for the conducted power on antenna port measurement

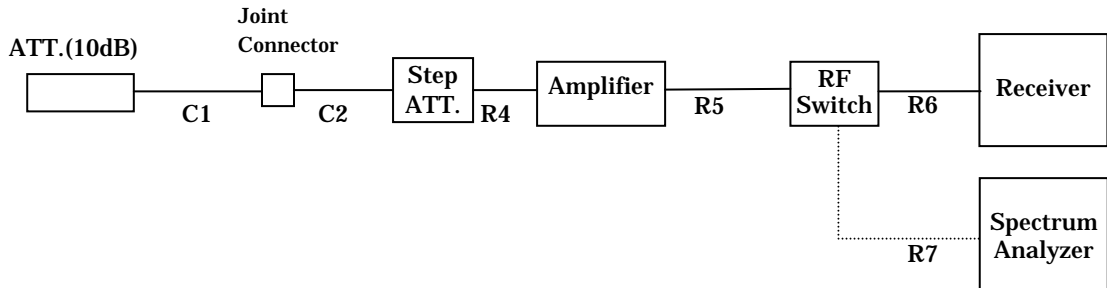

Schema for the 38dB rejection measurement



Summary ;

8.1 Conducted Voltages on Mains Port

8.1.1 Equipment Setup

System configuration and Equipment setup are shown on Section 6 and Annex A.

8.1.1.1 Tabletop Equipment

EUT is placed on the wooden table, the top of which is 0.8 meter above the metal ground plane.

8.1.1.2 Interconnecting Cables

Excess part of the interconnecting cables longer than 1 meter are bundled in the center. Cables that hang closer than 40 cm to the ground plane is folded back and forth forming bundle 30 to 40 cm long, hanging approx, in the middle between ground plane and table.

8.1.1.3 AC Power Cable

AC power cable for EUT is connected to one LISN which is placed on the ground plane. The LISN is placed in 80 cm from the nearest part of EUT chassis. The excess power cable is bundled in the center, or shortened to appropriate length. AC cables except from the EUT are connected second LISN.

8.1.2 Measuring Instruments

Measuring instruments list and their calibration schedule are shown on Section 10. The brief description are as follows;

8.1.2.1 Spectrum Analyzer

The Spectrum analyzer is used for preliminary measurement.

8.1.2.2 EMI Test Receiver

The Quasi-peak detector (IF bandwidth : 10 kHz) and average detector (IF bandwidth : 10 kHz) built in test receiver is used for final measurement. The test receiver is complied with the specification of the CISPR publication 16.

8.1.2.3 LISN

Two 50 μ H//50 Ω LISN are used. The chassis of the LISN is bonded to the ground plane by the copper blade. One LISN is connected to the EUT. Other LISN (2nd LISN) is connected to the support equipment. The signal output of the 2nd LISN is terminated with a 50 Ω termination.

8.1.3 Test Procedure

8.1.3.1 Preliminary Measurement

EUT is tested on all operating conditions.

The spectrum analyzer is controlled by the computer program to sweep the frequency range to be measured, then spectrum chart are plotted out to find the worst emission conditions in operating mode and/or configuration decision for the final test.

All leads other than safety ground are tested.

8.1.3.2 Final Measurement

The EUT is operated in the worst emission condition found by the preliminary test. The equipment and cables are arranged or manipulated within the range of the test standard in the above condition.

At least six highest spectrum are measured in quasi-peak and average (if necessary) using the test receiver.

8.2 Radiated Electric Field

8.2.1 Equipment Setup

System configuration and Equipment setup are shown on Section 6 and Annex A.

8.2.1.1 Tabletop Equipment

EUT is placed on the wooden table, the top of which is 0.8meter above the metal ground plane (turntable).

8.2.1.2 Interconnecting Cables

Excess part of the interconnecting cables longer than 1 meter are bundled in the center. Cables that hang closer than 40 cm to the ground plane is folded back and forth forming bundle 30 to 40 cm long, hanging approx, in the middle between ground plane and table.

8.2.2 Measuring Instruments

Measuring instruments list and their calibration schedule are shown on Section 10. The brief description are as follows;

8.2.2.1 Antennas

The broadband Tri-log antenna is used for measurement on the frequency range 30 – 1000 MHz.

The Double ridged guide antenna is used for frequency higher than 1000 MHz.

If uncertain result was obtained, the broadband antenna is replaced by the half wave length dipole, then measurement is carried out over again.

8.2.2.2 Pre-amplifier

The broadband pre-amplifier is used for Radiated Electric Field measurement.

The signal to noise ratio is improved by using pre-amplifier.

8.2.2.3 Spectrum Analyzer

The spectrum analyzer is used for preliminary measurement of frequency range 30 – 1000 MHz, and also used for final measurement of higher than 1000 MHz (Resolution bandwidth : 1 MHz).

8.2.2.4 EMI Test Receiver

The Quasi-peak detector (IF bandwidth : 120 kHz) built in test receiver is used for final measurement of the frequency 30 – 1000 MHz.

The test receiver is complied with the specification of the CISPR publication 16.

8.2.2.5 Turntable

The turntable is capable for EUT weight and rotatable 0 to 360 degree horizontally by remote control in the test room.

8.2.2.6 Antenna Mast

The antenna mast is attachable to all antennas described on clause 8.2.2.1 and antenna height is adjustable 1 to 4 meters continuously by remote control at the test room, and antenna polarization is also changed by the remote control.

8.2.3 Test Procedure

8.2.3.1 Preliminary Measurement

EUT is tested on all operating conditions.

The spectrum analyzer is set max-hold mode and swept during turntable was rotated 0 to 360 degree. Then spectrum chart are plotted out to find the worst emission conditions in configuration, operating mode, or ambient noise notation.

8.2.3.2 Final Measurement

The EUT operated in the worst emission condition found by the preliminary test.

The turntable azimuth (EUT direction) and antenna height are adjusted the position so that maximum field strength is obtained for each frequency spectrum to be measured. The equipment and cables are arranged or manipulated within the range of the test standard in the above condition.

When the uncertain result was obtained, the measurement is retried by using the half wave dipole antenna instead of the broadband antenna.

8.3 Conducted Power on Antenna Port

8.3.1 Equipment Setup

System configuration and Equipment setup are shown on Section 6 and Annex A.

8.3.1.1 Tabletop Equipment

EUT is placed on the wooden table, the top of which is 0.8 meter above the metal ground plane.

8.3.1.2 Interconnecting Cables

Excess part of the interconnecting cables longer than 1 meter are bundled in the center. Cables that hang closer than 40 cm to the ground plane is folded back and forth forming bundle 30 to 40 cm long, hanging approx, in the middle between ground plane and table.

8.3.2 Measuring Instruments

Measuring instruments list and their calibration schedule are shown on Section 10. The brief description are as follows;

8.3.2.1 Spectrum Analyzer

The Spectrum analyzer is used for preliminary measurement.

8.3.2.2 EMI Test Receiver

The Quasi-peak detector (IF bandwidth : 120 kHz) built in test receiver is used for final measurement of the frequency 30 – 1000 MHz.

The test receiver is complied with the specification of the CISPR publication 16.

8.3.3 Test Procedure

8.3.3.1 Preliminary Measurement

EUT is tested on all operating conditions.

The spectrum analyzer is controlled by the computer program to sweep the frequency range to be measured, then spectrum chart are plotted out to find the worst emission conditions in operating mode and/or configuration decision for the final test.

8.3.3.2 Final Measurement

The EUT is operated in the worst emission condition found by the preliminary test.

The equipment and cables are arranged or manipulated within the range of the test standard in the above condition.

At least six highest spectrum are measured in quasi-peak using the test receiver.

8.4 38dB Rejection

8.4.1 Equipment Setup

System configuration and Equipment setup are shown on Section 6 and Annex A.

8.4.1.1 Tabletop Equipment

EUT is placed on the wooden table, the top of which is 0.8 meter above the metal ground plane.

8.4.2 Measuring Instruments

Measuring instruments list and their calibration schedule are shown on Section 10. The brief description is as follows;

8.4.3 Test Procedure

8.4.3.1 Preliminary Measurement

The Signal Generator conditions :

Output level = 66 dBuV.

Modulation = Frequency modulated to 1 kHz tone at 3 kHz peak deviation.

Frequency Points = 824.040 MHz, 836.505 MHz, 848.970 MHz

869.040 MHz, 881.505 MHz, 893.970 MHz

(The Cellular Radiotelephone Service mobile and base frequency bands)

The EUT condition :

Scanning Frequency = 0.030 MHz – 59.999 MHz (5 kHz Step).

Scan stopped point, was the detected frequency.

8.4.3.2 Final Measurement

Injected 12dB SINAD Reading (SG RF Output)

The EUT condition :

Frequency = Scan stopped point

The Signal Generator condition :

Frequency = Cellular point

Detected 12dB SINAD Reading (SG RF Output)

The EUT condition :

Frequency = Scan stopped point

The Signal Generator condition :

Frequency = Scan stopped point

Under the requirements of Section 15.121(b) of the Rule.

Injected 12dB SINAD Reading – Detected 12dB SINAD Reading = 38 dB or more.

SECTION 9. EVALUATION OF TEST RESULTS

9.1 Conducted Voltages on Mains Port

9.1.1 Tuned Point 1.705 MHz mode (PSU1)

Akzo Nobel K. K.
Kashima No.1 Test Site
Conducted Voltages on Mains Port

APPLICANT : Kenwood Corporation
 EUT NAME : HF / 50MHz All Mode Transceiver
 MODEL NO. : TS-480HX
 SERIAL NO. : None
 TEST MODE : Tuned Point 1.705MHz (PSU1)
 POWER SOURCE : DC13.8V (AC120V/60Hz)
 DATE TESTED : Nov 10 2004
 FILE NO. : ANKK-104323
 REGULATION : FCC Part15B Class B
 TEST METHOD : ANSI C63.4-2003
 TEMPERATURE : 21.0 [degC]
 HUMIDITY : 51.0 [%]
 NOTE :

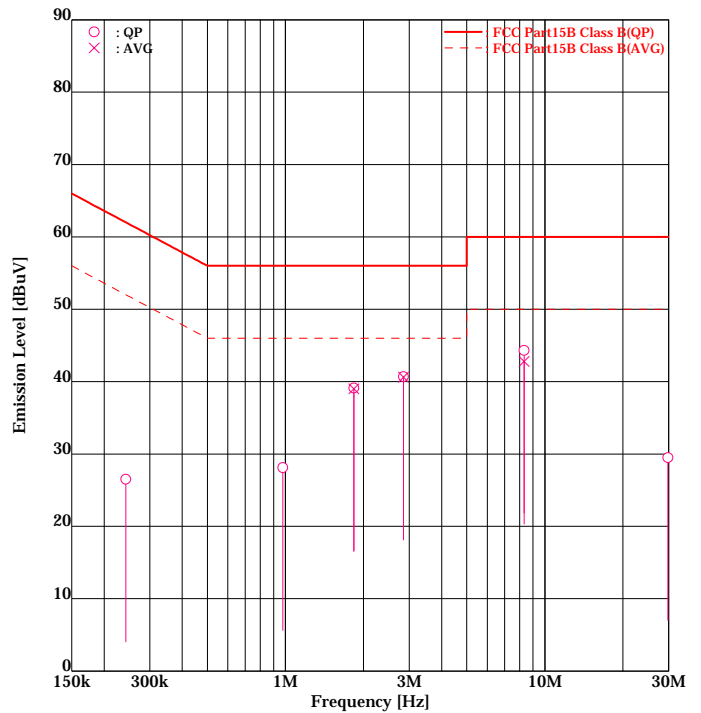

ENGINEER : Kazuo Masuda

FREQUENCY [No]	MODE [MHz]		READING [dBuV]		FACTOR [dB]		EMISSION [dBuV]		LIMIT [dBuV]	MARGIN [dB]	
			Line1	Line2	Line1	Line2	Line1	Line2		Line1	Line2
1	0.2426	QP	20.9	20.5	5.6	5.5	26.5	26.0	62.0	35.5	36.0
2	0.9777	QP	22.5	21.5	5.6	5.6	28.1	27.1	56.0	27.9	28.9
3	1.8360	QP	<u>33.4</u>	33.4	5.7	5.7	<u>39.1</u>	39.1	56.0	<u>16.9</u>	16.9
4	1.8360	AVG	<u>33.3</u>	33.2	5.7	5.7	<u>39.0</u>	38.9	46.0	<u>7.0</u>	7.1
5	2.8527	QP	<u>34.9</u>	35.0	5.8	5.7	<u>40.7</u>	40.7	56.0	<u>15.3</u>	15.3
6	2.8527	AVG	34.7	<u>34.9</u>	5.8	5.7	40.5	<u>40.6</u>	46.0	5.5	<u>5.4</u>
7	8.3194	QP	<u>38.1</u>	37.9	6.2	6.2	<u>44.3</u>	44.1	60.0	<u>15.7</u>	15.9
8	8.3194	AVG	<u>36.6</u>	36.5	6.2	6.2	<u>42.8</u>	42.7	50.0	<u>7.2</u>	7.3
9	29.7924	QP	21.2	21.9	6.9	7.6	28.1	29.5	60.0	31.9	30.5

Higher six points are underlined.

Other frequencies : Below the FCC Part15B Class B limit

Emission Level = Read + Factor(LISN,Pad,Cable)

9.1.2 Tuned Point 1.705 MHz mode (PSU2)

Akzo Nobel K. K.
Kashima No.1 Test Site
Conducted Voltages on Mains Port

APPLICANT : Kenwood Corporation
 EUT NAME : HF / 50MHz All Mode Transceiver
 MODEL NO. : TS-480HX
 SERIAL NO. : None
 TEST MODE : Tuned Point 1.705MHz (PSU2)
 POWER SOURCE : DC13.8V (AC120V/60Hz)
 DATE TESTED : Nov 10 2004
 FILE NO. : ANKK-104323
 REGULATION : FCC Part15B Class B
 TEST METHOD : ANSI C63.4-2003
 TEMPERATURE : 21.0 [degC]
 HUMIDITY : 51.0 [%]
 NOTE :

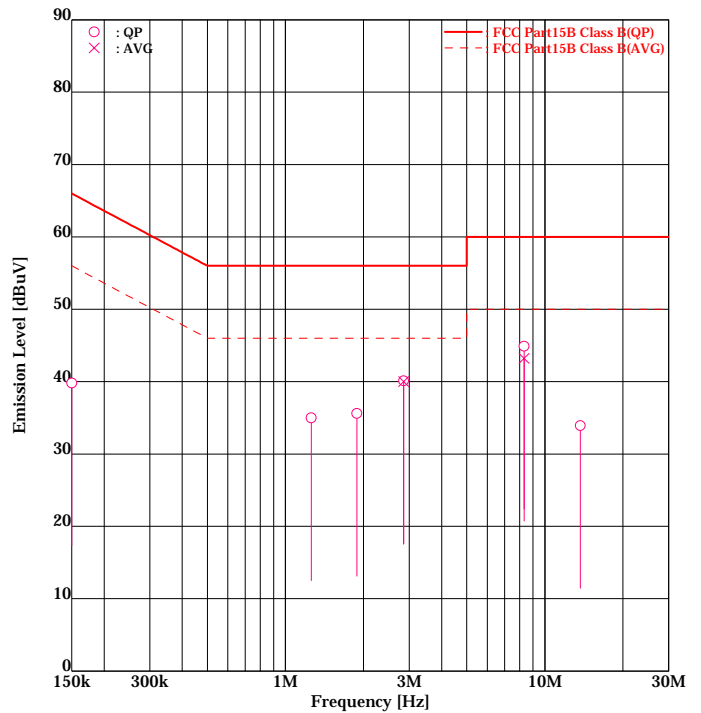

ENGINEER : Kazuo Masuda

FREQUENCY [No]	MODE [MHz]	READING [dBuV]		FACTOR [dB]		EMISSION [dBuV]		LIMIT [dBuV]	MARGIN [dB]		
		Line1	Line2	Line1	Line2	Line1	Line2		Line1	Line2	
1	0.1500	QP	34.1	33.9	5.7	5.6	39.8	39.5	66.0	26.2	26.5
2	1.2584	QP	<u>29.4</u>	27.5	5.6	5.6	<u>35.0</u>	33.1	56.0	<u>21.0</u>	22.9
3	1.8852	QP	<u>29.9</u>	29.8	5.7	5.7	<u>35.6</u>	35.5	56.0	<u>20.4</u>	20.5
4	2.8550	QP	34.2	<u>34.4</u>	5.8	5.7	40.0	<u>40.1</u>	56.0	16.0	<u>15.9</u>
5	2.8550	AVG	34.1	<u>34.3</u>	5.8	5.7	39.9	<u>40.0</u>	46.0	6.1	<u>6.0</u>
6	8.3193	QP	<u>38.7</u>	38.4	6.2	6.2	<u>44.9</u>	44.6	60.0	<u>15.1</u>	15.4
7	8.3193	AVG	<u>37.0</u>	36.8	6.2	6.2	<u>43.2</u>	43.0	50.0	<u>6.8</u>	7.0
8	13.6894	QP	27.4	26.6	6.5	6.5	33.9	33.1	60.0	26.1	26.9

Higher six points are underlined.
 Other frequencies : Below the FCC Part15B Class B limit
 Emission Level = Read + Factor(LISN,Pad,Cable)

9.1.3 Tuned Point 54.000 MHz mode (PSU1)

Akzo Nobel K. K.
Kashima No.1 Test Site
Conducted Voltages on Mains Port

APPLICANT : Kenwood Corporation
 EUT NAME : HF / 50MHz All Mode Transceiver
 MODEL NO. : TS-480HX
 SERIAL NO. : None
 TEST MODE : Tuned Point 54.000MHz (PSU1)
 POWER SOURCE : DC13.8V (AC120V/60Hz)
 DATE TESTED : Nov 10 2004
 FILE NO. : ANKK-104323
 REGULATION : FCC Part15B Class B
 TEST METHOD : ANSI C63.4-2003
 TEMPERATURE : 21.0 [degC]
 HUMIDITY : 51.0 [%]
 NOTE :

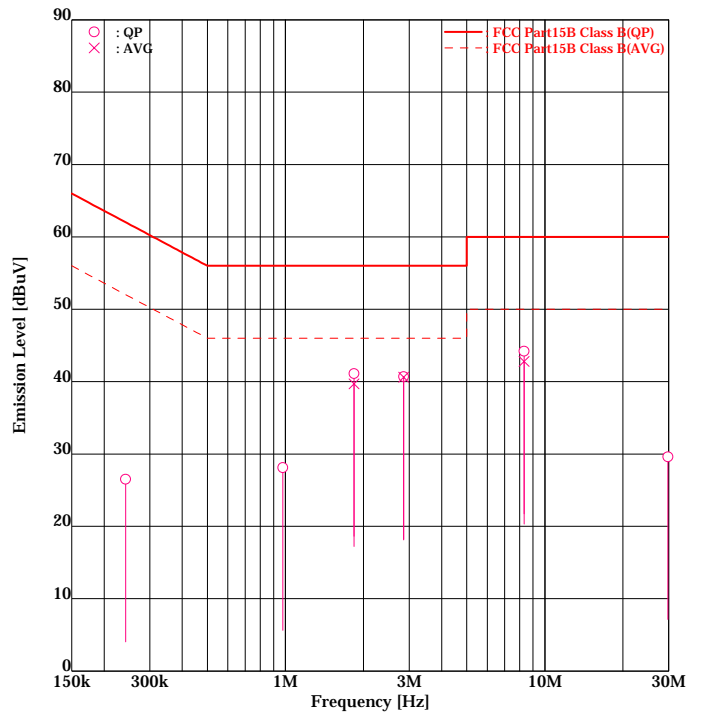

ENGINEER : Kazuo Masuda

FREQUENCY [No]	MODE [MHz]	READING [dBuV]		FACTOR [dB]		EMISSION [dBuV]		LIMIT [dBuV]	MARGIN [dB]		
		Line1	Line2	Line1	Line2	Line1	Line2		Line1	Line2	
1	0.2421	QP	20.6	21.0	5.6	5.5	26.2	26.5	62.0	35.8	35.5
2	0.9780	QP	22.5	22.4	5.6	5.6	28.1	28.0	56.0	27.9	28.0
3	1.8387	QP	33.7	<u>35.4</u>	5.7	5.7	39.4	<u>41.1</u>	56.0	16.6	<u>14.9</u>
4	1.8387	AVG	33.6	<u>34.0</u>	5.7	5.7	39.3	<u>39.7</u>	46.0	6.7	<u>6.3</u>
5	2.8547	QP	<u>34.9</u>	34.9	5.8	5.7	<u>40.7</u>	40.6	56.0	<u>15.3</u>	15.4
6	2.8547	AVG	<u>34.8</u>	34.8	5.8	5.7	<u>40.6</u>	40.5	46.0	<u>5.4</u>	5.5
7	8.3194	QP	<u>38.0</u>	37.9	6.2	6.2	<u>44.2</u>	44.1	60.0	<u>15.8</u>	15.9
8	8.3194	AVG	<u>36.6</u>	36.4	6.2	6.2	<u>42.8</u>	42.6	50.0	<u>7.2</u>	7.4
9	29.7939	QP	21.2	22.0	6.9	7.6	28.1	29.6	60.0	31.9	30.4

Higher six points are underlined.
 Other frequencies : Below the FCC Part15B Class B limit
 Emission Level = Read + Factor(LISN,Pad,Cable)

9.1.4 Tuned Point 54.000 MHz mode (PSU2)

Akzo Nobel K. K.
Kashima No.1 Test Site
Conducted Voltages on Mains Port

APPLICANT : Kenwood Corporation
 EUT NAME : HF / 50MHz All Mode Transceiver
 MODEL NO. : TS-480HX
 SERIAL NO. : None
 TEST MODE : Tuned Point 54.000MHz (PSU2)
 POWER SOURCE : DC13.8V (AC120V/60Hz)
 DATE TESTED : Nov 10 2004
 FILE NO. : ANKK-104323
 REGULATION : FCC Part15B Class B
 TEST METHOD : ANSI C63.4-2003
 TEMPERATURE : 21.0 [degC]
 HUMIDITY : 51.0 [%]
 NOTE :

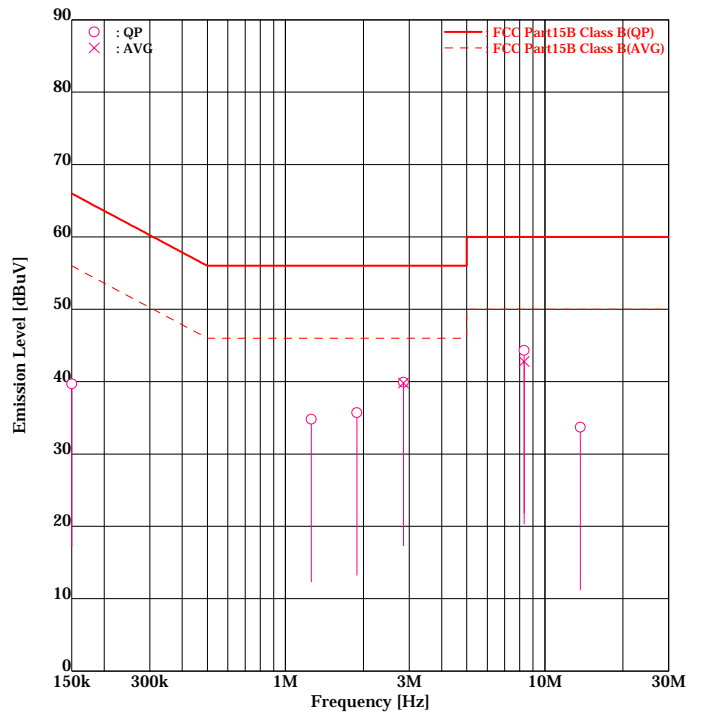

ENGINEER : Kazuo Masuda

FREQUENCY [No]	MODE [MHz]	READING [dBuV]		FACTOR [dB]		EMISSION [dBuV]		LIMIT [dBuV]	MARGIN [dB]		
		Line1	Line2	Line1	Line2	Line1	Line2		Line1	Line2	
1	0.1500	QP	34.0	33.9	5.7	5.6	39.7	39.5	66.0	26.3	26.5
2	1.2584	QP	29.2	27.7	5.6	5.6	34.8	33.3	56.0	21.2	22.7
3	1.8852	QP	30.0	29.7	5.7	5.7	35.7	35.4	56.0	20.3	20.6
4	2.8524	QP	34.1	33.9	5.8	5.7	39.9	39.6	56.0	16.1	16.4
5	2.8524	AVG	34.0	33.9	5.8	5.7	39.8	39.6	46.0	6.2	6.4
6	8.3196	QP	38.1	38.0	6.2	6.2	44.3	44.2	60.0	15.7	15.8
7	8.3196	AVG	36.6	36.4	6.2	6.2	42.8	42.6	50.0	7.2	7.4
8	13.6894	QP	27.2	26.5	6.5	6.5	33.7	33.0	60.0	26.3	27.0

Higher six points are underlined.
 Other frequencies : Below the FCC Part15B Class B limit
 Emission Level = Read + Factor(LISN,Pad,Cable)

9.1.5 VFO Scan mode (PSU1)

Akzo Nobel K. K.
Kashima No.1 Test Site
Conducted Voltages on Mains Port

APPLICANT : Kenwood Corporation
 EUT NAME : HF / 50MHz All Mode Transceiver
 MODEL NO. : TS-480HX
 SERIAL NO. : None
 TEST MODE : VFO Scan (PSU1)
 POWER SOURCE : DC13.8V (AC120V/60Hz)
 DATE TESTED : Nov 10 2004
 FILE NO. : ANKK-104323
 REGULATION : FCC Part15B Class B
 TEST METHOD : ANSI C63.4-2003
 TEMPERATURE : 21.0 [degC]
 HUMIDITY : 51.0 [%]
 NOTE : Band : 0.030 - 59.999MHz

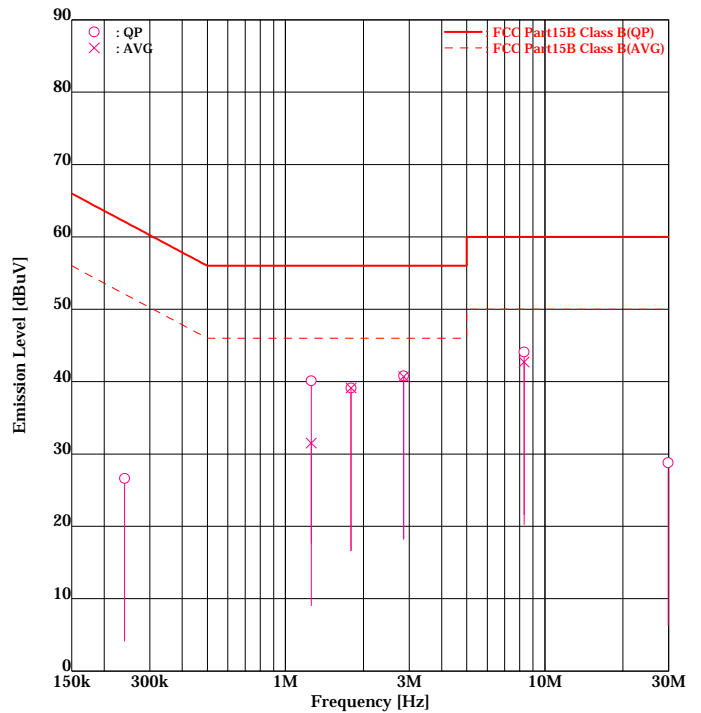

ENGINEER : Kazuo Masuda

FREQUENCY [No]	MODE [MHz]	READING [dBuV]		FACTOR [dB]		EMISSION [dBuV]		LIMIT [dBuV]	MARGIN [dB]		
		Line1	Line2	Line1	Line2	Line1	Line2		Line1	Line2	
1	0.2399	QP	21.0	21.1	5.6	5.5	26.6	26.6	62.1	35.5	35.5
2	1.2578	QP	34.2	<u>34.5</u>	5.6	5.6	39.8	<u>40.1</u>	56.0	16.2	<u>15.9</u>
3	1.2578	AVG	25.6	<u>25.9</u>	5.6	5.6	31.2	<u>31.5</u>	46.0	14.8	<u>14.5</u>
4	1.7907	QP	33.4	33.4	5.7	5.7	39.1	39.1	56.0	16.9	16.9
5	1.7907	AVG	<u>33.4</u>	33.3	5.7	5.7	<u>39.1</u>	39.0	46.0	<u>6.9</u>	7.0
6	2.8542	QP	34.9	<u>35.1</u>	5.8	5.7	40.7	<u>40.8</u>	56.0	15.3	<u>15.2</u>
7	2.8542	AVG	<u>34.9</u>	35.0	5.8	5.7	<u>40.7</u>	40.7	46.0	<u>5.3</u>	5.3
8	8.3193	QP	<u>37.9</u>	37.9	6.2	6.2	<u>44.1</u>	44.1	60.0	<u>15.9</u>	15.9
9	8.3193	AVG	<u>36.5</u>	36.4	6.2	6.2	<u>42.7</u>	42.6	50.0	<u>7.3</u>	7.4
10	29.8428	QP	20.5	21.2	6.9	7.6	27.4	28.8	60.0	32.6	31.2

Higher six points are underlined.
 Other frequencies : Below the FCC Part15B Class B limit
 Emission Level = Read + Factor(LISN,Pad,Cable)

9.1.6 VFO Scan mode (PSU2)

Akzo Nobel K. K.
Kashima No.1 Test Site
Conducted Voltages on Mains Port

APPLICANT : Kenwood Corporation
 EUT NAME : HF / 50MHz All Mode Transceiver
 MODEL NO. : TS-480HX
 SERIAL NO. : None
 TEST MODE : VFO Scan (PSU2)
 POWER SOURCE : DC13.8V (AC120V/60Hz)
 DATE TESTED : Nov 10 2004
 FILE NO. : ANKK-104323
 REGULATION : FCC Part15B Class B
 TEST METHOD : ANSI C63.4-2003
 TEMPERATURE : 21.0 [degC]
 HUMIDITY : 51.0 [%]
 NOTE : Band : 0.030 - 59.999MHz

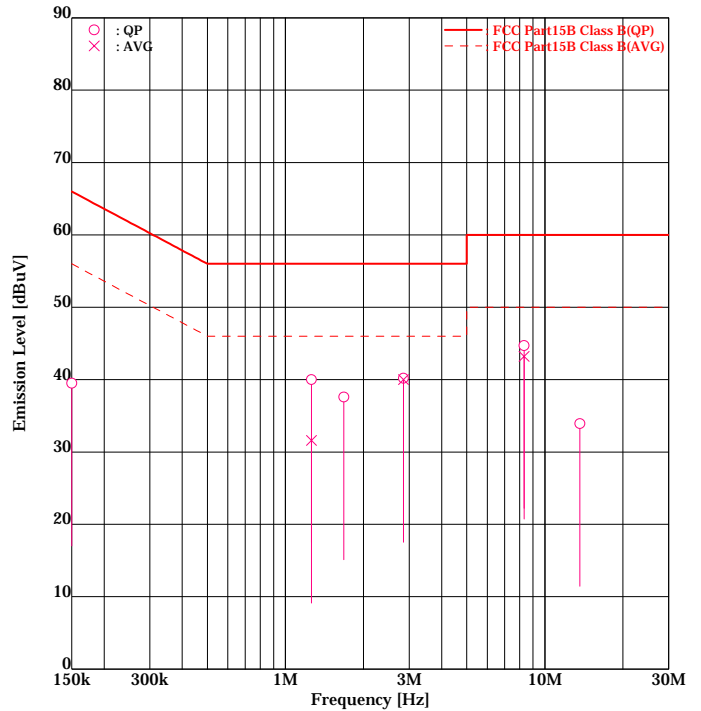

ENGINEER : Kazuo Masuda

FREQUENCY [No]	MODE [MHz]	READING [dBuV]		FACTOR [dB]		EMISSION [dBuV]		LIMIT [dBuV]	MARGIN [dB]		
		Line1	Line2	Line1	Line2	Line1	Line2		Line1	Line2	
1	0.1500	QP	33.5	33.9	5.7	5.6	39.2	39.5	66.0	26.8	26.5
2	1.2589	QP	34.2	<u>34.4</u>	5.6	5.6	39.8	<u>40.0</u>	56.0	16.2	<u>16.0</u>
3	1.2589	AVG	25.9	<u>26.0</u>	5.6	5.6	31.5	<u>31.6</u>	46.0	14.5	<u>14.4</u>
4	1.6796	QP	31.9	31.8	5.7	5.7	37.6	37.5	56.0	18.4	18.5
5	2.8524	QP	34.3	<u>34.5</u>	5.8	5.7	40.1	<u>40.2</u>	56.0	15.9	<u>15.8</u>
6	2.8524	AVG	34.1	<u>34.3</u>	5.8	5.7	39.9	<u>40.0</u>	46.0	6.1	<u>6.0</u>
7	8.3178	QP	37.0	<u>38.5</u>	6.2	6.2	43.2	<u>44.7</u>	60.0	16.8	<u>15.3</u>
8	8.3178	AVG	36.5	<u>37.0</u>	6.2	6.2	42.7	<u>43.2</u>	50.0	7.3	<u>6.8</u>
9	13.6405	QP	27.0	27.4	6.5	6.5	33.5	33.9	60.0	26.5	26.1

Higher six points are underlined.

Other frequencies : Below the FCC Part15B Class B limit

Emission Level = Read + Factor(LISN,Pad,Cable)

9.2 Radiated Electric Field

9.2.1 Tuned Point 0.500 MHz mode (30 – 1000 MHz)

Akzo Nobel K. K.
Kashima No.1 Test Site
Radiated Electric Field

APPLICANT : Kenwood Corporation
 EUT NAME : HF / 50MHz All Mode Transceiver
 MODEL NO. : TS-480HX
 SERIAL NO. : None
 TEST MODE : Tuned Point 0.500MHz
 POWER SOURCE : DC13.8V (AC120V/60Hz)
 DATE TESTED : Nov 11 2004
 FILE NO. : ANKK-104323
 REGULATION : FCC Part15B Class B
 TEST METHOD : ANSI C63.4-2003
 DISTANCE : 3.0 [m]
 TEMPERATURE : 22.0 [degC]
 HUMIDITY : 62.0 [%]
 NOTE :

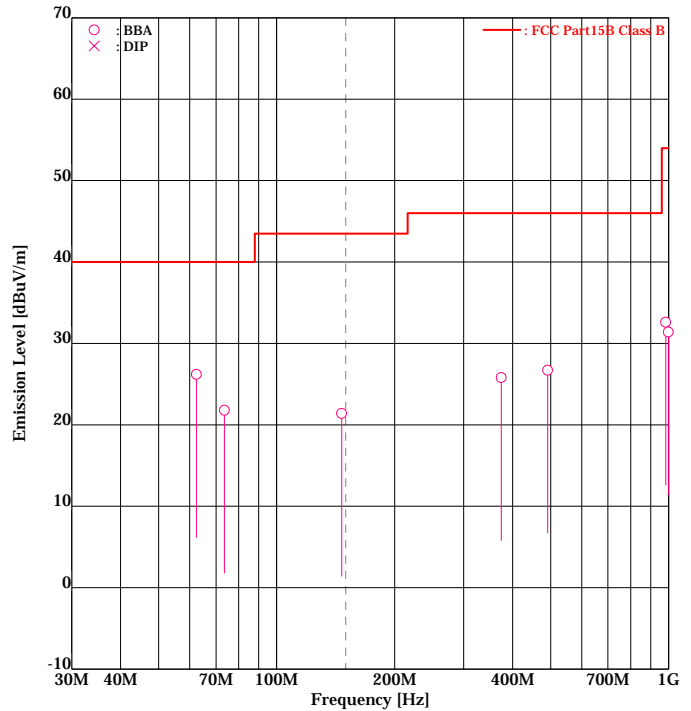

ENGINEER : Kazuo Masuda

FREQUENCY [No]	ANT. [MHz]	ANT.	READING [dBuV]		FACTOR [dB/m]		EMISSION [dBuV/m]		LIMIT [dBuV/m]	MARGIN [dB]	
			Hori	Vert	Hori	Vert	Hori	Vert		Hori	Vert
1	62.40	BBA	26.1	<u>34.0</u>	-7.8	-7.8	18.3	<u>26.2</u>	40.0	21.7	<u>13.8</u>
2	73.59	BBA	29.8	<u>31.1</u>	-9.3	-9.3	20.5	<u>21.8</u>	40.0	19.5	<u>18.2</u>
3	146.58	BBA	<u>27.5</u>	26.5	-6.1	-6.1	<u>21.4</u>	20.4	43.5	<u>22.1</u>	23.1
4	374.40	BBA	<u>28.3</u>	26.1	-2.5	-2.5	<u>25.8</u>	23.6	46.0	<u>20.2</u>	22.4
5	491.51	BBA	<u>26.0</u>	24.4	0.7	0.7	<u>26.7</u>	25.1	46.0	<u>19.3</u>	20.9
6	983.03	BBA	<u>22.2</u>	21.1	10.4	10.4	<u>32.6</u>	31.5	54.0	<u>21.4</u>	22.5
7	998.40	BBA	21.0	20.8	10.4	10.4	31.4	31.2	54.0	22.6	22.8

Higher six points are underlined.
 Other frequencies : Below the FCC Part15B Class B limit
 Emission Level = Read + Factor(Antenna,Antenna Pad,Cable,Preamp)
 ANT. : Used antenna(BBA = Broadband antenna, DIP = Dipole antenna)

9.2.2 Tuned Point 0.500 MHz mode (1000 – 2000 MHz)

Akzo Nobel K. K.
Kashima No.1 Test Site
Radiated Electric Field

APPLICANT : Kenwood Corporation
 EUT NAME : HF / 50MHz All Mode Transceiver
 MODEL NO. : TS-480HX
 SERIAL NO. : None
 TEST MODE : Tuned Point 0.500MHz
 POWER SOURCE : DC13.8V (AC120V/60Hz)
 DATE TESTED : Nov 11 2004
 FILE NO. : ANKK-104323
 REGULATION : FCC Part15B Class B
 TEST METHOD : ANSI C63.4-2003
 DISTANCE : 3.0 [m]
 TEMPERATURE : 22.0 [degC]
 HUMIDITY : 62.0 [%]
 NOTE :

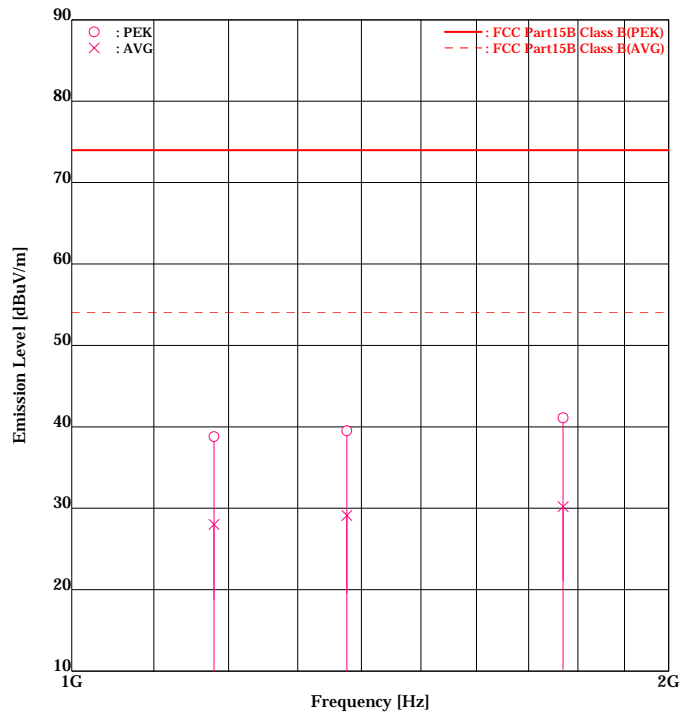

ENGINEER : Kazuo Masuda

FREQUENCY [No]	MODE [MHz]		READING [dBuV]		FACTOR [dB/m]		EMISSION [dBuV/m]		LIMIT [dBuV/m]	MARGIN [dB]	
			Hori	Vert	Hori	Vert	Hori	Vert		Hori	Vert
1	1179.64	PEK	-	<u>39.5</u>	-0.7	-0.7	-	<u>38.8</u>	74.0	-	<u>35.2</u>
2	1179.64	AVG	-	<u>28.7</u>	-0.7	-0.7	-	<u>28.0</u>	54.0	-	<u>26.0</u>
3	1376.35	PEK	-	<u>40.0</u>	-0.5	-0.5	-	<u>39.5</u>	74.0	-	<u>34.5</u>
4	1376.35	AVG	-	<u>29.6</u>	-0.5	-0.5	-	<u>29.1</u>	54.0	-	<u>24.9</u>
5	1769.52	PEK	-	<u>39.7</u>	1.4	1.4	-	<u>41.1</u>	74.0	-	<u>32.9</u>
6	1769.52	AVG	-	<u>28.8</u>	1.4	1.4	-	<u>30.2</u>	54.0	-	<u>23.8</u>

Higher six points are underlined.
 Other frequencies : Below the FCC Part15B Class B limit
 Emission Level = Read + Factor(Antenna,Antenna Pad,Cable,Preamp)
 ANT. : Used antenna(BBA = Broadband antenna, DIP = Dipole antenna)

9.2.3 Tuned Point 30.000 MHz mode (30 – 1000 MHz)

Akzo Nobel K. K.
Kashima No.1 Test Site
Radiated Electric Field

APPLICANT : Kenwood Corporation
 EUT NAME : HF / 50MHz All Mode Transceiver
 MODEL NO. : TS-480HX
 SERIAL NO. : None
 TEST MODE : Tuned Point 30.000MHz
 POWER SOURCE : DC13.8V (AC120V/60Hz)
 DATE TESTED : Nov 11 2004
 FILE NO. : ANKK-104323
 REGULATION : FCC Part15B Class B
 TEST METHOD : ANSI C63.4-2003
 DISTANCE : 3.0 [m]
 TEMPERATURE : 22.0 [degC]
 HUMIDITY : 62.0 [%]
 NOTE :

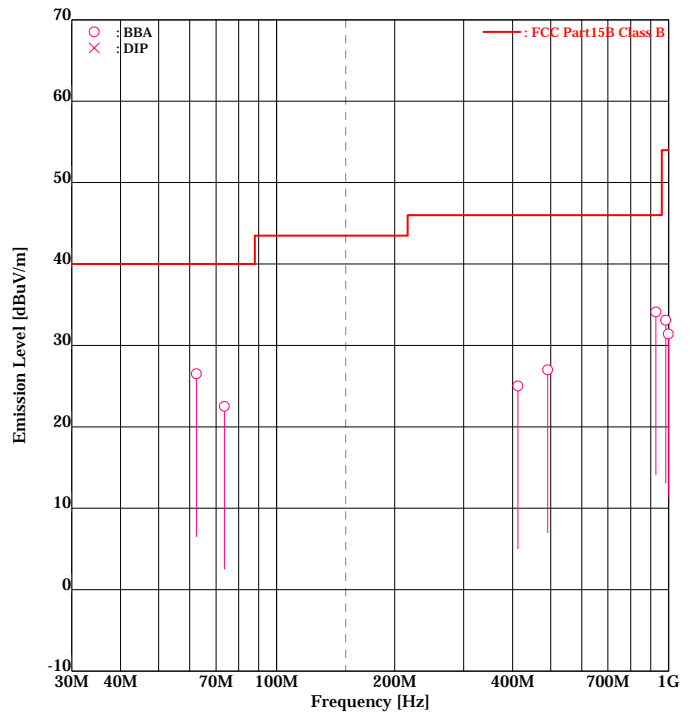

ENGINEER : Kazuo Masuda

FREQUENCY [No]	ANT. [MHz]	ANT.	READING [dBuV]		FACTOR [dB/m]		EMISSION [dBuV/m]		LIMIT [dBuV/m]	MARGIN [dB]	
			Hori	Vert	Hori	Vert	Hori	Vert		Hori	Vert
1	62.40	BBA	26.4	<u>34.3</u>	-7.8	-7.8	18.6	<u>26.5</u>	40.0	21.4	<u>13.5</u>
2	73.59	BBA	28.6	<u>31.8</u>	-9.3	-9.3	19.3	<u>22.5</u>	40.0	20.7	<u>17.5</u>
3	412.38	BBA	<u>26.5</u>	24.9	-1.5	-1.5	<u>25.0</u>	23.4	46.0	<u>21.0</u>	22.6
4	491.51	BBA	<u>26.3</u>	24.2	0.7	0.7	<u>27.0</u>	24.9	46.0	<u>19.0</u>	21.1
5	927.86	BBA	23.8	<u>24.4</u>	9.7	9.7	33.5	<u>34.1</u>	46.0	12.5	<u>11.9</u>
6	983.03	BBA	<u>22.7</u>	21.8	10.4	10.4	<u>33.1</u>	32.2	54.0	<u>20.9</u>	21.8
7	998.40	BBA	21.0	20.7	10.4	10.4	31.4	31.1	54.0	22.6	22.9

Higher six points are underlined.
 Other frequencies : Below the FCC Part15B Class B limit
 Emission Level = Read + Factor(Antenna,Antenna Pad,Cable,Preamp)
 ANT. : Used antenna(BBA = Broadband antenna, DIP = Dipole antenna)

9.2.4 Tuned Point 30.000 MHz mode (1000 – 2000 MHz)

Akzo Nobel K. K.
Kashima No.1 Test Site
Radiated Electric Field

APPLICANT : Kenwood Corporation
 EUT NAME : HF / 50MHz All Mode Transceiver
 MODEL NO. : TS-480HX
 SERIAL NO. : None
 TEST MODE : Tuned Point 30.000MHz
 POWER SOURCE : DC13.8V (AC120V/60Hz)
 DATE TESTED : Nov 11 2004
 FILE NO. : ANKK-104323
 REGULATION : FCC Part15B Class B
 TEST METHOD : ANSI C63.4-2003
 DISTANCE : 3.0 [m]
 TEMPERATURE : 22.0 [degC]
 HUMIDITY : 62.0 [%]
 NOTE :

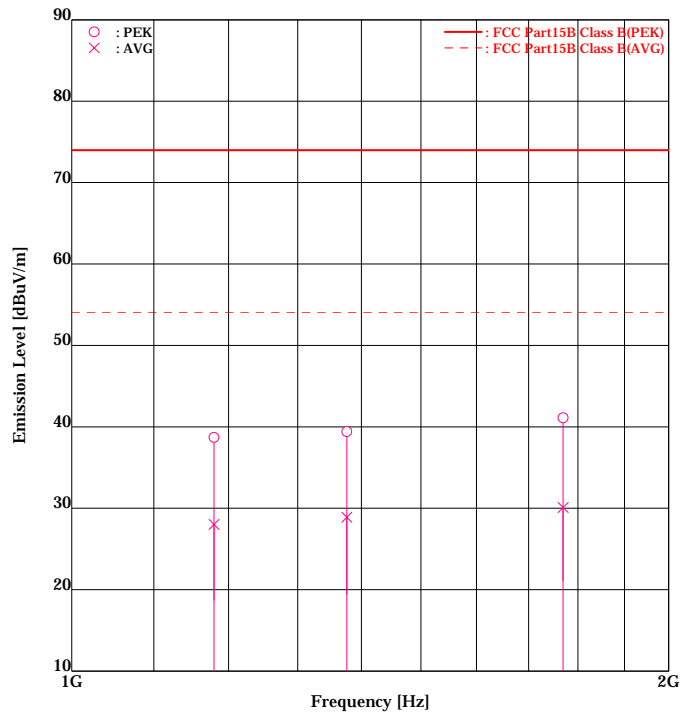

ENGINEER : Kazuo Masuda

FREQUENCY [No]	MODE [MHz]		READING [dBuV]		FACTOR [dB/m]		EMISSION [dBuV/m]		LIMIT [dBuV/m]		MARGIN [dB]	
			Hori	Vert	Hori	Vert	Hori	Vert	Hori	Vert		
1	1179.64	PEK	-	<u>39.4</u>	-0.7	-0.7	-	<u>38.7</u>	74.0	-	<u>35.3</u>	
2	1179.64	AVG	-	<u>28.7</u>	-0.7	-0.7	-	<u>28.0</u>	54.0	-	<u>26.0</u>	
3	1376.35	PEK	-	<u>39.9</u>	-0.5	-0.5	-	<u>39.4</u>	74.0	-	<u>34.6</u>	
4	1376.35	AVG	-	<u>29.4</u>	-0.5	-0.5	-	<u>28.9</u>	54.0	-	<u>25.1</u>	
5	1769.52	PEK	-	<u>39.7</u>	1.4	1.4	-	<u>41.1</u>	74.0	-	<u>32.9</u>	
6	1769.52	AVG	-	<u>28.7</u>	1.4	1.4	-	<u>30.1</u>	54.0	-	<u>23.9</u>	

Higher six points are underlined.
 Other frequencies : Below the FCC Part15B Class B limit
 Emission Level = Read + Factor(Antenna,Antenna Pad,Cable,Preamp)
 ANT. : Used antenna(BBA = Broadband antenna, DIP = Dipole antenna)

9.2.5 Tuned Point 54.000 MHz mode (30 – 1000 MHz)

Akzo Nobel K. K.
Kashima No.1 Test Site
Radiated Electric Field

APPLICANT : Kenwood Corporation
 EUT NAME : HF / 50MHz All Mode Transceiver
 MODEL NO. : TS-480HX
 SERIAL NO. : None
 TEST MODE : Tuned Point 54.000MHz
 POWER SOURCE : DC13.8V (AC120V/60Hz)
 DATE TESTED : Nov 11 2004
 FILE NO. : ANKK-104323
 REGULATION : FCC Part15B Class B
 TEST METHOD : ANSI C63.4-2003
 DISTANCE : 3.0 [m]
 TEMPERATURE : 22.0 [degC]
 HUMIDITY : 62.0 [%]
 NOTE :

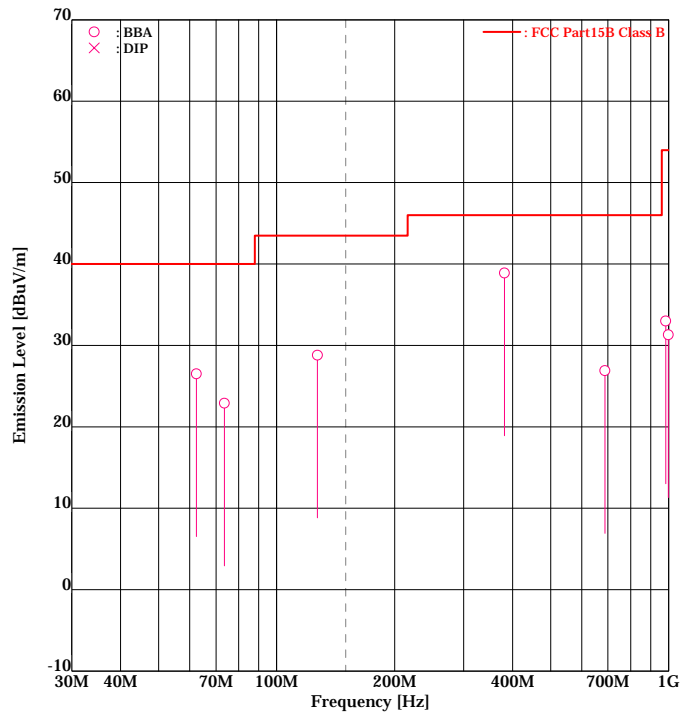

ENGINEER : Kazuo Masuda

FREQUENCY [No]	ANT. [MHz]		READING [dBuV]		FACTOR [dB/m]		EMISSION [dBuV/m]		LIMIT [dBuV/m]	MARGIN [dB]	
			Hori	Vert	Hori	Vert	Hori	Vert		Hori	Vert
1	62.40	BBA	26.5	<u>34.3</u>	-7.8	-7.8	18.7	<u>26.5</u>	40.0	21.3	<u>13.5</u>
2	73.59	BBA	28.5	<u>32.2</u>	-9.3	-9.3	19.2	<u>22.9</u>	40.0	20.8	<u>17.1</u>
3	127.09	BBA	31.1	<u>36.0</u>	-7.2	-7.2	23.9	<u>28.8</u>	43.5	19.6	<u>14.7</u>
4	381.28	BBA	41.2	34.5	-2.3	-2.3	38.9	32.2	46.0	<u>7.1</u>	13.8
5	688.12	BBA	<u>22.3</u>	21.7	4.6	4.6	<u>26.9</u>	26.3	46.0	<u>19.1</u>	19.7
6	983.03	BBA	<u>22.6</u>	22.0	10.4	10.4	<u>33.0</u>	32.4	54.0	<u>21.0</u>	21.6
7	998.40	BBA	20.8	20.9	10.4	10.4	31.2	31.3	54.0	22.8	22.7

Higher six points are underlined.
 Other frequencies : Below the FCC Part15B Class B limit
 Emission Level = Read + Factor(Antenna,Antenna Pad,Cable,Preamp)
 ANT. : Used antenna(BBA = Broadband antenna, DIP = Dipole antenna)

9.2.6 Tuned Point 54.000 MHz mode (1000 – 2000 MHz)

Akzo Nobel K. K.
Kashima No.1 Test Site
Radiated Electric Field

APPLICANT : Kenwood Corporation
 EUT NAME : HF / 50MHz All Mode Transceiver
 MODEL NO. : TS-480HX
 SERIAL NO. : None
 TEST MODE : Tuned Point 54.000MHz
 POWER SOURCE : DC13.8V (AC120V/60Hz)
 DATE TESTED : Nov 11 2004
 FILE NO. : ANKK-104323
 REGULATION : FCC Part15B Class B
 TEST METHOD : ANSI C63.4-2003
 DISTANCE : 3.0 [m]
 TEMPERATURE : 22.0 [degC]
 HUMIDITY : 62.0 [%]
 NOTE :

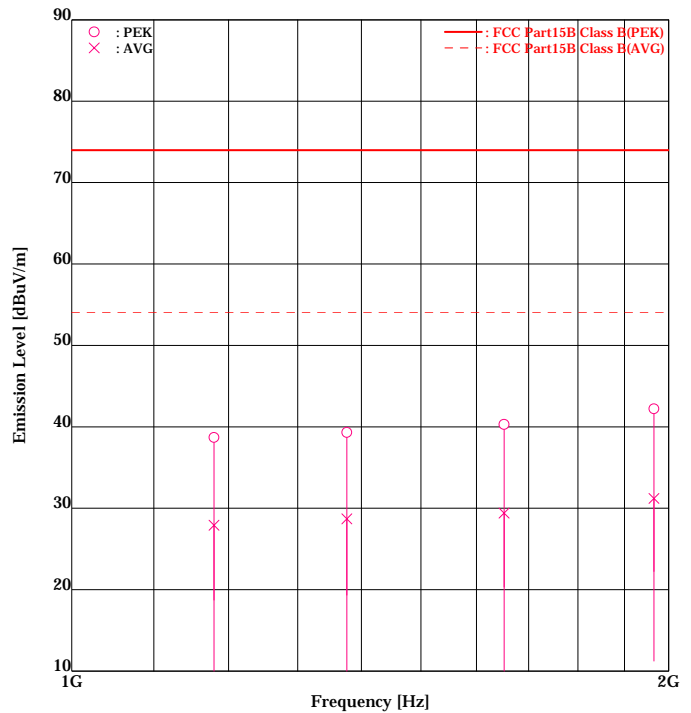

ENGINEER : Kazuo Masuda

FREQUENCY [No]	MODE [MHz]		READING [dBuV]		FACTOR [dB/m]		EMISSION [dBuV/m]		LIMIT [dBuV/m]		MARGIN [dB]	
			Hori	Vert	Hori	Vert	Hori	Vert	Hori	Vert	Hori	Vert
1	1179.64	PEK	-	<u>39.4</u>	-0.7	-0.7	-	<u>38.7</u>	74.0	-	35.3	
2	1179.64	AVG	-	<u>28.6</u>	-0.7	-0.7	-	<u>27.9</u>	54.0	-	<u>26.1</u>	
3	1376.35	PEK	-	<u>39.8</u>	-0.5	-0.5	-	<u>39.3</u>	74.0	-	<u>34.7</u>	
4	1376.35	AVG	-	<u>29.2</u>	-0.5	-0.5	-	<u>28.7</u>	54.0	-	<u>25.3</u>	
5	1652.25	PEK	-	<u>39.6</u>	0.7	0.7	-	<u>40.3</u>	74.0	-	<u>33.7</u>	
6	1652.25	AVG	-	<u>28.7</u>	0.7	0.7	-	<u>29.4</u>	54.0	-	<u>24.6</u>	
7	1966.09	PEK	<u>39.4</u>	-	2.8	2.8	<u>42.2</u>	-	74.0	<u>31.8</u>	-	
8	1966.09	AVG	<u>28.4</u>	-	2.8	2.8	<u>31.2</u>	-	54.0	<u>22.8</u>	-	

Higher six points are underlined.

Other frequencies : Below the FCC Part15B Class B limit

Emission Level = Read + Factor(Antenna, Antenna Pad, Cable, Preamp)

ANT. : Used antenna(BBA = Broadband antenna, DIP = Dipole antenna)

9.2.7 VFO Scan mode (30 – 1000 MHz)

Akzo Nobel K. K.
Kashima No.1 Test Site
Radiated Electric Field

APPLICANT : Kenwood Corporation
 EUT NAME : HF / 50MHz All Mode Transceiver
 MODEL NO. : TS-480HX
 SERIAL NO. : None
 TEST MODE : VFO Scan
 POWER SOURCE : DC13.8V (AC120V/60Hz)
 DATE TESTED : Nov 11 2004
 FILE NO. : ANKK-104323
 REGULATION : FCC Part15B Class B
 TEST METHOD : ANSI C63.4-2003
 DISTANCE : 3.0 [m]
 TEMPERATURE : 22.0 [degC]
 HUMIDITY : 62.0 [%]
 NOTE : Band : 0.030 - 59.999MHz

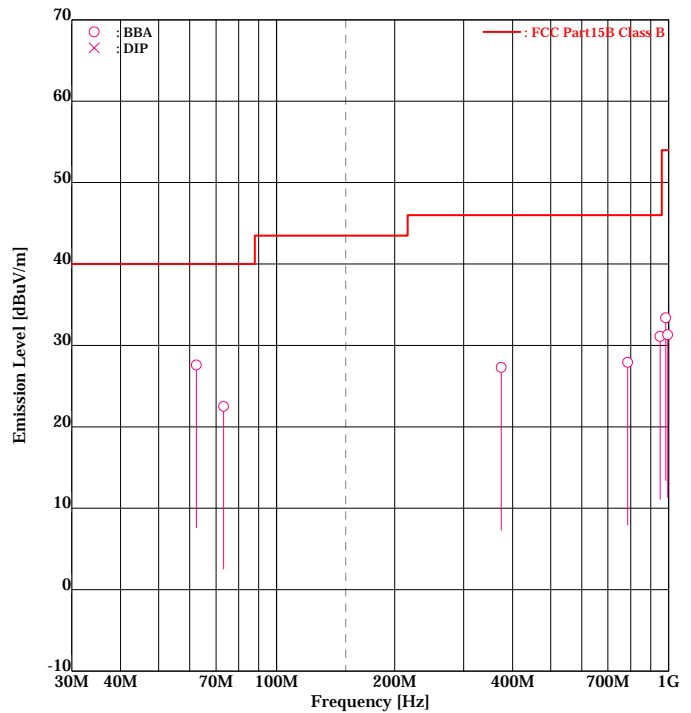

ENGINEER : Kazuo Masuda

FREQUENCY [No]	ANT. [MHz]		READING [dBuV]		FACTOR [dB/m]		EMISSION [dBuV/m]		LIMIT [dBuV/m]		MARGIN [dB]	
			Hori	Vert	Hori	Vert	Hori	Vert	Hori	Vert	Hori	Vert
1	62.40	BBA	27.4	<u>35.4</u>	-7.8	-7.8	19.6	<u>27.6</u>	40.0	20.4	<u>12.4</u>	
2	73.25	BBA	28.3	<u>31.7</u>	-9.2	-9.2	19.1	<u>22.5</u>	40.0	20.9	<u>17.5</u>	
3	374.40	BBA	<u>29.8</u>	26.3	-2.5	-2.5	<u>27.3</u>	23.8	46.0	<u>18.7</u>	22.2	
4	786.43	BBA	20.9	<u>21.1</u>	6.8	6.8	27.7	<u>27.9</u>	46.0	18.3	<u>18.1</u>	
5	951.60	BBA	20.9	<u>21.2</u>	9.9	9.9	30.8	<u>31.1</u>	46.0	15.2	<u>14.9</u>	
6	983.04	BBA	<u>23.0</u>	22.1	10.4	10.4	<u>33.4</u>	32.5	54.0	<u>20.6</u>	21.5	
7	995.31	BBA	20.7	20.9	10.4	10.4	31.1	31.3	54.0	22.9	22.7	

Higher six points are underlined.
 Other frequencies : Below the FCC Part15B Class B limit
 Emission Level = Read + Factor(Antenna,Antenna Pad,Cable,Preamp)
 ANT. : Used antenna(BBA = Broadband antenna, DIP = Dipole antenna)

9.2.8 VFO Scan mode (1000 – 2000 MHz)

Akzo Nobel K. K.
Kashima No.1 Test Site
Radiated Electric Field

APPLICANT : Kenwood Corporation
 EUT NAME : HF / 50MHz All Mode Transceiver
 MODEL NO. : TS-480HX
 SERIAL NO. : None
 TEST MODE : VFO Scan
 POWER SOURCE : DC13.8V (AC120V/60Hz)
 DATE TESTED : Nov 11 2004
 FILE NO. : ANKK-104323
 REGULATION : FCC Part15B Class B
 TEST METHOD : ANSI C63.4-2003
 DISTANCE : 3.0 [m]
 TEMPERATURE : 22.0 [degC]
 HUMIDITY : 62.0 [%]
 NOTE : Band : 0.030 - 59.999MHz

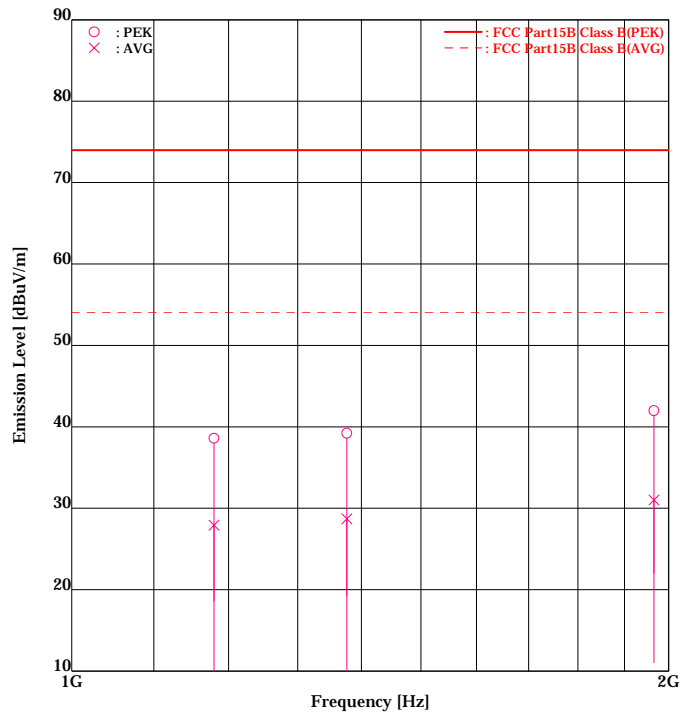

ENGINEER : Kazuo Masuda

FREQUENCY [No]	MODE [MHz]		READING [dBuV]		FACTOR [dB/m]		EMISSION [dBuV/m]		LIMIT [dBuV/m]		MARGIN [dB]	
			Hori	Vert	Hori	Vert	Hori	Vert	Hori	Vert	Hori	Vert
1	1179.64	PEK	-	<u>39.3</u>	-0.7	-0.7	-	<u>38.6</u>	74.0	-	<u>35.4</u>	-
2	1179.64	AVG	-	<u>28.6</u>	-0.7	-0.7	-	<u>27.9</u>	54.0	-	<u>26.1</u>	-
3	1376.35	PEK	-	<u>39.7</u>	-0.5	-0.5	-	<u>39.2</u>	74.0	-	<u>34.8</u>	-
4	1376.35	AVG	-	<u>29.2</u>	-0.5	-0.5	-	<u>28.7</u>	54.0	-	<u>25.3</u>	-
5	1966.09	PEK	<u>39.2</u>	-	2.8	2.8	<u>42.0</u>	-	74.0	<u>32.0</u>	-	-
6	1966.09	AVG	<u>28.2</u>	-	2.8	2.8	<u>31.0</u>	-	54.0	<u>23.0</u>	-	-

Higher six points are underlined.
 Other frequencies : Below the FCC Part15B Class B limit
 Emission Level = Read + Factor(Antenna,Antenna Pad,Cable,Preamp)
 ANT. : Used antenna(BBA = Broadband antenna, DIP = Dipole antenna)

9.3 Conducted Power on Antenna Port

9.3.1 Tuned Point 0.500 MHz mode (ANT1)

Akzo Nobel K. K.
Kashima No.1 Test Site
Conducted Power on Antenna Port

APPLICANT : Kenwood Corporation
 EUT NAME : HF / 50MHz All Mode Transceiver
 MODEL NO. : TS-480HX
 SERIAL NO. : None
 TEST MODE : Tuned Point 0.500MHz (ANT1)
 POWER SOURCE : DC13.8V (AC120V/60Hz)
 DATE TESTED : Nov 17 2004
 FILE NO. : ANKK-104323
 REGULATION : FCC Part15B (15.111)
 TEST METHOD : ANSI C63.4-2003
 TEMPERATURE : 23.0 [degC]
 HUMIDITY : 45.0 [%]
 NOTE :

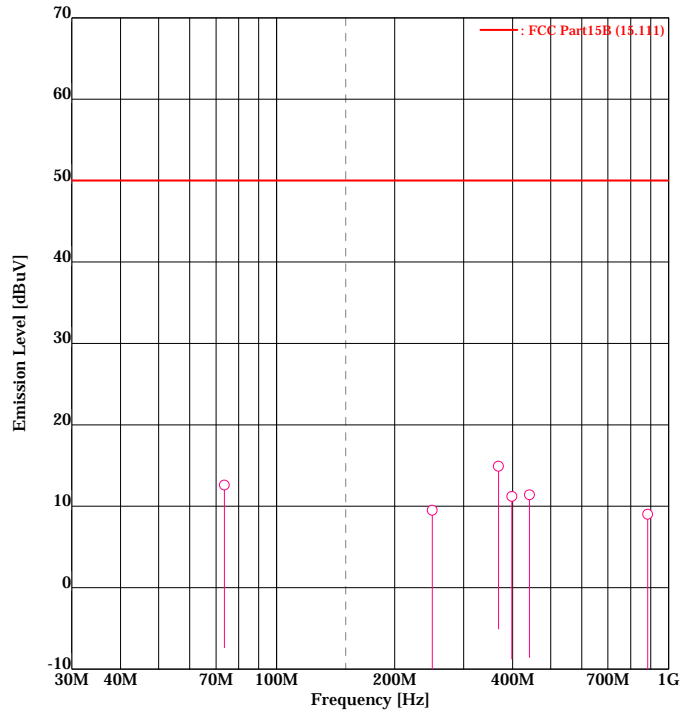

ENGINEER : Kazuo Masuda

FREQUENCY [No]	FREQUENCY [MHz]	READING [dBuV]	FACTOR [dB]	EMISSION [dBuV]	LIMIT [dBuV]	MARGIN [dB]
1	73.5900	<u>28.5</u>	-15.9	<u>12.6</u>	50.0	<u>37.4</u>
2	249.6000	<u>24.4</u>	-14.9	<u>9.5</u>	50.0	<u>40.5</u>
3	367.9800	<u>29.5</u>	-14.6	<u>14.9</u>	50.0	<u>35.1</u>
4	398.1300	<u>25.7</u>	-14.5	<u>11.2</u>	50.0	<u>38.8</u>
5	441.5800	<u>25.7</u>	-14.3	<u>11.4</u>	50.0	<u>38.6</u>
6	884.7400	<u>20.9</u>	-11.9	<u>9.0</u>	50.0	<u>41.0</u>

Higher six points are underlined.
 Other frequencies : Below the FCC Part15B (15.111) limit
 Emission Level = Read + Factor(Pad,Cable,Preamp)

9.3.2 Tuned Point 24.500 MHz mode (ANT1)

Akzo Nobel K. K.
Kashima No.1 Test Site
Conducted Power on Antenna Port

APPLICANT : Kenwood Corporation
 EUT NAME : HF / 50MHz All Mode Transceiver
 MODEL NO. : TS-480HX
 SERIAL NO. : None
 TEST MODE : Tuned Point 24.500MHz (ANT1)
 POWER SOURCE : DC13.8V (AC120V/60Hz)
 DATE TESTED : Nov 17 2004
 FILE NO. : ANKK-104323
 REGULATION : FCC Part15B (15.111)
 TEST METHOD : ANSI C63.4-2003
 TEMPERATURE : 23.0 [degC]
 HUMIDITY : 45.0 [%]
 NOTE :

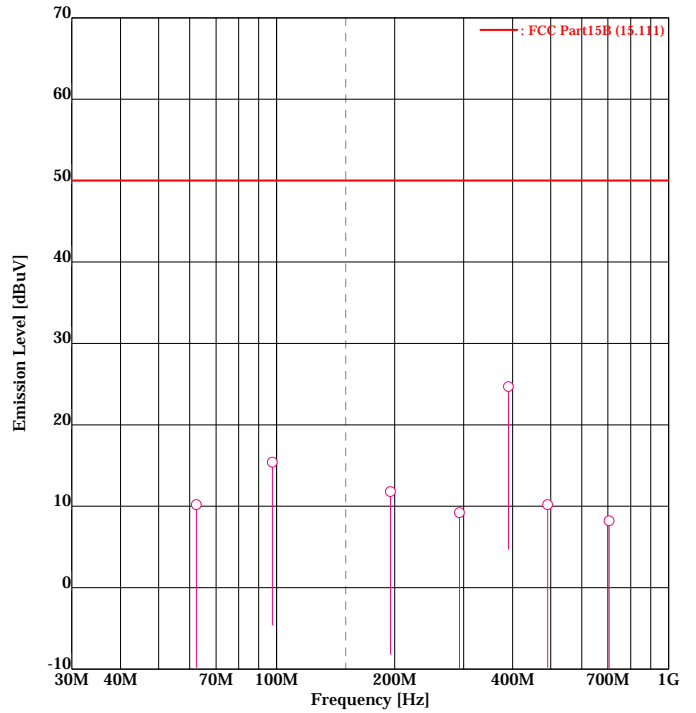

ENGINEER : Kazuo Masuda

FREQUENCY [No]	FREQUENCY [MHz]	READING [dBuV]	FACTOR [dB]	EMISSION [dBuV]	LIMIT [dBuV]	MARGIN [dB]
1	62.4000	<u>26.1</u>	-15.9	<u>10.2</u>	50.0	<u>39.8</u>
2	97.5900	<u>31.1</u>	-15.7	<u>15.4</u>	50.0	<u>34.6</u>
3	195.1900	<u>26.9</u>	-15.1	<u>11.8</u>	50.0	<u>38.2</u>
4	292.7900	<u>24.0</u>	-14.8	<u>9.2</u>	50.0	<u>40.8</u>
5	390.3800	<u>39.2</u>	-14.5	<u>24.7</u>	50.0	<u>25.3</u>
6	491.5100	<u>24.0</u>	-13.8	<u>10.2</u>	50.0	<u>39.8</u>
7	704.6500	21.3	-13.1	8.2	50.0	41.8

Higher six points are underlined.
 Other frequencies : Below the FCC Part15B (15.111) limit
 Emission Level = Read + Factor(Pad,Cable,Preamp)

9.3.3 Tuned Point 54.000 MHz mode (ANT1)

Akzo Nobel K. K.
Kashima No.1 Test Site
Conducted Power on Antenna Port

APPLICANT : Kenwood Corporation
 EUT NAME : HF / 50MHz All Mode Transceiver
 MODEL NO. : TS-480HX
 SERIAL NO. : None
 TEST MODE : Tuned Point 54.000MHz (ANT1)
 POWER SOURCE : DC13.8V (AC120V/60Hz)
 DATE TESTED : Nov 17 2004
 FILE NO. : ANKK-104323
 REGULATION : FCC Part15B (15.111)
 TEST METHOD : ANSI C63.4-2003
 TEMPERATURE : 23.0 [degC]
 HUMIDITY : 45.0 [%]
 NOTE :

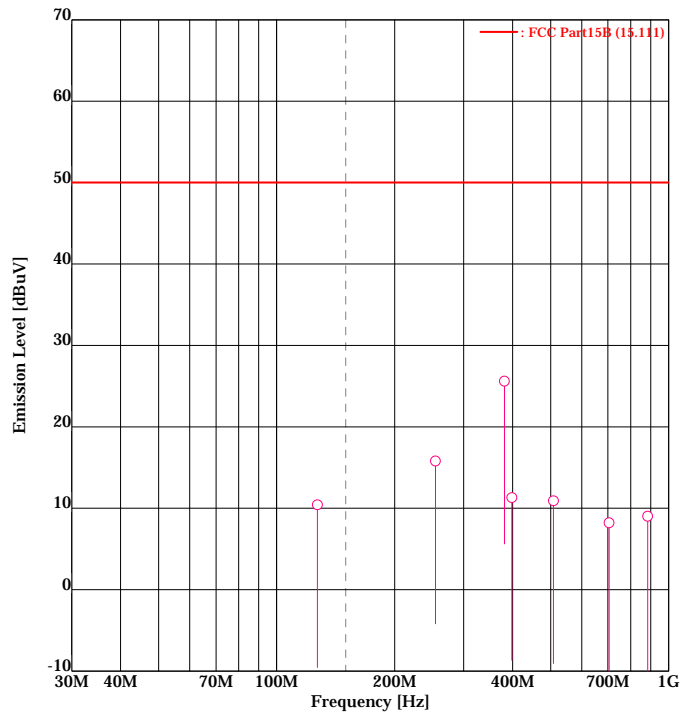

ENGINEER : Kazuo Masuda

FREQUENCY [No]	FREQUENCY [MHz]	READING [dBuV]	FACTOR [dB]	EMISSION [dBuV]	LIMIT [dBuV]	MARGIN [dB]
1	127.0900	<u>26.0</u>	-15.6	<u>10.4</u>	50.0	<u>39.6</u>
2	254.1900	<u>30.7</u>	-14.9	<u>15.8</u>	50.0	<u>34.2</u>
3	381.2900	<u>40.1</u>	-14.5	<u>25.6</u>	50.0	<u>24.4</u>
4	398.1200	<u>25.8</u>	-14.5	<u>11.3</u>	50.0	<u>38.7</u>
5	508.3800	<u>24.6</u>	-13.7	<u>10.9</u>	50.0	<u>39.1</u>
6	704.6500	21.3	-13.1	8.2	50.0	41.8
7	884.7300	<u>20.9</u>	-11.9	<u>9.0</u>	50.0	<u>41.0</u>

Higher six points are underlined.
 Other frequencies : Below the FCC Part15B (15.111) limit
 Emission Level = Read + Factor(Pad,Cable,Preamp)

9.3.4 VFO Scan mode (ANT1)

< Graph number #1 >

SPECTRUM ANALYSIS

Kashima No.1 Test Site

23.0BC/45.0%

Date tested : Nov 17 2004

Test mode : VFO Scan (ANT1)

Company : Kenwood Corporation

Power source : DC13.8V (AC120V/60Hz)

EUT Name : HF / 50MHz All Mode Transceiver

File number : ANKK-104323

Model number : TS-480HX

Engineer : Kazuo Masuda

Serial number : None

Note : Band : 0.030 - 59.999MHz

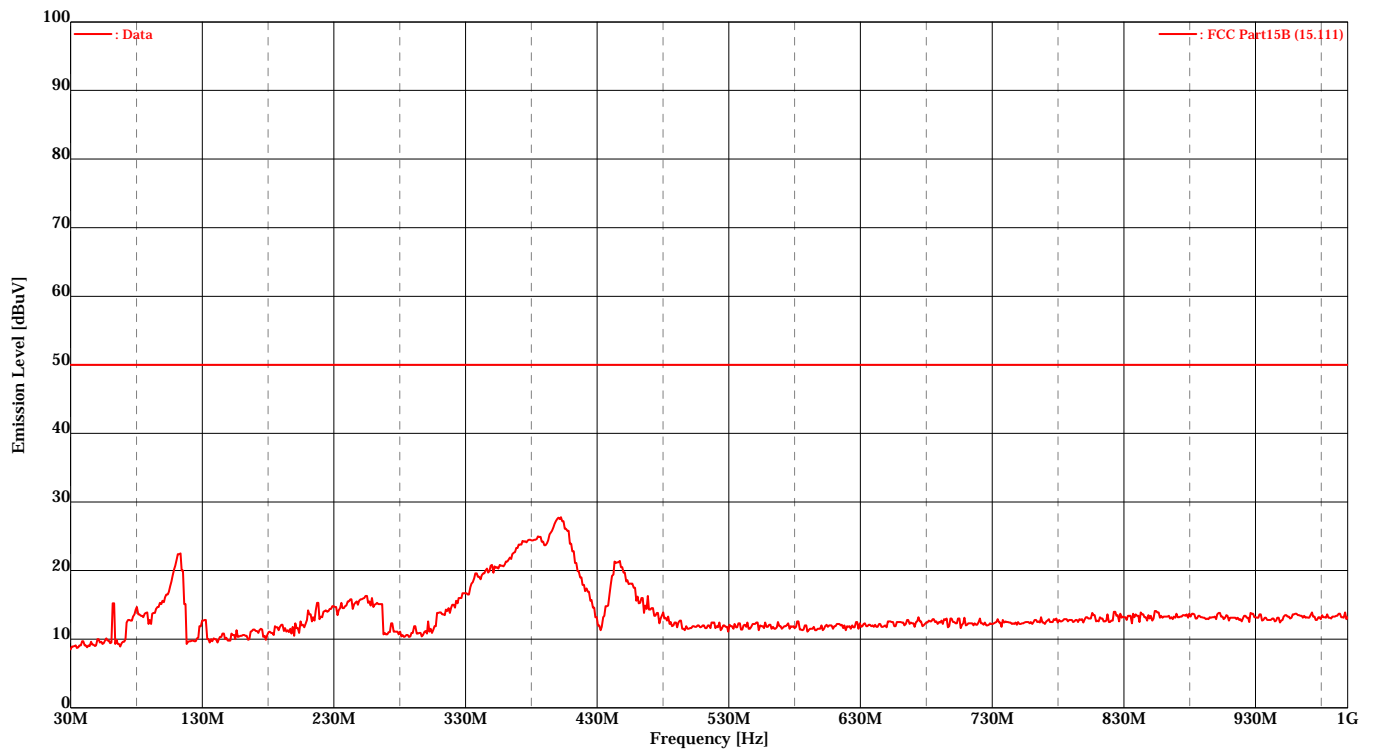

9.3.5 Tuned Point 0.500 MHz mode (ANT2)

Akzo Nobel K. K.
Kashima No.1 Test Site
Conducted Power on Antenna Port

APPLICANT : Kenwood Corporation
 EUT NAME : HF / 50MHz All Mode Transceiver
 MODEL NO. : TS-480HX
 SERIAL NO. : None
 TEST MODE : Tuned Point 0.500MHz (ANT2)
 POWER SOURCE : DC13.8V (AC120V/60Hz)
 DATE TESTED : Nov 17 2004
 FILE NO. : ANKK-104323
 REGULATION : FCC Part15B (15.111)
 TEST METHOD : ANSI C63.4-2003
 TEMPERATURE : 23.0 [degC]
 HUMIDITY : 45.0 [%]
 NOTE :

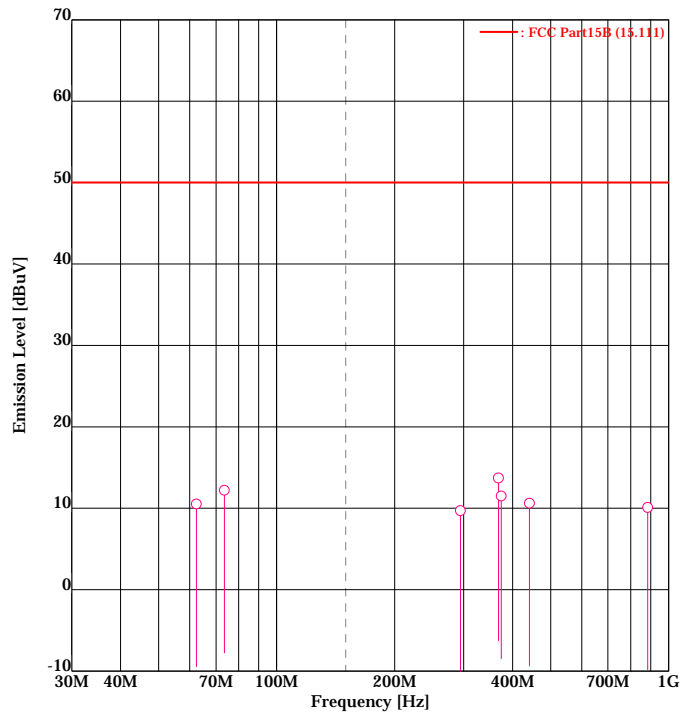

ENGINEER : Kazuo Masuda

FREQUENCY [No]	FREQUENCY [MHz]	READING [dBuV]	FACTOR [dB]	EMISSION [dBuV]	LIMIT [dBuV]	MARGIN [dB]
1	62.4000	<u>26.4</u>	-15.9	<u>10.5</u>	50.0	<u>39.5</u>
2	73.5900	<u>28.1</u>	-15.9	<u>12.2</u>	50.0	<u>37.8</u>
3	294.3800	24.5	-14.8	9.7	50.0	40.3
4	367.9800	<u>28.3</u>	-14.6	<u>13.7</u>	50.0	<u>36.3</u>
5	374.4000	<u>26.1</u>	-14.6	<u>11.5</u>	50.0	<u>38.5</u>
6	441.5800	<u>24.9</u>	-14.3	<u>10.6</u>	50.0	<u>39.4</u>
7	884.7300	<u>22.0</u>	-11.9	<u>10.1</u>	50.0	<u>39.9</u>

Higher six points are underlined.
 Other frequencies : Below the FCC Part15B (15.111) limit
 Emission Level = Read + Factor(Pad,Cable,Preamp)

9.3.6 Tuned Point 24.500 MHz mode (ANT2)

Akzo Nobel K. K.
Kashima No.1 Test Site
Conducted Power on Antenna Port

APPLICANT : Kenwood Corporation
 EUT NAME : HF / 50MHz All Mode Transceiver
 MODEL NO. : TS-480HX
 SERIAL NO. : None
 TEST MODE : Tuned Point 24.500MHz (ANT2)
 POWER SOURCE : DC13.8V (AC120V/60Hz)
 DATE TESTED : Nov 17 2004
 FILE NO. : ANKK-104323
 REGULATION : FCC Part15B (15.111)
 TEST METHOD : ANSI C63.4-2003
 TEMPERATURE : 23.0 [degC]
 HUMIDITY : 45.0 [%]
 NOTE :

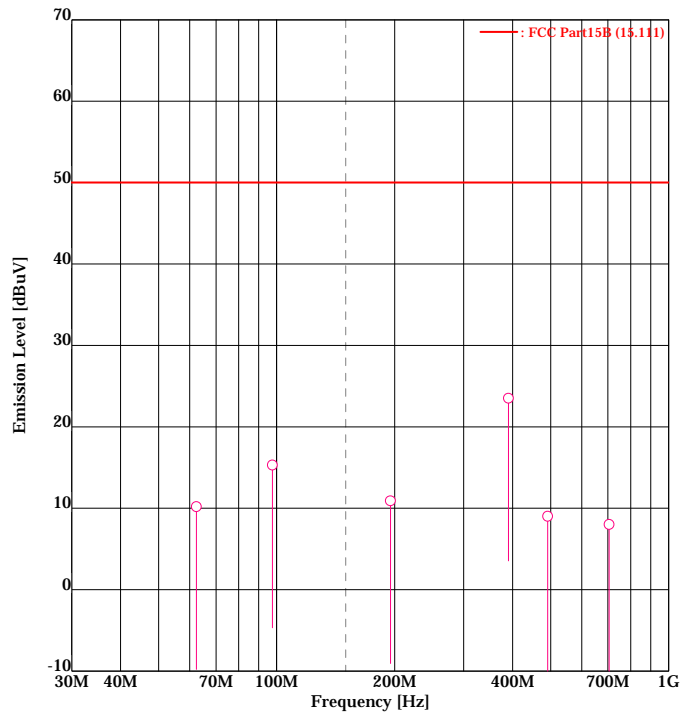

ENGINEER : Kazuo Masuda

FREQUENCY [No]	FREQUENCY [MHz]	READING [dBuV]	FACTOR [dB]	EMISSION [dBuV]	LIMIT [dBuV]	MARGIN [dB]
1	62.4000	<u>26.1</u>	-15.9	<u>10.2</u>	50.0	<u>39.8</u>
2	97.5900	<u>31.0</u>	-15.7	<u>15.3</u>	50.0	<u>34.7</u>
3	195.1900	<u>26.0</u>	-15.1	<u>10.9</u>	50.0	<u>39.1</u>
4	390.3800	<u>38.0</u>	-14.5	<u>23.5</u>	50.0	<u>26.5</u>
5	491.5200	<u>22.8</u>	-13.8	<u>9.0</u>	50.0	<u>41.0</u>
6	704.6500	<u>21.1</u>	-13.1	<u>8.0</u>	50.0	<u>42.0</u>

Higher six points are underlined.
 Other frequencies : Below the FCC Part15B (15.111) limit
 Emission Level = Read + Factor(Pad,Cable,Preamp)

9.3.7 Tuned Point 54.000 MHz mode (ANT2)

Akzo Nobel K. K.
Kashima No.1 Test Site
Conducted Power on Antenna Port

APPLICANT : Kenwood Corporation
 EUT NAME : HF / 50MHz All Mode Transceiver
 MODEL NO. : TS-480HX
 SERIAL NO. : None
 TEST MODE : Tuned Point 54.000MHz (ANT2)
 POWER SOURCE : DC13.8V (AC120V/60Hz)
 DATE TESTED : Nov 17 2004
 FILE NO. : ANKK-104323
 REGULATION : FCC Part15B (15.111)
 TEST METHOD : ANSI C63.4-2003
 TEMPERATURE : 23.0 [degC]
 HUMIDITY : 45.0 [%]
 NOTE :

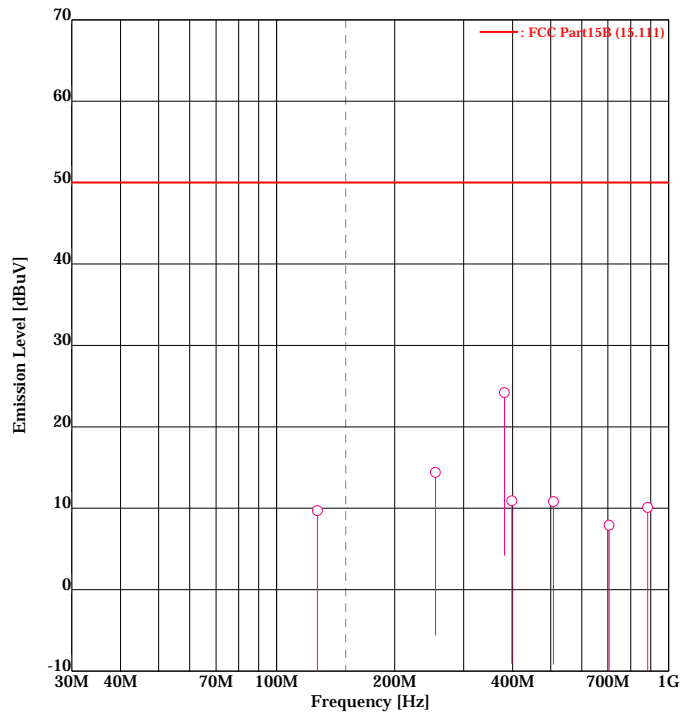

ENGINEER : Kazuo Masuda

FREQUENCY [No]	FREQUENCY [MHz]	READING [dBuV]	FACTOR [dB]	EMISSION [dBuV]	LIMIT [dBuV]	MARGIN [dB]
1	127.0900	<u>25.3</u>	-15.6	<u>9.7</u>	50.0	<u>40.3</u>
2	254.1900	<u>29.3</u>	-14.9	<u>14.4</u>	50.0	<u>35.6</u>
3	381.2900	<u>38.7</u>	-14.5	<u>24.2</u>	50.0	<u>25.8</u>
4	398.1200	<u>25.4</u>	-14.5	<u>10.9</u>	50.0	<u>39.1</u>
5	508.3800	<u>24.5</u>	-13.7	<u>10.8</u>	50.0	<u>39.2</u>
6	704.6500	21.0	-13.1	7.9	50.0	42.1
7	884.7300	<u>22.0</u>	-11.9	<u>10.1</u>	50.0	<u>39.9</u>

Higher six points are underlined.
 Other frequencies : Below the FCC Part15B (15.111) limit
 Emission Level = Read + Factor(Pad,Cable,Preamp)

9.3.8 VFO Scan mode (ANT2)

< Graph number #2 >

SPECTRUM ANALYSIS

Kashima No.1 Test Site

23.0BC/45.0%

Date tested : Nov 17 2004

Test mode : VFO Scan (ANT2)

Company : Kenwood Corporation

Power source : DC13.8V (AC120V/60Hz)

EUT Name : HF / 50MHz All Mode Transceiver

File number : ANKK-104323

Model number : TS-480HX

Engineer : Kazuo Masuda

Serial number : None

Note : Band : 0.030 - 59.999MHz

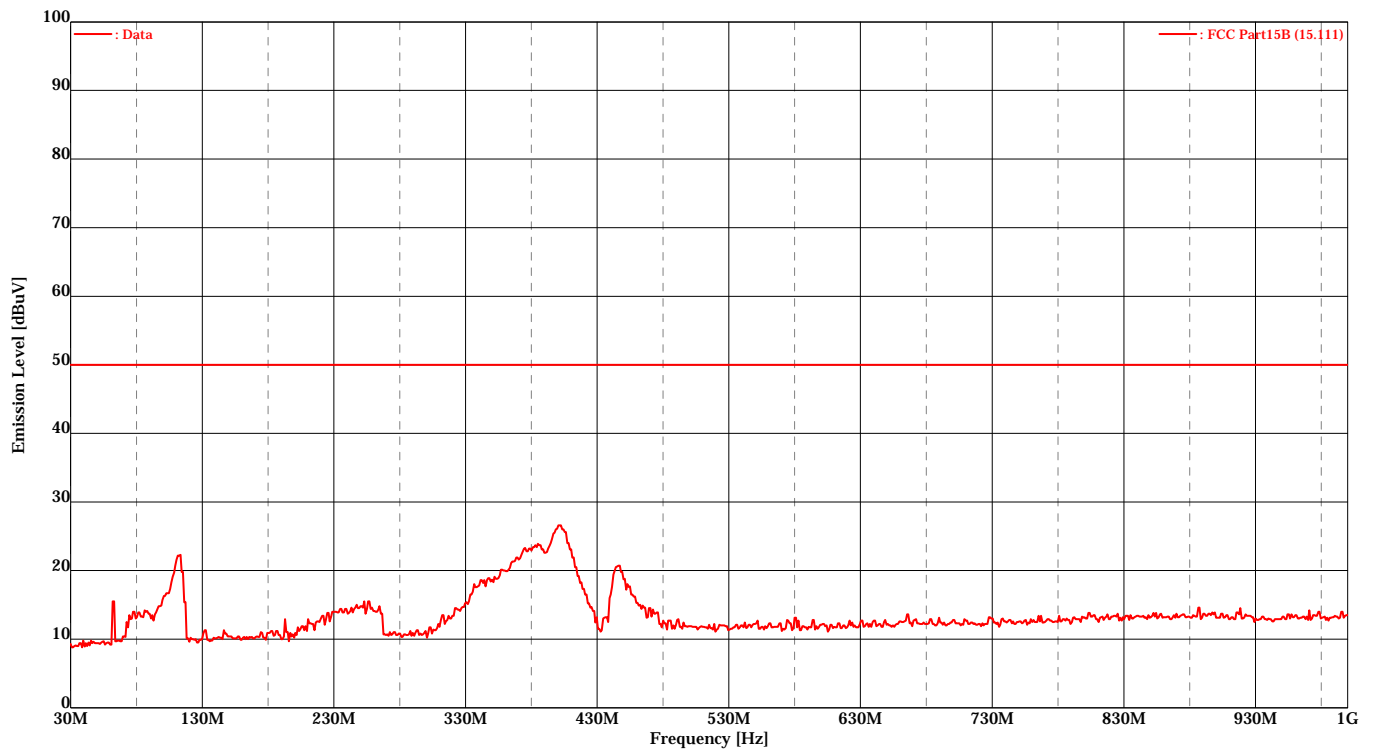

9.4 38dB Rejection Test

9.4.1 VFO Scan mode (ANT1)

Location : Kashima No.1 Test Site
 Date Tested : November 18, 2004
 Temperature : 20 [degC]
 Humidity : 63 [%]
 Engineer : Kazuo Masuda

Injected Frequency [MHz]	Detected Frequency [MHz]	12dB SINAD Reading Injected Frequency [dBm]	12dB SINAD Reading Detected Frequency [dBm]	Rejection Level [dB]	Margin [dB]
824.040	No Point Detected	N / A	N / A	N / A	N / A
836.505	No Point Detected	N / A	N / A	N / A	N / A
848.970	No Point Detected	N / A	N / A	N / A	N / A
869.040	No Point Detected	N / A	N / A	N / A	N / A
881.505	No Point Detected	N / A	N / A	N / A	N / A
893.970	No Point Detected	N / A	N / A	N / A	N / A

The Audio Analyzer condition :
 12dB SINAD measurement level = 70mV

9.4.2 VFO Scan mode (ANT2)

Location : Kashima No.1 Test Site
Date Tested : November 18, 2004
Temperature : 20 [degC]
Humidity : 63 [%]
Engineer : Kazuo Masuda

Injected Frequency [MHz]	Detected Frequency [MHz]	12dB SINAD Reading Injected Frequency [dBm]	12dB SINAD Reading Detected Frequency [dBm]	Rejection Level [dB]	Margin [dB]
824.040	No Point Detected	N / A	N / A	N / A	N / A
836.505	No Point Detected	N / A	N / A	N / A	N / A
848.970	No Point Detected	N / A	N / A	N / A	N / A
869.040	No Point Detected	N / A	N / A	N / A	N / A
881.505	No Point Detected	N / A	N / A	N / A	N / A
893.970	No Point Detected	N / A	N / A	N / A	N / A

The Audio Analyzer condition :
12dB SINAD measurement level = 70mV

9.5 Sample Calculations

9.5.1 Conducted Voltages on Mains Port

Example @ 2.8547 MHz (AVG)

Emission Level	=	Meter Reading	34.8	dBuV
	+	Factor	5.8	dB
			<hr/>	
	=		40.6	dBuV
Margin	=	Limit	46.0	dBuV
	-	Emission Level	40.6	dBuV
			<hr/>	
	=		5.4	dB

Factor = LISN Factor + Cable Loss + Pad Loss

9.5.2 Radiated Electric Field

Example @ 381.28 MHz

Emission Level	=	Meter Reading	41.2	dBuV
	+	Factor	2.3	dB/m
			<hr/>	
	=		38.9	dBuV/m
Margin	=	Limit	46.0	dBuV/m
	-	Emission Level	38.9	dBuV/m
			<hr/>	
	=		7.1	dB

Factor = Antenna Factor + Cable Loss - Amplifier Gain + Pad Loss

9.5.3 Conducted Power on Antenna Port

Example @ 381.29 MHz

Output Power Level	=	Meter Reading		40.1	dBuV
	+	Factor		14.5	dB
				<hr/>	
				=	25.6 dBuV
Margin	=	Limit (:2.0nW)		50.0	dBuV
	-	Output Power Level		25.6	dBuV
				<hr/>	
				=	24.4 dB

Factor = Cable Loss – Amplifier Gain + Pad Loss

9.5.4 38dB Rejection

Example @ N/A MHz

Rejection Level	=	12dB SINAD Reading at Injected Frequency		N/A	dBm
	-	12dB SINAD Reading at Detected Frequency		N/A	dBm
				<hr/>	
				=	N/A dB
Margin	=	Rejection Level		N/A	dB
	-	Limit		38.0	dB
				<hr/>	
				=	N/A dB

SECTION 10. INSTRUMENTS USED FOR FINAL TEST

Instrument	Model No.	Serial No.	Manufacturer	Cal.expired
LISN (EUT)	ESH2-Z5	881492/014	ROHDE & SCHWARZ	Oct. 31, 05
6dB Attenuator	CFA-01	None	TME	Oct. 31, 05
LISN (Peripheral)	KNW-242	8-851-22	KYORITSU	Oct. 31, 05
50Ω Termination	CT-01	A010CON50	TME	Jul. 31, 05
Coaxial cable	5D-2W (7.0 m)	C1	AKZO	Oct. 31, 05
	5D-2W (2.0 m)	C2	AKZO	Oct. 31, 05
	5D-2W (1.0 m)	R6	AKZO	Oct. 31, 05
	5D-2W (1.0 m)	R7	AKZO	Oct. 31, 05
Broad Band antenna	VULB9168	106	Schwarzbeck	Feb. 30, 05
Double Ridged antenna	3115	5044	EMCO	Jun. 30, 05
6dB Attenuator	MP721B	M57593	ANRITSU	Oct. 31, 05
3dB Attenuator	4768-3	79	NARDA	Sep. 30, 05
Step Attenuator	8494B	2726A14513	HEWLETT PACKARD	Oct. 31, 05
Amplifier	8447D	1937A03130	HEWLETT PACKARD	Oct. 31, 05
	83051A	3332A00329	HEWLETT PACKARD	Sep. 30, 05
Coaxial cable	5D-2W (9.0 m)	R1	AKZO	Oct. 31, 05
	10D-2W (5.5 m)	R2	AKZO	Oct. 31, 05
	5D-2W (2.0 m)	R3	AKZO	Oct. 31, 05
	5D-2W (0.2 m)	R4	AKZO	Oct. 31, 05
	5D-2W (1.0 m)	R5	AKZO	Oct. 31, 05
	5D-2W (1.0 m)	R6	AKZO	Oct. 31, 05
	5D-2W (1.0 m)	R7	AKZO	Oct. 31, 05
	SUCOFLEX102 (1.0 m)	R14	SUHNER	Sep. 30, 05
	KPS-1501-1969-KPS (5.0 m)	R15	INSULATED WIRE	Sep. 30, 05
Test receiver	ESS (Firmware Version 1.08)	842123/005	ROHDE & SCHWARZ	Oct. 31, 05
Spectrum Analyzer	8564E	3643A00665	HEWLETT PACKARD	Aug. 31, 05
RF Switch	ACX-150	None	AKZO	Oct. 31, 05
Site Attenuation				Apr. 30, 05

Instrument	Model No.	Serial No.	Manufacturer	Cal.expired
ANT Termination	CT-01	A030CON50	TME	Jul. 31, 05
	CT-01	A040CON50	TME	Jul. 31, 05
Signal Generator	SMG	860289/011	ROHDE & SCHWARZ	May 31, 05
Audio (-BNC) cable	None(1.0 m)	None	KENWOOD	Nov.30, 05
Audio Analyzer	VA-2230	3080029	KENWOOD	Aug. 31, 05

Note : Test instruments are calibrated according to Quality Manual and Calibration Rules of EMC division.

SECTION 11. MEASUREMENT UNCERTAINTY

The uncertainty of the measurements performed for this report lies:

Radiated Electric Field at 3m

30 MHz – 1000 MHz	+/- 4.07 dB
Above 1 GHz	+/- 3.90 dB

Conducted Voltages on Mains Port

9 kHz – 30 MHz	+/- 2.45 dB
----------------------	-------------

Conducted Power on Antenna Port

30 MHz – 1000 MHz	+/- 2.50 dB
-------------------------	-------------

38dB Rejection

30 kHz – 60 MHz	+/- 0.71 dB
-----------------------	-------------

Note on Radiated Electric Field measurement uncertainty

The following items are not included in the calculations in spite of their own uncertainty components because it is impracticable to find the value. It is our problem awaiting solution in future.

(1) Repeatability of measurement

It is not possible to calculate repeatability since the measurement was carried out only one time.

(2) Antenna factor variation

The definition of measured (radiated electric field strength) is not completed on the referred standard(s).

(3) Loss of EUT radiation propagation

It is certainly one of the uncertainty components, however is not able to calculate.

Please note that these uncertainties are not reflected to the compliance judgement of the test results in this report.

SECTION 12. DESCRIPTION OF TEST LABORATORY

12.1 Outline of Akzo Nobel K. K. (formerly Akzo Kashima Limited), EMC Division

Akzo Nobel K. K., the country organization in Japan for Akzo Nobel NV, was established in 1968. The shares are owned by Akzo Nobel NV (100%). Akzo Nobel NV, headquartered in the Netherlands, is one of the world's leading companies in selected areas of chemicals, coatings, healthcare products and fibers with work force of approximately 70,000 people in over 50 countries.

In 1984, in order to respond to the growing testing demand, in particular, for FCC filing, Akzo Nobel K. K. started EMI testing business, installing the first open air test site in Kashima, Ibaraki prefecture. Further the business has been expanded by installing additional testing facilities not only in Ibaraki but also in other areas such as Shizuoka, Nagano, Kanagawa and Tochigi. As results, Akzo Nobel K. K. has now 16 open air test sites and 4 anechoic chambers for EMI/EMC testing. As the largest EMC testing laboratory in number of testing facilities and staffs, EMC Division has been organized separately in the company and independently operated in conformity with the requirements of ISO/IEC17025 for its competency as a testing laboratory.

Akzo Nobel K. K. EMC Division is the first foreign private laboratory accredited by NVLAP, National Voluntary Laboratory Accreditation Program-NIST, USA. The division has been certified, authorized and/or filed as a competent testing laboratory by various testing organizations/authorities as described below.

12.2 Filing, certification, authorization and accreditation list

<u>EMI/EMC testing</u>		<u>Telecommunications terminal testing</u>	
FCC	(USA)	FCC	(USA)
NVLAP	(USA)	NVLAP	(USA)
NEMKO	(Norway)	NATA	(Australia)
VCCI	(Japan)	IC	(Canada)
VLAC	(Japan)		
ETL SEMKO	(Sweden)		
TÜV PRODUCT SERVICE	(Germany)		
BSMI	(Taiwan)		

Note 1 : NVLAP accreditation does not constitute any product endorsement by NVLAP or any agent of the U.S. Government.