

HCT CO., LTD.

CERTIFICATE OF COMPLIANCE FCC Certification

Applicant Name: Pantech Co., Ltd.	Date of Issue: July 30, 2012
Address: Pantech Bldg, I-2, DMC, Sangam-dong, Mapo-gu, Seoul, 121-792, Korea	Location: HCT CO., LTD., 105-1, Jangam-ri, Majang-Myeon, Icheon-si, Kyunggi-Do, Korea
	Test Report No.: HCTR1207FR06-1
	HCT FRN: 0005866421

FCC ID : JYCSPARKLE

APPLICANT : Pantech Co., Ltd.

FCC Model(s):	UML295
EUT Type:	CDMA/GSM/WCDMA/LTE Data Dongle
Tx Frequency:	824.70 — 848.31 MHz (CDMA) 1 851.25 — 1 908.75 MHz (PCS CDMA)
Rx Frequency:	869.70 — 893.31 MHz (CDMA) 1 931.25 — 1 988.75 MHz (PCS CDMA)
Max. RF Output Power:	0.206 W ERP CDMA (23.13 dBm)/ 0.369 W EIRP PCS CDMA (25.67 dBm) 0.230 W ERP CDMA EVDO (23.62 dBm)/ 0.695 W EIRP PCS EVDO (28.42 dBm)
Emission Designator(s):	1M28F9W (CDMA), 1M28F9W (PCS CDMA), 1M27F9W (CDMA EVDO), 1M27F9W (PCS CDMA EVDO)
FCC Classification:	PCS Licensed Transmitter (PCB)
FCC Rule Part(s):	§22, §24, §2

The measurements shown in this report were made in accordance with the procedures specified in §2.947. I assume full responsibility for the accuracy and completeness of these measurements, and for the qualifications of all persons taking them.

HCT CO., LTD. Certifies that no party to this application has subject to a denial of Federal benefits that includes FCC benefits pursuant to section 5301 of the Anti-Drug Abuse Act of 1998, 21 U.S. C.853(a)

 <hr/> Report prepared by : Hyo Sun Kwak Test engineer of RF Team	 <hr/> Approved by : Sang Jun Lee Manager of RF Team
--	---

This report only responds to the tested sample and may not be reproduced, except in full, without written approval of the HCT Co., Ltd.

FCC CERTIFICATION REPORT			www.hct.co.kr
Test Report No. HCTR1207FR06-1	Date of Issue: July 30, 2017	EUT Type: CDMA/GSM/WCDMA/LTE Data Dongle	FCC ID: JYCSPARKLE

Version

TEST REPORT NO.	DATE	DESCRIPTION
HCTR1207FR06	July 18, 2012	- First Approval Report
HCTR1207FR06-1	July 30, 2012	-Revise page 1 and 4

Table of Contents

1. GENERAL INFORMATION	4
2. INTRODUCTION	5
2.1. EUT DESCRIPTION.....	5
2.2. MEASURING INSTRUMENT CALIBRATION.....	5
2.3. TEST FACILITY	5
3. DESCRIPTION OF TESTS	6
3.1 EFFECTIVE RADIATED POWER/EQUIVALENT ISOTROPIC RADIATED POWER.....	6
3.2 PEAK- TO- AVERAGE RATIO	7
3.3 OCCUPIED BANDWIDTH.	8
3.4 SPURIOUS AND HARMONIC EMISSIONS AT ANTENNA TERMINAL.....	9
3.5 RADIATED SPURIOUS AND HARMONIC EMISSIONS.....	10
3.6 FREQUENCY STABILITY / VARIATION OF AMBIENT TEMPERATURE	11
4. LIST OF TEST EQUIPMENT	12
5. SUMMARY OF TEST RESULTS	13
6. SAMPLE CALCULATION	14
7. TEST DATA	15
7.1 CONDUCTED OUTPUT POWER	15
7.2 PEAK-TO-AVERAGE RATIO	16
7.3 OCCUPIED BANDWIDTH	16
7.4 CONDUCTED SPURIOUS EMISSIONS	17
7.4.1 Band Edge	17
7.5 EFFECTIVE RADIATED POWER OUTPUT	18
7.6 EQUIVALENT ISOTROPIC RADIATED POWER	19
7.7 RADIATED SPURIOUS EMISSIONS	20
7.7.1 RADIATED SPURIOUS EMISSIONS (CDMA Mode).....	20
7.7.2 RADIATED SPURIOUS EMISSIONS (PCS Mode)	21
7.8 FREQUENCY STABILITY / VARIATION OF AMBIENT TEMPERATURE	22
7.8.1 FREQUENCY STABILITY (CDMA).....	22
7.8.2 FREQUENCY STABILITY (PCS CDMA)	23
8. TEST PLOTS.....	24

FCC CERTIFICATION REPORT			www.hct.co.kr
Test Report No. HCTR1207FR06-1	Date of Issue: July 30, 2017	EUT Type: CDMA/GSM/WCDMA/LTE Data Dongle	FCC ID: JYCSPARKLE

MEASUREMENT REPORT

1. GENERAL INFORMATION

Applicant Name: Pantech Co., Ltd.

Address: Pantech Bldg, I-2, DMC, Sangam-dong, Mapo-gu, Seoul, 121-792, Korea

FCC ID: JYCSPARKLE

Application Type: Certification

FCC Classification: PCS Licensed Transmitter (PCB)

FCC Rule Part(s): §22, §24, §2,

EUT Type: CDMA/GSM/WCDMA/LTE Data Dongle

FCC Model(s): UML295

Tx Frequency: 824.70 — 848.31 MHz (CDMA)
1 851.25 — 1 908.75 MHz (PCS CDMA)

Rx Frequency: 869.70 — 893.31 MHz (CDMA)
1 931.25 — 1 988.75 MHz (PCS CDMA)

Max. RF Output Power: 0.206 W ERP CDMA (23.13 dBm)/ 0.369 W EIRP PCS CDMA (25.67 dBm)
0.230 W ERP CDMA EVDO (23.62 dBm)/ 0.695 W EIRP PCS EVDO (28.42 dBm)

Emission Designator(s): 1M28F9W (CDMA), 1M28F9W (PCS CDMA),
1M27F9W (CDMA EVDO), 1M27F9W (PCS CDMA EVDO)

Date(s) of Tests: June 10, 2012 ~ July 13, 2012

Antenna Specification Manufacturer: Karam Solution
Antenna type: INTERNAL Antenna
Peak Gain: CDMA : 0.67 dBi
PCS CDMA : 5.12 dBi

FCC CERTIFICATION REPORT			www.hct.co.kr
Test Report No. HCTR1207FR06-1	Date of Issue: July 30, 2017	EUT Type: CDMA/GSM/WCDMA/LTE Data Dongle	FCC ID: JYCSPARKLE

2. INTRODUCTION

2.1. EUT DESCRIPTION

The UML295 CDMA/GSM/WCDMA/LTE Data Dongle consists of Cellular CDMA, PCS CDMA, 1xRTT and EVDO Rev.0,A.

2.2. MEASURING INSTRUMENT CALIBRATION

The measuring equipment, which was utilized in performing the tests documented herein, has been calibrated in accordance with the manufacturer's recommendations for utilizing calibration equipment, which is traceable to recognized national standards.

2.3. TEST FACILITY

The SAC(Semi-Anechoic Chamber) and conducted measurement facility used to collect the radiated data are located at the 105-1, Jangam-ri, Majang-Myeon, Icheon-si, Kyunggi-Do, 467-811, Korea. The site is constructed in conformance with the requirements of ANSI C63.4 and CISPR Publication 22. Detailed description of test facility was submitted to the Commission and accepted dated March 02, 2011 (Registration Number: 90661)

FCC CERTIFICATION REPORT			www.hct.co.kr
Test Report No. HCTR1207FR06-1	Date of Issue: July 30, 2017	EUT Type: CDMA/GSM/WCDMA/LTE Data Dongle	FCC ID: JYCSPARKLE

3. DESCRIPTION OF TESTS

3.1 EFFECTIVE RADIATED POWER/EQUIVALENT ISOTROPIC RADIATED POWER

Test Set-up

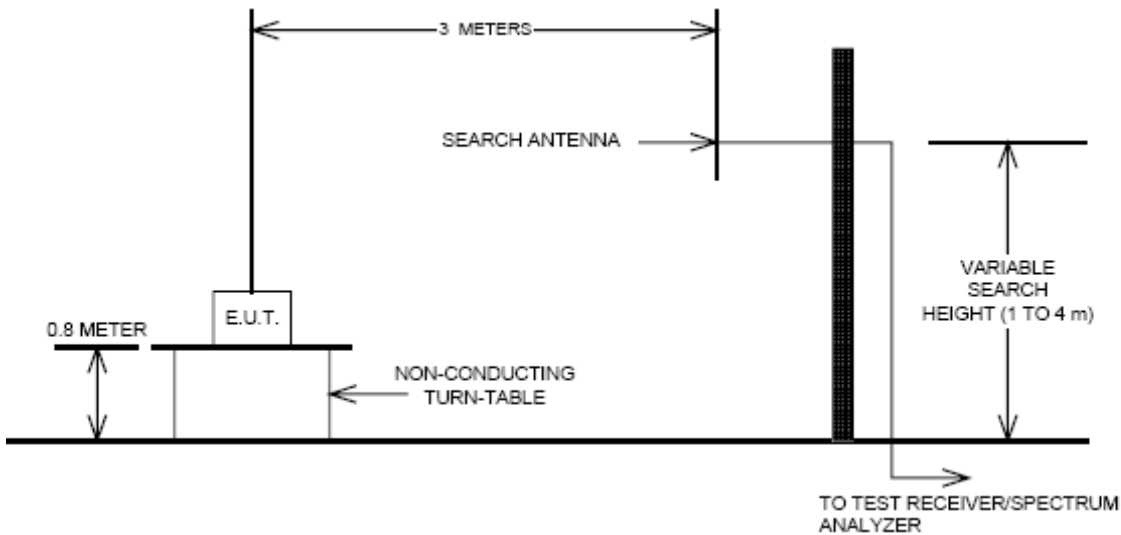

Test Procedure

emission measurements were performed at an Fully-anechoic chamber.

The equipment under test is placed on a non-conductive table 3-meters from the receive antenna. A turntable was rotated 360° and the receiving antenna scanned from 1-4m in order to capture the maximum emission. A half wave dipole was substituted in place of the EUT. This dipole antenna was driven by a signal generator and the previously recorded signal was duplicated.

The maximum EIRP was calculated by adding the forward power to the calibrated source plus its appropriate gain value. These steps were carried out with the receiving antenna in both vertical and horizontal polarization. For readings above 1GHz, the above procedure is repeated using horn antennas and the difference between the gain of the horn and an isotropic antenna are taken into consideration

Note : This device was tested under all R.C.s and S.O.s and worst case is reported with RC3/SO55(CDMA) and RC1/SO55(PCS) with 'All Up' power control bits.

FCC CERTIFICATION REPORT			www.hct.co.kr
Test Report No. HCTR1207FR06-1	Date of Issue: July 30, 2017	EUT Type: CDMA/GSM/WCDMA/LTE Data Dongle	FCC ID: JYCSPARKLE

3.2 PEAK- TO- AVERAGE RATIO

A peak to average ratio measurement is performed at the conducted port of the EUT. For CDMA and WCDMA signals, the spectrum analyzers Complementary Cumulative Distribution Function (CCDF) measurement profile is used to determine the largest deviation between the average and the peak power of the EUT in a given bandwidth. The CCDF curve shows how much time the peak waveform spends at or above a given average power level. The percent of time the signal spends at or above the level defines the probability for that particular power level. For GSM signals, an average and a peak trace are used on a spectrum analyzer to determine the largest deviation between the average and the peak power of the EUT in a bandwidth greater than the emission bandwidth. Plots of the EUT's Peak- to- Average Ratio are shown herein.

Note : This device was tested under all R.C.s and S.O.s and worst case is reported with RC3/SO55(CDMA) and RC1/SO55(PCS) with 'All Up' power control bits.

FCC CERTIFICATION REPORT			www.hct.co.kr
Test Report No. HCTR1207FR06-1	Date of Issue: July 30, 2017	EUT Type: CDMA/GSM/WCDMA/LTE Data Dongle	FCC ID: JYCSPARKLE

3.3 OCCUPIED BANDWIDTH.

Test set-up

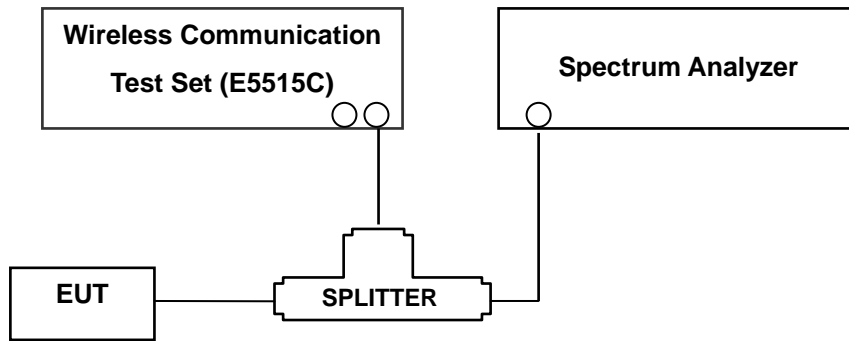

(Configuration of conducted Emission measurement)

The width of a frequency band such that, below the lower and above the upper frequency limits, the mean powers emitted are each equal to a specified percentage 0.5 % of the total mean power of a given emission.

Test Procedure

The EUT makes a call to the communication simulator. The power was measured with R&S Spectrum Analyzer. All measurements were done at 3 channels(low, middle and high operational range.)

The conducted occupied bandwidth used the power splitter via EUT RF power connector between simulation base station and spectrum analyzer.

The communication simulator station system controlled a EUT to export maximum output power under transmission mode and specific channel frequency. Use OBW measurement function of Spectrum analyzer to measure 99 % occupied bandwidth

Note : This device was tested under all R.C.s and S.O.s and worst case is reported with RC3/SO55(CDMA) and RC1/SO55(PCS) with 'All Up' power control bits.

FCC CERTIFICATION REPORT			www.hct.co.kr
Test Report No. HCTR1207FR06-1	Date of Issue: July 30, 2017	EUT Type: CDMA/GSM/WCDMA/LTE Data Dongle	FCC ID: JYCSPARKLE

3.4 SPURIOUS AND HARMONIC EMISSIONS AT ANTENNA TERMINAL.

Test Procedure

The level of the carrier and the various conducted spurious and harmonic frequencies is measured by means of a calibrated spectrum analyzer.

The EUT was setup to maximum output power at its lowest channel. The Resolution BW of the analyzer is set to < 1 % of the emission bandwidth to show compliance with the – 13 dBm limit, in the 1 MHz bands immediately outside and adjacent to the edge of the frequency block. The 1 MHz RBW was used to scan from 10 MHz to 10 GHz. (GSM1900 Mode: 10 MHz to 20 GHz). A display line was placed at – 13 dBm to show compliance. The high, lowest and a middle channel were tested for out of band measurements.

- Band Edge Requirement : In the 1MHz bands immediately outside and adjacent to the frequency block, a resolution bandwidth of at least 1 percent of the emission bandwidth of the fundamental emission of the transmitter may be employed to measure the out of band Emissions. Limit, -13dBm.

Note : This device was tested under all R.C.s and S.O.s and worst case is reported with RC3/SO55(CDMA) and RC1/SO55(PCS) with 'All Up' power control bits.

FCC CERTIFICATION REPORT			www.hct.co.kr
Test Report No. HCTR1207FR06-1	Date of Issue: July 30, 2017	EUT Type: CDMA/GSM/WCDMA/LTE Data Dongle	FCC ID: JYCSPARKLE

3.5 RADIATED SPURIOUS AND HARMONIC EMISSIONS

Test Set-up

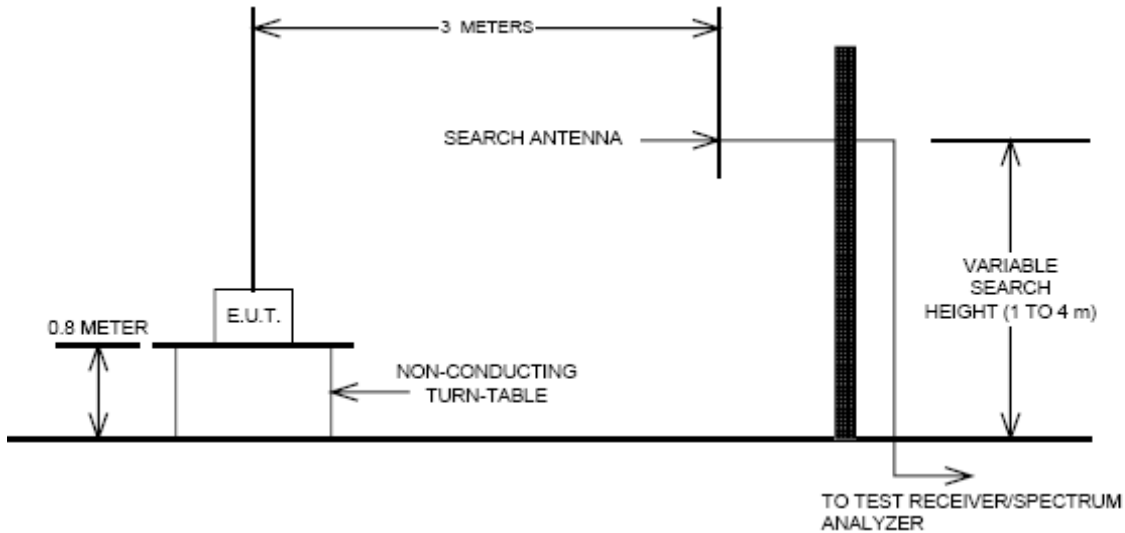

The measurement facilities used for this test have been documented in previous filings with the commission pursuant to section § 2.948. The Fully-anechoic chamber meets requirements in ANSI C63.4 –2003. A mast capable of lifting the receiving antenna from a height of one to four meters is used together with a rotatable platform mounted at three from the antenna mast.

- 1) The unit mounted on a turntable 1.5 m × 1.0 m × 0.80 m is 0.8 meter above test site ground level.
- 2) During the emission test, the turntable is rotated and the EUT is manipulated to find the configuration resulting in maximum emission under normal condition of installation and operation.
- 3) The antenna height and polarization are also varied from 1 to 4 meters until the maximum signal is found.
- 4) The spectrum shall be scanned up to the 10th harmonic of the fundamental frequency.

Test Procedure

The equipment under test is placed on a non-conductive table 3-meters from the receive antenna. A turntable was rotated 360° and the receiving antenna scanned from 1-4m in order to capture the maximum emission. A half wave dipole was substituted in place of the EUT. This dipole antenna was driven by a signal generator and the previously recorded signal was duplicated.

The maximum EIRP was calculated by adding the forward power to the calibrated source plus its appropriate gain value. These steps were carried out with the receiving antenna in both vertical and horizontal polarization. For readings above 1GHz, the above procedure is repeated using horn antennas and the difference between the gain of the horn and an isotropic antenna are taken into consideration.

Note : This device was tested under all R.C.s and S.O.s and worst case is reported with RC3/SO55(CDMA) and RC1/SO55(PCS) with 'All Up' power control bits.

FCC CERTIFICATION REPORT			www.hct.co.kr
Test Report No. HCTR1207FR06-1	Date of Issue: July 30, 2017	EUT Type: CDMA/GSM/WCDMA/LTE Data Dongle	FCC ID: JYCSPARKLE

3.6 FREQUENCY STABILITY / VARIATION OF AMBIENT TEMPERATURE

Test Set-up

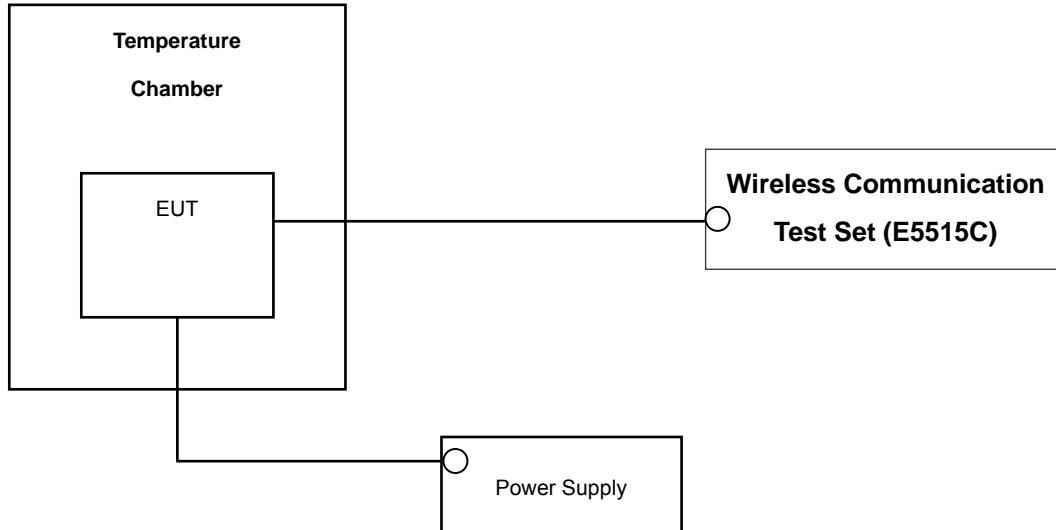

* Nominal Operating Voltage

Test Procedure

The frequency stability of the transmitter is measured by:

- a.) **Temperature:** The temperature is varied from - 30 °C to + 50 °C using an environmental chamber.
- b.) **Primary Supply Voltage:** The primary supply voltage is varied from battery end point to 115 % of the voltage normally at the input to the device or at the power supply terminals if cables are not normally supplied.

Specification — the frequency stability shall be sufficient to ensure that the fundamental emission stays within the authorized frequency block. The frequency stability of the transmitter shall be maintained within $\pm 0.00025\%$ (± 2.5 ppm) of the center frequency.

Time Period and Procedure:

The carrier frequency of the transmitter is measured at room temperature (20°C to provide a reference).

1. The equipment is turned on in a “standby” condition for one minute before applying power to the transmitter. Measurement of the carrier frequency of the transmitter is made within one minute after applying power to the transmitter.
2. Frequency measurements are made at 10°C intervals ranging from -30°C to +50°C. A period of at least one half-hour is provided to allow stabilization of the equipment at each temperature level.

NOTE: The EUT is tested down to the battery endpoint.

Note : This device was tested under all R.C.s and S.O.s and worst case is reported with RC3/SO55(CDMA) and RC1/SO55(PCS) with ‘All Up’ power control bits.

FCC CERTIFICATION REPORT			www.hct.co.kr
Test Report No. HCTR1207FR06-1	Date of Issue: July 30, 2017	EUT Type: CDMA/GSM/WCDMA/LTE Data Dongle	FCC ID: JYCSPARKLE

4. LIST OF TEST EQUIPMENT

Manufacture	Model/ Equipment	Serial Number	Calibration Interval	Calibration Due
Agilent	N9020A	MY51110020	Annual	09/23/2012
Agilent	E9327A/ Power Sensor	MY4442009	Annual	05/02/2013
R&S	CMW500/ Base Station	1201.0002K50_116858	Annual	01/17/2013
MITEQ	AMF-6D-001180-35-20P/AMP	1081666	Annual	09/24/2012
Wainwright	WHK1.2/15G-10EF/H.P.F	2	Annual	05/02/2013
Wainwright	WHK3.3/18G-10EF/H.P.F	1	Annual	05/02/2013
Hewlett Packard	11667B / Power Splitter	10126	Annual	11/04/2012
Digital	EP-3010/ Power Supply	3110117	Annual	11/07/2012
Schwarzbeck	UHAP/ Dipole Antenna	557	Biennial	03/11/2013
Schwarzbeck	UHAP/ Dipole Antenna	558	Biennial	03/11/2013
Korea Engineering	KR-1005L / Chamber	KRAB05063-3CH	Annual	11/07/2012
Schwarzbeck	BBHA 9120D/ Horn Antenna	296	Biennial	02/20/2014
Agilent	E4440A/Spectrum Analyzer	US45303008	Annual	05/02/2013
WEINSCHL	ATTENUATOR	BR0592	Annual	11/07/2012
REOHDE&SCHWARZ	FSP30/Spectrum Analyzer	839117/011	Annual	02/09/2013
Agilent	8960 (E5515C)/ Base Station	GB44400269	Annual	02/10/2013

5. SUMMARY OF TEST RESULTS

FCC Part Section(s)	Test Description	Test Limit	Test Condition	Test Result
2.1049, 22.917(a), 24.238(a)	Occupied Bandwidth	N/A	CONDUCTED	PASS
2.1051, 22.917(a), 24.238(a)	Band Edge / Spurious and Harmonic Emissions at Antenna Terminal.	< 43 + 10log ₁₀ (P[Watts]) at Band Edge and for all out-of-band emissions		PASS
2.1046	Conducted Output Power	N/A		PASS
24.232(d)	Peak- to- Average Ratio	< 13 dB		PASS
2.1055, 22.355, 24.235	Frequency stability / variation of ambient temperature	< 2.5 ppm		PASS
22.913(a)(2) 24.232(c)	Effective Radiated Power	< 7 Watts max. ERP	RADIATED	PASS
	Equivalent Isotropic Radiated Power	< 2 Watts max. EIRP		PASS
2.1053, 22.917(a), 24.238(a)	Radiated Spurious and Harmonic Emissions	< 43 + 10log ₁₀ (P[Watts]) for all out-of band emissions		PASS

6. SAMPLE CALCULATION

A. ERP Sample Calculation

Mode	Ch./ Freq.		Measured Level(dBm)	Substitute LEVEL(dBm)	Ant. Gain	C.L	Pol.	ERP	
	channel	Freq.(MHz)						W	dBm
CDMA	384	836.52	-10.96	24.81	2.50	1.19	H	0.41	26.12

ERP = SubstituteLEVEL(dBm) + Ant. Gain – CL(Cable Loss)

- 1) The EUT mounted on a non-conductive tunnable is 0.8 meter above test site ground level.
- 2) During the test , the turn table is rotated and the antenna height is also varied from 1 to 4 meters until the maximum signal is found.
- 3) Record the field strength meter's level.
- 4) Replace the EUT with dipole/Horn antenna that is connected to a calibrated signal generator.
- 5) Increase the signal generator output till the field strength meter's level is equal to the item (3).
- 6) The signal generator output level with Ant. Gain and cable loss are the rating of effective radiated power (**ERP**).

B. Emission Designator

CDMA Emission Designator

Emission Designator = 1M27F9W

CDMA BW = 1.27 MHz (Measured at the 99% power bandwidth)

F = Frequency Modulation

9 = Composite Digital Info

W = Combination (Audio/Data)

FCC CERTIFICATION REPORT			www.hct.co.kr
Test Report No. HCTR1207FR06-1	Date of Issue: July 30, 2017	EUT Type: CDMA/GSM/WCDMA/LTE Data Dongle	FCC ID: JYCSPARKLE

7. TEST DATA

7.1 CONDUCTED OUTPUT POWER

A base station simulator was used to establish communication with The EUT. The base station simulator parameters were set to produce the maximum power from the EUT. This device was tested under all configurations and the highest power is reported. Conducted Output Powers of EUT are reported below.

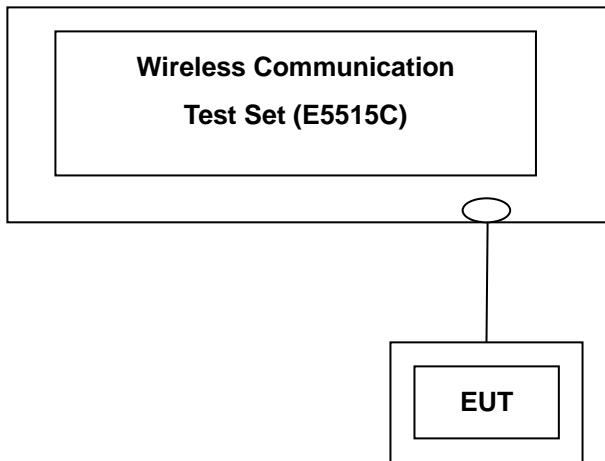

Band	Channel	SO2	SO2	SO55	SO55	TDSO SO32	1xEVDO Rev.0	1xEVDO Rev.0	1xEVDO Rev.1	1xEVDO Rev.1
		RC1/1 (dBm)	RC3/3 (dBm)	RC1/1 (dBm)	RC3/3 (dBm)	RC3/3 (dBm)	(FTAP)	(RTAP)	(FETAP)	(RETAP)
CDMA	1013	23.98	23.98	23.95	24.00	23.98	23.98	23.98	24.06	24.03
	384	23.91	23.87	23.94	23.86	23.90	23.93	23.85	23.86	23.94
	777	23.88	23.82	23.89	23.85	23.83	23.93	23.84	23.94	23.88
PCS	25	23.94	23.91	23.96	23.94	23.88	24.80	24.79	24.74	24.83
	600	24.32	24.32	24.40	24.28	24.33	24.93	24.88	24.98	24.95
	1175	23.80	23.85	23.93	23.84	23.79	24.16	24.08	24.48	24.46

(Maximum Conducted Output Powers)

Note : Detecting mode is average.

FCC CERTIFICATION REPORT			www.hct.co.kr
Test Report No. HCTR1207FR06-1	Date of Issue: July 30, 2017	EUT Type: CDMA/GSM/WCDMA/LTE Data Dongle	FCC ID: JYCSPARKLE

7.2 PEAK-TO-AVERAGE RATIO

- Plots of the EUT's Peak- to- Average Ratio are shown Page 29.

7.3 OCCUPIED BANDWIDTH

Band	Channel	Frequency(MHz)	Data (MHz)
CDMA	1013	824.70	1.2725
	384	836.52	1.2677
	777	848.31	1.2772
CDMA EVDO	777	848.31	1.2736
PCS	25	1851.25	1.2761
	600	1880.00	1.2831
	1175	1908.75	1.2836
PCS EVDO	1175	1908.75	1.2724

- Plots of the EUT's Occupied Bandwidth are shown Page 25 ~ 28.

7.4 CONDUCTED SPURIOUS EMISSIONS

Band	Channel	Frequency of Maximum Harmonic (GHz)	Maximum Data (dBm)
CDMA	1013	1.6480	-39.75
	384	1.6730	-38.90
	777	7.4500	-40.61
PCS	25	14.2930	-38.14
	600	14.5070	-37.35
	1175	14.4800	-38.28

- Plots of the EUT's Conducted Spurious Emissions are shown Page 38 ~ 43.

7.4.1 Band Edge

- Plots of the EUT's Band Edge are shown Page 30 ~ 37.

7.5 EFFECTIVE RADIATED POWER OUTPUT

(CDMA Mode)

Mode	Ch./ Freq.		Measured Level(dBm)	Substitute LEVEL (dBm)	Ant. Gain	C.L	Pol.	ERP	
	channel	Freq.(MHz)						W	dBm
CDMA	1013	824.70	-14.65	34.25	-10.54	1.61	H	0.162	22.10
	384	836.52	-13.62	35.30	-10.50	1.67	H	0.206	23.13
	777	848.31	-16.58	32.48	-10.47	1.64	H	0.109	20.37
EVDO	1013	824.70	-14.15	34.75	-10.54	1.61	H	0.182	22.60
	384	836.52	-13.13	35.79	-10.50	1.67	H	0.230	23.62
	777	848.31	-16.41	32.65	-10.47	1.64	H	0.113	20.54

Note: Standard batteries are the only options for this phone. And a peak detector is used.

NOTES:

Effective Radiated Power Output Measurements by Substitution Method

according to ANSI/TIA/EIA-603-C-2004, Aug. 17, 2004:

The EUT was placed on a non-conductive styrofoam resin table 3-meters from the receive antenna. The receive antenna height and turntable rotation was adjusted for the highest reading on the receive spectrum analyzer. For CDMA signals, a peak detector is used, with RBW = VBW = 3 MHz. For WCDMA signals, a peak detector is used, with RBW = VBW = 5MHz. For AMPS, GSM, and NADC TDMA signals, a peak detector is used, with RBW = VBW = 1 MHz. A half-wave dipole was substituted in place of the EUT. This dipole antenna was driven by a signal generator and the level of the signal generator was adjusted to obtain the same receive spectrum analyzer reading. The conducted power at the terminals of the dipole is measured. The ERP is recorded.

This device was tested under all configurations and the highest power is reported. Also, we have done x, y, z planes in EUT and horizontal and vertical polarization in detecting antenna. The worst case of the EUT is in z plane in CDMA mode. Also worst case of detecting Antenna is in horizontal polarization in CDMA mode.

The EVDO mode testing were performed using FETAP on Rev.A because FETAP on Rev.A is highest power in EVDO mode.

FCC CERTIFICATION REPORT			www.hct.co.kr
Test Report No. HCTR1207FR06-1	Date of Issue: July 30, 2017	EUT Type: CDMA/GSM/WCDMA/LTE Data Dongle	FCC ID: JYCSPARKLE

7.6 EQUIVALENT ISOTROPIC RADIATED POWER

(PCS CDMA Mode)

Mode	Ch./ Freq.		Measured Level(dBm)	Substitute LEVEL (dBm)	Ant. Gain	C.L	Pol.	EIRP	
	channel	Freq.(MHz)						W	dBm
PCS	25	1,851.25	-16.07	15.87	10.23	1.78	V	0.270	24.32
	600	1,880.00	-16.09	16.04	10.25	1.77	V	0.283	24.52
	1175	1,908.75	-15.07	17.13	10.29	1.75	V	0.369	25.67
EVDO	25	1,851.25	-11.97	19.97	10.23	1.78	V	0.695	28.42
	600	1,880.00	-13.66	18.47	10.25	1.77	V	0.495	26.95
	1175	1,908.75	-13.27	18.93	10.29	1.75	V	0.558	27.47

Note: Standard batteries are the only options for this phone. And a peak detector is used.

NOTES:

Equivalent Isotropic Radiated Power Measurements by Substitution Method

according to ANSI/TIA/EIA-603-C-2004, Aug. 17, 2004:

The EUT was placed on a non-conductive styrofoam resin table 3-meters from the receive antenna. The receive antenna height and turntable rotation was adjusted for the highest reading on the receive spectrum analyzer. For CDMA signals, a peak detector is used, with RBW = VBW = 3 MHz. For WCDMA signals, a peak detector is used, with RBW = VBW = 5MHz. For AMPS, GSM, and NADC TDMA signals, a peak detector is used, with RBW = VBW = 1 MHz. A Horn antenna was substituted in place of the EUT. This Horn antenna was driven by a signal generator and the level of the signal generator was adjusted to obtain the same receive spectrum analyzer reading. The conducted power at the terminals of the Horn antenna is measured. The difference between the gain of the horn and an isotropic antenna is taken into consideration and the EIRP is recorded.

This device was tested under all configurations and the highest power is reported. Also, we have done x, y, z planes in EUT and horizontal and vertical polarization in detecting antenna. And worst case of the EUT is in y plane in PCS mode. Also worst case of detecting Antenna is in vertical in PCS mode.

The EVDO mode testing were performed using FETAP on Rev.A because FETAP on Rev.A is highest power in EVDO mode.

FCC CERTIFICATION REPORT			www.hct.co.kr
Test Report No. HCTR1207FR06-1	Date of Issue: July 30, 2017	EUT Type: CDMA/GSM/WCDMA/LTE Data Dongle	FCC ID: JYCSPARKLE

7.7 RADIATED SPURIOUS EMISSIONS

7.7.1 RADIATED SPURIOUS EMISSIONS (CDMA Mode)

- MEASURED OUTPUT POWER: 23.62 dBm = 0.230 W
- MODULATION SIGNAL: CDMA EVDO
- DISTANCE: 3 meters
- LIMIT: - (43 + 10 log10 (W)) = -36.62 dBc

Ch.	Freq.(MHz)	Measured Level [dBm]	Ant. Gain	Substitute Level [dBm]	C.L	Pol.	ERP (dBm)	dBc
1013	1,649.40	-51.15	9.69	-60.44	1.71	H	-52.46	-76.08
	2,474.10	-	-	-	-	-	-	-
	3,298.80	-	-	-	-	-	-	-
384	1,673.04	-50.98	9.82	-60.59	1.74	V	-52.51	-76.13
	2,509.56	-	-	-	-	-	-	-
	3,346.08	-	-	-	-	-	-	-
777	1,696.62	-50.02	10.01	-59.44	1.70	V	-51.13	-74.75
	2,544.93	-	-	-	-	-	-	-
	3,393.24	-	-	-	-	-	-	-

- NOTES:**
1. Radiated Spurious Emission Measurements at 3 meters by Substitution Method according to ANSI/TIA/EIA-603-C-2004, Aug. 17, 2004:
 2. The magnitude of spurious emissions attenuated more than 20dB below the limit above 5th Harmonic for all channel.
 3. we have done x, y, z planes in EUT and horizontal and vertical polarization in detecting antenna.

FCC CERTIFICATION REPORT			www.hct.co.kr
Test Report No. HCTR1207FR06-1	Date of Issue: July 30, 2017	EUT Type: CDMA/GSM/WCDMA/LTE Data Dongle	FCC ID: JYCSPARKLE

7.7.2 RADIATED SPURIOUS EMISSIONS (PCS Mode)

- MEASURED OUTPUT POWER: 28.42 dBm = 0.695 W
- MODULATION SIGNAL: PCS CDMA EVDO
- DISTANCE: 3 meters
- LIMIT: - (43 + 10 log₁₀ (W)) = -41.42 dBc

Ch.	Freq.(MHz)	Measured Level [dBm]	Ant. Gain	Substitute Level [dBm]	C.L	Pol.	ERP (dBm)	dBc
25	3,702.50	-51.48	12.50	-56.45	2.55	H	-46.50	-74.92
	5,553.75	-	-	-	-	-	-	-
	7,405.00	-	-	-	-	-	-	-
600	3,760.00	-51.88	12.54	-56.56	2.60	V	-46.62	-75.04
	5,640.00	-	-	-	-	-	-	-
	7,520.00	-	-	-	-	-	-	-
1175	3,817.50	-51.87	12.59	-56.31	2.59	V	-46.31	-74.73
	5,726.25	-	-	-	-	-	-	-
	7,635.00	-	-	-	-	-	-	-

- NOTES:**
1. Radiated Spurious Emission Measurements at 3 meters by Substitution Method according to ANSI/TIA/EIA-603-C-2004, Aug. 17, 2004:
 2. The magnitude of spurious emissions attenuated more than 20dB below the limit above 5th Harmonic for all channel.
 3. we have done x, y, z planes in EUT and horizontal and vertical polarization in detecting antenna.

FCC CERTIFICATION REPORT			www.hct.co.kr
Test Report No. HCTR1207FR06-1	Date of Issue: July 30, 2017	EUT Type: CDMA/GSM/WCDMA/LTE Data Dongle	FCC ID: JYCSPARKLE

7.8 FREQUENCY STABILITY / VARIATION OF AMBIENT TEMPERATURE

7.8.1 FREQUENCY STABILITY (CDMA)

OPERATING FREQUENCY: 836,520,000 Hz
 CHANNEL: 384
 REFERENCE VOLTAGE: 3.7 VDC
 DEVIATION LIM IT: ± 0.000 25 % or 2.5 ppm

Voltage (%)	Power (VDC)	Temp. (°C)	Frequency (Hz)	Frequency Error (Hz)	Deviation (%)	ppm
100%	3.700	+20(Ref)	836 520 012	0	0.000 000	0.000
100%		-30	836 520 001	-11.35	-0.000 001	-0.014
100%		-20	836 520 000	-12.35	-0.000 001	-0.015
100%		-10	836 520 001	-11.16	-0.000 001	-0.013
100%		0	836 520 002	-10.28	-0.000 001	-0.012
100%		+10	836 520 001	-11.37	-0.000 001	-0.014
100%		+30	836 520 002	-10.83	-0.000 001	-0.013
100%		+40	836 520 002	-10.81	-0.000 001	-0.013
100%		+50	836 519 994	-17.88	-0.000 002	-0.021
115%	4.255	+20	836 520 000	-12.56	-0.000 002	-0.015
Batt. Endpoint	3.400	+20	836 520 002	-10.06	-0.000 001	-0.012

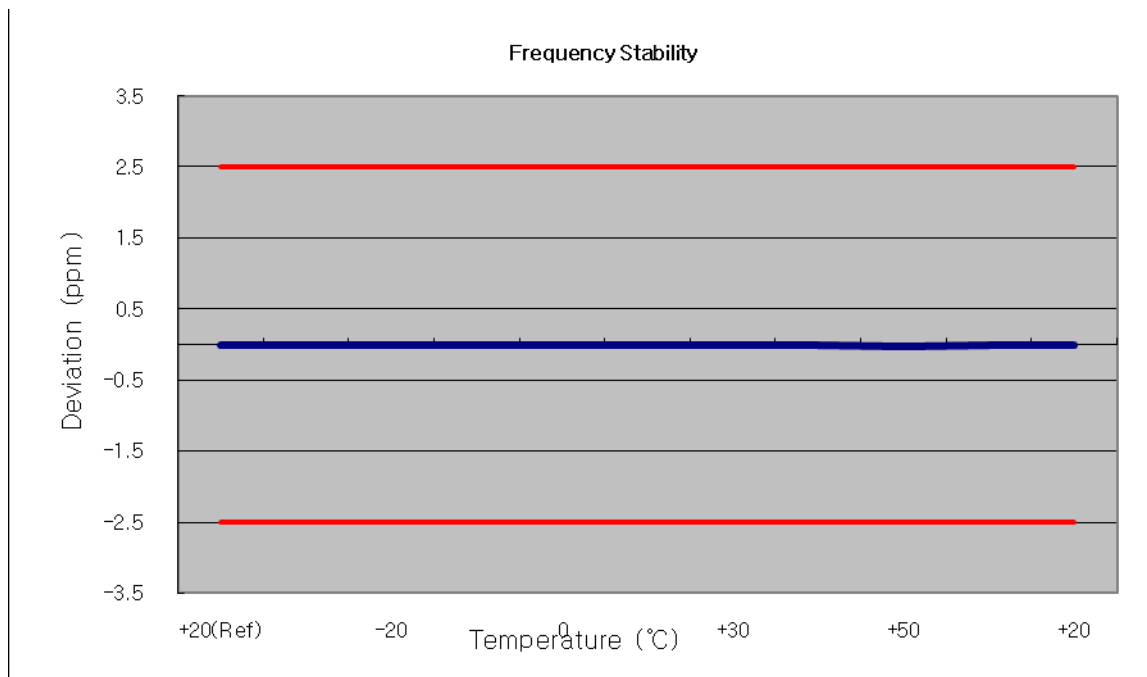

7.8.2 FREQUENCY STABILITY (PCS CDMA)

OPERATING FREQUENCY: 1880,000,000 Hz
 CHANNEL: 600
 REFERENCE VOLTAGE: 3.7 VDC
 DEVIATION LIM IT: ± 0.000 25 % or 2.5 ppm

Voltage (%)	Power (VDC)	Temp. (°C)	Frequency (Hz)	Frequency Error (Hz)	Deviation (%)	ppm
100%	3.700	+20(Ref)	1879 999 990	0	0.000 000	0.000
100%		-30	1880 000 009	8.84	0.000 000	0.005
100%		-20	1880 000 007	6.96	0.000 000	0.004
100%		-10	1880 000 010	9.52	0.000 001	0.005
100%		0	1880 000 010	10.39	0.000 001	0.006
100%		+10	1880 000 009	8.69	0.000 000	0.005
100%		+30	1880 000 007	7.47	0.000 000	0.004
100%		+40	1880 000 011	10.60	0.000 001	0.006
100%		+50	1880 000 008	8.34	0.000 000	0.004
115%		4.255	+20	1880 000 008	7.93	0.000 000
Batt. Endpoint	3.400	+20	1880 000 009	9.33	0.000 000	0.005

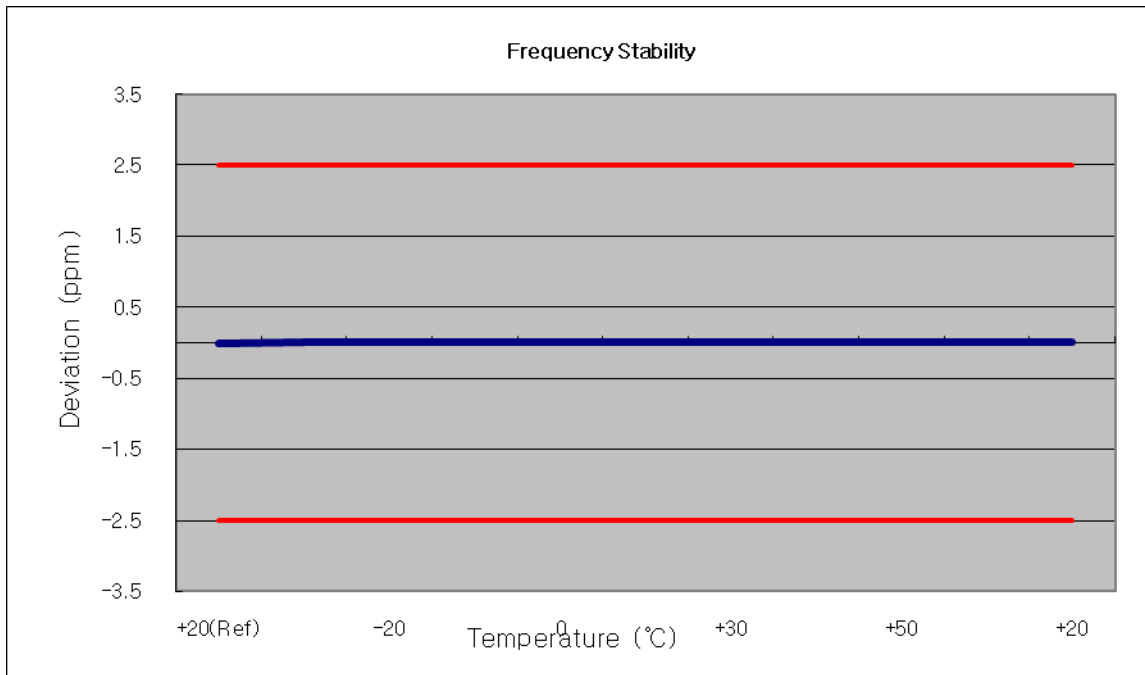

8. TEST PLOTS

FCC CERTIFICATION REPORT			www.hct.co.kr
Test Report No. HCTR1207FR06-1	Date of Issue: July 30, 2017	EUT Type: CDMA/GSM/WCDMA/LTE Data Dongle	FCC ID: JYCSPARKLE

■ CDMA MODE (1013 CH.) Occupied Bandwidth

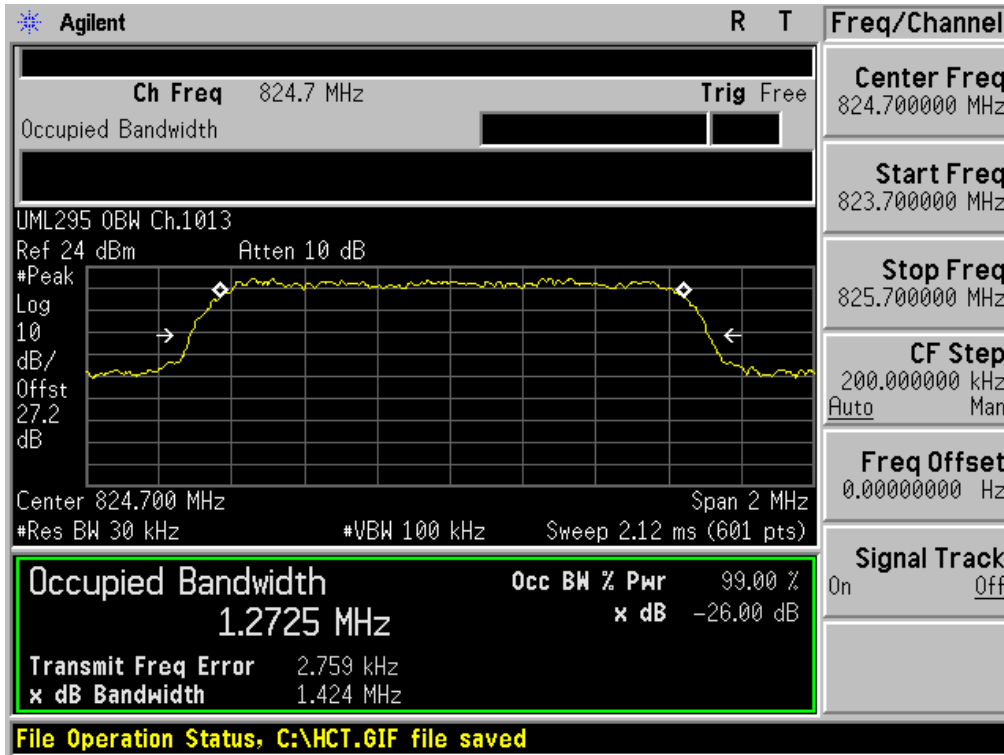

■ CDMA MODE (384 CH.) Occupied Bandwidth

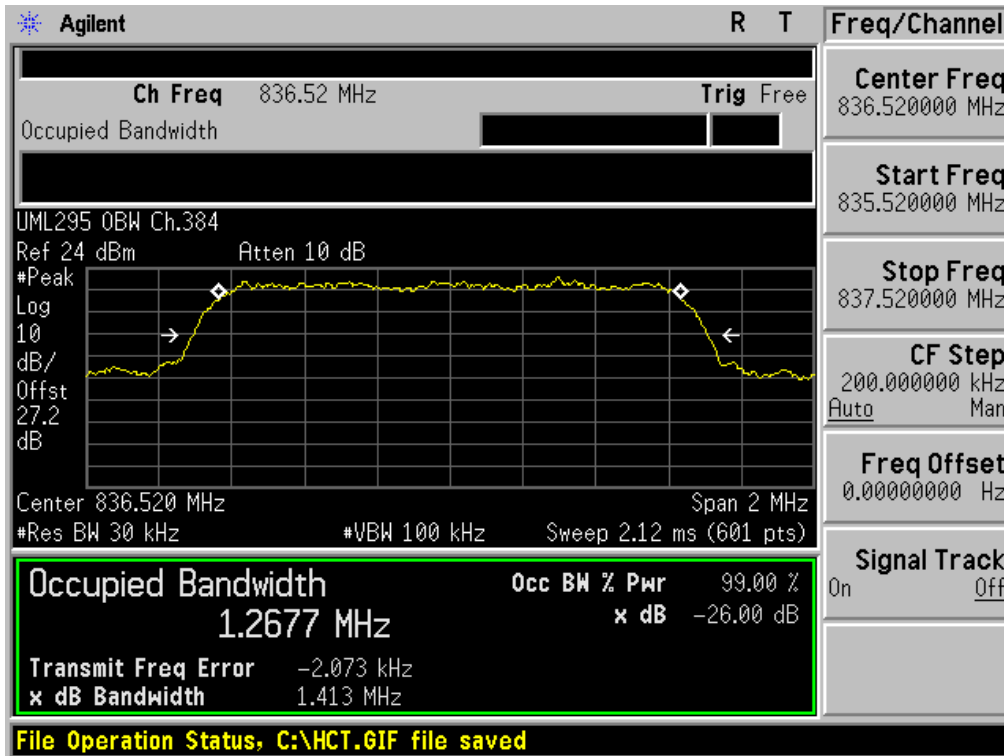

FCC CERTIFICATION REPORT			www.hct.co.kr
Test Report No. HCTR1207R06-1	Date of Issue: July 30, 2017	EUT Type: CDMA/GSM/WCDMA/LTE Data Dongle	FCC ID: JYCSPARKLE

■ CDMA MODE (777 CH.) Occupied Bandwidth

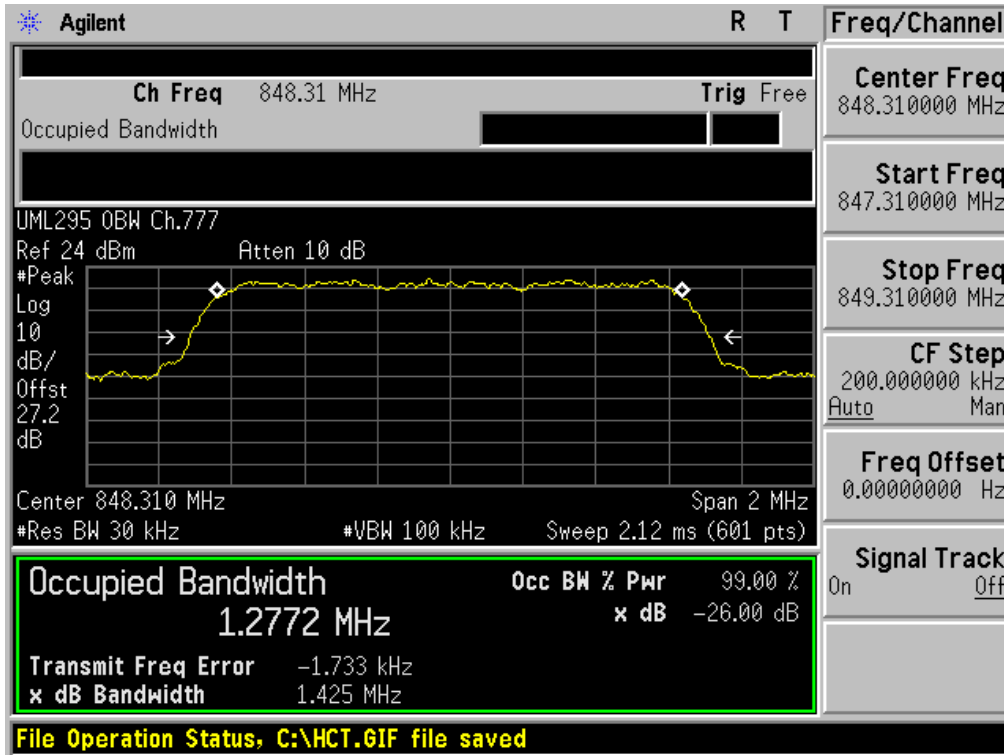

■ CDMA EVDO MODE (777 CH.) Occupied Bandwidth

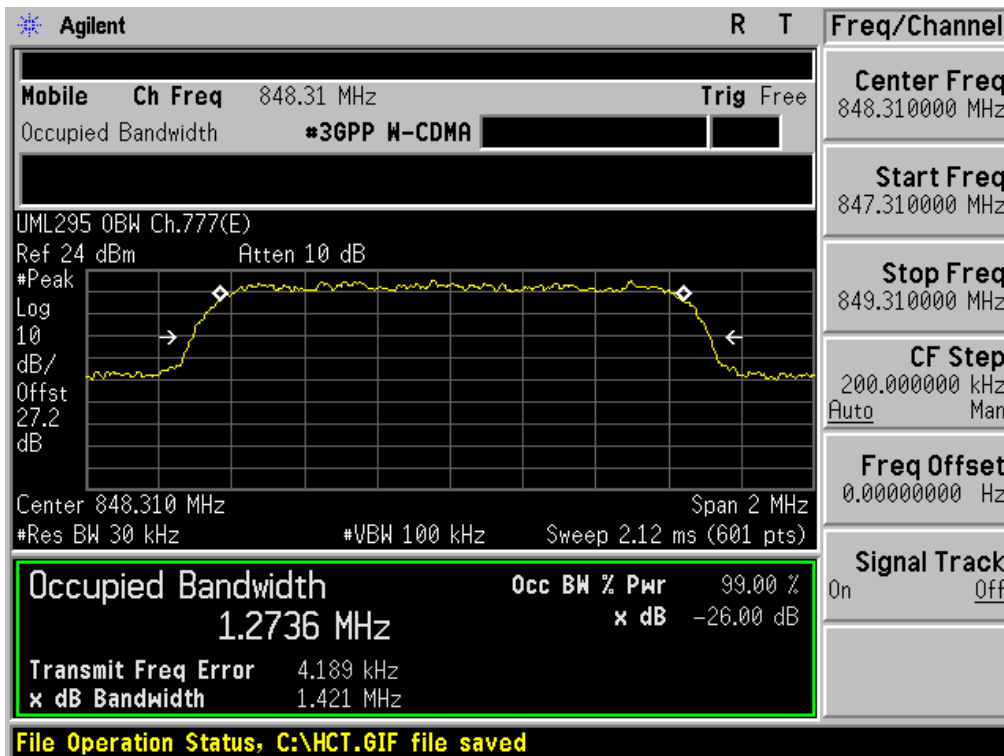

FCC CERTIFICATION REPORT			www.hct.co.kr
Test Report No. HCTR1207R06-1	Date of Issue: July 30, 2017	EUT Type: CDMA/GSM/WCDMA/LTE Data Dongle	FCC ID: JYCSPARKLE

■ PCS CDMA MODE (25 CH.) Occupied Bandwidth

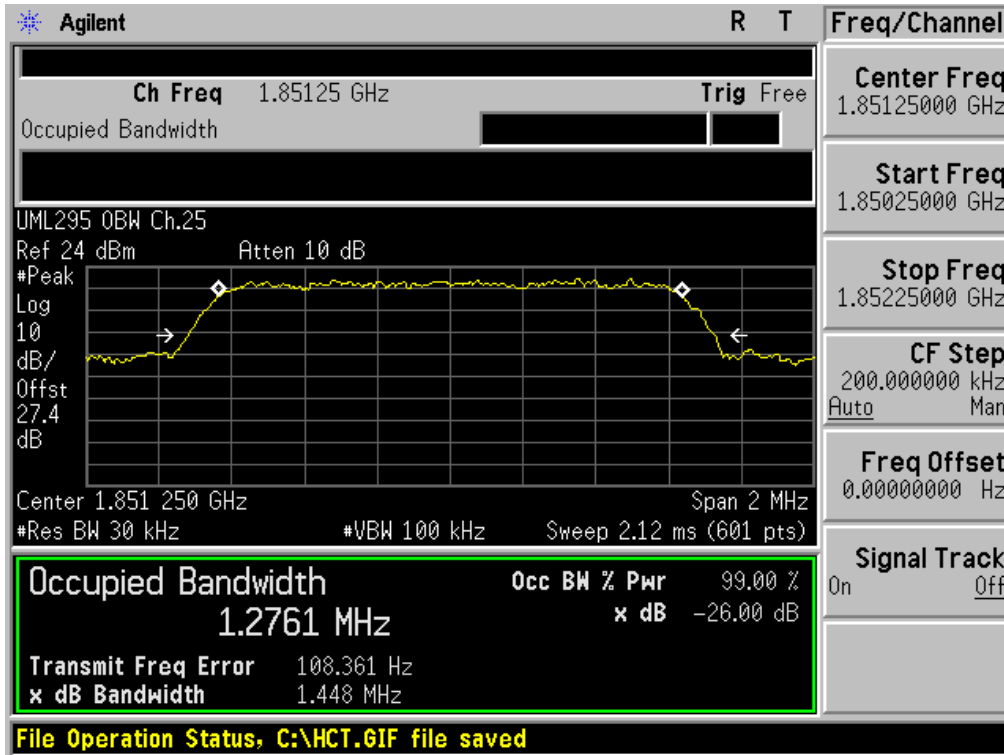

■ PCS CDMA MODE (600 CH.) Occupied Bandwidth

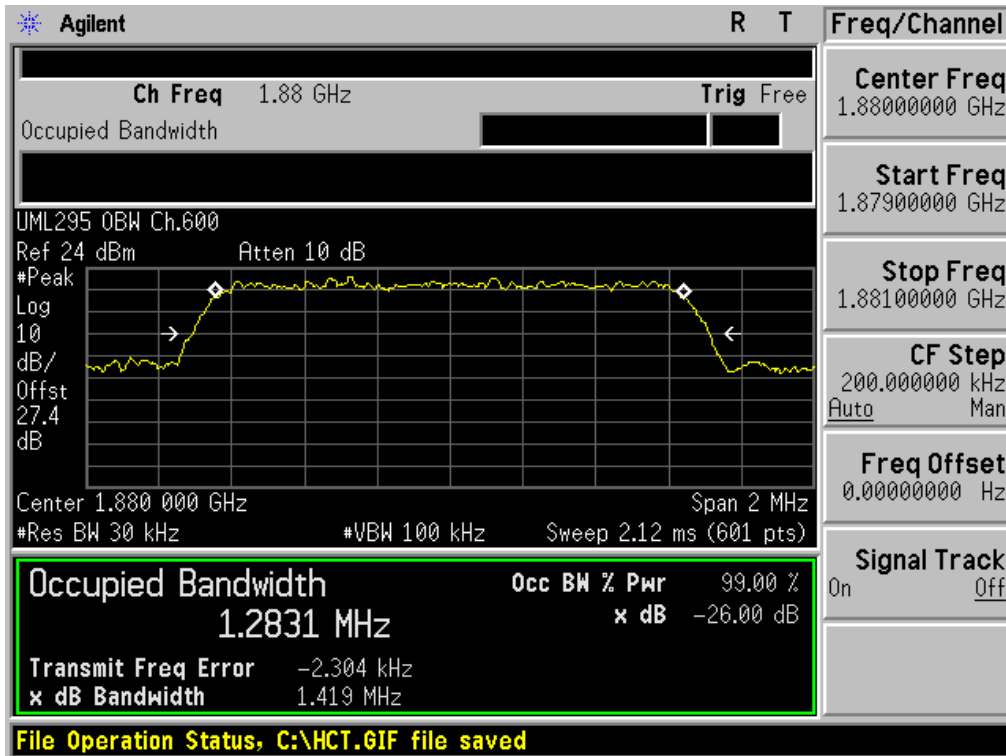

FCC CERTIFICATION REPORT			www.hct.co.kr
Test Report No. HCTR1207FR06-1	Date of Issue: July 30, 2017	EUT Type: CDMA/GSM/WCDMA/LTE Data Dongle	FCC ID: JYCSPARKLE

■ PCS CDMA MODE (1175 CH.) Occupied Bandwidth

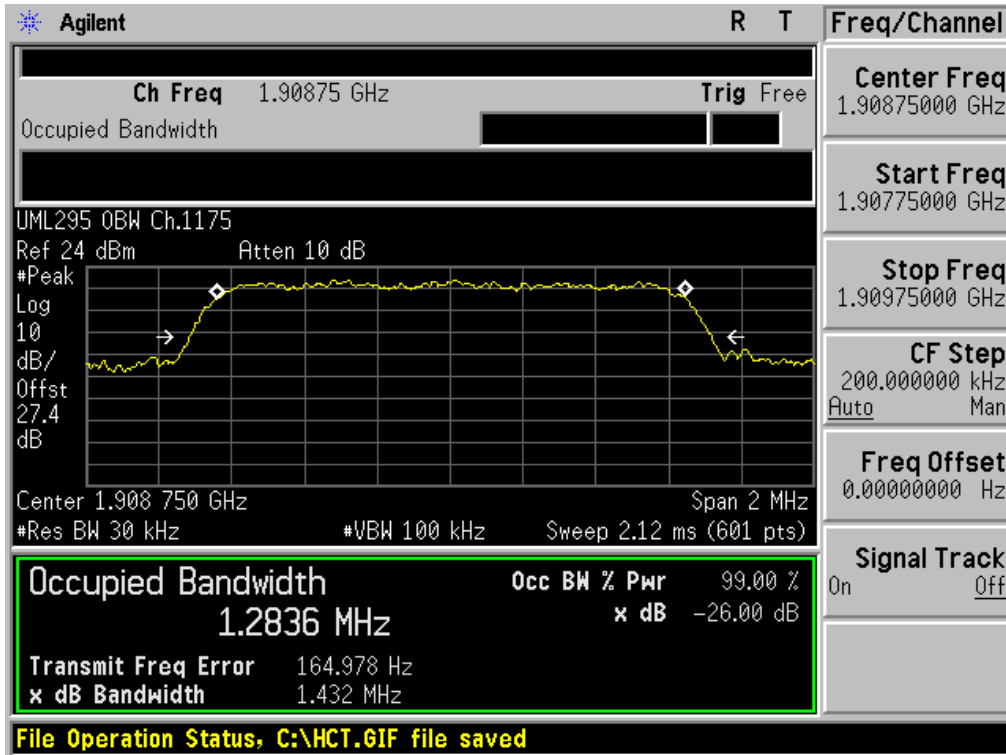

■ PCS CDMA EVDO MODE (1175 CH.) Occupied Bandwidth

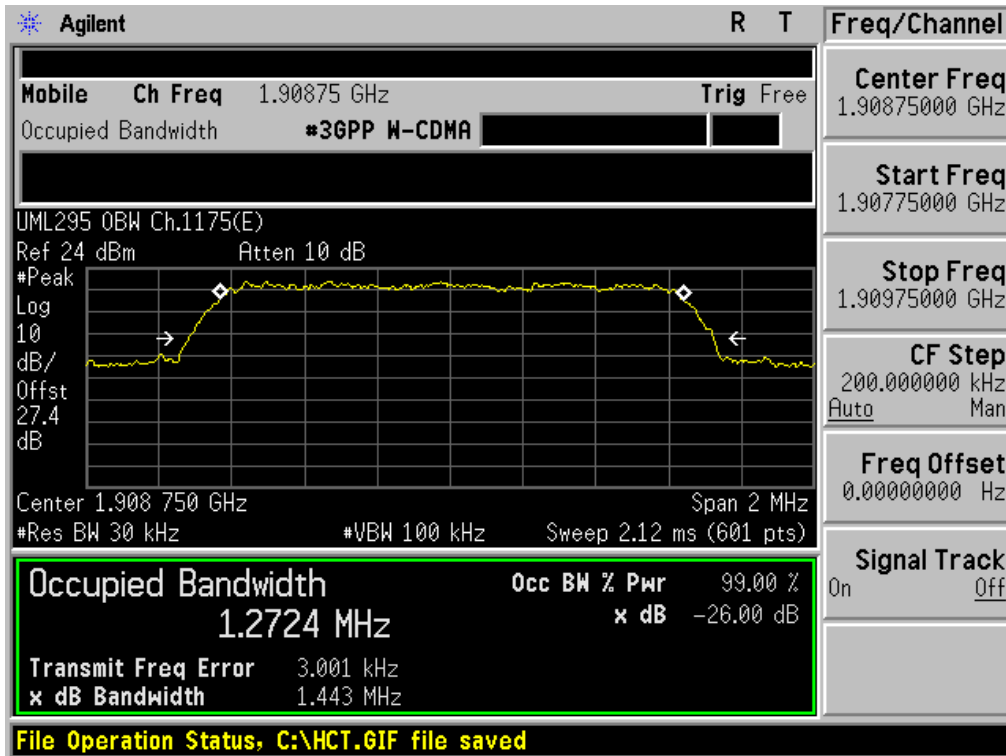

FCC CERTIFICATION REPORT			www.hct.co.kr
Test Report No. HCTR1207FR06-1	Date of Issue: July 30, 2017	EUT Type: CDMA/GSM/WCDMA/LTE Data Dongle	FCC ID: JYCSPARKLE

■ PCS CDMA MODE (600 CH.) Peak-to-Average Ratio

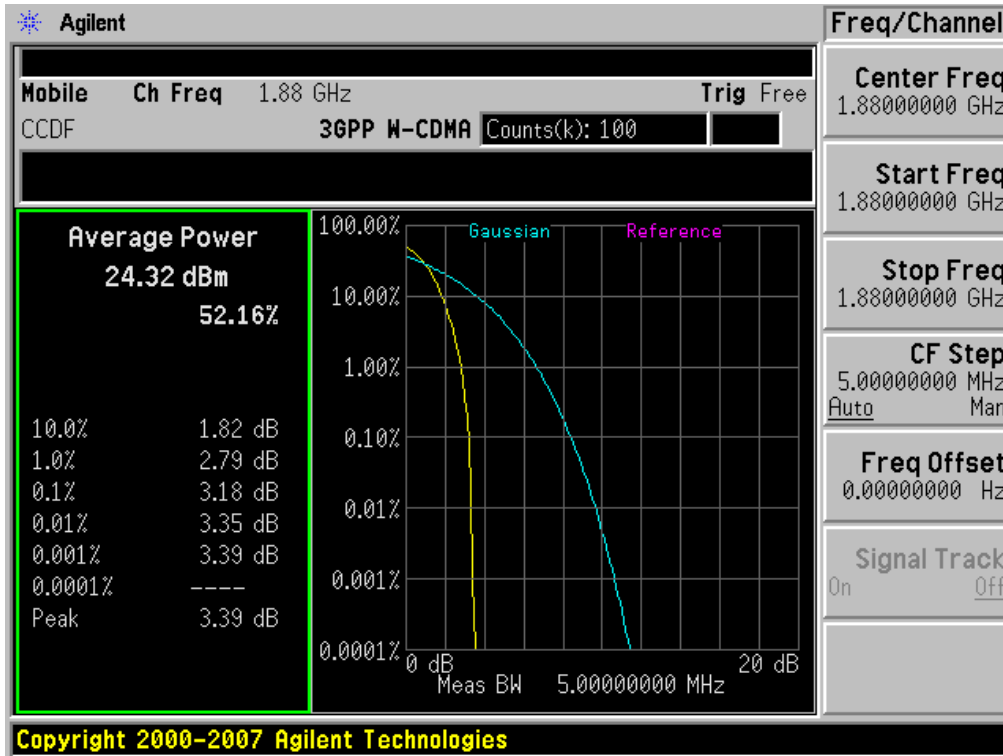

■ PCS CDMA EVDO MODE (600 CH.) Peak-to-Average Ratio

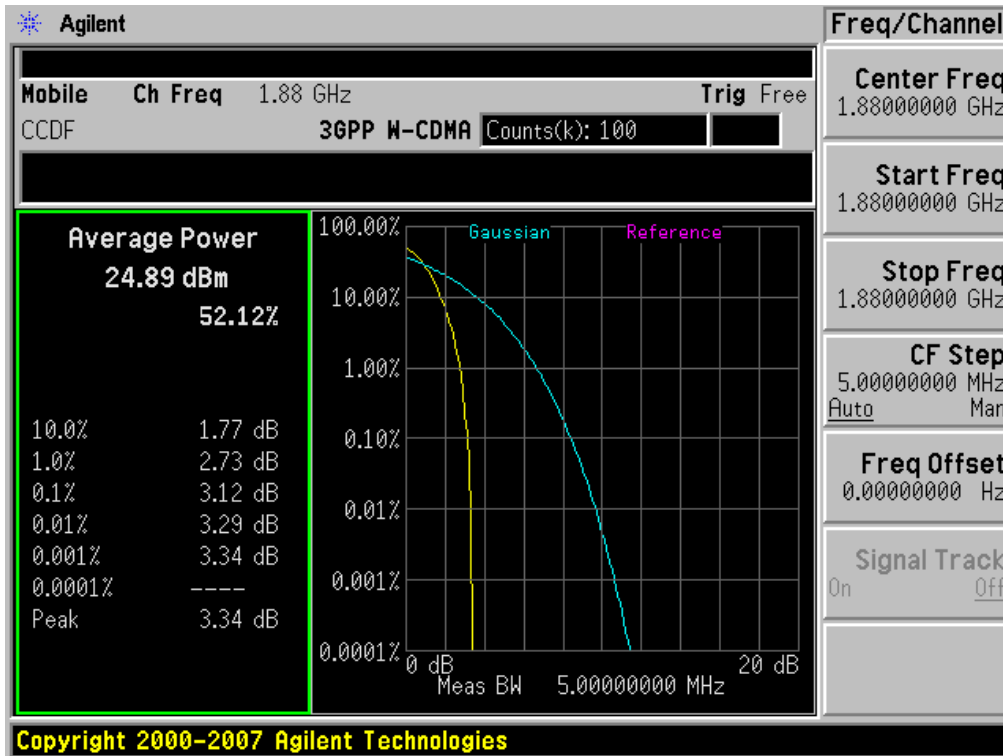

FCC CERTIFICATION REPORT			www.hct.co.kr
Test Report No. HCTR1207FR06-1	Date of Issue: July 30, 2017	EUT Type: CDMA/GSM/WCDMA/LTE Data Dongle	FCC ID: JYCSPARKLE

■ CDMA MODE (1013 CH.) Block Edge

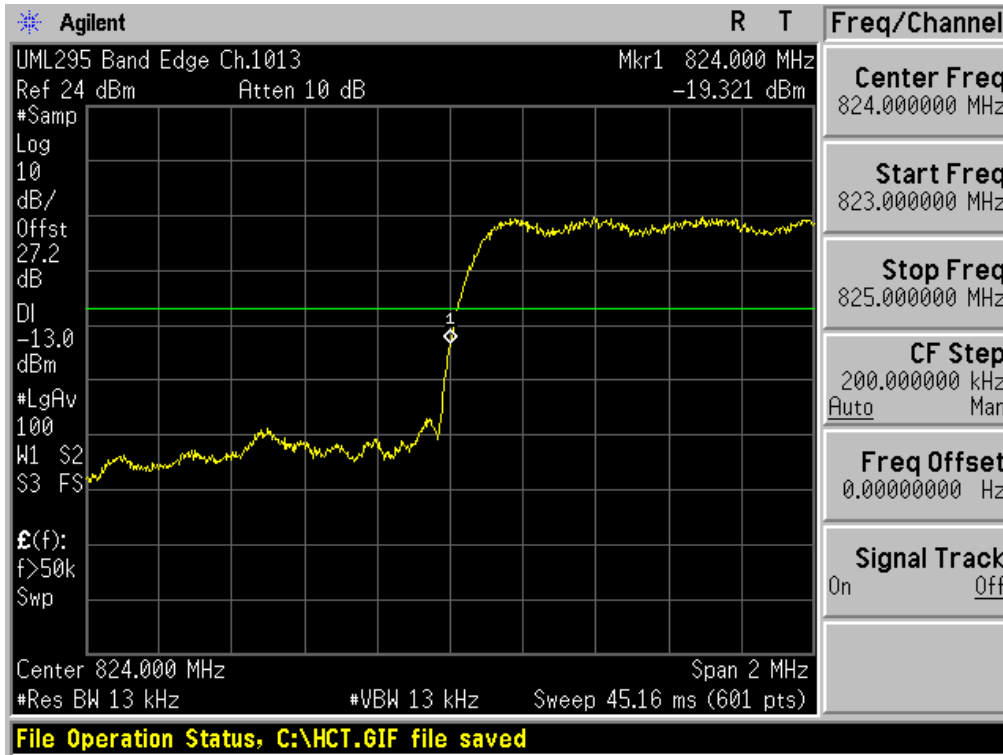

■ CDMA MODE (777 CH.) Block Edge

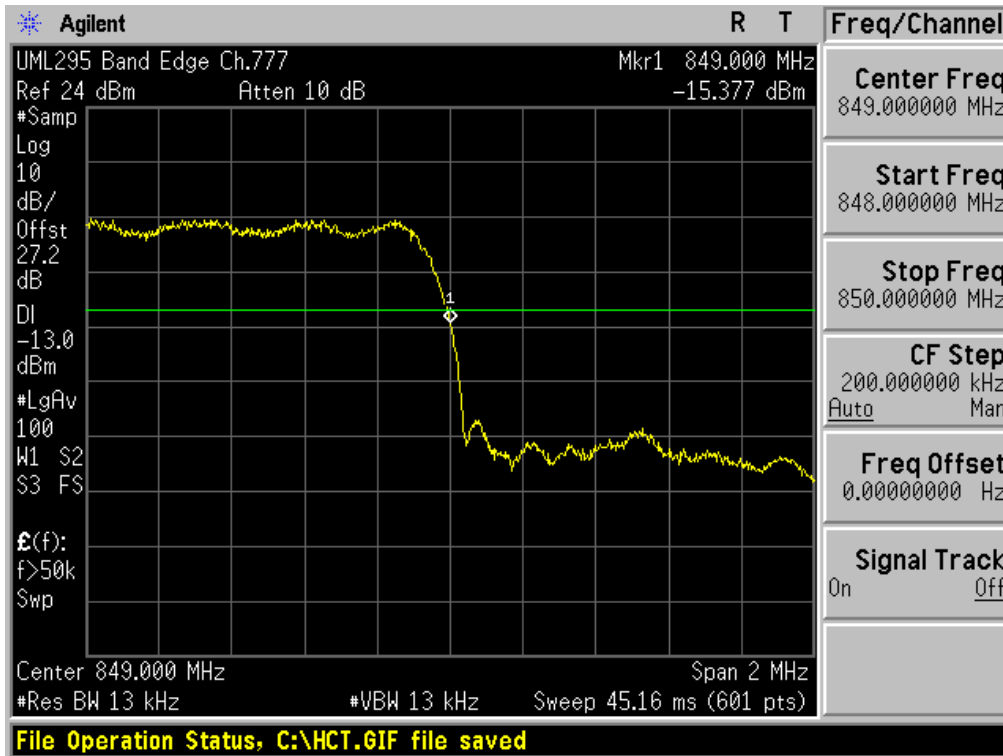

FCC CERTIFICATION REPORT			www.hct.co.kr
Test Report No. HCTR1207FR06-1	Date of Issue: July 30, 2017	EUT Type: CDMA/GSM/WCDMA/LTE Data Dongle	FCC ID: JYCSPARKLE

■ CDMA EVDO MODE (1013 CH.) Block Edge

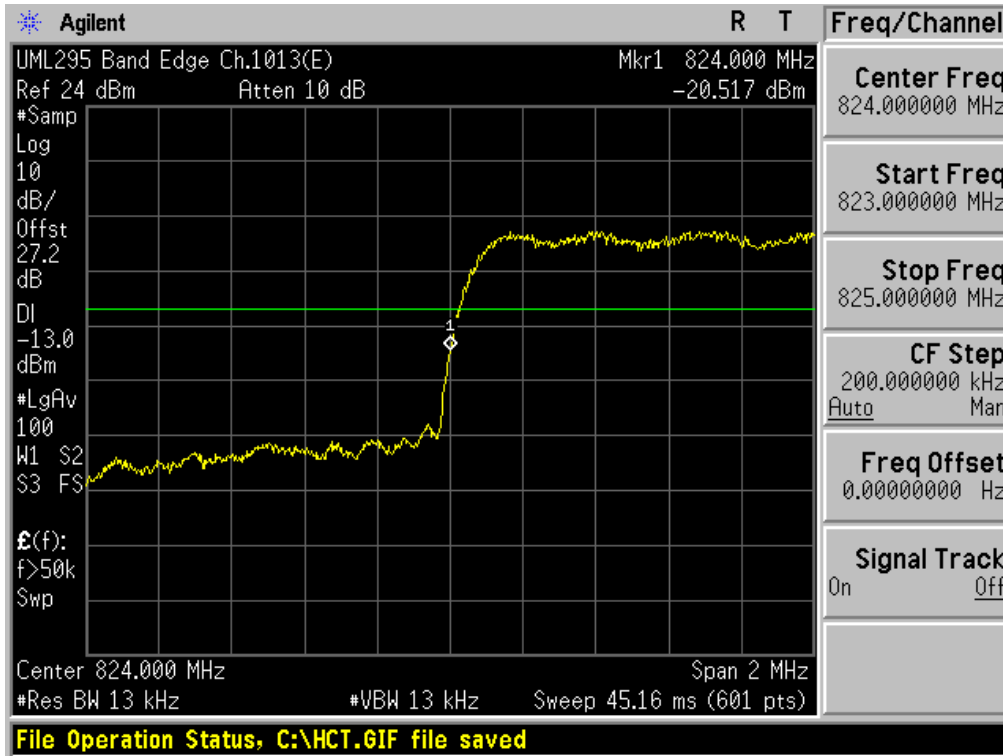

■ CDMA EVDO MODE (777 CH.) Block Edge

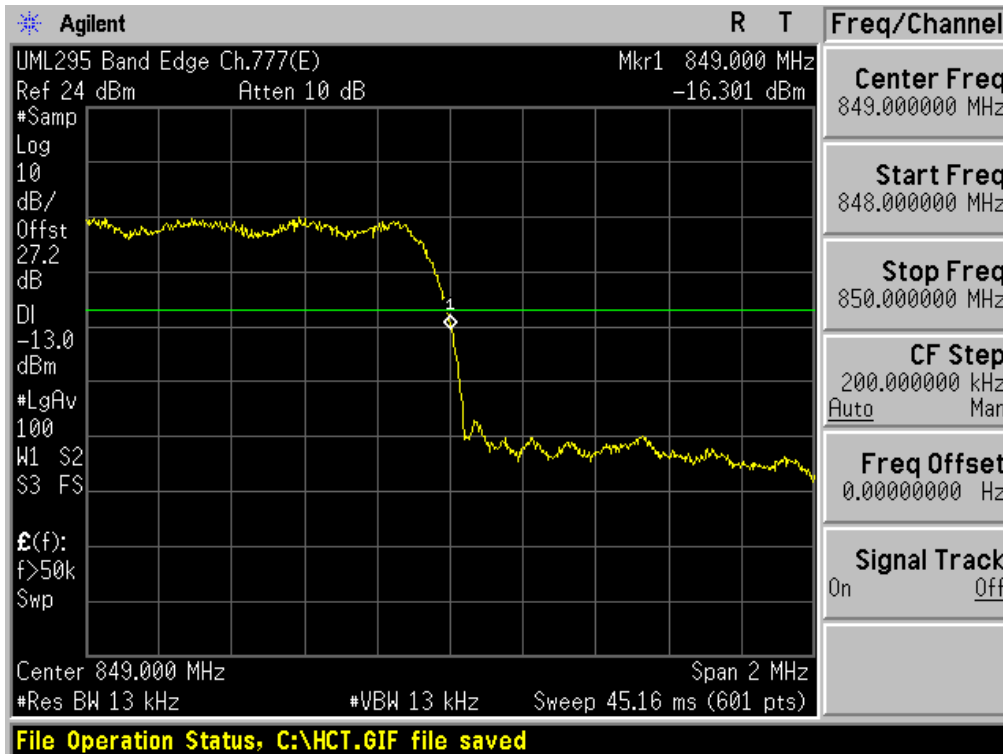

FCC CERTIFICATION REPORT			www.hct.co.kr
Test Report No. HCTR1207FR06-1	Date of Issue: July 30, 2017	EUT Type: CDMA/GSM/WCDMA/LTE Data Dongle	FCC ID: JYCSPARKLE

■ CDMA MODE (1013 CH.) 4 MHz Span

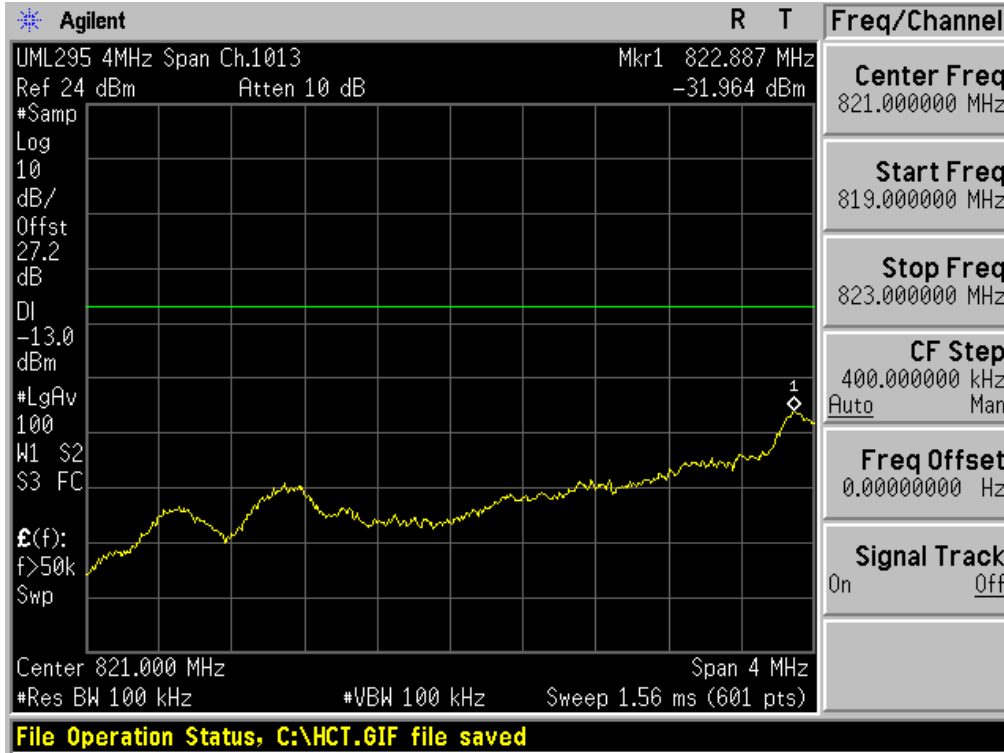

■ CDMA MODE (777 CH.) 4 MHz Span

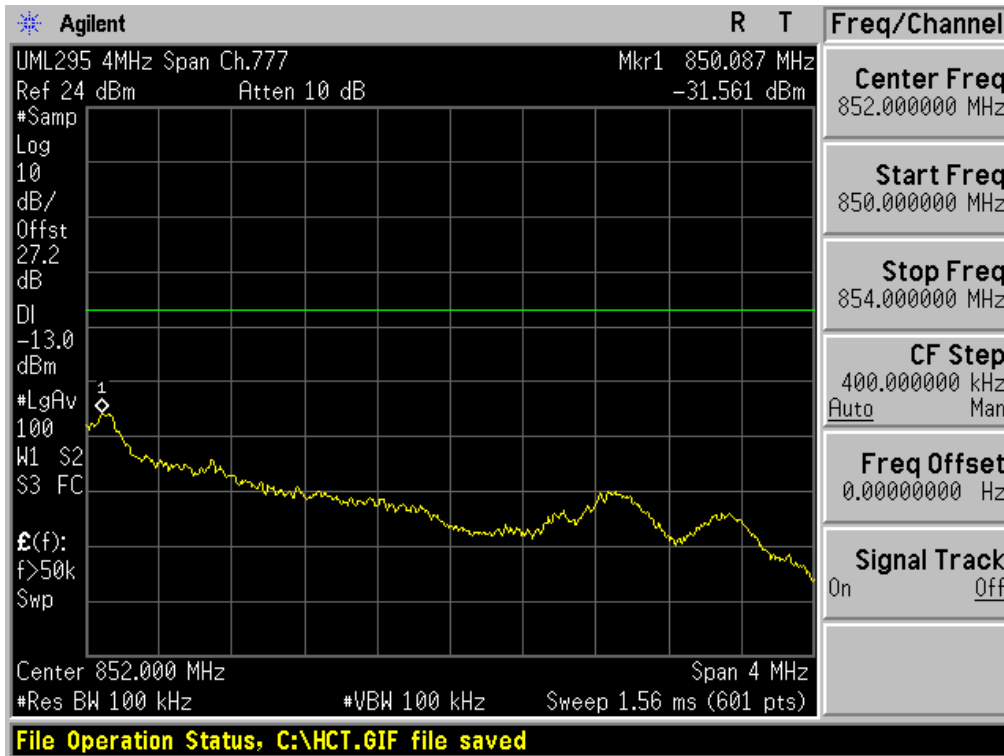

FCC CERTIFICATION REPORT			www.hct.co.kr
Test Report No. HCTR1207FR06-1	Date of Issue: July 30, 2017	EUT Type: CDMA/GSM/WCDMA/LTE Data Dongle	FCC ID: JYCSPARKLE

■ CDMA EVDO MODE (1013 CH.) 4 MHz Span

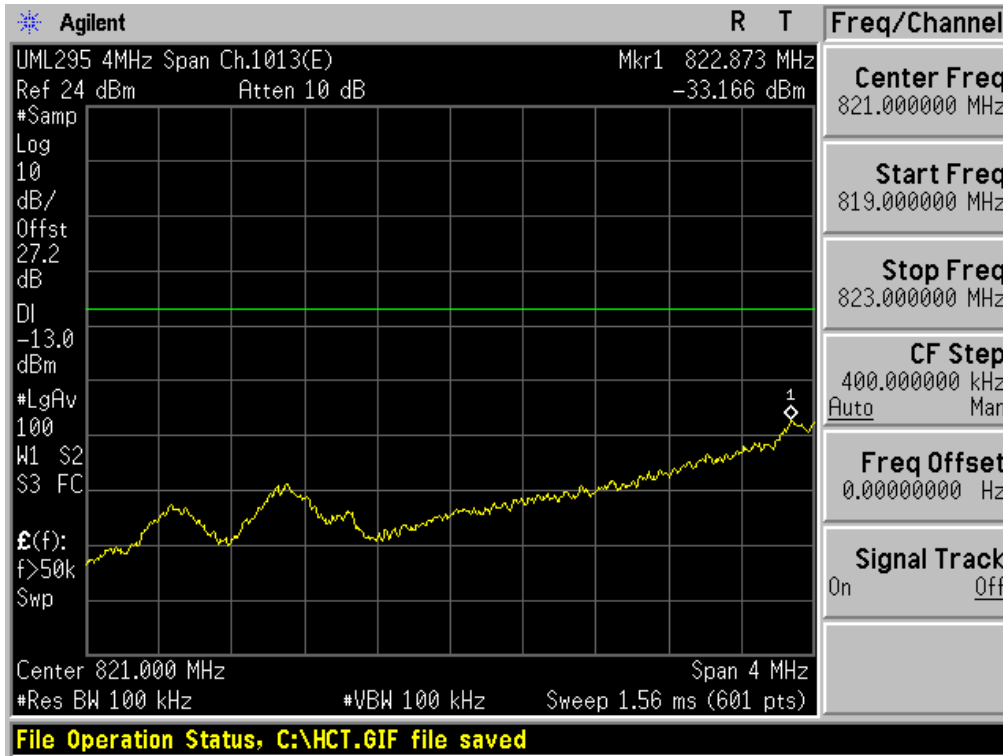

■ CDMA EVDO MODE (777 CH.) 4 MHz Span

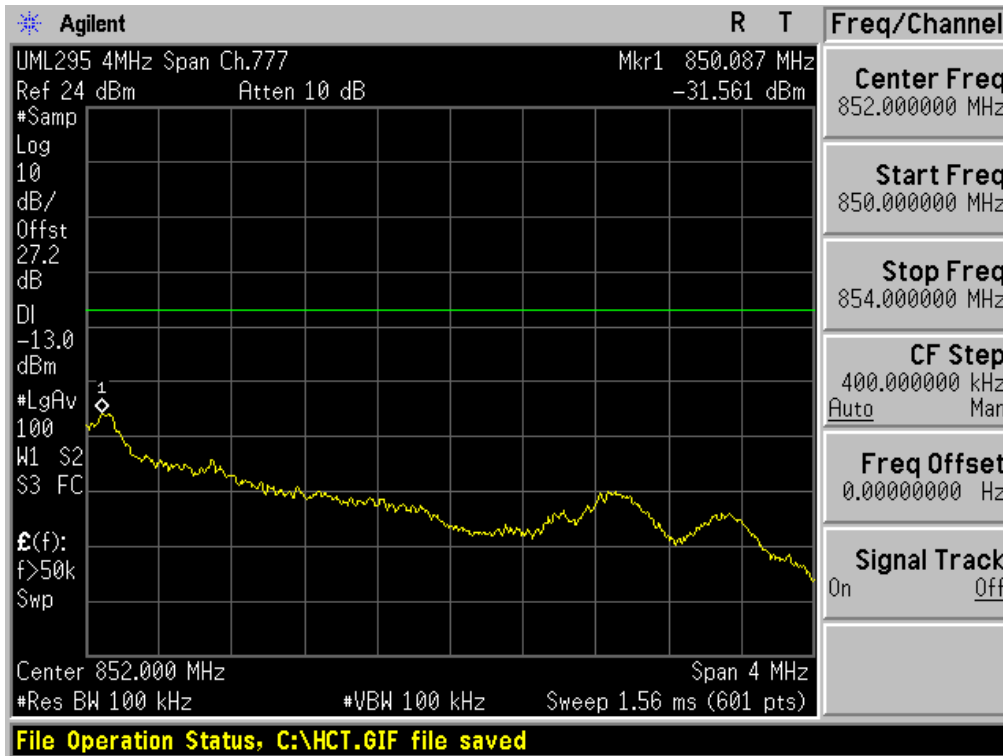

FCC CERTIFICATION REPORT			www.hct.co.kr
Test Report No. HCTR1207FR06-1	Date of Issue: July 30, 2017	EUT Type: CDMA/GSM/WCDMA/LTE Data Dongle	FCC ID: JYCSPARKLE

■ PCS CDMA MODE (25 CH.) Block Edge

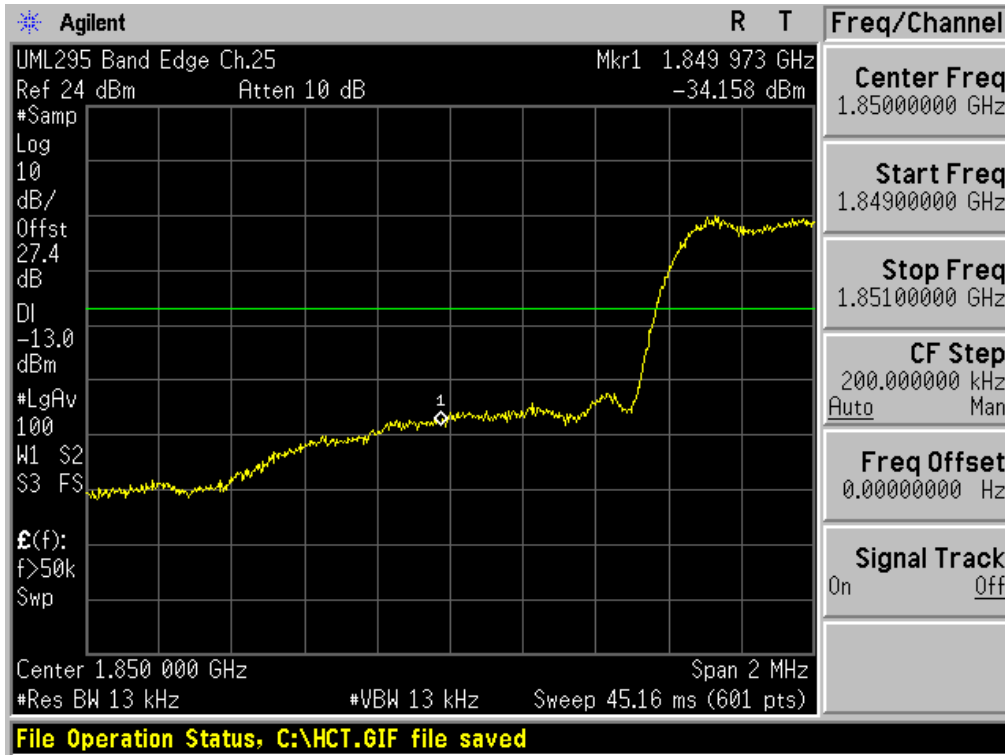

■ PCS CDMA MODE (1175 CH.) Block Edge

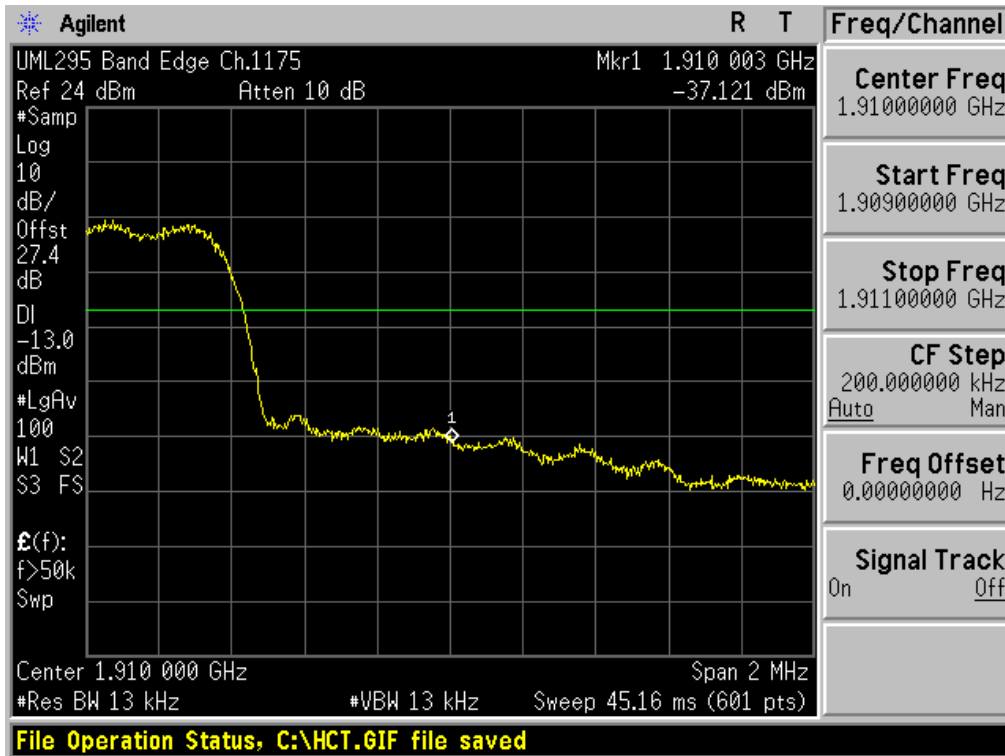

FCC CERTIFICATION REPORT			www.hct.co.kr
Test Report No. HCTR1207FR06-1	Date of Issue: July 30, 2017	EUT Type: CDMA/GSM/WCDMA/LTE Data Dongle	FCC ID: JYCSPARKLE

■ PCS CDMA EVDO MODE (25 CH.) Block Edge

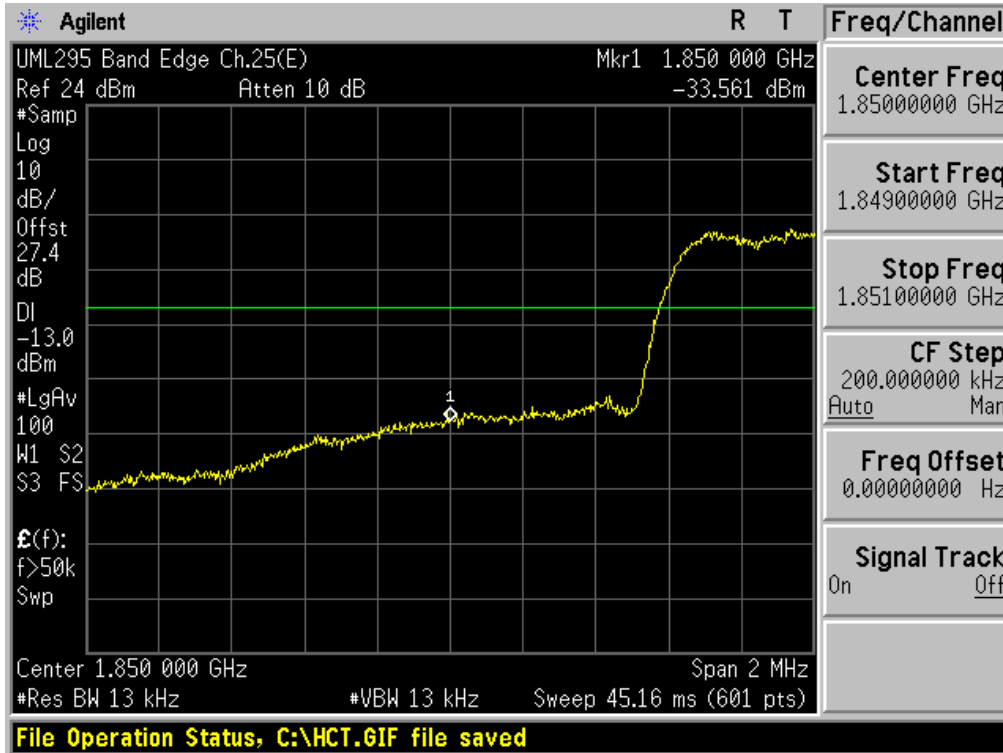

■ PCS CDMA EVDO MODE (1175 CH.) Block Edge

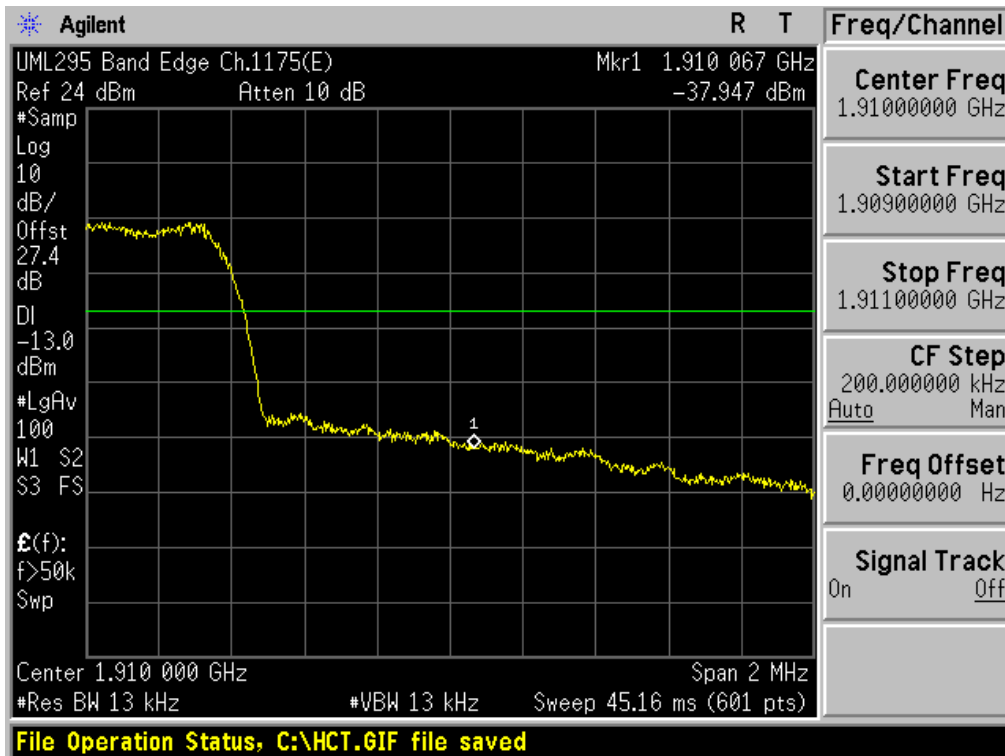

FCC CERTIFICATION REPORT			www.hct.co.kr
Test Report No. HCTR1207FR06-1	Date of Issue: July 30, 2017	EUT Type: CDMA/GSM/WCDMA/LTE Data Dongle	FCC ID: JYCSPARKLE

■ PCS CDMA MODE (25 CH.) 4 MHz Span

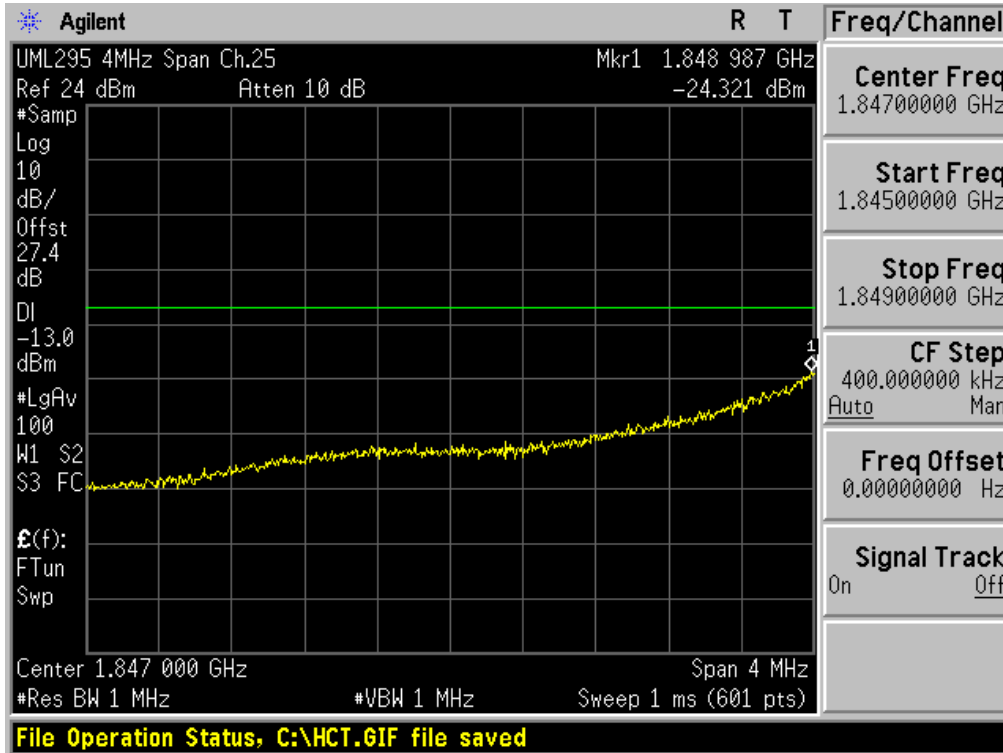

■ PCS CDMA MODE (1175 CH.) 4 MHz Span

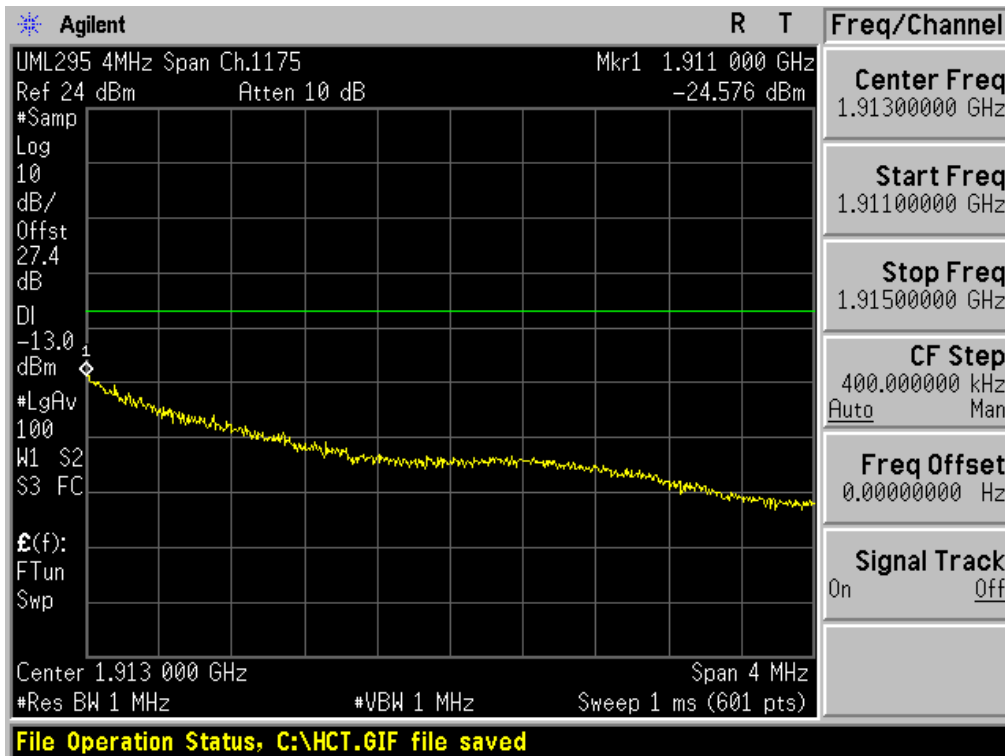

FCC CERTIFICATION REPORT			www.hct.co.kr
Test Report No. HCTR1207FR06-1	Date of Issue: July 30, 2017	EUT Type: CDMA/GSM/WCDMA/LTE Data Dongle	FCC ID: JYCSPARKLE

■ PCS CDMA EVDO MODE (25 CH.) 4 MHz Span

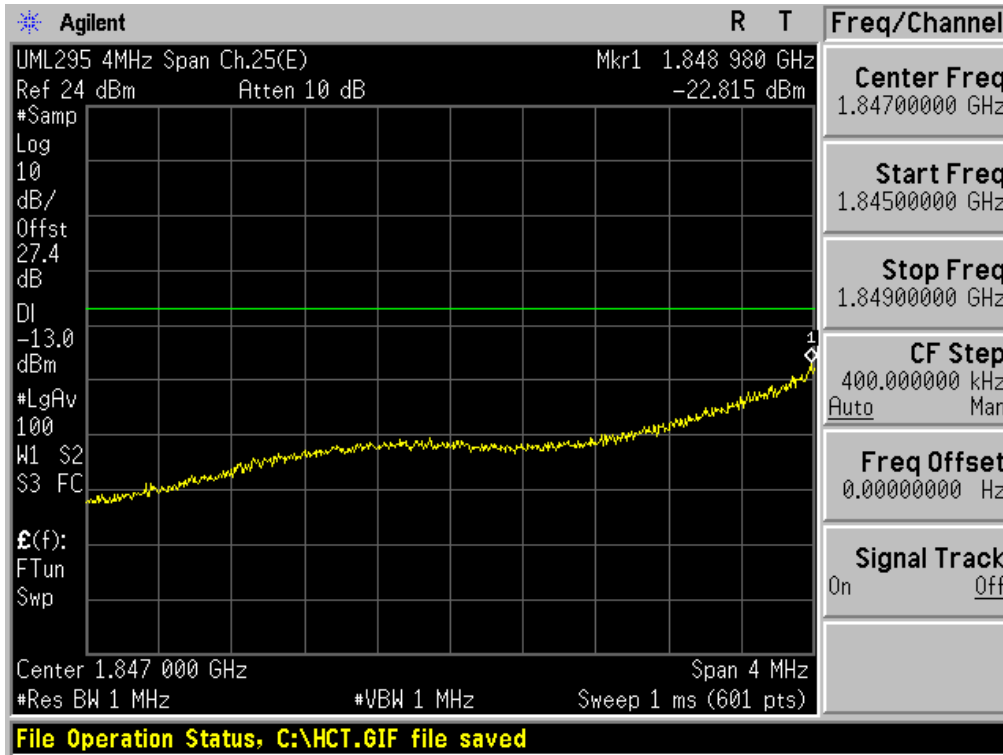

■ PCS CDMA EVDO MODE (1175 CH.) 4 MHz Span

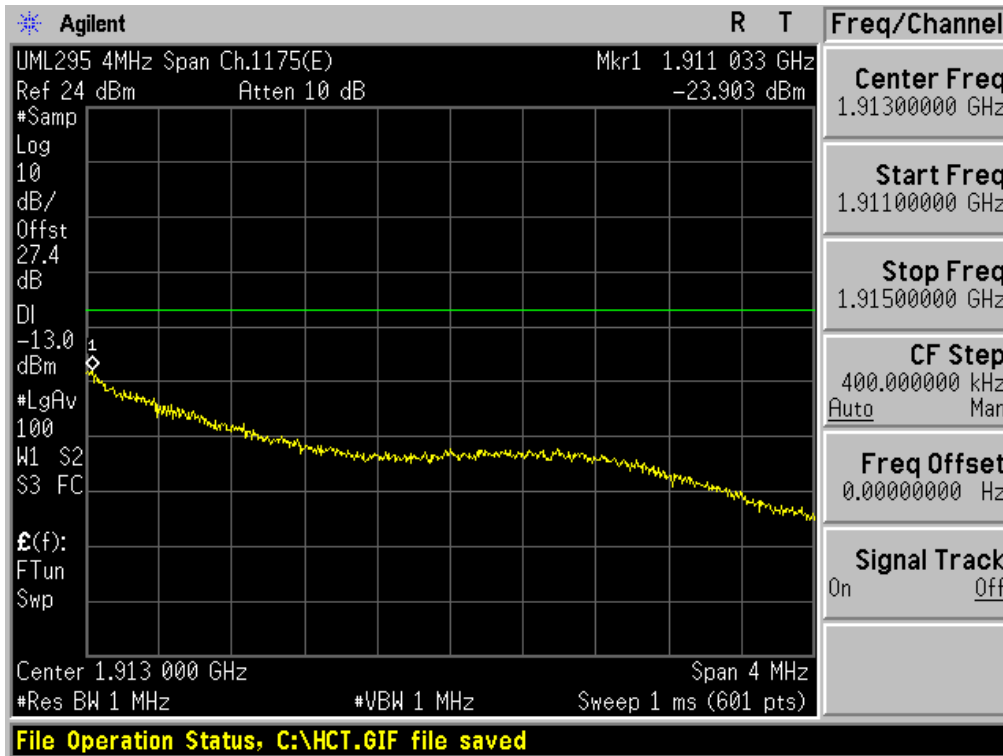

FCC CERTIFICATION REPORT			www.hct.co.kr
Test Report No. HCTR1207FR06-1	Date of Issue: July 30, 2017	EUT Type: CDMA/GSM/WCDMA/LTE Data Dongle	FCC ID: JYCSPARKLE

■ CDMA MODE (1013 CH.) Conducted Spurious Emissions - 1

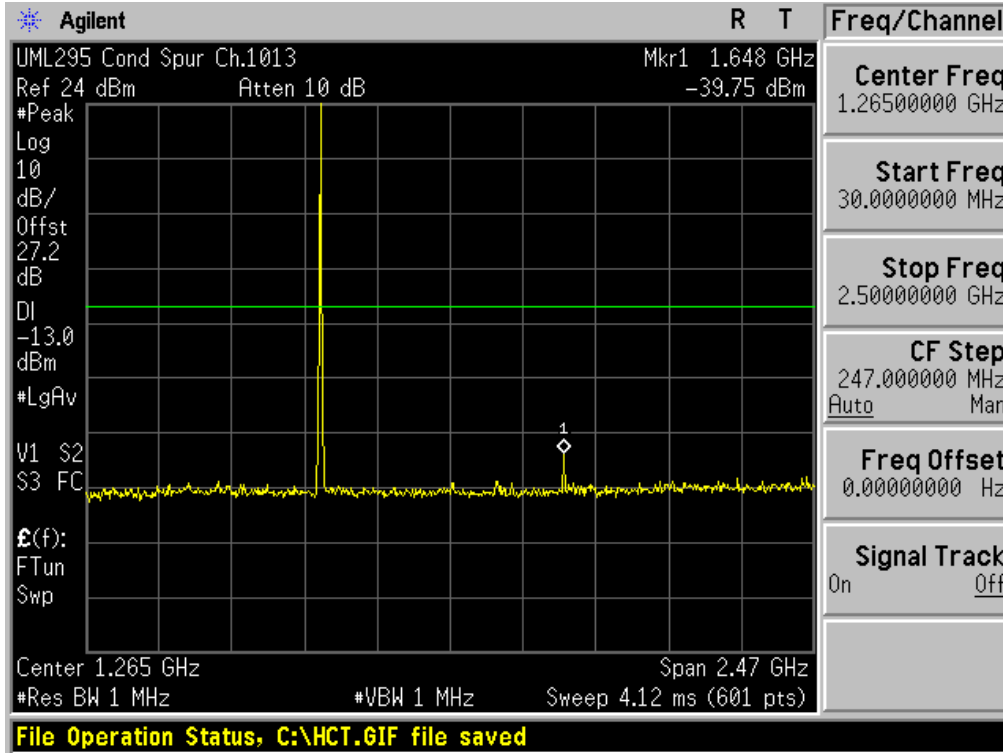

■ CDMA MODE (1013 CH.) Conducted Spurious Emissions - 2

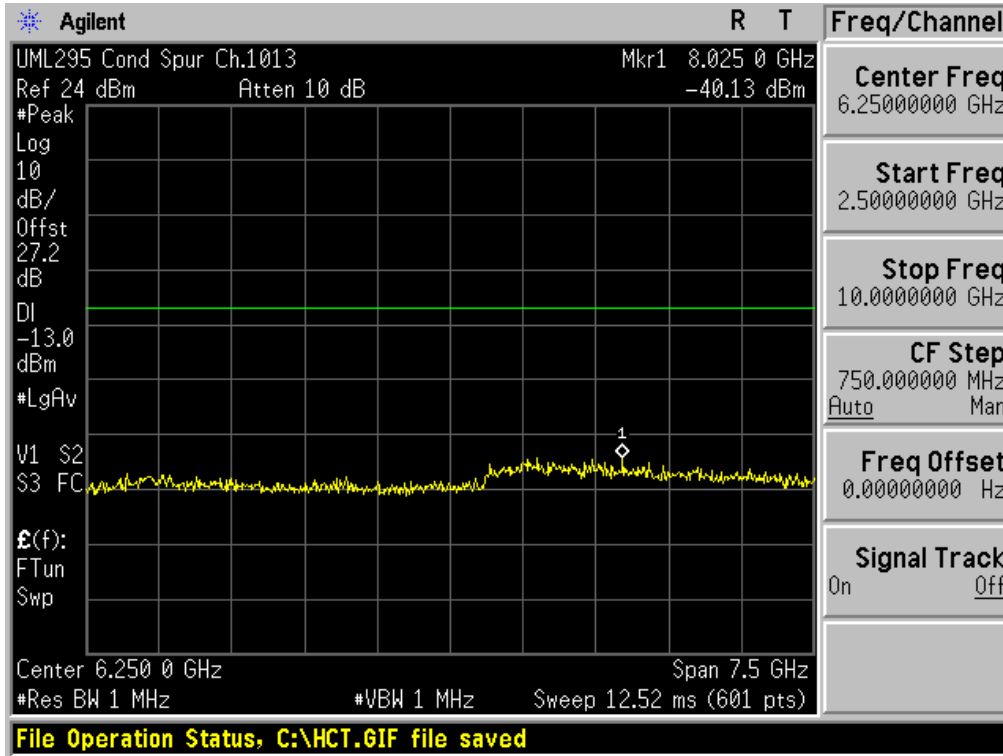

FCC CERTIFICATION REPORT			www.hct.co.kr
Test Report No. HCTR1207FR06-1	Date of Issue: July 30, 2017	EUT Type: CDMA/GSM/WCDMA/LTE Data Dongle	FCC ID: JYCSPARKLE

■ CDMA MODE (384 CH.) Conducted Spurious Emissions - 1

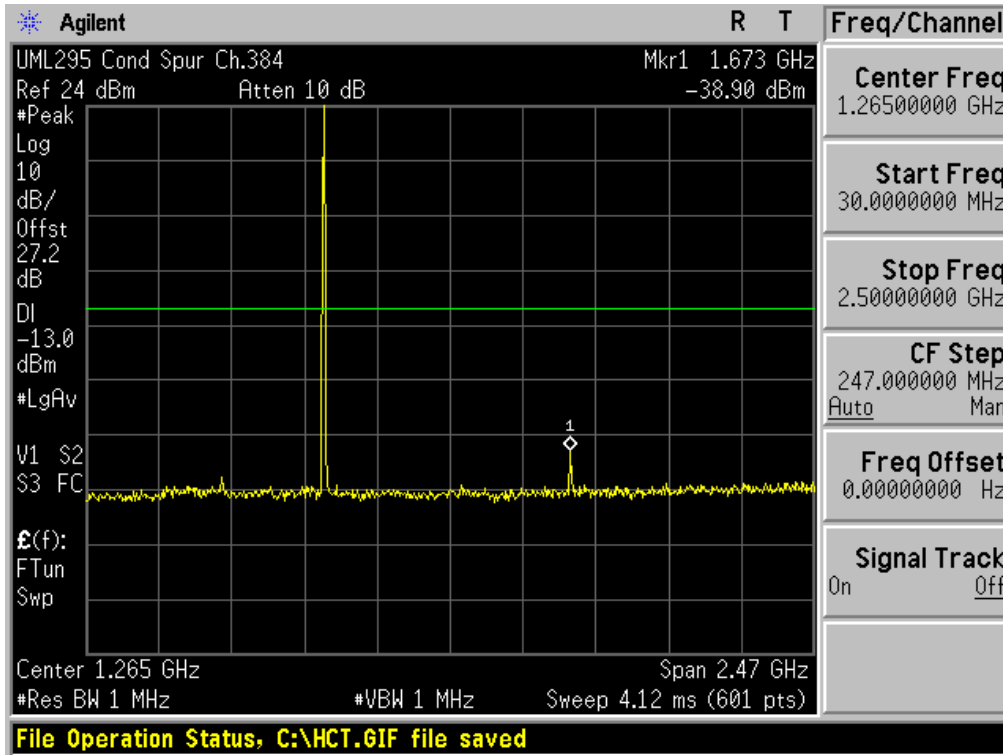

■ CDMA MODE (384 CH.) Conducted Spurious Emissions - 2

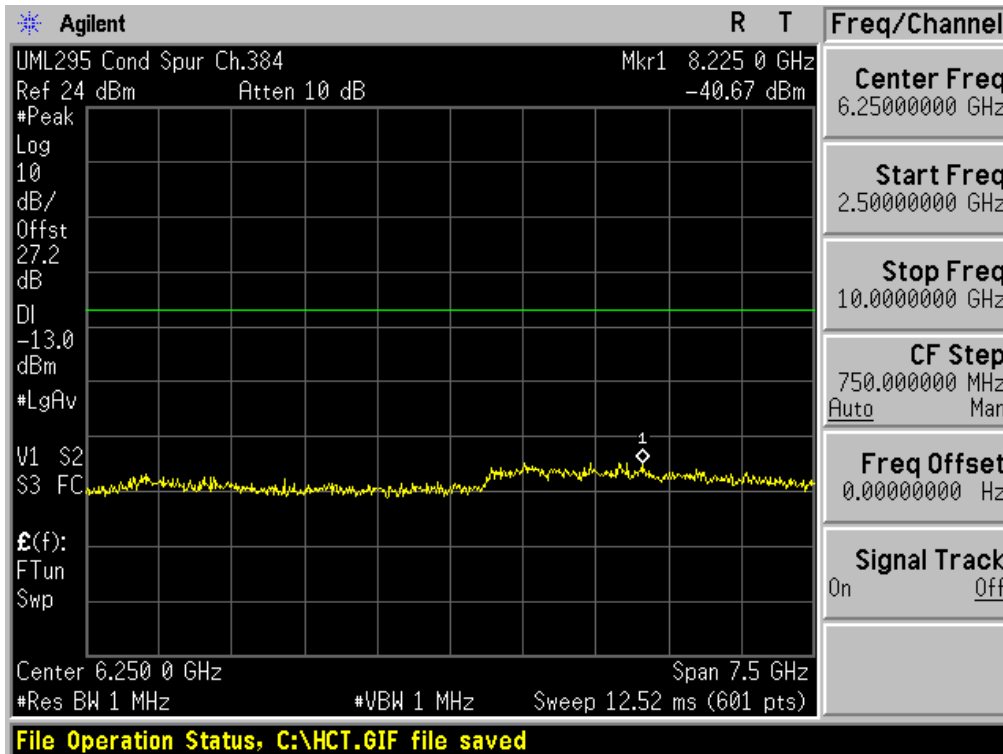

FCC CERTIFICATION REPORT			www.hct.co.kr
Test Report No. HCTR1207FR06-1	Date of Issue: July 30, 2017	EUT Type: CDMA/GSM/WCDMA/LTE Data Dongle	FCC ID: JYCSPARKLE

■ CDMA MODE (777 CH.) Conducted Spurious Emissions - 1

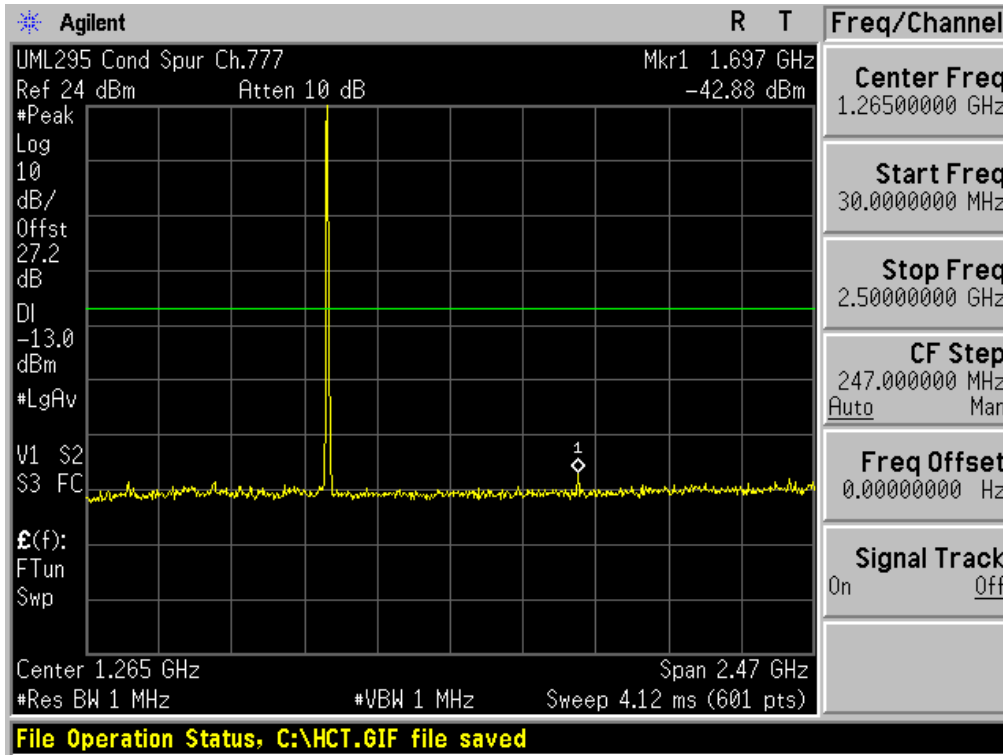

■ CDMA MODE (777 CH.) Conducted Spurious Emissions - 2

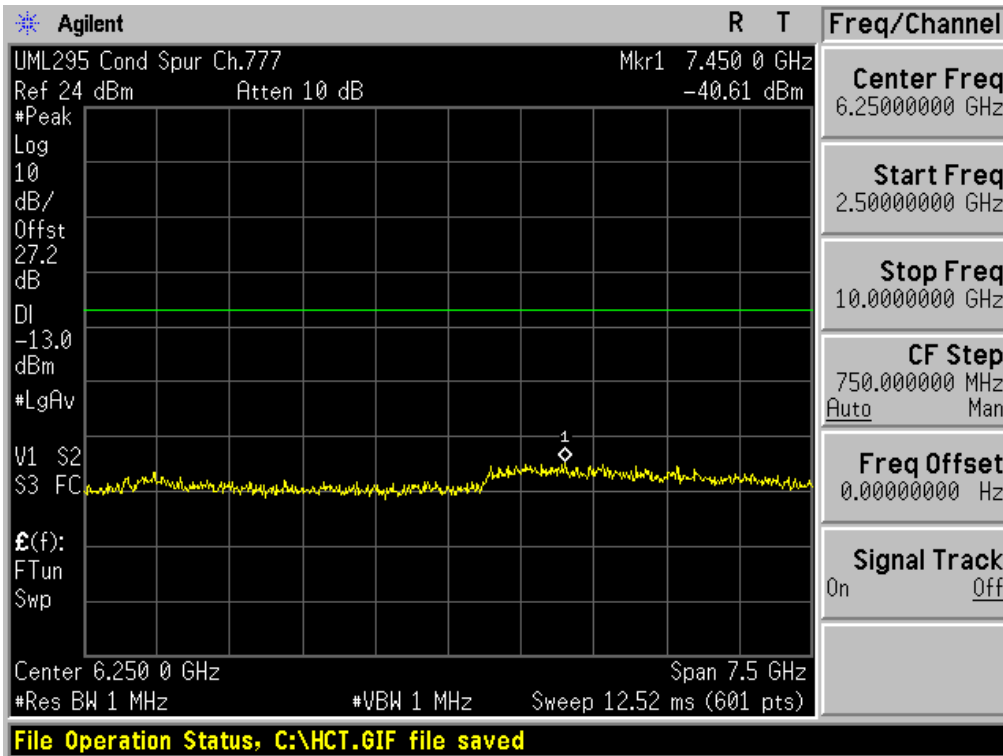

FCC CERTIFICATION REPORT			www.hct.co.kr
Test Report No. HCTR1207FR06-1	Date of Issue: July 30, 2017	EUT Type: CDMA/GSM/WCDMA/LTE Data Dongle	FCC ID: JYCSPARKLE

■ PCS CDMA MODE (25 CH.) Conducted Spurious Emissions - 1

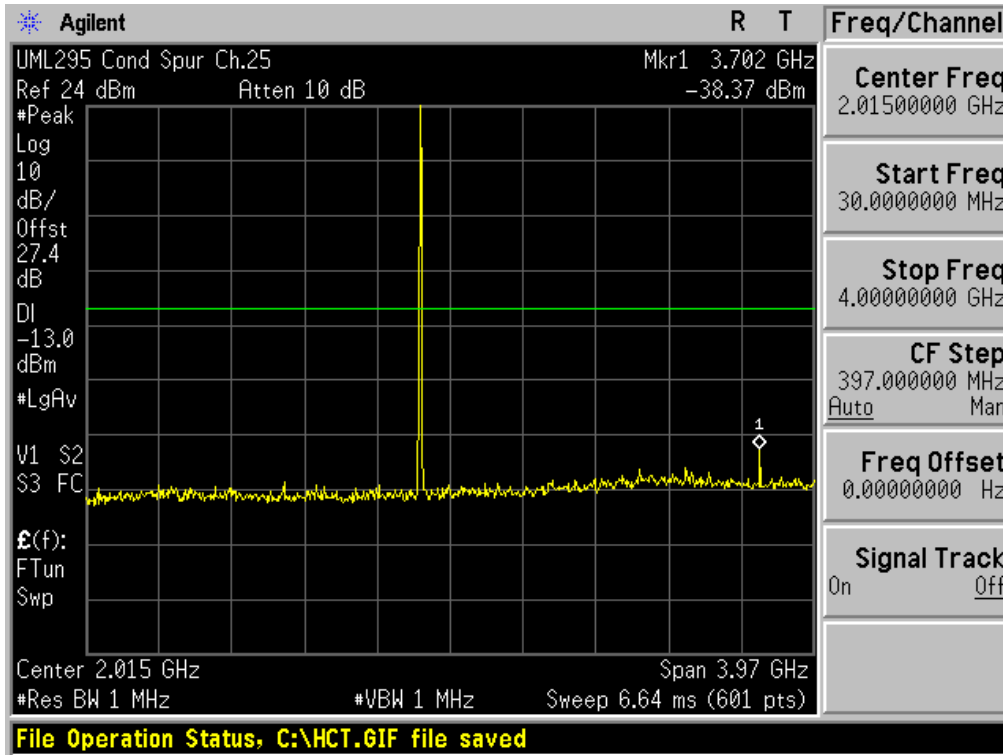

■ PCS CDMA MODE (25 CH.) Conducted Spurious Emissions - 2

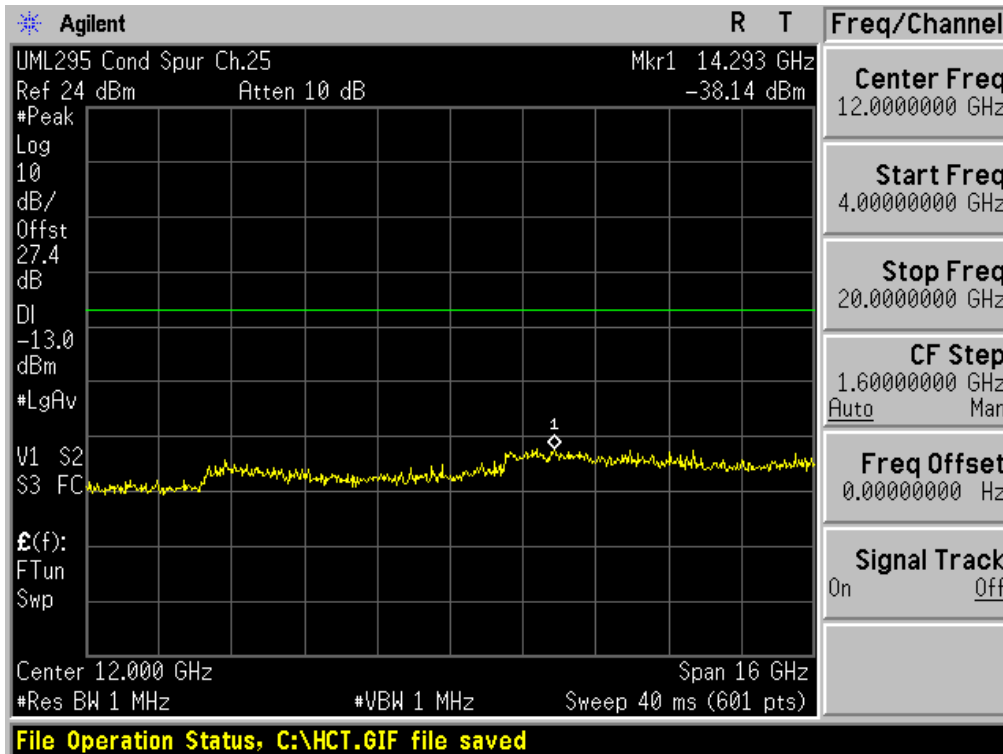

FCC CERTIFICATION REPORT			www.hct.co.kr
Test Report No. HCTR1207FR06-1	Date of Issue: July 30, 2017	EUT Type: CDMA/GSM/WCDMA/LTE Data Dongle	FCC ID: JYCSPARKLE

■ PCS CDMA MODE (600 CH.) Conducted Spurious Emissions - 1

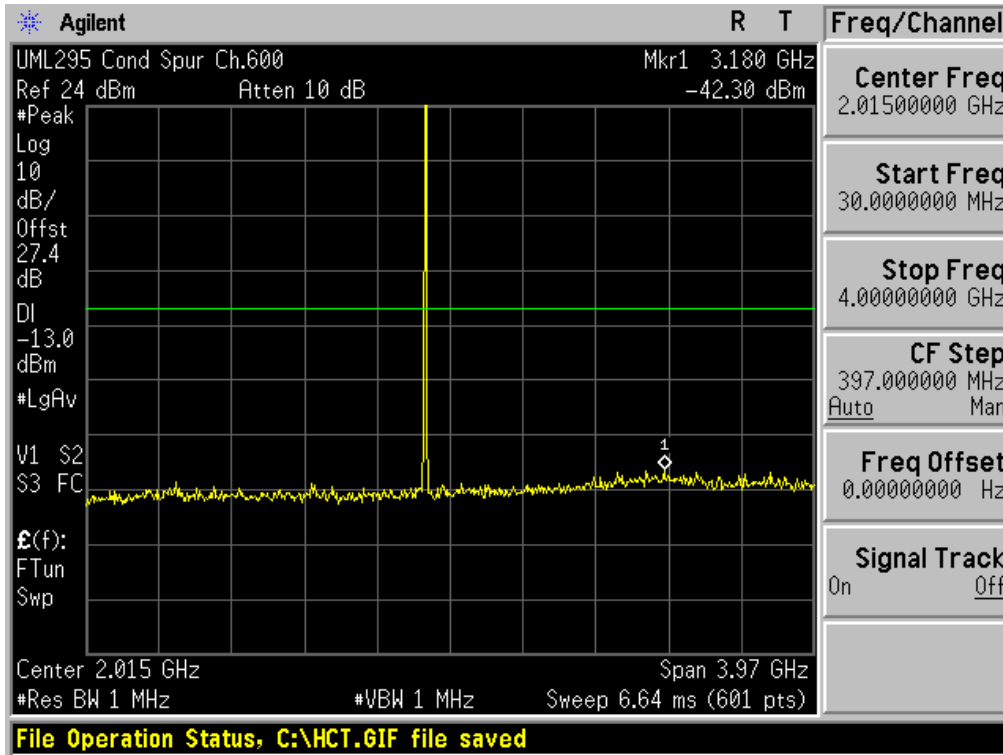

■ PCS CDMA MODE (600 CH.) Conducted Spurious Emissions - 2

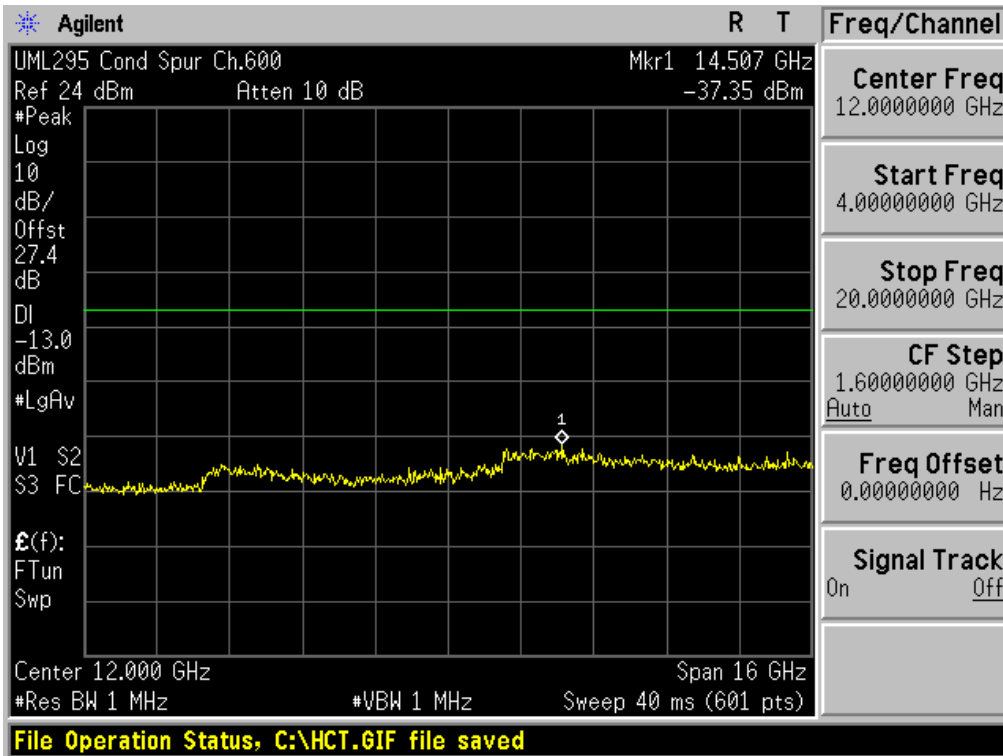

FCC CERTIFICATION REPORT			www.hct.co.kr
Test Report No. HCTR1207FR06-1	Date of Issue: July 30, 2017	EUT Type: CDMA/GSM/WCDMA/LTE Data Dongle	FCC ID: JYCSPARKLE

■ PCS CDMA MODE (1175 CH.) Conducted Spurious Emissions - 1

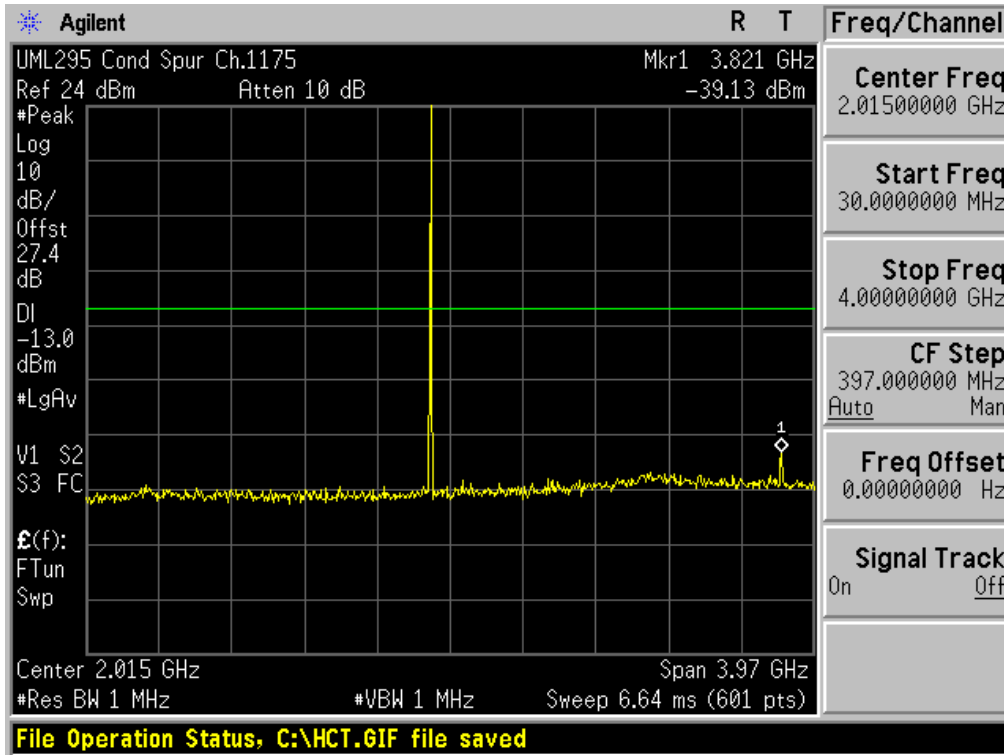

■ PCS CDMA MODE (1175 CH.) Conducted Spurious Emissions - 2

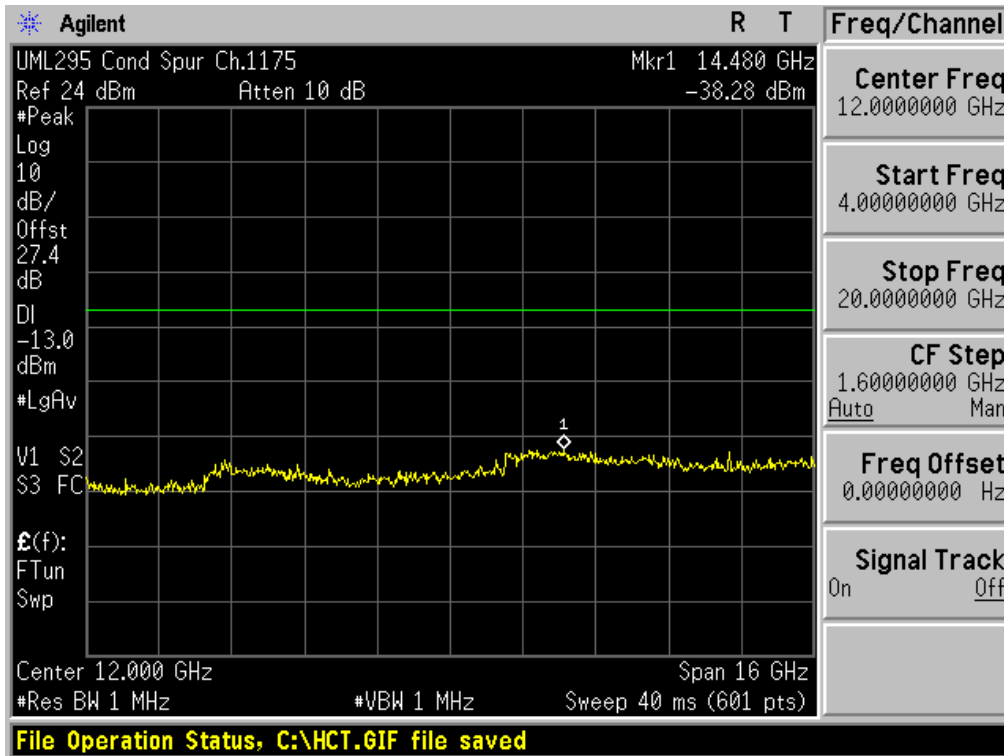

FCC CERTIFICATION REPORT			www.hct.co.kr
Test Report No. HCTR1207FR06-1	Date of Issue: July 30, 2017	EUT Type: CDMA/GSM/WCDMA/LTE Data Dongle	FCC ID: JYCSPARKLE