



**ELECTRONIC TECHNOLOGY SYSTEMS
DR. GENZ GMBH**

TEST - REPORT

SAR Compliance Test Report

Test report no.:

G5M205010001-S-8

SAR



TABLE OF CONTENTS

| | |
|----------|---------------------------------------|
| 1 | General information |
| 1.1 | Notes |
| 1.2 | Testing laboratory |
| 1.3 | Details of approval holder |
| 1.4 | Manufacturer |
| 1.5 | Application details |
| 1.6 | Test item |
| 1.7 | Test results |
| 1.8 | Test standards |
| 2 | Technical test |
| 2.1 | Summary of test results |
| 2.2 | Test environment |
| 2.3 | Test equipment utilized |
| 2.4 | Definitions |
| 2.5 | Measurement system description |
| 2.6 | Test system specification |
| 2.7 | Measurement procedure |
| 2.8 | Reference points |
| 2.9 | Test positions |
| 2.10 | Measurement uncertainty |
| 3 | Tissue and system verification |
| 3.1 | Tissue verification |
| 3.2 | System verification |
| 4 | Test Results |
| 5 | References |
| 6 | Appendix |

1 General Information

1.1 Notes

The purpose of conformity testing is to increase the probability of adherence to the essential requirements or conformity specifications, as appropriate.

The complexity of the technical specifications, however, means that full and thorough testing is impractical for both technical and economic reasons.

Furthermore, there is no guarantee that a test sample which has passed all the relevant tests conforms to a specification.

The existence of the tests nevertheless provides the confidence that the test sample possesses the qualities as maintained and that its performance generally conforms to representative cases of communications equipment.

The test results of this test report relate exclusively to the item tested as specified in 1.5.

The test report may only be reproduced or published in full.

Reproduction or publication of extracts from the report requires the prior written approval of the ELECTRONIC TECHNOLOGY SYSTEMS DR. GENZ GMBH.

I attest to the accuracy of data. All measurements reported herein were performed by me or were made under my supervision and are correct to the best of my knowledge and belief. I assume full responsibility for the completeness of these measurements and vouch for the qualification of all persons taking them.

Tester:

03.03.2005

N. Kaspar



Date

ETS-Lab.

Name

Signature

Technical responsibility for area of testing:

03.03.2005

Dr. Genz



Date

ETS

Name

Signature

1.2 Testing laboratory

1.2.1 Location

ELECTRONIC TECHNOLOGY SYSTEM DR. GENZ GMBH (ETS)
Storkower Straße 38c
D-15526 Reichenwalde b. Berlin
Germany
Telephone : +49 33631 888 00
Fax : +49 33631 888 660

1.2.2 Details of accreditation status

ACCREDITED TESTING LABORATORY

DAR-REGISTRATION NUMBER: TTI-P-G 126/96

FCC FILED TEST LABORATORY REG. No. 96970

BLUETOOTH QUALIFICATION TEST FACILITY (BQTF)

ACCREDITED BY BLUETOOTH QUALIFICATION REVIEW BOARD

INDUSTRY CANADA FILED TEST LABORATORY REG. No. IC 3470

A2LA ACCREDITED Certificate Number 1983-01

1.3 Details of approval holder

Name : Pantech Co., Ltd.
Street : Sinsong Center Bldg. 8th Fl., 25-12, Yeouido-dong
Town : Yeongdeungpo-gu, Seoul
Country : Korea
Telephone : +82-2-3660-5862
Fax : +82-2-3660-5990
Contact : Mr. B.W. Kim
E-Mail : bwkim@pantech.co.kr

1.4 Manufacturer: (if applicable)

Name :
Street :
Town :
Country :

1.5 Application details

Date of receipt of application : 28.01.2005
Date of receipt of test item : 28.01.2005
Date of test : 21.02. - 24.02.2005

1.6 Test item

FCC ID : JYCPG-3210
Description of test item : Triple Band GSM 850 (E-GSM)/DCS 1800 /PCS 1900 (with WAP & GPRS)
Type identification : PG-3210
Serial number : without; Identical prototype
Device category : PCB (Licensed Base Station)

Technical data

| | GSM850 | PCS 1900 |
|--------------------------------|------------------------------------|------------------------|
| TX Frequency range | : 824,2 - 848,8 MHz | 1850,2 - 1909,8 MHz |
| RX Frequency range | : 869,2 - 893,8 MHz | 1930,2 - 1989,8 MHz |
| Max. Conducted RF output power | : 32.4 dBm / (1737.8 mW) | 29.2 dBm / (831.76 mW) |
| Power supply | : 4,2 V DC rechargeable battery | |
| Antenna Tx | : integral | |
| Antenna RX | : integral | |
| Additional information | : Tx and Rx. antenna are the same. | |

1.7 Test Results

Max. SAR Measurement : 1.19 W/kg (averaged over 1 gram)

This EUT has been shown to be capable of compliance for localized specific absorption rate (SAR) for uncontrolled environment/general population exposure limits specified in ANSI/IEEE Std. C95.1-1992 and had been tested in accordance with the measurement procedures specified in FCC/OET Bulletin 65 Supplement C (2001) and IEEE Std. 1528-2003, December 2003.

1.8 Test standards

Standards : - IEEE Std. 1528-200X (Draft 6.5, January 2002), December 2003

FCC Rule Part(s) : - FCC OET Bulletin 65, Supplement C, Edition 01-01

2 Technical test

2.1 Summary of test results

Applicable Configuration

| | |
|---------------------|---|
| Handset (Head) | X |
| Handset (Body) | X |
| Headset (Head) | |
| Body Worn Equipment | |

EUT complies with the RF radiation exposure limits of the FCC as shown by the SAR measurement results. These measurements are taken to simulate the RF effects exposure under worst-case conditions. The EUT complies with the requirements in respect to all parameters subject to the test. The test results and statements relate only to the item(s) tested.

Please note that the absorption and distribution of electromagnetic energy in the body are very complex phenomena that depend on the mass, shape, and size of the body, the orientation of the body with respect to the field vectors, and the electrical properties of both the body and the environment. Other variables that may play a substantial role in possible biological effects are those that characterize the environment (e.g. ambient temperature, air velocity, relative humidity, and body insulation) and those that characterize the individual (e.g. age, gender, activity level, debilitation, or disease). Because innumerable factors may interact to determine the specific biological outcome of an exposure to electromagnetic fields, any protection guide shall consider maximal amplification of biological effects as a result of field-body interactions, environmental conditions, and physiological variables. [1]

In case of multiple hotspots the hotspot with the highest value is displayed only. The second hotspots are measured and stored by the measurement system too. Only the highest value is displayed as cube in the measurement plot and the results table.

2.2 Test environment

Room temperature : 22,1 -22,6 °C

Liquid temperature : 22,0 -22,3 °C

Relative humidity content : 20 ... 75 %

Air pressure : 86 ... 103 k P a

Details of power supply : 4,2 DC

2.3 Test equipment utilized

| No. | Measurement device: | Type: | Manufacturer: |
|-----------|--------------------------------------|--------------------|------------------|
| ETS 0449 | Stäubli Robot | RX90B L | Stäubli |
| ETS 0450 | Stäubli Robot Controller | CS/MBs&p | Stäubli |
| ETS 0451 | DASY 4 Measurement Server | | Schmid & Partner |
| ETS 0452 | Control Pendant | | Stäubli |
| ETS 0453 | Compaq Computer | Pentium IV, 2 GHz, | Schmid & Partner |
| ETS 0454 | Dabu Acquisition Electronics | DAE3V1 | Schmid & Partner |
| ETS 0455 | Dummy Probe | | Schmid & Partner |
| ETS 0456 | Dosimetric E-Field Probe | ET3DV6 | Schmid & Partner |
| ETS 0457 | Dosimetric E-Field Probe | ET3DV6 | Schmid & Partner |
| ETS 0458 | Dosimetric H-Field Probe | H3DV6 | Schmid & Partner |
| ETS 0459 | System Validation Kit | D900V2 | Schmid & Partner |
| ETS 0460 | System Validation Kit | D1800V2 | Schmid & Partner |
| ETS 0461 | System Validation Kit | D1900V2 | Schmid & Partner |
| ETS 0462 | System Validation Kit | D2450V2 | Schmid & Partner |
| ETS 0463 | Probe Alignment Unit | LBV2 | Schmid & Partner |
| ETS 0464 | SAM Twin phantom | V 4.0 | Schmid & Partner |
| ETS 0465 | Mounting Device | V 3.1 | Schmid & Partner |
| ETS 0224a | Millivoltmeter | URV 5 | Rohde & Schwarz |
| ETS 0219 | Power sensor | NRV-Z2 | Rohde & Schwarz |
| ETS 0268 | RF signal generator | SMP 02 | Rohde & Schwarz |
| ETS 0322 | Insertion unit | URV5-Z4 | Rohde & Schwarz |
| ETS 0466 | Directional Coupler | HP 87300B | HP |
| ETS0231 | Radio Communication Tester | CMD65 | Rohde & Schwarz |
| ETS 0467 | Universal Radio Communication Tester | CMU 200 | Rohde & Schwarz |
| ETS 0468 | Network Analyzer 300 kHz to 3 GHz | 8753C | Agilent |
| ETS 0469 | Dielectric Probe Kit | 85070C | Agilent |

2.4 Definitions

2.4.1 SAR

The specific absorption rate (SAR) is defined as the time derivative of the incremental energy (dW) absorbed by (dissipated in) an incremental mass (dm) contained in a volume element (dV) of a given density (ρ_t), expressed in watts per kilogram (W/kg)

$$\text{SAR} = \frac{d}{dt} \left(\frac{dW}{dm} \right) = \frac{d}{dt} \left(\frac{dW}{\rho_t dV} \right) = \frac{\sigma}{\rho_t} |E_t|^2$$

where:

$$\frac{dW}{dt} = \int_v E \cdot J dV = \int_v \sigma E^2 dV$$

2.4.2 Uncontrolled Exposure

The general population/uncontrolled exposure limits are applicable to situations in which the general public may be exposed or in which persons who are exposed as a consequence of their employment may not be made fully aware of the potential for exposure or cannot exercise control over their exposure. Members of the general public would come under this category when exposure is not employment-related; for example, in the case of a wireless transmitter that exposes persons in its vicinity. Warning labels placed on low-power consumer devices such as cellular telephones are not considered sufficient to allow the device to be considered under the occupational/controlled category, and the general population/uncontrolled exposure limits apply to these devices. [2]

2.4.3 Controlled Exposure

In general, occupational/controlled exposure limits are applicable to situations in which persons are exposed as a consequence of their employment, who have been made fully aware of the potential for exposure and can exercise control over their exposure. This exposure category is also applicable when the exposure is of a transient nature due to incidental passage through a location where the exposure levels may be higher than the general population/uncontrolled limits, but the exposed person is fully aware of the potential for exposure and can exercise control over his or her exposure by leaving the area or by some other appropriate means. Awareness of the potential for RF exposure in a workplace or similar environment can be provided through specific training as part of a RF safety program. If appropriate, warning signs and labels can also be used to establish such awareness by providing prominent information on the risk of potential exposure and instructions on the risk of potential exposure and instructions on methods to minimize such exposure risks. [2]

2.5 Measurement System Description

2.5.1 System Setup

Measurements are performed using the DASY4 automated dosimetric assessment system (figure 1) made by Schmid & Partner Engineering AG (SPEAG) in Zurich, Switzerland.



Figure 1

The DASY4 system for performing compliance tests consists of the following items:

- A standard high precision 6-axis robot (Stäubli RX family) with controller, teach pendant and software. An arm extension for accommodating the data acquisition electronics (DAE).
- A dosimetric probe, i.e., an isotropic E-field probe optimized and calibrated for usage in tissue simulating liquid. The probe is equipped with an optical surface detector system.
- A data acquisition electronics (DAE) which performs the signal amplification, signal multiplexing, AD-conversion, offset measurements, mechanical surface detection, collision detection, etc. The unit is battery powered with standard or rechargeable batteries. The signal is optically transmitted to the EOC.
- An unit to operate the optical surface detector which is connected to the EOC.
- The Electro-optical converter (EOC) performs the conversion from the optical into a digital electric signal of the DAE. The EOC is connected to the measurement server.
- The functions of the measurement server is to perform the time critical task such as signal filtering, surveillance of the robot operation, fast movement interrupts.
- A probe alignment unit which improves the (absolute) accuracy of the probe positioning.
- A computer operating Windows 2000 or Windows NT.
- DASY4 software.
- Remote control with teach pendant and additional circuitry for robot safety such as warning lamps, etc.
- The SAM twin phantom enabling testing left-hand and right-hand usage.
- The device holder for handheld mobile phones.
- Tissue simulating liquid mixed according to the given recipes (see Application Notes).
- System validation dipoles allowing to validate the proper functioning of the system.

2.5.2 Phantom Description



Figure 2

The SAM twin phantom V4.0 (figure 2) is a fiberglass shell phantom with 2 mm shell thickness. It has three measurement areas:

- Left hand
- Right hand
- Flat phantom

The phantom is integrated in a wooden table.

The bottom plate of the table contains three pair of bolts for locking the device holder. The device holder positions are adjusted to the standard measurement positions in the three sections. Only one device holder is necessary if two phantoms are used (e.g., for different liquids).

A cover is provided to tap the phantom during off-periods to prevent water evaporation and changes in the liquid parameters. Free space scans of devices on the cover are possible.

On the phantom top, three reference markers are provided to identify the phantom positions with respect to the robot.

2.5.3 Tissue Simulating Liquids

The parameters of the tissue simulating liquid strongly influence the SAR. The parameters for the different frequencies are defined in the corresponding compliance standards (e.g., EN 50361, IEEE P1528-200X).

Tissue dielectric properties

| Frequency (MHz) | Head | | Body | |
|-----------------|---|---------------------------------|---|---------------------------------|
| | Relative Dielectric Constant (ϵ_r) | Conductivity (σ) (S/m) | Relative Dielectric Constant (ϵ_r) | Conductivity (σ) (S/m) |
| 300 | 45.3 | 0.87 | 58.2 | 0.92 |
| 450 | 43.5 | 0.87 | 56.7 | 0.94 |
| 835 | 41.5 | 0.90 | 55.2 | 0.97 |
| 900 | 41.5 | 0.97 | 55.0 | 1.05 |
| 1450 | 40.5 | 1.20 | 54.0 | 1.30 |
| 1800 | 40.0 | 1.40 | 53.3 | 1.52 |
| 1900 | 40.0 | 1.40 | 53.3 | 1.52 |
| 2000 | 40.0 | 1.40 | 53.3 | 1.52 |
| 2450 | 39.2 | 1.80 | 52.7 | 1.95 |
| 3000 | 38.5 | 2.40 | 52.0 | 2.73 |

2.5.4 Device Holder

The DASY device holder (figure 3.1 and 3.2) is designed to cope with different positions given in the standard. It has two scales for the device rotation (with respect to the body axis) and the device inclination (with respect to the line between the ear openings). The rotation centers for both scales is the ear opening. Thus the device needs no repositioning when changing the angles.



Figure 3.1



Figure 3.2

The DASY device holder has been made out of low-loss POM material having the following dielectric parameters: relative permittivity $\epsilon = 3$ and loss tangent $\delta = 0.02$. The amount of dielectric material has been reduced in the closest vicinity of the device, since measurements have suggested that the influence of the clamp on the test results could thus be lowered.

2.5.5 Probes

The SAR measurements were conducted with the dosimetric probe ET3DV6 (figure 4), designed in the classical triangular configuration and optimized for dosimetric evaluation. [3] The probe is constructed using the thick film technique; with printed resistive lines on ceramic substrates. The probe is equipped with an optical multifiber line ending at the front of the probe tip. It is connected to the EOC box on the robot arm and provides an automatic detection of the phantom surface. Half of the fibers are connected to a pulsed infrared transmitter, the other half to a synchronized receiver. As the probe approaches the surface, the reflection from the surface produces a coupling from the transmitting to the receiving fibers. This reflection increases first during the approach, reaches maximum and then decreases. If the probe is flatly touching the surface, the coupling is zero. The distance of the coupling maximum to the surface is independent of the surface reflectivity and largely independent of the surface to probe angle. The DASY4 software reads the reflection during a software approach and looks for the maximum using a 2nd order fitting. The approach is stopped at reaching the maximum.



Figure 4

Probe Specifications

| | |
|----------------|--|
| Calibration: | In air from 10 MHz to 2.5 GHz In brain and muscle simulating tissue at Frequencies of 835 MHz, 900 MHz, 1800 MHz, 1900 MHz and 2450 MHz Calibration certificates please find attached. |
| Frequency: | 10 MHz to > 3 GHz; Linearity: ± 0.2 dB (30 MHz to 3 GHz) |
| Directivity: | ± 0.2 dB in HSL (rotation around probe axis) ± 0.4 dB in HSL (rotation normal probe axis) |
| Dynamic Range: | 5 μ W/g to > 100 mW/g; |
| Linearity: | ± 0.2 dB |
| Dimensions: | Overall length: 330 mm Tip length: 16 mm Body diameter: 12 mm Tip diameter: 6.8 mm Distance from probe tip to dipole centers: 2.7 mm |
| Application: | General dosimetry up to 3 GHz Compliance tests of mobile phones Fast automatic scanning in arbitrary phantoms |

2.6 Test System Specification

Positioner

| | |
|----------------|--|
| Robot: | Stäubli Animation Corp. Robot Model: RX90B L |
| Repeatability: | 0.02 mm |
| No. of axis: | 6 |

Data Acquisition Electronic (DAE) System

Cell Controller

| | |
|-------------------|---|
| Processor: | Pentium IV |
| Clock Speed: | 2.0 GHz |
| Operating System: | Windows 2000 |
| Data Card: | DASY4 PC-Board |
| Data Converter | |
| Features: | Signal Amplifier, multiplexer, A/D converter, & control logic |
| Software: | DASY4 software |
| Connecting Lines: | Optical downlink for data and status info. Optical uplink for commands and clock |

PC Interface Card

| | |
|-----------|---|
| Function: | 24 bit (64 MHz) DSP for real time processing Link to DAE3 16 bit A/D converter for surface detection system serial link to robot direct emergency stop output for robot |
|-----------|---|

E-Field Probes

| | |
|---------------|--|
| Model: | ET3DV6 SN1711 |
| Construction: | Triangular core fiber optic detection system |
| Frequency: | 10 MHz to 6 GHz |
| Linearity: | ± 0.2 dB (30MHz to 3 GHz) |

Phantom

| | |
|-----------------|-------------------------|
| Phantom: | SAM Twin Phantom (V4.0) |
| Shell Material: | Fiberglass |
| Thickness: | 2.0 ± 0.2 mm |

2.7 Measurement Procedure

The evaluation was performed using the following procedure:

1. The SAR measurement was taken at a selected spatial reference point to monitor power variations during testing. This fixed location point was measured and used as a reference value.
2. The SAR distribution at the exposed side of the head was measured at a distance of 3.9mm from the inner surface of the shell. The area covered the entire dimension of the head and the horizontal grid spacing was 10mm x 10mm.
3. Based on the area scan data, the area of the maximum absorption was determined by spline interpolation. Around this point, a volume of 30mm x 30mm x 30mm (fine resolution volume scan, zoom scan) was assessed by measuring 5 x 5 x 5 points. On this basis of this data set, the spatial peak SAR value was evaluated with the following procedure:
 - a. The data at the surface was extrapolated, since the center of the dipoles is 2.7mm away from the tip of the probe and the distance between the surface and the lowest measuring point is 1.2mm. The extrapolation was based on a least square algorithm [4]. A polynomial of the fourth order was calculated through the points in z-axis. This polynomial was then used to evaluate the points between the surface and the probe tip.
 - b. The maximum interpolated value was searched with a straight-forward algorithm. Around this maximum the SAR values averaged over the spatial volumes (1g or 10g) were computed using the 3D-Spline interpolation algorithm. The 3D-spline is composed of three one-dimensional splines with the "Not a knot" condition (in x, y, and z directions) [4] [5]. The volume was integrated with the trapezoidal algorithm. One thousand points (10 x 10 x 10) were interpolated to calculate the average.
 - c. All neighboring volumes were evaluated until no neighboring volume with a higher average value was found.
4. The SAR reference value, at the same location as procedure #1, was remeasured. If the value changed by more than 5%, the evaluation is repeated.

2.8 Reference Points

2.8.1 Ear Reference Points

Figure 5.1 shows the front, back and side views of SAM. The point "M" is the reference point for the center of mouth, "LE" is the left ear reference point (ERP), and "RE" is the right ERP. The ERPs are 15 mm posterior to the entrance to ear canal (EEC) along the B-M line (Back-Mouth), as shown in Figure 5.2. The plane passing through the two ear reference points and M is defined as the Reference Plane. The line N-F (Neck-Front) perpendicular to the reference plane and passing through the RE (or LE) is called the Reference Pivoting Line (see Figure 5.3). Line B-M is perpendicular to the N-F line. Both N-F and B-M lines should be marked on the external phantom shell to facilitate handset positioning. Posterior to the N-F line, the thickness of the N-F line, the ear is truncated as illustrated in Figure 5.2. The ear truncation is introduced to avoid the handset from touching the ear lobe, which can cause unstable handset positioning at the cheek. [6]

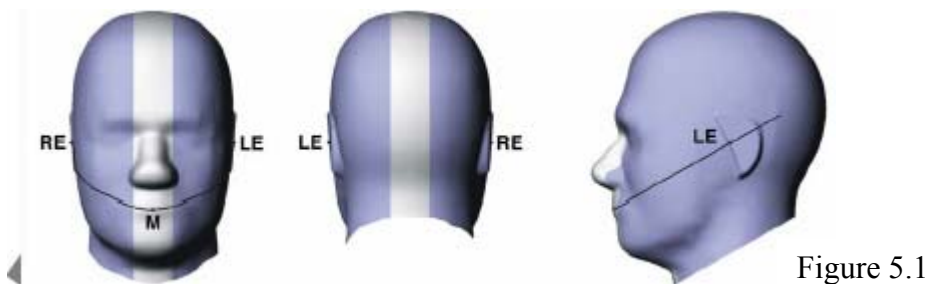

Figure 5.1

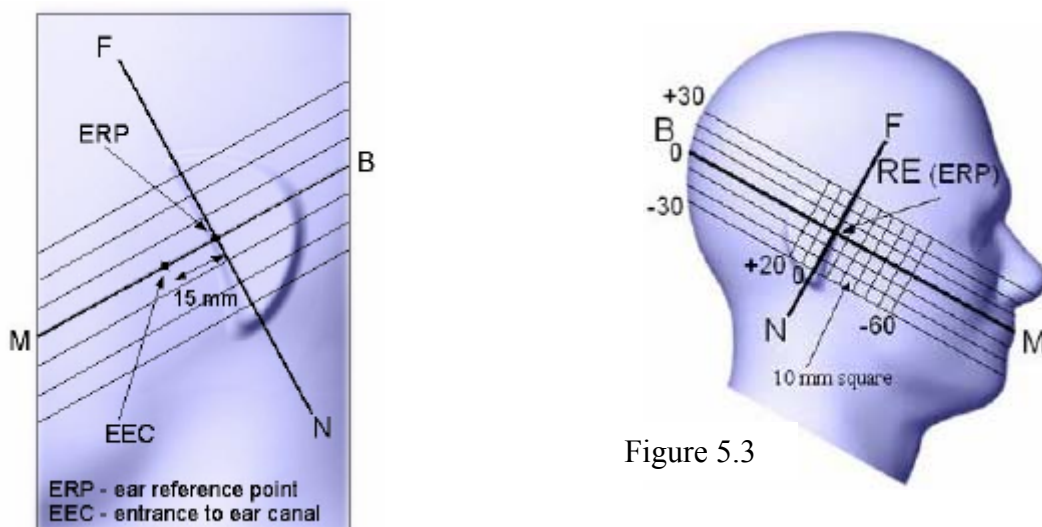

Figure 5.2

Figure 5.3

2.8.2 Handset Reference Points

Two imaginary lines on the handset were defined: the vertical centerline and the horizontal line. The vertical centerline passes through two points on the front side of the handset: the midpoint of the width w_t of the handset at the level of the acoustic output (point A on Figures 6.1 and 6.2), and the midpoint of the width w_b of the bottom of the handset (point B). The horizontal line is perpendicular to the vertical centerline and passes through the center of the acoustic output (see Figure 6.1). The two lines intersect at point A. For many handsets, point A coincides with the center of the acoustic output. However, the acoustic output may be located elsewhere on the horizontal line. The vertical centerline is not necessarily parallel to the front face of the handset (see Figure 6.2), especially for clamshell handsets, handsets with flip pieces, and other irregularly-shaped handsets. [6]

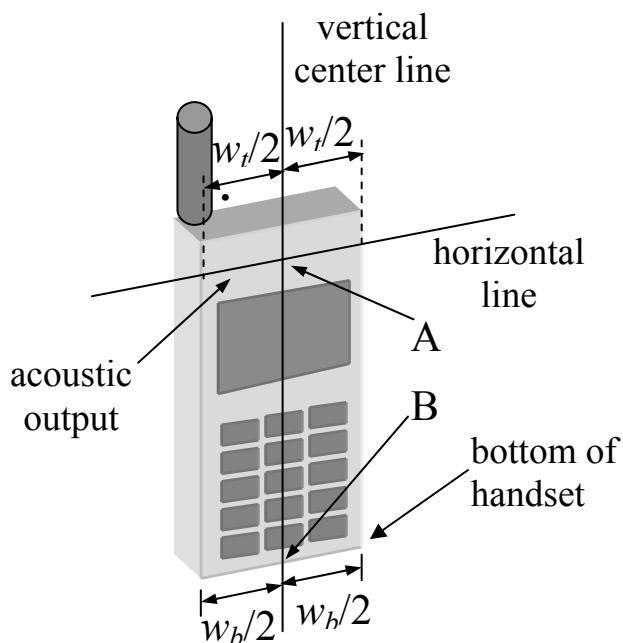

Figure 6.1

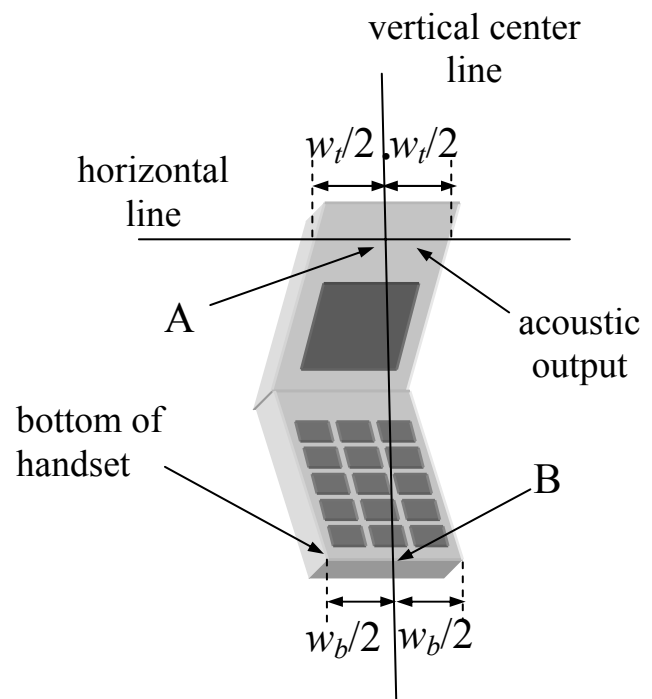

Figure 6.2

2.9 Test Positions

2.9.1 "Cheek" / "Touch" Position

The EUT was positioned close to the surface of the phantom such that point A is on the (virtual) extension of the line passing through points RE and LE on the phantom (see Figure 7), such that the plane defined by the vertical center line and the horizontal line of the handset is approximately parallel to the sagittal plane of the phantom.

The EUT was translated towards the phantom along the line passing through RE and LE until the handset touches the pinna.

While maintaining the handset in this plane, the EUT was rotated it around the LE-RE line until the vertical centerline was in the plane normal to MB-NF including the line MB (called the reference plane).

The EUT was rotated around the vertical centerline until the handset (horizontal line) was symmetrical with respect to the line NF.

While maintaining the vertical centerline in the reference plane, keeping point A on the line passing through RE and LE and maintaining the handset contact with the pinna, the EUT was rotated about the line NF until any point on the handset was in contact with a phantom point below the pinna (cheek). [6] See Figure 7.

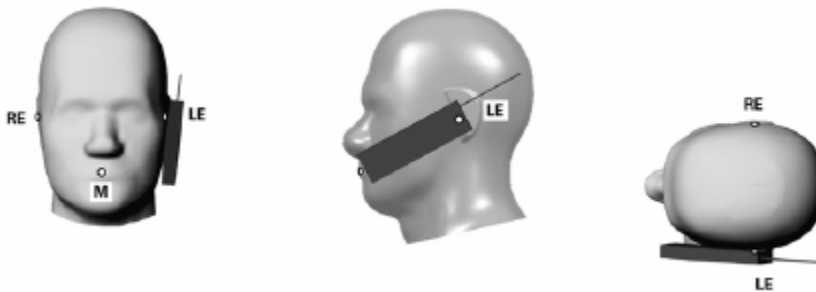

Figure 7

2.9.2 "Tilted" Position

The EUT was in "cheek position".

While maintaining the orientation of the handset move the handset away from the pinna along the line passing through RE and LE in order to enable a rotation of the handset by 15 degrees.

The EUT was rotated around the horizontal line by 15 degrees.

While maintaining the orientation of the handset, the EUT was moved towards the phantom on a line passing through RE and LE until any part of the handset touched the ear. The tilted position is obtained when the contact is on the pinna. If the contact was at any location other than the pinna (e.g., the antenna with the back of the phantom head), the angle of the handset would be reduced. In this case, the tilted position is obtained if any part of the handset was in contact with the pinna as well as a second part of the handset was in contact with the phantom (e.g., the antenna with the back of the head). [6] See Figure 8.

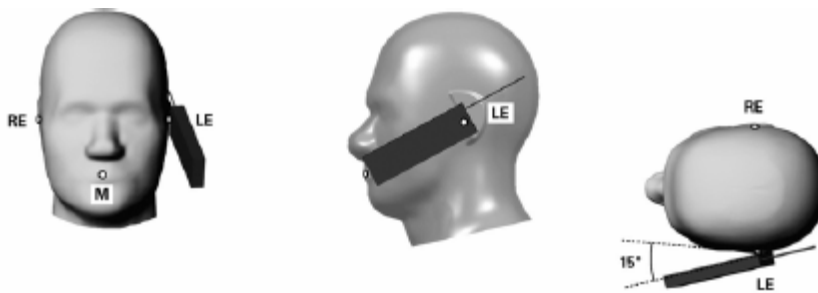

Figure 8

2.9.3 Belt Clip/Holster Configuration

Test configurations for body-worn operated EUTs are carried out while the belt-clip and/or holster is attached to the EUT and placed against a flat phantom in a regular configuration (see Figure 9). An EUT with a headset output is tested with a headset connected to the device.

Body dielectric parameters are used.

There are two categories for accessories for body-worn operation configurations:

1. accessories not containing metallic components
2. accessories containing metallic components.

When the EUT is equipped with accessories not containing metallic components the tests are done with the accessory that dictates the closest spacing to the body. For accessories containing metallic parts a test with each one is implemented. If the multiple accessories share an identical metallic component (e.g. the same metallic belt-clip used with different holsters with no other metallic components) only the accessory that has the closest spacing to the body is tested.

In case that a EUT authorized to be body-worn is not supplied or has no options to be operated with any accessories, a test configuration where a separation distance between the back of the device and the flat phantom is used. All test position spacings are documented.

Transmitters operating in front of a person's face (e.g. push-to-talk configurations) are tested for SAR compliance with the front of the device positioned to face the flat platform. SAR Compliance tests for shoulder, waist or chest-worn transmitters are carried out with the accessories including headsets and microphones attached to the device and placed against a flat phantom in a regular configuration.

The SAR measurements are performed to investigate the worst-case positioning. This is documented and used to perform Body SAR testing. [2].



Figure 9

2.9.4 Headset Configuration

Headsets which have their radiating structure in close proximity to the head are measured according to the following conditions.

- Head tissue liquid is used.
- The EUT is positioned on the surface of the head of phantom according the picture below. Right and left position is tested according to the normal use (see figure 10).
- Additional metallic parts like clips or others are subject of testing, too.



Figure 10

Headsets which have their radiating structure in close proximity to the body are tested as body worn equipment.

2.10 Measurement uncertainty

The uncertainty budget has been determined for the DASY4 system performance check according to IEEE Str. 1528-2003 December 2003.

| Error Description | Tol. (± %) | Prob. dist. | Div. | $(^c i)^1$ (1g) | Std. unc. (1g) (± %) | $(^v i)^2$ |
|--------------------------------------|---------------|----------------|------------|--------------------|-------------------------|------------|
| Measurement System | | | | | | |
| Probe Calibration | 4.8 | N | 1 | 1 | 4.8 | ∞ |
| Axial Isotropy | 4.7 | R | $\sqrt{3}$ | 0.7 | 1.9 | ∞ |
| Hemispherical Isotropy | 9.6 | R | $\sqrt{3}$ | 0.7 | 3.9 | ∞ |
| Boundary Effects | 1.0 | R | $\sqrt{3}$ | 1 | 0.6 | ∞ |
| Linearity | 4.7 | R | $\sqrt{3}$ | 1 | 2.7 | ∞ |
| System Detection Limit | 1.0 | R | $\sqrt{3}$ | 1 | 0.6 | ∞ |
| Readout Electronics | 1.0 | N | 1 | 1 | 1.0 | ∞ |
| Response Time | 0.8 | R | $\sqrt{3}$ | 1 | 0.5 | ∞ |
| Integration Time | 2.6 | R | $\sqrt{3}$ | 1 | 1.5 | ∞ |
| RF Ambient Conditions | 3.0 | R | $\sqrt{3}$ | 1 | 1.7 | ∞ |
| Probe Positioner | 0.4 | R | $\sqrt{3}$ | 1 | 0.2 | ∞ |
| Probe Positioning | 2.9 | R | $\sqrt{3}$ | 1 | 1.7 | ∞ |
| Algorithms for Max. SAR Eval. | 1.0 | R | $\sqrt{3}$ | 1 | 0.6 | ∞ |
| Test Sample Related | | | | | | |
| Device Positioning | 2.9 | N | 1 | 1 | 2.9 | 145 |
| Device Holder | 3.6 | N | 1 | 1 | 3.6 | 5 |
| Power Drift | 5.0 | R | $\sqrt{3}$ | 1 | 2.9 | ∞ |
| Phantom and Setup | | | | | | |
| Phantom Uncertainty | 4.0 | R | $\sqrt{3}$ | 1 | 2.3 | ∞ |
| Liquid Conductivity (target) | 5.0 | R. | $\sqrt{3}$ | 0.64 | 1.8 | ∞ |
| Liquid Conductivity (meas.) | 2.6 | N | 1 | 0.64 | 1.7 | ∞ |
| Liquid Permittivity (target) | 5.0 | R | $\sqrt{3}$ | 0.6 | 1.7 | ∞ |
| Liquid Permittivity (meas.) | 3.8 | N | 1 | 0.6 | 2.3 | ∞ |
| Combined Standard Uncertainty | | | | | 10.4 | 330 |
| Expanded Uncertainty kp=2 | | | | | | |
| Coverage Factor for 95% | | | | | 20.8 | |

The budget is valid for the frequency range 300MHz – 3 GHz and represent a worst case analysis. For specific tests and configurations, the uncertainty could be considerable smaller.

3. Tissue and System Verification

3.1 Tissue Verification

Dielectric parameters of the simulating liquids were verified using a Dielectric Probe Kit Agilent 85070D to a tolerance of $\pm 5\%$.

Room Temperature: 22,1 -22,6 °C

| | Measured Tissue Parameters | | | |
|---------------------------------|----------------------------|----------------------------|----------------|----------------------------|
| | 900 MHz Brain | | 1900 MHz Brain | |
| | Target | Measured 21.-22.02.2005 | Target | Measured 22.-23.02.2005 |
| Room Temperature: | | 22,1 ° C | | 22,1 ° C |
| Liquid Temperature: | | 22,1 ° C | | 22,1 ° C |
| Dielectric Constant: ϵ | 41.5 | 43.1 | 40.0 | 39.8 |
| Conductivity: σ | 0.97 | 0.972 | 1.40 | 1.42 |

Room Temperature: 22,1 -22,6 °C

| | Measured Tissue Parameters | | | |
|---------------------------------|----------------------------|------------------------|-----------------|------------------------|
| | 900 MHz Muscle | | 1900 MHz Muscle | |
| | Target | Measured 24.02.2005 | Target | Measured 23.02.2005 |
| Room Temperature: | | 22,1 ° C | | 22,1 ° C |
| Liquid Temperature: | | 22,1 ° C | | 22,1 ° C |
| Dielectric Constant: ϵ | 55.0 | 54.4 | 53.3 | 51.9 |
| Conductivity: σ | 1.05 | 1.04 | 1.52 | 1.58 |

3.2 System Verification

Prior to the assessment, the system was verified by using a 900 MHz /1900 MHz validation dipole. Power level of 250mW was supplied to the dipole antenna placed under the flat section of SAM Phantom. This system validation is valid for a frequency range of 900 ± 100 MHz.

The system was verified to a tolerance of ± 10 %.

Liquid Temperature: 22,0 -22,3 °C
Room Temperature: 22,1 -22,6 °C
Liquid Depth: >15.5 cm

| System Dipole Validation Target & Measurement | | | | | |
|---|------------------------|---------------|------------------------|------------------------|---------------|
| Date | System Validation Kit: | Liquid | Targeted SAR 1g (mW/g) | Measured SAR 1g (mW/g) | Deviation (%) |
| 21.02.2005 | D900V2 SN164 | 900 MHz Head | 10.2 | 11.08 | th,tt1.00 |
| 22.02.2005 | D900V2 SN164 | 900 MHz Head | 10.2 | 11.12 | 9.02 |
| 22.02.2005 | D1900V2 SN5d025 | 1900 MHz Head | 40.4 | 43.20 | 6.93 |
| 23.02.2005 | D1900V2 SN5d025 | 1900 MHz Head | 40.4 | 43.20 | 6.93 |

Liquid Temperature: 22,0 -22,3 °C
Room Temperature: 22,1 -22,6 °C
Liquid Depth: >15.5 cm

| System Dipole Validation Target & Measurement | | | | | |
|---|------------------------|-----------------|------------------------|------------------------|---------------|
| Date | System Validation Kit: | Liquid | Targeted SAR 1g (mW/g) | Measured SAR 1g (mW/g) | Deviation (%) |
| 24.02.2005 | D900V2 SN164 | 900 MHz Muscle | 10.2 | 11.12 | 9.02 |
| 23.02.2005 | D1900V2 SN5d025 | 1900 MHz Muscle | 40.4 | 43.60 | 7.92 |

Comment: Please find attached the measurement plots.

4. Test Results

Procedures Used To Establish Test Signal

The EUT was placed into simulated call mode (e.g. AMPS, Cellular CDMA & PCS CDMA modes) using manufacturers test codes. Such test signals offer a consistent means for testing SAR and are recommended for evaluating SAR [2]. The actual transmission is activated through a base station simulator or similar when test modes are not available or inappropriate for testing the EUT.

The EUT is rechargeable battery operated. The battery used for the SAR measurements was completely charged. The device was tested at full power verified by implementing conducted output power measurements. For confirming of the output power it was tested before and after each SAR measurement. The test was repeated if a conducted power deviation of more than 5 % occurred.

Mixture Type: 900 MHz Head

Date: 21.- 22.2.2005

Liquid Temperature: 22,0 -22,3 °C

Room Temperature: 22,1 -22,6 °C

| Frequency | | | Power Drift dBm | Antenna Pos. | Phantom Section | Test Position | SAR (W/kg) |
|-----------|---------|------------|--------------------|---------------|--------------------|------------------|---------------|
| MHz | Channel | Modulation | | | | | |
| 824,2 | 128 | GSM | -0.0 | Integral ant1 | Right Ear | Cheek | 1.15 |
| 824,2 | 128 | GSM | 0.1 | Integral ant1 | Right Ear | Tilt | 0.314 |
| 836,4 | 189 | GSM | -0.1 | Integral ant1 | Right Ear | Cheek | 1.17 |
| 836,4 | 189 | GSM | -0.0 | Integral ant1 | Right Ear | Tilt | 0.332 |
| 848,8 | 251 | GSM | -0.1 | Integral ant1 | Right Ear | Cheek | 1.04 |
| 848,8 | 251 | GSM | -0.1 | Integral ant1 | Right Ear | Tilt | 0.230 |
| 824,2 | 128 | GSM | 0.008 | Integral ant1 | Left Ear | Cheek | 1.04 |
| 824,2 | 128 | GSM | 0.1 | Integral ant1 | Left Ear | Tilt | 0.291 |
| 836,4 | 189 | GSM | 0.1 | Integral ant1 | Left Ear | Cheek | 1.1 |
| 836,4 | 189 | GSM | 0.0 | Integral ant1 | Left Ear | Tilt | 0.327 |
| 848,8 | 251 | GSM | 0.1 | Integral ant1 | Left Ear | Cheek | 1.19 |
| 848,8 | 251 | GSM | -0.1 | Integral ant1 | Left Ear | Tilt | 0.296 |

Mixture Type: 900 MHz Muscle

Date: 24.02.2005

Liquid Temperature: 22,0 -22,3 ° C

Room Temperature: 22,1 -22,6 ° C

| Frequency | | | Power Drift dBm | Antenna Pos. | Phantom Section | Test Position -15 mm | SAR (W/kg) |
|-----------|---------|------------|--------------------|--------------|--------------------|----------------------------|---------------|
| MHz | Channel | Modulation | | | | | |
| 824,2 | 128 | GSM | | Integral | Flat | Front | |
| 824,2 | 128 | GSM | | Integral | Flat | Back | |
| 836,4 | 189 | GSM | -0.0 | Integral | Flat | Front | 0.125 |
| 836,4 | 189 | GSM | -0.0 | Integral | Flat | Back | 0.188 |
| 848,8 | 251 | GSM | | Integral | Flat | Front | |
| 848,8 | 251 | GSM | | Integral | Flat | Back | |

Note: Device positioning: spacing from flat phantom was adjusted at 1.5 cm.

Limits:

| Exposure Limits | SAR (W/kg) | |
|---|---|---|
| | Uncontrolled Exposure/General Population Environment | Controlled Exposure/Occupational Environment |
| Spatial Average SAR (averaged over the whole body) | 0.08 | 0.40 |
| Spatial Peak SAR (averaged over any 1g of tissue) | 1.60 | 8.00 |
| Spatial Peak SAR (Hands, Feet, Ankles, Wrist) (averaged over any 10g of tissue) | 4.00 | 20.00 |

Notes:

1. Test data represent the worst case SAR value and test procedure used are according to OET Bulletin 65, Supplement C (01-01).
2. All modes of operation were investigated.

Mixture Type: 1900 MHz Head

Date: 22. - 23.2.2005

Liquid Temperature: 22,0 -22,3 °C

Room Temperature: 22,1 -22,6 °C

| Frequency | | | Power Drift dBm | Antenna Pos. | Phantom Section | Test Position | SAR (W/kg) |
|-----------|---------|------------|--------------------|---------------|--------------------|------------------|---------------|
| MHz | Channel | Modulation | | | | | |
| 1850,2 | 512 | GSM | -0.1 | Integral ant1 | Right Ear | Cheek | 0.674 |
| 1850,2 | 512 | GSM | 0.1 | Integral ant1 | Right Ear | Tilt | 0.128 |
| 1880,0 | 661 | GSM | 0.1 | Integral ant1 | Right Ear | Cheek | 0.922 |
| 1880,0 | 661 | GSM | -0.1 | Integral ant1 | Right Ear | Tilt | 0.159 |
| 1909,8 | 810 | GSM | -0.0 | Integral ant1 | Right Ear | Cheek | 1.15 |
| 1909,8 | 810 | GSM | 0.1 | Integral ant1 | Right Ear | Tilt | 0.239 |
| 1850,2 | 512 | GSM | -0.0 | Integral ant1 | Left Ear | Cheek | 0.511 |
| 1850,2 | 512 | GSM | 0.1 | Integral ant1 | Left Ear | Tilt | 0.116 |
| 1880,0 | 661 | GSM | 0.0 | Integral ant1 | Left Ear | Cheek | 0.702 |
| 1880,0 | 661 | GSM | 0.1 | Integral ant1 | Left Ear | Tilt | 0.154 |
| 1909,8 | 810 | GSM | -0.1 | Integral ant1 | Left Ear | Cheek | 0.944 |
| 1909,8 | 810 | GSM | -0.0 | Integral ant1 | Left Ear | Tilt | 0.247 |

Mixture Type: 1900 MHz Muscle

Date: 23.02.2005

Liquid Temperature: 22,0 -22,3 °C

Room Temperature: 22,1 -22,6 °C

| Frequency | | | Power Drift dBm | Antenna Pos. | Phantom Section | Test Position | SAR (W/kg) |
|-----------|---------|------------|--------------------|--------------|--------------------|------------------|---------------|
| MHz | Channel | Modulation | | | | | |
| 1850,2 | 512 | GSM | | Integral | Flat | Front | |
| 1850,2 | 512 | GSM | | Integral | Flat | Back | |
| 1880,0 | 661 | GSM | 0.1 | Integral | Flat | Front | 0.115 |
| 1880,0 | 661 | GSM | 0.1 | Integral | Flat | Back | 0.225 |
| 1909,8 | 810 | GSM | | Integral | Flat | Front | |
| 1909,8 | 810 | GSM | | Integral | Flat | Back | |

Limits:

| Exposure Limits | SAR (W/kg) | |
|---|--|--|
| | Uncontrolled Exposure/General Population Environment | Controlled Exposure/Occupational Environment |
| Spatial Average SAR (averaged over the whole body) | 0.08 | 0.40 |
| Spatial Peak SAR (averaged over any 1g of tissue) | 1.60 | 8.00 |
| Spatial Peak SAR (Hands, Feet, Ankles, Wrist) (averaged over any 10g of tissue) | 4.00 | 20.00 |

Notes:

3. Test data represent the worst case SAR value and test procedure used are according to OET Bulletin 65, Supplement C (01-01).
4. All modes of operation were investigated.

5. References

- [1] ANSI/IEEE C95.3 – 1991, *IEEE Recommended Practice for the Measurement of Potentially Hazardous Electromagnetic fields, 300 kHz to 100 GHz*, New York: IEEE, Aug. 1992
- [2] Federal Communications Commission, OET Bulletin 65 (Edition 97-01), Supplement C (Edition 01-01), *Evaluating Compliance with FCC Guidelines for Human Exposure to Radiofrequency Electromagnetic Fields*, July 2001.
- [3] T. Schmid, O. Egger, N. Kuster, *Automated E-field scanning system for dosimetric assessments*, IEEE Transaction on Microwave Theory and Techniques, vol. 44, Jan. 1996, pp. 105-113.
- [4] W. Gander, *Computermathematics*, Birkhaeuser, Basel, 1992.
- [5] W.H. Press, S.A. Teukolsky, W.T. Vetterling, and B.P. Flannery, *Numerical Recipes in C, The Art of Scientific Computing*, Second edition, Cambridge University Press, 1992.
- [6] IEEE Standards Coordinating Committee 34 – IEEE Std. 1528-2003, December 2003 *Draft Recommended Practice for Determining the Peak Spatial-Average Absorption Rate (SAR in the Human Body Due to Wireless Communications Devices: Experimental Techniques*.
- [7] DASY4 *Dosimetric Assessment System Manual*; Draft; September 6, 2002; Schmid & Partner Engineering AG

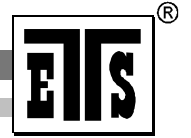

6. Appendix

1. Appendix A Calibration Certificate D900V2 SN164
D1900V2 SN5d025
ET3DV6 SN1711
DAE3V1-522
2. Appendix B Measurement Plots
3. Appendix C Pictures



Appendix A

Calibration Certificate

Schmid & Partner Engineering AG

Zeughausstrasse 43, 8004 Zurich, Switzerland, Phone +41 1 245 97 00, Fax +41 1 245 97 79

Calibration Certificate

900 MHz System Validation Dipole

Type:

D900V2

Serial Number:

164

Place of Calibration:

Zurich

Date of Calibration:

September 5, 2002

Calibration Interval:

24 months

Schmid & Partner Engineering AG hereby certifies, that this device has been calibrated on the date indicated above. The calibration was performed in accordance with specifications and procedures of Schmid & Partner Engineering AG.

Wherever applicable, the standards used in the calibration process are traceable to international standards. In all other cases the standards of the Laboratory for EMF and Microwave Electronics at the Swiss Federal Institute of Technology (ETH) in Zurich, Switzerland have been applied.

Calibrated by:

N. Vetter

Approved by:

Alain Klatz

**Schmid & Partner
Engineering AG**

Zeughausstrasse 43, 8004 Zurich, Switzerland, Phone +41 1 245 97 00, Fax +41 1 245 97 79

DASY

Dipole Validation Kit

Type: D900V2

Serial: 164

Manufactured: April 30, 2002

Calibrated: September 5, 2002

1. Measurement Conditions

The measurements were performed in the flat section of the new SAM twin phantom filled with head simulating solution of the following electrical parameters at 900 MHz:

| | | |
|------------------------|-------------------|-----------|
| Relative Dielectricity | 40.6 | $\pm 5\%$ |
| Conductivity | 0.95 mho/m | $\pm 5\%$ |

The DASY System with a dosimetric E-field probe ET3DV6 (SN:1507, Conversion factor 6.5 at 900 MHz) was used for the measurements.

The dipole was mounted on the small tripod so that the dipole feedpoint was positioned below the center marking of the flat phantom section and the dipole was oriented parallel to the body axis (the long side of the phantom). The standard measuring distance was 15mm from dipole center to the solution surface. The included distance holder was used during measurements for accurate distance positioning.

The coarse grid with a grid spacing of 20mm was aligned with the dipole. The 5x5x7 fine cube was chosen for cube integration. Probe isotropy errors were cancelled by measuring the SAR with normal and 90° turned probe orientations and averaging.

The dipole input power (forward power) was 250mW $\pm 3\%$. The results are normalized to 1W input power.

2 SAR Measurement with DASY4 System

Standard SAR-measurements were performed according to the measurement conditions described in section 1. The results (see figure supplied) have been normalized to a dipole input power of 1W (forward power). The resulting averaged SAR-values measured with the dosimetric probe ET3DV6 SN:1507 and applying the advanced extrapolation are:

| | |
|--|------------------|
| averaged over 1 cm ³ (1 g) of tissue: | 10.2 mW/g |
| averaged over 10 cm ³ (10 g) of tissue: | 6.56 mW/g |

3. Dipole Impedance and Return Loss

The impedance was measured at the SMA-connector with a network analyzer and numerically transformed to the dipole feedpoint. The transformation parameters from the SMA-connector to the dipole feedpoint are:

Electrical delay: **1.408 ns** (one direction)
Transmission factor: **0.990** (voltage transmission, one direction)

The dipole was positioned at the flat phantom sections according to section 1 and the distance holder was in place during impedance measurements.

Feedpoint impedance at 900 MHz: $\text{Re}\{Z\} = 50.7 \Omega$

$\text{Im}\{Z\} = -5.2 \Omega$

Return Loss at 900 MHz **-25.7 dB**

4. Handling

Do not apply excessive force to the dipole arms, because they might bend. Bending of the dipole arms stresses the soldered connections near the feedpoint leading to a damage of the dipole.

5. Design

The dipole is made of standard semirigid coaxial cable. The center conductor of the feeding line is directly connected to the second arm of the dipole. The antenna is therefore short-circuited for DC-signals.

6. Power Test

After long term use with 100W radiated power, only a slight warming of the dipole near the feedpoint can be measured.

Validation Dipole D900V2 SN:164, d=15 mm

Frequency: 900 MHz; Antenna Input Power: 250 [mW]

SAM Phantom; Flat Section; Grid Spacing: Dx = 20.0, Dy = 20.0, Dz = 10.0

Probe: ET3DV6 - SN1507; ConvF(6.50,6.50,6.50) at 900 MHz; IEEE 1528 900 MHz: $\sigma = 0.95$ mho/m $\epsilon_r = 40.6$ $\rho = 1.00$ g/cm³

Cubes (2): Peak: 3.80 mW/g ± 0.03 dB, SAR (1g): 2.54 mW/g ± 0.03 dB, SAR (10g): 1.64 mW/g ± 0.02 dB, (Advanced extrapolation)

Penetration depth: 12.5 (12.3, 13.0) [mm]

Powerdrift: -0.01 dB

SAR_{tot} [mW/g]

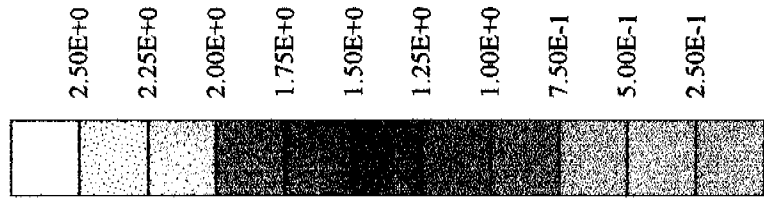

Validation Dipole D900V2 SN:164, d=15 mm

Frequency: 900 MHz; Antenna Input Power: 250 [mW]

SAM Phantom; Flat Section; Grid Spacing: Dx = 20.0, Dy = 20.0, Dz = 10.0

Probe: ET3DV6 - SN1507; ConvF(6.50,6.50,6.50) at 900 MHz; IEEE 1528 900 MHz: $\sigma = 0.95$ mho/m $\epsilon_r = 40.6$ $\rho = 1.00$ g/cm³

Cubes (2): Peak: 4.29 mW/g ± 0.03 dB, SAR (1g): 2.71 mW/g ± 0.03 dB, SAR (10g): 1.72 mW/g ± 0.02 dB, (Worst-case extrapolation)

Penetration depth: 11.6 (10.7, 12.8) [mm]

Powerdrift: -0.01 dB

SAR_{Tot} [mW/g]

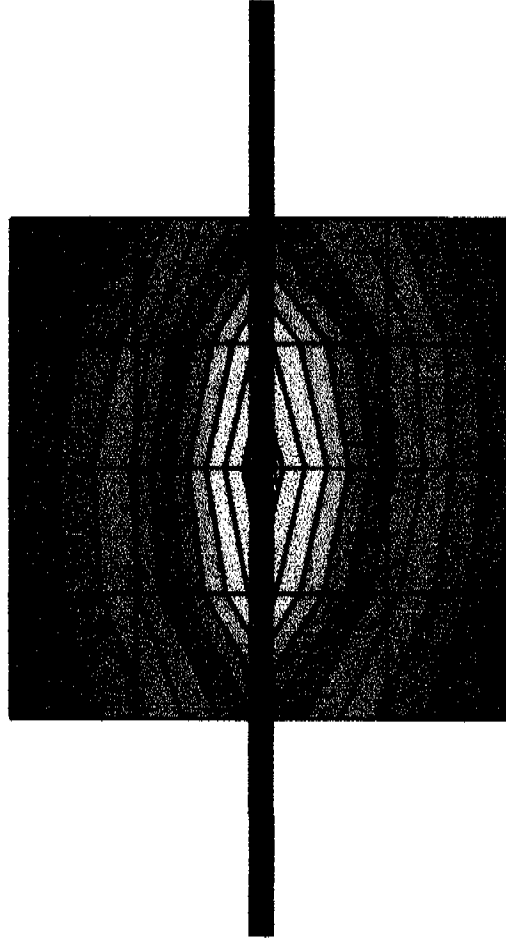
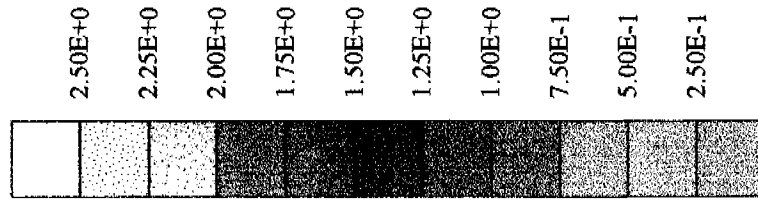

4 Sep 2002 10:05:41

CH1 S11 1 U FS 1: 50.693 Ω -5.2207 Ω 33.873 pF 900.000 000 MHz

De1

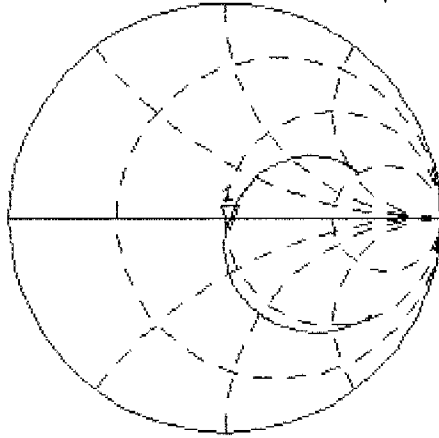

PRm

Cor
Avg
16

↑

CH2 S11 LOG 5 dB/REF 0 dB 1:-25.680 dB 900.000 000 MHz

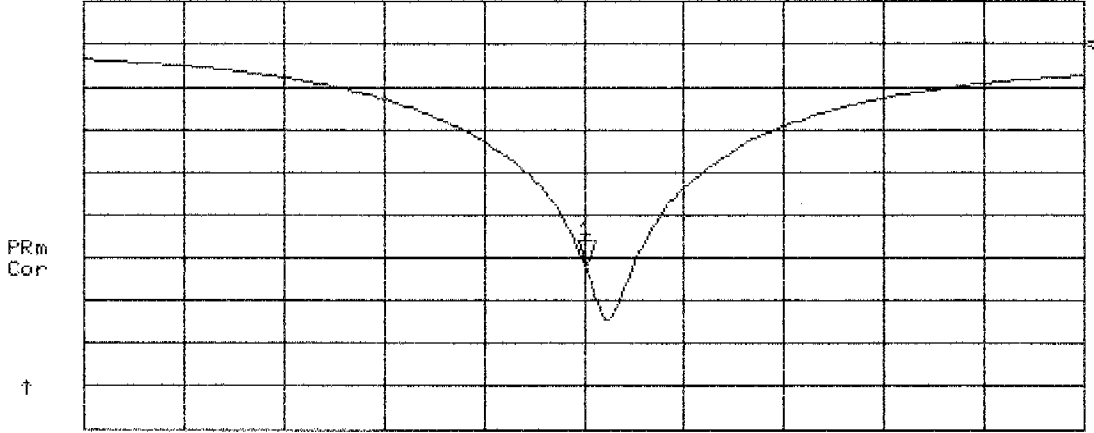

PRm
Cor

↑

START 700.000 000 MHz

STOP 1100.000 000 MHz

Schmid & Partner Engineering AG

Zeughausstrasse 43, 8004 Zurich, Switzerland, Phone +41 1 245 97 00, Fax +41 1 245 97 79

Calibration Certificate

1900 MHz System Validation Dipole

Type:

D1900V2

Serial Number:

5d025

Place of Calibration:

Zurich

Date of Calibration:

October 14, 2002

Calibration Interval:

24 months

Schmid & Partner Engineering AG hereby certifies, that this device has been calibrated on the date indicated above. The calibration was performed in accordance with specifications and procedures of Schmid & Partner Engineering AG.

Wherever applicable, the standards used in the calibration process are traceable to international standards. In all other cases the standards of the Laboratory for EMF and Microwave Electronics at the Swiss Federal Institute of Technology (ETH) in Zurich, Switzerland have been applied.

Calibrated by:

D. Vella

Approved by:

Blair Kofe

DASY

Dipole Validation Kit

Type: D1900V2

Serial: 5d025

Manufactured: July 29, 2002

Calibrated: October 14, 2002

1. Measurement Conditions

The measurements were performed in the flat section of the new SAM twin phantom filled with head simulating glycol solution of the following electrical parameters at 1900 MHz:

| | | |
|------------------------|-------------------|-----------|
| Relative Dielectricity | 38.7 | $\pm 5\%$ |
| Conductivity | 1.45 mho/m | $\pm 5\%$ |

The DASY4 System with a dosimetric E-field probe ET3DV6 (SN:1507, Conversion factor 5.2 at 1900 MHz) was used for the measurements.

The dipole was mounted on the small tripod so that the dipole feedpoint was positioned below the center marking of the flat phantom section and the dipole was oriented parallel to the body axis (the long side of the phantom). The standard measuring distance was 10mm from dipole center to the solution surface. The included distance holder was used during measurements for accurate distance positioning.

The coarse grid with a grid spacing of 15mm was aligned with the dipole. The 7x7x7 fine cube was chosen for cube integration.

The dipole input power (forward power) was $250\text{mW} \pm 3\%$. The results are normalized to 1W input power.

2 SAR Measurement with DASY4 System

Standard SAR-measurements were performed according to the measurement conditions described in section 1. The results (see figure supplied) have been normalized to a dipole input power of 1W (forward power). The resulting averaged SAR-values measured with the dosimetric probe ET3DV6 SN:1507 and applying the advanced extrapolation are:

| | |
|--|------------------|
| averaged over 1 cm^3 (1 g) of tissue: | 40.4 mW/g |
| averaged over 10 cm^3 (10 g) of tissue: | 20.6 mW/g |

3. Dipole Impedance and Return Loss

The impedance was measured at the SMA-connector with a network analyzer and numerically transformed to the dipole feedpoint. The transformation parameters from the SMA-connector to the dipole feedpoint are:

Electrical delay: **1.196 ns** (one direction)
Transmission factor: **0.997** (voltage transmission, one direction)

The dipole was positioned at the flat phantom sections according to section 1 and the distance holder was in place during impedance measurements.

Feedpoint impedance at 1900 MHz: $\text{Re}\{Z\} = 51.6 \Omega$

$\text{Im}\{Z\} = 4.7 \Omega$

Return Loss at 1900 MHz **-26.3 dB**

4. Handling

Do not apply excessive force to the dipole arms, because they might bend. Bending of the dipole arms stresses the soldered connections near the feedpoint leading to a damage of the dipole.

5. Design

The dipole is made of standard semirigid coaxial cable. The center conductor of the feeding line is directly connected to the second arm of the dipole. The antenna is therefore short-circuited for DC-signals.

6. Power Test

After long term use with 40W radiated power, only a slight warming of the dipole near the feedpoint can be measured.

Test Laboratory: SPEAG, Zurich, Switzerland
File Name: SN5d025_SN1507_HSL1900_141002.da4

DUT: Dipole 1900 MHz Type & Serial Number: D1900V2 - SN5d025
Program: Dipole Calibration; Pin = 250 mW; d = 10 mm

Communication System: CW-1900; Frequency: 1900 MHz; Duty Cycle: 1:1
Medium: HSL 1900 MHz ($\sigma = 1.45$ mho/m, $\epsilon = 38.7$, $\rho = 1000$ kg/m³)
Phantom section: FlatSection

DASY4 Configuration:

- Probe: ET3DV6 - SN1507; ConvF(5.2, 5.2, 5.2); Calibrated: 1/24/2002
- Sensor-Surface: 4mm (Mechanical Surface Detection)
- Electronics: DAE3 - SN410; Calibrated: 7/18/2002
- Phantom: SAM 4.0 - TP:1006
- Software: DASY4, V4.0 Build 35

Area Scan (81x81x1): Measurement grid: dx=15mm, dy=15mm
Zoom Scan (7x7x7)/Cube 0: Measurement grid: dx=5mm, dy=5mm
Reference Value = 93 V/m
Peak SAR = 18.3 mW/g
SAR(1 g) = 10.1 mW/g; SAR(10 g) = 5.16 mW/g
Power Drift = -0.0005 dB

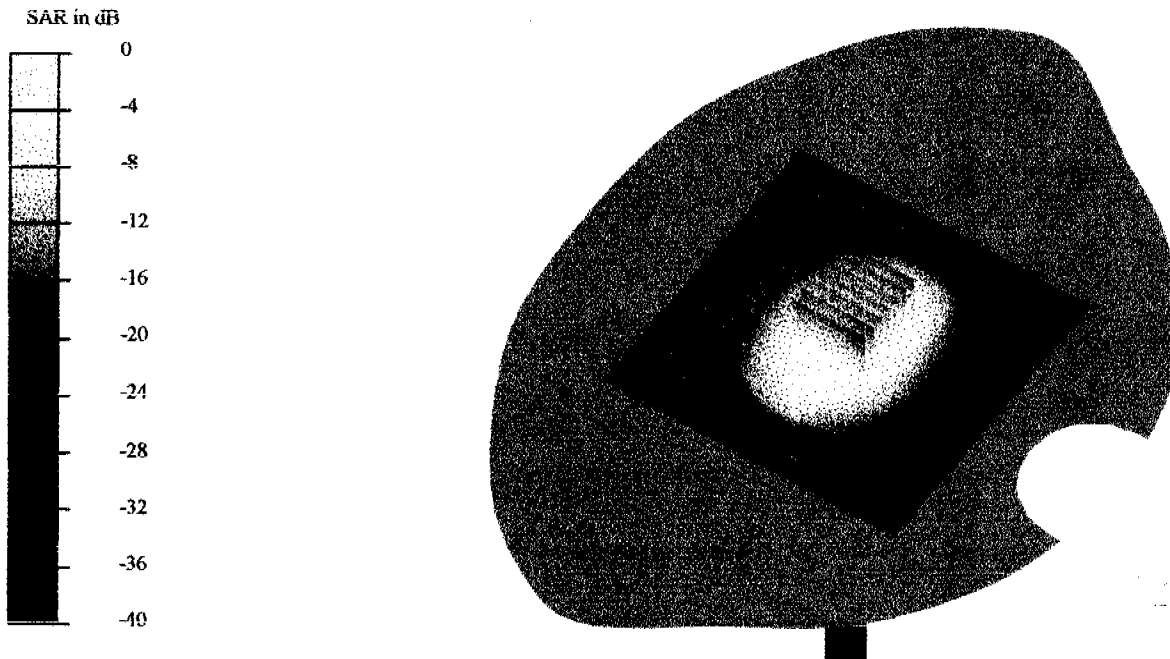

CH1 S11 1 U F9 1: 51.551 Ω 4.6641 Ω 390.69 μ H 1 900.000 000 MHz

γ

Del

PRm

Cor
Avg
16

↑

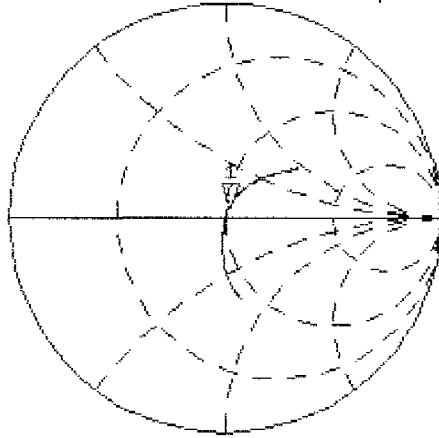

CH2 S11 LOG 5 dB/REF 0 dB 1:-26.320 dB 1 900.000 000 MHz

PRm
Cor

↑

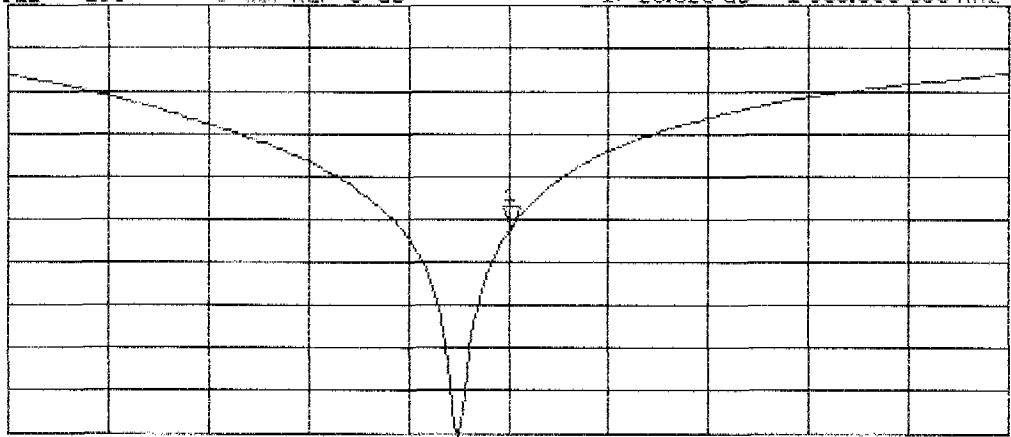

START 1 700.000 000 MHz

STOP 2 100.000 000 MHz

Probe ET3DV6

SN:1711

| | |
|-------------------|-------------------|
| Manufactured: | August 7, 2002 |
| Last calibration: | November 26, 2002 |
| Recalibrated: | December 16, 2003 |

Calibrated for DASY Systems

(Note: non-compatible with DASY2 system!)

DASY - Parameters of Probe: ET3DV6 SN:1711

Sensitivity in Free Space

| | |
|-------|---|
| NormX | 1.41 $\mu\text{V}/(\text{V}/\text{m})^2$ |
| NormY | 1.62 $\mu\text{V}/(\text{V}/\text{m})^2$ |
| NormZ | 1.56 $\mu\text{V}/(\text{V}/\text{m})^2$ |

Diode Compression

| | | |
|-------|-----------|----|
| DCP X | 97 | mV |
| DCP Y | 97 | mV |
| DCP Z | 97 | mV |

Sensitivity in Tissue Simulating Liquid

Head 900 MHz $\epsilon_r = 41.5 \pm 5\%$ $\sigma = 0.97 \pm 5\%$ mho/m

Valid for f=800-1000 MHz with Head Tissue Simulating Liquid according to EN 50361, P1528-200X

| | | |
|---------|------------------------------|-------------------|
| ConvF X | 6.2 $\pm 9.5\%$ (k=2) | Boundary effect: |
| ConvF Y | 6.2 $\pm 9.5\%$ (k=2) | Alpha 0.31 |
| ConvF Z | 6.2 $\pm 9.5\%$ (k=2) | Depth 2.87 |

Head 1800 MHz $\epsilon_r = 40.0 \pm 5\%$ $\sigma = 1.40 \pm 5\%$ mho/m

Valid for f=1710-1910 MHz with Head Tissue Simulating Liquid according to EN 50361, P1528-200X

| | | |
|---------|------------------------------|-------------------|
| ConvF X | 5.2 $\pm 9.5\%$ (k=2) | Boundary effect: |
| ConvF Y | 5.2 $\pm 9.5\%$ (k=2) | Alpha 0.50 |
| ConvF Z | 5.2 $\pm 9.5\%$ (k=2) | Depth 2.62 |

Boundary Effect

Head 900 MHz Typical SAR gradient: 5 % per mm

| | | | |
|-----------------------|------------------------------|-------------|-------------|
| Probe Tip to Boundary | | 1 mm | 2 mm |
| SAR _{be} [%] | Without Correction Algorithm | 9.9 | 5.8 |
| SAR _{be} [%] | With Correction Algorithm | 0.4 | 0.6 |

Head 1800 MHz Typical SAR gradient: 10 % per mm

| | | | |
|-----------------------|------------------------------|-------------|-------------|
| Probe Tip to Boundary | | 1 mm | 2 mm |
| SAR _{be} [%] | Without Correction Algorithm | 13.6 | 9.2 |
| SAR _{be} [%] | With Correction Algorithm | 0.2 | 0.1 |

Sensor Offset

| | | |
|----------------------------|---------------------------------|----|
| Probe Tip to Sensor Center | 2.7 | mm |
| Optical Surface Detection | 1.1 \pm 0.2 | mm |

Receiving Pattern (ϕ), $\theta = 0^\circ$

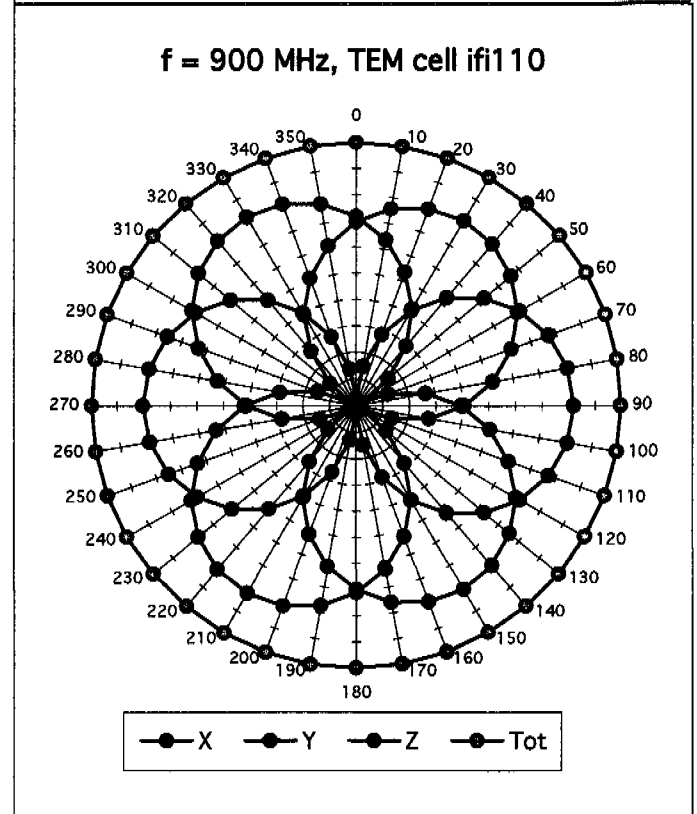
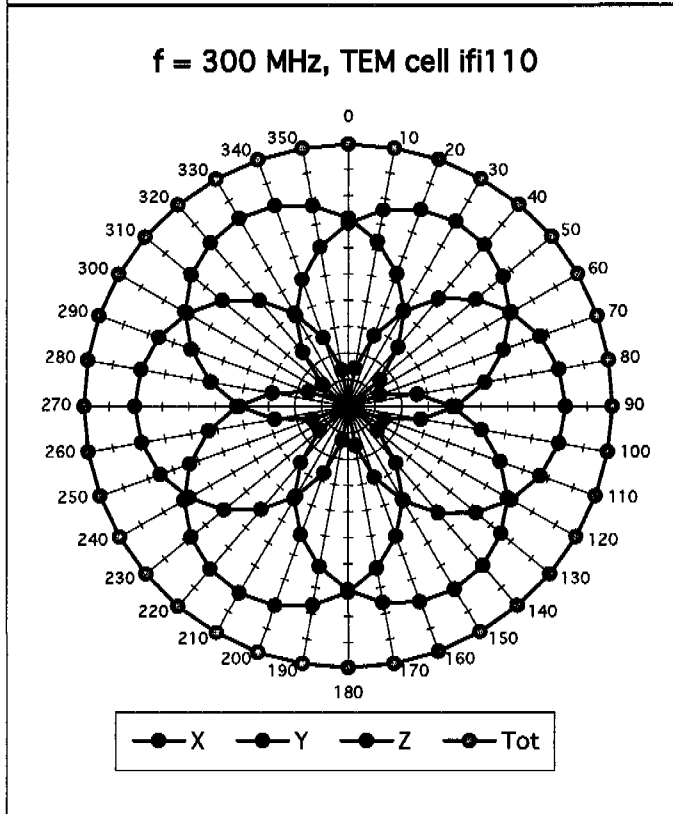
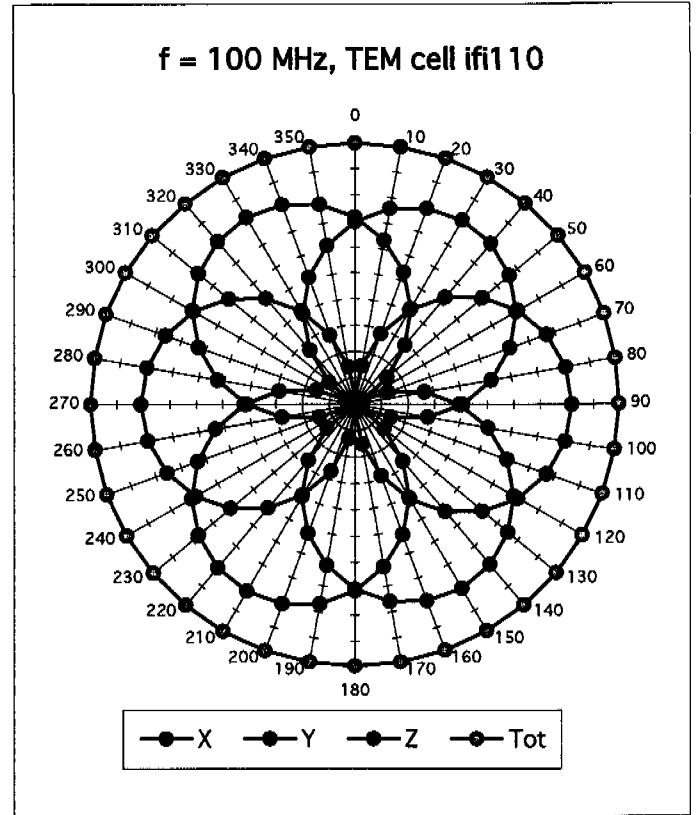
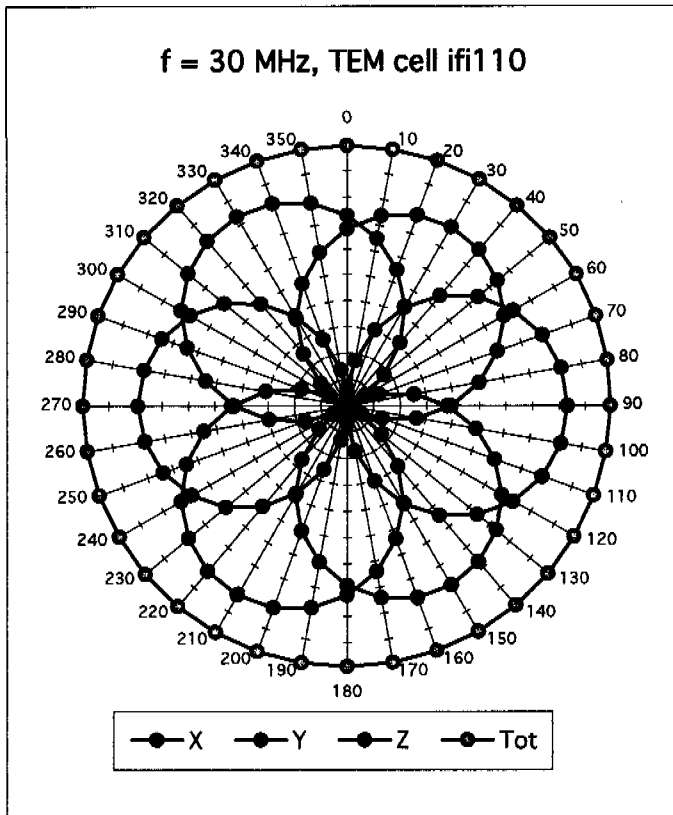

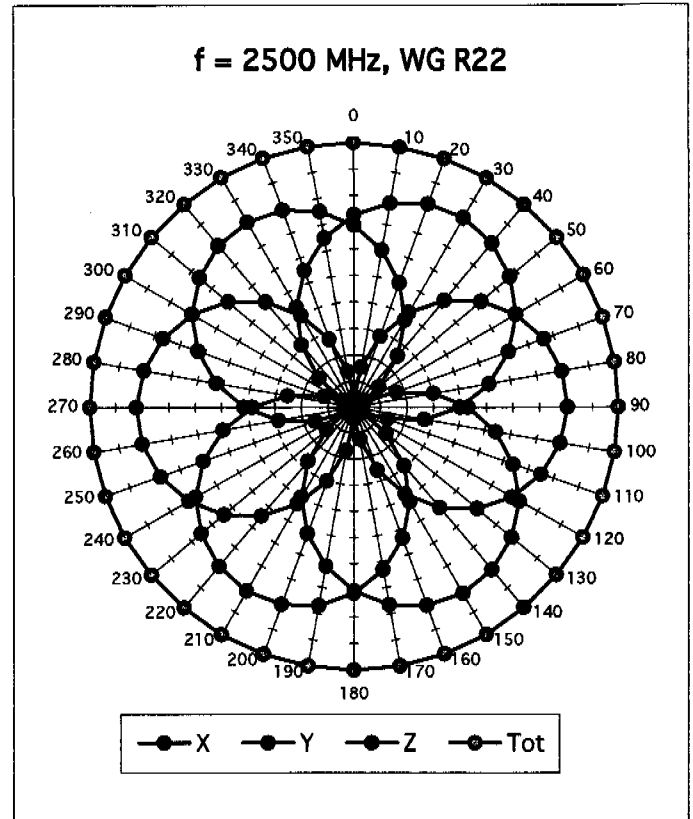
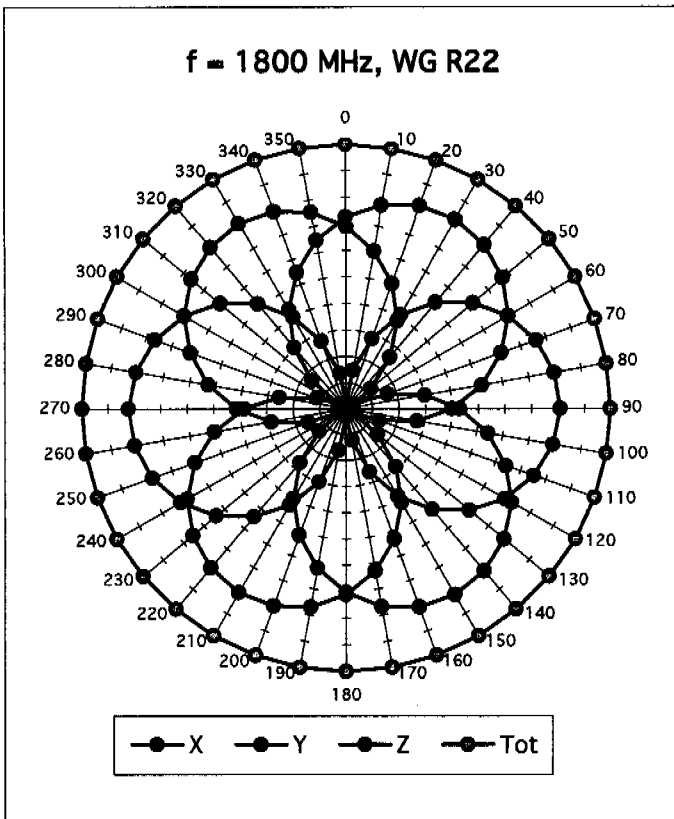

Isotropy Error (ϕ), $\theta = 0^\circ$

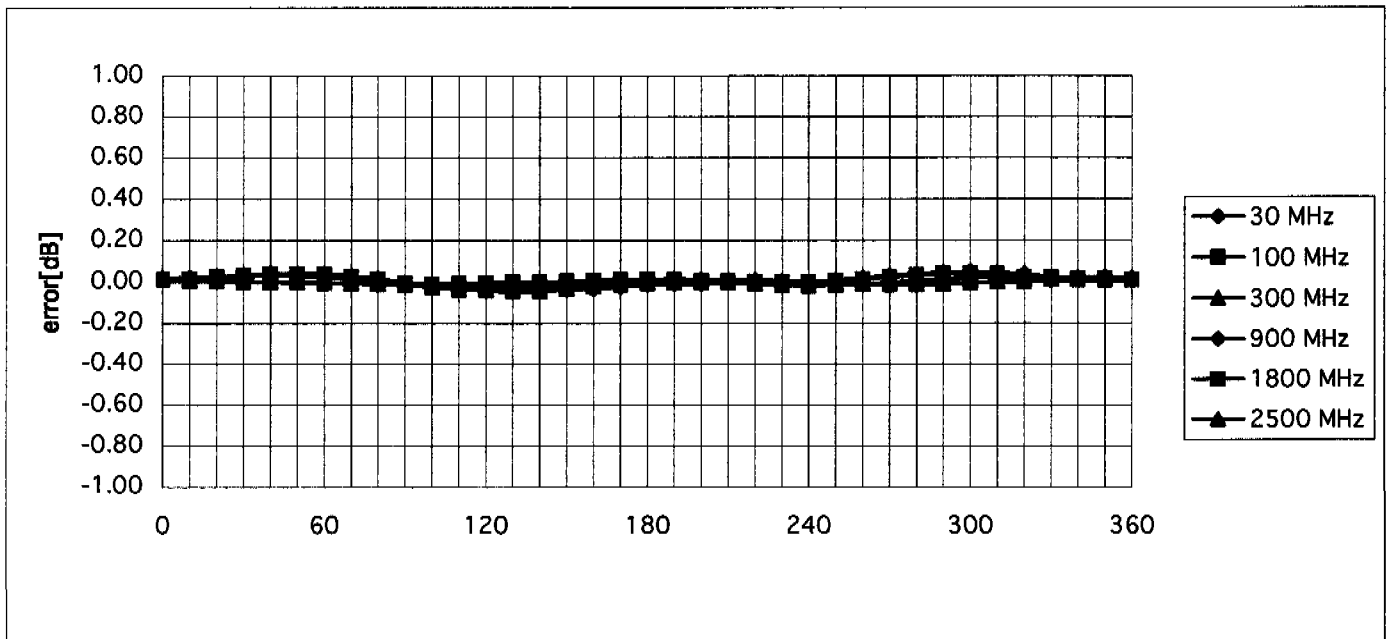

Frequency Response of E-Field

(TEM-Cell:ifi110, Waveguide R22)

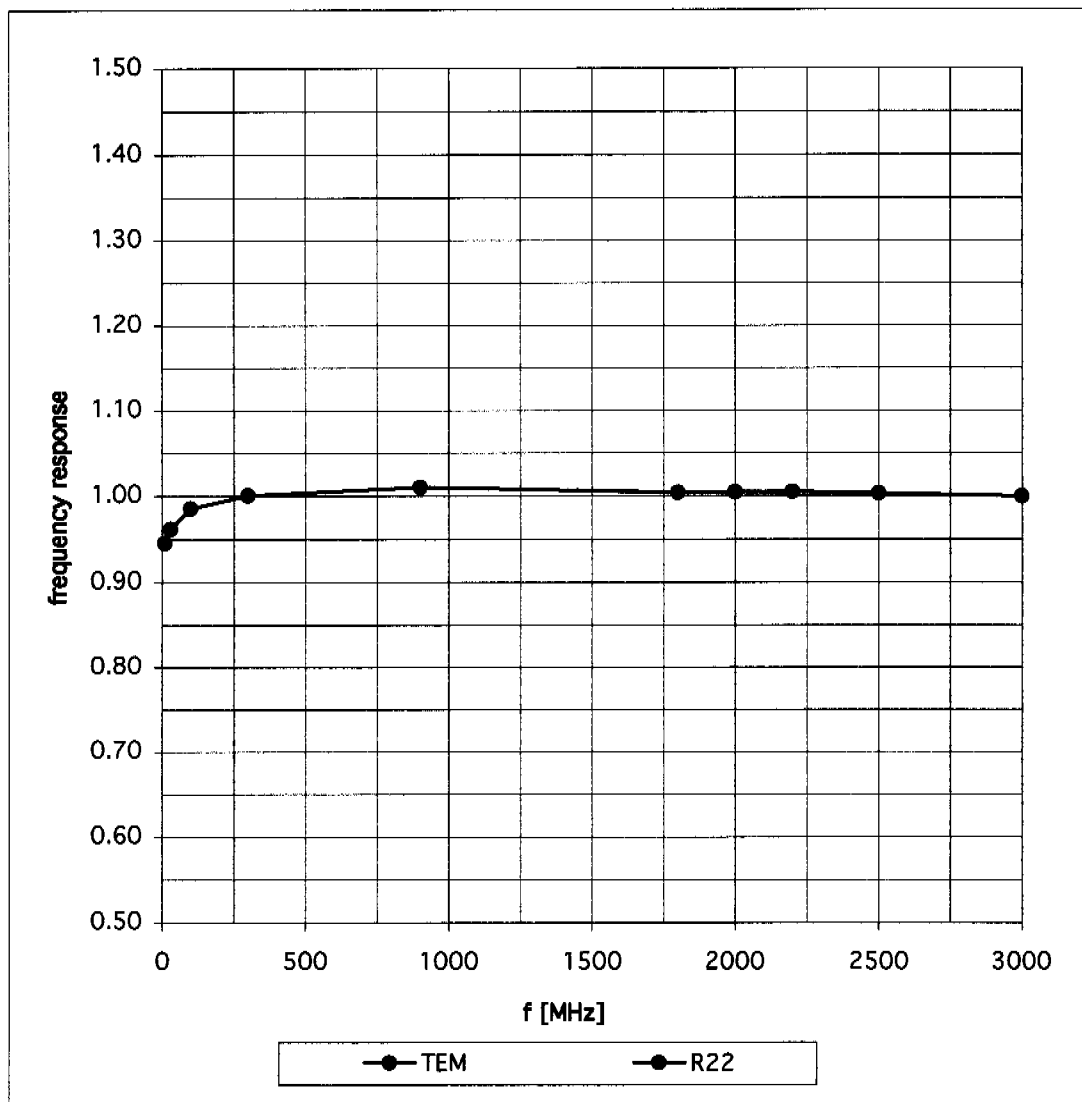

Dynamic Range f(SARhead) (Waveguide R22)

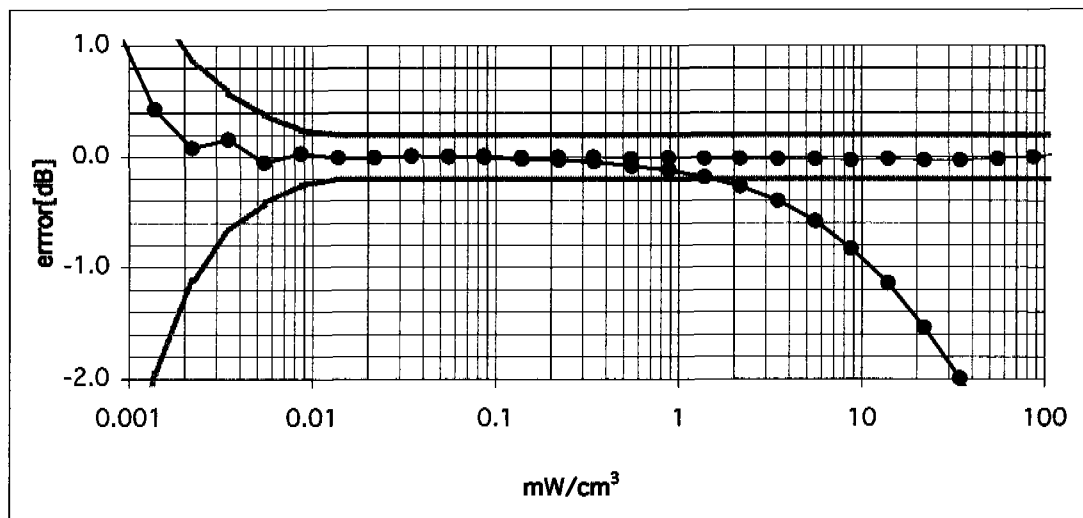
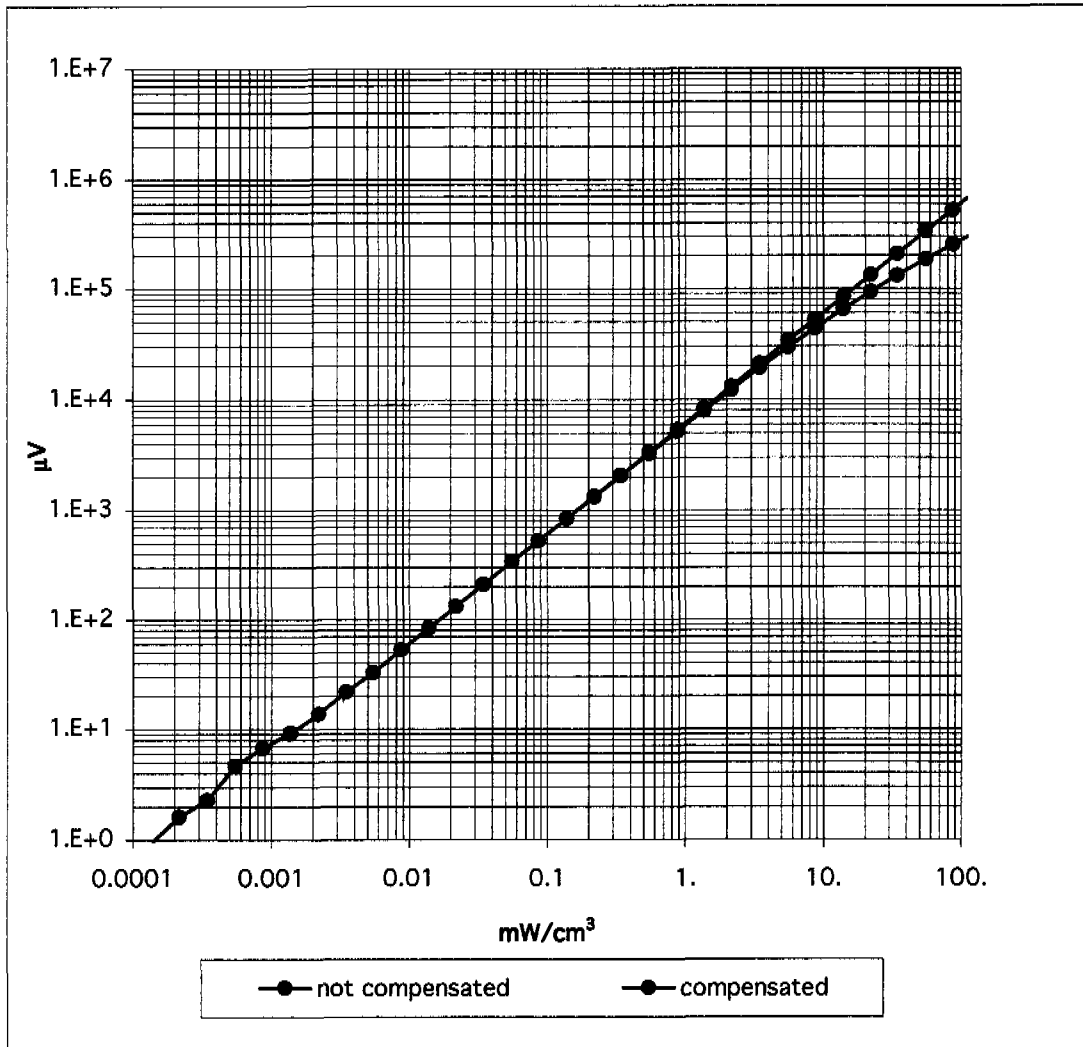

Conversion Factor Assessment

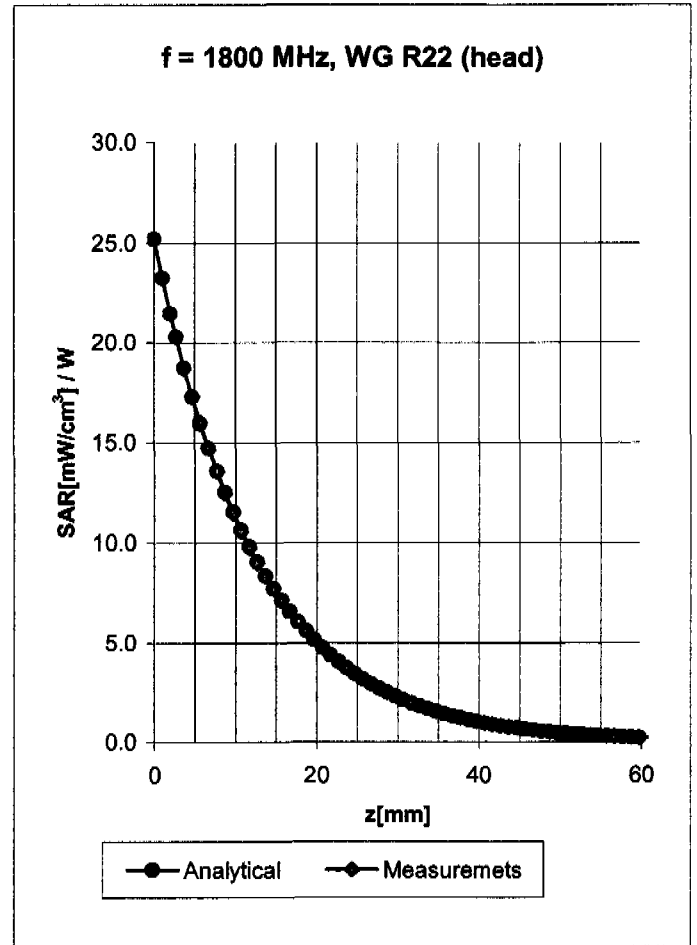
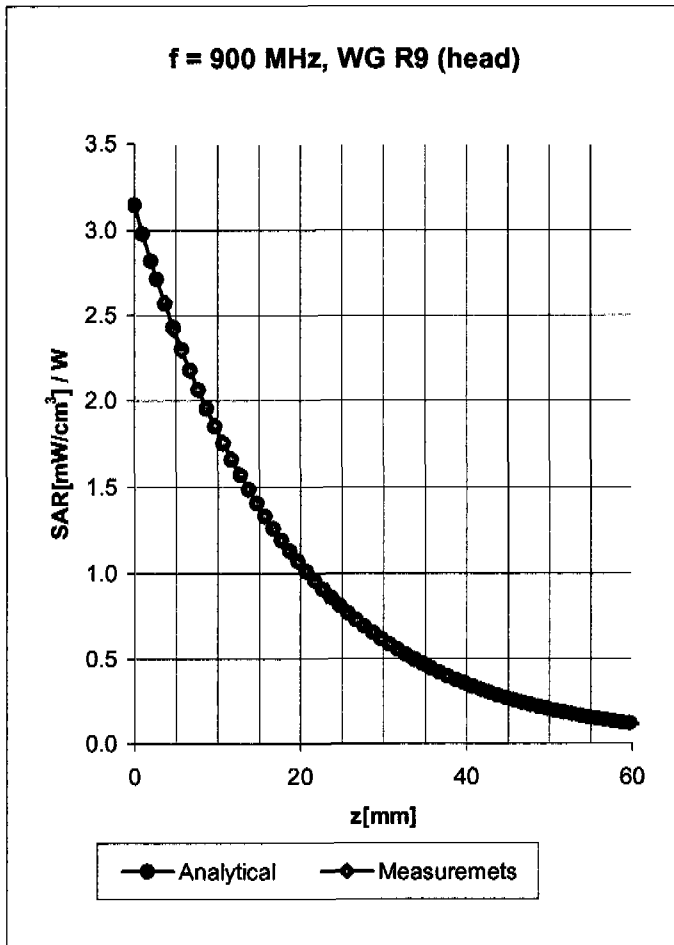

Head 900 MHz $\epsilon_r = 41.5 \pm 5\%$ $\sigma = 0.97 \pm 5\%$ mho/m

Valid for f=800-1000 MHz with Head Tissue Simulating Liquid according to EN 50361, P1528-200X

| | | | |
|---------|------------------------------|------------------|-------------|
| ConvF X | 6.2 $\pm 9.5\%$ (k=2) | Boundary effect: | |
| ConvF Y | 6.2 $\pm 9.5\%$ (k=2) | Alpha | 0.31 |
| ConvF Z | 6.2 $\pm 9.5\%$ (k=2) | Depth | 2.87 |

Head 1800 MHz $\epsilon_r = 40.0 \pm 5\%$ $\sigma = 1.40 \pm 5\%$ mho/m

Valid for f=1710-1910 MHz with Head Tissue Simulating Liquid according to EN 50361, P1528-200X

| | | | |
|---------|------------------------------|------------------|-------------|
| ConvF X | 5.2 $\pm 9.5\%$ (k=2) | Boundary effect: | |
| ConvF Y | 5.2 $\pm 9.5\%$ (k=2) | Alpha | 0.50 |
| ConvF Z | 5.2 $\pm 9.5\%$ (k=2) | Depth | 2.62 |

Conversion Factor Assessment

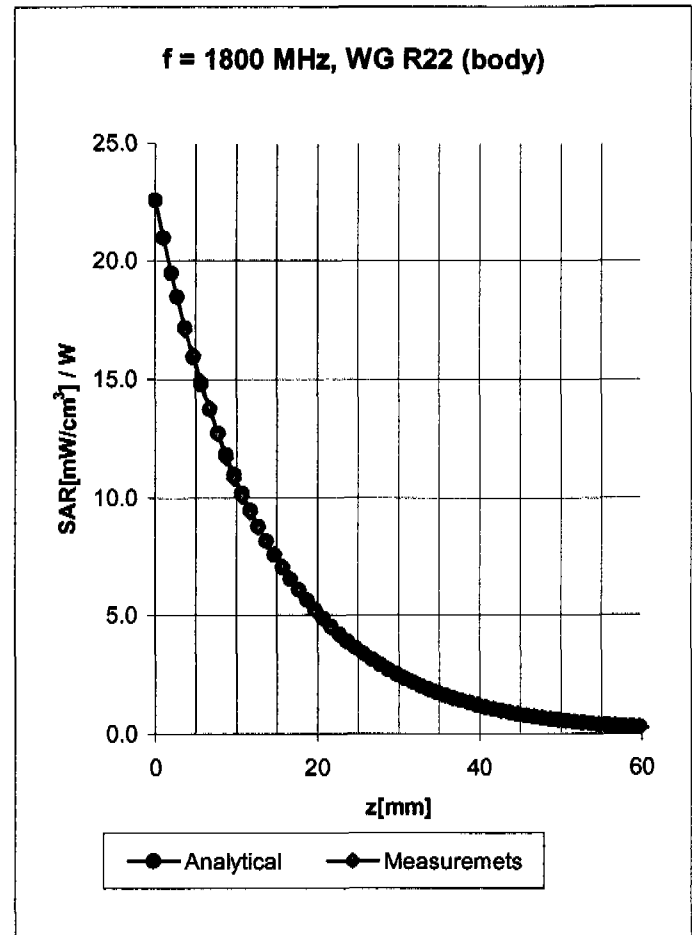
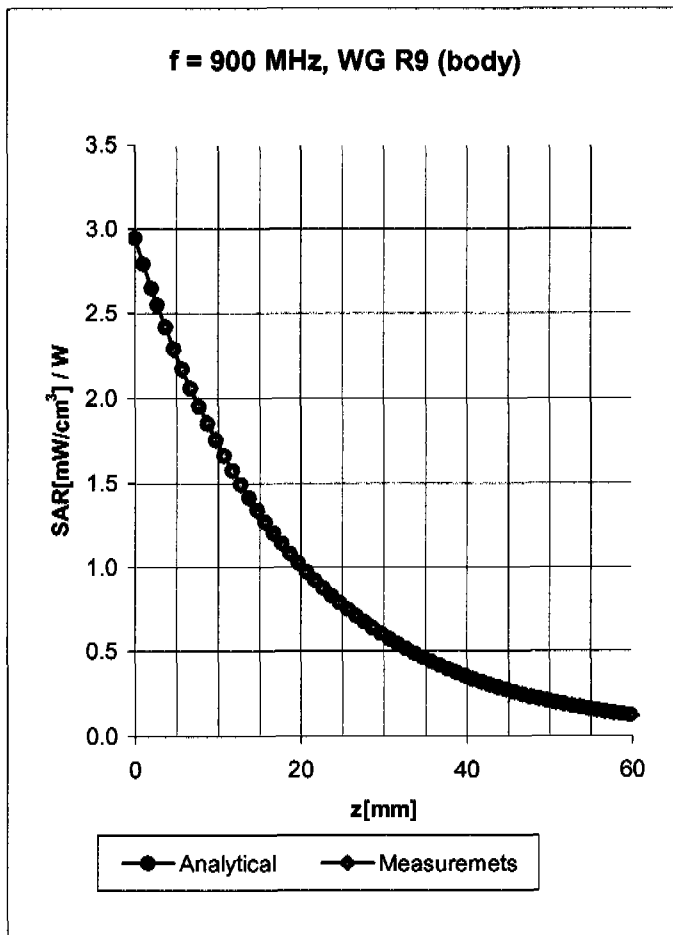

Body 900 MHz $\epsilon_r = 55.0 \pm 5\%$ $\sigma = 1.05 \pm 5\%$ mho/m

Valid for f=800-1000 MHz with Body Tissue Simulating Liquid according to OET 65 Suppl. C

| | | |
|---------|------------------|-------------------|
| ConvF X | 6.0 ± 9.5% (k=2) | Boundary effect: |
| ConvF Y | 6.0 ± 9.5% (k=2) | Alpha 0.38 |
| ConvF Z | 6.0 ± 9.5% (k=2) | Depth 2.52 |

Body 1800 MHz $\epsilon_r = 53.3 \pm 5\%$ $\sigma = 1.52 \pm 5\%$ mho/m

Valid for f=1710-1910 MHz with Body Tissue Simulating Liquid according to OET 65 Suppl. C

| | | |
|---------|------------------|-------------------|
| ConvF X | 4.6 ± 9.5% (k=2) | Boundary effect: |
| ConvF Y | 4.6 ± 9.5% (k=2) | Alpha 0.56 |
| ConvF Z | 4.6 ± 9.5% (k=2) | Depth 2.67 |

Conversion Factor Assessment

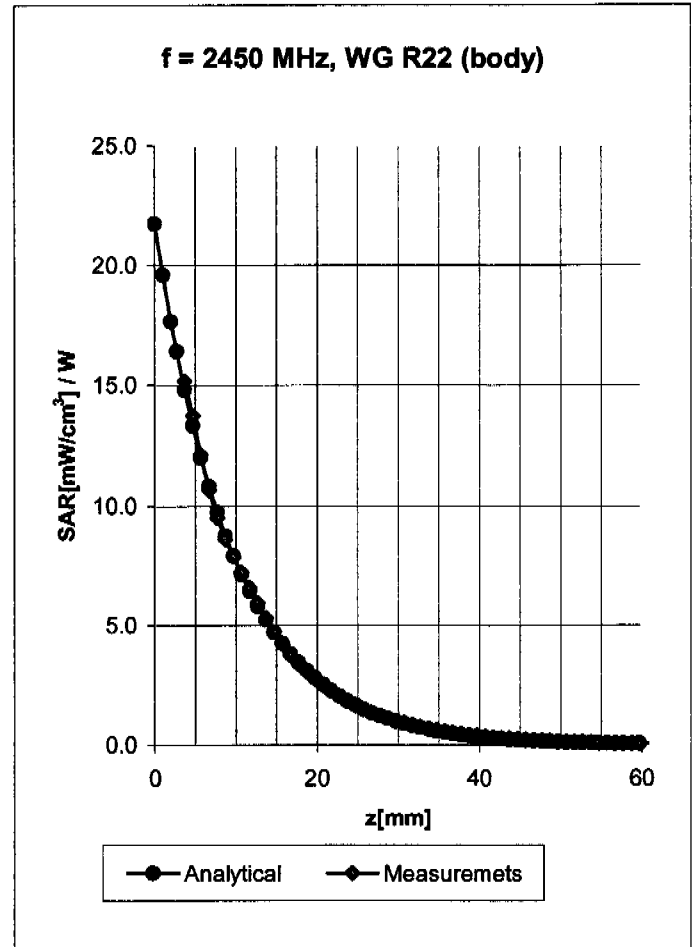
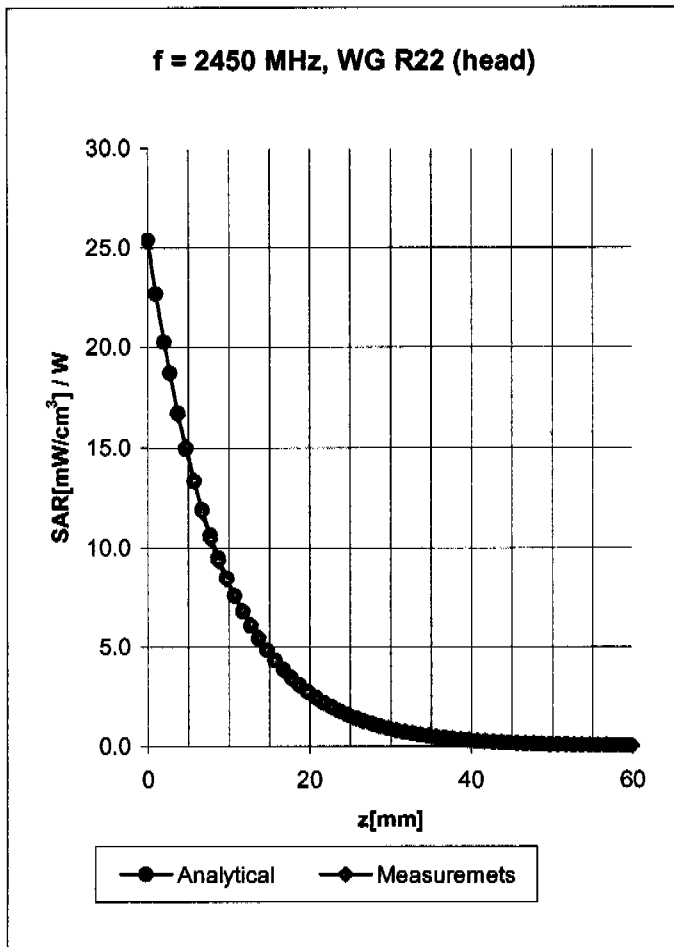

Head 2450 MHz $\epsilon_r = 39.2 \pm 5\%$ $\sigma = 1.80 \pm 5\%$ mho/m

Valid for f=2400-2500 MHz with Head Tissue Simulating Liquid according to EN 50361, P1528-200X

| | | | |
|---------|------------------|------------------|------|
| ConvF X | 4.6 ± 9.5% (k=2) | Boundary effect: | |
| ConvF Y | 4.6 ± 9.5% (k=2) | Alpha | 1.07 |
| ConvF Z | 4.6 ± 9.5% (k=2) | Depth | 1.79 |

Body 2450 MHz $\epsilon_r = 52.7 \pm 5\%$ $\sigma = 1.95 \pm 5\%$ mho/m

Valid for f=2400-2500 MHz with Body Tissue Simulating Liquid according to OET 65 Suppl. C

| | | | |
|---------|------------------|------------------|------|
| ConvF X | 4.1 ± 9.5% (k=2) | Boundary effect: | |
| ConvF Y | 4.1 ± 9.5% (k=2) | Alpha | 1.11 |
| ConvF Z | 4.1 ± 9.5% (k=2) | Depth | 1.56 |

Deviation from Isotropy in HSL

Error (θ, ϕ), $f = 900$ MHz

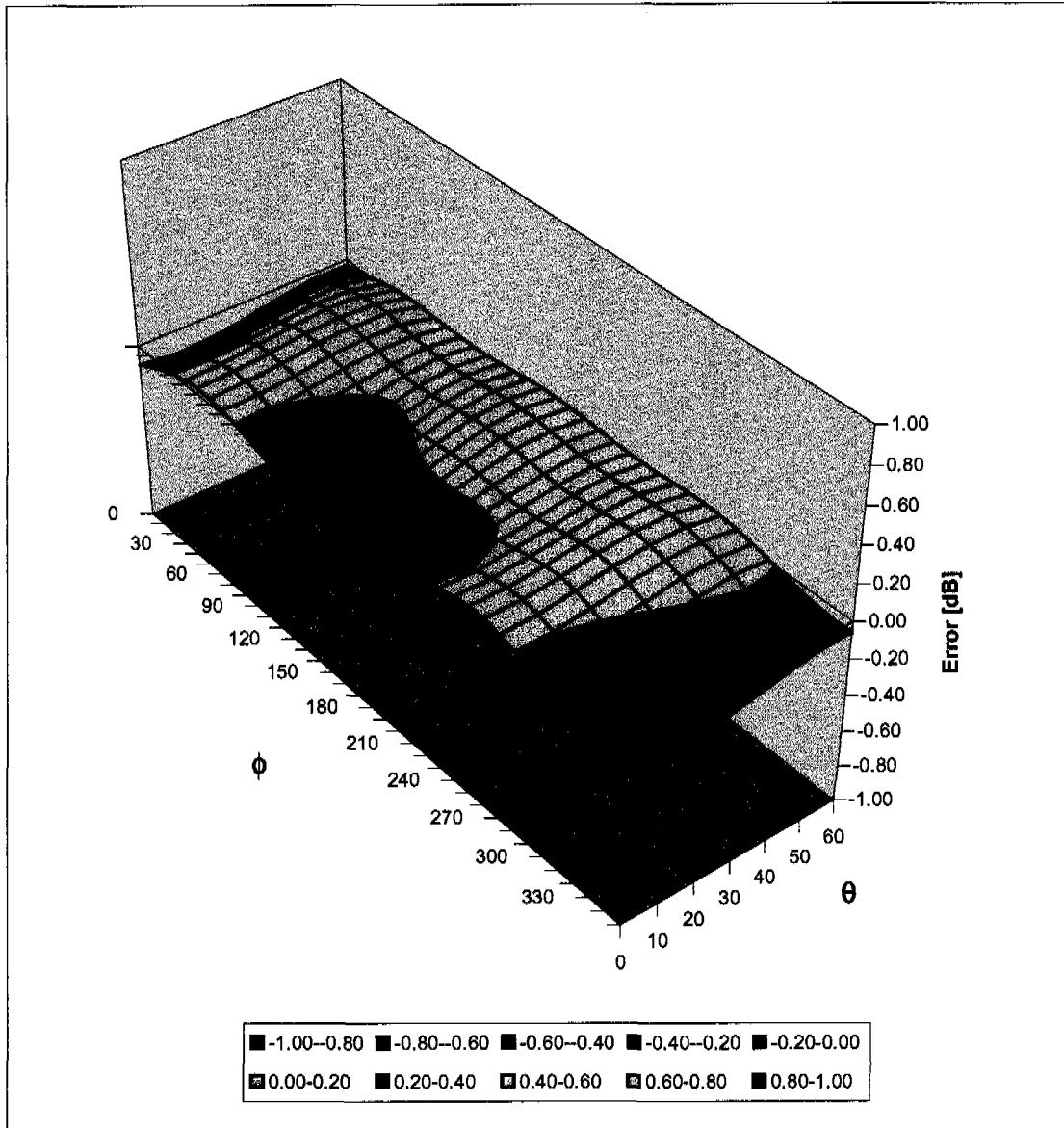

Client **ETS Dr. Genz**

CALIBRATION CERTIFICATE

Object(s) **DAE3 – SD 000 D03 AA – SN:522**

Calibration procedure(s) **QA CAL-06.v5a
Calibration procedure for the data acquisition unit (DAE)**

Calibration date: **16.12.2003**



Condition of the calibrated item **In Tolerance (according to the specific calibration document)**

This calibration statement documents traceability of M&TE used in the calibration procedures and conformity of the procedures with the ISO/IEC 17025 international standard.

All calibrations have been conducted in the closed laboratory facility: environment temperature 22 +/- 2 degrees Celsius and humidity < 75%.

Calibration Equipment used (M&TE critical for calibration)

| Model Type | ID # | Cal Date | Scheduled Calibration |
|-----------------------------------|-------------|----------|-----------------------|
| Fluke Process Calibrator Type 702 | SN: 6295803 | 8-Sep-03 | Sep-04 |

| | Name | Function | Signature |
|----------------|-----------------------|--------------|---|
| Calibrated by: | Philipp Storchenegger | Technician |  |
| Approved by: | Fin Bomholt | R&D Director |  |

Date issued: 16.12.2003

This calibration certificate is issued as an intermediate solution until the accreditation process (based on ISO/IEC 17025 International Standard) for Calibration Laboratory of Schmid & Partner Engineering AG is completed.

IMPORTANT NOTICE

USAGE OF THE DAE

The DAE unit is a delicate, high precision instrument and requires careful treatment by the user. There are no serviceable parts inside the DAE. Special attention shall be given to the following points:

Battery Exchange: The battery cover of the DAE3 unit is connected to a fragile 3-pin battery connector. Customer is responsible to apply utmost caution not to bend or damage the connector when changing batteries.

Shipping of the DAE: Before shipping the DAE to SPEAG for calibration Customer shall remove the batteries and pack the DAE in an antistatic bag. The packaging shall protect the DAE from impacts during transportation. The package shall be marked to indicate that a fragile instrument is inside.

E-Stop Failures: Touch detection may be malfunctioning due to broken magnets in the E-stop. Rough handling of the E-stop may lead to damage of these magnets. Touch and collision errors are often caused by dust and dirt accumulated in the E-stop. To prevent E-stop failure, Customer shall always mount the probe to the DAE carefully and keep the DAE unit in a non-dusty environment if not used for measurements.

Repair: Minor repairs are performed at no extra cost during the annual calibration. However, SPEAG reserves the right to charge for any repair especially if rough unprofessional handling caused the defect.

Important Note:

Warranty and calibration is void if the DAE unit is disassembled partly or fully by the Customer.

Important Note:

Never attempt to grease or oil the E-stop assembly. Cleaning and readjusting of the E-stop assembly is allowed by certified SPEAG personnel only and is part of the annual calibration procedure.

1. Cal Lab. Incoming Inspection & Pre Test

| | | |
|----------------------------------|--------------------------|---------------|
| Modification Status | Note Status here → → → → | BC |
| Visual Inspection | Note anomalies..... | None |
| | | |
| Pre Test | Indication | Yes/No |
| Probe Touch | Function | Yes |
| Probe Collision | Function | Yes |
| Probe Touch&Collision | Function | Yes |

2. DC Voltage Measurement

A/D - Converter Resolution nominal

High Range: 1LSB = 6.1µV, full range = 400 mV
 Low Range: 1LSB = 61nV, full range = 4 mV

DASY measurement parameters: Auto Zero Time: 3 sec; Measuring time: 3 sec

| | | | |
|-----------------------------------|----------------|----------|----------|
| Calibration Factors | X | Y | Z |
| High Range | 403.721 | 403.496 | 403.817 |
| Low Range | 3.90669 | 3.92578 | 3.92595 |
| Connector Angle to be used | in DASY System | | 44 ° |

| High Range | Input | Reading in µV | % Error |
|--------------------------|-------|---------------|---------|
| Channel X + Input | 200mV | 199999.4 | 0.00 |
| | 20mV | 19996.3 | -0.02 |
| Channel X - Input | 20mV | -19993.6 | -0.03 |
| | 200mV | 199999.5 | 0.00 |
| Channel Y + Input | 20mV | 19995.9 | -0.02 |
| | 20mV | -19994.4 | -0.03 |
| Channel Y - Input | 200mV | 200000.7 | 0.00 |
| | 20mV | 19994.2 | -0.03 |
| Channel Z + Input | 20mV | -19995.6 | -0.02 |

| Low Range | Input | Reading in µV | % Error |
|--------------------------|-------|---------------|---------|
| Channel X + Input | 2mV | 1999.97 | 0.00 |
| | 0.2mV | 200.58 | 0.29 |
| Channel X - Input | 0.2mV | -200.30 | 0.15 |
| | 2mV | 1999.98 | 0.00 |
| Channel Y + Input | 0.2mV | 199.72 | -0.14 |
| | 0.2mV | -200.64 | 0.32 |
| Channel Y - Input | 2mV | 2000.02 | 0.00 |
| | 0.2mV | 199.41 | -0.30 |
| Channel Z + Input | 0.2mV | -201.21 | 0.61 |

3. Common mode sensitivity

DASY measurement parameters:

Auto Zero Time: 3 sec,
High/Low Range

Measuring time: 3 sec

| In μV | Common mode Input Voltage | High Range Reading | Low Range Reading |
|------------------|---------------------------|--------------------|-------------------|
| Channel X | 200mV | -0.71 | -1.13 |
| | - 200mV | 2.36 | -0.91 |
| Channel Y | 200mV | -0.87 | -0.14 |
| | - 200mV | -0.34 | -1.27 |
| Channel Z | 200mV | -7.73 | -6.96 |
| | - 200mV | 5.49 | 6.16 |

4. Channel separation

DASY measurement parameters:

Auto Zero Time: 3 sec,
High Range

Measuring time: 3 sec

| In μV | Input Voltage | Channel X | Channel Y | Channel Z |
|------------------|---------------|-----------|-----------|-----------|
| Channel X | 200mV | - | 1.45 | 0.18 |
| Channel Y | 200mV | -0.88 | - | 4.83 |
| Channel Z | 200mV | -1.60 | 0.24 | - |

5.1 AD-Converter Values with Input Voltage set to 2.0 mVDC

| In Zero Low | Low Range Max - Min | Max. | Min |
|-------------|---------------------|-------|-------|
| Channel X | 10 | 16531 | 16521 |
| Channel Y | 5 | 16003 | 15998 |
| Channel Z | 13 | 16439 | 16426 |

5.2 AD-Converter Values with inputs shorted

| In LSB | Low Range | High Range |
|-----------|-----------|------------|
| Channel X | 16555 | 15364 |
| Channel Y | 16020 | 15473 |
| Channel Z | 16437 | 15486 |

6. Input Offset Measurement

DASY measurement parameters:

Auto Zero Time: 3 sec, Measuring time: 3 sec
 Number of measurements: 100, Low Range

Input 10M Ω

| in μ V | Average | min. Offset | max. Offset | Std. Deviation |
|------------|---------|-------------|-------------|----------------|
| Channel X | 1.48 | 0.57 | 2.44 | 0.40 |
| Channel Y | -1.16 | -1.66 | -0.62 | 0.23 |
| Channel Z | 0.05 | -0.52 | 1.00 | 0.23 |

Input shorted

| in μ V | Average | min. Offset | max. Offset | Std. Deviation |
|------------|---------|-------------|-------------|----------------|
| Channel X | 0.15 | -0.68 | 0.94 | 0.31 |
| Channel Y | -0.50 | -1.87 | -0.10 | 0.25 |
| Channel Z | -0.86 | -1.70 | -0.19 | 0.23 |

7. Input Offset Current

Nominal Input circuitry offset current on all channels: <25fA

8. Input Resistance

| In MOhm | Calibrating | Measuring |
|-----------|-------------|-----------|
| Channel X | 0.2000 | 199.5 |
| Channel Y | 0.2000 | 199.0 |
| Channel Z | 0.1999 | 199.5 |

9. Low Battery Alarm Voltage

| in V | Alarm Level |
|----------------|-------------|
| Supply (+ Vcc) | 7.88 |
| Supply (- Vcc) | -7.65 |

10. Power Consumption

| in mA | Switched off | Stand by | Transmitting |
|----------------|--------------|----------|--------------|
| Supply (+ Vcc) | 0.00 | 5.70 | 13.9 |
| Supply (- Vcc) | -0.01 | -8.03 | -9.22 |



Appendix B

Measurement Plots

Test Laboratory: ELECTRONIC TECHNOLOGY SYSTEMS DR. GENZ GMBH

Dipol Valid.900(h)_250mW_21.02.2005

DUT: Dipole 900 MHz; Type: D900V2; Serial: 164

Communication System: CW; Frequency: 900 MHz; Duty Cycle: 1:1

Medium: Head 900 MHz Medium parameters used: $f = 900$ MHz; $\sigma = 0.972$ mho/m; $\epsilon_r = 43.1$; $\rho = 1000$ kg/m³

Phantom section: Flat Section

DASY4 Configuration:

- Probe: ET3DV6 - SN1711; ConvF(6.2, 6.2, 6.2); Calibrated: 12/16/2003
- Sensor-Surface: 4mm (Mechanical And Optical Surface Detection)
- Electronics: DAE3 Sn522; Calibrated: 1/12/2004
- Phantom: SAM 12; Type: TP-1217; Serial: QD000P40CA
- Measurement SW: DASY4, V4.4 Build 3; Postprocessing SW: SEMCAD, V1.8 Build 130

Dipol 900 (250mW)/Area Scan (81x121x1): Measurement grid: dx=10mm, dy=10mm
Maximum value of SAR (interpolated) = 3.04 mW/g

Dipol 900 (250mW)/Zoom Scan (7x7x7)/Cube 0: Measurement grid: dx=5mm, dy=5mm, dz=5mm

Reference Value = 57.8 V/m; Power Drift = -0.1 dB

Peak SAR (extrapolated) = 4.07 W/kg

SAR(1 g) = 2.77 mW/g; SAR(10 g) = 1.79 mW/g

Maximum value of SAR (measured) = 3.01 mW/g

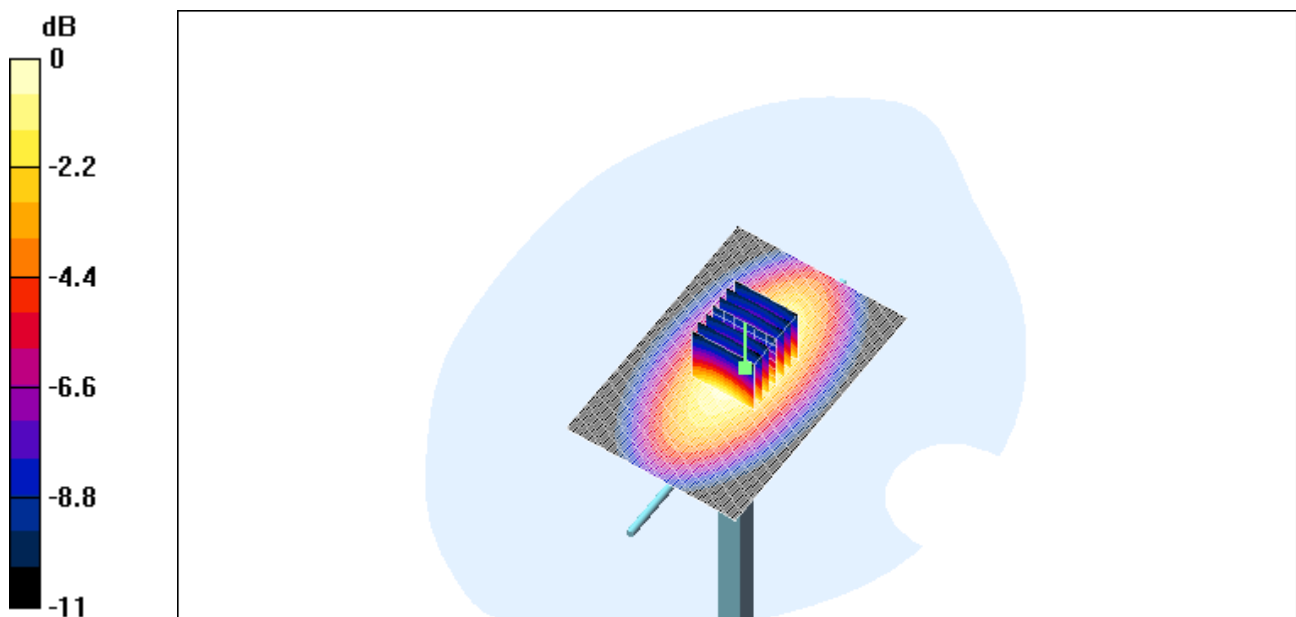

0 dB = 3.01mW/g

Test Laboratory: ELECTRONIC TECHNOLOGY SYSTEMS DR. GENZ GMBH

Dipol Valid.900(h)_250mW_22.02.2005

DUT: Dipole 900 MHz; Type: D900V2; Serial: 164

Communication System: CW; Frequency: 900 MHz; Duty Cycle: 1:1

Medium: Head 900 MHz Medium parameters used: $f = 900$ MHz; $\sigma = 0.972$ mho/m; $\epsilon_r = 43.1$; $\rho = 1000$ kg/m³

Phantom section: Flat Section

DASY4 Configuration:

- Probe: ET3DV6 - SN1711; ConvF(6.2, 6.2, 6.2); Calibrated: 12/16/2003
- Sensor-Surface: 4mm (Mechanical And Optical Surface Detection)
- Electronics: DAE3 Sn522; Calibrated: 1/12/2004
- Phantom: SAM 12; Type: TP-1217; Serial: QD000P40CA
- Measurement SW: DASY4, V4.4 Build 3; Postprocessing SW: SEMCAD, V1.8 Build 130

Dipol 900 (250mW)/Area Scan (81x121x1): Measurement grid: dx=10mm, dy=10mm
Maximum value of SAR (interpolated) = 3.17 mW/g

Dipol 900 (250mW)/Zoom Scan (7x7x7)/Cube 0: Measurement grid: dx=5mm, dy=5mm, dz=5mm

Reference Value = 60.1 V/m; Power Drift = -0.0 dB

Peak SAR (extrapolated) = 4.66 W/kg

SAR(1 g) = 2.78 mW/g; SAR(10 g) = 1.82 mW/g

Maximum value of SAR (measured) = 3.17 mW/g

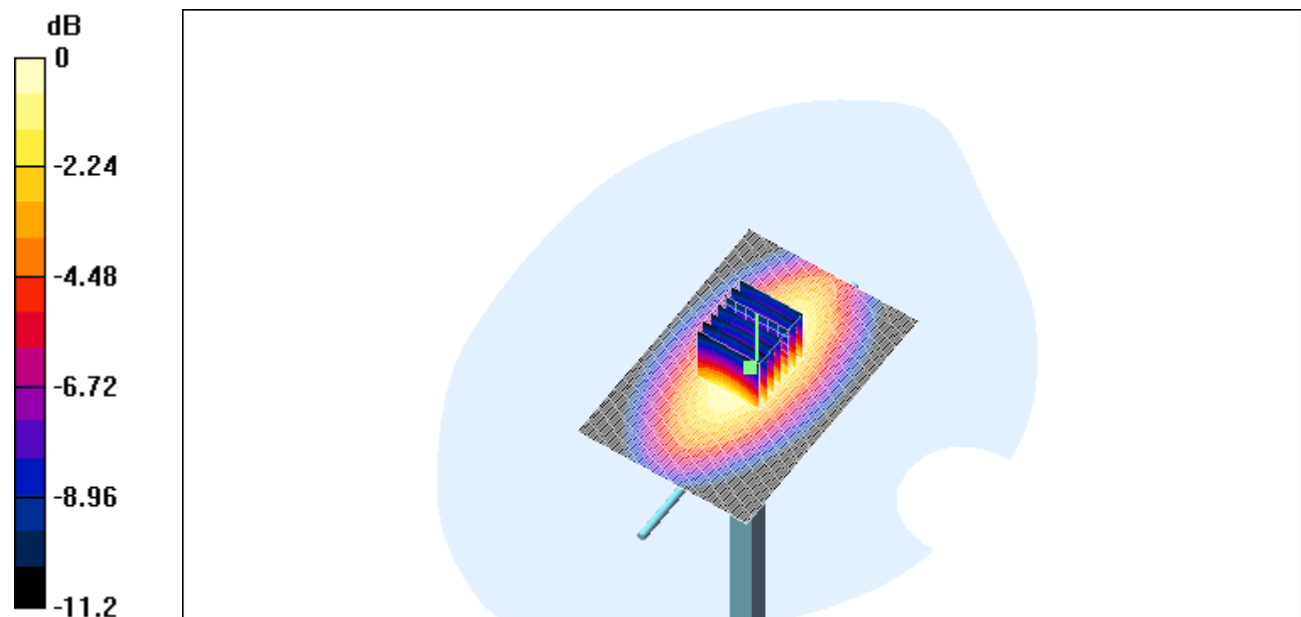

0 dB = 3.27mW/g

Test Laboratory: ELECTRONIC TECHNOLOGY SYSTEMS DR. GENZ GMBH

Dipol Valid.1900(h)_250mW_22.02.2005

DUT: Dipole 1900 MHz; Type: D1900V2; Serial: 5d025

Communication System: CW; Frequency: 1900 MHz; Duty Cycle: 1:1

Medium: Head 1900 MHz Medium parameters used (interpolated): $f = 1900$ MHz; $\sigma = 1.42$ mho/m;

$\epsilon_r = 39.8$; $\rho = 1000$ kg/m³

Phantom section: Flat Section

DASY4 Configuration:

- Probe: ET3DV6 - SN1711; ConvF(5.2, 5.2, 5.2); Calibrated: 12/16/2003
- Sensor-Surface: 4mm (Mechanical And Optical Surface Detection)
- Electronics: DAE3 Sn522; Calibrated: 1/12/2004
- Phantom: SAM 12; Type: TP-1217; Serial: QD000P40CA
- Measurement SW: DASY4, V4.4 Build 3; Postprocessing SW: SEMCAD, V1.8 Build 130

Dipol 1900 (250mW)/Area Scan (61x101x1): Measurement grid: dx=10mm, dy=10mm

Maximum value of SAR (interpolated) = 12.5 mW/g

Dipol 1900 (250mW)/Zoom Scan (7x7x7)/Cube 0: Measurement grid: dx=5mm, dy=5mm, dz=5mm

Reference Value = 96.7 V/m; Power Drift = -0.0 dB

Peak SAR (extrapolated) = 18.7 W/kg

SAR(1 g) = 10.8 mW/g; SAR(10 g) = 5.64 mW/g

Maximum value of SAR (measured) = 12.1 mW/g

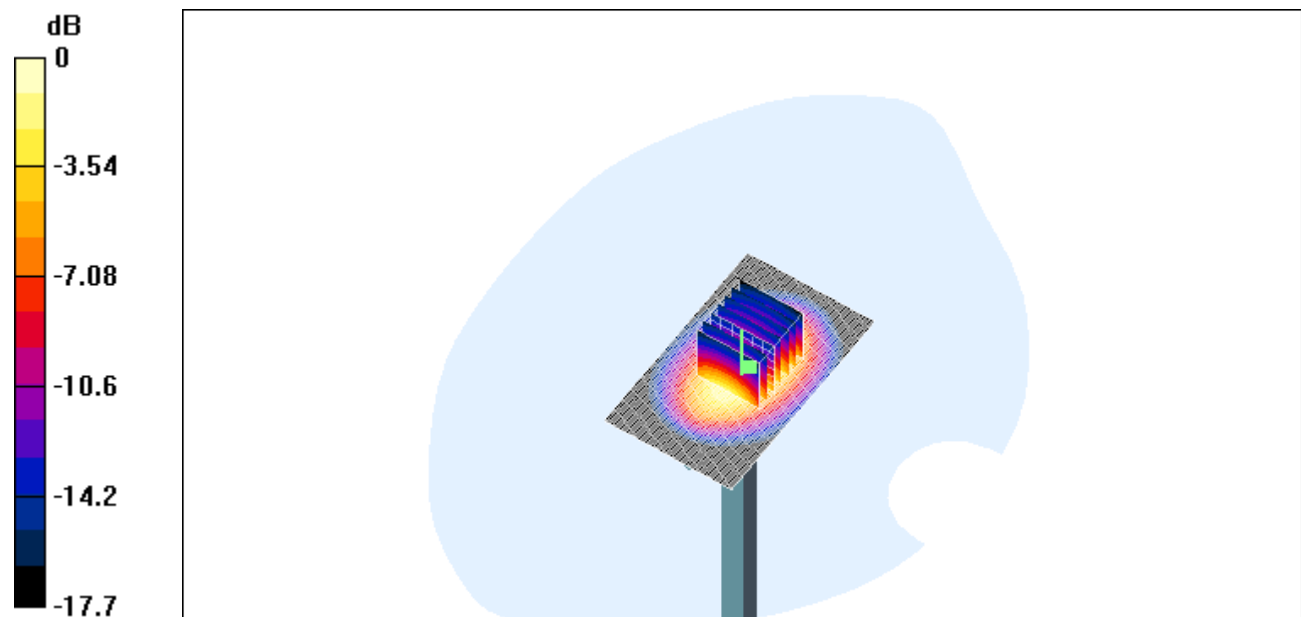

0 dB = 12.1mW/g

Test Laboratory: ELECTRONIC TECHNOLOGY SYSTEMS DR. GENZ GMBH

Dipol Valid.1900(h)_250mW_23.02.2005

DUT: Dipole 1900 MHz; Type: D1900V2; Serial: 5d025

Communication System: CW; Frequency: 1900 MHz; Duty Cycle: 1:1

Medium: Head 1900 MHz Medium parameters used (interpolated): $f = 1900$ MHz; $\sigma = 1.42$ mho/m;

$\epsilon_r = 39.8$; $\rho = 1000$ kg/m³

Phantom section: Flat Section

DASY4 Configuration:

- Probe: ET3DV6 - SN1711; ConvF(5.2, 5.2, 5.2); Calibrated: 12/16/2003
- Sensor-Surface: 4mm (Mechanical And Optical Surface Detection)
- Electronics: DAE3 Sn522; Calibrated: 1/12/2004
- Phantom: SAM 12; Type: TP-1217; Serial: QD000P40CA
- Measurement SW: DASY4, V4.4 Build 3; Postprocessing SW: SEMCAD, V1.8 Build 130

Dipol 1900 (250mW)/Area Scan (61x101x1): Measurement grid: dx=10mm, dy=10mm

Maximum value of SAR (interpolated) = 12.3 mW/g

Dipol 1900 (250mW)/Zoom Scan (7x7x7)/Cube 0: Measurement grid: dx=5mm, dy=5mm, dz=5mm

Reference Value = 98.5 V/m; Power Drift = -0.1 dB

Peak SAR (extrapolated) = 19.2 W/kg

SAR(1 g) = 10.8 mW/g; SAR(10 g) = 5.62 mW/g

Maximum value of SAR (measured) = 12.2 mW/g

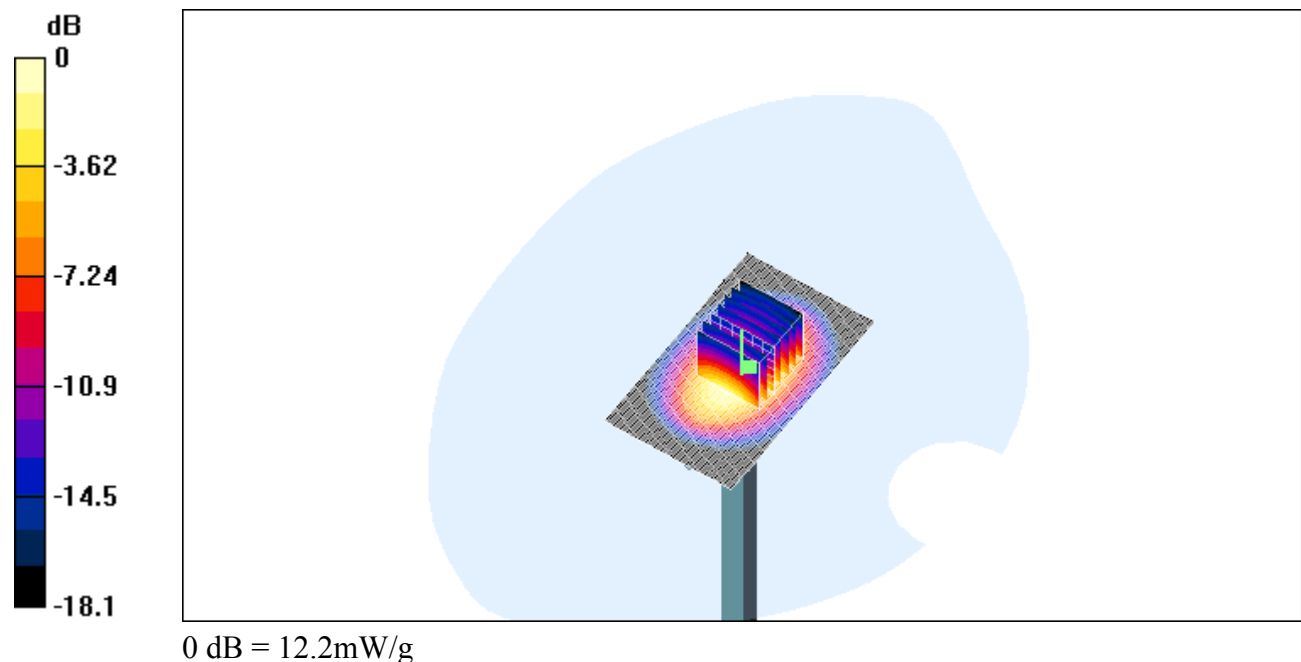

Test Laboratory: ELECTRONIC TECHNOLOGY SYSTEMS DR. GENZ GMBH

Dipol Valid.900(m)_250mW_24.02.2005

DUT: Dipole 900 MHz; Type: D900V2; Serial: 164

Communication System: CW; Frequency: 900 MHz; Duty Cycle: 1:1

Medium: Muscle 900 MHz Medium parameters used: $f = 900 \text{ MHz}$; $\sigma = 1.04 \text{ mho/m}$; $\epsilon_r = 54.4$; $\rho = 1000 \text{ kg/m}^3$

Phantom section: Flat Section

DASY4 Configuration:

- Probe: ET3DV6 - SN1711; ConvF(6, 6, 6); Calibrated: 12/16/2003
- Sensor-Surface: 4mm (Mechanical And Optical Surface Detection)
- Electronics: DAE3 Sn522; Calibrated: 1/12/2004
- Phantom: SAM 12; Type: TP-1217; Serial: QD000P40CA
- Measurement SW: DASY4, V4.4 Build 3; Postprocessing SW: SEMCAD, V1.8 Build 130

Dipol 900 (250mW)/Area Scan (81x121x1): Measurement grid: $dx=10\text{mm}$, $dy=10\text{mm}$
Maximum value of SAR (interpolated) = 3.09 mW/g

Dipol 900 (250mW)/Zoom Scan (7x7x7)/Cube 0: Measurement grid: $dx=5\text{mm}$, $dy=5\text{mm}$, $dz=5\text{mm}$

Reference Value = 55.1 V/m; Power Drift = -0.2 dB

Peak SAR (extrapolated) = 4.15 W/kg

SAR(1 g) = 2.78 mW/g; SAR(10 g) = 1.79 mW/g

Maximum value of SAR (measured) = 3.03 mW/g

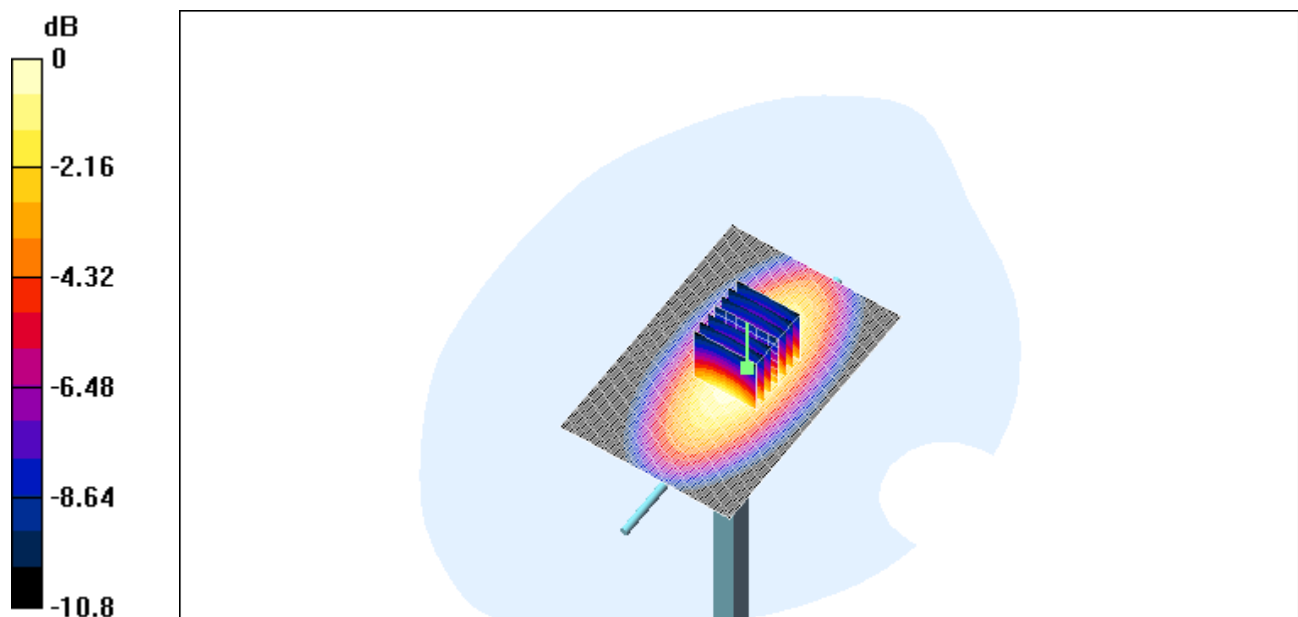

0 dB = 3.03mW/g

Test Laboratory: ELECTRONIC TECHNOLOGY SYSTEMS DR. GENZ GMBH

Dipol Valid.1900(m)_250mW_23.02.2005

DUT: Dipole 1900 MHz; Type: D1900V2; Serial: 5d025

Communication System: CW; Frequency: 1900 MHz; Duty Cycle: 1:1

Medium: Muscle 1900 MHz Medium parameters used: $f = 1900$ MHz; $\sigma = 1.58$ mho/m; $\epsilon_r = 51.9$; $\rho = 1000$ kg/m³

Phantom section: Flat Section

DASY4 Configuration:

- Probe: ET3DV6 - SN1711; ConvF(4.6, 4.6, 4.6); Calibrated: 12/16/2003
- Sensor-Surface: 4mm (Mechanical And Optical Surface Detection)
- Electronics: DAE3 Sn522; Calibrated: 1/12/2004
- Phantom: SAM 12; Type: TP-1217; Serial: QD000P40CA
- Measurement SW: DASY4, V4.4 Build 3; Postprocessing SW: SEMCAD, V1.8 Build 130

Dipol 1900 (250mW)/Area Scan (61x101x1): Measurement grid: dx=10mm, dy=10mm
Maximum value of SAR (interpolated) = 13.3 mW/g

Dipol 1900 (250mW)/Zoom Scan (7x7x7)/Cube 0: Measurement grid: dx=5mm, dy=5mm, dz=5mm

Reference Value = 95.8 V/m; Power Drift = 0.0 dB

Peak SAR (extrapolated) = 19.3 W/kg

SAR(1 g) = 10.9 mW/g; SAR(10 g) = 6 mW/g

Maximum value of SAR (measured) = 12.9 mW/g

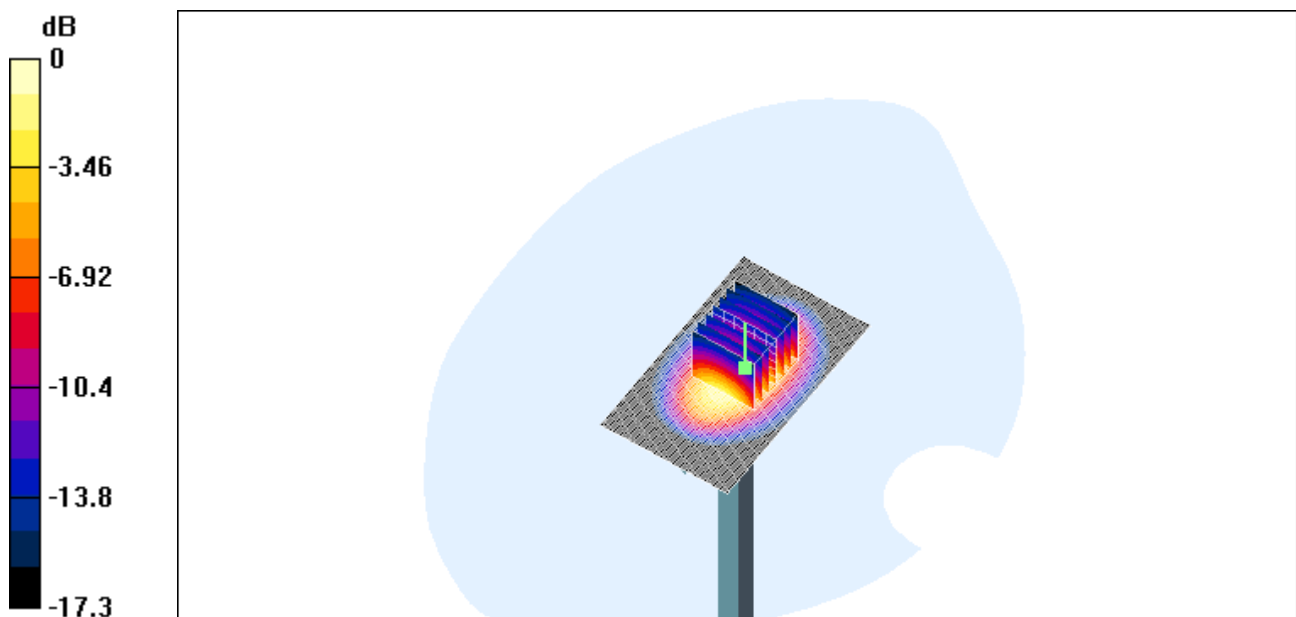

0 dB = 12.9mW/g

Test Laboratory: ELECTRONIC TECHNOLOGY SYSTEMS DR. GENZ GMBH

850_right_ch128_cheek

DUT: Triple Band GSM 850 / DCS 1800 / PCS 1900 (with WAP & GPRS); Type: ---; Serial: PG-3210

Communication System: GSM 850; Frequency: 824.2 MHz; Duty Cycle: 1:8.3

Medium: Head 850 MHz Medium parameters used (interpolated): $f = 824.2$ MHz; $\sigma = 0.892$ mho/m;

$\epsilon_r = 42.2$; $\rho = 1000$ kg/m³

Phantom section: Right Section

DASY4 Configuration:

- Probe: ET3DV6 - SN1711; ConvF(6.2, 6.2, 6.2); Calibrated: 12/16/2003
- Sensor-Surface: 4mm (Mechanical And Optical Surface Detection)
- Electronics: DAE3 Sn522; Calibrated: 1/12/2004
- Phantom: SAM 12; Type: TP-1217; Serial: QD000P40CA
- Measurement SW: DASY4, V4.4 Build 3; Postprocessing SW: SEMCAD, V1.8 Build 130

PG_3210/Area Scan (91x161x1): Measurement grid: dx=10mm, dy=10mm

Maximum value of SAR (interpolated) = 1.33 mW/g

PG_3210/Zoom Scan (7x7x7)/Cube 0: Measurement grid: dx=5mm, dy=5mm, dz=5mm

Reference Value = 7.55 V/m; Power Drift = -0.0 dB

Peak SAR (extrapolated) = 1.78 W/kg

SAR(1 g) = 1.15 mW/g; SAR(10 g) = 0.744 mW/g

Maximum value of SAR (measured) = 1.29 mW/g

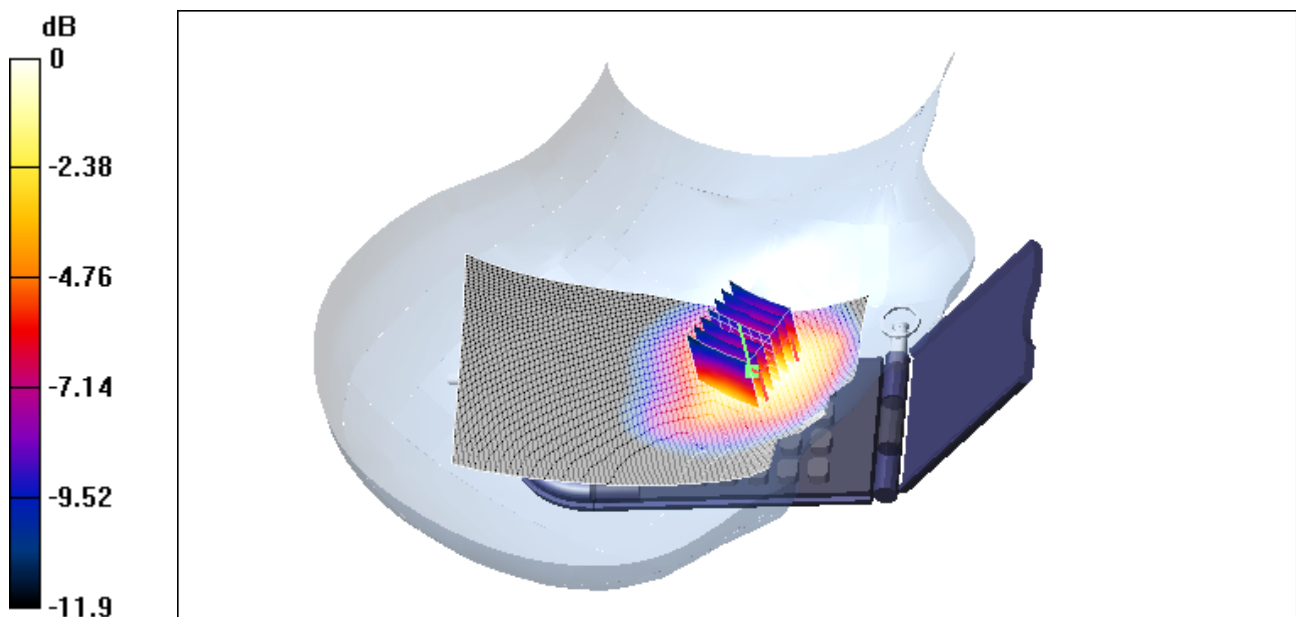

0 dB = 1.29mW/g

Test Laboratory: ELECTRONIC TECHNOLOGY SYSTEMS DR. GENZ GMBH

850_right_ch128_tilted

DUT: Triple Band GSM 850 / DCS 1800 / PCS 1900 (with WAP & GPRS); Type: ---; Serial: PG-3210

Communication System: GSM 850; Frequency: 824.2 MHz; Duty Cycle: 1:8.3

Medium: Head 850 MHz Medium parameters used (interpolated): $f = 824.2$ MHz; $\sigma = 0.892$ mho/m;

$\epsilon_r = 42.2$; $\rho = 1000$ kg/m³

Phantom section: Right Section

DASY4 Configuration:

- Probe: ET3DV6 - SN1711; ConvF(6.2, 6.2, 6.2); Calibrated: 12/16/2003
- Sensor-Surface: 4mm (Mechanical And Optical Surface Detection)
- Electronics: DAE3 Sn522; Calibrated: 1/12/2004
- Phantom: SAM 12; Type: TP-1217; Serial: QD000P40CA
- Measurement SW: DASY4, V4.4 Build 3; Postprocessing SW: SEMCAD, V1.8 Build 130

PG_3210/Area Scan (91x161x1): Measurement grid: dx=10mm, dy=10mm

Maximum value of SAR (interpolated) = 0.332 mW/g

PG_3210/Zoom Scan (7x7x7)/Cube 0: Measurement grid: dx=5mm, dy=5mm, dz=5mm

Reference Value = 12.6 V/m; Power Drift = 0.1 dB

Peak SAR (extrapolated) = 0.411 W/kg

SAR(1 g) = 0.314 mW/g; SAR(10 g) = 0.228 mW/g

Maximum value of SAR (measured) = 0.334 mW/g

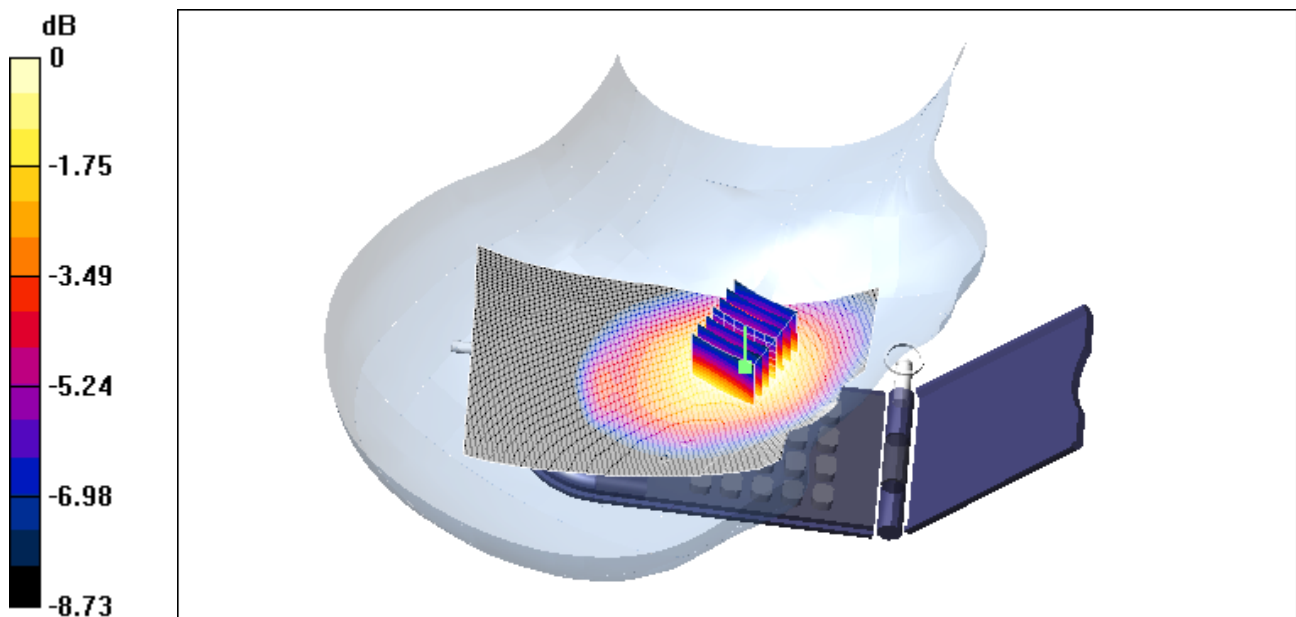

Test Laboratory: ELECTRONIC TECHNOLOGY SYSTEMS DR. GENZ GMBH

850_right_ch189_cheek

DUT: Triple Band GSM 850 / DCS 1800 / PCS 1900 (with WAP & GPRS); Type: ---; Serial: PG-3210

Communication System: GSM 850; Frequency: 836.4 MHz; Duty Cycle: 1:8.3

Medium: Head 850 MHz Medium parameters used (interpolated): $f = 836.4$ MHz; $\sigma = 0.883$ mho/m;

$\epsilon_r = 42.3$; $\rho = 1000$ kg/m³

Phantom section: Right Section

DASY4 Configuration:

- Probe: ET3DV6 - SN1711; ConvF(6.2, 6.2, 6.2); Calibrated: 12/16/2003
- Sensor-Surface: 4mm (Mechanical And Optical Surface Detection)
- Electronics: DAE3 Sn522; Calibrated: 1/12/2004
- Phantom: SAM 12; Type: TP-1217; Serial: QD000P40CA
- Measurement SW: DASY4, V4.4 Build 3; Postprocessing SW: SEMCAD, V1.8 Build 130

PG_3210/Area Scan (91x161x1): Measurement grid: dx=10mm, dy=10mm

Maximum value of SAR (interpolated) = 1.28 mW/g

PG_3210/Zoom Scan (7x7x7)/Cube 0: Measurement grid: dx=5mm, dy=5mm, dz=5mm

Reference Value = 7.66 V/m; Power Drift = -0.1 dB

Peak SAR (extrapolated) = 1.82 W/kg

SAR(1 g) = 1.17 mW/g; SAR(10 g) = 0.736 mW/g

Maximum value of SAR (measured) = 1.27 mW/g

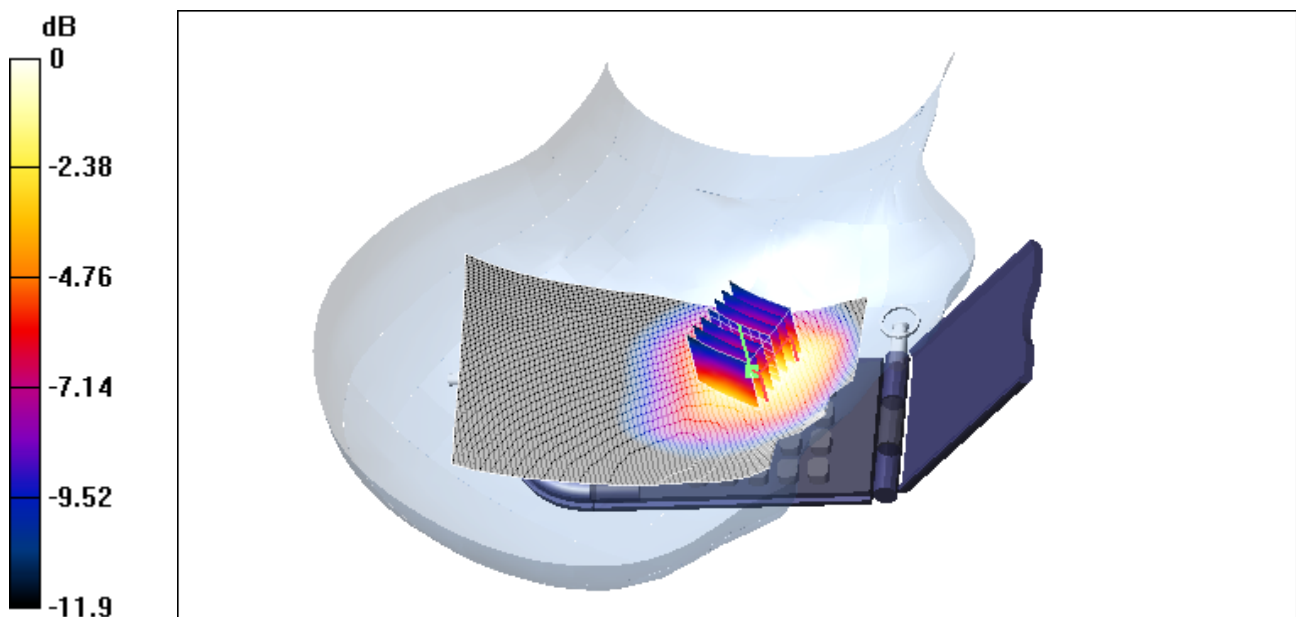

0 dB = 1.27mW/g

Test Laboratory: ELECTRONIC TECHNOLOGY SYSTEMS DR. GENZ GMBH

850_right_ch189_tilted

DUT: Triple Band GSM 850 / DCS 1800 / PCS 1900 (with WAP & GPRS); Type: ---; Serial: PG-3210

Communication System: GSM 850; Frequency: 836.4 MHz; Duty Cycle: 1:8.3

Medium: Head 850 MHz Medium parameters used (interpolated): $f = 836.4$ MHz; $\sigma = 0.883$ mho/m;

$\epsilon_r = 42.3$; $\rho = 1000$ kg/m³

Phantom section: Right Section

DASY4 Configuration:

- Probe: ET3DV6 - SN1711; ConvF(6.2, 6.2, 6.2); Calibrated: 12/16/2003
- Sensor-Surface: 4mm (Mechanical And Optical Surface Detection)
- Electronics: DAE3 Sn522; Calibrated: 1/12/2004
- Phantom: SAM 12; Type: TP-1217; Serial: QD000P40CA
- Measurement SW: DASY4, V4.4 Build 3; Postprocessing SW: SEMCAD, V1.8 Build 130

PG_3210/Area Scan (91x161x1): Measurement grid: dx=10mm, dy=10mm

Maximum value of SAR (interpolated) = 0.357 mW/g

PG_3210/Zoom Scan (7x7x7)/Cube 0: Measurement grid: dx=5mm, dy=5mm, dz=5mm

Reference Value = 12.7 V/m; Power Drift = -0.0 dB

Peak SAR (extrapolated) = 0.429 W/kg

SAR(1 g) = 0.332 mW/g; SAR(10 g) = 0.239 mW/g

Maximum value of SAR (measured) = 0.351 mW/g

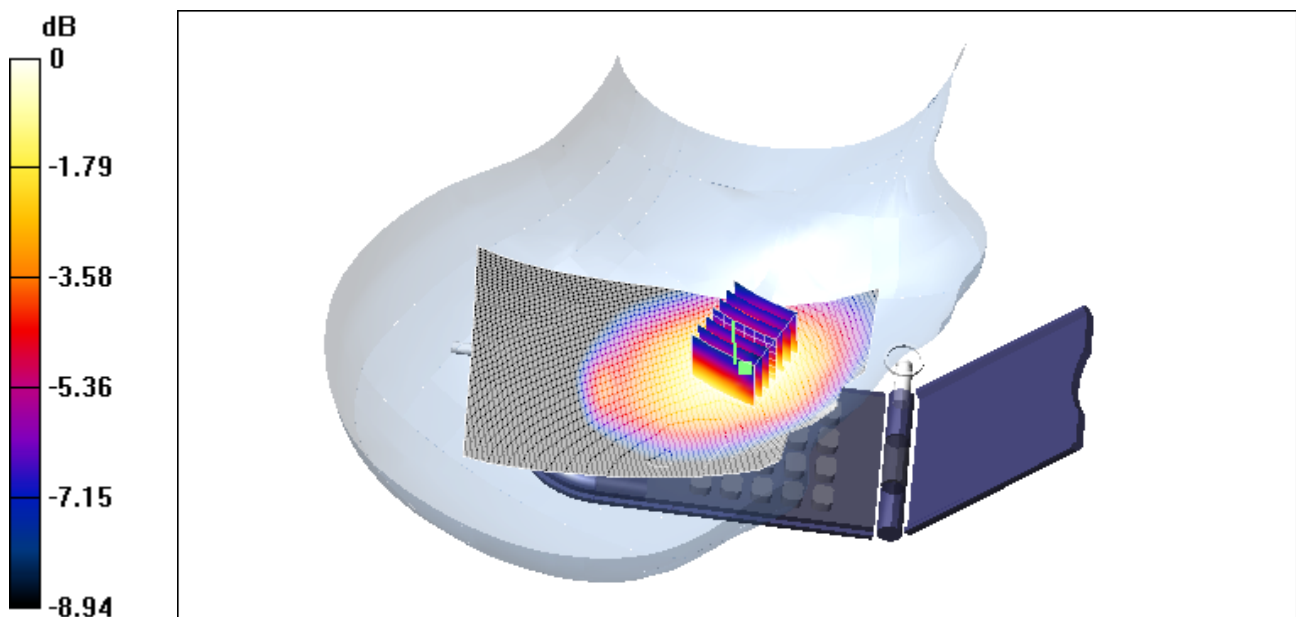

0 dB = 0.351mW/g

Test Laboratory: ELECTRONIC TECHNOLOGY SYSTEMS DR. GENZ GMBH

850_right_ch251_cheek

DUT: Triple Band GSM 850 / DCS 1800 / PCS 1900 (with WAP & GPRS); Type: ---; Serial: PG-3210

Communication System: GSM 850; Frequency: 848.8 MHz; Duty Cycle: 1:8.3

Medium: Head 850 MHz Medium parameters used (interpolated): $f = 848.8$ MHz; $\sigma = 0.927$ mho/m;

$\epsilon_r = 41.8$; $\rho = 1000$ kg/m³

Phantom section: Right Section

DASY4 Configuration:

- Probe: ET3DV6 - SN1711; ConvF(6.2, 6.2, 6.2); Calibrated: 12/16/2003
- Sensor-Surface: 4mm (Mechanical And Optical Surface Detection)
- Electronics: DAE3 Sn522; Calibrated: 1/12/2004
- Phantom: SAM 12; Type: TP-1217; Serial: QD000P40CA
- Measurement SW: DASY4, V4.4 Build 3; Postprocessing SW: SEMCAD, V1.8 Build 130

PG_3210/Area Scan (91x161x1): Measurement grid: dx=10mm, dy=10mm

Maximum value of SAR (interpolated) = 1.16 mW/g

PG_3210/Zoom Scan (7x7x7)/Cube 0: Measurement grid: dx=5mm, dy=5mm, dz=5mm

Reference Value = 6.29 V/m; Power Drift = -0.1 dB

Peak SAR (extrapolated) = 1.59 W/kg

SAR(1 g) = 1.04 mW/g; SAR(10 g) = 0.667 mW/g

Maximum value of SAR (measured) = 1.14 mW/g

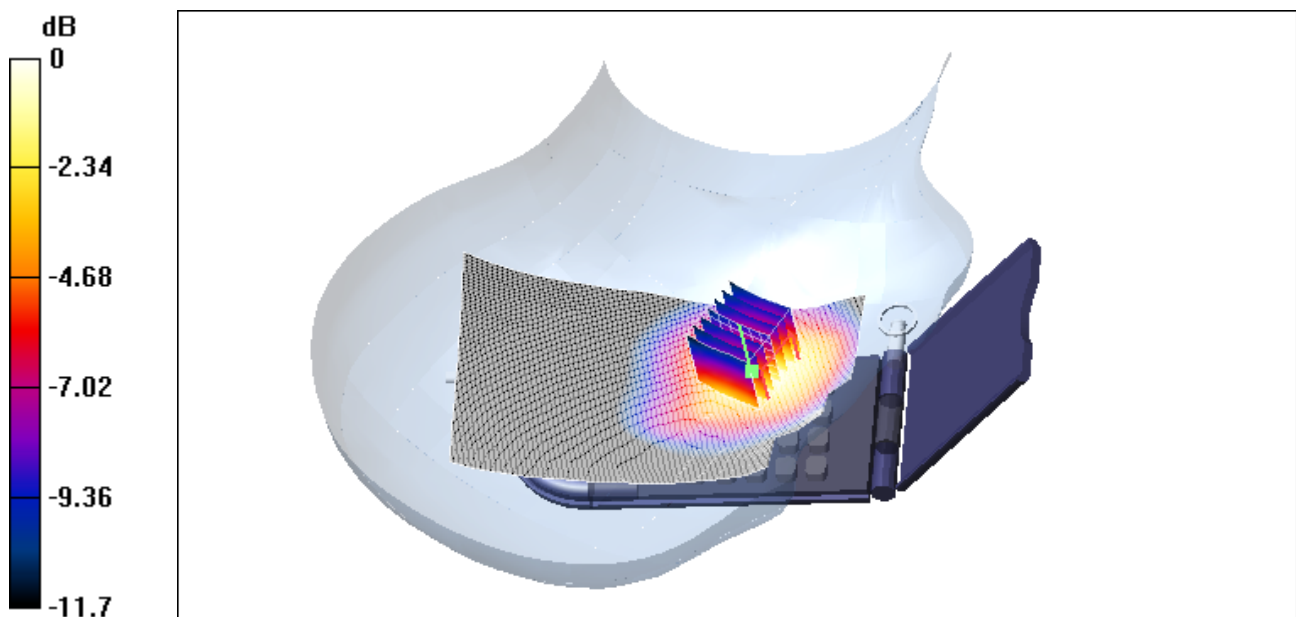

0 dB = 1.14mW/g

Test Laboratory: ELECTRONIC TECHNOLOGY SYSTEMS DR. GENZ GMBH

850_right_ch251_tilted

DUT: Triple Band GSM 850 / DCS 1800 / PCS 1900 (with WAP & GPRS); Type: ---; Serial: PG-3210

Communication System: GSM 850; Frequency: 848.8 MHz; Duty Cycle: 1:8.3

Medium: Head 850 MHz Medium parameters used (interpolated): $f = 848.8$ MHz; $\sigma = 0.927$ mho/m;

$\epsilon_r = 41.8$; $\rho = 1000$ kg/m³

Phantom section: Right Section

DASY4 Configuration:

- Probe: ET3DV6 - SN1711; ConvF(6.2, 6.2, 6.2); Calibrated: 12/16/2003
- Sensor-Surface: 4mm (Mechanical And Optical Surface Detection)
- Electronics: DAE3 Sn522; Calibrated: 1/12/2004
- Phantom: SAM 12; Type: TP-1217; Serial: QD000P40CA
- Measurement SW: DASY4, V4.4 Build 3; Postprocessing SW: SEMCAD, V1.8 Build 130

PG_3210/Area Scan (91x161x1): Measurement grid: dx=10mm, dy=10mm

Maximum value of SAR (interpolated) = 0.247 mW/g

PG_3210/Zoom Scan (7x7x7)/Cube 0: Measurement grid: dx=5mm, dy=5mm, dz=5mm

Reference Value = 10.5 V/m; Power Drift = -0.1 dB

Peak SAR (extrapolated) = 0.292 W/kg

SAR(1 g) = 0.230 mW/g; SAR(10 g) = 0.166 mW/g

Maximum value of SAR (measured) = 0.244 mW/g

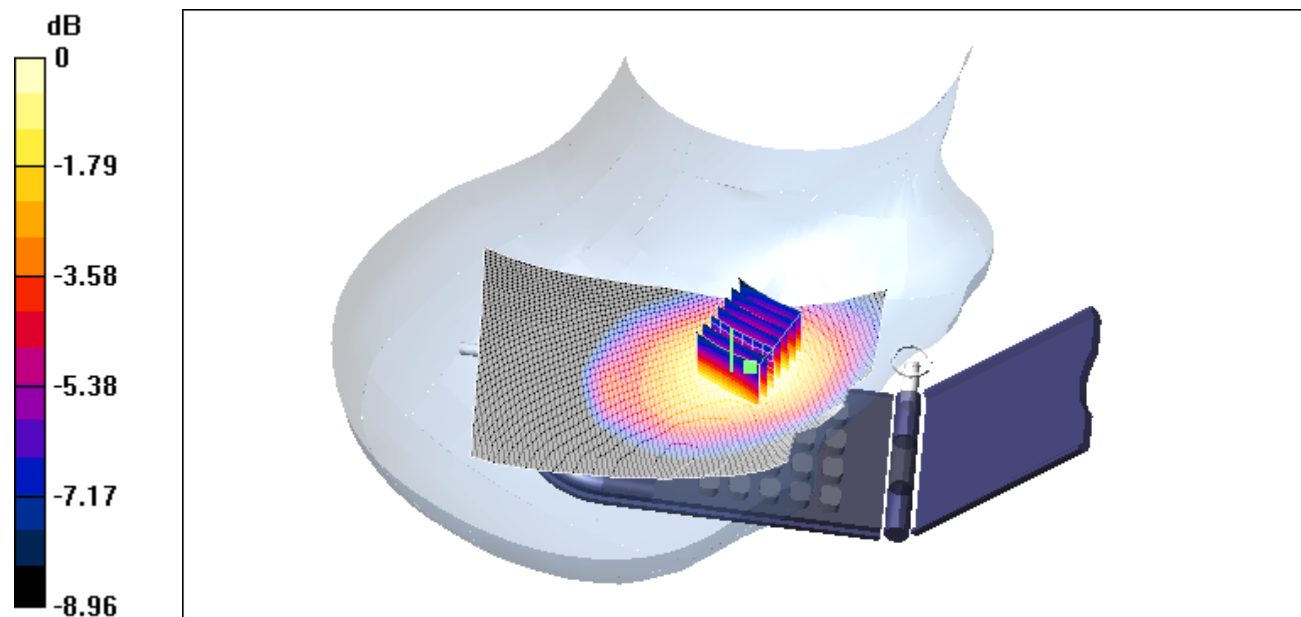

0 dB = 0.244mW/g

Test Laboratory: ELECTRONIC TECHNOLOGY SYSTEMS DR. GENZ GMBH

850_left_ch128_cheek

DUT: Triple-Band GSM 850 (E-GSM)/DCS 1800 /PCS1900 (with WAP & GPRS); Type: ---; Serial: PG-3210

Communication System: GSM 850; Frequency: 824.2 MHz; Duty Cycle: 1:8.3
Medium: Head 850 MHz Medium parameters used (interpolated): $f = 824.2$ MHz; $\sigma = 0.892$ mho/m;
 $\epsilon_r = 42.2$; $\rho = 1000$ kg/m³
Phantom section: Left Section

DASY4 Configuration:

- Probe: ET3DV6 - SN1711; ConvF(6.2, 6.2, 6.2); Calibrated: 12/16/2003
- Sensor-Surface: 4mm (Mechanical And Optical Surface Detection)
- Electronics: DAE3 Sn522; Calibrated: 1/12/2004
- Phantom: SAM 12; Type: TP-1217; Serial: QD000P40CA
- Measurement SW: DASY4, V4.4 Build 3; Postprocessing SW: SEMCAD, V1.8 Build 130

PG-3210/Area Scan (91x141x1): Measurement grid: dx=10mm, dy=10mm

Maximum value of SAR (interpolated) = 1.12 mW/g

PG-3210/Zoom Scan (7x7x7)/Cube 0: Measurement grid: dx=5mm, dy=5mm, dz=5mm

Reference Value = 7.41 V/m; Power Drift = 0.008 dB

Peak SAR (extrapolated) = 1.53 W/kg

SAR(1 g) = 1.04 mW/g; SAR(10 g) = 0.674 mW/g

Maximum value of SAR (measured) = 1.12 mW/g

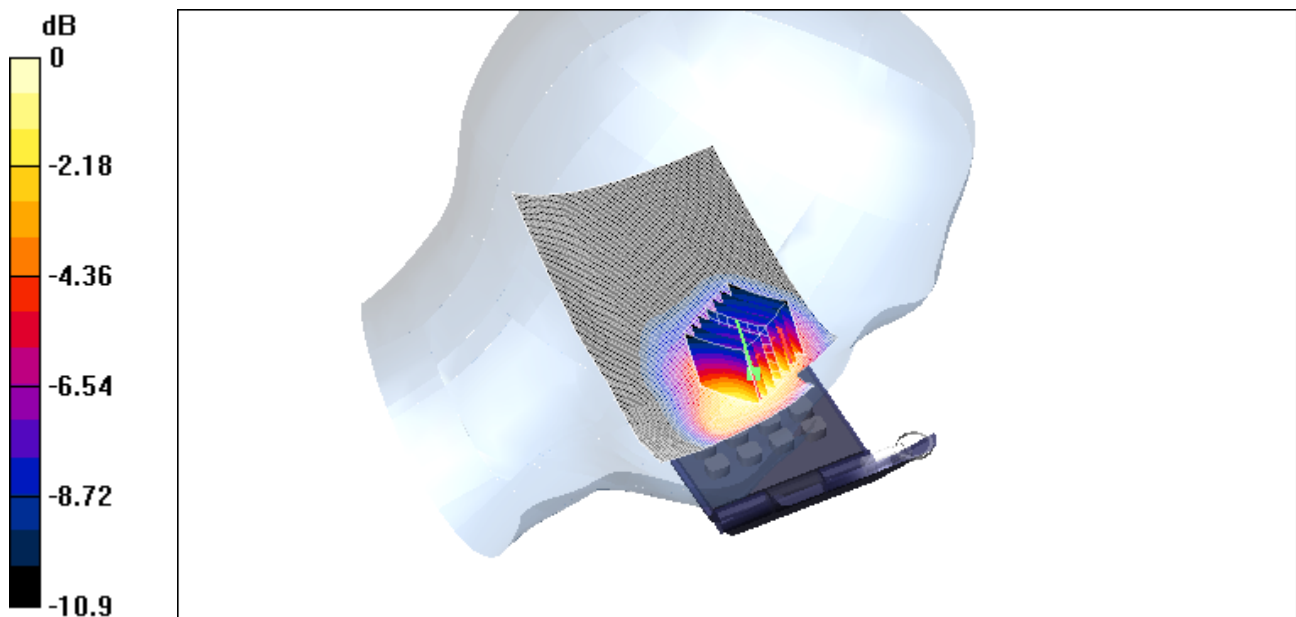

0 dB = 1.12mW/g

Test Laboratory: ELECTRONIC TECHNOLOGY SYSTEMS DR. GENZ GMBH

850_left_ch128_tilted

DUT: Triple-Band GSM 850 (E-GSM)/DCS 1800 /PCS1900 (with WAP & GPRS); Type: ---; Serial: PG-3210

Communication System: GSM 850; Frequency: 824.2 MHz; Duty Cycle: 1:8.3
Medium: Head 850 MHz Medium parameters used (interpolated): $f = 824.2$ MHz; $\sigma = 0.892$ mho/m;
 $\epsilon_r = 42.2$; $\rho = 1000$ kg/m³
Phantom section: Left Section

DASY4 Configuration:

- Probe: ET3DV6 - SN1711; ConvF(6.2, 6.2, 6.2); Calibrated: 12/16/2003
- Sensor-Surface: 4mm (Mechanical And Optical Surface Detection)
- Electronics: DAE3 Sn522; Calibrated: 1/12/2004
- Phantom: SAM 12; Type: TP-1217; Serial: QD000P40CA
- Measurement SW: DASY4, V4.4 Build 3; Postprocessing SW: SEMCAD, V1.8 Build 130

PG-3210/Area Scan (91x141x1): Measurement grid: dx=10mm, dy=10mm
Maximum value of SAR (interpolated) = 0.314 mW/g

PG-3210/Zoom Scan (7x7x7)/Cube 0: Measurement grid: dx=5mm, dy=5mm, dz=5mm
Reference Value = 10.4 V/m; Power Drift = 0.1 dB
Peak SAR (extrapolated) = 0.380 W/kg
SAR(1 g) = 0.291 mW/g; SAR(10 g) = 0.209 mW/g
Maximum value of SAR (measured) = 0.306 mW/g

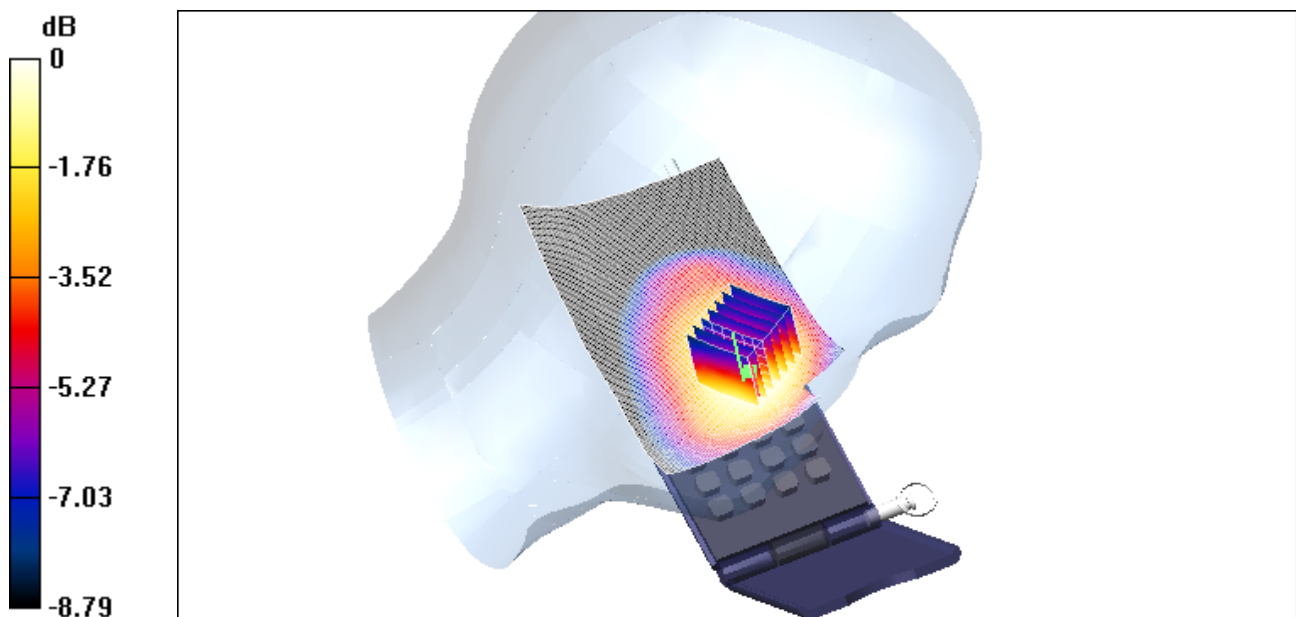

0 dB = 0.306mW/g

Test Laboratory: ELECTRONIC TECHNOLOGY SYSTEMS DR. GENZ GMBH

850_left_ch189_cheek

DUT: Triple-Band GSM 850 (E-GSM)/DCS 1800 /PCS1900 (with WAP & GPRS); Type: ---; Serial: PG-3210

Communication System: GSM 850; Frequency: 836.4 MHz; Duty Cycle: 1:8.3
Medium: Head 900 MHz Medium parameters used (interpolated): $f = 836.4$ MHz; $\sigma = 0.913$ mho/m;
 $\epsilon_r = 43.6$; $\rho = 1000$ kg/m³
Phantom section: Left Section

DASY4 Configuration:

- Probe: ET3DV6 - SN1711; ConvF(6.2, 6.2, 6.2); Calibrated: 12/16/2003
- Sensor-Surface: 4mm (Mechanical And Optical Surface Detection)
- Electronics: DAE3 Sn522; Calibrated: 1/12/2004
- Phantom: SAM 12; Type: TP-1217; Serial: QD000P40CA
- Measurement SW: DASY4, V4.4 Build 3; Postprocessing SW: SEMCAD, V1.8 Build 130

PG-3210/Area Scan (91x141x1): Measurement grid: dx=10mm, dy=10mm

Maximum value of SAR (interpolated) = 1.2 mW/g

PG-3210/Zoom Scan (7x7x7)/Cube 0: Measurement grid: dx=5mm, dy=5mm, dz=5mm

Reference Value = 8.62 V/m; Power Drift = 0.1 dB

Peak SAR (extrapolated) = 1.64 W/kg

SAR(1 g) = 1.1 mW/g; SAR(10 g) = 0.706 mW/g

Maximum value of SAR (measured) = 1.19 mW/g

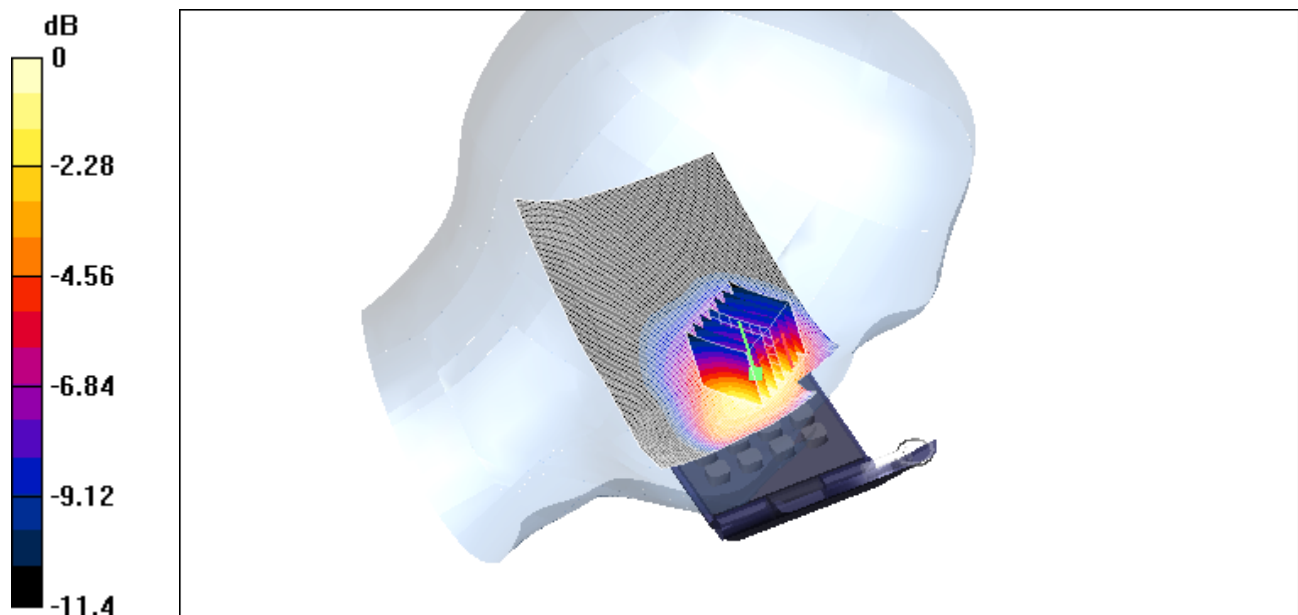

0 dB = 1.19mW/g

Test Laboratory: ELECTRONIC TECHNOLOGY SYSTEMS DR. GENZ GMBH

850_left_ch189_tilted

DUT: Triple Band GSM 850 / DCS 1800 / PCS 1900 (with WAP & GPRS); Type: ---; Serial: PG-3210

Communication System: GSM 850; Frequency: 836.4 MHz; Duty Cycle: 1:8.3

Medium: Head 850 MHz Medium parameters used (interpolated): $f = 836.4$ MHz; $\sigma = 0.883$ mho/m;

$\epsilon_r = 42.3$; $\rho = 1000$ kg/m³

Phantom section: Left Section

DASY4 Configuration:

- Probe: ET3DV6 - SN1711; ConvF(6.2, 6.2, 6.2); Calibrated: 12/16/2003
- Sensor-Surface: 4mm (Mechanical And Optical Surface Detection)
- Electronics: DAE3 Sn522; Calibrated: 1/12/2004
- Phantom: SAM 12; Type: TP-1217; Serial: QD000P40CA
- Measurement SW: DASY4, V4.4 Build 3; Postprocessing SW: SEMCAD, V1.8 Build 130

PG_3210/Area Scan (91x161x1): Measurement grid: dx=10mm, dy=10mm

Maximum value of SAR (interpolated) = 0.349 mW/g

PG_3210/Zoom Scan (7x7x7)/Cube 0: Measurement grid: dx=5mm, dy=5mm, dz=5mm

Reference Value = 13.5 V/m; Power Drift = 0.0 dB

Peak SAR (extrapolated) = 0.435 W/kg

SAR(1 g) = 0.327 mW/g; SAR(10 g) = 0.233 mW/g

Maximum value of SAR (measured) = 0.352 mW/g

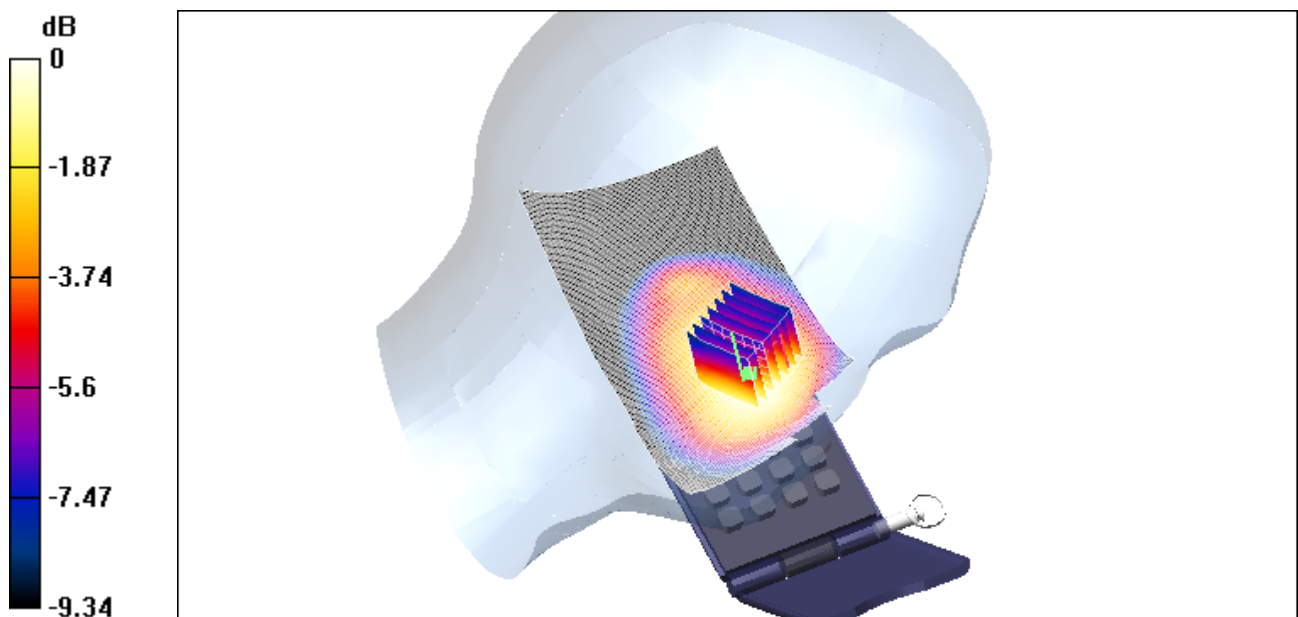

0 dB = 0.352mW/g

Test Laboratory: ELECTRONIC TECHNOLOGY SYSTEMS DR. GENZ GMBH

850_left_ch251_cheek

DUT: Triple-Band GSM 850 (E-GSM)/DCS 1800 /PCS1900 (with WAP & GPRS); Type: ---; Serial: PG-3210

Communication System: GSM 850; Frequency: 848.8 MHz; Duty Cycle: 1:8.3

Medium: Head 850 MHz Medium parameters used (interpolated): $f = 848.8$ MHz; $\sigma = 0.927$ mho/m;

$\epsilon_r = 41.8$; $\rho = 1000$ kg/m³

Phantom section: Left Section

DASY4 Configuration:

- Probe: ET3DV6 - SN1711; ConvF(6.2, 6.2, 6.2); Calibrated: 12/16/2003
- Sensor-Surface: 4mm (Mechanical And Optical Surface Detection)
- Electronics: DAE3 Sn522; Calibrated: 1/12/2004
- Phantom: SAM 12; Type: TP-1217; Serial: QD000P40CA
- Measurement SW: DASY4, V4.4 Build 3; Postprocessing SW: SEMCAD, V1.8 Build 130

PG-3210/Area Scan (91x141x1): Measurement grid: dx=10mm, dy=10mm

Maximum value of SAR (interpolated) = 1.27 mW/g

PG-3210/Zoom Scan (7x7x7)/Cube 0: Measurement grid: dx=5mm, dy=5mm, dz=5mm

Reference Value = 6.86 V/m; Power Drift = 0.1 dB

Peak SAR (extrapolated) = 1.78 W/kg

SAR(1 g) = 1.19 mW/g; SAR(10 g) = 0.754 mW/g

Maximum value of SAR (measured) = 1.27 mW/g

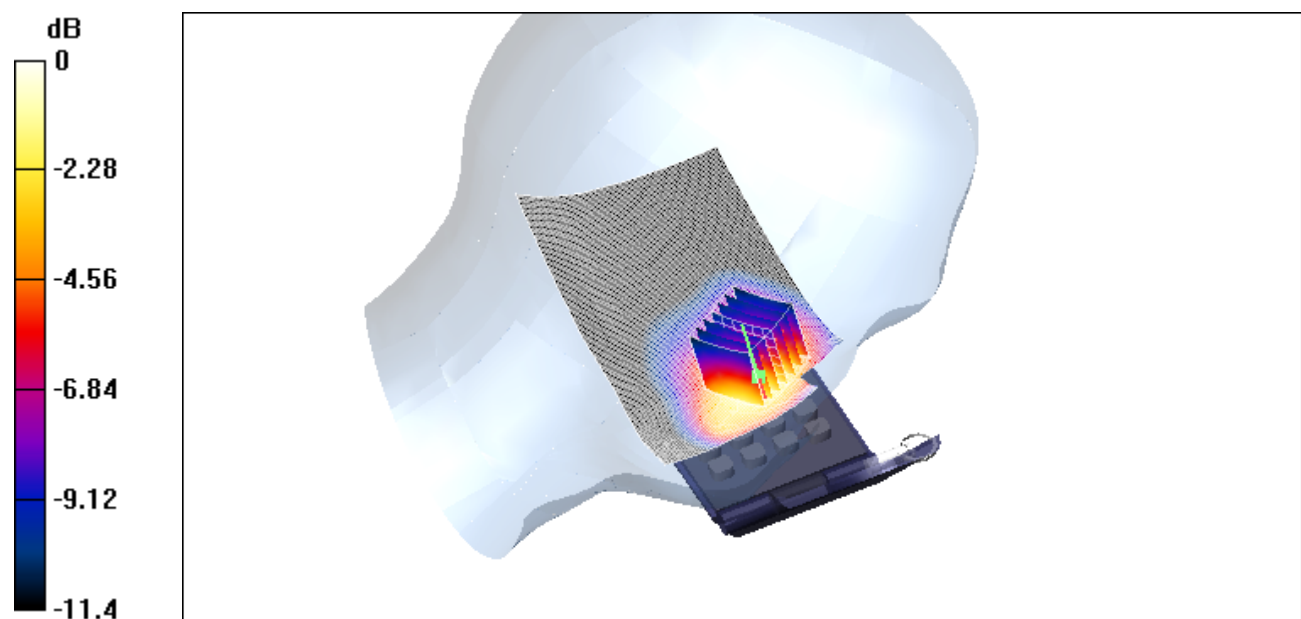

0 dB = 1.27mW/g

Test Laboratory: ELECTRONIC TECHNOLOGY SYSTEMS DR. GENZ GMBH

850_left_ch251_tilted

DUT: Triple-Band GSM 850 (E-GSM)/DCS 1800 /PCS1900 (with WAP & GPRS); Type: ---; Serial: PG-3210

Communication System: GSM 850; Frequency: 848.8 MHz; Duty Cycle: 1:8.3
Medium: Head 850 MHz Medium parameters used (interpolated): $f = 848.8$ MHz; $\sigma = 0.927$ mho/m;
 $\epsilon_r = 41.8$; $\rho = 1000$ kg/m³
Phantom section: Left Section

DASY4 Configuration:

- Probe: ET3DV6 - SN1711; ConvF(6.2, 6.2, 6.2); Calibrated: 12/16/2003
- Sensor-Surface: 4mm (Mechanical And Optical Surface Detection)
- Electronics: DAE3 Sn522; Calibrated: 1/12/2004
- Phantom: SAM 12; Type: TP-1217; Serial: QD000P40CA
- Measurement SW: DASY4, V4.4 Build 3; Postprocessing SW: SEMCAD, V1.8 Build 130

PG-3210/Area Scan (91x141x1): Measurement grid: dx=10mm, dy=10mm
Maximum value of SAR (interpolated) = 0.315 mW/g

PG-3210/Zoom Scan (7x7x7)/Cube 0: Measurement grid: dx=5mm, dy=5mm, dz=5mm
Reference Value = 11 V/m; Power Drift = -0.1 dB
Peak SAR (extrapolated) = 0.397 W/kg
SAR(1 g) = 0.296 mW/g; SAR(10 g) = 0.209 mW/g
Maximum value of SAR (measured) = 0.315 mW/g

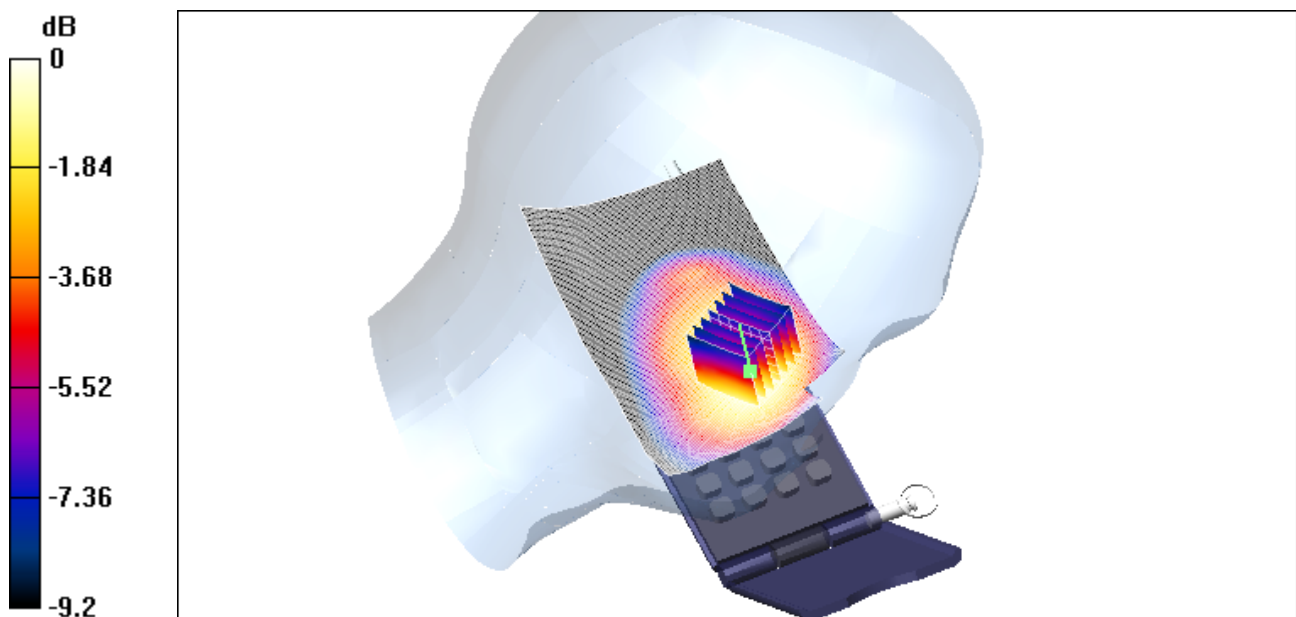

0 dB = 0.315mW/g

Test Laboratory: ELECTRONIC TECHNOLOGY SYSTEMS DR. GENZ GMBH

850_flat_front_ch189_dist15

DUT: Triple-Band GSM 850 (E-GSM)/DCS 1800 /PCS1900 (with WAP & GPRS); Type: ---; Serial: PG-3210

Communication System: GSM 850; Frequency: 836.4 MHz; Duty Cycle: 1:8.3
Medium: Muscle 850 MHz Medium parameters used (interpolated): $f = 836.4$ MHz; $\sigma = 0.975$ mho/m; $\epsilon_r = 55.1$; $\rho = 1000$ kg/m³
Phantom section: Flat Section

DASY4 Configuration:

- Probe: ET3DV6 - SN1711; ConvF(6, 6, 6); Calibrated: 12/16/2003
- Sensor-Surface: 4mm (Mechanical And Optical Surface Detection)
- Electronics: DAE3 Sn522; Calibrated: 1/12/2004
- Phantom: SAM 12; Type: TP-1217; Serial: QD000P40CA
- Measurement SW: DASY4, V4.4 Build 3; Postprocessing SW: SEMCAD, V1.8 Build 130

PG-3210/Area Scan (61x101x1): Measurement grid: dx=10mm, dy=10mm

Maximum value of SAR (interpolated) = 0.133 mW/g

PG-3210/Zoom Scan (7x7x7)/Cube 0: Measurement grid: dx=5mm, dy=5mm, dz=5mm

Reference Value = 8.49 V/m; Power Drift = -0.0 dB

Peak SAR (extrapolated) = 0.170 W/kg

SAR(1 g) = 0.125 mW/g; SAR(10 g) = 0.087 mW/g

Maximum value of SAR (measured) = 0.134 mW/g

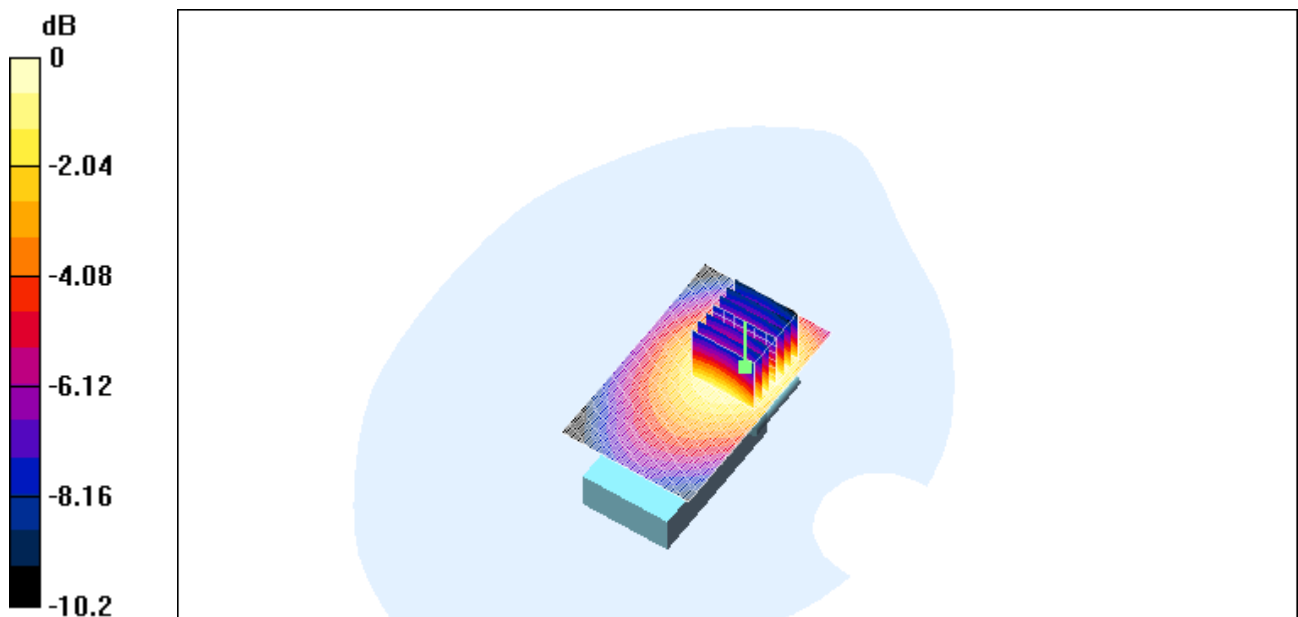

0 dB = 0.134mW/g

Test Laboratory: ELECTRONIC TECHNOLOGY SYSTEMS DR. GENZ GMBH

850_flat_back_ch189_dist15

DUT: Triple-Band GSM 850 (E-GSM)/DCS 1800 /PCS1900 (with WAP & GPRS); Type: ---; Serial: PG-3210

Communication System: GSM 850; Frequency: 836.4 MHz; Duty Cycle: 1:8.3
Medium: Muscle 850 MHz Medium parameters used (interpolated): $f = 836.4$ MHz; $\sigma = 0.975$ mho/m; $\epsilon_r = 55.1$; $\rho = 1000$ kg/m³
Phantom section: Flat Section

DASY4 Configuration:

- Probe: ET3DV6 - SN1711; ConvF(6, 6, 6); Calibrated: 12/16/2003
- Sensor-Surface: 4mm (Mechanical And Optical Surface Detection)
- Electronics: DAE3 Sn522; Calibrated: 1/12/2004
- Phantom: SAM 12; Type: TP-1217; Serial: QD000P40CA
- Measurement SW: DASY4, V4.4 Build 3; Postprocessing SW: SEMCAD, V1.8 Build 130

PG-3210/Area Scan (61x101x1): Measurement grid: dx=10mm, dy=10mm

Maximum value of SAR (interpolated) = 0.204 mW/g

PG-3210/Zoom Scan (7x7x7)/Cube 0: Measurement grid: dx=5mm, dy=5mm, dz=5mm

Reference Value = 12.1 V/m; Power Drift = -0.0 dB

Peak SAR (extrapolated) = 0.262 W/kg

SAR(1 g) = 0.188 mW/g; SAR(10 g) = 0.129 mW/g

Maximum value of SAR (measured) = 0.204 mW/g

