



HYUNDAI CALIBRATION & CERTIFICATION TECH. CO., LTD.

PRODUCT COMPLIANCE DIVISION
SAN 136-1, AMI-RI, BUBAL-EUP, ICHEON-SI, KYOUNGKI-DO, 467-701, KOREA
TEL: +82 31 639 8518 FAX: +82 31 639 8525 www.hct.co.kr



HEARING AID COMPATIBILITY CERTIFICATE

Pantech Co., Ltd.

Shinsong Bldg, 25-12, Yeouido-dong,
Youngdeungpo-Gu, Seoul, 150-711, Korea

FRN: 0008874489

Date of Issue: April 01, 2006

Test Report No.: HCT-SAR06-0318

Test Site: HYUNDAI CALIBRATION & CERTIFICATION
TECHNOLOGIES CO., LTD.

FRN: 0005866421

FCC ID: JYCPC-8200N

APPLICANT : Pantech Co., Ltd.

Application Type:	Certification
EUT Type:	Dual-Mode CDMA Phone with Bluetooth- Prototype
Tx Frequency:	824.70 — 848.31 MHz (CDMA) 1851.25 — 1908.75 MHz (PCS CDMA)
Maximum Conducted Power (HAC):	0.342W CDMA (25.3dBm) 0.342W PCS CDMA (25.3dBm)
Trade Name/Model(s):	Pantech / PC-8200N
FCC Classification:	Licensed Portable Transmitter Held to Ear (PCE)
FCC Rule Part(s):	§20.19
HAC Standard:	ANSI PC63.19-2005 D3.6

Hearing Aid Near-Field Category: M4

This wireless portable device has been shown to be compatible with hearing aids under the above rated category, specified in ANSI/IEEE Std. PC63.19 and had been tested in accordance with the specified measurement procedures. Hearing-Aid Compatibility is based on the assumption that all production units will be designed electrically identical to the device tested in this report.

I attest to the accuracy of data. All measurements reported herein were performed by me or were made under my supervision and are correct to the best of my knowledge and belief. I assume full responsibility for the completeness of these measurements and vouch for the qualifications of all persons taking them.

Hyundai C-Tech Co., Ltd. Certifies that no party to this application has been denied FCC benefits pursuant to section 5301 of the Anti-Drug Abuse Act of 1998, 21 U.S. C. 853(a)

Report prepared by: Ki-Soo Kim

Manager of Product Compliance Team



Table of Contents

1. APLICANT / EUT DESCRIPTION -----	3
2. HAC MEASUREMENT SET- UP -----	4
3. SYSTEM SPECIFICATIONS -----	5-6
4. EUT ARRANGEMENT -----	7
5. TEST SETUP PHOTOGRAPHS -----	8
6. SYSTEM VALIDATION -----	9-10
7. PROBE MODULATION FACTOR -----	11-12
8. TEST PROCEDURE -----	13-14
9. ANSI-PC 63.19-2001 LIMITS -----	15
10. MEASUREMENT UNCERTAINTIES -----	16-17
11. HAC TEST DATA SUMMARY -----	18-19
12. HAC TEST EQUIPMENT LIST -----	20
13. CONCLUSION -----	21
APPENDIX A – HAC TEST PLOTS	
APPENDIX B – DIPOLE VALIDATION PLOTS	
APPENDIX C – PROBE MODULATION FACTOR	
APPENDIX D – PROBE CALIBRATION DATA	
APPENDIX E – DIPOLE CALIBRATION DATA	

HAC MEASUREMENT REPORT

1. APPLICANT / EUT DESCRIPTION

1.1 Applicant

- Company Name: Pantech Co., Ltd.
- Address: Shinsong Bldg, 25-12, Yeouido-dong, Youngdeungpo-Gu, Seoul, 150-711, Korea
- Attention: Mr. IN TAE LEE
- Tel. / Fax: 82 02 3660 5896/ 82 02 3660 5828
- E-Mail : lit@pantech.com

1.2 EUT Description

- EUT Type: Dual-Mode CDMA Phone with Bluetooth- Prototype
- Trade Name: Pantech
- Model(s): PC-8200N
- FCC ID: JYCPC-8200N
- Serial Number(s): JYCPC-8200N-1
- Tx Frequency: 824.70 — 848.31 MHz (CDMA)
1851.25 — 1908.75 MHz (PCS CDMA)
- FCC Classification: Licensed Portable Transmitter Held to Ear (PCE)
- FCC Rule Part(s): §20.19
- Modulation(s): CDMA/ PCS CDMA
- Antenna Type: Retractable (Retracted/Extended)
- Date(s) of Tests: March 31, 2006
- Place of Tests: Hyundai C-Tech. EMC Lab.
Icheon, Kyoungki-Do, KOREA
- Report Serial No.: HCT-SAR06-0318
- Max E-Field Emission: channel 384, 836.52 MHz= 60.9 V/m (M4)
- Max H-Field Emission: channel 1013, 824.70 MHz= 0.106 A/m (M4)

2. HAC MEASUREMENT SET-UP

These measurements are performed using the DASY4 automated dosimetric assessment system. It is made by Schmid & Partner Engineering AG (SPEAG) in Zurich, Switzerland. It consists of high precision robotics system (Staubli), robot controller, Pentium IV computer, near-field probe, probe alignment sensor. The robot is a six-axis industrial robot performing precise movements.

A cell controller system contains the power supply, robot controller, teach pendant (Joystick), and remote control, is used to drive the robot motors. The PC consists of the HP Pentium IV 3.0 GHz computer with Windows XP system and HAC Measurement Software DASY4, A/D interface card, monitor, mouse, and keyboard. The Staubli Robot is connected to the cell controller to allow software manipulation of the robot. A data acquisition electronic (DAE) circuit performs the signal amplification, signal multiplexing, AD-conversion, offset measurements, mechanical surface detection, collision detection, etc. is connected to the Electro-optical coupler (EOC). The EOC performs the conversion from the optical into digital electric signal of the DAE and transfers data to the PC plug-in card.

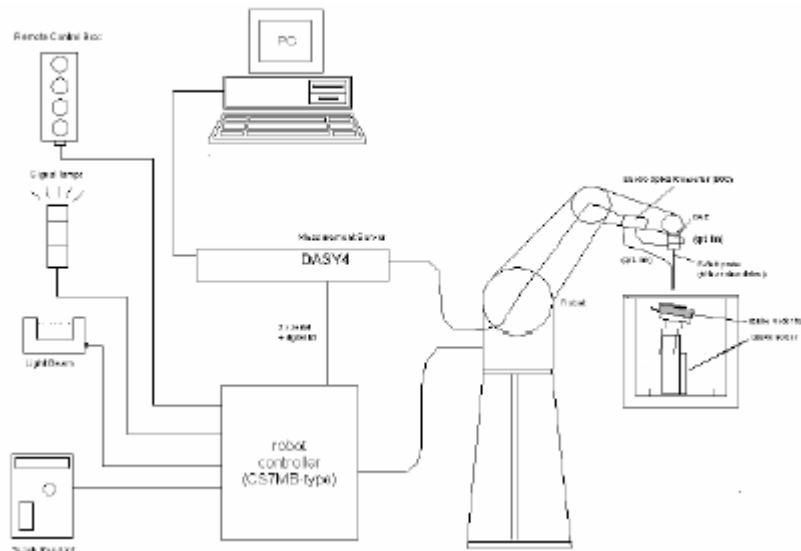



Figure 1. HAC Test Measurement Set-up

The DAE4 consists of a highly sensitive electrometer-grade preamplifier with auto-zeroing, a channel and gain-switching multiplexer, a fast 16 bit AD-converter and a command decoder and control logic unit. Transmission to the PC-card is accomplished through an optical downlink for data and status information and an optical uplink for commands and clock lines. The mechanical probe mounting device includes two different sensor systems for frontal and sidewise probe contacts. They are also used for mechanical surface detection and probe collision detection. The robot uses its own controller with a built in VME-bus computer.

3. SYSTEM SPECIFICATIONS

3.1 Probe

3.1.1 E-Field Probe Description

Construction	One dipole parallel, two dipoles normal to probe axis Built-in shielding against static charges	 <p>[E-Field Probe]</p>
Calibration	In air from 100 MHz to 3.0 GHz (absolute accuracy $\pm 6.0\%$, $k=2$)	
Frequency	100 MHz to > 6 GHz; Linearity: $\pm 0.2\text{dB}$ (100 MHz to 3 GHz)	
Directivity	± 0.2 dB in air (rotation around probe axis) ± 0.4 dB in air (rotation normal to probe axis)	
Dynamic Range	2 V/m to > 1000 V/m (M3 or better device readings fall well below diode compression point)	
Linearity	± 0.2 dB	
Dimensions	Overall length: 330 mm (Tip: 16mm) Tip diameter: 8 mm (Body: 12 mm) Distance from probe tip to dipole centers: 2.5 mm	

3.1.2 H-Field Probe Description

Construction	Three concentric loop sensors with 3.8 mm loop diameters resistively loaded detector diodes for linear response Built-in shielding against static charges PEEK enclosure material (resistant to organic solvents, e.g., glycoether)	 <p>[H-Field Probe]</p>
Frequency	200 MHz to > 3 GHz (absolute accuracy $\pm 6.0\%$, $k=2$); Output linearized	
Directivity	± 0.25 dB (spherical isotropy error)	
Dynamic Range	10 mA/m to 2 A/m at 1 GHz	
E-Field Interference	< 10% at 3 GHz (for plane wave)	
Dimensions	Overall length: 330 mm (Tip: 40mm) Tip diameter: 6 mm (Body: 12 mm) Distance from probe tip to dipole centers: 3 mm The closest part of the sensor element is 1.9 mm closer to the tip	

3.2 Phantom & Device Holder

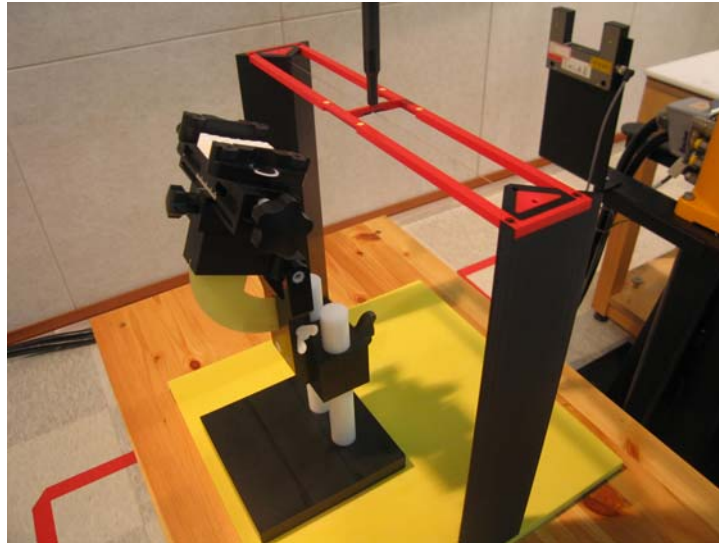

Figure 2. HAC Phantom & Device Holder

The Test Arch phantom should be positioned horizontally on a stable surface. Reference markings on the Phantom allow the complete setup of all predefined phantom positions and measurement grids by manually teaching three points in the robot.

The devices can be easily, accurately, and repeatably positioned according to the FCC specifications.

3.3 Robotic System Specifications

Specifications

POSITIONER:	Stäubli Unimation Corp. Robot Model: RX90LB
Repeatability:	0.02 mm
No. of axis:	6
Data Acquisition Electronic (DAE) System	
Cell Controller	
Processor:	Pentium IV
Clock Speed:	3.0 GHz
Operating System:	Windows XP
Data Card:	DASY4 PC-Board
Data Converter	
Features:	Signal Amplifier, multiplexer, A/D converter, and control logic
Software:	DASY4 software
Connecting Lines:	Optical downlink for data and status info. Optical uplink for commands and clock
PC Interface Card	
Function:	24 bit (64 MHz) DSP for real time processing Link to DAE3 16 bit A/D converter for surface detection system serial link to robot direct emergency stop output for robot

4. EUT ARRANGEMENT

4.1 WD RF Emission Measurements Reference and Plane

Figure 3. Illustrate the references and reference plane that shall be used in the WD emissions measurement.

- The grid is 5 cm by 5 cm area that is divided into 9 evenly sized blocks or sub-grids.
- The grid is centered on the audio frequency output transducer of the WD (speaker or T-coil).
- The grid is in a reference plane, which is defined as the planar area that contains the highest point in the area of the phone that normally rests against the user's ear. It is parallel to the centerline of the receiver area of the phone and is defined by the points of the receiver-end of the WD handset, which, in normal handset use, rest against the ear.
- The measurement plane is parallel to, and 1.0 cm in front of, the reference plane.



Figure 3. WD reference and plane for RF emission measurements

5. TEST SET-UP PHOTOGRAPHS

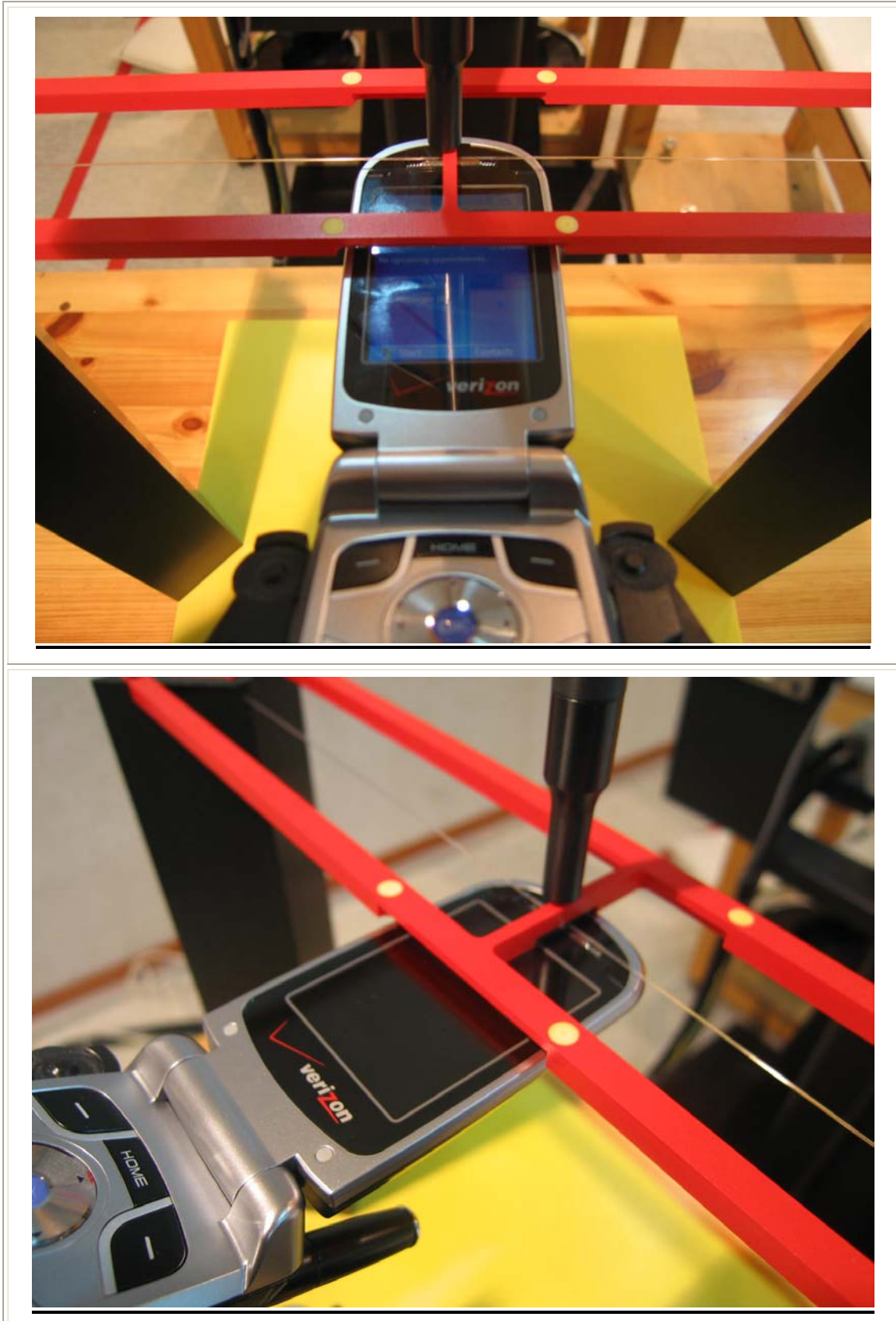

Figure 4. Test Set-up Photo

6. SYSTEM VALIDATION

The test setup was validated when confabulated and verified periodically thereafter to ensure proper function. The procedure is a validation procedure using dipole antennas for which the field levels were computed by FDTD modeling.

6.1 Validation Procedure

Place a dipole antenna meeting the requirements given in ANSI-PC63.19 in the position normally occupied by the WD. The dipole antenna serves as a known source for an electrical and magnetic output. Position the E-field and H-field probes so that:

- the probes and their cables are parallel to the coaxial feed of the dipole antenna
- the probe cables and the coaxial feed of the dipole antenna approach the measurement area from opposite directions; and
- the probes are 10 mm from the surface of the dipole elements.

Scan the length of the dipole with both E-field and H-field probes and record the maximum values for each. Compare the readings to expected values.

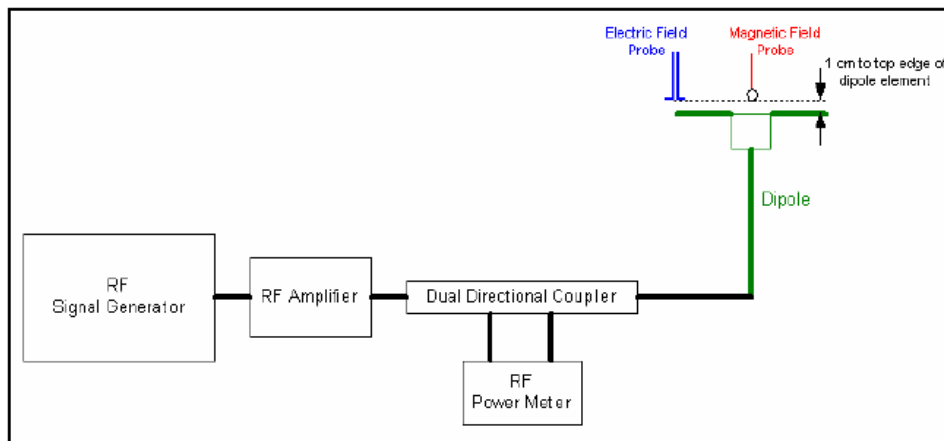

Figure 5. WD dipole calibration procedure

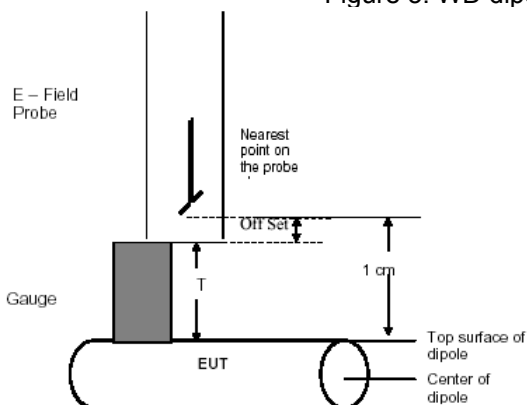

Figure 6. Gauge Block with E-Field Probe

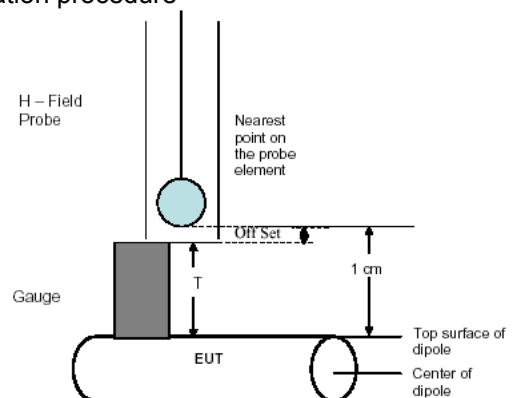

Figure 7. Gauge Block with H-Field Probe

6.2 Validation Result

6.2.1 E-Field Scan

Mode	Freq. [MHz]	Input Power (dBm)	Measured Value (V/m)	Target Value (V/m) SPEAG	Deviation [%]	Limit [%]
CW	835	20	169.8	163.3	+3.98	±25
CW	1880	20	137.8	138.9	-0.79	±25

6.2.2 H-Field Scan

Mode	Freq. [MHz]	Input Power (dBm)	Measured Value (A/m)	Target Value (A/m) SPEAG	Deviation [%]	Limit [%]
CW	835	20	0.459	0.453	+1.32	±25
CW	1880	20	0.465	0.462	+0.65	±25

Notes:

- 1) Deviation (%) = $100 * (\text{Measured value minus Target value}) / \text{Target value}$.
ANSI-PC63.19 requires values to be within 25% of their targets. 12% is deviation and 13% is measurement uncertainty.
- 2) The maximum E-field or H-field were evaluated and compared to the target values provided by SPEAD in the calibration certificate of specific dipoles.
- 3) Please refer to the attachment for detailed measurement data and plot.

7. Probe Modulation Factor

The Probe Modulation Factor (PMF) is defined as the ratio of the field readings for a CW and a modulated signal with the equivalent Field Envelope Peak as defined in the Standard (Chapter C.3.1).

Calibration shall be made of the modulation response of the probe and its instrumentation chain. This Calibration shall be performed with the field probe, attached to the instrumentation that is to be used with it during the measurement. The response of the probe system to a CW field at the frequency(s) of interest is compared to its response to a modulated signal with equal peak amplitude. The field level of the test signals shall be more than 10dB above the ambient level and the noise floor of the instrumentation being used. The ratio of the CW reading to that taken with a modulated field shall be applied to the readings taken of modulated fields of the specified type.

7.1 Modulation Factor Test Procedure

This may be done using the following procedure:

1. Fixing the probe in a set location relative to a field generating device, such as a reference dipole antenna or
2. Illuminate the probe with a CW signal at the intended measurement frequency.
3. Record the reading of the probe measurement system of the CW signal.
4. Determine the level of the CW signal being used to drive the field generating device.
5. Substitute a signal using the same modulation as that used by the intended WD for the CW signal.
6. Set the amplitude during transmission of the modulated signal to equal the amplitude of the CW signal.
7. Record the reading of the probe measurement system of the modulated signal.
8. Calculate the Probe Modulation Factor as the ratio between the CW multimeter field readings and the reading for the applicable modulation. $PMF = CW/WD_CDMA$

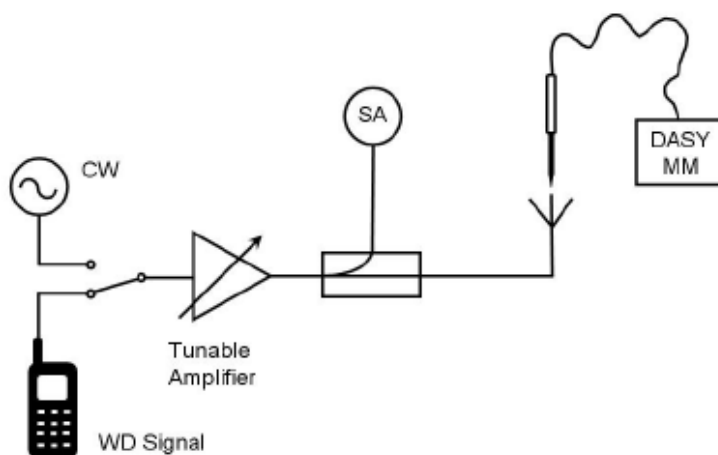

Figure 8. Probe modulation Setup Photo

7.2 Modulation Factor

7.2.1 E-Field

Mode	Freq. [MHz]	Input Power (dB)	E-Field measured value (V/m)	Probe Modulation Factor
80% AM	835	20	105.2	1.61
CDMA		20	170.0	1.00
80% AM	1880	20	81.4	1.69
CDMA		20	139.6	0.99

7.2.2 H-Field

Mode	Freq. [MHz]	Input Power (dB)	H-Field measured value (A/m)	Probe Modulation Factor
80% AM	835	20	0.298	1.54
CDMA		20	0.453	1.01
80% AM	1880	20	0.307	1.51
CDMA		20	0.475	0.98

Notes:

- 1) Modulation Factor = CW / WD_CDMA

8. TEST PROCEDURE

Test Instructions

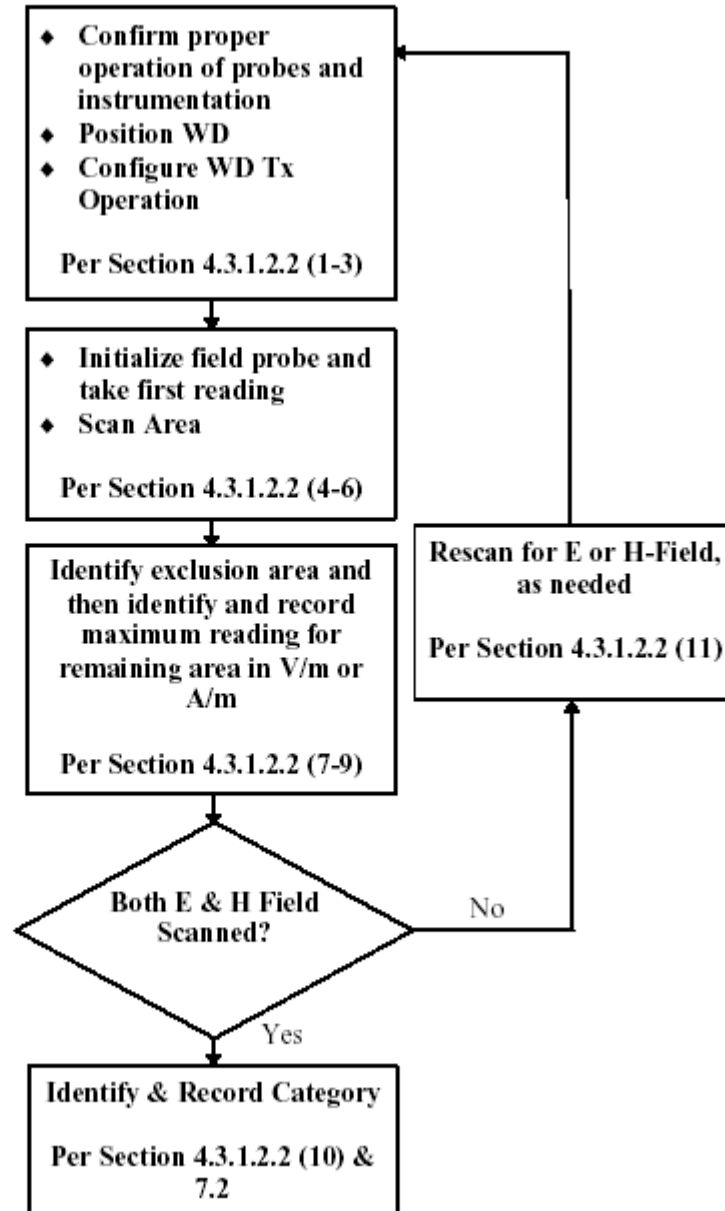

Figure 9. WD near-field emission automated test flowchart

The evaluation was performed with the following procedure:

1. Confirm proper operation of the field probe, probe measurement system and other instrumentation and the positioning system.
2. Position the WD in its intended test position. The gauge block, depicted in Section A.2.1, can simplify this positioning. Note that a separate E- and H-field gauge block will be needed if the edges of the probe sensors are at different distances from the tip of the probe.
3. Configure the WD normal operation for maximum rated RF output power, at the desired channel and other operating parameters, (e.g. test mode) as intended for the test.
4. The center sub-grid shall be centered on the center of the WD output (acoustic or T-Coil output), as appropriate. Locate the field probe at the initial test position in the 5 x 5 cm grid, which is contained in the measurement plane.
5. Record the reading.
6. Scan the entire 5 x 5 cm region in equally spaced increments and record the reading at each measurement point. The distance between measurement points shall be sufficient to assure the identification of the peak reading.
7. Identify the five contiguous sub-grids around the center sub-grid with the lowest maximum field strength readings. Thus the 6 areas to be used to determine the WD's peak emissions are identified and outlined for the final manual scan. Please note that a maximum of five blocks can be excluded for both E- and H-field measurements for the WD output being measured. State another way, the center sub-grid and 3 other must be common to both the E- and H-field measurements.
8. Identify the highest field reading within the non-excluded sub-grids identified in step 7.
9. Convert the highest field strength reading identified in step 8 to peak V/m or A/m, as appropriate. This conversion shall be done using the appropriate probe modulation factor.
10. Repeat steps 1-10 for both the E- and H-field measurements.
11. Compare this reading to the categories in ANSI-PC63.19 and record the resulting category. The lowest category number listed in ANSI-PC63.19, obtained in step 10 for either E or H field determines the M category for the audio coupling mode assessment. Record the WD category rating.

9. ANSI-PC 63.19-2001 LIMITS

The EUT must meet the following M3 or M4 category:

Category	AWF (dB)	Limits for E-Field Emissions(V/m)	Limits for H-Field Emissions(V/m)
M1	0	199.5 - 354.8	0.6 - 1.07
	-5	149.6 - 266.1	0.45 - 0.8
M2	0	112.2 - 199.5	0.34 - 0.6
	-5	84.1 - 149.6	0.25 - 0.45
M3	0	63.1 - 112.2	0.19 - 0.34
	-5	47.3 - 84.1	0.15 - 0.25
M4	0	< 63.1	< 0.19
	-5	< 47.3	< 0.15

Table 1. Telephone near-field categories in linear units

10. MEASUREMENT UNCERTAINTIES

HAC-Extension Setup Performance Test Using SPEAG Calibration Dipoles							
Error Description	Uncertainty Value $\pm\%$	Probability Distribution	Divisor	(Ci) E	(Ci) H	Std. Unc. E	Std. Unc. H
Measurement System							
Probe calibration	± 5.1	N	1	1	1	± 5.1	± 5.1
Axial isotropy	± 4.7	R	$\sqrt{3}$	1	1	± 2.7	± 2.7
Sensor Displacement	± 16.5	R	$\sqrt{3}$	1	0.145	± 9.5	± 1.4
Boundary effects	± 2.4	R	$\sqrt{3}$	1	1	± 1.4	± 1.4
Linearity	± 4.7	R	$\sqrt{3}$	1	1	± 2.7	± 2.7
Scaling to Peak Envelope Power	± 0	R	$\sqrt{3}$	1	1	± 0	± 0
System Detection Limit	± 1	R	$\sqrt{3}$	1	1	± 0.6	± 0.6
Readout electronics	± 0.3	N	1	1	1	± 0.3	± 0.3
Response time	± 0	R	$\sqrt{3}$	1	1	± 0	± 0
Integration time	± 0	R	$\sqrt{3}$	1	1	± 0	± 0
RF ambient conditions	± 3.0	R	$\sqrt{3}$	1	1	± 1.7	± 1.7
RF Reflections	± 6.0	R	$\sqrt{3}$	1	1	± 3.5	± 3.5
Probe Positioner	± 1.2	R	$\sqrt{3}$	1	0.67	± 0.7	± 0.7
Probe positioning	± 4.7	R	$\sqrt{3}$	1	0.67	± 2.7	± 1.8
Extrap. and integration	± 1.0	R	$\sqrt{3}$	1	1	± 0.6	± 0.6
Dipole Related							
Distance Dipole-Scanning Plane	± 5.2	R	$\sqrt{3}$	1	0.3	± 3.0	± 0.9
Input power	± 4.7	N	1	1	1	± 4.7	± 4.7
Combined Standard Uncertainty						± 13.7	± 9.3
Expanded Std. Uncertainty on Power						$\pm 27.4\%$	$\pm 18.6\%$
Expanded Std. Uncertainty on Field						$\pm 13.7\%$	$\pm 9.3\%$

Table 2. Breakdown of Errors

Notes:

Uncertainty budget for HAC setup performance test. The budget is valid for the Frequency range 800MHz-3GHz and represents a worst-case analysis with respect to power uncertainty of the field. Some of the parameters are dependent on the user situations and need adjustment according to the actual laboratory conditions.

HAC Uncertainty Budget							
According to ANSI C63.19 [1]							
Error Description	Uncertainty Value $\pm\%$	Probability Distribution	Divisor	(Ci) E	(Ci) H	Std. Unc. E	Std. Unc. H
Measurement System							
Probe calibration	± 5.1	N	1	1	1	± 5.1	± 5.1
Axial isotropy	± 4.7	R	$\sqrt{3}$	1	1	± 2.7	± 2.7
Sensor Displacement	± 16.5	R	$\sqrt{3}$	1	0.145	± 9.5	± 1.4
Boundary effects	± 2.4	R	$\sqrt{3}$	1	1	± 1.4	± 1.4
Linearity	± 4.7	R	$\sqrt{3}$	1	1	± 2.7	± 2.7
Scaling to Peak Envelope Power	± 2.0	R	$\sqrt{3}$	1	1	± 1.2	± 1.2
System Detection Limit	± 1.0	R	$\sqrt{3}$	1	1	± 0.6	± 0.6
Readout electronics	± 0.3	N	1	1	1	± 0.3	± 0.3
Response time	± 0.8	R	$\sqrt{3}$	1	1	± 0.5	± 0.5
Integration time	± 2.6	R	$\sqrt{3}$	1	1	± 1.5	± 1.5
RF ambient conditions	± 3.0	R	$\sqrt{3}$	1	1	± 1.7	± 1.7
RF Reflections	± 12.0	R	$\sqrt{3}$	1	1	± 6.9	± 6.9
Probe Positioner	± 1.2	R	$\sqrt{3}$	1	0.67	± 0.7	± 0.5
Probe positioning	± 4.7	R	$\sqrt{3}$	1	0.67	± 2.7	± 1.8
Extrap. and Interpolation	± 1.0	R	$\sqrt{3}$	1	1	± 0.6	± 0.6
Test Sample Related							
Device Positioning Vertical	± 4.7	R	$\sqrt{3}$	1	1	± 2.7	± 1.8
Device Positioning Lateral	± 1.0	R	$\sqrt{3}$	1	1	± 0.6	± 0.6
Device Holder and Phantom	± 2.4	R	$\sqrt{3}$	1	1	± 1.4	± 1.4
Power Drift	± 5.0	R	$\sqrt{3}$	1	1	± 2.9	± 2.9
Phantom and Setup Related							
Phantom Thickness	± 2.4	R	$\sqrt{3}$	1	0.67	± 1.4	± 0.89
Combined Standard Uncertainty						± 14.7	± 10.9
Expanded Std. Uncertainty on Power						$\pm 29.4\%$	$\pm 21.8\%$
Expanded Std. Uncertainty on Field						$\pm 14.7\%$	$\pm 10.9\%$

Table 3. Breakdown of Errors
Notes:

Worst-Case uncertainty budget for HAC free field assessment according to ANSI-C 63.19[1]. The budget is valid for the frequency range 800MHz-3GHz and represents a worst-Case analysis. For specific test sand configurations, the uncertainty could be considerably smaller. Some of the parameters are dependent on the user situations and need adjustment according to the actual laboratory conditions.

11. HAC TEST DATA SUMMARY

Ambient TEMPERATURE (°C): 21.5
S/N: JYCPC-8200N-1

11.1 Measurement Results (E-Field CDMA, PCS DATA)

Frequency		Modulation	Conducted Power (dBm)	Power drift (dB)	AWF	Ant. Position	Measured Value (V/m)	Category
MHz	Chan.							
824.70	1013	CDMA	25.3	-0.050	0	In	52.7	M4
	(Low)	CDMA	25.3	-0.007	0	Out	58.9	M4
836.52	0384	CDMA	25.3	0.184	0	In	60.9	M4
	(Middle)	CDMA	25.3	0.181	0	Out	51.9	M4
848.31	0777	CDMA	25.3	-0.151	0	In	56.8	M4
	(High)	CDMA	25.3	-0.073	0	Out	55.9	M4
1851.25	0025	PCS	25.3	-0.082	0	In	43.3	M4
	(Low)	PCS	25.3	-0.117	0	Out	43.7	M4
1880.00	0600	PCS	25.3	-0.077	0	In	36.8	M4
	(Middle)	PCS	25.3	-0.057	0	Out	33.9	M4
1908.75	1175	PCS	25.3	-0.067	0	In	42.5	M4
	(High)	PCS	25.3	-0.114	0	Out	37.8	M4
Overall M-Rating								M4

NOTES:

- All modes of operation were investigated and the worst-case are reported.
- Battery Type Standard Extended Fixed
- Power Measured Conducted EIRP ERP
- Test Signal Call Mode Manual Test cord Base Station Simulator
- SAR Measurement System SPEAG

11. HAC TEST DATA SUMMARY

Ambient TEMPERATURE (°C): 21.5

S/N: JYCPC-8200N-1

11.2 Measurement Results (H-Field CDMA, PCS DATA)

Frequency		Modulation	Conducted Power (dBm)	Power drift (dB)	AWF	Ant. Position	Measured Value (V/m)	Category
MHz	Chan.							
824.70	1013 (Low)	CDMA	25.3	-0.016	0	In	0.083	M4
		CDMA	25.3	0.023	0	Out	0.108	M4
836.52	0384 (Middle)	CDMA	25.3	0.160	0	In	0.098	M4
		CDMA	25.3	-0.003	0	Out	0.097	M4
848.31	0777 (High)	CDMA	25.3	-0.145	0	In	0.104	M4
		CDMA	25.3	-0.023	0	Out	0.115	M4
1851.25	0025 (Low)	PCS	25.3	0.087	0	In	0.095	M4
		PCS	25.3	0.023	0	Out	0.075	M4
1880.00	0600 (Middle)	PCS	25.3	0.073	0	In	0.097	M4
		PCS	25.3	0.144	0	Out	0.061	M4
1908.75	1175 (High)	PCS	25.3	-0.069	0	In	0.090	M4
		PCS	25.3	-0.199	0	Out	0.061	M4
Overall M-Rating								M4

NOTES:

1. All modes of operation were investigated and the worst-case are reported.
2. Battery Type Standard Extended Fixed
3. Power Measured Conducted EIRP ERP
4. Test Signal Call Mode Manual Test cord Base Station Simulator
5. SAR Measurement System SPEAG

12. HAC TEST EQUIPMENT LIST

Type / Model	Calib. Date	S/N
Staubli Robot RX90L	N/A	F01/ 5K09A1/A/01
Staubli Robot ControllerCS7MB	N/A	F99/5A82A1/C/01
Staubli Teach Pendant (Joystick)	N/A	D221340.01
Dell OptiPlex GX100	N/A	HY4640
Windows NT 4.0	N/A	-
SPEAG DAE3V1	May 05	446
SPEAG DAE3V1	June 05	447
SPEAG E-Field Probe	March 06	2343
SPEAG E-Field Probe	July 05	6101
SPEAG HAC Phantom	N/A	-
SPEAG Light Alignment Sensor	N/A	265
SPEAG Validation Dipole D835V2	March 06	1024
SPEAG Validation Dipole D1880V2	March 06	1019
Phone Holder	N/A	-
A/B Power Indicator	N/A	-
Remote Power Switch	N/A	-

NOTE:

The E-field, H-field probe was calibrated by SPEAG. Dipole Validation measurement is performed by HCT Lab. before each test. The following list of equipment was used to :

Power Meter(A)	E4419B	June 05	MY40511244
Power Sensor(A)	8481	June 05	MY41090680
Signal Generator	8664A (100kHz ~ 3GHz)	April 06	3744A02069
Power Amp	A0825-4343-R	Sep. 05	A00450
Dual Directional Coupler	778D	August 05	16072
Power divider	1506A	Jan. 06	MD793
Base Station Simulator	E5515C	May 05	US41070189

13. CONCLUSION

The HAC measurement indicates that the EUT complies with the HAC limits of the ANSI-PC63.19-2001.

These measurements are taken to simulate the RF effects exposure under worst-case conditions. Precise Laboratory measures were taken to assure repeatability of the tests.