

HCT CO., LTD.



SAN 136-1, AMI-RI, BUBAL-EUP, ICHEON-SI, KYOUNGKI-DO, 467-701, KOREA

TEL: +82 31 639 8565 FAX: +82 31 639 8525 www.hct.co.kr

HAC RF Emission TEST REPORT

Pantech Co., Ltd.

Pantech Building, I-2, DMC,
Sangam-dong, Mapo-gu, Seoul, Korea
(ZIP : 121-792)

Date of Issue: Oct.26, 2009

Test Report No.: HCTA0910FM01

Test Site: HCT CO., LTD.

FCC ID: JYCP7040

APPLICANT: Pantech Co., Ltd.

EUT Type: Dual-Band Dual-Mode GSM/WCDMA Phone with Bluetooth
GPRS Class 10 and GPRS mode class B(GPRS and GSM, but not simultaneously)

Tx Frequency: 824.20 - 848.80 MHz (GSM850)
1 850.20 -1 909.80 MHz (GSM1900)
826.4 - 846.6 MHz (WCDMA850)
1 852.4 – 1 907.6 MHz (WCDMA1900)

Maximum Conducted Power (HAC): GSM850 (32.5 dBm), GSM1900 (30 dBm)
WCDMA850 (24.0 dBm), WCDMA1900 (24.0 dBm)

Trade Name/Model(s): Pantech / P7040

FCC Classification: Licensed Portable Transmitter Held to Ear (PCE)

FCC Rule Part(s): §20.19

HAC Standard: ANSI C63.19-2007

Hearing Aid Near-Field Category: M3

This wireless portable device has been shown to be hearing-aid compatible under the above rated category, specified in ANSI/IEEE Std. C63.19-2007 and had been tested in accordance with the specified measurement procedures. Hearing-Aid Compatibility is based on the assumption that all production units will be designed electrically identical to the device tested in this report.

I attest to the accuracy of data. All measurements reported herein were performed by me or were made under my supervision and are correct to the best of my knowledge and belief. I assume full responsibility for the completeness of these measurements and vouch for the qualifications of all persons taking them.

HCT Co., Ltd. Certifies that no party to this application has been denied FCC benefits pursuant to section 5301 of the Anti- Drug Abuse Act of 1998, 21 U.S. C. 862.

Report prepared by

: Sun-Hee Kim

Test Engineer of SAR Part

Approved by

: Jae-Sang So

Manager of SAR Part

Table of Contents

| | |
|--|----|
| 1. APPLICANT / EUT DESCRIPTION ----- | 3 |
| 2. HAC MEASUREMENT SET- UP ----- | 4 |
| 3. SYSTEM SPECIFICATIONS ----- | 5 |
| 4. EUT ARRANGEMENT ----- | 7 |
| 5. SYSTEM VALIDATION ----- | 8 |
| 6. PROBE MODULATION FACTOR ----- | 10 |
| 7. FCC 3G MEASUREMENTS – MAY / JUNE 2006 ----- | 15 |
| 8. TEST PROCEDURE ----- | 17 |
| 9. ANSI/IEEE C63.19 PERFORMANCE CATEGORIES ----- | 19 |
| 10. MEASUREMENT UNCERTAINTIES ----- | 20 |
| 11. HAC TEST DATA SUMMARY ----- | 22 |
| 12. HAC TEST EQUIPMENT LIST ----- | 27 |
| 13. CONCLUSION ----- | 28 |

Appendix A_HAC TEST PLOTS

Appendix B_TEST SET-UP PHOTO

Appendix C_DIPOLE VALIDATION PLOTS

Appendix D_PROBE CALIBRATION DATA

Appendix E_DIPOLE CALIBRATION DATA

HAC MEASUREMENT REPORT

1. APPLICANT / EUT DESCRIPTION

1.1 Applicant

- Company Name: Pantech Co., Ltd.
- Attention: Pantech Building, I-2, DMC,
Sangam-dong, Mapo-gu, Seoul, Korea (ZIP : 121-792)
- Tel. / Fax : +82-2-2030-1363 / +82-2-2030-2519

1.2 EUT Description

- EUT Type: Dual-Band Dual-Mode GSM/WCDMA Phone with Bluetooth
GPRS Class 10 and GPRS mode class B(GPRS and GSM, but not simultaneously)
- Trade Name: Pantech
- Model(s): P7040
- FCC ID: JYCP7040
- Serial Number(s): #1
- Tx Frequency: 824.20 - 848.80 MHz (GSM850), 1 850.20 -1 909.80 MHz (GSM1900)
826.4 - 846.6 MHz (WCDMA850), 852.4 – 1 907.6 MHz (WCDMA1900)
- FCC Classification: Licensed Portable Transmitter Held to Ear (PCE)
- FCC Rule Part(s): § 20.19(b); §6.3(v), §7.3(v)
- Modulation(s): GSM850, GSM1900, WCDMA850, WCDMA1900
- Antenna Type: Intenna
- Date(s) of Tests: Oct.20, 2009
- Place of Tests: HCT CO., LTD.
Icheon, Kyoung ki-Do, KOREA
- Report Serial No.: HCTA0910FM01
- Max E-Field Emission: GSM1900 810ch, 1 909.8 MHz = 38.2 dBV/m (M3)
WCDMA1900 9538ch, 1 907.6 MHz = 32.0 dBV/m (M4)
- Max H-Field Emission: GSM1900 661ch, 1 880 MHz = -15.2 dBA/m (M3)
WCDMA1900 9400ch, 1 880 MHz = -20.4 dBV/m (M4)

2. HAC MEASUREMENT SET-UP

These measurements are performed using the DASY4 automated dosimetric assessment system. It is made by Schmid & Partner Engineering AG (SPEAG) in Zurich, Switzerland. It consists of high precision robotics system (Staubli), robot controller, Pentium IV computer, near-field probe, probe alignment sensor. The robot is a six-axis industrial robot performing precise movements.

A cell controller system contains the power supply, robot controller, teach pendant (Joystick), and remote control, is used to drive the robot motors. The PC consists of the HP Pentium IV 3.0 GHz computer with Windows XP system and HAC Measurement Software DASY4, A/D interface card, monitor, mouse, and keyboard. The Staubli Robot is connected to the cell controller to allow software manipulation of the robot. A data acquisition electronic (DAE) circuit performs the signal amplification, signal multiplexing, AD-conversion, offset measurements, mechanical surface detection, collision detection, etc. is connected to the Electro-optical coupler (EOC). The EOC performs the conversion from the optical into digital electric signal of the DAE and transfers data to the PC plug-in card.

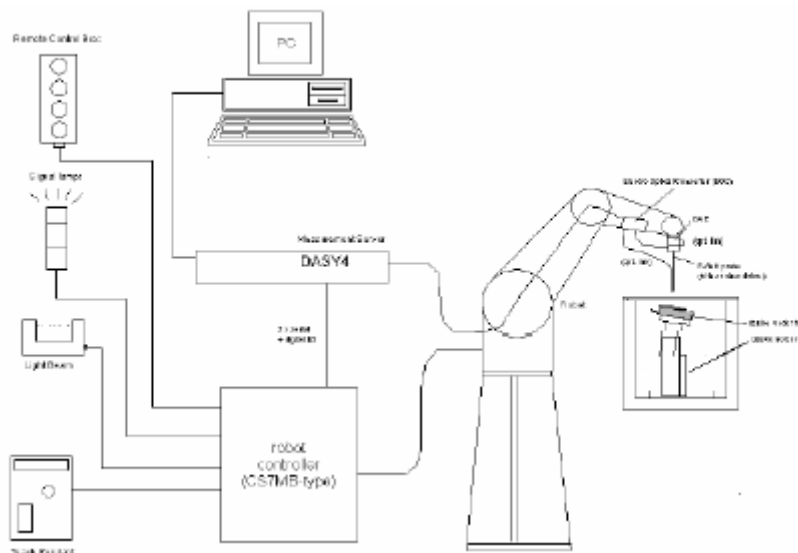



Figure 1. HAC Test Measurement Set-up

The DAE4 consists of a highly sensitive electrometer-grade preamplifier with auto-zeroing, a channel and gain-switching multiplexer, a fast 16 bit AD-converter and a command decoder and control logic unit. Transmission to the PC-card is accomplished through an optical downlink for data and status information and an optical uplink for commands and clock lines. The mechanical probe mounting device includes two different sensor systems for frontal and sidewise probe contacts. They are also used for mechanical surface detection and probe collision detection. The robot uses its own controller with a built in VME-bus computer.

3. SYSTEM SPECIFICATIONS

3.1 Probe

3.1.1 E-Field Probe Description

| | | |
|---------------|--|--|
| Construction | One dipole parallel, two dipoles normal to probe axis Built-in shielding against static charges |  <p>[E-Field Probe]</p> |
| Calibration | In air from 100 MHz to 3.0 GHz (absolute accuracy $\pm 6.0\%$, $k = 2$) | |
| Frequency | 100 MHz to > 6 GHz; Linearity: ± 0.2 dB (100 MHz to 3 GHz) | |
| Directivity | ± 0.2 dB in air (rotation around probe axis) ± 0.4 dB in air (rotation normal to probe axis) | |
| Dynamic Range | 2 V/m to > 1000 V/m (M3 or better device readings fall well below diode compression point) | |
| Linearity | ± 0.2 dB | |
| Dimensions | Overall length: 330 mm (Tip: 16 mm) Tip diameter: 8 mm (Body: 12 mm) Distance from probe tip to dipole centers: 2.5 mm | |

3.1.2 H-Field Probe Description

| | | |
|----------------------|---|--|
| Construction | Three concentric loop sensors with 3.8 mm loop diameters resistively loaded detector diodes for linear response Built-in shielding against static charges PEEK enclosure material (resistant to organic solvents, e.g., glycoether) |  <p>[H-Field Probe]</p> |
| Frequency | 200 MHz to > 3 GHz (absolute accuracy $\pm 6.0\%$, $k = 2$); Output linearized | |
| Directivity | ± 0.25 dB (spherical isotropy error) | |
| Dynamic Range | 10 mA/m to 2 A/m at 1 GHz | |
| E-Field Interference | < 10 % at 3 GHz (for plane wave) | |
| Dimensions | Overall length: 330 mm (Tip: 40 mm) Tip diameter: 6 mm (Body: 12 mm) Distance from probe tip to dipole centers: 3 mm The closest part of the sensor element is 1.9 mm closer to the tip | |

3.2 Phantom & Device Holder



Figure 2. HAC Phantom & Device Holder

The Test Arch phantom should be positioned horizontally on a stable surface. Reference markings on the Phantom allow the complete setup of all predefined phantom positions and measurement grids by manually teaching three points in the robot.

The devices can be easily, accurately, and repeatably positioned according to the FCC specifications.

3.3 Robotic System Specifications

Specifications

POSITIONER: Stäubli Unimation Corp. Robot Model: RX90LB

Repeatability: 0.02 mm

No. of axis: 6

Data Acquisition Electronic (DAE) System

Cell Controller

Processor: Pentium IV

Clock Speed: 3.0 GHz

Operating System: Windows XP

Data Card: DASY4 PC-Board

Data Converter

Features: Signal Amplifier, multiplexer, A/D converter, and control logic

Software: DASY4 software

Connecting Lines: Optical downlink for data and status info.

Optical uplink for commands and clock

PC Interface Card

Function: 24 bit (64 MHz) DSP for real time processing
Link to DAE
16 bit A/D converter for surface detection system
serial link to robot
direct emergency stop output for robot

4. EUT ARRANGEMENT

4.1 WD RF Emission Measurements Reference and Plane

Figure 3. Illustrate the references and reference plane that shall be used in the WD emissions measurement.

- The grid is 5 cm by 5 cm area that is divided into 9 evenly sized blocks or sub-grids.
- The grid is centered on the audio frequency output transducer of the WD (speaker or T-coil).
- The grid is in a reference plane, which is defined as the planar area that contains the highest point in the area of the phone that normally rests against the user's ear. It is parallel to the centerline of the receiver area of the phone and is defined by the points of the receiver-end of the WD handset, which, in normal handset use, rest against the ear.
- The measurement plane is parallel to, and 1.5 cm in front of, the reference plane.

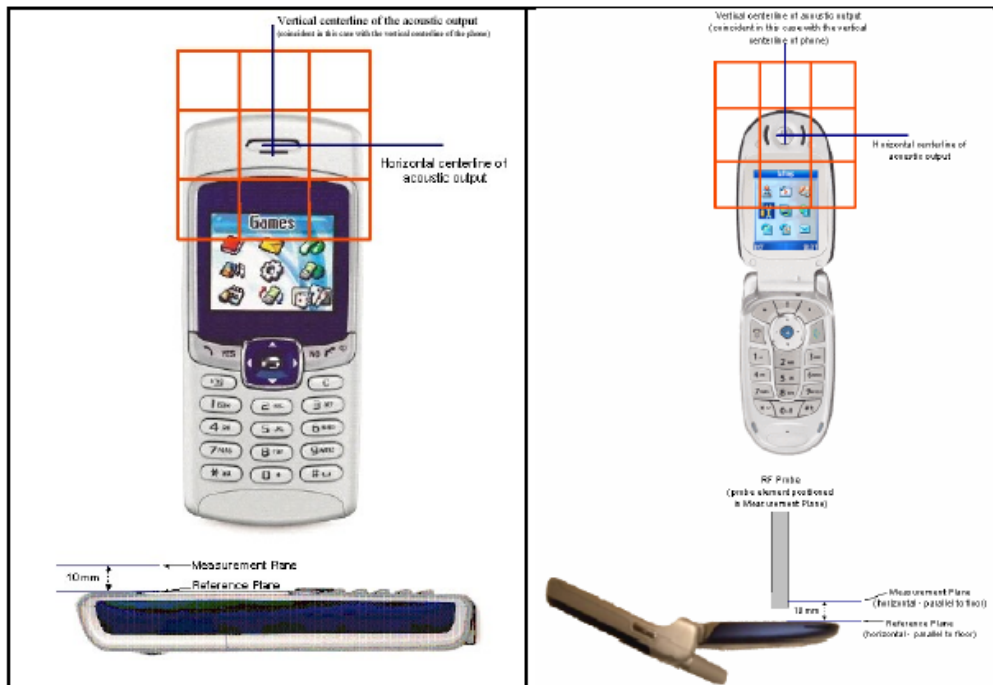

Figure 3. WD reference and plane for RF emission measurements

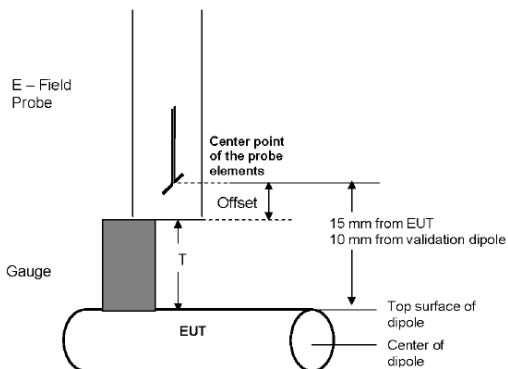

Figure 4. Gauge Block with E-Field Probe

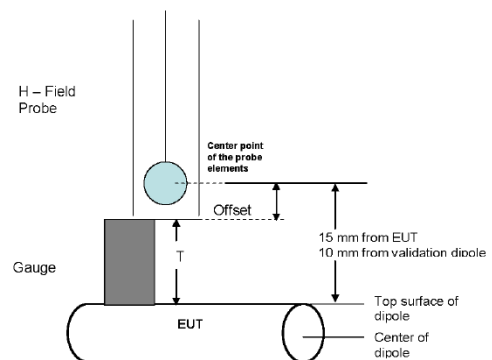

Figure 5. Gauge Block with H-Field Probe

5. SYSTEM VALIDATION

The test setup was validated when configured and verified periodically thereafter to ensure proper function. The procedure is a validation procedure using dipole antennas for which the field levels were computed by FDTD modeling.

5.1 Validation Procedure

Place a dipole antenna meeting the requirements given in ANSI-C63.19 in the position normally occupied by the WD. The dipole antenna serves as a known source for an electrical and magnetic output. Position the E-field and H-field probes so that:

- the probes and their cables are parallel to the coaxial feed of the dipole antenna
- the probe cables and the coaxial feed of the dipole antenna approach the measurement area from opposite directions; and
- the probes are 10 mm from the surface of the dipole elements.

Scan the length of the dipole with both E-field and H-field probes and record the maximum values for each. Compare the readings to expected values.

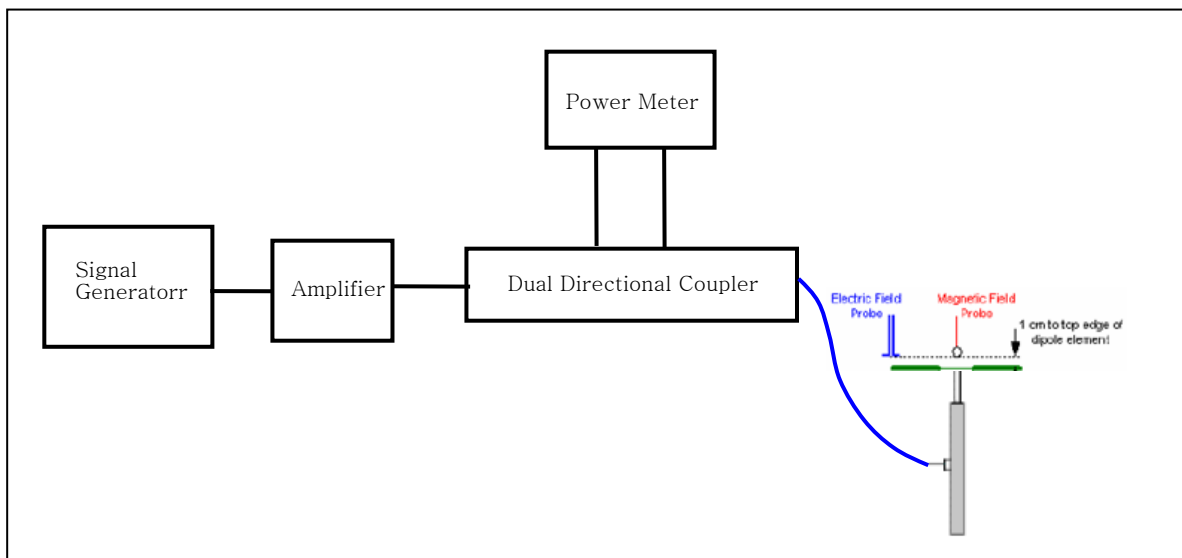

Figure 6. Dipole Validation SET-UP

5.2 Validation Result

5.2.1 E-Field Scan

| Mode | Freq. [MHz] | Input Power [dBm] | Measured Value [V/m] | Target Value [V/m] SPEAG | Deviation [%] | Limit [%] |
|------|-------------|-------------------|----------------------|-----------------------------|---------------|-----------|
| CW | 835 | 20 | 164.25 | 159 | + 3.31 | ± 25 |
| CW | 1 880 | 20 | 134.8 | 140.25 | - 3.89 | ± 25 |

5.2.2 H-Field Scan

| Mode | Freq. [MHz] | Input Power [dBm] | Measured Value [A/m] | Target Value [A/m] SPEAG | Deviation [%] | Limit [%] |
|------|-------------|-------------------|----------------------|-----------------------------|---------------|-----------|
| CW | 835 | 20 | 0.460 | 0.445 | + 3.37 | ± 25 |
| CW | 1 880 | 20 | 0.480 | 0.469 | + 2.34 | ± 25 |

Notes:

- 1) Deviation (%) = 100 * (Measured value minus Target value) divided by Target value.
ANSI-C63.19 requires values to be within 25 % of their targets. 12 % is deviation and 13 % is measurement uncertainty.
- 2) The maximum E-field or H-field were evaluated and compared to the target values provided by SPEAG in the calibration certificate of specific dipoles.
- 3) Please refer to the attachment for detailed measurement data and plot.

6. Probe Modulation Factor

A calibration was made of the modulation response of the probe and its instrumentation chain. This calibration was performed with the field probe, attached to its instrumentation. The response of the probe system to a CW field at the frequency of interest is compared to its response to a modulated signal with equal peak amplitude to that of a CW signal. The field level of the test signals are ensured to be more than 10 dB above the ambient level and the noise floor of the instrumentation being used. The ratio of the CW reading to that taken with a modulated reading was applied to the DUT measurements.

All voice modes for this device have been investigated in this section of the report. According to the FCC 3G Measurement Procedures, May 2006 for RF Emissions, variations in peak field and power readings.

This was done using the following procedure:

1. The probe was illuminated with a CW signal at the intended measurement frequency and wireless device power.
2. The probe was positioned at the field maxima over the dipole antenna (determined after an area scan over the dipole) illuminated with the CW signal.
3. The reading of the probe measurement system of the CW signal at the maximum point was recorded.
4. Using a Spectrum Analyzer, the modulated signal adjusted with the same peak level of the CW signal was determined.
5. The probe measurement system reading was recorded with the modulated signal. The appropriate system crest factors for the modulation type were configured in the software to the system measurements.
6. The ratio of the CW reading to modulated signal reading is the probe modulation factor (PMF) for the modulation and field probe combination. This was repeated for 80 % AM.
7. Steps 1-6 were repeated at all frequency bands and for both E and H field probes.

The modulation factors obtained were applied to readings taken of the actual wireless device, in order to obtain an accurate peak field reading using the formula:

$$\text{Peak} = 20 \cdot \log (\text{Raw} \cdot \text{PMF})$$

This method correlates well with the modulation using the DUT in the alternative substitution method. See below for correlation of signal:

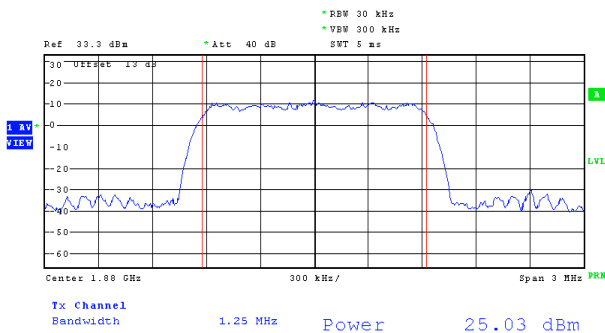

Figure. 7

Signal Generator Modulated Signal

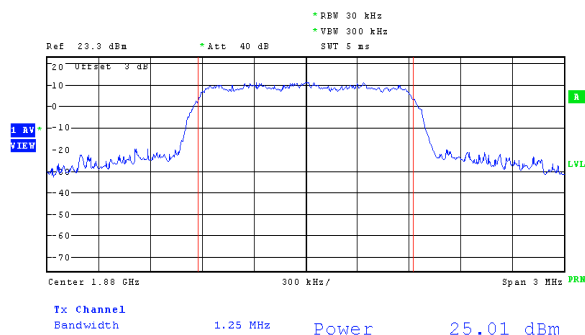

Figure. 8

Wireless Device Modulated Signal

6.2 Modulation Factor

6.2.1 E-Field (GSM)

| Mode | Freq. [MHz] | Input Power [dB] | E-Field measured value [V/m] | Probe Modulation Factor |
|---------|-------------|------------------|------------------------------|-------------------------|
| CW | 835 | 32.5 | 739 | - |
| 80 % AM | | 32.5 | 521.5 | 1.417 |
| GSM | | 32.5 | 272.1 | 2.716 |
| CW | 1 880 | 30 | 431 | - |
| 80 % AM | | 30 | 369.5 | 1.166 |
| GSM | | 30 | 161.7 | 2.665 |

6.2.2 H-Field (GSM)

| Mode | Freq. [MHz] | Input Power [dB] | E-Field measured value [A/m] | Probe Modulation Factor |
|---------|-------------|------------------|------------------------------|-------------------------|
| CW | 835 | 32.5 | 2.012 | - |
| 80 % AM | | 32.5 | 1.685 | 1.194 |
| GSM | | 32.5 | 1.079 | 1.865 |
| CW | 1 880 | 30 | 1.523 | - |
| 80 % AM | | 30 | 1.305 | 1.167 |
| GSM | | 30 | 0.685 | 2.223 |

Notes:

- 1) Modulation Factor =CW / WD_GSM

6.2.3 E-Field (WCDMA)

| Mode | Freq. [MHz] | Input Power [dB] | E-Field measured value [V/m] | Probe Modulation Factor |
|---------|-------------|------------------|------------------------------|-------------------------|
| CW | 835 | 24 | 268.8 | - |
| 80 % AM | | 24 | 168.2 | 1.598 |
| WCDMA | | 24 | 321 | 0.837 |
| CW | 1 880 | 24 | 219.6 | - |
| 80 % AM | | 24 | 133.4 | 1.646 |
| WCDMA | | 24 | 256.7 | 0.855 |

6.2.4 H-Field (WCDMA)

| Mode | Freq. [MHz] | Input Power [dB] | E-Field measured value [A/m] | Probe Modulation Factor |
|---------|-------------|------------------|------------------------------|-------------------------|
| CW | 835 | 24 | 0.725 | - |
| 80 % AM | | 24 | 0.502 | 1.444 |
| WCDMA | | 24 | 0.879 | 0.825 |
| CW | 1 880 | 24 | 0.703 | - |
| 80 % AM | | 24 | 0.501 | 1.403 |
| WCDMA | | 24 | 0.864 | 0.814 |

Notes:

Modulation Factor =CW / WD_WCDMA Notes:

6.2.3 PMF Peak Power Measurement Plots

■ Probe Modulation Factor (CW)

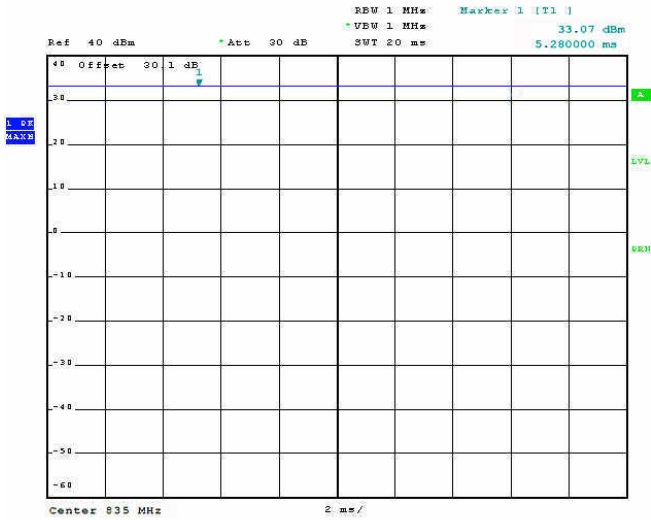

■ Probe Modulation Factor (AM 80 %)

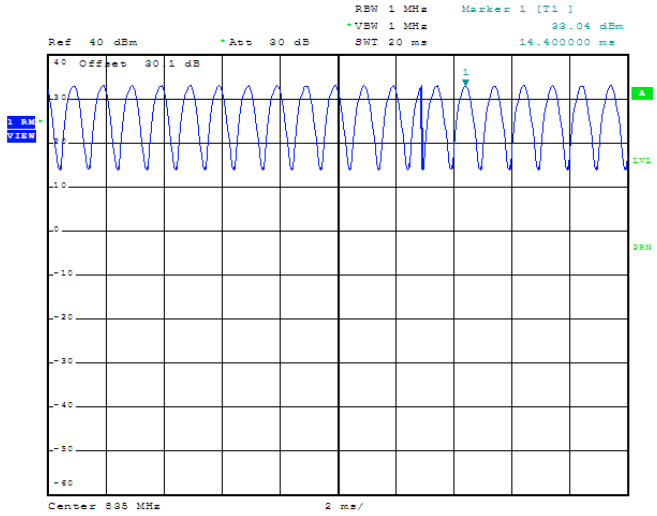

■ Probe Modulation Factor (GSM)

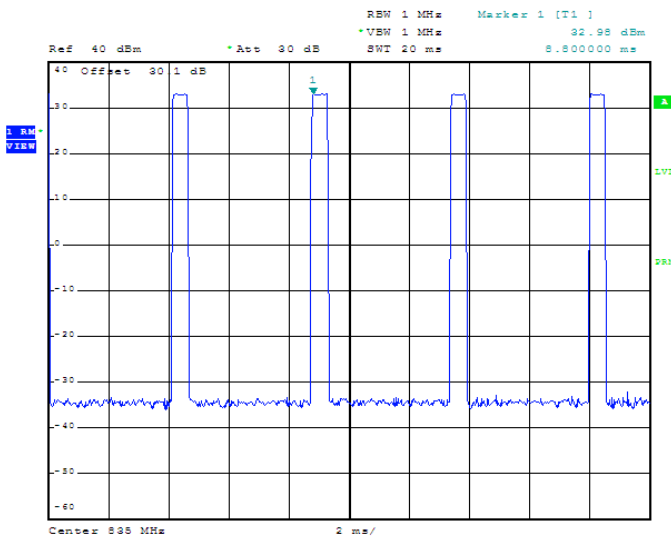

Spectrum Analyzer Settings

- Input Power: 33.0 dBm, 30.0 dBm
- RBW: 1 MHz
- Video Bandwidth: 1 MHz
- Span: Zero
- Sweep Time: 20 ms
- Detection: Peak detection (RMS)

■ Probe Modulation Factor (CW)

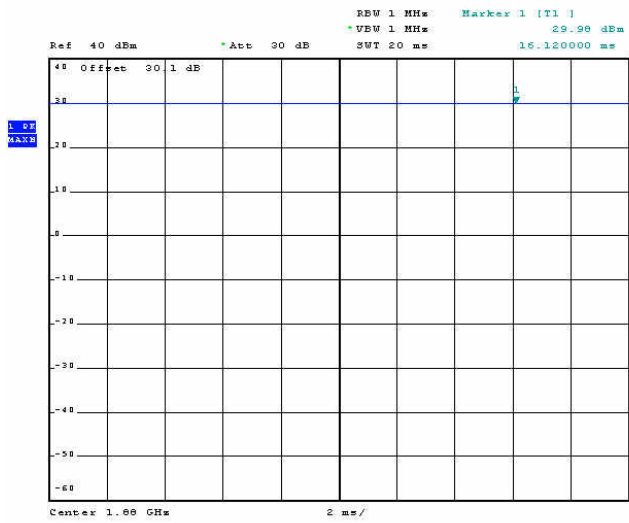

■ Probe Modulation Factor (AM 80 %)

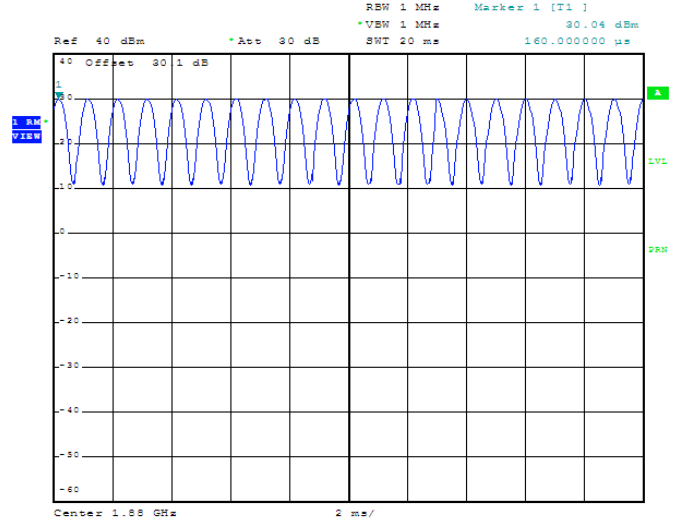

■ Probe Modulation Factor (GSM)

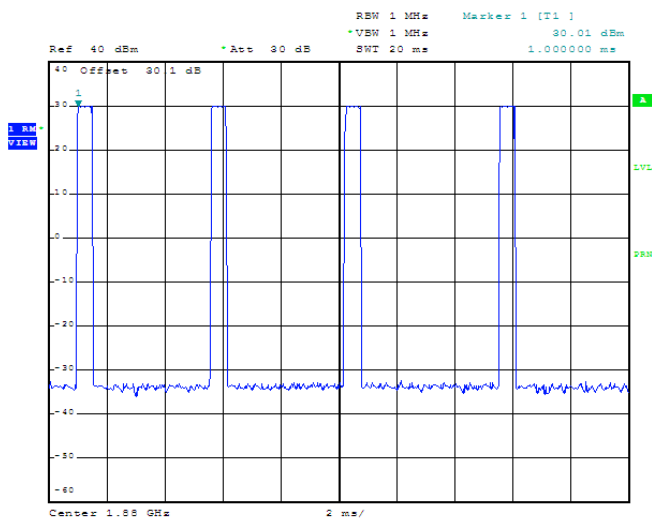

Spectrum Analyzer Settings

- Input Power: 33.0 dBm, 30.0 dBm
- RBW: 1 MHz
- Video Bandwidth: 1 MHz
- Span: Zero
- Sweep Time: 20 ms
- Detection: Peak detection (RMS)

7. FCC 3G MEASUREMENTS – MAY / JUNE 2006

Power measurements were performed using a base station simulator under digital average power.

7.1 Procedures Used to Establish RF Signal for HAC Testing

The handset was placed into a simulated call using a base station simulator in a shielded chamber.

Such test signals offer a consistent means for testing HAC and are recommended for evaluating HAC.

Measurements were taken with a fully charged battery. In order to verify that the device was tested and maintained at full power, this was configured with the base station simulator. The HAC measurement software calculates a reference point at the start and end of the test to check for power drifts. If conducted power deviations of more than 5 % occurred, the tests were repeated.

7.1 HAC Measurement Conditions for UMTS

Output Power Verification

Maximum output power is verified on the High, Middle and Low channel according to the general description in section 5.2 of 3GPP TS 34.121, using the appropriate RMC or AMR with TPC(transmit power control) set to all "1s".

HAC Measurements

HAC is measured using the 12.2 kbps RMC with TPC bits configured to all "1s". HAC in AMR configurations is not required when the maximum average output of each RF channel for 12.2 kbps AMR is less than 1/4 dB higher than that measured in 12.2 kbps RMC. Otherwise, HAC is measured on the maximum output channel in AMR with a 3.4kbps SRB (signaling radio bearer) using the configuration that results in the highest HAC for that RF channel in 12.2 RMC.

Average Output Power Measurement for FCC ID: JYCP7040

| Band | Channel | Voice | GPRS Data | | EDGE Data | |
|----------|---------|-----------|----------------------|----------------------|----------------------|----------------------|
| | | GSM (dBm) | GPRS 1 TX Slot (dBm) | GPRS 2 TX Slot (dBm) | EDGE 1 TX Slot (dBm) | EDGE 2 TX Slot (dBm) |
| GSM 850 | 128 | 32.67 | 32.65 | 32.62 | 26.76 | 26.77 |
| | 190 | 32.60 | 32.59 | 32.55 | 26.71 | 26.71 |
| | 251 | 32.60 | 32.60 | 32.55 | 26.71 | 26.72 |
| GSM 1900 | 512 | 30.17 | 30.16 | 30.10 | 25.71 | 25.72 |
| | 661 | 30.21 | 30.20 | 30.16 | 25.76 | 25.77 |
| | 810 | 30.48 | 30.48 | 30.43 | 26.03 | 26.02 |

Table 1. GSM Conducted output powers

| Band | Channel | HSDPA INACTIVE | | HSDPA ACTIVE |
|---------------|---------|-------------------|-------------------|-------------------|
| | | 12.2kbps RMC(dBm) | 12.2kbps AMR(dBm) | 12.2kbps RMC(dBm) |
| WCDMA 850 | 4132 | 24.06 | 24.06 | 23.82 |
| | 4183 | 23.95 | 23.90 | 23.69 |
| | 4233 | 23.93 | 23.87 | 23.67 |
| WCDMA 1900 | 9262 | 24.18 | 24.27 | 24.06 |
| | 9400 | 24.36 | 24.44 | 24.26 |
| | 9538 | 24.01 | 24.04 | 23.80 |

Table 2. WCDMA Conducted output power

8. TEST PROCEDURE

Test Instructions

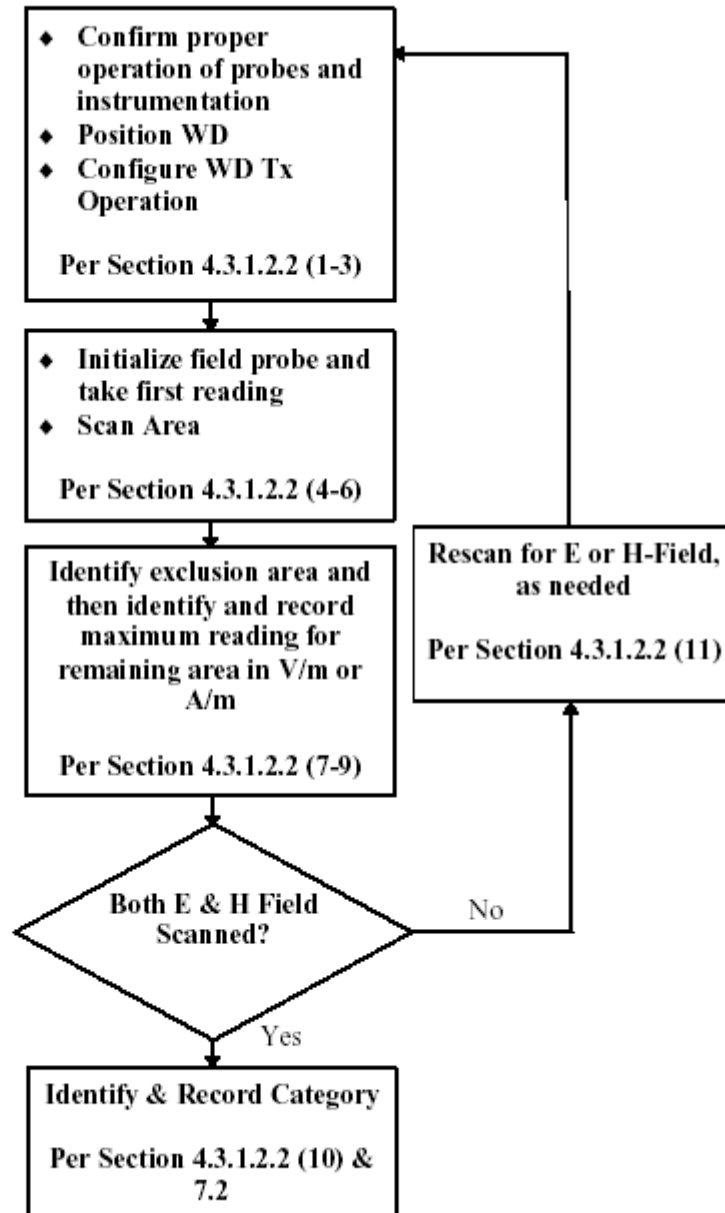

Figure 9. WD near-field emission automated test flowchart

The evaluation was performed with the following procedure:

1. Confirm proper operation of the field probe, probe measurement system and other instrumentation and the positioning system.
2. Position the WD in its intended test position. The measurement should be performed at a distance 1.5 cm from the probe elements so the gauge block can simplify this positioning.
3. Configure the WD normal operation for maximum rated RF output power, at the desired channel and other operating parameters, as intended for the test.
4. The center sub-grid shall be centered on the center of the WD output (acoustic or T-Coil output), as appropriate.
5. A Surface calibration was performed before each setup change to ensure repeatable spacing and proper maintenance of the measurement plane using the HAC Phantom.
6. Locate the field probe at reference location and measure the field strength.
7. Scan the entire 5 cm by 5 cm region at 5 mm increments and record the reading at each measurement point.
8. Identify the maximum field reading within the non-excluded sub-grids identified in Step 7.
9. Move the probe to the location of maximum scan measurement and then 360° rotating the probe to align it for the maximum reading at that position.
10. Locate the field probe at the reference location and measure the field strength for drift evaluation. If conducted power deviations of more than 5 % occurred, the tests were repeated.
11. Convert the maximum field strength reading identified in Step 8 to V/m or A/m, as appropriate. For probes which require a probe modulation factor, this conversion shall be done using the appropriate probe modulation.
12. Repeat Step 1 through Step 11 for both the E and H field measurements.

9. ANSI/IEEE C63.19 PERFORMANCE CATEGORIES

The EUT must meet the following M3 or M4 category:

| Category | Telephone RF Parameters | | |
|---------------------|-------------------------|----------------------------|----------------------------|
| Near Field | AWF [dB] | E-Field Emissions dB [V/m] | H-Field Emissions dB [A/m] |
| Frequency < 960 MHz | | | |
| M1 | 0 | 56 to 61 | + 5.6 to + 10.6 |
| | -5 | 53.5 to 58.5 | + 3.1 to + 8.1 |
| M2 | 0 | 51 to 56 | + 0.6 to + 5.6 |
| | -5 | 48.5 to 53.5 | - 1.9 to + 3.1 |
| M3 | 0 | 46 to 51 | - 4.4 to + 0.6 |
| | -5 | 43.5 to 48.5 | - 6.9 to - 1.9 |
| M4 | 0 | < 46 | < - 4.4 |
| | -5 | < 43.5 | < - 6.9 |
| Frequency > 960 MHz | | | |
| M1 | 0 | 46 to 51 | - 4.4 to 0.6 |
| | -5 | 43.5 to 48.5 | - 6.9 to -1.9 |
| M2 | 0 | 41 to 46 | - 9.4 to - 4.4 |
| | -5 | 38.5 to 43.5 | -11.9 to - 6.9 |
| M3 | 0 | 36 to 41 | - 14.4 to - 9.4 |
| | -5 | 33.5 to 38.5 | - 16.9 to -11.9 |
| M4 | 0 | < 36 | < - 14.4 |
| | -5 | < 33.5 | < - 16.9 |

Table 1. Telephone near-field categories in linear units

10. MEASUREMENT UNCERTAINTIES

10.1 E-Field

| HAC (E-Field) Uncertainty Budget [According to ANSI C63.19] | | | | | | | | | | Note/ Comment |
|---|--------------------------------|--------------------------|-------------|--------|--------------------------|----------------|---------------------------|-----------|---|------------------|
| Error Description | Uncertainty [%] | Probability Distribution | Divisor | ci [E] | Standard Uncertainty [E] | Stand Uncert*2 | (Stand Uncert*2) X (ci*2) | Vi & Veff | | |
| Measurement system | | | | | | | | | | |
| 1 | Probe Calibration | 5.1 % | Normal | 1.00 | 1 | 5.1 % | 26.01 | 26.01 | ∞ | |
| 2 | Axial Isotropy | 4.7 % | Rectangular | 1.73 | 1 | 2.7 % | 7.36 | 7.36 | ∞ | |
| 3 | Sensor Displacement | 16.5 % | Rectangular | 1.73 | 1 | 9.5 % | 90.75 | 90.75 | ∞ | |
| 4 | Boundary effect | 2.4 % | Rectangular | 1.73 | 1 | 1.4 % | 1.92 | 1.92 | ∞ | |
| 5 | Linearity | 4.7 % | Rectangular | 1.73 | 1 | 2.7 % | 7.36 | 7.36 | ∞ | |
| 6 | Scaling to peak Envelope Power | 2.0 % | Rectangular | 1.73 | 1 | 1.2 % | 1.33 | 1.33 | ∞ | |
| 7 | System Detection limits | 1.0 % | Rectangular | 1.73 | 1 | 0.6 % | 0.33 | 0.33 | ∞ | |
| 8 | Readout Electronics | 0.3 % | Normal | 1.00 | 1 | 0.3 % | 0.09 | 0.09 | ∞ | |
| 9 | Response time | 0.8 % | Rectangular | 1.73 | 1 | 0.5 % | 0.21 | 0.21 | ∞ | |
| 10 | Integration time | 2.6 % | Rectangular | 1.73 | 1 | 1.5 % | 2.25 | 2.25 | ∞ | |
| 11 | RF Ambient Conditions | 3.0 % | Rectangular | 1.73 | 1 | 1.7 % | 3.00 | 3.00 | ∞ | |
| 12 | RF Reflections | 1.2 % | Rectangular | 1.73 | 1 | 0.7 % | 0.50 | 0.50 | ∞ | |
| 13 | Probe positioner | 1.2 % | Rectangular | 1.73 | 1 | 0.7 % | 0.48 | 0.48 | ∞ | |
| 14 | Probe positioning | 4.7 % | Rectangular | 1.73 | 1 | 2.7 % | 7.36 | 7.36 | ∞ | |
| 15 | Extrap. And Interpolation | 1.0 % | Rectangular | 1.73 | 1 | 0.6 % | 0.33 | 0.33 | ∞ | |
| Test Sample Related | | | | | | | | | | |
| 16 | Device Positioning Vertical | 4.7 % | Rectangular | 1.73 | 1 | 2.7 % | 7.36 | 7.36 | ∞ | |
| 17 | Device Positioning Lateral | 1.0 % | Rectangular | 1.73 | 1 | 0.6 % | 0.33 | 0.33 | ∞ | |
| 18 | Device Holder and Phantom | 2.4 % | Rectangular | 1.73 | 1 | 1.4 % | 1.92 | 1.92 | ∞ | |
| 19 | Test Sample | 0.4 % | Normal | 1.00 | 1 | 0.4 % | 0.16 | 0.16 | g | 0.17 dB |
| 20 | Power drift | 3.0 % | Rectangular | 1.73 | 1 | 1.7 % | 3.00 | 3.00 | ∞ | |
| PMF Calculations | | | | | | | | | | |
| 21 | Power Sensor | 1.0 % | Rectangular | 1.73 | 1 | 0.6 % | 0.32 | 0.32 | ∞ | |
| 22 | Dual Directional Coupler | 1.0 % | Rectangular | 1.73 | 1 | 0.6 % | 0.32 | 0.32 | ∞ | |
| Phantom and Setup Related | | | | | | | | | | |
| 23 | Phantom Thickness | 2.4 % | Rectangular | 1.73 | 1 | 1.4 % | 1.92 | 1.92 | ∞ | |
| Combined standard Uncertainty [%] | | | | | | 12.8 % | | 164.64 | | 0.523 dB |
| Expanded standard Uncertainty [k = 2 , Confidence 95 %] | | | | | | 25.7 % | | | | 0.993 dB |

Table 2. Uncertainties (E-Field)

Notes:

1. Worst-Case uncertainty budget for HAC free field assessment according to ANSI-C 63.19[1]. The budget is valid for the frequency range 800 MHz-3 GHz and represents a worst-Case analysis. For specific test sand configurations, the uncertainty could be considerably smaller. Some of the parameters are dependent on the user situations and need adjustment according to the actual laboratory conditions.
2. * Uncertainty specifications from Schmidt & Partner Engineering AG (not site specific)

10.2 H-Field

| HAC (H-Field) Uncertainty Budget [According to ANSI C63.19] | | | | | | | | | | Note/ Comment |
|--|--------------------------------|--------------------------|-------------|--------|--------------------------|----------------|---------------------------|-----------------------------------|---|------------------|
| Error Description | Uncertainty [%] | Probability Distribution | Divisor | ci [H] | Standard Uncertainty [H] | Stand Uncert*2 | (Stand Uncert*2) X (ci^2) | V _i & V _{eff} | | |
| Measurement system | | | | | | | | | | |
| 1 | Probe Calibration | 5.1 % | Normal | 1.00 | 1 | 5.1 % | 26.01 | 26.01 | ∞ | |
| 2 | Axial Isotropy | 4.7 % | Rectangular | 1.73 | 1 | 2.7 % | 7.36 | 7.36 | ∞ | |
| 3 | Sensor Displacement | 16.5 % | Rectangular | 1.73 | 0.145 | 1.4 % | 1.91 | 0.04 | ∞ | |
| 4 | Boundary effect | 2.4 % | Rectangular | 1.73 | 1 | 1.4 % | 1.92 | 1.92 | ∞ | |
| 5 | Linearity | 4.7 % | Rectangular | 1.73 | 1 | 2.7 % | 7.36 | 7.36 | ∞ | |
| 6 | Scaling to peak Envelope Power | 2.0 % | Rectangular | 1.73 | 1 | 1.2 % | 1.33 | 1.33 | ∞ | |
| 7 | System Detection limits | 1.0 % | Rectangular | 1.73 | 1 | 0.6 % | 0.33 | 0.33 | ∞ | |
| 8 | Readout Electronics | 0.3 % | Normal | 1.00 | 1 | 0.3 % | 0.09 | 0.09 | ∞ | |
| 9 | Response time | 0.8 % | Rectangular | 1.73 | 1 | 0.5 % | 0.21 | 0.21 | ∞ | |
| 10 | Integration time | 2.6 % | Rectangular | 1.73 | 1 | 1.5 % | 2.25 | 2.25 | ∞ | |
| 11 | RF Ambient Conditions | 3.0 % | Rectangular | 1.73 | 1 | 1.7 % | 3.00 | 3.00 | ∞ | |
| 12 | RF Reflections | 1.1 % | Rectangular | 1.00 | 1 | 1.1 % | 1.14 | 1.14 | ∞ | |
| 13 | Probe positioner | 1.2 % | Rectangular | 1.73 | 0.67 | 0.5 % | 0.22 | 0.10 | ∞ | |
| 14 | Probe positioning | 4.7 % | Rectangular | 1.73 | 0.67 | 1.8 % | 3.31 | 1.48 | ∞ | |
| 15 | Extrap. And Interpolation | 1.0 % | Rectangular | 1.73 | 1 | 0.6 % | 0.33 | 0.33 | ∞ | |
| Test Sample Related | | | | | | | | | | |
| 16 | Device Positioning Vertical | 4.7 % | Rectangular | 1.73 | 0.67 | 1.8 % | 3.31 | 7.32 | ∞ | |
| 17 | Device Positioning Lateral | 1.0 % | Rectangular | 1.73 | 1 | 0.6 % | 0.33 | 0.33 | ∞ | |
| 18 | Device Holder and Phantom | 2.4 % | Rectangular | 1.73 | 1 | 1.4 % | 1.92 | 1.92 | ∞ | |
| 19 | Test Sample | 0.3 % | Normal | 1.00 | 1 | 0.3 % | 0.08 | 0.08 | 9 | 0.013 dB |
| 20 | Power drift | 3.0 % | Rectangular | 1.73 | 1 | 1.7 % | 3.00 | 3.00 | ∞ | |
| PMF Calculations | | | | | | | | | | |
| 21 | Power Sensor | 1.0 % | Rectangular | 1.73 | 1 | 0.6 % | 0.32 | 0.10 | ∞ | |
| 22 | Dual Directional Coupler | 1.0 % | Rectangular | 1.73 | 1 | 0.6 % | 0.32 | 0.32 | ∞ | |
| Phantom and Setup Related | | | | | | | | | | |
| 23 | Phantom Thickness | 2.4 % | Rectangular | 1.73 | 0.67 | 0.9 % | 0.86 | 0.39 | ∞ | |
| Combined standard Uncertainty [%] | | | | | | 8.2 % | | 66.44 | | 0.342 dB |
| Expanded standard Uncertainty [k = 2 , Confidence 95 %] | | | | | | 16.3 % | | | | 0.6558 dB |

Table 2. Uncertainties (H-Field)

Notes:

1. Worst-Case uncertainty budget for HAC free field assessment according to ANSI-C 63.19[1]. The budget is valid for the frequency range 800 MHz-3 GHz and represents a worst-Case analysis. For specific test sand configurations, the uncertainty could be considerably smaller. Some of the parameters are dependent on the user situations and need adjustment according to the actual laboratory conditions.

2. * Uncertainty specifications from Schmidt & Partner Engineering AG (not site specific)

11. HAC TEST DATA SUMMARY

Ambient TEMPERATURE (°C): 21.4
S/N: #1

11.1 E-Field Measurement Results (GSM850 / GSM1900 DATA)

| Mode | Ch. | Back light | Battery | Antenna | Conducted Power [dBm] | Time Avg. Field [V/m] | Peak Field [dBV/m] | FCC Limit [dBV/m] | FCC MARGIN [dB] | RESULT | Exclusion Block |
|---------|-----|------------|----------|---------|-----------------------|-----------------------|--------------------|-------------------|-----------------|-----------|-----------------|
| GSM850 | 128 | off | Standard | Intenna | 32.67 | 59.5 | 44.2 | 48.5 | - 4.33 | M3 | none |
| GSM850 | 190 | off | Standard | Intenna | 32.60 | 87.9 | 47.6 | 48.5 | - 0.94 | M3 | none |
| GSM850 | 251 | off | Standard | Intenna | 32.60 | 76.0 | 46.3 | 48.5 | - 2.20 | M3 | none |
| GSM1900 | 512 | off | Standard | Intenna | 30.17 | 28.7 | 37.7 | 38.5 | - 0.83 | M3 | none |
| GSM1900 | 661 | off | Standard | Intenna | 30.21 | 29.5 | 37.9 | 38.5 | - 0.59 | M3 | none |
| GSM1900 | 810 | off | Standard | Intenna | 30.48 | 30.7 | 38.2 | 38.5 | - 0.26 | M3 | none |

NOTES:

- All modes of operation were investigated and the worst-case are reported.
- Battery Type Standard Extended Fixed
- Power Measured Conducted EIRP ERP
- Test Signal Call Mode Manual Test cord Base Station Simulator
- SAR Measurement System SPEAG

11.2 H-Field Measurement Results (GSM850 / GSM1900 DATA)

Ambient TEMPERATURE (°C): 21.4
S/N: #1

| Mode | Ch. | Back light | Battery | Antenna | Conducted Power [dBm] | Time Avg. Field [V/m] | Peak Field [dBV/m] | FCC Limit [dBV/m] | FCC MARGIN [dB] | RESULT | Exclusion Block |
|---------|-----|------------|----------|---------|-----------------------|-----------------------|--------------------|-------------------|-----------------|-----------|-----------------|
| GSM850 | 128 | off | Standard | Intenna | 32.67 | 0.123 | - 12.8 | - 1.9 | - 10.91 | M4 | none |
| GSM850 | 190 | off | Standard | Intenna | 32.60 | 0.185 | - 9.3 | - 1.9 | - 7.37 | M4 | none |
| GSM850 | 251 | off | Standard | Intenna | 32.60 | 0.161 | - 10.5 | - 1.9 | - 8.57 | M4 | none |
| GSM1900 | 512 | off | Standard | Intenna | 30.17 | 0.071 | - 16.0 | - 11.9 | - 4.10 | M3 | none |
| GSM1900 | 661 | off | Standard | Intenna | 30.21 | 0.078 | - 15.2 | - 11.9 | - 3.32 | M3 | none |
| GSM1900 | 810 | off | Standard | Intenna | 30.48 | 0.076 | - 15.5 | - 11.9 | - 3.60 | M3 | none |

NOTES:

- All modes of operation were investigated and the worst-case are reported.
- Battery Type Standard Extended Fixed
- Power Measured Conducted EIRP ERP
- Test Signal Call Mode Manual Test cord Base Station Simulator
- SAR Measurement System SPEAG

11.3 E-Field Measurement Results (WCDMA850 /WCDMA1900 DATA)

Ambient TEMPERATURE (°C): 21.4
S/N: #1

| Mode | Ch. | Back light | Battery | Antenna | Conducted Power [dBm] | Time Avg. Field [V/m] | Peak Field [dBV/m] | FCC Limit [dBV/m] | FCC MARGIN [dB] | RESULT | Exclusion Block |
|-----------|------|------------|----------|---------|-----------------------|-----------------------|--------------------|-------------------|-----------------|-----------|-----------------|
| WCDMA850 | 4132 | off | Standard | Intenna | 24.06 | 57.9 | 33.7 | 51 | - 17.29 | M4 | none |
| WCDMA850 | 4183 | off | Standard | Intenna | 23.95 | 72.9 | 35.7 | 51 | - 15.29 | M4 | none |
| WCDMA850 | 4233 | off | Standard | Intenna | 23.93 | 66.7 | 34.9 | 51 | - 16.06 | M4 | none |
| WCDMA1900 | 9262 | off | Standard | Intenna | 24.18 | 41.9 | 31.1 | 41 | - 9.91 | M4 | none |
| WCDMA1900 | 9400 | off | Standard | Intenna | 24.36 | 45.0 | 31.7 | 41 | - 9.31 | M4 | none |
| WCDMA1900 | 9538 | off | Standard | Intenna | 24.01 | 46.8 | 32.0 | 41 | - 8.96 | M4 | none |

NOTES:

1. All modes of operation were investigated and the worst-case are reported.
2. Battery Type Standard Extended Fixed
3. Power Measured Conducted EIRP ERP
4. Test Signal Call Mode Manual Test cord Base Station Simulator
5. SAR Measurement System SPEAG

11.4 H-Field Measurement Results (WCDMA850 /WCDMA1900 DATA)

Ambient TEMPERATURE (°C): 21.4
S/N: #1

| Mode | Ch. | Back light | Battery | Antenna | Conducted Power [dBm] | Time Avg. Field [V/m] | Peak Field [dBV/m] | FCC Limit [dBV/m] | FCC MARGIN [dB] | RESULT | Exclusion Block |
|-----------|------|------------|----------|---------|-----------------------|-----------------------|--------------------|-------------------|-----------------|-----------|-----------------|
| WCDMA850 | 4132 | off | Standard | Intenna | 24.06 | 0.119 | -20.1 | 0.6 | -20.73 | M4 | none |
| WCDMA850 | 4183 | off | Standard | Intenna | 23.95 | 0.149 | -18.2 | 0.6 | -18.82 | M4 | none |
| WCDMA850 | 4233 | off | Standard | Intenna | 23.93 | 0.134 | -19.1 | 0.6 | -19.70 | M4 | none |
| WCDMA1900 | 9262 | off | Standard | Intenna | 24.18 | 0.106 | -21.3 | -9.4 | -11.89 | M4 | none |
| WCDMA1900 | 9400 | off | Standard | Intenna | 24.36 | 0.117 | -20.4 | -9.4 | -11.02 | M4 | none |
| WCDMA1900 | 9538 | off | Standard | Intenna | 24.01 | 0.115 | -20.6 | -9.4 | -11.15 | M4 | none |

NOTES:

- All modes of operation were investigated and the worst-case are reported.
- Battery Type Standard Extended Fixed
- Power Measured Conducted EIRP ERP
- Test Signal Call Mode Manual Test cord Base Station Simulator
- SAR Measurement System SPEAG

11.5 Worst-case Configuration Evaluation

Ambient TEMPERATURE (°C): 21.4

S/N: #1

Peak Reading 360° Probe Rotation at Azimuth axis

| Mode | Chan nel | Backlight | RC/SO | Antenna | Conducted Power (dBm) | Time Avg. Field (V/m) | Peak Field (dBV/m) | FCC Limit (dBV/m) | FCC MARGIN (dB) | Exclusion Block | RESULT |
|---------|-------------|-----------|----------|---------|-----------------------------|-----------------------------|--------------------------|----------------------|-----------------------|--------------------|--------|
| GSM1900 | 810 | off | Standard | Intenna | 30.17 | 30.8 | 38.3 | 38.5 | -0.20 | none | M3 |

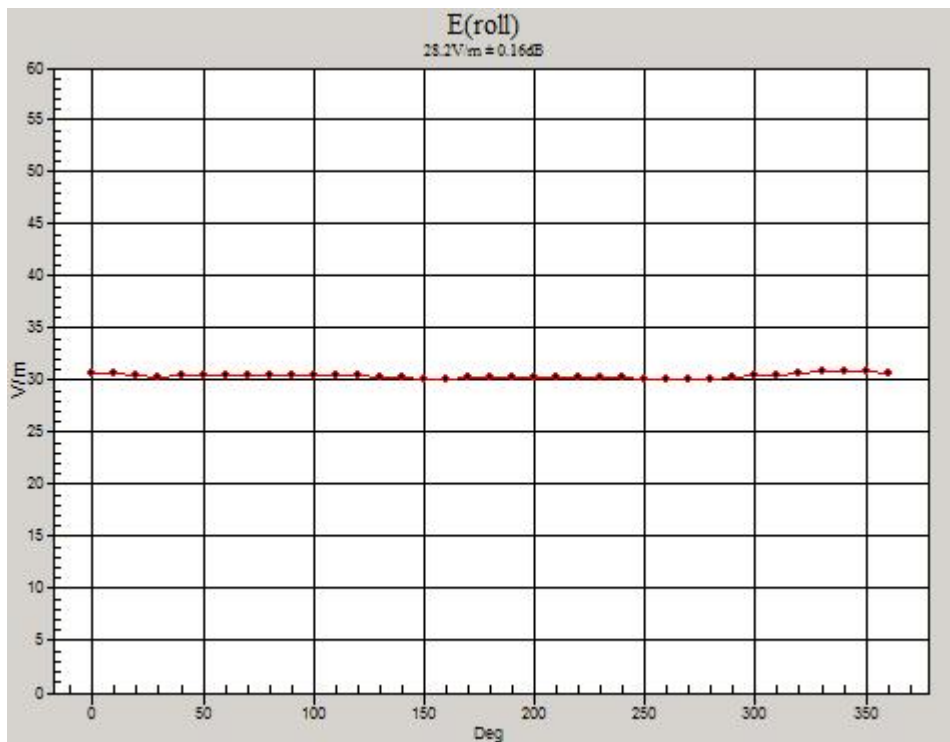

Worst-Case Probe Rotation about Azimuth axis

12. HAC TEST EQUIPMENT LIST

| Manufacturer | Type / Model | S/N | Calib. Date | Calib. Interval | Calib. Due |
|--------------|-------------------------------|------------------|-------------|-----------------|------------|
| Staubli | Robot RX90L | F01/ 5K09A1/A/01 | N/A | N/A | N/A |
| Staubli | Robot ControllerCS7MB | F99/5A82A1/C/01 | N/A | N/A | N/A |
| Staubli | Teach Pendant (Joystick) | D221340.01 | N/A | N/A | N/A |
| HP | Pavilion t000_puffer | KRJ51201TV | N/A | N/A | N/A |
| SPEAG | SPEAG HAC Phantom | - | N/A | N/A | N/A |
| SPEAG | Light Alignment Sensor | 265 | N/A | N/A | N/A |
| SPEAG | DAE3 | 466 | 07/21/09 | Annual | 07/21/10 |
| SPEAG | E-Field Probe | 2343 | 05/22/09 | Annual | 05/22/10 |
| SPEAG | H-Field Probe | 6101 | 05/22/09 | Annual | 05/22/10 |
| SPEAG | Validation Dipole CD835V2 | 1024 | 03/11/08 | Biennial | 03/11/10 |
| SPEAG | Validation Dipole CD1880V2 | 1019 | 03/11/08 | Biennial | 03/11/10 |
| Agilent | Power Meter(F) E4419B | MY41291386 | 11/05/08 | Annual | 11/05/09 |
| Agilent | Power Sensor(G) 8481 | MY41090870 | 11/05/08 | Annual | 11/05/09 |
| HP | Signal Generator E4438C | MY42082646 | 12/24/08 | Annual | 12/24/09 |
| EM POWER | Power Amp BBS3Q7ELU | 1009D/C0028 | 11/05/08 | Annual | 11/05/09 |
| HP | Dual Directional Coupler 778D | 16072 | 11/05/08 | Annual | 11/05/09 |
| R&S | Base Station CMU200 | 110740 | 07/26/09 | Annual | 07/26/10 |
| Agilent | Base Station E5515C | GB44400269 | 02/10/09 | Annual | 02/10/10 |
| R&S | Spectrum Analyzer FSP30 | 839117/011 | 07/31/09 | Annual | 07/31/10 |

NOTE:

The probe was calibrated by SPEAG, by the waveguide technique procedure. Dipole Validation measurement is performed by HCT Lab. before each test.

13. CONCLUSION

The HAC measurement indicates that the EUT complies with the HAC limits of the ANSI-C63.19-2007.

These measurements are taken to simulate the RF effects exposure under worst-case conditions. Precise Laboratory measures were taken to assure repeatability of the tests.