



# HCT CO., LTD.

Product Compliance Division

TEL : +82 31 639 8518 FAX : +82 31 639 8535

## FCC Certification

<b>Applicant Name:</b> PANTECH CO., LTD.	<b>Date of Issue:</b> December 09, 2010
<b>Address:</b> Pantech Building, I-2, DMC, Sangam-dong, Mapo-gu, Seoul, Korea(ZIP: 121-792)	<b>Location:</b> HCT CO., LTD., 105-1, Jangam-ri, Majang-Myeon, Icheon-si, Kyunggi-Do, Korea(Lab)
	<b>Test Report No.:</b> HCTR1012FR11
	<b>HCT FRN:</b> 0005866421
	<b>IC Recognition No.:</b> IC 5944A-2

<b>FCC ID</b>	<b>: JYCP6010</b>
<b>APPLICANT</b>	<b>: PANTECH CO., LTD.</b>

<b>FCC Model(s):</b>	P6010
<b>EUT Type:</b>	GSM/ WCDMA Phone with Bluetooth
<b>FCC Classification:</b>	Licensed Portable Transmitter Held to Ear (PCE)
<b>Tx Frequency:</b>	824.20 - 848.80 MHz (GSM850) 826.40 - 846.60 MHz (WCDMA850) 1 850.20 - 1 909.80 MHz (GSM1900) 1 852.4 - 1 907.6 MHz (WCDMA1900)
<b>Rx Frequency:</b>	869.20 - 893.80 MHz (GSM850) 871.40 - 891.60 (WCDMA850) 1 930.20 - 1 989.80 MHz (GSM1900) 1 932.4 - 1 987.6 MHz (WCDMA1900)
<b>Max. RF Output Power:</b>	0.804 W ERP GSM850 (29.05 dBm) / 0.741 W EIRP GSM1900 (28.70 dBm) 0.608 W ERP EDGE850 (27.84 dBm) / 0.655 W EIRP EDGE1900 (28.16 dBm) 0.214 W ERP WCDMA850(23.30 dBm) / 0.267 W EIRP WCDMA1900(24.26 dBm)
<b>Emission Designator(s):</b>	250KGXW (GSM850) 247KGXW (GSM1900) 245 KG7W (GSM850 EDGE) 245 KG7W (GSM1900 EDGE) 4M18F9W (WCDMA850) 4M18F9W (WCDMA1900)
<b>FCC Rule Part(s):</b>	§22, §24, §2

The measurements shown in this report were made in accordance with the procedures specified in §2.947. I assume full responsibility for the accuracy and completeness of these measurements, and for the qualifications of all persons taking them.

HCT CO., LTD. Certifies that no party to this application has subject to a denial of Federal benefits that includes FCC benefits pursuant to section 5301 of the Anti-Drug Abuse Act of 1998,21 U.S. C.853(a)

  
**Report prepared by**  
**: Hyo Sun Kwak**  
**Test engineer of RF Team**

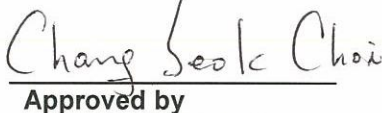
  
**Approved by**  
**: Chang Seok Choi**  
**Manager of RF Team**

This report only responds to the tested sample and may not be reproduced, except in full, without written approval of the HCT Co., Ltd.

FCC CERTIFICATION REPORT				<a href="http://www.hct.co.kr">www.hct.co.kr</a>
Test Report No. HCTR1012FR11	Date of Issue: December 09, 2010	EUT Type: GSM/ WCDMA Phone with Bluetooth	FCC ID: JYCP6010	Page 1 of 61

# Version

TEST REPORT NO.	DATE	DESCRIPTION
HCTR1012FR11	December 09, 2010	First Approval Report

# Table of Contents

1. GENERAL INFORMATION .....	4
2. INTRODUCTION .....	5
2.1. EUT DESCRIPTION.....	5
2.2. MEASURING INSTRUMENT CALIBRATION.....	5
2.3. TEST FACILITY .....	5
3. DESCRIPTION OF TESTS .....	6
3.1 EFFECTIVE RADIATED POWER/EQUIVALENT ISOTROPIC RADIATED POWER.....	6
3.2 PEAK- TO- AVERAGE RATIO .....	7
3.3 OCCUPIED BANDWIDTH. ....	8
3.4 SPURIOUS AND HARMONIC EMISSIONS AT ANTENNA TERMINAL.....	9
3.5 RADIATED SPURIOUS AND HARMONIC EMISSIONS .....	10
3.6 FREQUENCY STABILITY / VARIATION OF AMBIENT TEMPERATURE .....	11
4. LIST OF TEST EQUIPMENT .....	12
5. SUMMARY OF TEST RESULTS .....	13
6. SAMPLE CALCULATION .....	14
7. TEST DATA .....	15
7.1 CONDUCTED OUTPUT POWER .....	15
7.2 PEAK-TO-AVERAGE RATIO .....	17
7.3 OCCUPIED BANDWIDTH .....	17
7.4 CONDUCTED SPURIOUS EMISSIONS .....	18
7.4.1 BAND EDGE.....	18
7.5 EFFECTIVE RADIATED POWER OUTPUT (GSM / WCDMA) .....	19
7.6 EQUIVALENT ISOTROPIC RADIATED POWER (GSM / WCDMA).....	20
7.7 RADIATED SPURIOUS EMISSIONS .....	21
7.7.1 RADIATED SPURIOUS EMISSIONS (GSM850).....	21
7.7.2 RADIATED SPURIOUS EMISSIONS (GSM1900).....	22
7.7.3 RADIATED SPURIOUS EMISSIONS (WCDMA850).....	23
7.7.4 RADIATED SPURIOUS EMISSIONS (WCDMA1900).....	24
7.8 FREQUENCY STABILITY / VARIATION OF AMBIENT TEMPERATURE .....	25
7.8.1 FREQUENCY STABILITY (GSM850) .....	25
7.8.2 FREQUENCY STABILITY (GSM1900) .....	26
7.8.3 FREQUENCY STABILITY (WCDMA850) .....	27
7.8.4 FREQUENCY STABILITY (WCDMA1900) .....	28
8. TEST PLOTS.....	29



# MEASUREMENT REPORT

## 1. GENERAL INFORMATION

**Applicant Name:** PANTECH CO., LTD.

**Address:** Pantech Building, I-2, DMC, Sangam-dong, Mapo-gu, Seoul, Korea(ZIP: 121-792)

**FCC ID:** JYCP6010

**Application Type:** Certification

**FCC Classification:** Licensed Portable Transmitter Held to Ear (PCE)

**FCC Rule Part(s):** §22, §24, §2

**EUT Type:** GSM/ WCDMA Phone with Bluetooth

**FCC Model(s):** P6010

**Battery** Model Name: PBR-55dD(Standard)  
Power Rating: 3.7 V, 1000 mAh, 3.7 Wh  
Type: Lithium-Ion Battery

**Tx Frequency:** 824.20 - 848.80 MHz (GSM850)  
826.40 - 846.60 MHz (WCDMA850)  
1 850.20 - 1 909.80 MHz (GSM1900)  
1 852.4 - 1 907.6 MHz (WCDMA1900)

**Rx Frequency:** 869.20 - 893.80 MHz (GSM850)  
871.40 - 891.60 (WCDMA850)  
1 930.20 - 1 989.80 MHz (GSM1900)  
1 932.4 - 1 987.6 MHz (WCDMA1900)

**Max. RF Output Power:** 0.804 W ERP GSM850 (29.05 dBm) / 0.741 W EIRP GSM1900 (28.70 dBm)  
0.608 W ERP EDGE850 (27.84 dBm) / 0.655 W EIRP EDGE1900 (28.16 dBm)  
0.214 W ERP WCDMA850(23.30 dBm) / 0.267 W EIRP WCDMA1900(24.26 dBm)

**Emission Designator(s):** 250KGXW (GSM850) 247KGXW (GSM1900)  
245 KG7W (GSM850 EDGE) 245 KG7W (GSM1900 EDGE)  
4M18F9W (WCDMA850) 4M18F9W (WCDMA1900)

**Antenna Specification** Manufacturer: DONGNAM C), Ltd.  
Antenna type: Internal Antenna  
Peak Gain: 4.80 dBi

**Date(s) of Tests:** December 01, 2010 ~ December 07, 2010

FCC CERTIFICATION REPORT				<a href="http://www.hct.co.kr">www.hct.co.kr</a>
Test Report No. HCTR1012FR11	Date of Issue: December 09, 2010	EUT Type: GSM/ WCDMA Phone with Bluetooth	FCC ID: JYCP6010	Page 4 of 61



## 2. INTRODUCTION

### 2.1. EUT DESCRIPTION

The PANTECH CO., LTD. P6010 GSM/ WCDMA Phone with Bluetooth consists of GSM850, GSM1900, GPRS Class10, EDGE, WCDMA850, WCDMA1900 and HSDPA.

### 2.2. MEASURING INSTRUMENT CALIBRATION

The measuring equipment, which was utilized in performing the tests documented herein, has been calibrated in accordance with the manufacturer's recommendations for utilizing calibration equipment, which is traceable to recognized national standards.

### 2.3. TEST FACILITY

The SAC(Semi-Anechoic Chamber) and conducted measurement facility used to collect the radiated data are located at the 105-1, Jangam-ri, Majang-Myeon, Icheon-si, Kyunggi-Do, 467-811, Korea. The site is constructed in conformance with the requirements of ANSI C63.4 and CISPR Publication 22. Detailed description of test facility was submitted to the Commission and accepted dated June 10, 2009 (Registration Number: 90661)

FCC CERTIFICATION REPORT				<a href="http://www.hct.co.kr">www.hct.co.kr</a>
Test Report No. HCTR1012FR11	Date of Issue: December 09, 2010	EUT Type: GSM/ WCDMA Phone with Bluetooth	FCC ID: JYCP6010	Page 5 of 61

### 3. DESCRIPTION OF TESTS

#### 3.1 EFFECTIVE RADIATED POWER/EQUIVALENT ISOTROPIC RADIATED POWER

##### Test Set-up

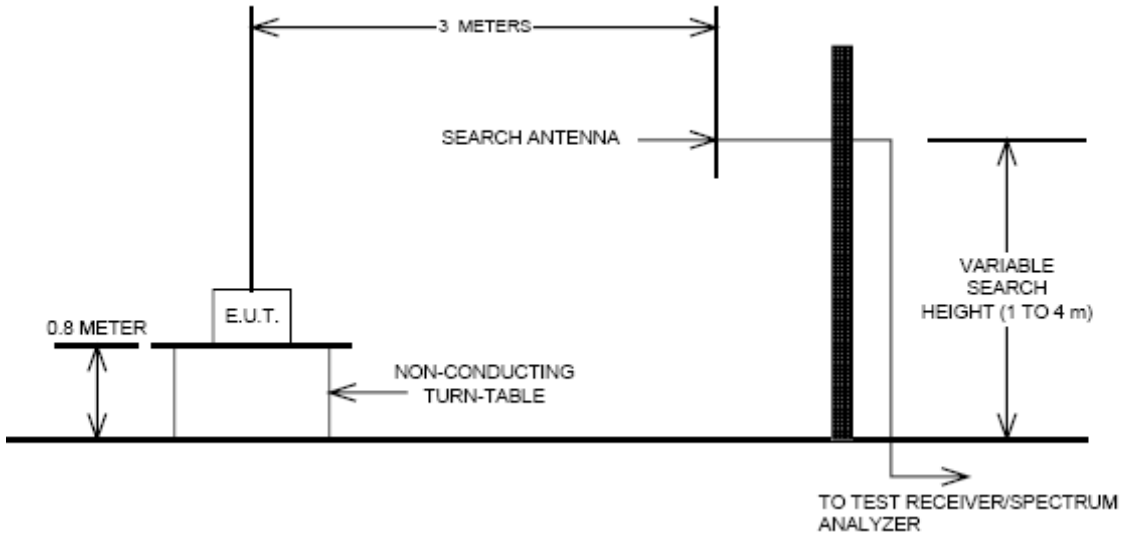

##### Test Procedure

Radiated emission measurements were performed at an SAC(Semi-Anechoic Chamber)

The equipment under test is placed on a non-conductive styrofoam resin table 3-meters from the receive antenna. A styrofoam turntable was rotated 360° and the receiving antenna scanned from 1-4m in order to capture the maximum emission. A half wave dipole was substituted in place of the EUT. This dipole antenna was driven by a signal generator and the previously recorded signal was duplicated.

The maximum EIRP was calculated by adding the forward power to the calibrated source plus its appropriate gain value. These steps were carried out with the receiving antenna in both vertical and horizontal polarization. For readings above 1GHz, the above procedure is repeated using horn antennas and the difference between the gain of the horn and an isotropic antenna are taken into consideration.



### 3.2 PEAK- TO- AVERAGE RATIO

A peak to average ratio measurement is performed at the conducted port of the EUT. For CDMA and WCDMA signals, the spectrum analyzers Complementary Cumulative Distribution Function ( CCDF ) measurement profile is used to determine the largest deviation between the average and the peak power of the EUT in a given bandwidth. The CCDF curve shows how much time the peak waveform spends at or above a given average power level. The percent of time the signal spends at or above the level defines the probability for that particular power level. For GSM signals, an average and a peak trace are used on a

spectrum analyzer to determine the largest deviation between the average and the peak power of the EUT in a bandwidth greater than the emission bandwidth. Plots of the EUT's Peak- to- Average Ratio are shown herein.

FCC CERTIFICATION REPORT				<a href="http://www.hct.co.kr">www.hct.co.kr</a>
Test Report No. HCTR1012FR11	Date of Issue: December 09, 2010	EUT Type: GSM/ WCDMA Phone with Bluetooth	FCC ID: JYCP6010	Page 7 of 61

### 3.3 OCCUPIED BANDWIDTH.

#### Test set-up

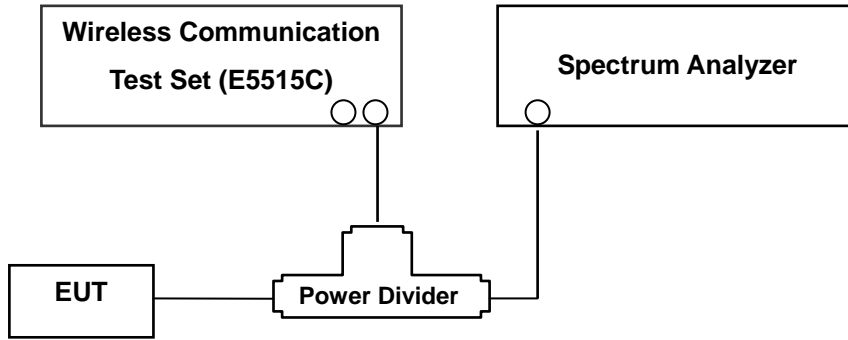

(Configuration of conducted Emission measurement)

#### Test Procedure

The EUT was setup to maximum output power at its lowest channel. The occupied bandwidth was measured using a spectrum analyzer. The measurements are repeated for the highest and a middle channel. The EUT's occupied bandwidth is measured as the width of the signal between two points, one below the carrier center frequency and one above the carrier frequency, outside of which all emissions are attenuated at least 26 dB below the transmitter power. Plots of the EUT's occupied bandwidth are shown herein.





### 3.4 SPURIOUS AND HARMONIC EMISSIONS AT ANTENNA TERMINAL.

#### Test Procedure

The level of the carrier and the various conducted spurious and harmonic frequencies is measured by means of a calibrated spectrum analyzer.

The EUT was setup to maximum output power at its lowest channel. The Resolution BW of the analyzer is set to 1 % of the emission bandwidth to show compliance with the – 13 dBm limit, in the 1 MHz bands immediately outside and adjacent to the edge of the frequency block. The 1 MHz RBW was used to scan from 10 MHz to 10 GHz. (GSM1900 Mode: 10 MHz to 20 GHz). A display line was placed at – 13 dBm to show compliance. The high, lowest and a middle channel were tested for out of band measurements.

- Band Edge Requirement : In the 1MHz bands immediately outside and adjacent to the frequency block, a resolution bandwidth of at least 1 percent of the emission bandwidth of the fundamental emission of the transmitter may be employed to measure the out of band Emissions. Limit, -13dBm.

FCC CERTIFICATION REPORT				<a href="http://www.hct.co.kr">www.hct.co.kr</a>
Test Report No. HCTR1012FR11	Date of Issue: December 09, 2010	EUT Type: GSM/ WCDMA Phone with Bluetooth	FCC ID: JYCP6010	Page 9 of 61

### 3.5 RADIATED SPURIOUS AND HARMONIC EMISSIONS

#### Test Set-up

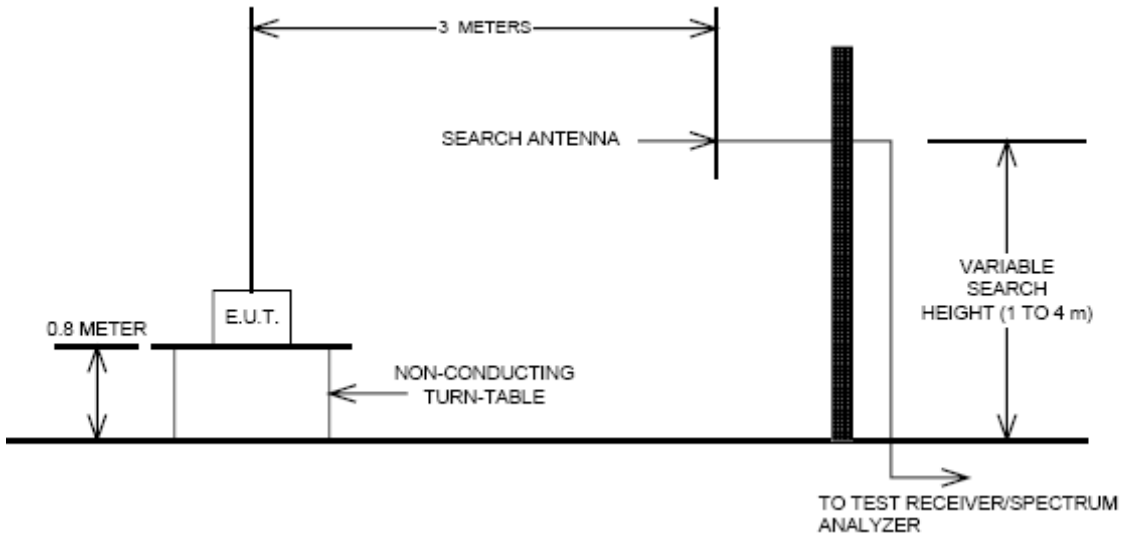

The measurement facilities used for this test have been documented in previous filings with the commission pursuant to section § 2.948. The SAC(Semi-Anechoic Chamber) meets requirements in ANSI C63.4 –2003. A mast capable of lifting the receiving antenna from a height of one to four meters is used together with a rotatable styrofoam platform mounted at three from the antenna mast.

- 1) The unit mounted on a styrofoam turntable 1.5 m × 1.0 m × 0.80 m is 0.8 meter above test site ground level.
- 2) During the emission test, the turntable is rotated and the EUT is manipulated to find the configuration resulting in maximum emission under normal condition of installation and operation.
- 3) The antenna height and polarization are also varied from 1 to 4 meters until the maximum signal is found.
- 4) The spectrum shall be scanned up to the 10<sup>th</sup> harmonic of the fundamental frequency.

#### Test Procedure

The equipment under test is placed on a non-conductive styrofoam resin table 3-meters from the receive antenna. A styrofoam turntable was rotated 360° and the receiving antenna scanned from 1-4m in order to capture the maximum emission. A half wave dipole was substituted in place of the EUT. This dipole antenna was driven by a signal generator and the previously recorded signal was duplicated.

The maximum EIRP was calculated by adding the forward power to the calibrated source plus its appropriate gain value. These steps were carried out with the receiving antenna in both vertical and horizontal polarization. For readings above 1GHz, the above procedure is repeated using horn antennas and the difference between the gain of the horn and an isotropic antenna are taken into consideration.

### 3.6 FREQUENCY STABILITY / VARIATION OF AMBIENT TEMPERATURE

#### Test Set-up

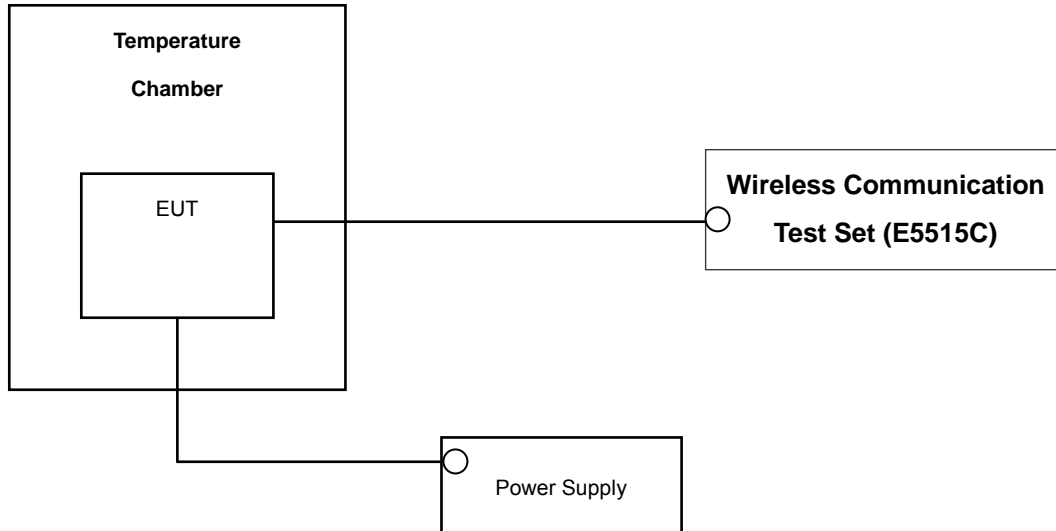

\* Nominal Operating Voltage

#### Test Procedure

The frequency stability of the transmitter is measured by:

- a.) **Temperature:** The temperature is varied from - 30 °C to + 50 °C using an environmental chamber.
- b.) **Primary Supply Voltage:** The primary supply voltage is varied from battery end point to 115 % of the voltage normally at the input to the device or at the power supply terminals if cables are not normally supplied.

Specification — the frequency stability shall be sufficient to ensure that the fundamental emission stays within the authorized frequency block. The frequency stability of the transmitter shall be maintained within  $\pm 0.00025\%$  ( $\pm 2.5$  ppm) of the center frequency.

#### Time Period and Procedure:

The carrier frequency of the transmitter is measured at room temperature (20°C to provide a reference).

1. The equipment is turned on in a “standby” condition for one minute before applying power to the transmitter. Measurement of the carrier frequency of the transmitter is made within one minute after applying power to the transmitter.
2. Frequency measurements are made at 10°C intervals ranging from -30°C to +50°C. A period of at least one half-hour is provided to allow stabilization of the equipment at each temperature level.

**NOTE: The EUT is tested down to the battery endpoint.**

## 4. LIST OF TEST EQUIPMENT

Manufacture	Model/ Equipment	Serial Number	Calibration Interval	Calibration Due
R&S	ESI40/ Spectrum Analyzer	831564/003	Annual	10/29/2011
Agilent	E4416A/ Power Meter	GB41291412	Annual	01/14/2011
Agilent	E9327A/ Power Sensor	MY4442009	Annual	07/23/2011
Agilent	8960 (E5515C)/ Base Station	GB44400269	Annual	02/10/2011
MITEQ	AMF-6D-001180-35-20P/AMP	990893	Annual	05/20/2011
Wainwright	WHK1.2/15G-10EF/H.P.F	2	Annual	06/25/2011
Wainwright	WHK3.3/18G-10EF/H.P.F	1	Annual	06/25/2011
Agilent	775D/ Dual Directional Coupler	12922	Annual	12/24/2010
Agilent	11636B/ Power Divider	11377	Annual	12/24/2010
Digital	EP-3010/ Power Supply	3110117	Annual	01/08/2011
Schwarzbeck	UHAP/ Dipole Antenna	585	Biennial	02/13/2011
Schwarzbeck	UHAP/ Dipole Antenna	558	Biennial	02/13/2011
Korea Engineering	KR-1005L / Chamber	KRAB07063-2CH	Annual	12/28/2010
Schwarzbeck	BBHA 9120D/ Horn Antenna	296	Biennial	09/23/2011
Schwarzbeck	BBHA 9120D/ Horn Antenna	147	Biennial	04/13/2012
Agilent	E4440A/Spectrum Analyzer	US45303008	Annual	06/09/2011

## 5. SUMMARY OF TEST RESULTS

FCC Part Section(s)	Test Description	Test Limit	Test Condition	Test Result
2.1049, 22.917(a), 24.238(a)	Occupied Bandwidth	N/A	CONDUCTED	PASS
2.1051, 22.917(a), 24.238(a)	Band Edge / Spurious and Harmonic Emissions at Antenna Terminal.	< 43 + 10log10 (P[Watts]) at Band Edge and for all out-of-band emissions		PASS
2.1046	Conducted Output Power	-		PASS
24.232(d)	Peak- to- Average Ratio	< 13 dB		PASS
2.1055, 22.355, 24.235	Frequency stability / variation of ambient temperature	< 2.5 ppm		PASS
22.913(a)(2) 24.232(c)	Effective Radiated Power	< 7 Watts max. ERP	RADIATED	PASS
	Equivalent Isotropic Radiated Power	< 2 Watts max. EIRP		PASS
2.1053, 22.917(a), 24.238(a)	Radiated Spurious and Harmonic Emissions	< 43 + 10log10 (P[Watts]) for all out-of band emissions		PASS

## 6. SAMPLE CALCULATION

### A. ERP Sample Calculation

Mode	Ch./ Freq.		Measured Level(dBm)	Substitute LEVEL(dBm)	Ant. Gain	C.L	Pol.	ERP	
	channel	Freq.(MHz)						W	dBm
GSM850	128	824.20	-11.56	34.28	-8.32	1.17	H	0.30	24.79

**ERP = SubstituteLEVEL(dBm) + Ant. Gain – CL(Cable Loss)**

- 1) The EUT mounted on a wooden tripod is 0.8 meter above test site ground level.
- 2) During the test , the turn table is rotated and the antenna height is also varied from 1 to 4 meters until the maximum signal is found.
- 3) Record the field strength meter's level.
- 4) Replace the EUT with dipole/Horn antenna that is connected to a calibrated signal generator.
- 5) Increase the signal generator output till the field strength meter's level is equal to the item (3).
- 6) The signal generator output level with Ant. Gain and cable loss are the rating of effective radiated power (ERP).

### B. Emission Designator

#### GSM Emission Designator

**Emission Designator = 249KGXW**

GSM BW = 249 kHz

G = Phase Modulation

X = Cases not otherwise covered

W = Combination (Audio/Data)

#### WCDMA Emission Designator

**Emission Designator = 4M17F9W**

WCDMA BW = 4.17 MHz

F = Frequency Modulation

9 = Composite Digital Info

W = Combination (Audio/Data)

## 7. TEST DATA

### 7.1 CONDUCTED OUTPUT POWER

A base station simulator was used to establish communication with the EUT. The base station simulator parameters were set to produce the maximum power from the EUT. This device was tested under all configurations and the highest power is reported. Conducted Output Powers of EUT are reported below.

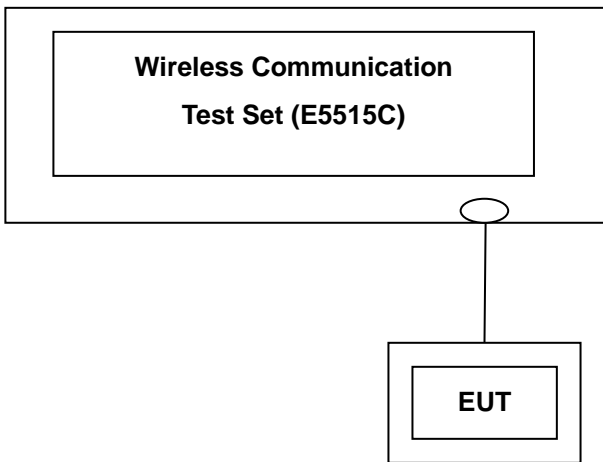

#### Test Result

Band	Channel	Voice	GPRS Data	
		GSM (dBm)	GPRS 1 TX Slot (dBm)	GPRS 2 TX Slot (dBm)
GSM 850	128	32.41	32.41	32.38
	190	32.40	32.40	32.37
	251	32.38	32.38	32.36
GSM 1900	512	29.85	29.84	29.81
	661	30.02	30.01	29.99
	810	30.13	30.13	30.10

(GSM Conducted Maximum Output Powers)

Band	Channel	EDGE Data	
		EDGE 1 TX Slot (dBm)	EDGE 2 TX Slot (dBm)
GSM 850	128	26.89	26.90
	190	26.89	26.89
	251	26.88	26.87
GSM 1900	512	25.90	25.89
	661	26.09	26.07
	810	26.22	26.21

(GSM EDGE Conducted Output Powers)

3GPP Release Version	Mode	3GPP 34.121	Cellular Band [dBm]			MPR
		Subtest	UL 4132 (826.4)	UL 4183 (836.6)	UL 4233 (846.6)	
			DL 4357	DL 4408	DL 4458	
99	WCDMA	12.2 kbps RMC	23.12	22.97	23.05	-
99	WCDMA	12.2 kbps AMR	23.11	22.95	23.04	-
5	HSDPA	Subtest 1	23.04	22.91	23.04	0

3GPP Release Version	Mode	3GPP 34.121	PCS Band [dBm]			MPR
		Subtest	UL 9262 (1852.4)	UL 9400 (1880.0)	UL 9538 (1907.6)	
			DL 9662	DL 9800	DL 9938	
99	WCDMA	12.2 kbps RMC	23.01	22.90	22.68	-
99	WCDMA	12.2 kbps AMR	23.00	22.88	22.65	-
5	HSDPA	Subtest 1	22.97	22.87	22.41	0

(WCDMA Conducted Output Powers)

Note : Detecting mode is average.



## 7.2 PEAK-TO-AVERAGE RATIO

- Plots of the EUT's Peak- to- Average Ratio are shown Page 34, 37.

## 7.3 OCCUPIED BANDWIDTH

Band	Channel	Frequency(MHz)	Data (GSM: kHz / WCDMA : MHz)
GSM850	128	824.20	244.6344
	190	836.60	242.5998
	251	848.80	249.5359
GSM850 EDGE	251	848.80	244.4810
GSM1900	512	1850.20	246.7330
	661	1880.00	246.3078
	810	1909.80	246.4267
GSM1900 EDGE	512	1850.20	244.5259
WCDMA850	4132	826.40	4.1683
	4183	836.60	4.1762
	4233	846.60	4.1637
WCDMA1900	9262	1852.40	4.1443
	9400	1880.00	4.1583
	9538	1907.60	4.1794

- Plots of the EUT's Occupied Bandwidth are shown Page 30 ~ 33, 34 ~ 37.

## 7.4 CONDUCTED SPURIOUS EMISSIONS

Band	Channel	Frequency of Maximum Harmonic (GHz)	Maximum Data (dBm)
GSM850	128	7.3500	-30.89
	190	6.9625	-30.53
	251	7.6375	-30.16
GSM1900	512	14.7470	-26.89
	661	14.8800	-26.93
	810	14.3730	-27.51
WCDMA850	4132	7.3875	-38.87
	4183	7.0500	-39.47
	4233	6.9625	-38.75
WCDMA1900	9262	3.7020	-29.79
	9400	14.2930	-36.77
	9538	13.7070	-37.08

- Plots of the EUT's Conducted Spurious Emissions are shown Page 50 ~ 61.

### 7.4.1 BAND EDGE

- Plots of the EUT's Band Edge are shown Page 38 ~ 49.

## 7.5 EFFECTIVE RADIATED POWER OUTPUT (GSM / WCDMA)

### (GSM850 Mode)

Ch./ Freq.		Measured Level(dBm)	Substitute LEVEL (dBm)	Ant. Gain (dBd)	C.L	Pol.	ERP	
channel	Freq.(MHz)						W	dBm
128	824.20	-7.88	39.88	-10.24	1.17	V	0.70	28.47
190	836.60	-8.52	40.11	-10.36	1.19	V	0.72	28.56
251	848.80	-8.75	40.73	-10.48	1.20	V	0.80	29.05
EDGE 128	824.20	-8.51	39.25	-10.24	1.17	V	0.61	27.84

### (WCDMA850 Mode)

Ch./ Freq.		Measured Level(dBm)	Substitute LEVEL (dBm)	Ant. Gain (dBd)	C.L	Pol.	ERP	
channel	Freq.(MHz)						W	dBm
4132	826.40	-15.62	32.29	-10.26	1.17	V	0.12	20.86
4183	836.60	-15.87	32.76	-10.36	1.19	V	0.13	21.21
4233	846.60	-14.37	34.96	-10.46	1.20	V	0.21	23.30

Note: Standard batteries are the only options for this phone

#### NOTES:

Effective Radiated Power Output Measurements by Substitution Method according to ANSI/TIA/EIA-603-C-2004, Aug. 17, 2004:

The EUT was placed on a wooden turn table 3-meters from the receive antenna. The receive antenna height and turntable rotation was adjusted for the highest reading on the receive spectrum analyzer. For CDMA signals, a peak detector is used, with RBW = VBW = 3 MHz. For WCDMA signals, a peak detector is used, with RBW = VBW = 5MHz. For AMPS, GSM, and NADC TDMA signals, a peak detector is used, with RBW = VBW = 1 MHz. A half-wave dipole was substituted in place of the EUT. This dipole antenna was driven by a signal generator and the level of the signal generator was adjusted to obtain the same receive spectrum analyzer reading. The conducted power at the terminals of the dipole is measured. The ERP is recorded.

This device was tested under all configurations and the highest power is reported in WCDMA mode with HSDPA Inactive at 12.2 kbps RMC and TPC bits all set to "1" and in GSM mode and using a Power Control Level of "0" in the PCS Band and "5" in the Cellular Band. This unit was tested with its standard battery. Also, we have done x, y, z planes in EUT and horizontal and vertical polarization in detecting antenna. The worst case of the EUT is y plane in GSM850 and WCDMA850 mode. Also worst case of detecting Antenna is vertical polarization in GSM850 and WCDMA850 mode.

The EDGE mode testing were performed using 1Tx because 1Tx is highest power in EDGE mode.

FCC CERTIFICATION REPORT				<a href="http://www.hct.co.kr">www.hct.co.kr</a>
Test Report No. HCTR1012FR11	Date of Issue: December 09, 2010	EUT Type: GSM/ WCDMA Phone with Bluetooth	FCC ID: JYCP6010	Page 19 of 61

## 7.6 EQUIVALENT ISOTROPIC RADIATED POWER (GSM / WCDMA)

### (GSM1900 Mode)

Ch./ Freq.		Measured Level(dBm)	Substitute LEVEL (dBm)	Ant. Gain (dBi)	C.L	Pol.	EIRP	
channel	Freq.(MHz)						W	dBm
512	1,850.20	-12.10	19.15	10.40	1.91	H	0.58	27.64
661	1,880.00	-11.33	20.11	10.43	1.95	H	0.72	28.59
810	1,909.80	-11.29	20.20	10.47	1.97	H	0.74	28.70
EDGE 810	1,909.80	-11.83	19.66	10.47	1.97	H	0.65	28.16

### (WCDMA1900 Mode)

Ch./ Freq.		Measured Level(dBm)	Substitute LEVEL (dBm)	Ant. Gain (dBi)	C.L	Pol.	EIRP	
channel	Freq.(MHz)						W	dBm
9262	1,852.40	-16.87	14.39	10.40	1.91	H	0.19	22.88
9400	1,880.00	-15.70	15.74	10.43	1.95	H	0.26	24.22
9538	1,907.60	-15.75	15.76	10.47	1.97	H	0.27	24.26

Note: Standard batteries are the only options for this phone

#### NOTES:

#### Equivalent Isotropic Radiated Power Measurements by Substitution Method

according to ANSI/TIA/EIA-603-C-2004, Aug. 17, 2004:

The EUT was placed on a wooden turn table 3-meters from the receive antenna. The receive antenna height and turntable rotation was adjusted for the highest reading on the receive spectrum analyzer. For CDMA signals, a peak detector is used, with RBW = VBW = 3 MHz. For WCDMA signals, a peak detector is used, with RBW = VBW = 5MHz. For AMPS, GSM, and NADC TDMA signals, a peak detector is used, with RBW = VBW = 1 MHz. A Horn antenna was substituted in place of the EUT. This Horn antenna was driven by a signal generator and the level of the signal generator was adjusted to obtain the same receive spectrum analyzer reading. The conducted power at the terminals of the Horn antenna is measured. The difference between the gain of the horn and an isotropic antenna is taken into consideration and the EIRP is recorded.

This device was tested under all configurations and the highest power is reported in WCDMA mode with HSDPA Inactive at 12.2 kbps RMC and TPC bits all set to "1" and in GSM mode and using a Power Control Level of "0" in the PCS Band and "5" in the Cellular Band. This unit was tested with its standard battery. Also, we have done x, y, z planes in EUT and horizontal and vertical polarization in detecting antenna. The worst case of the EUT is x plane in GSM1900 and WCDMA1900 mode. Also worst case of detecting Antenna is in horizontal polarization in GSM1900 and WCDMA1900 mode.

The EDGE mode testing were performed using 1Tx because 1Tx is highest power in EDGE mode.

FCC CERTIFICATION REPORT				<a href="http://www.hct.co.kr">www.hct.co.kr</a>
Test Report No. HCTR1012FR11	Date of Issue: December 09, 2010	EUT Type: GSM/ WCDMA Phone with Bluetooth	FCC ID: JYCP6010	Page 20 of 61

## 7.7 RADIATED SPURIOUS EMISSIONS

### 7.7.1 RADIATED SPURIOUS EMISSIONS (GSM850)

- MEASURED OUTPUT POWER: 29.05 dBm = 0.804W
- MODULATION SIGNAL: GSM850
- DISTANCE: 3 meters
- LIMIT:  $-(43 + 10 \log_{10}(W)) =$  - 42.05 dBc

Ch.	Freq.(MHz)	Measured Level [dBm]	Ant. Gain (dBd)	Substitute Level [dBm]	C.L	Pol.	ERP (dBm)	dBc
128 (824.2)	1,648.40	-43.06	8.57	-55.07	1.73	H	-48.23	-77.28
	2,472.60	-39.85	11.10	-49.94	2.28	H	-41.12	-70.17
	3,296.80	-	-	-	-	-	-	-
190 (836.6)	1,673.20	-47.85	8.57	-59.95	1.79	H	-53.17	-82.22
	2,509.80	-42.40	11.15	-52.54	2.33	V	-43.72	-72.77
	3,346.40	-	-	-	-	-	-	-
251 (848.8)	1,697.60	-49.14	8.57	-60.91	1.83	H	-54.17	-83.22
	2,546.40	-48.70	11.15	-58.92	2.34	H	-50.11	-79.16
	3,395.20	-	-	-	-	-	-	-

- NOTES:**
1. Radiated Spurious Emission Measurements at 3 meters by Substitution Method according to ANSI/TIA/EIA-603-C-2004, Aug. 17, 2004:
  2. The magnitude of spurious emissions attenuated more than 20dB below the limit above 5<sup>th</sup> Harmonic for all channel.
  3. we have done x, y, z planes in EUT and horizontal and vertical polarization in detecting antenna.

### 7.7.2 RADIATED SPURIOUS EMISSIONS (GSM1900)

- MEASURED OUTPUT POWER: 28.70 dBm = 0.741 W
- MODULATION SIGNAL: GSM1900
- DISTANCE: 3 meters
- LIMIT: - (43 + 10 log<sub>10</sub> (W)) = - 41.70 dBc

Ch.	Freq.(MHz)	Measured Level [dBm]	Ant. Gain (dBi)	Substitute Level [dBm]	C.L	Pol.	EIRP (dBm)	dBc
-512 (1850.2)	3,700.40	-45.60	12.25	-51.66	2.73	V	-42.14	-70.84
	5,550.60	-47.83	12.59	-49.30	3.60	H	-40.31	-69.01
	7,400.80	-	-	-	-	-	-	-
661 (1880.0)	3,760.00	-47.63	12.25	-53.38	2.73	V	-43.86	-72.56
	5,640.00	-45.96	12.51	-47.37	3.60	H	-38.46	-67.16
	7,520.00	-	-	-	-	-	-	-
810 (1909.8)	3,819.60	-49.37	12.37	-55.13	2.73	V	-45.49	-74.19
	5,729.40	-47.52	12.43	-48.46	3.60	H	-39.63	-68.33
	7,639.20	-	-	-	-	-	-	-

- NOTES:**
1. Radiated Spurious Emission Measurements at 3 meters by Substitution Method according to ANSI/TIA/EIA-603-C-2004, Aug. 17, 2004:
  2. The magnitude of spurious emissions attenuated more than 20dB below the limit above 5<sup>th</sup> Harmonic for all channel.
  3. we have done x, y, z planes in EUT and horizontal and vertical polarization in detecting antenna.

### 7.7.3 RADIATED SPURIOUS EMISSIONS (WCDMA850)

- MEASURED OUTPUT POWER: 23.30 dBm = 0.214 W
- MODULATION SIGNAL: WCDMA850
- DISTANCE: 3 meters
- LIMIT: - (43 + 10 log<sub>10</sub> (W)) = - 36.30 dBc

Ch.	Freq.(MHz)	Measured Level [dBm]	Ant. Gain (dBd)	Substitute Level [dBm]	C.L	Pol.	ERP (dBm)	dBc
4,132 (826.4)	1,652.80	-56.31	8.57	-68.35	1.73	H	-61.51	-84.81
	2,479.20	-53.50	11.10	-63.60	2.28	H	-54.78	-78.08
	3,305.60	-53.11	12.65	-63.60	2.57	V	-53.52	-76.82
4,183 (836.6)	1,673.20	-55.62	8.57	-67.72	1.79	H	-60.94	-84.24
	2,509.80	-53.59	11.15	-63.73	2.33	V	-54.91	-78.21
	3,346.40	-55.11	12.65	-65.80	2.66	H	-55.81	-79.11
4,233 (846.6)	1,693.20	-56.50	8.57	-68.32	1.83	H	-61.58	-84.88
	2,539.80	-47.47	11.15	-57.67	2.34	V	-48.86	-72.16
	3,386.40	-52.62	12.69	-63.05	2.85	H	-53.21	-76.51

- NOTES:**
1. Radiated Spurious Emission Measurements at 3 meters by Substitution Method according to ANSI/TIA/EIA-603-C-2004, Aug. 17, 2004:
  2. The magnitude of spurious emissions attenuated more than 20dB below the limit above 5<sup>th</sup> Harmonic for all channel.
  3. we have done x, y, z planes in EUT and horizontal and vertical polarization in detecting antenna.

#### 7.7.4 RADIATED SPURIOUS EMISSIONS (WCDMA1900)

- MEASURED OUTPUT POWER: 24.26 dBm = 0.267 W
- MODULATION SIGNAL: WCDMA1900
- DISTANCE: 3 meters
- LIMIT:  $-(43 + 10 \log_{10}(W)) =$  - 37.26 dBc

Ch.	Freq.(MHz)	Measured Level [dBm]	Ant. Gain (dBi)	Substitute Level [dBm]	C.L	Pol.	EIRP (dBm)	dBc
9262	3,704.80	-40.28	12.46	-46.52	2.73	H	-36.79	-61.05
	5,557.20	-	-	-	-	-	-	-
	7,409.60	-	-	-	-	-	-	-
9400	3,760.00	-41.10	12.47	-47.07	2.73	H	-37.33	-61.59
	5,640.00	-	-	-	-	-	-	-
	7,520.00	-	-	-	-	-	-	-
9538	3,815.20	-39.75	12.46	-45.62	2.73	H	-35.89	-60.15
	5,722.80	-	-	-	-	-	-	-
	7,630.40	-	-	-	-	-	-	-

- NOTES:**
1. Radiated Spurious Emission Measurements at 3 meters by Substitution Method according to ANSI/TIA/EIA-603-C-2004, Aug. 17, 2004:
  2. The magnitude of spurious emissions attenuated more than 20dB below the limit above 5<sup>th</sup> Harmonic for all channel.
  3. we have done x, y, z planes in EUT and horizontal and vertical polarization in detecting antenna.



## 7.8 FREQUENCY STABILITY / VARIATION OF AMBIENT TEMPERATURE

### 7.8.1 FREQUENCY STABILITY (GSM850)

OPERATING FREQUENCY: 836,600,000 Hz  
 CHANNEL: 190  
 REFERENCE VOLTAGE: 3.7 VDC  
 DEVIATION LIM IT: ± 0.000 25 % or 2.5 ppm

Voltage (%)	Power (VDC)	Temp. (°C)	Frequency (Hz)	Frequency Error (Hz)	Deviation (%)	ppm
100%	3.700	+20(Ref)	836 600 033	0	0.000 000	0.000
100%		-30	836 599 967	-32.71	-0.000 004	-0.039
100%		-20	836 599 962	-37.52	-0.000 004	-0.045
100%		-10	836 599 965	-34.81	-0.000 004	-0.042
100%		0	836 599 964	-35.52	-0.000 004	-0.042
100%		+10	836 599 960	-39.74	-0.000 005	-0.048
100%		+30	836 599 959	-40.99	-0.000 005	-0.049
100%		+40	836 599 965	-34.67	-0.000 004	-0.041
100%		+50	836 599 962	-38.29	-0.000 005	-0.046
115%		4.255	+20	836 599 961	-39.37	-0.000 005
Batt. Endpoint	3.400	+20	836 599 965	-34.54	-0.000 004	-0.041

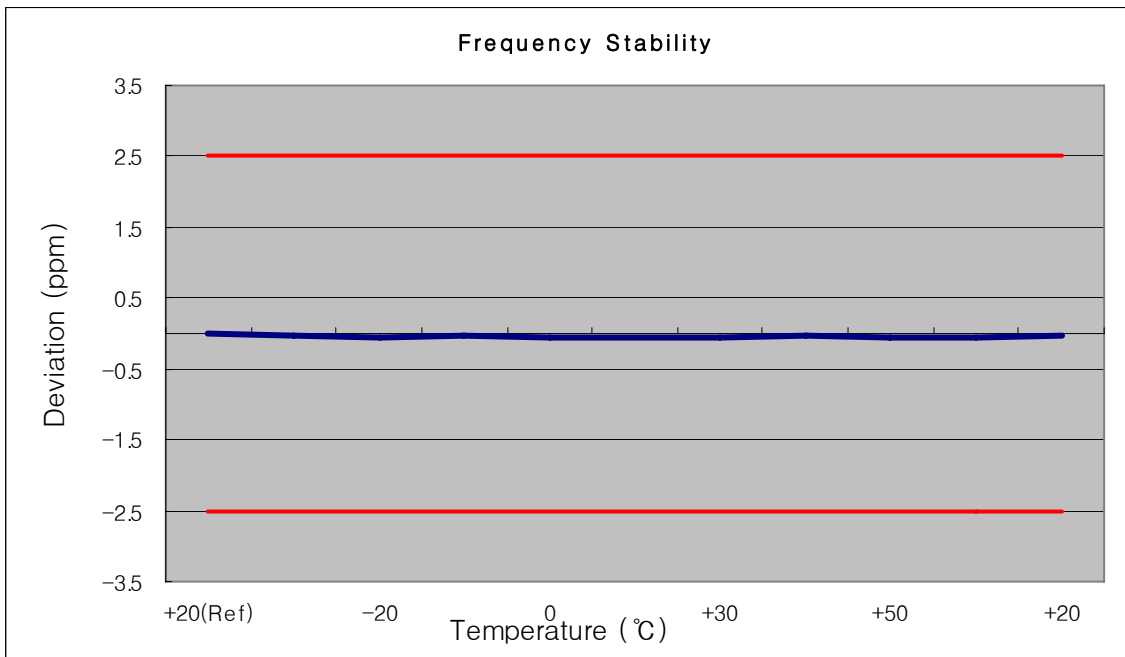

### 7.8.2 FREQUENCY STABILITY (GSM1900)

OPERATING FREQUENCY: 1880,000,000 Hz  
 CHANNEL: 661  
 REFERENCE VOLTAGE: 3.7 VDC  
 DEVIATION LIM IT: ± 0.000 25 % or 2.5 ppm

Voltage (%)	Power (VDC)	Temp. (°C)	Frequency (Hz)	Frequency Error (Hz)	Deviation (%)	ppm
100%	3.700	+20(Ref)	1879 999 980	0	0.000 000	0.000
100%		-30	1880 000 039	38.64	0.000 002	0.021
100%		-20	1880 000 040	39.87	0.000 002	0.021
100%		-10	1880 000 030	29.73	0.000 002	0.016
100%		0	1880 000 023	22.95	0.000 001	0.012
100%		+10	1880 000 021	21.20	0.000 001	0.011
100%		+30	1880 000 023	23.44	0.000 001	0.012
100%		+40	1880 000 041	41.16	0.000 002	0.022
100%		+50	1880 000 029	28.76	0.000 002	0.015
115%		4.255	+20	1880 000 029	29.14	0.000 002
Batt. Endpoint	3.400	+20	1880 000 042	41.70	0.000 002	0.022

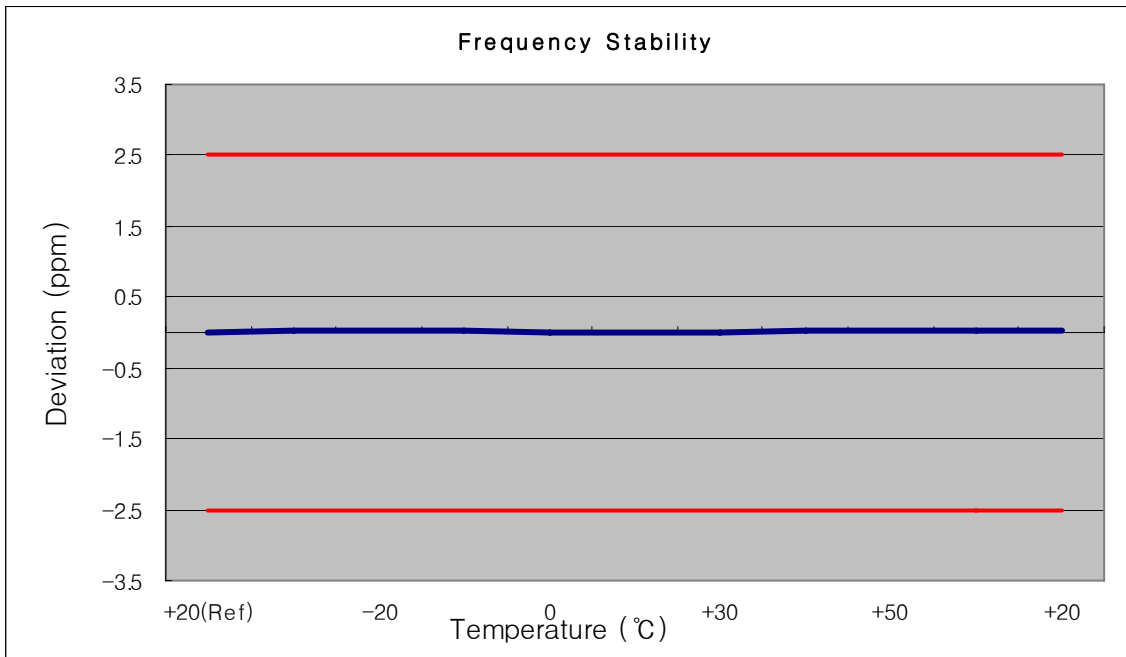

### 7.8.3 FREQUENCY STABILITY (WCDMA850)

OPERATING FREQUENCY: 836,600,000 Hz  
 CHANNEL: 4183  
 REFERENCE VOLTAGE: 3.7 VDC  
 DEVIATION LIM IT: ± 0.000 25 % or 2.5 ppm

Voltage (%)	Power (VDC)	Temp. (°C)	Frequency (Hz)	Frequency Error (Hz)	Deviation (%)	ppm
100%	3.700	+20(Ref)	836 600 002	0	0.000 000	0.000
100%		-30	836 600 000	0.13	0.000 000	0.000
100%		-20	836 599 990	-10.05	-0.000 001	-0.012
100%		-10	836 599 995	-4.60	-0.000 001	-0.005
100%		0	836 599 993	-7.40	-0.000 001	-0.009
100%		+10	836 599 989	-10.65	-0.000 001	-0.013
100%		+30	836 599 996	-4.25	-0.000 001	-0.005
100%		+40	836 599 999	-1.45	0.000 000	-0.002
100%		+50	836 599 997	-3.29	0.000 000	-0.004
115%	4.255	+20	836 600 004	3.81	0.000 000	0.005
Batt. Endpoint	3.400	+20	836 599 996	-4.02	0.000 000	-0.005

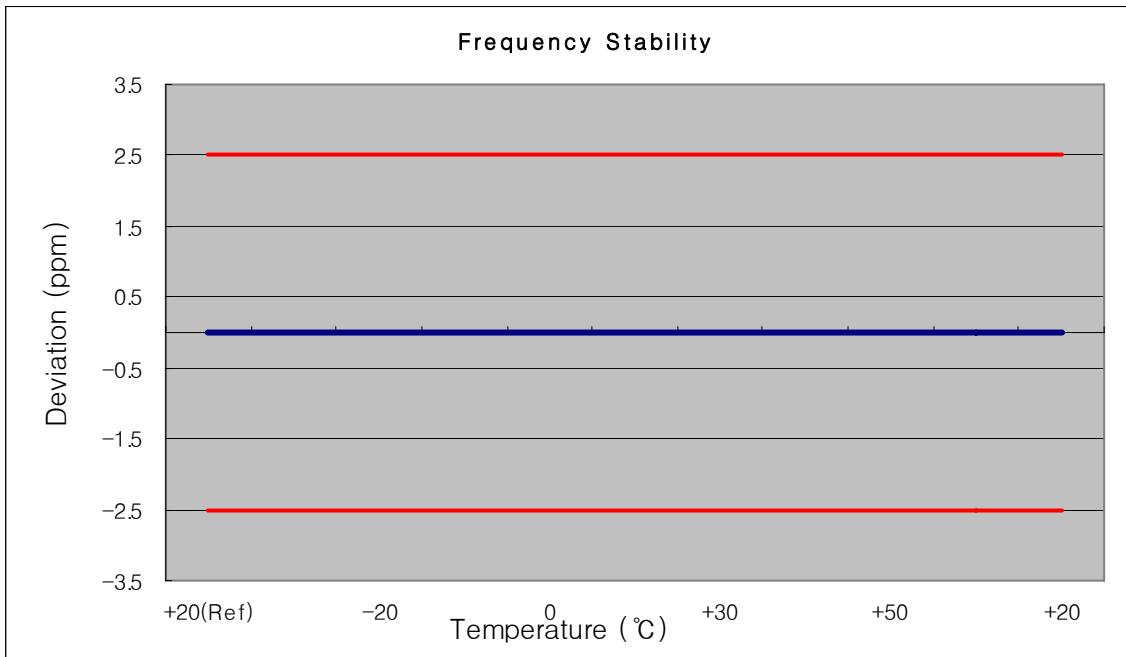

### 7.8.4 FREQUENCY STABILITY (WCDMA1900)

OPERATING FREQUENCY: 1,880,000,000 Hz  
 CHANNEL: 9400  
 REFERENCE VOLTAGE: 3.7 VDC  
 DEVIATION LIM IT: ± 0.000 25 % or 2.5 ppm

Voltage (%)	Power (VDC)	Temp. (°C)	Frequency (Hz)	Frequency Error (Hz)	Deviation (%)	ppm
100%	3.700	+20(Ref)	1880 000 030	0	0.000 000	0.000
100%		-30	1879 999 987	-13.33	-0.000 001	-0.007
100%		-20	1879 999 980	-19.58	-0.000 001	-0.010
100%		-10	1879 999 977	-22.77	-0.000 001	-0.012
100%		0	1879 999 983	-17.02	-0.000 001	-0.009
100%		+10	1879 999 977	-22.87	-0.000 001	-0.012
100%		+30	1880 000 005	4.91	0.000 000	0.003
100%		+40	1879 999 988	-11.85	-0.000 001	-0.006
100%		+50	1879 999 978	-21.53	-0.000 001	-0.011
115%	4.255	+20	1879 999 989	-11.44	-0.000 001	-0.006
Batt. Endpoint	3.400	+20	1879 999 981	-19.01	-0.000 001	-0.010

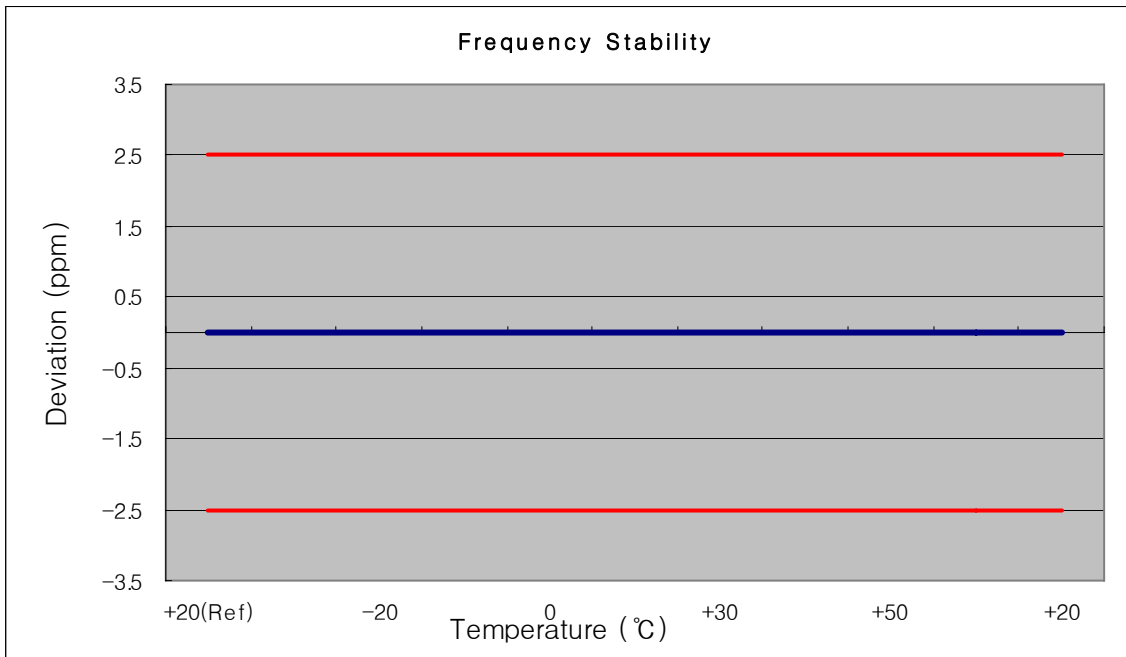



## 8. TEST PLOTS

FCC CERTIFICATION REPORT				<a href="http://www.hct.co.kr">www.hct.co.kr</a>
Test Report No. HCTR1012FR11	Date of Issue: December 09, 2010	EUT Type: GSM/ WCDMA Phone with Bluetooth	FCC ID: JYCP6010	Page 29 of 61

■ GSM850 MODE (128 CH.) Occupied Bandwidth



■ GSM850 MODE (190 CH.) Occupied Bandwidth

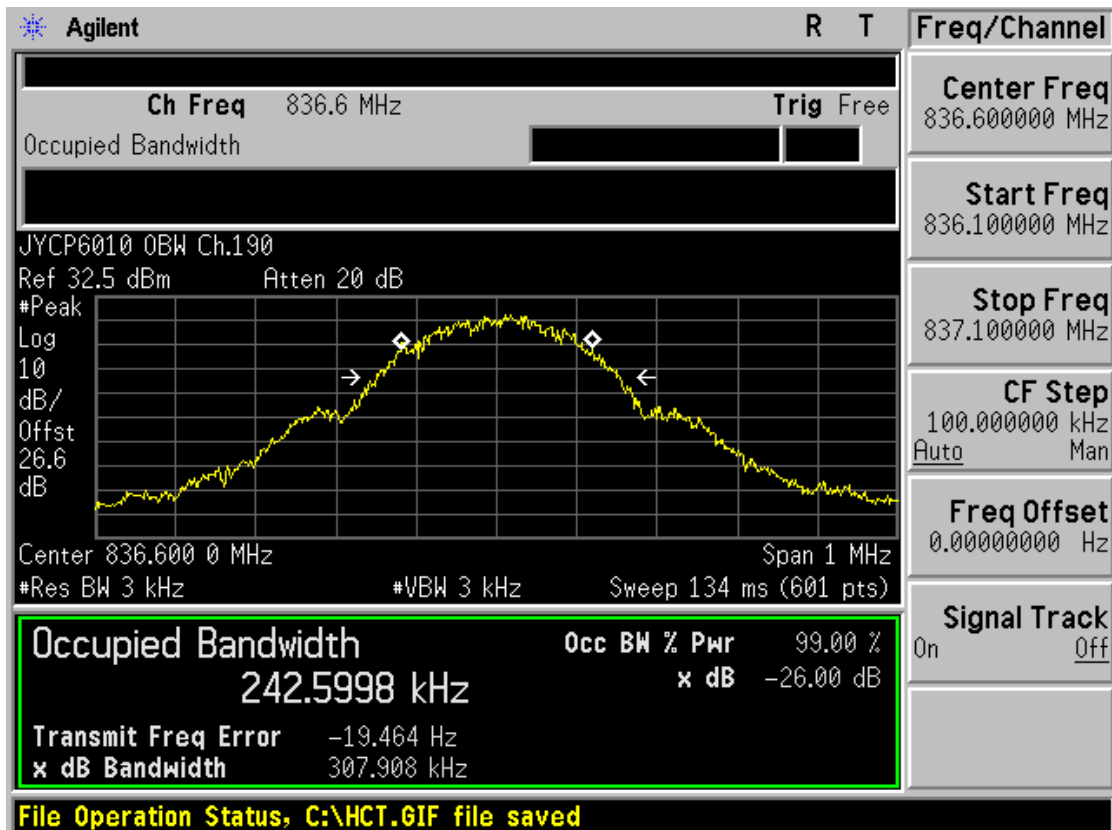

■ GSM850 MODE (251 CH.) Occupied Bandwidth



■ GSM850 EDGE (251 CH.) Occupied Bandwidth

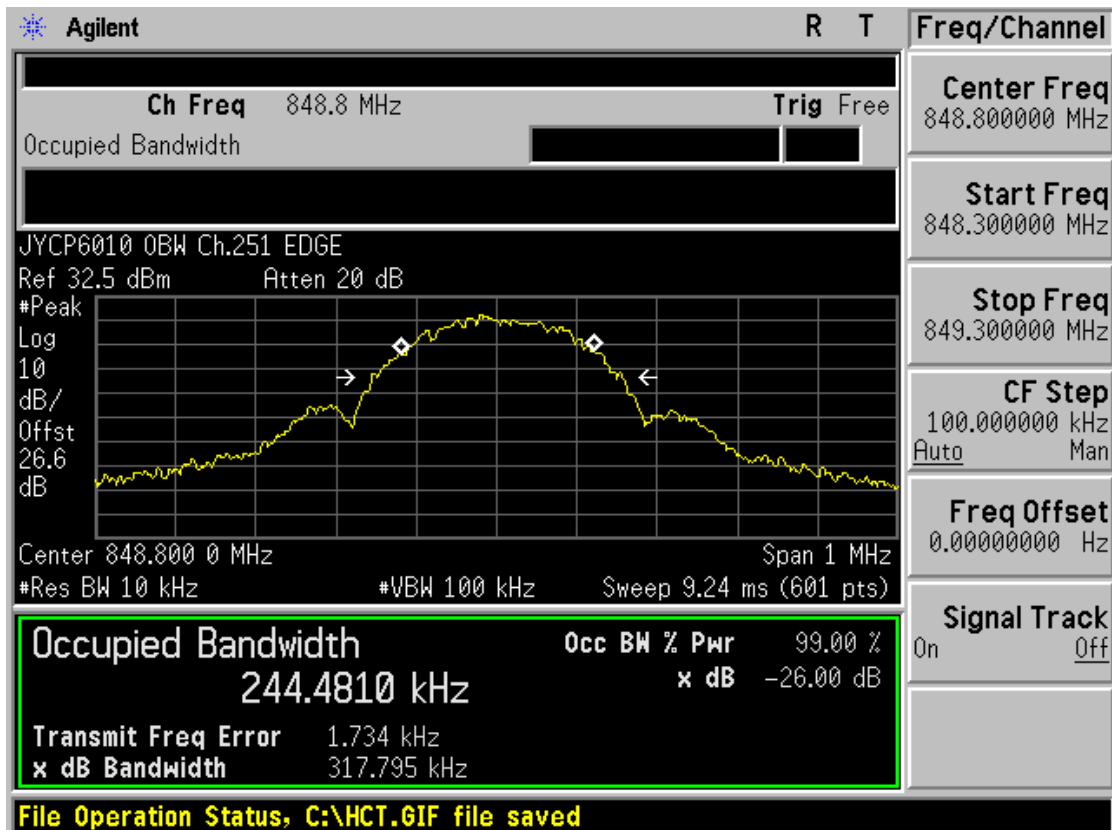

FCC CERTIFICATION REPORT

Test Report No. HCTR1012FR11	Date of Issue: December 09, 2010	EUT Type: GSM/ WCDMA Phone with Bluetooth	FCC ID: JYCP6010	<a href="http://www.hct.co.kr">www.hct.co.kr</a> Page 31 of 61
---------------------------------	-------------------------------------	--	---------------------	---

■ GSM1900 MODE (512 CH.) Occupied Bandwidth



■ GSM1900 MODE (661 CH.) Occupied Bandwidth

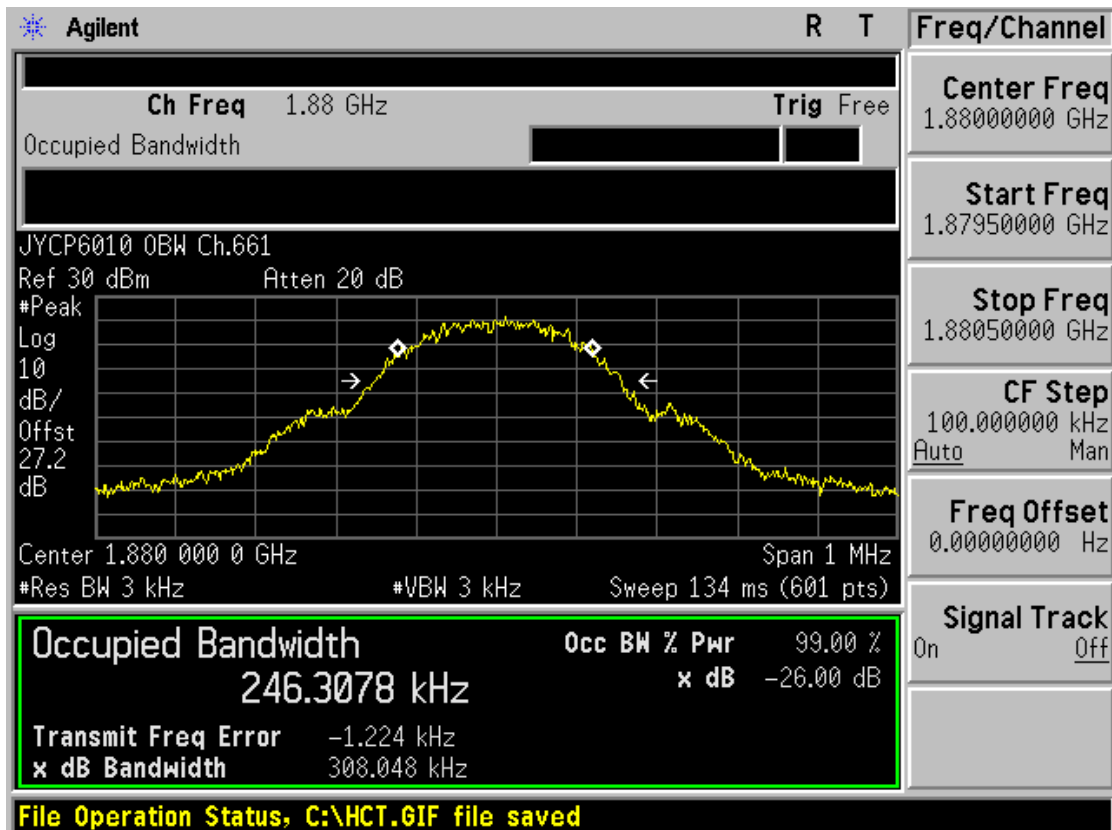

FCC CERTIFICATION REPORT

Test Report No. HCTR1012FR11	Date of Issue: December 09, 2010	EUT Type: GSM/ WCDMA Phone with Bluetooth	FCC ID: JYCP6010	Page 32 of 61
---------------------------------	-------------------------------------	--	---------------------	---------------



■ GSM1900 MODE (810 CH.) Occupied Bandwidth

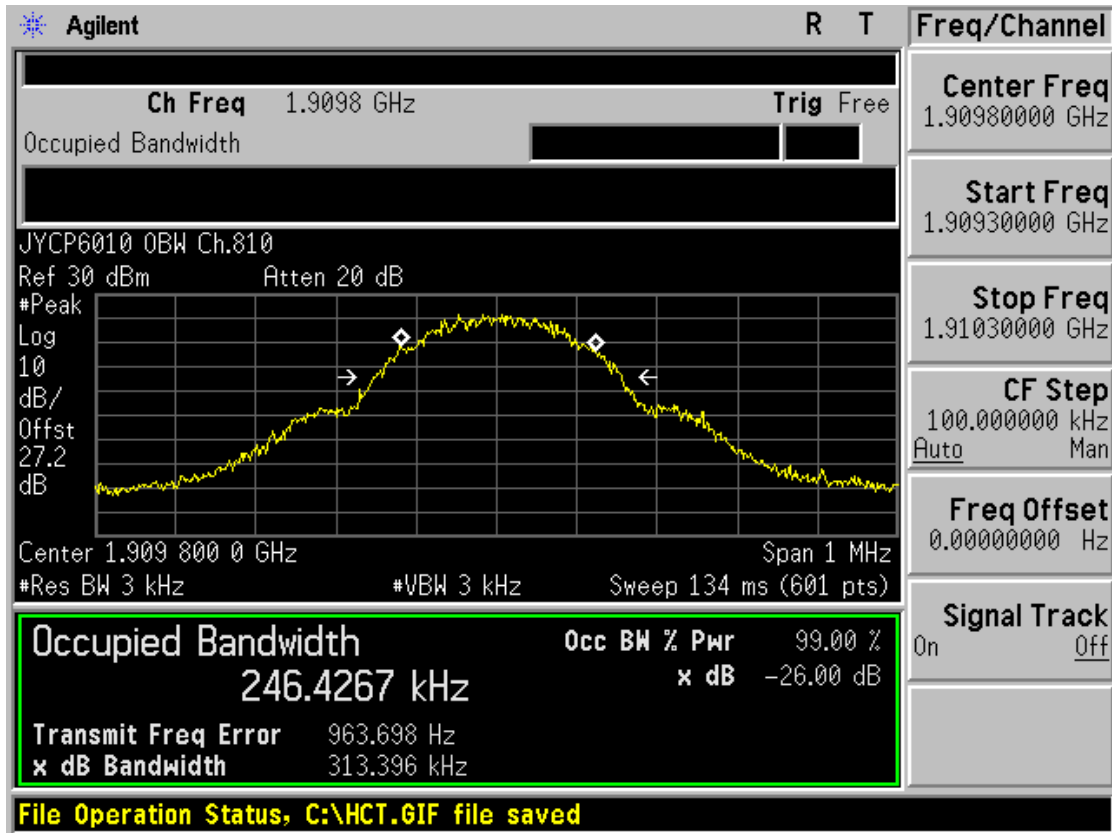

■ GSM1900 EDGE (512 CH.) Occupied Bandwidth

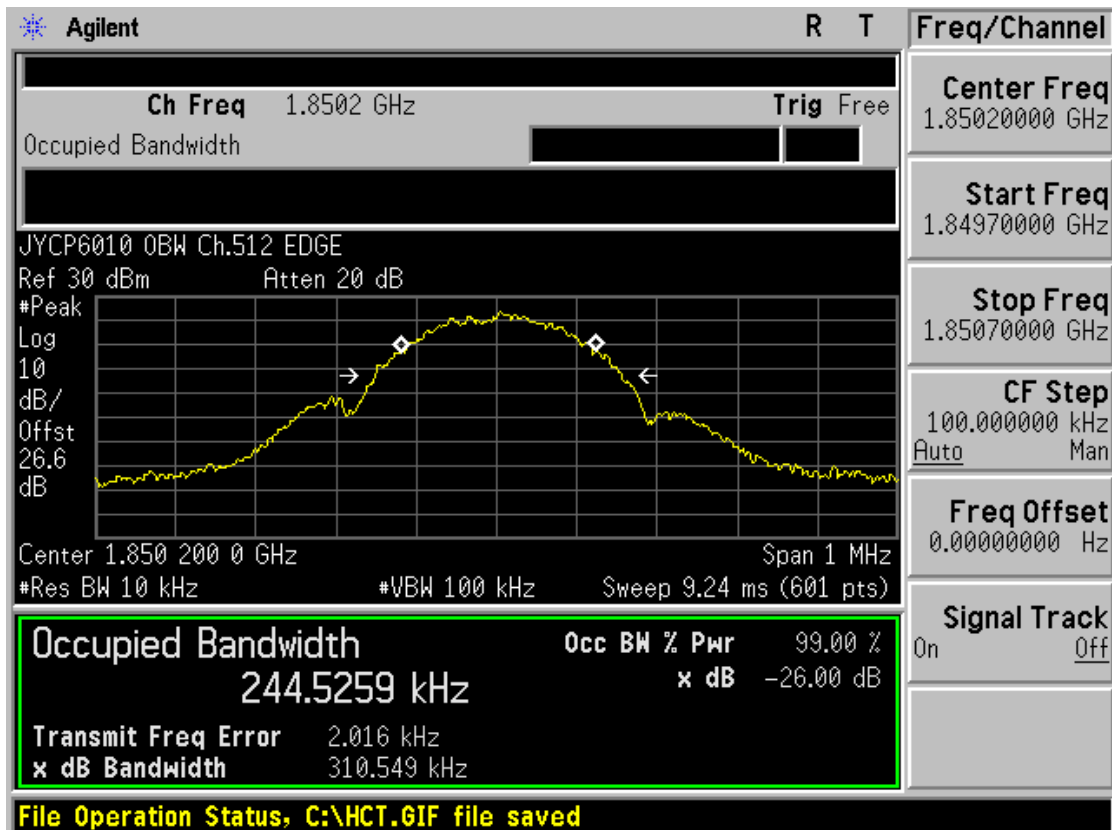

■ GSM1900 MODE (661 CH.) Peak-to-Average Ratio

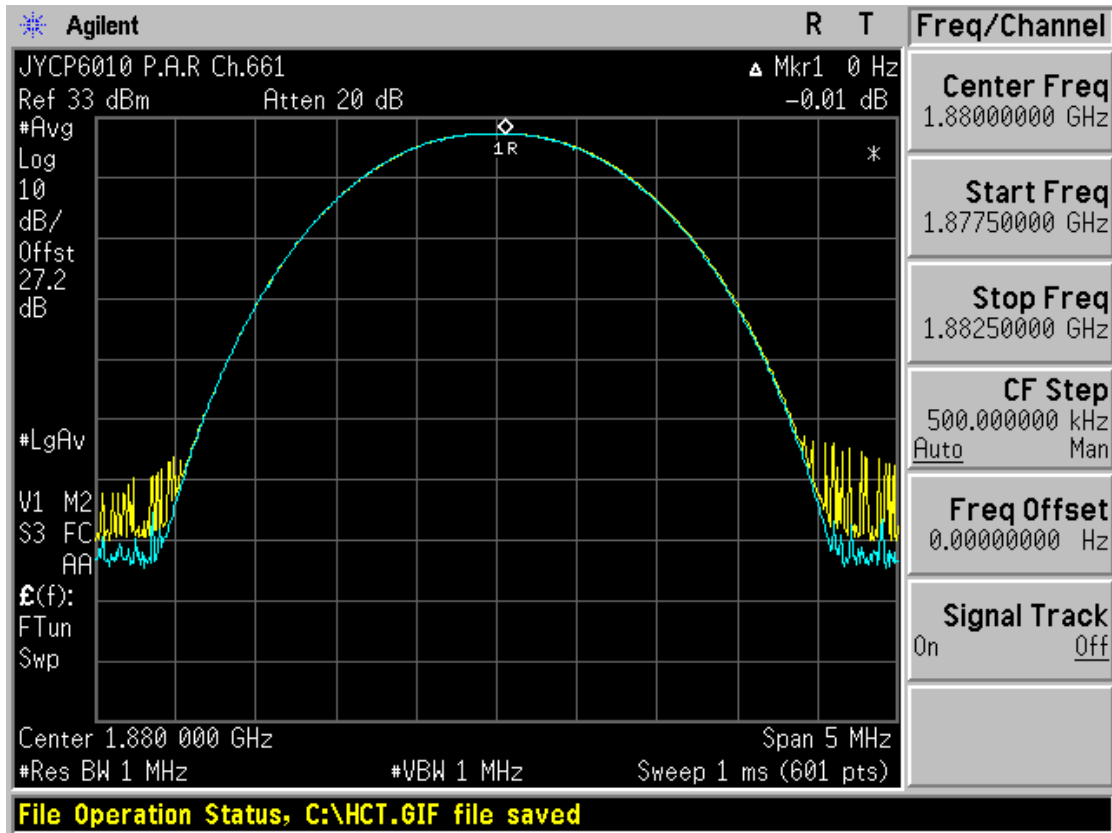

■ WCDMA850 MODE (4132 CH.) Occupied Bandwidth

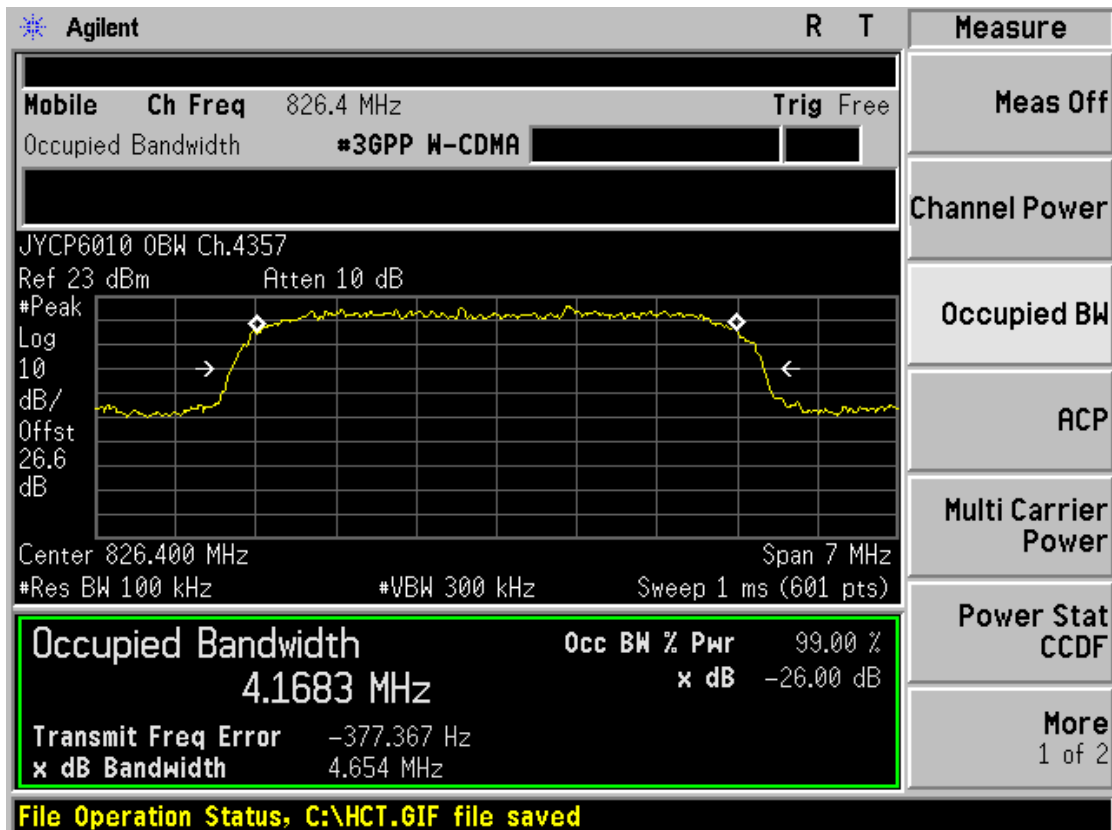

■ WCDMA850 MODE (4183 CH.) Occupied Bandwidth

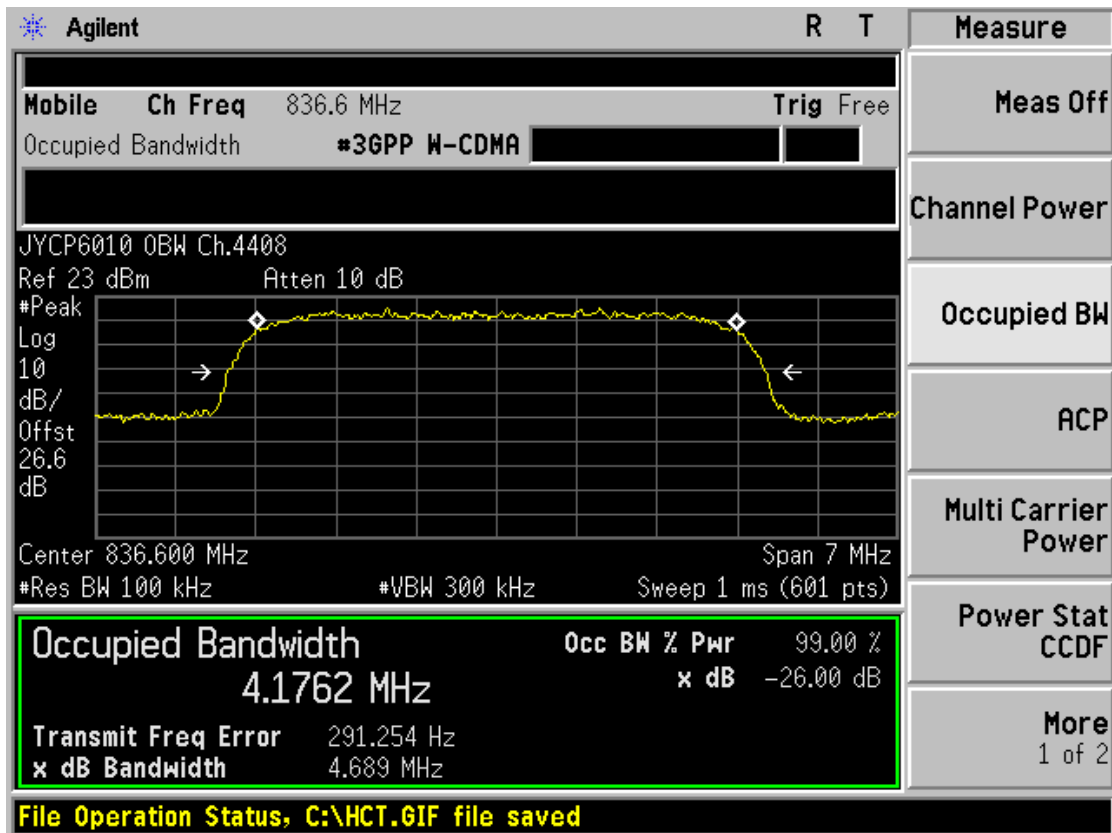

■ WCDMA850MODE (4233 CH.) Occupied Bandwidth

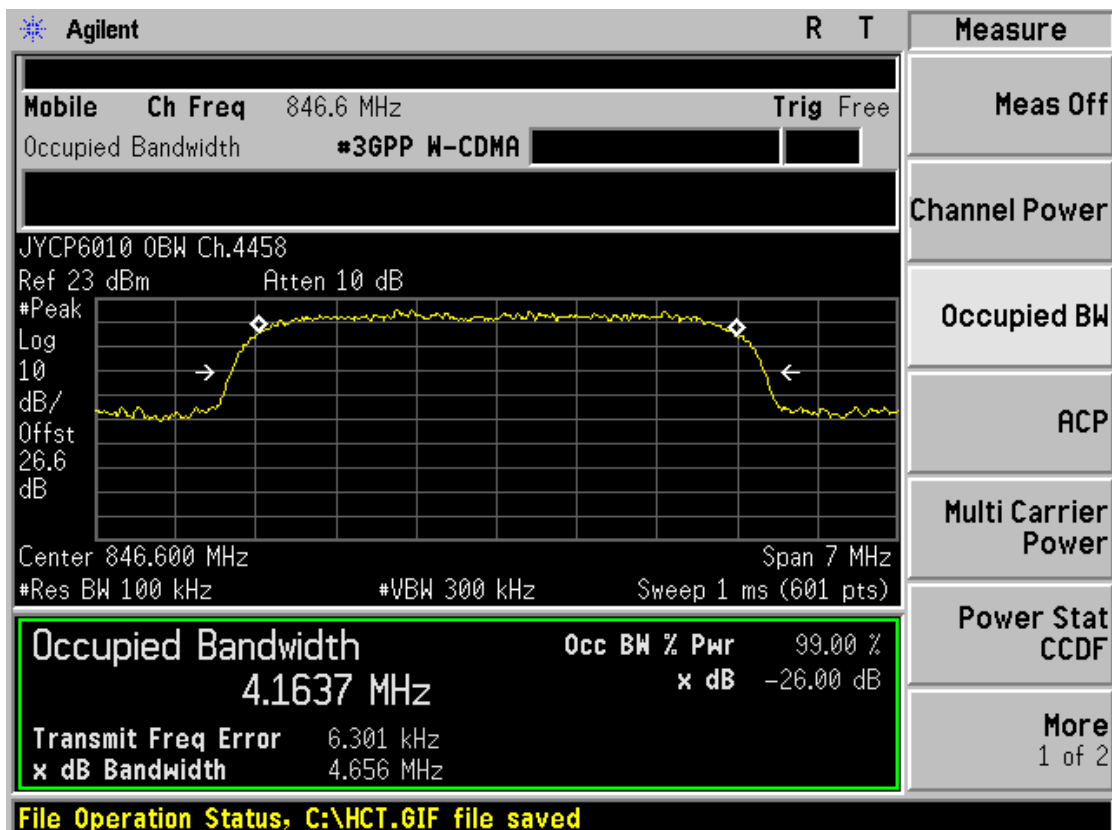

FCC CERTIFICATION REPORT

FCC CERTIFICATION REPORT			<a href="http://www.hct.co.kr">www.hct.co.kr</a>	
Test Report No. HCTR1012FR11	Date of Issue: December 09, 2010	EUT Type: GSM/ WCDMA Phone with Bluetooth	FCC ID: JYCP6010	Page 35 of 61

■ WCDMA1900 MODE (9262 CH.) Occupied Bandwidth

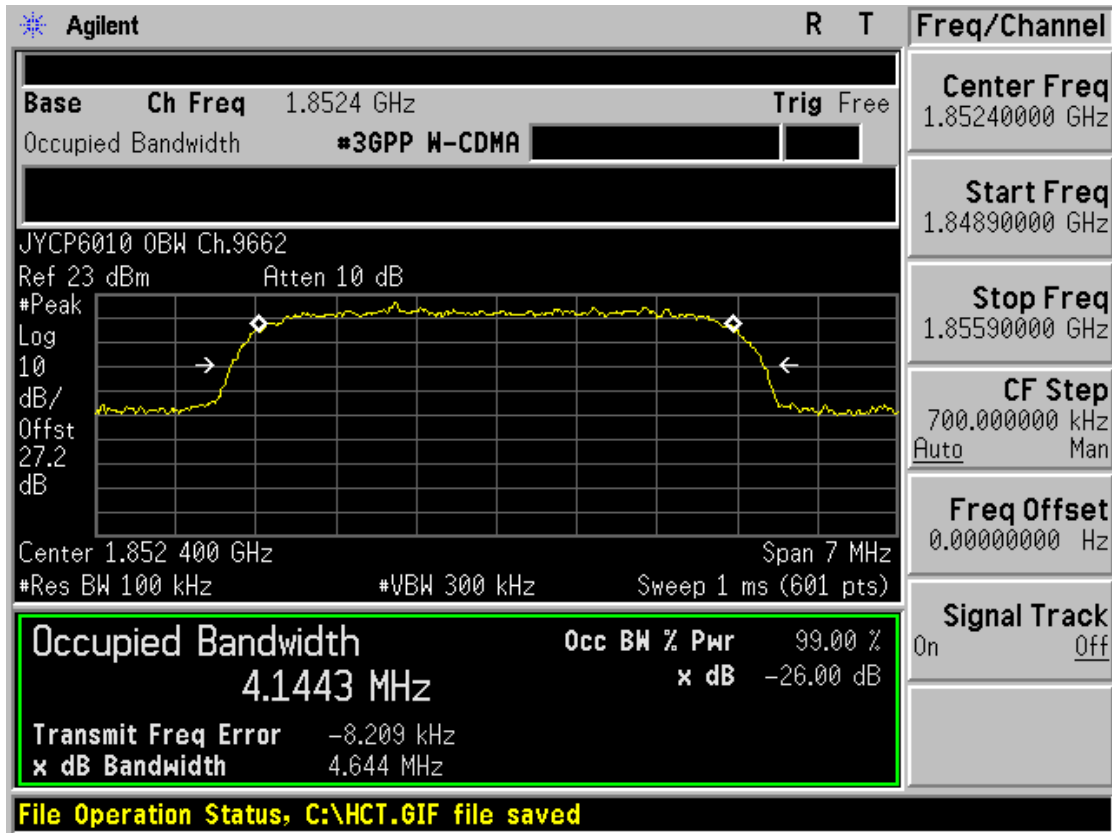

■ WCDMA1900 MODE (9400 CH.) Occupied Bandwidth

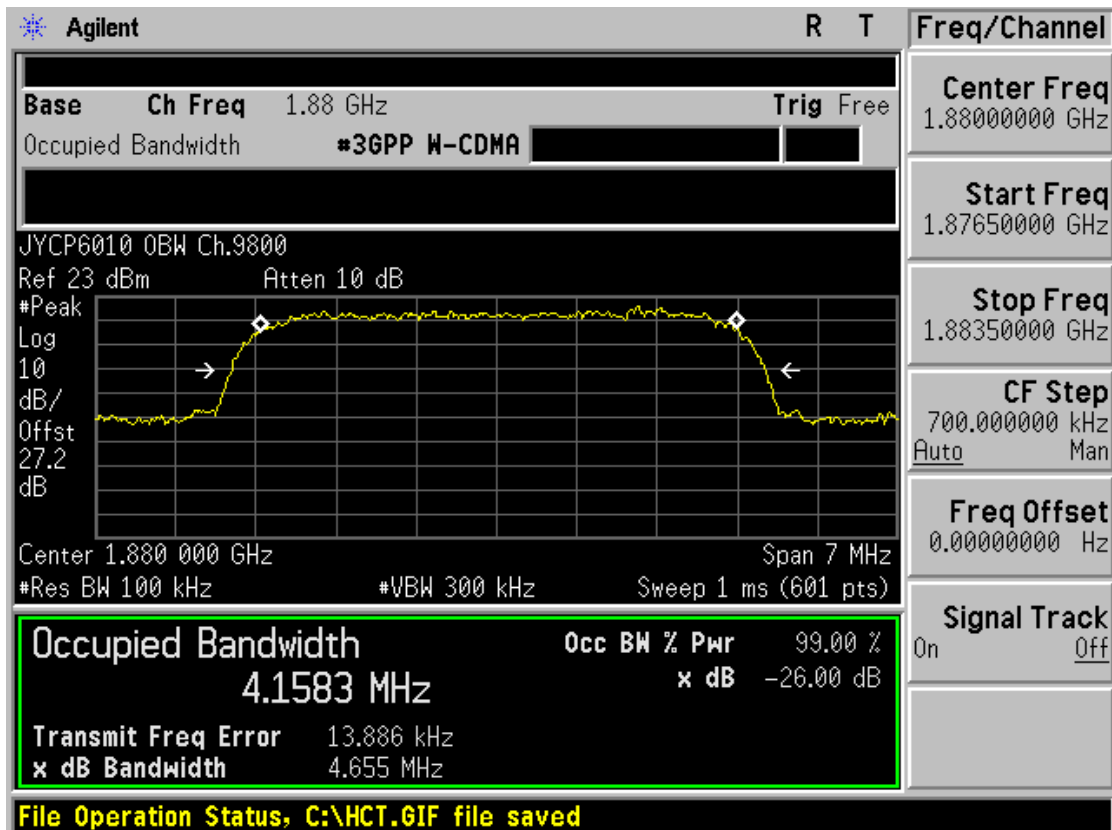



■ GSM850 MODE (128 CH.) Block Edge 1

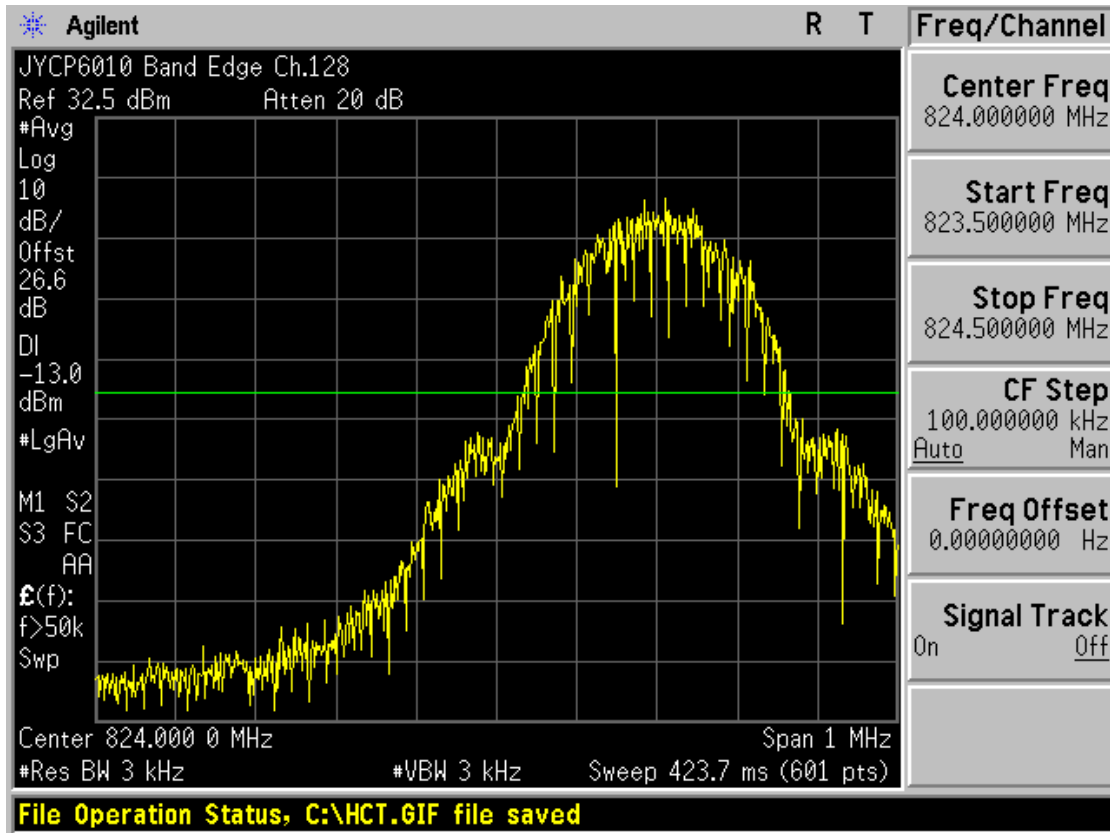

■ GSM850 MODE (128 CH.) Block Edge 2

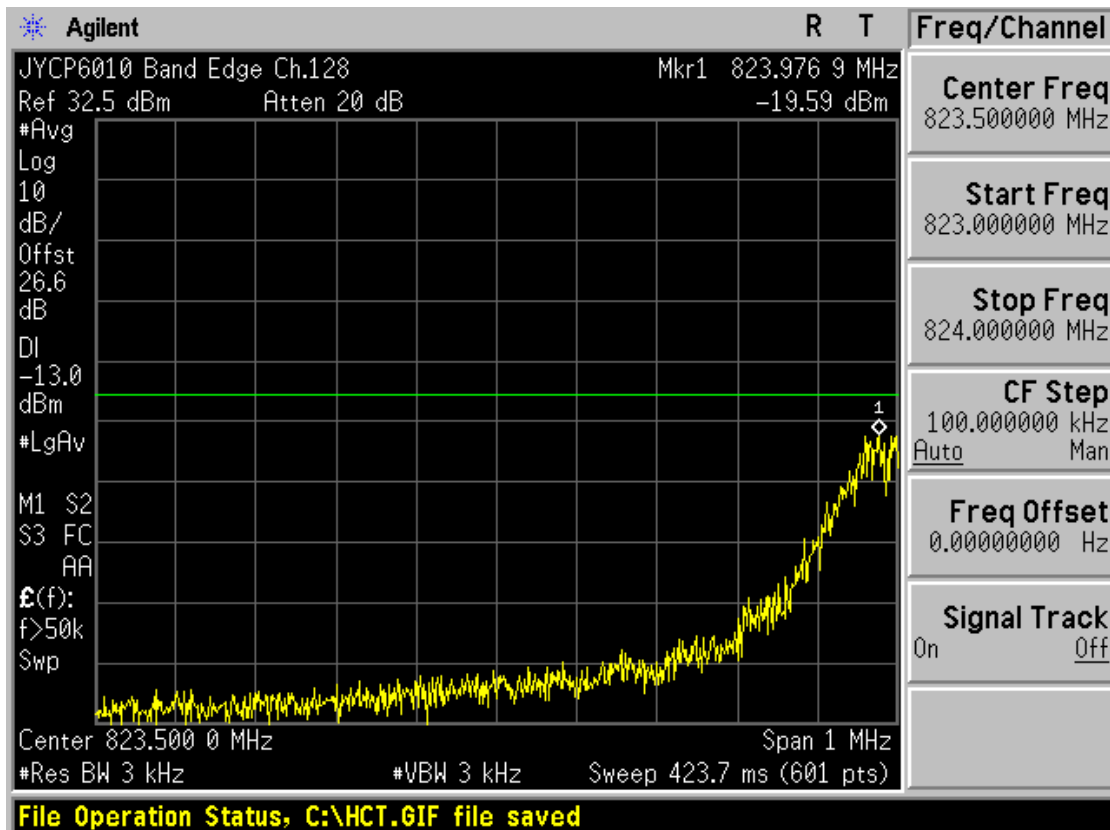

■ GSM850 MODE (251 CH.) Block Edge 1

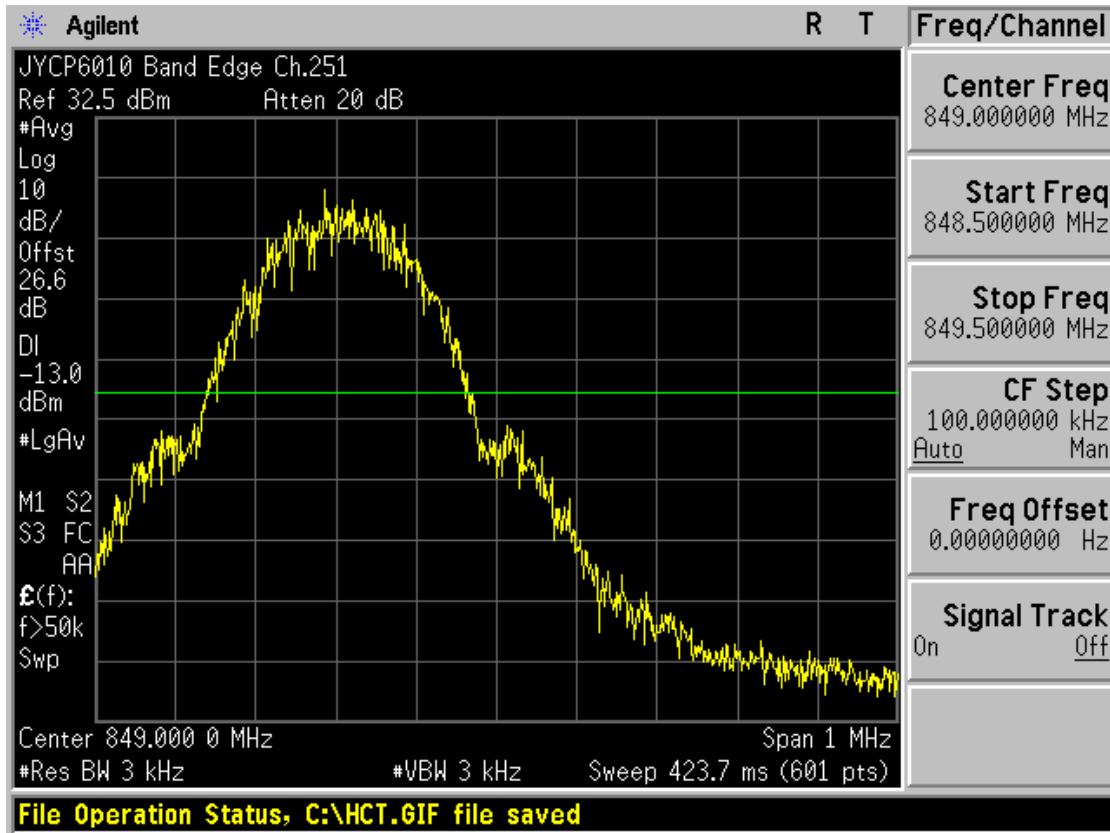

■ GSM850 MODE (251 CH.) Block Edge 2

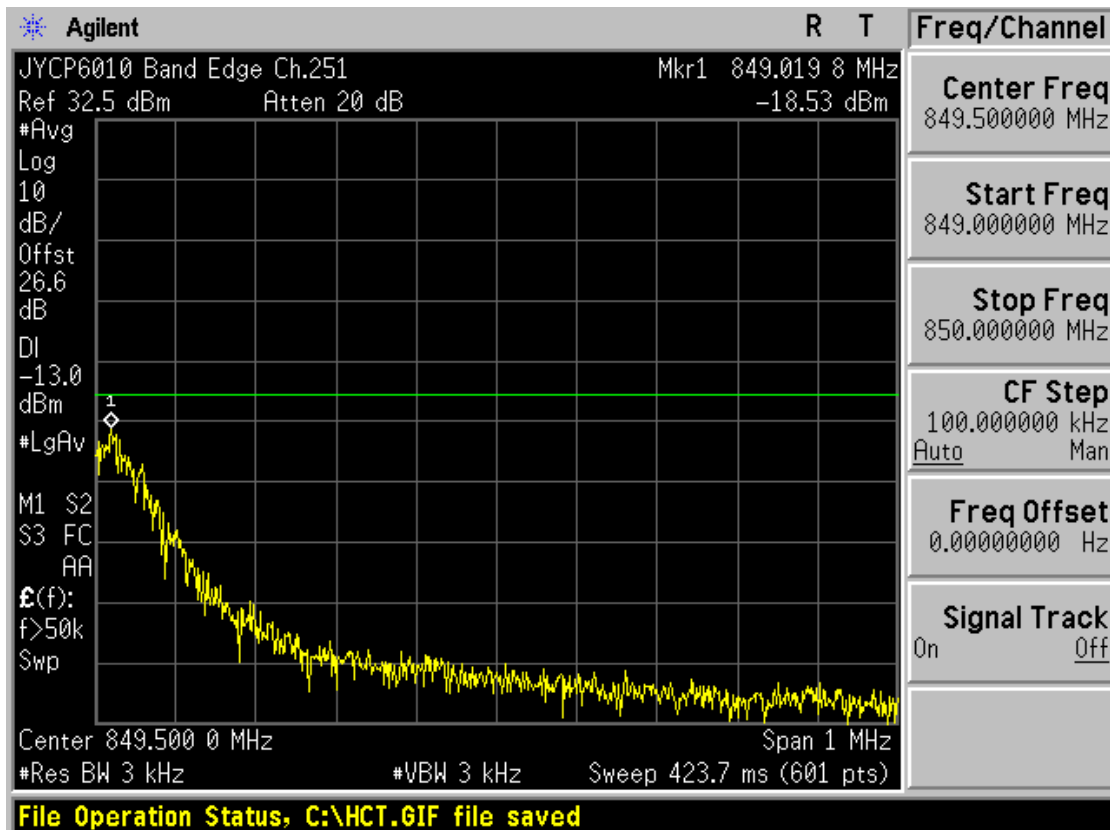

■ EDGE MODE (128 CH.) Block Edge 1

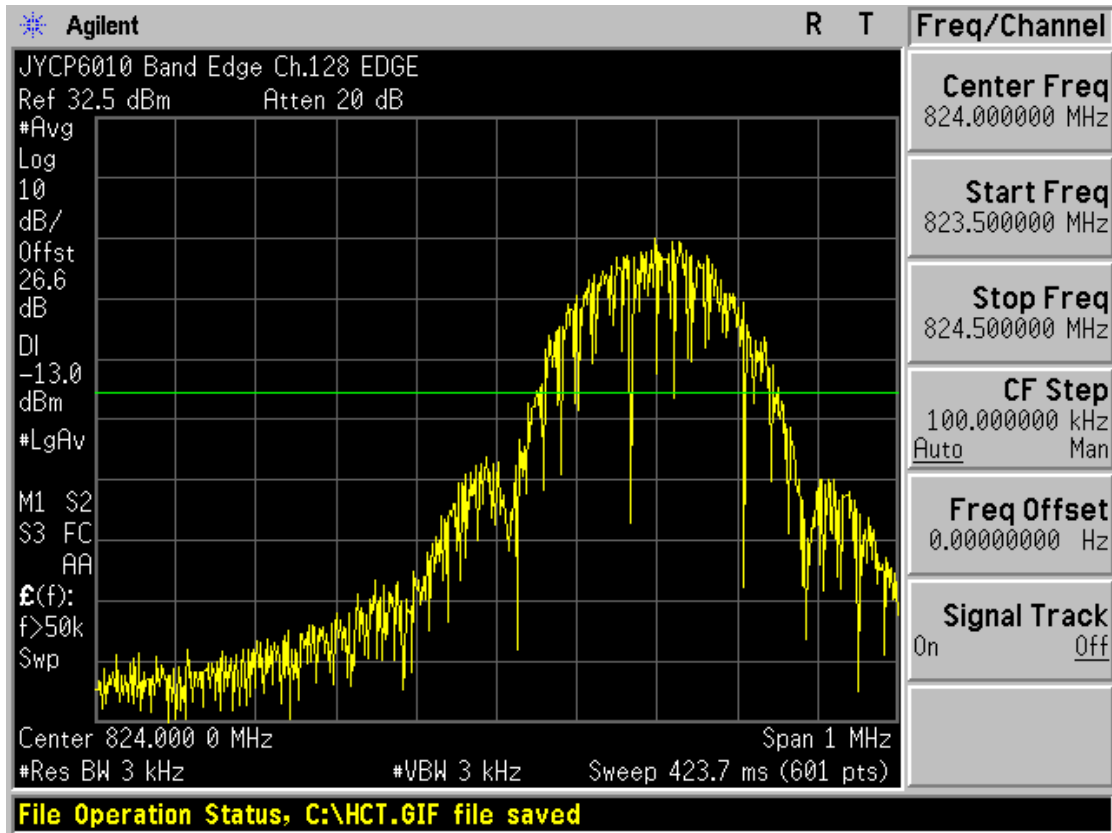

■ EDGE MODE (128 CH.) Block Edge 2

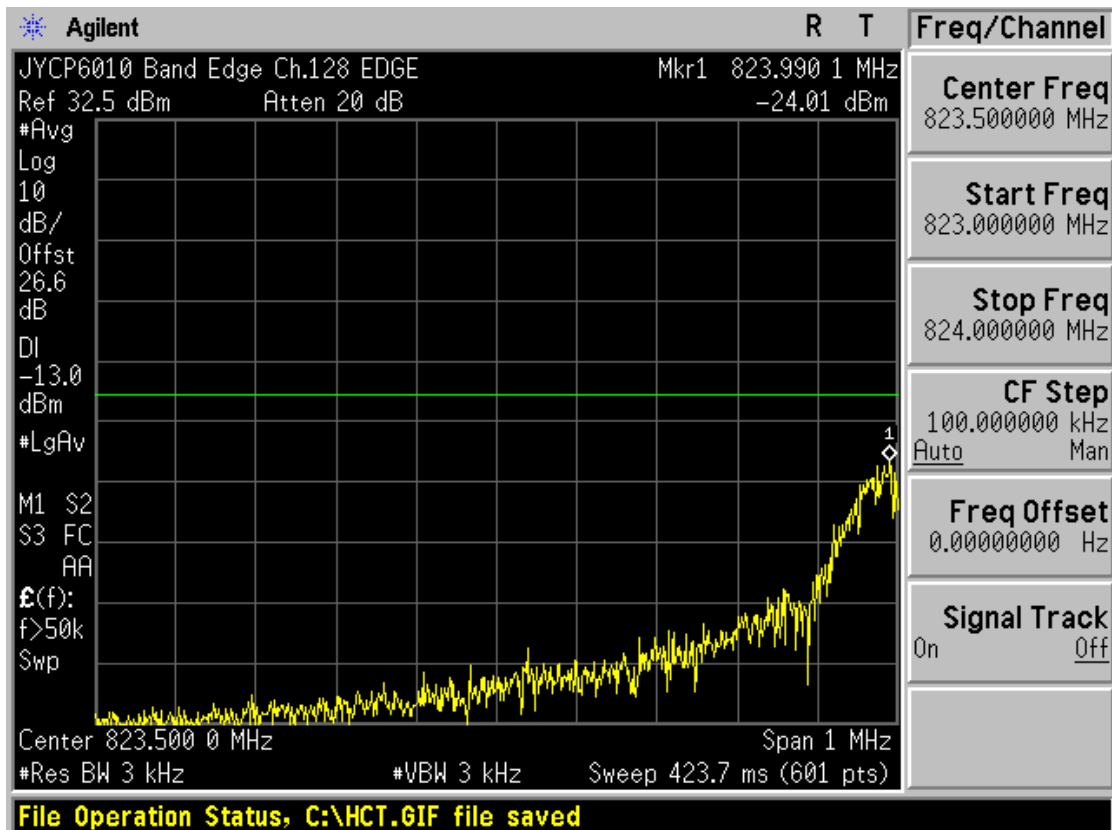



■ EDGE MODE (251 CH.) Block Edge 1



■ EDGE MODE (251 CH.) Block Edge 2

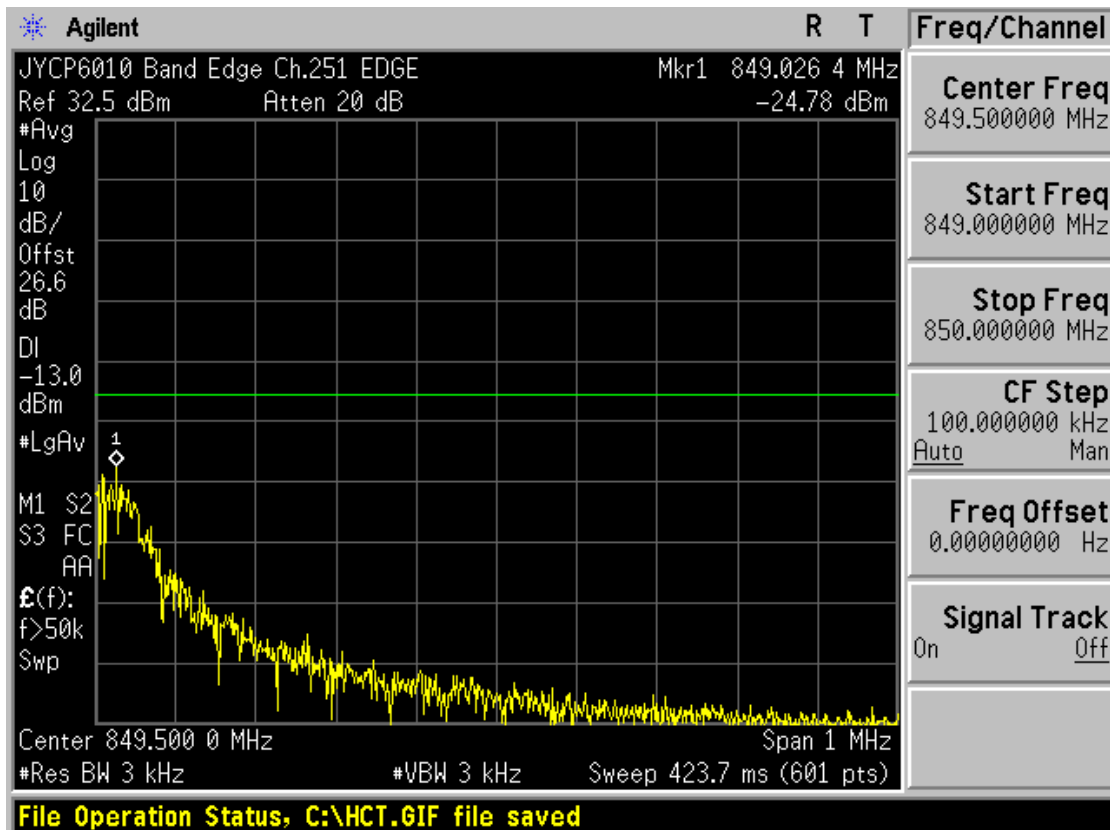

■ GSM1900 MODE (512 CH.) Block Edge 1

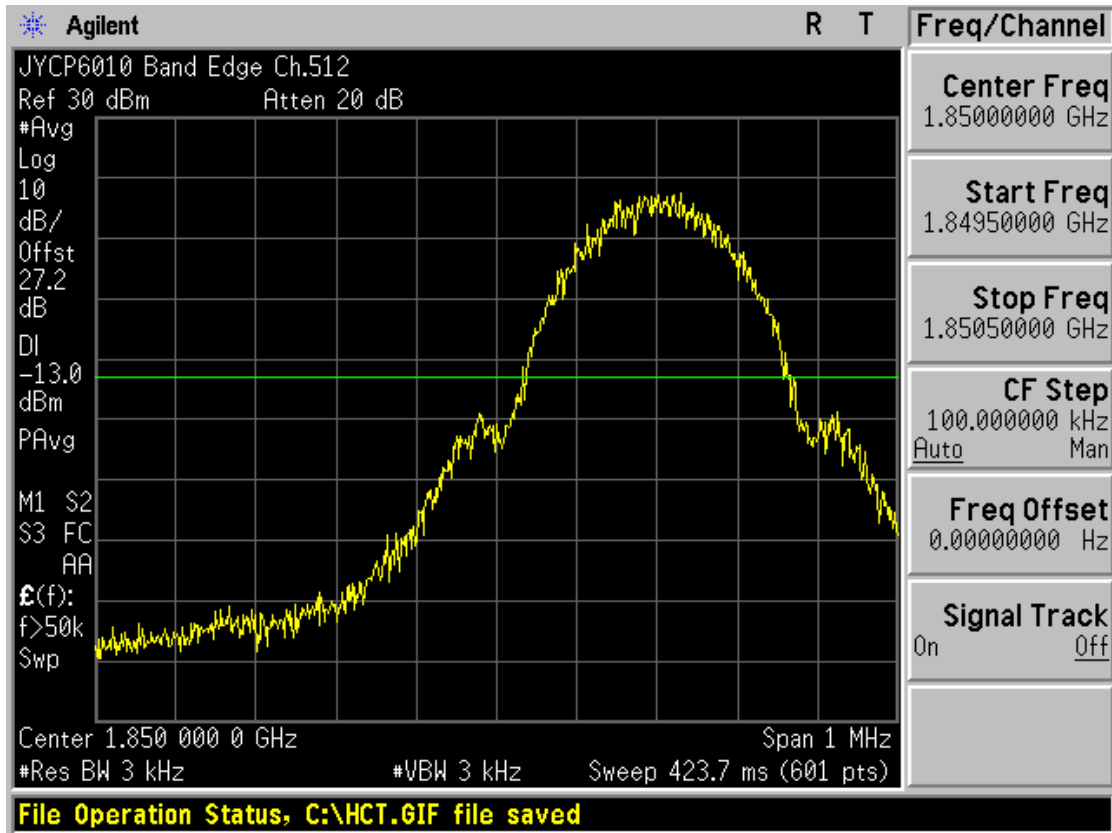

■ GSM1900 MODE (512 CH.) Block Edge 2

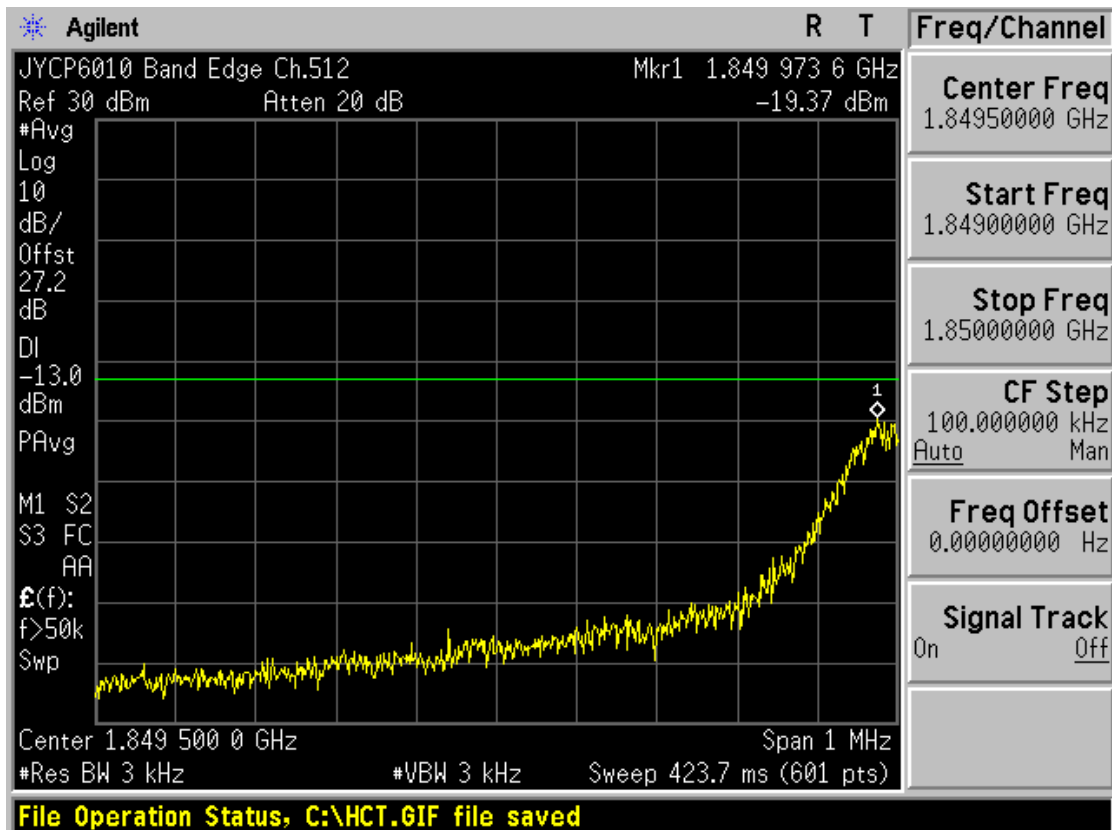

■ GSM1900 MODE (810 CH.) Block Edge 1

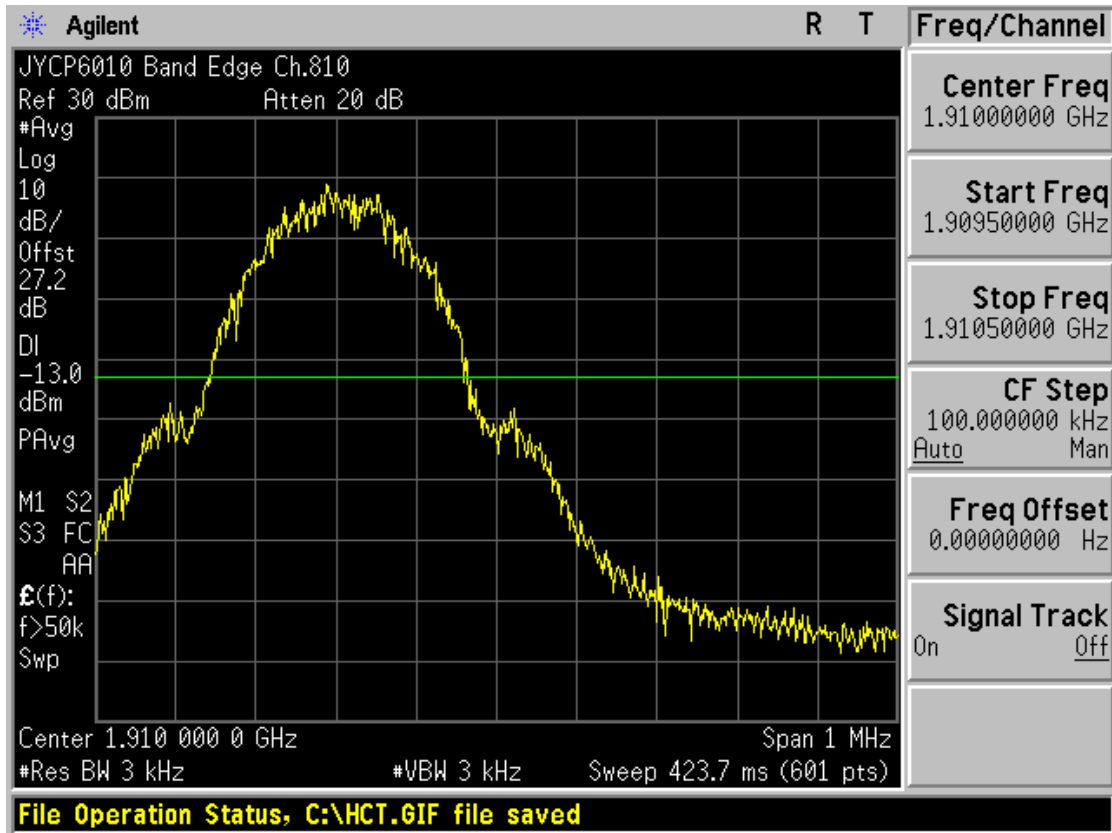

■ GSM1900 MODE (810 CH.) Block Edge 2

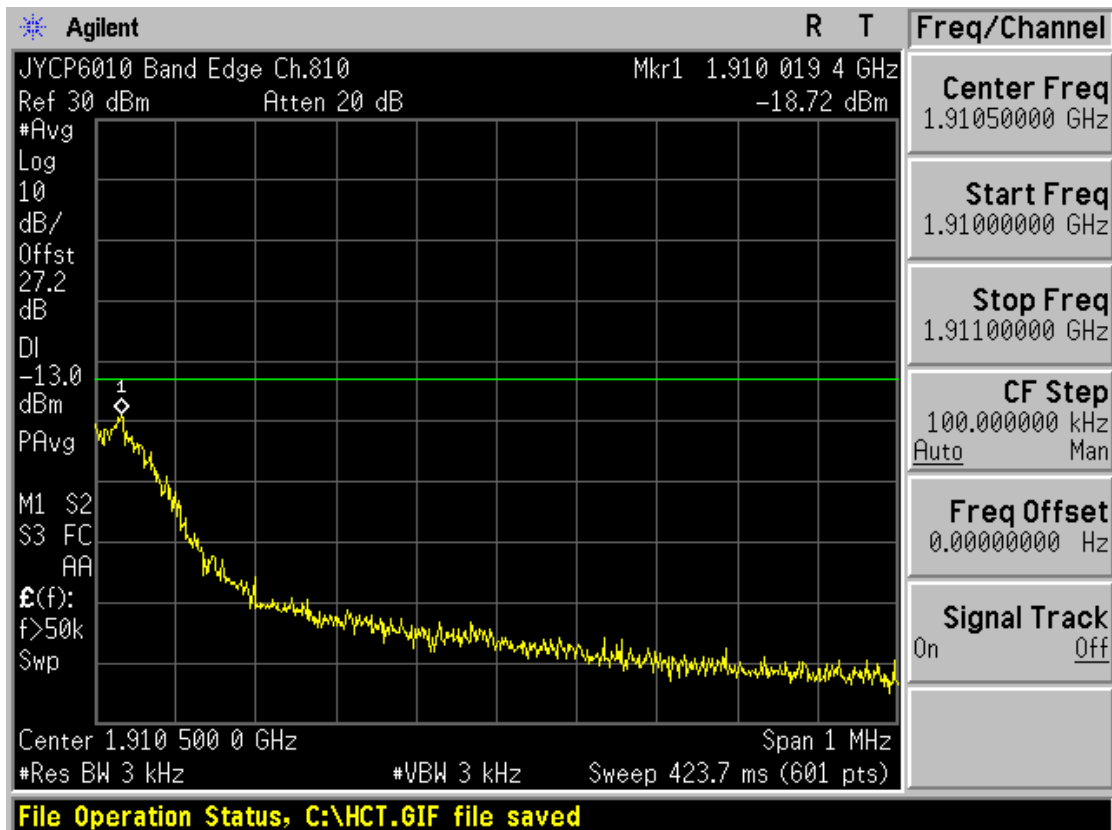

■ EDGE MODE (512 CH.) Block Edge 1

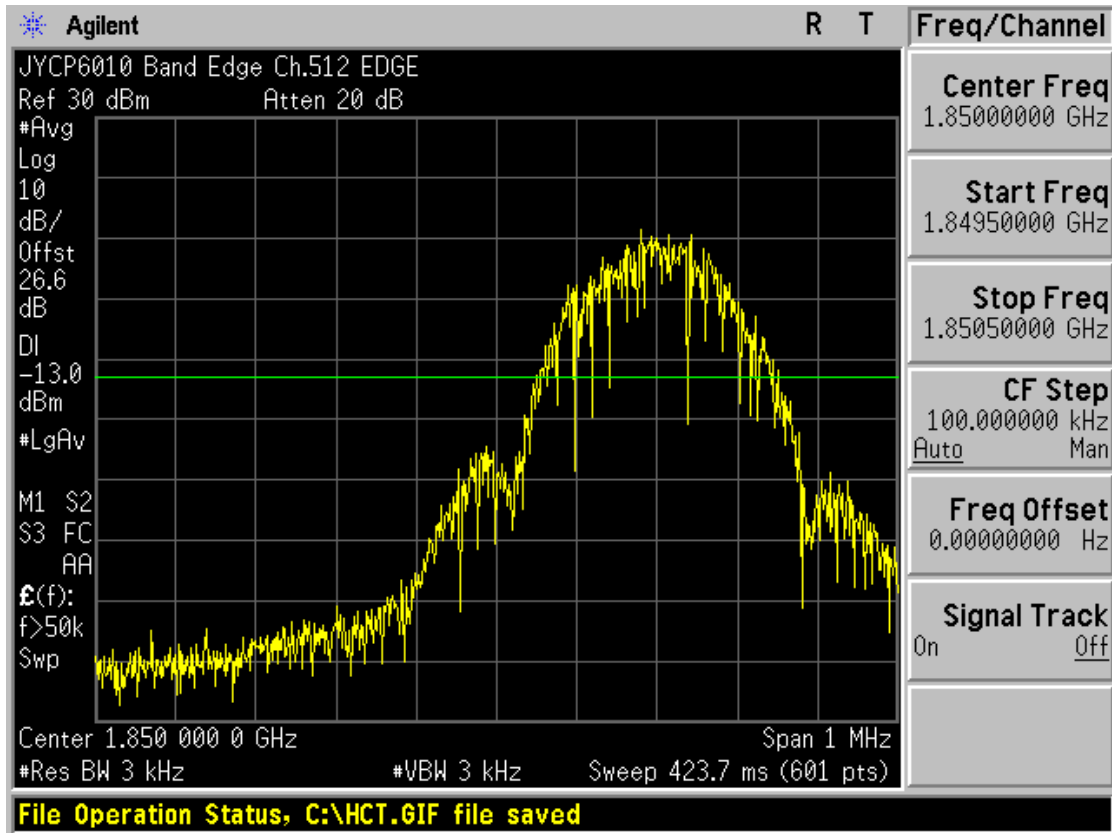

■ EDGE MODE (512 CH.) Block Edge 2

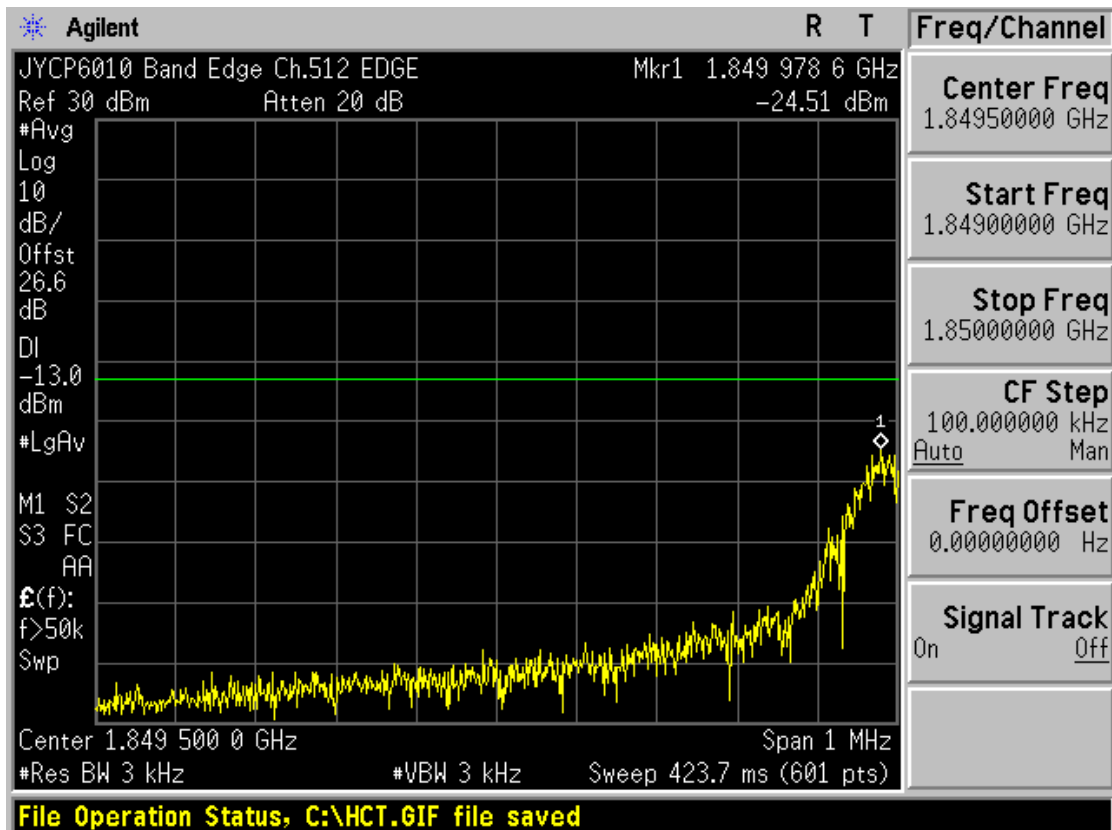

■ EDGE MODE (810 CH.) Block Edge 1



■ EDGE MODE (810 CH.) Block Edge 2

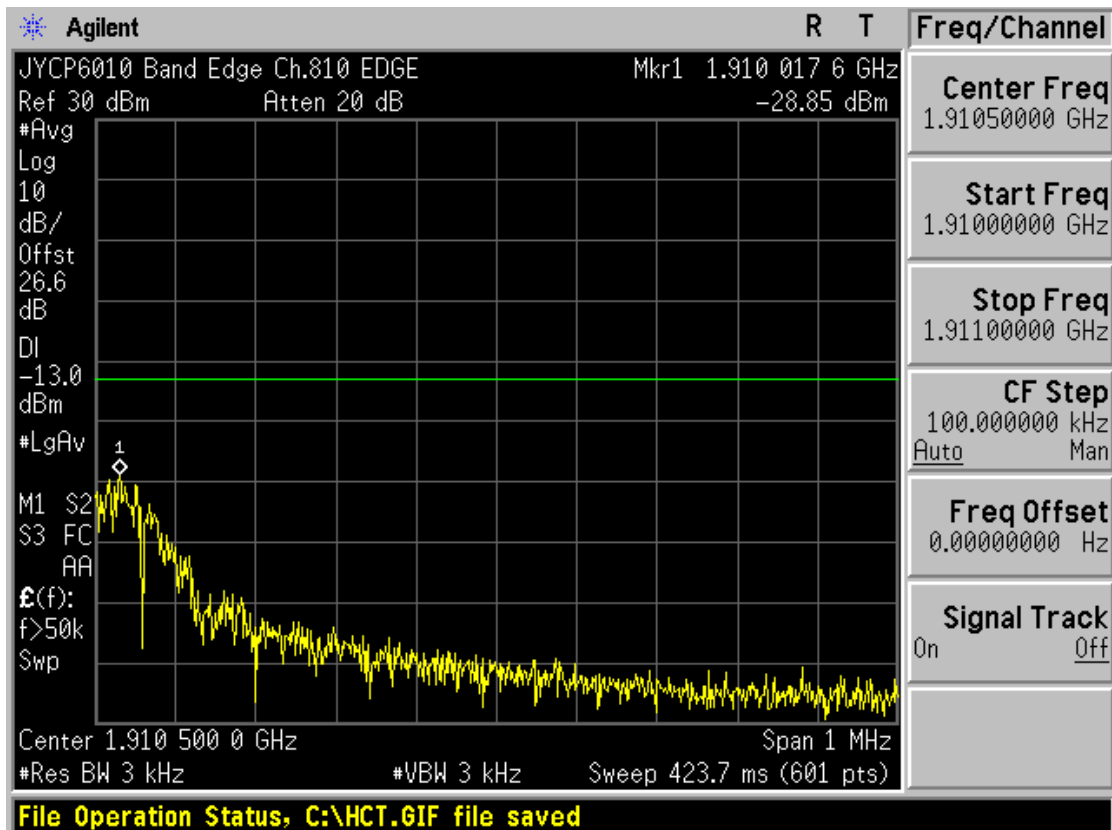

■ WCDMA850 MODE (4132 CH.) Block Edge

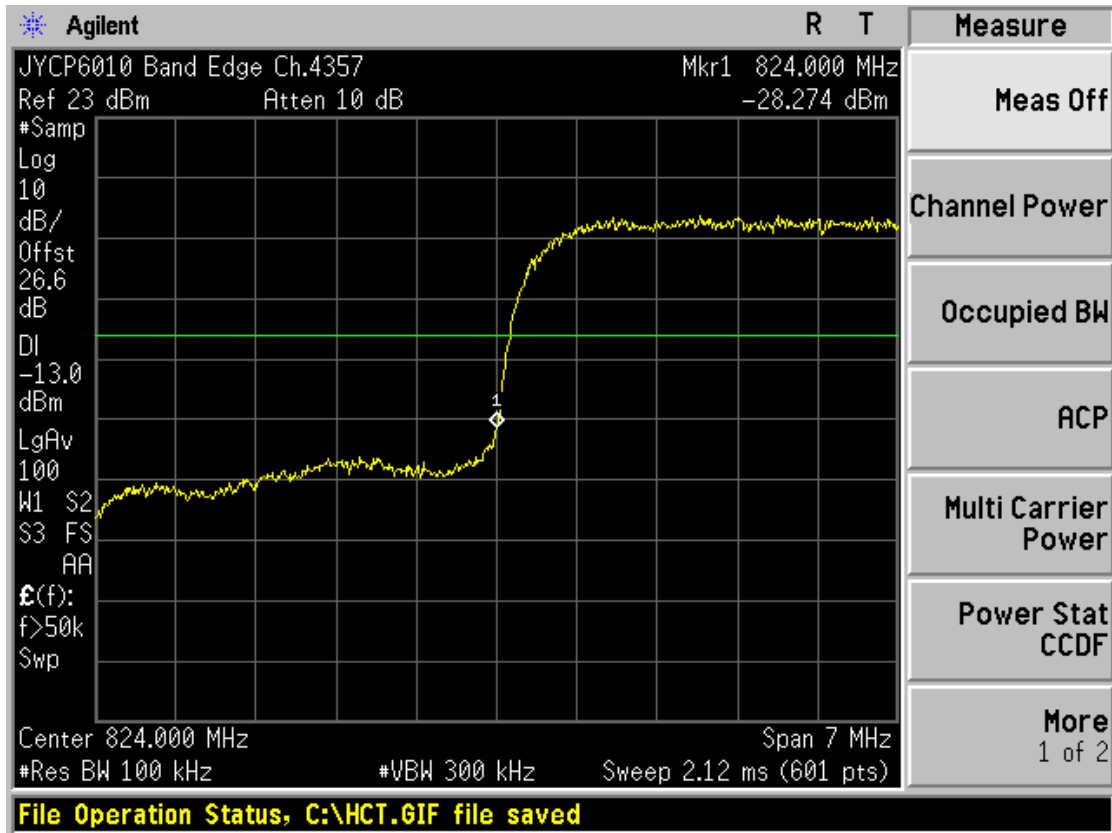

■ WCDMA850MODE (4233 CH.) Block Edge

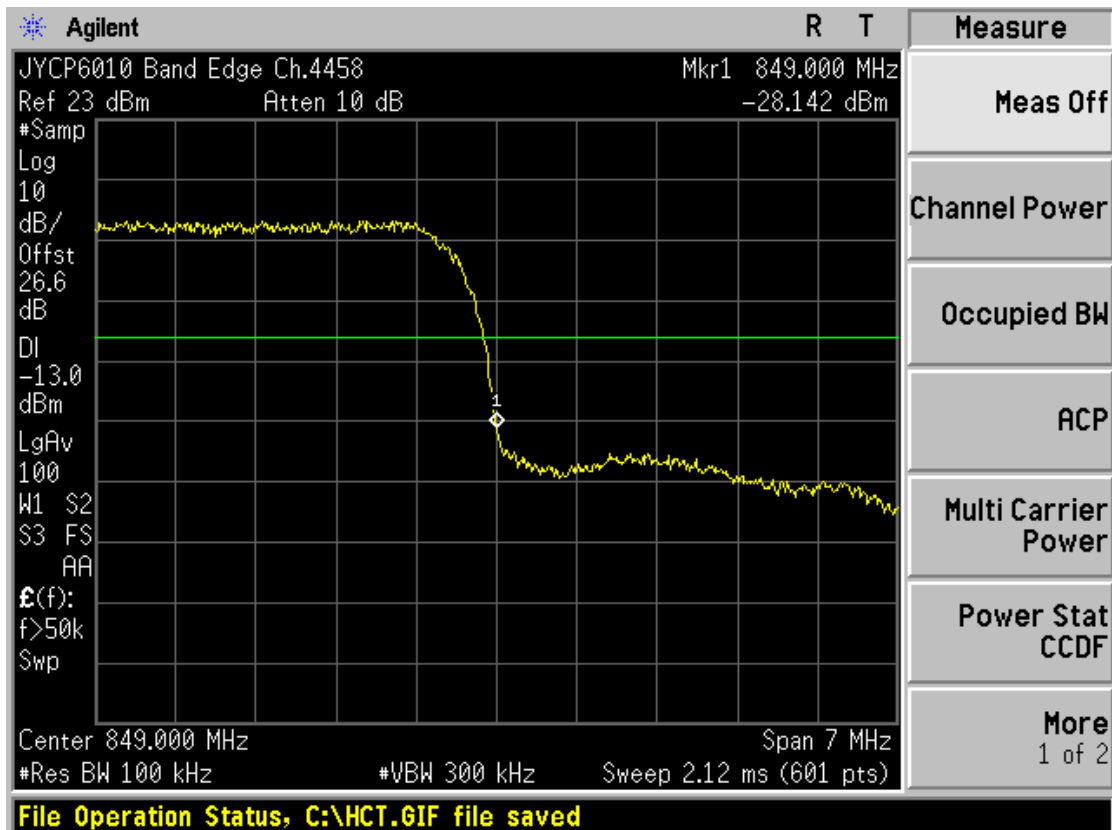

■ WCDMA850 MODE (4132 CH.) – 4 MHz Span

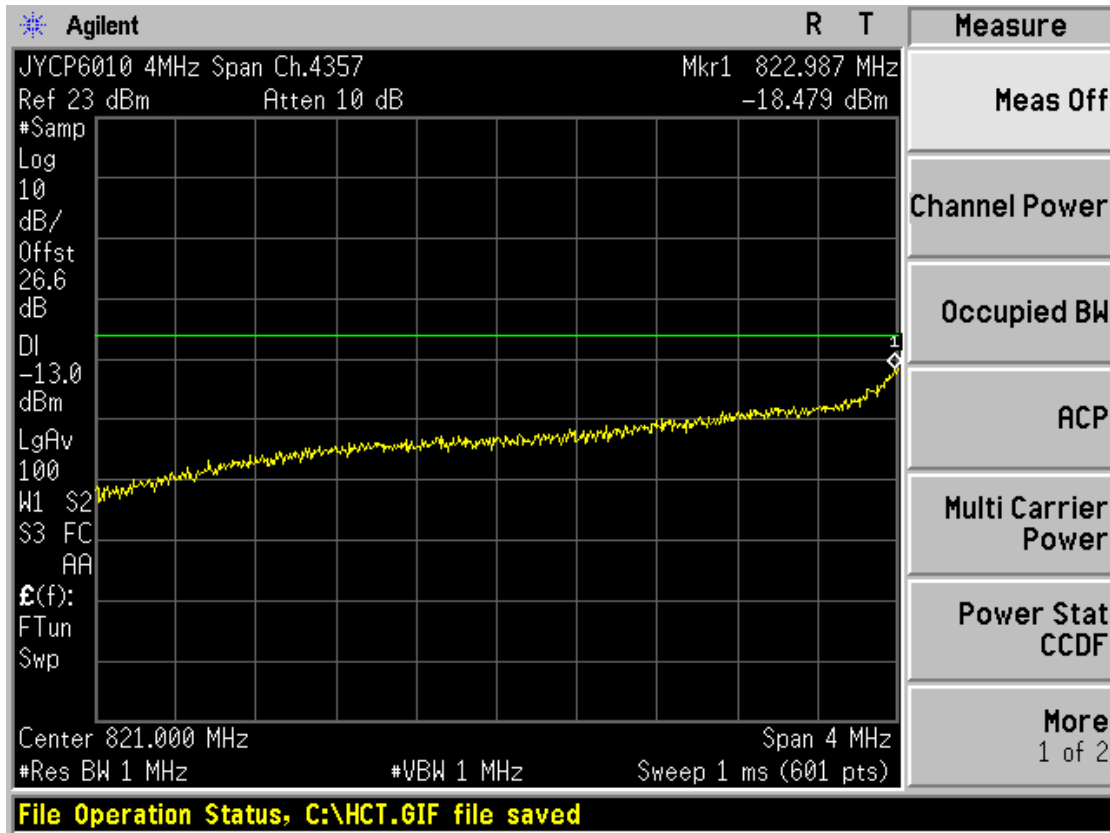

■ WCDMA850MODE (4233 CH.) – 4 MHz Span

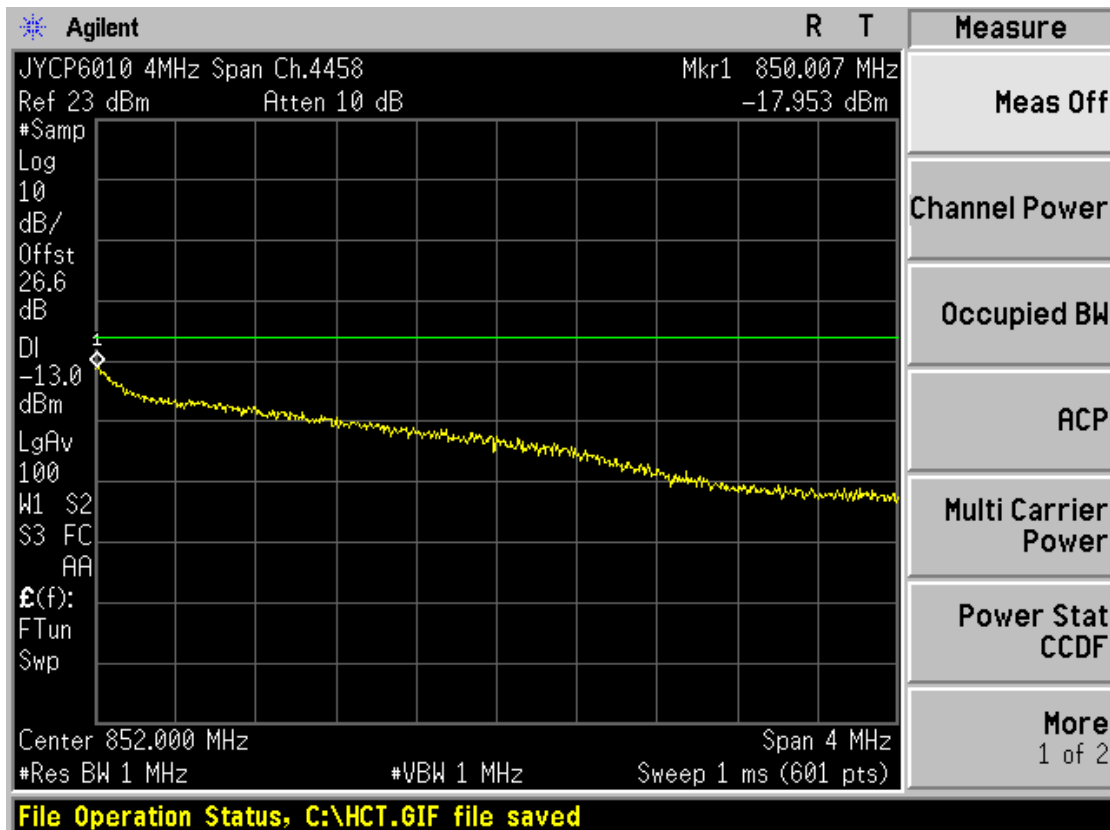

■ WCDMA1900 MODE (9262 CH.) Block Edge

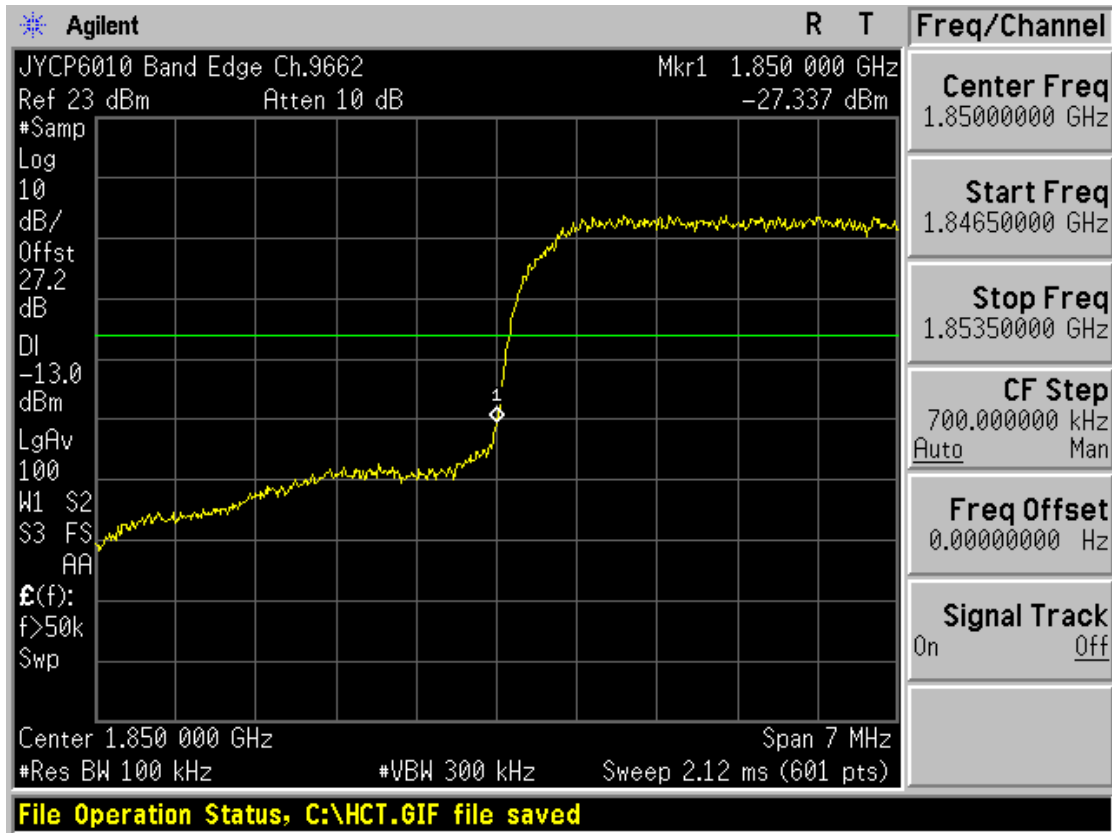

■ WCDMA1900 MODE (9538 CH.) Block Edge

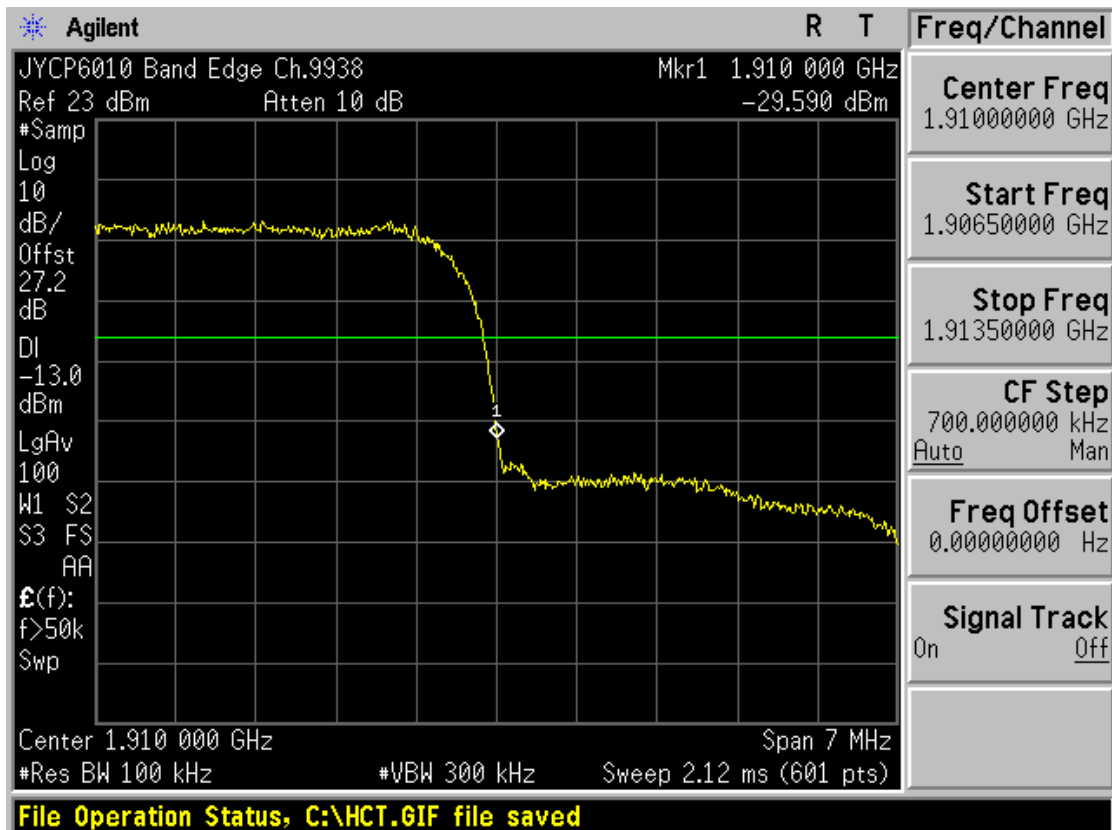



■ WCDMA1900 MODE (9262 CH.) – 4 MHz Span

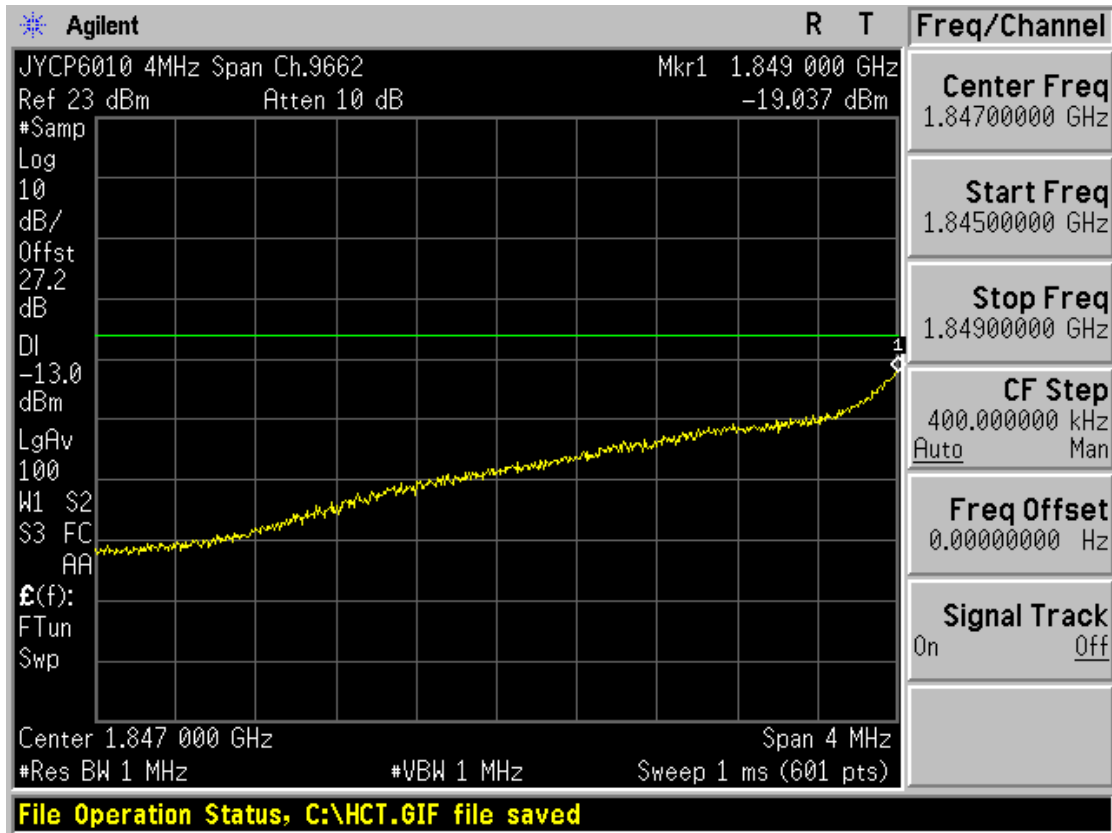

■ WCDMA1900 MODE (9538 CH.) – 4 MHz Span

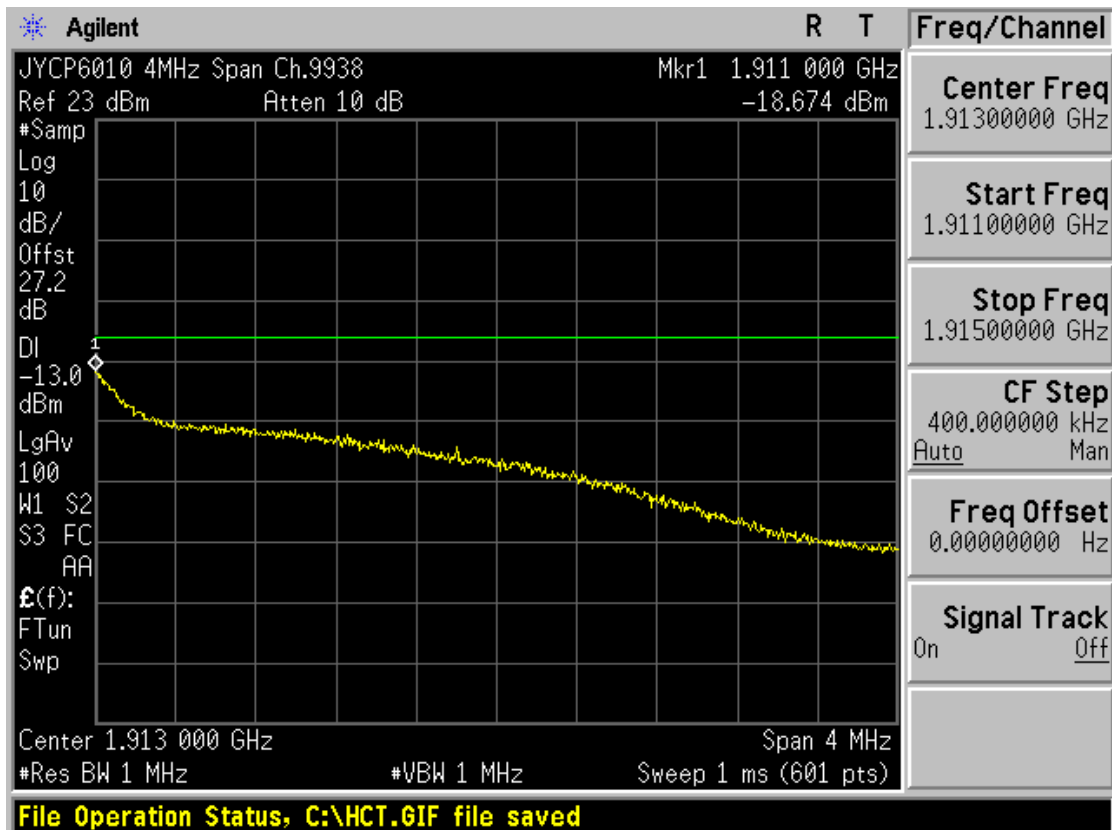

■ GSM850 MODE (128 CH.) Conducted Spurious Emissions1

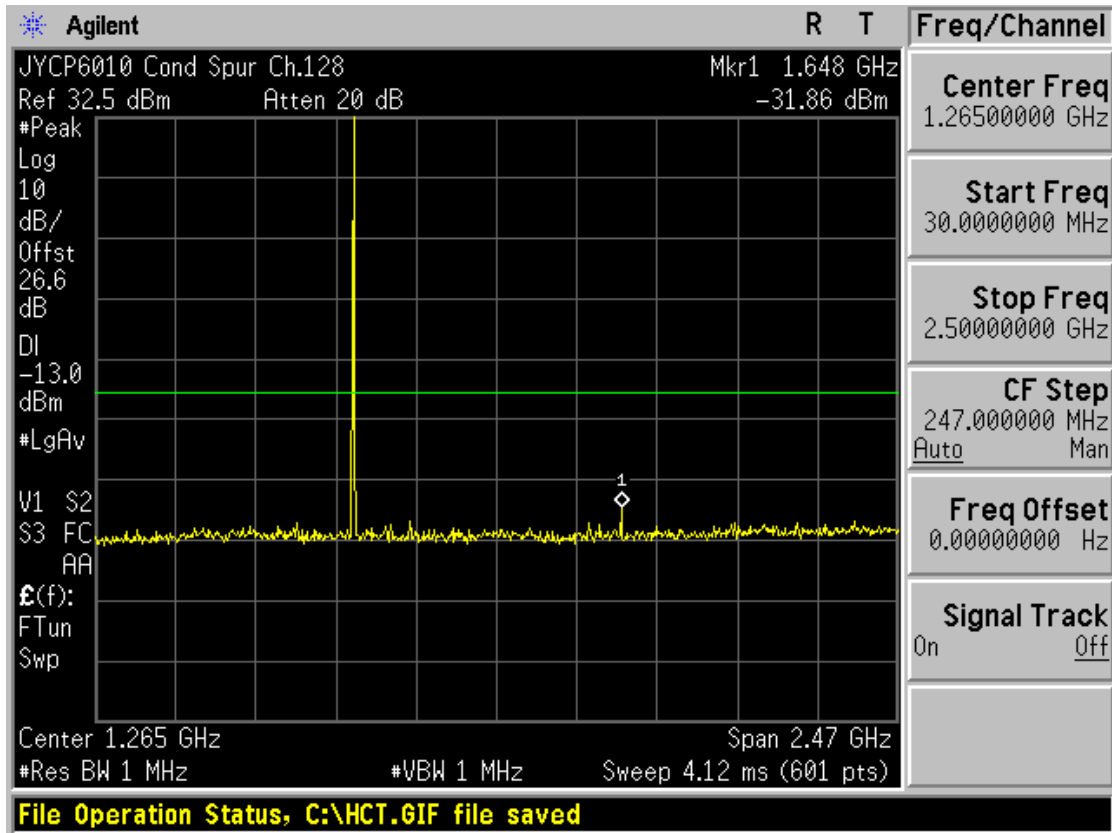

■ GSM850 MODE (128 CH.) Conducted Spurious Emissions2

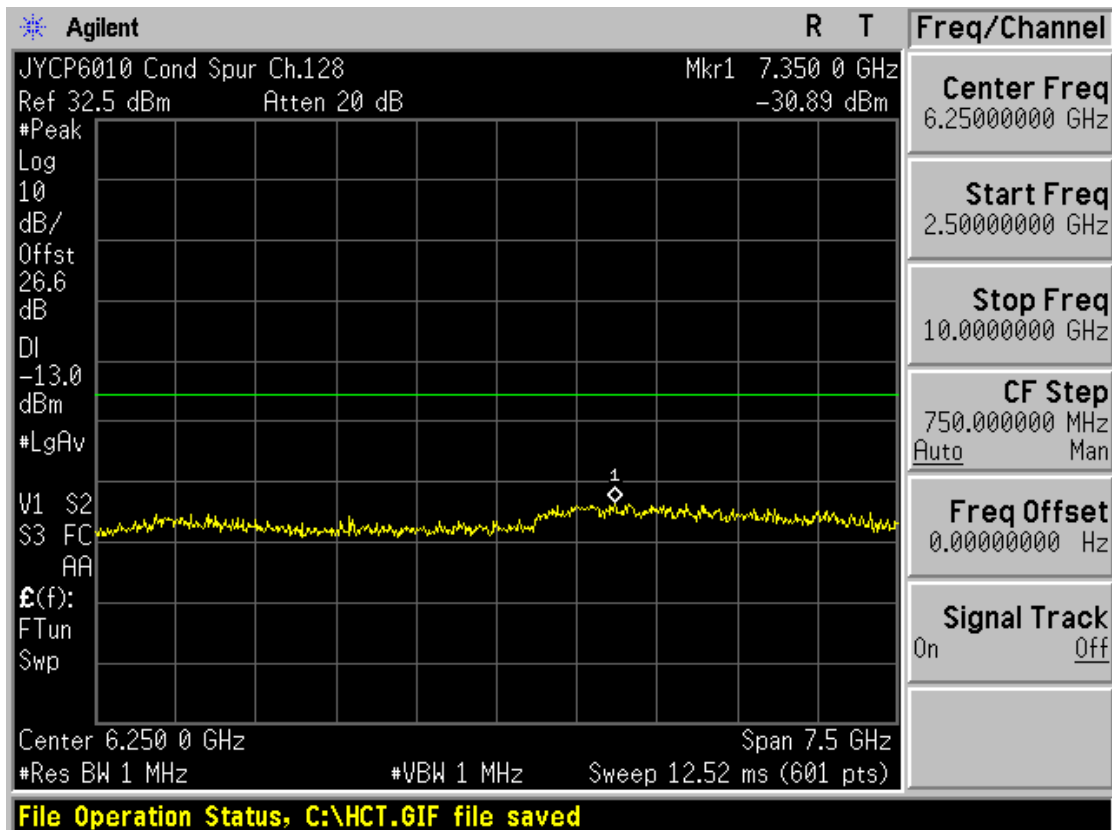

■ GSM850 MODE (190 CH.) Conducted Spurious Emissions1

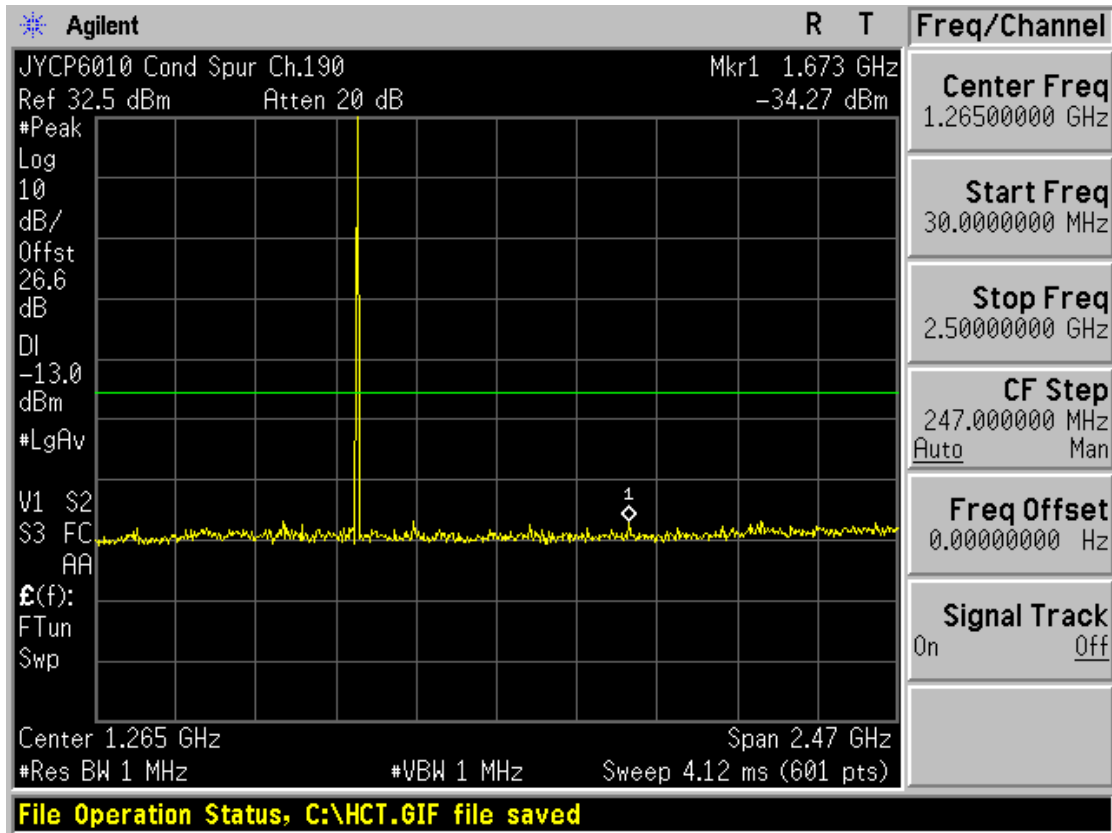

■ GSM850 MODE (190 CH.) Conducted Spurious Emissions2

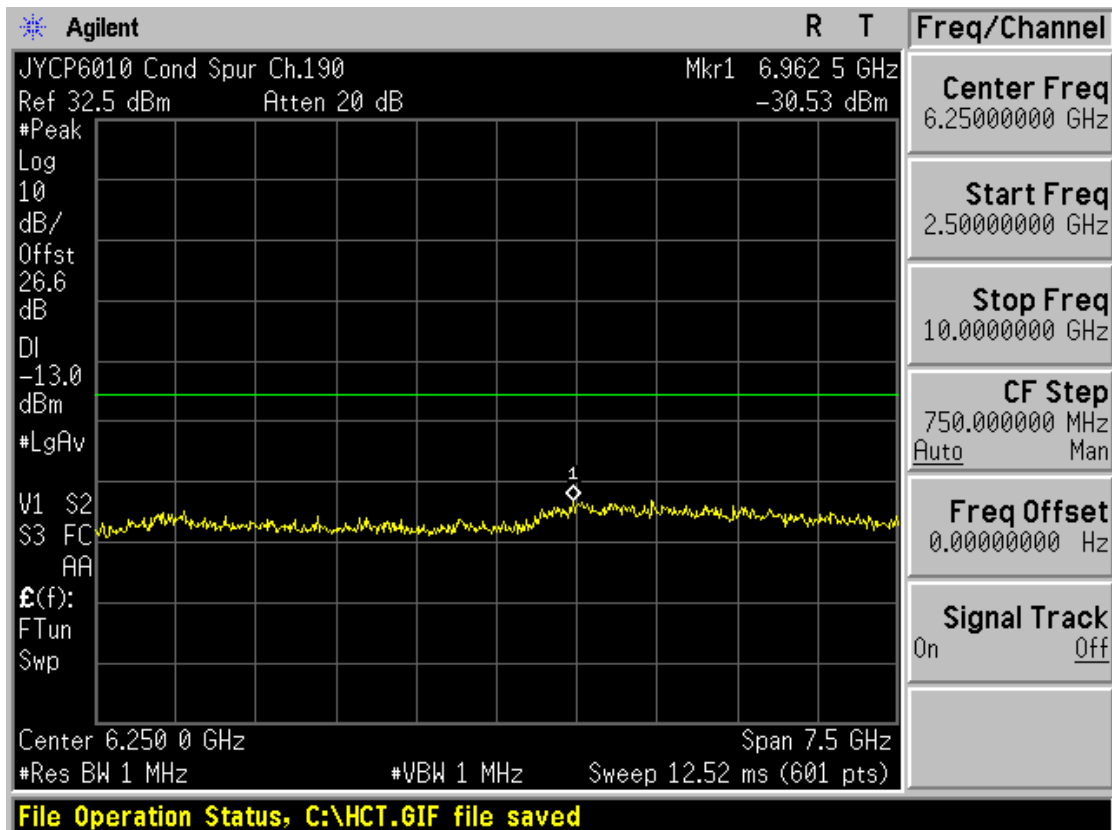

■ GSM850 MODE (251 CH.) Conducted Spurious Emissions1

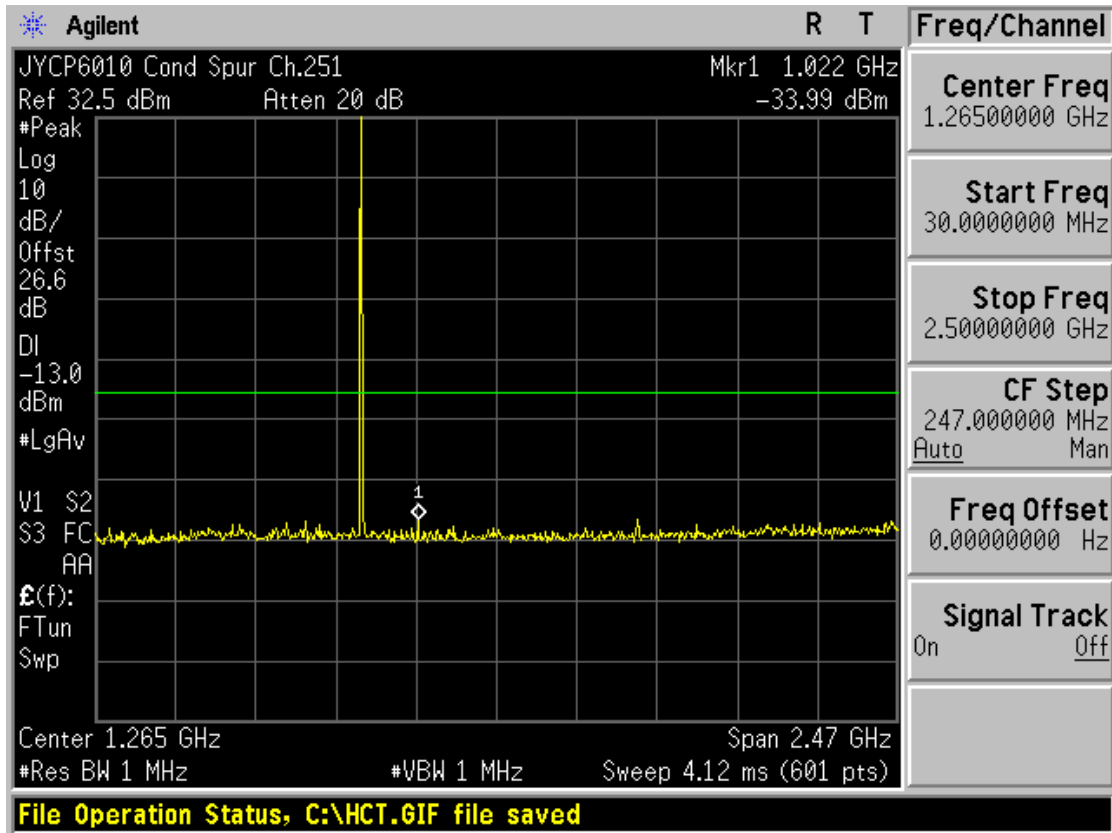

■ GSM850 MODE (251 CH.) Conducted Spurious Emissions2

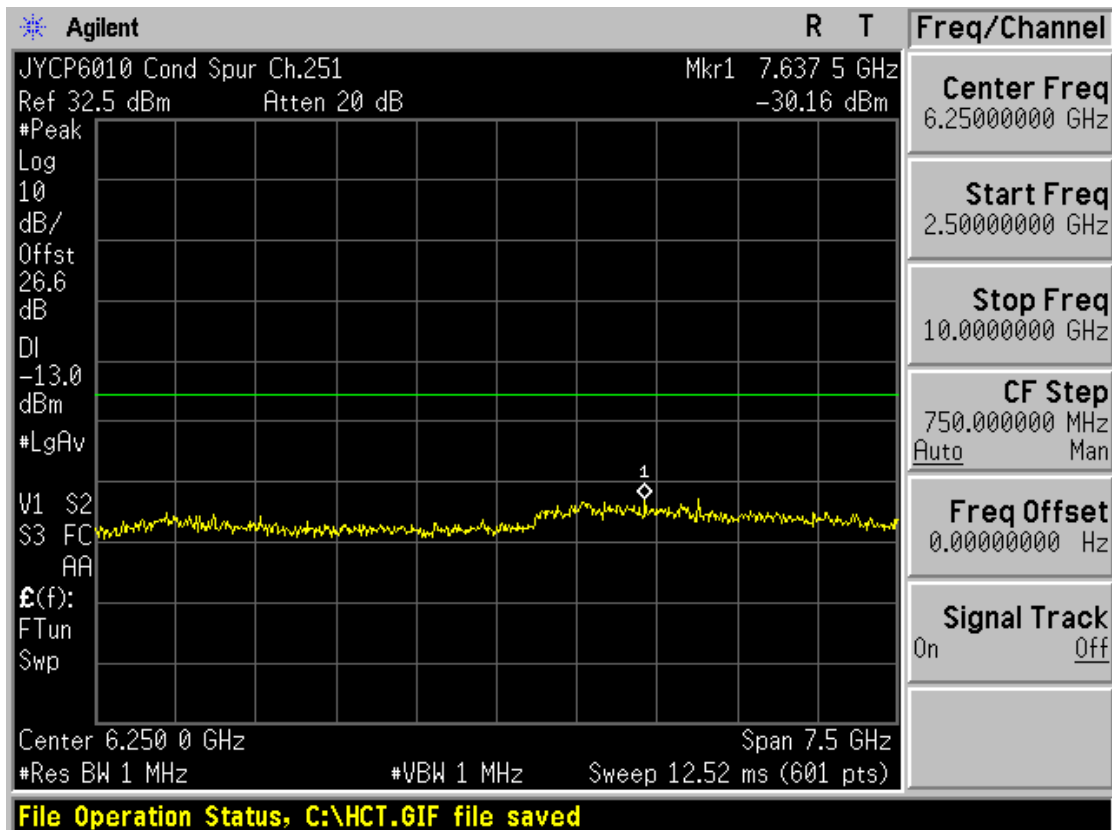

■ GSM1900 MODE (512 CH.) Conducted Spurious Emissions1

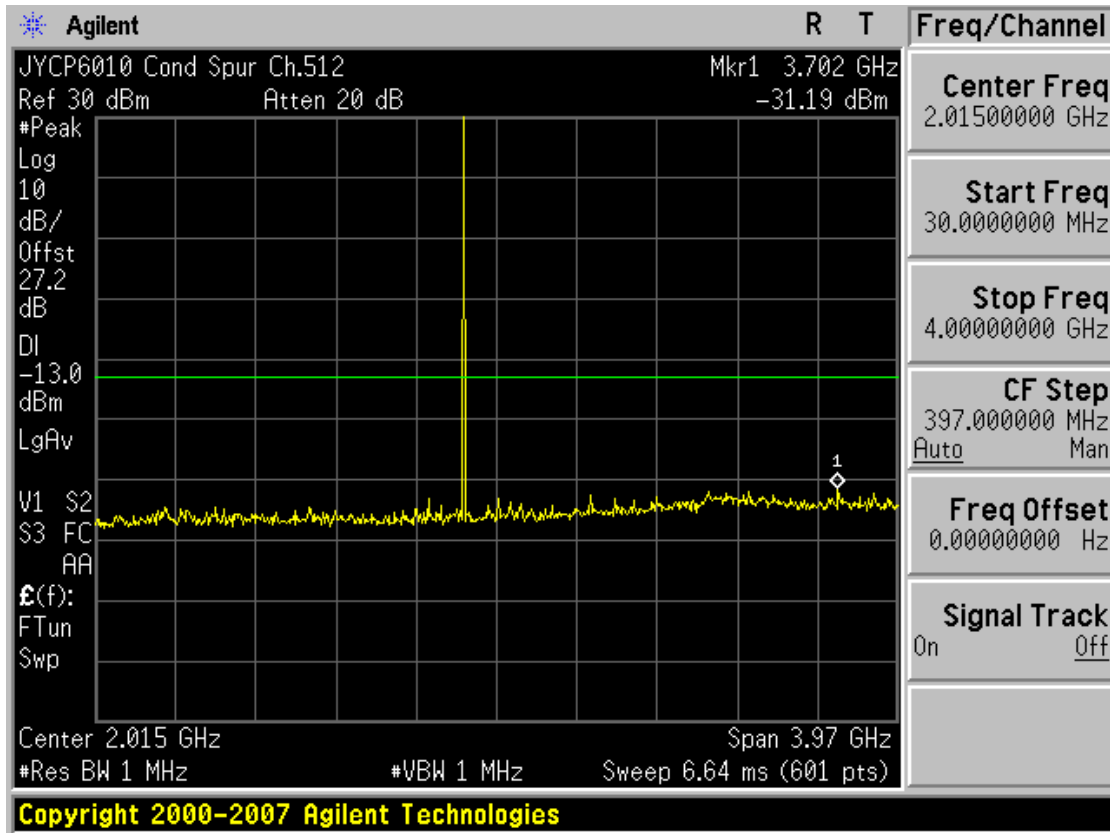

■ GSM1900 MODE (512 CH.) Conducted Spurious Emissions2

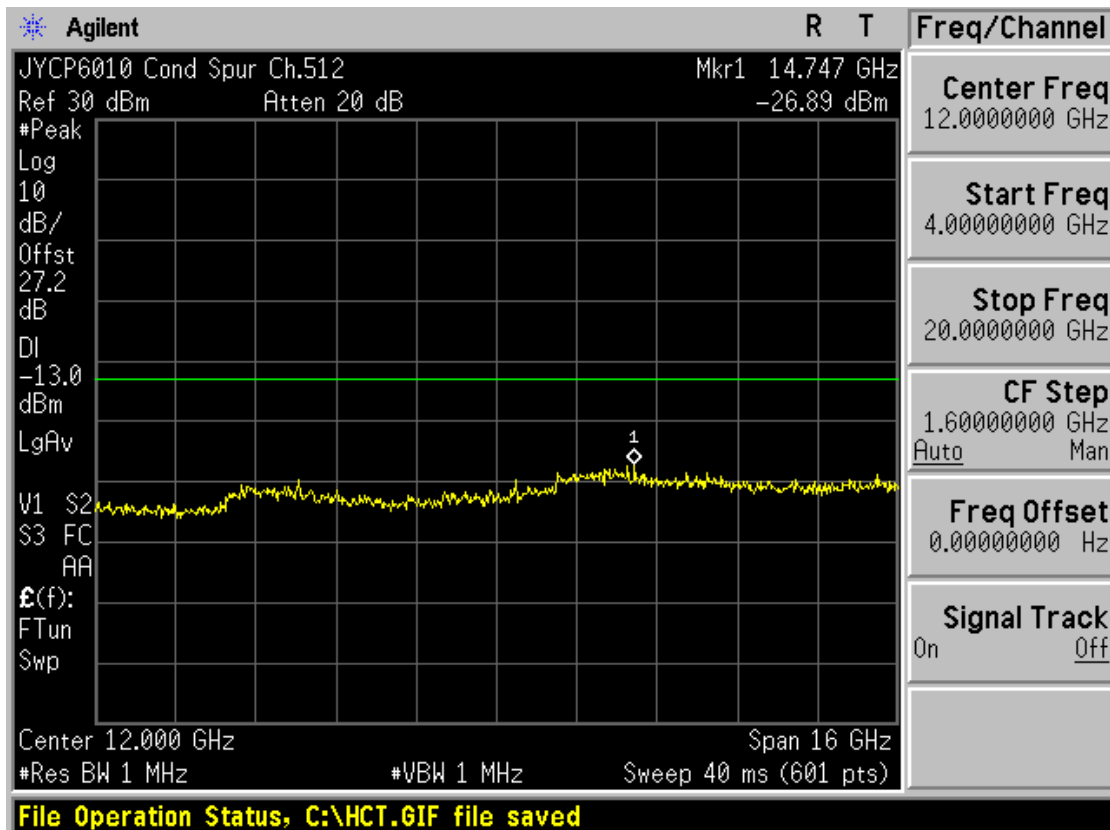

■ GSM1900 MODE (661 CH) Conducted Spurious Emissions1

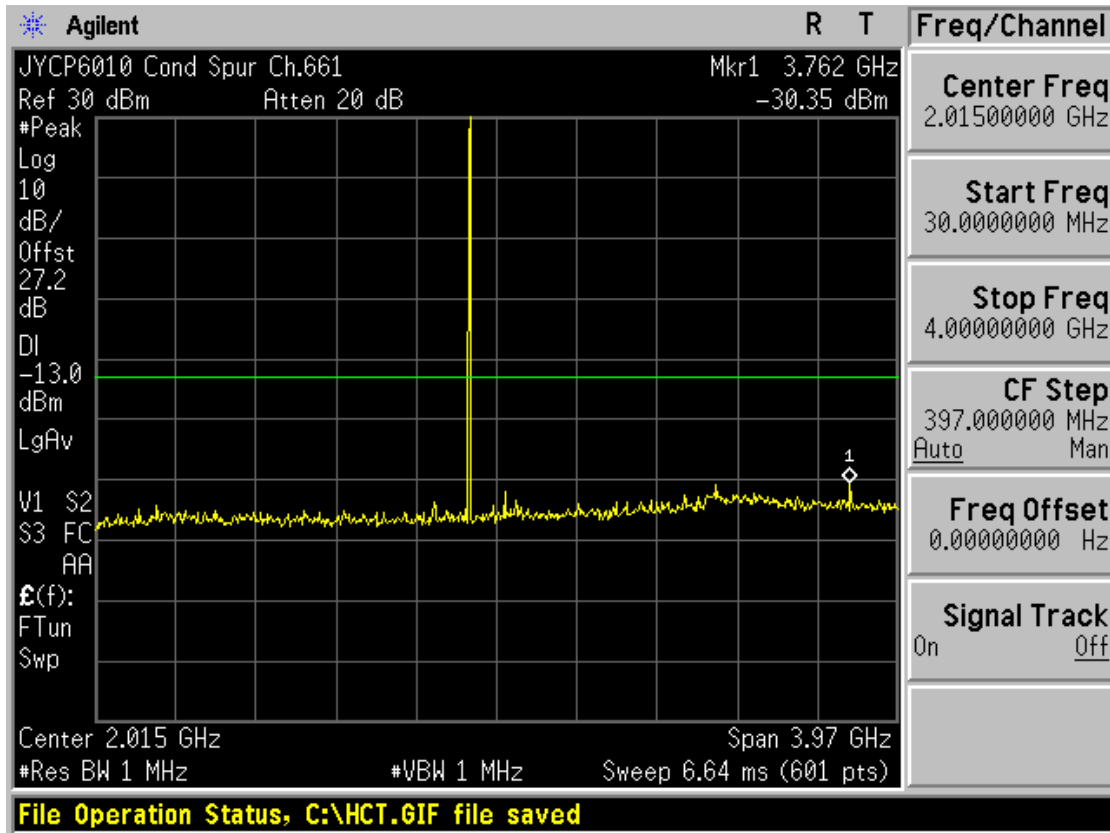

■ GSM1900 MODE (661 CH.) Conducted Spurious Emissions2

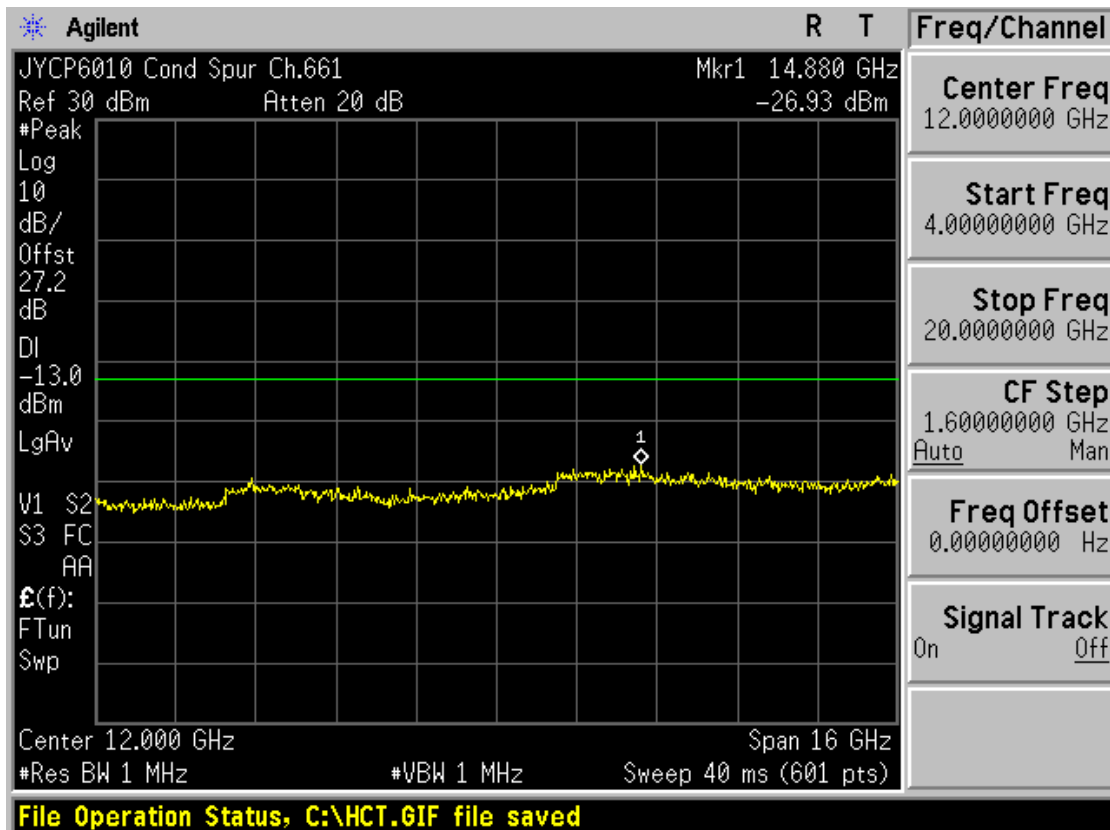

■ GSM1900 MODE (810 CH.) Conducted Spurious Emissions1

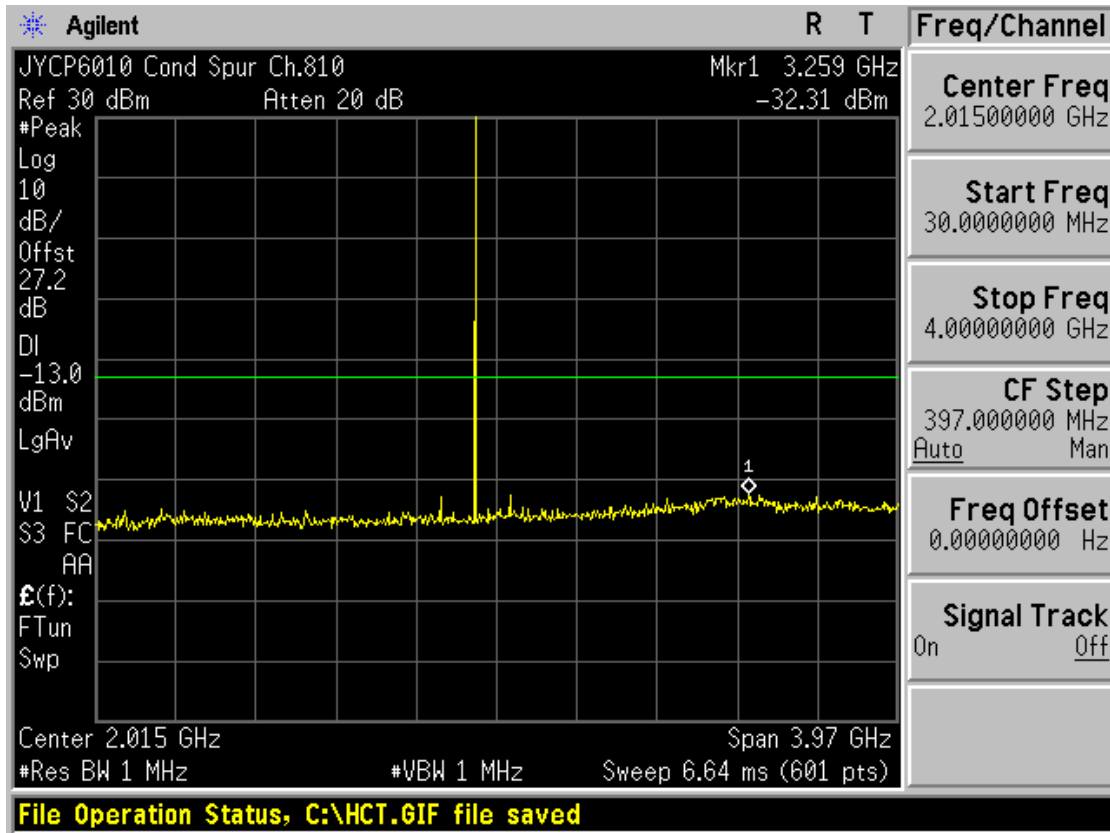

■ GSM1900 MODE (810 CH.) Conducted Spurious Emissions2

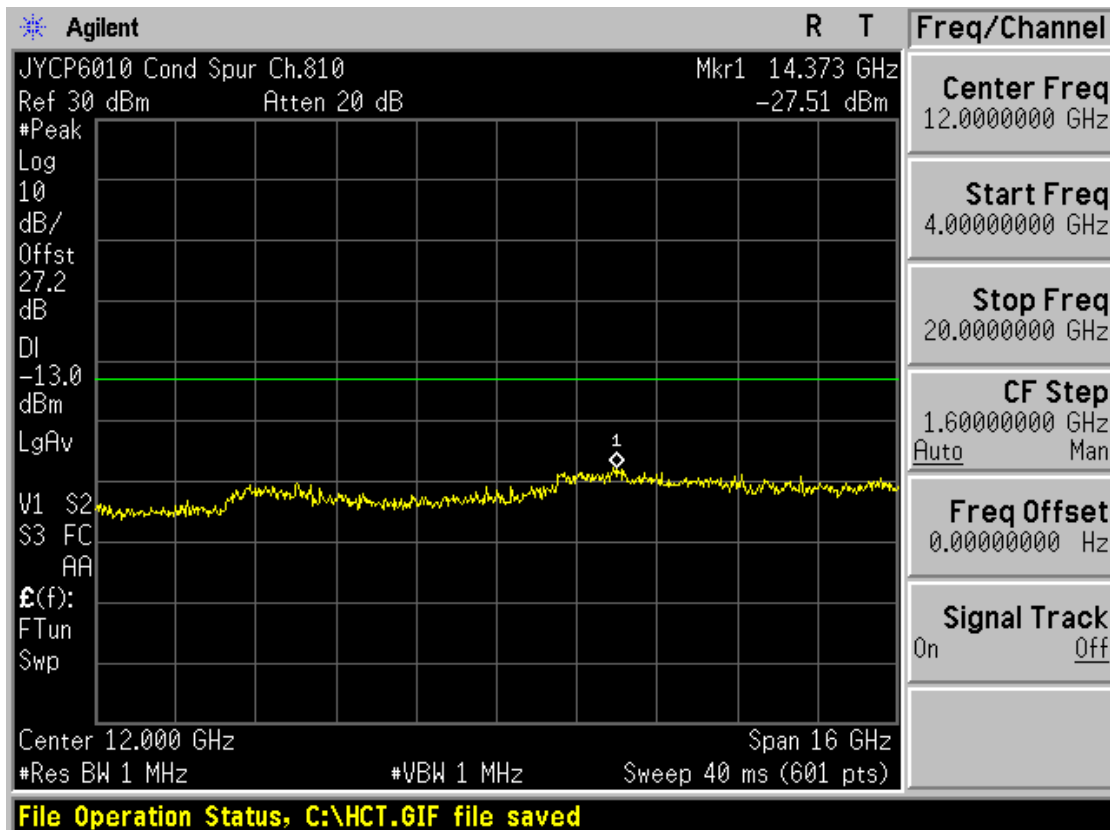

■ WCDMA850 MODE (4132 CH.) Conducted Spurious Emissions1

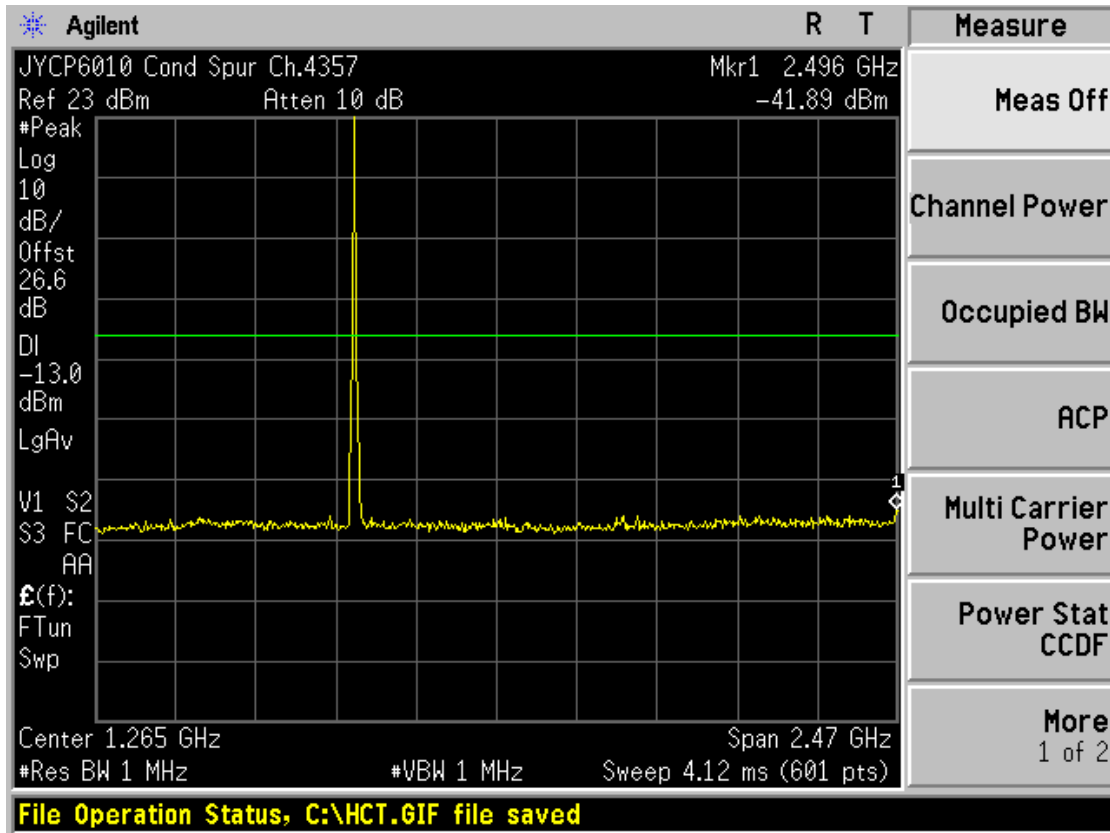

■ WCDMA850 MODE (4132 CH.) Conducted Spurious Emissions2

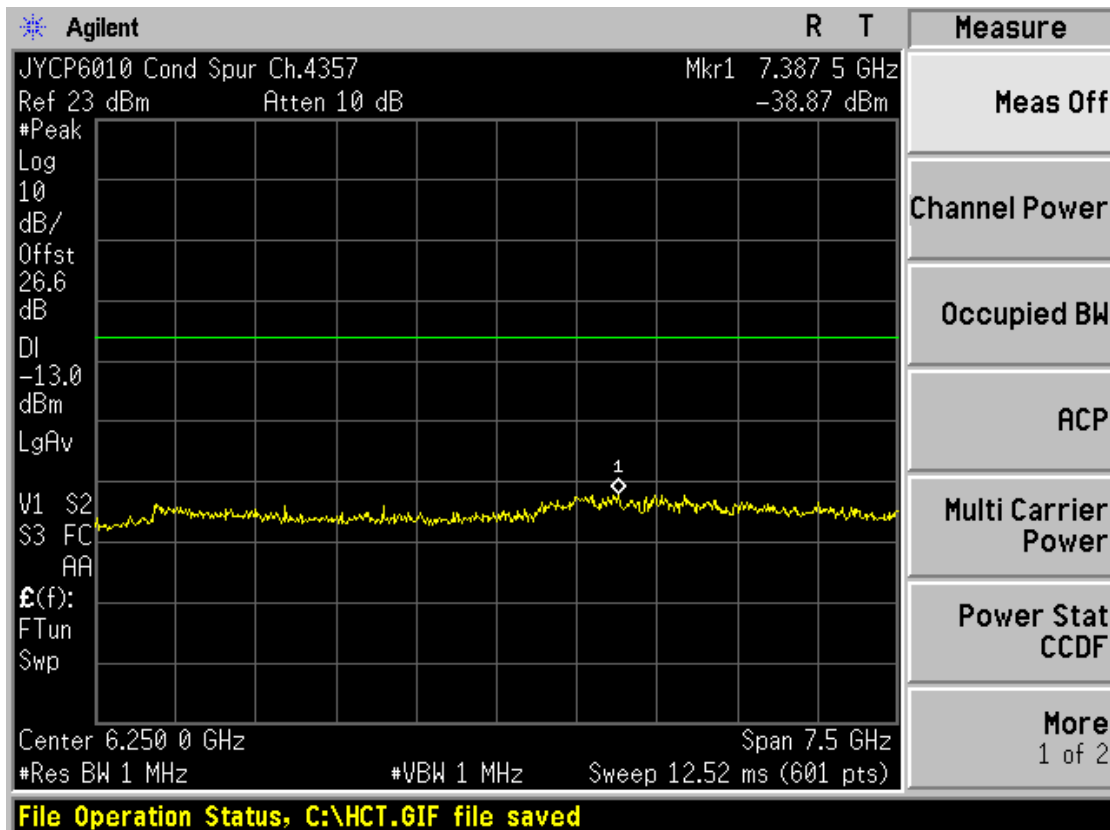



■ WCDMA850 MODE (4183 CH.) Conducted Spurious Emissions1

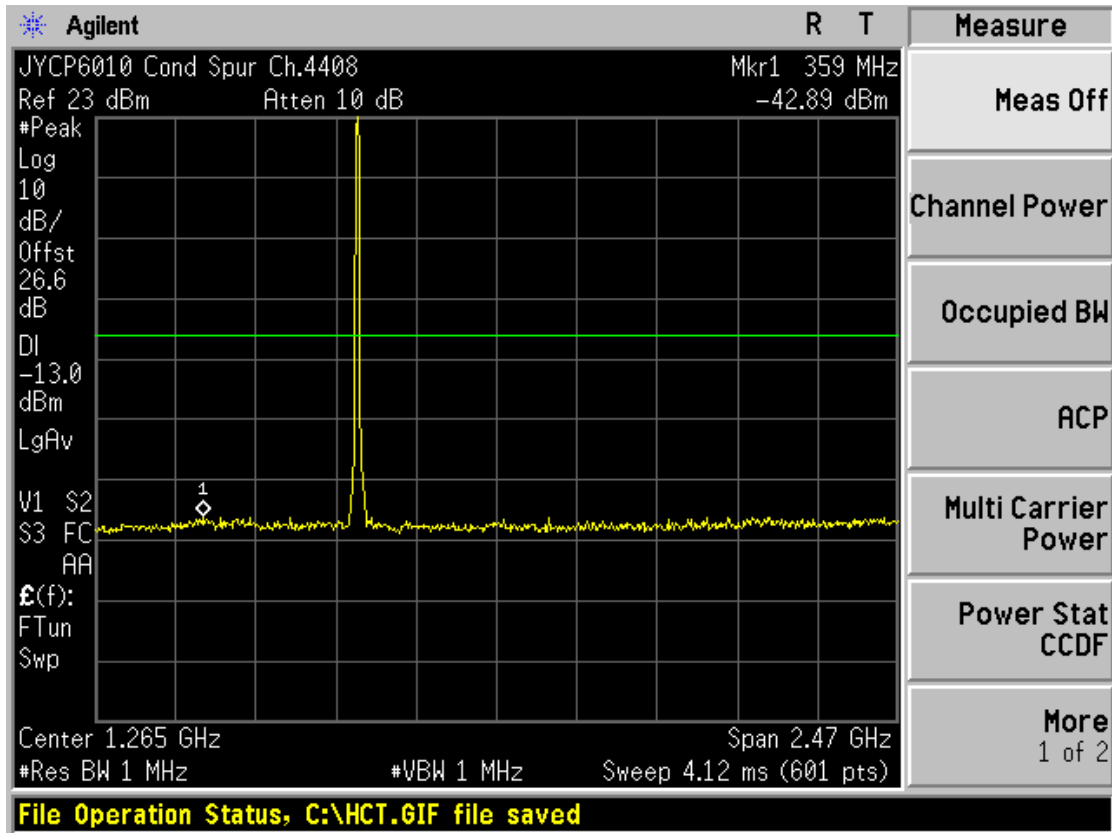

■ WCDMA850 MODE (4183 CH.) Conducted Spurious Emissions2

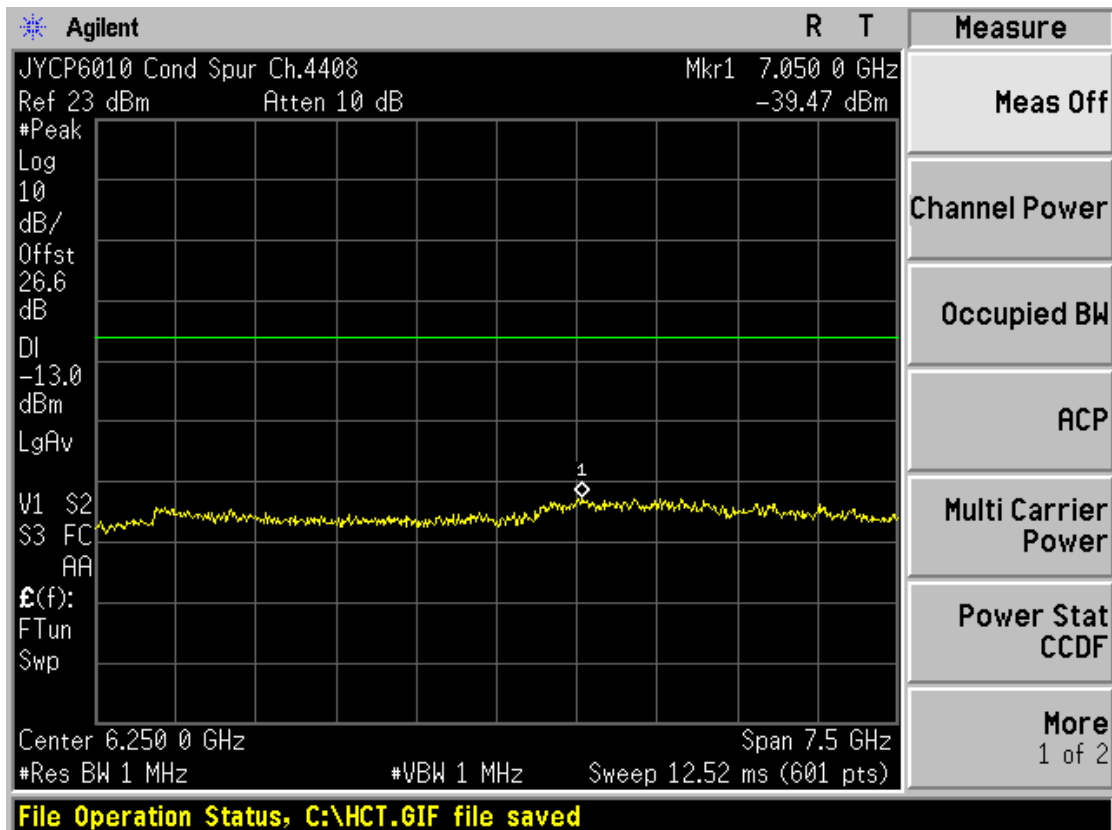

■ WCDMA850MODE (4233 CH.) Conducted Spurious Emissions1

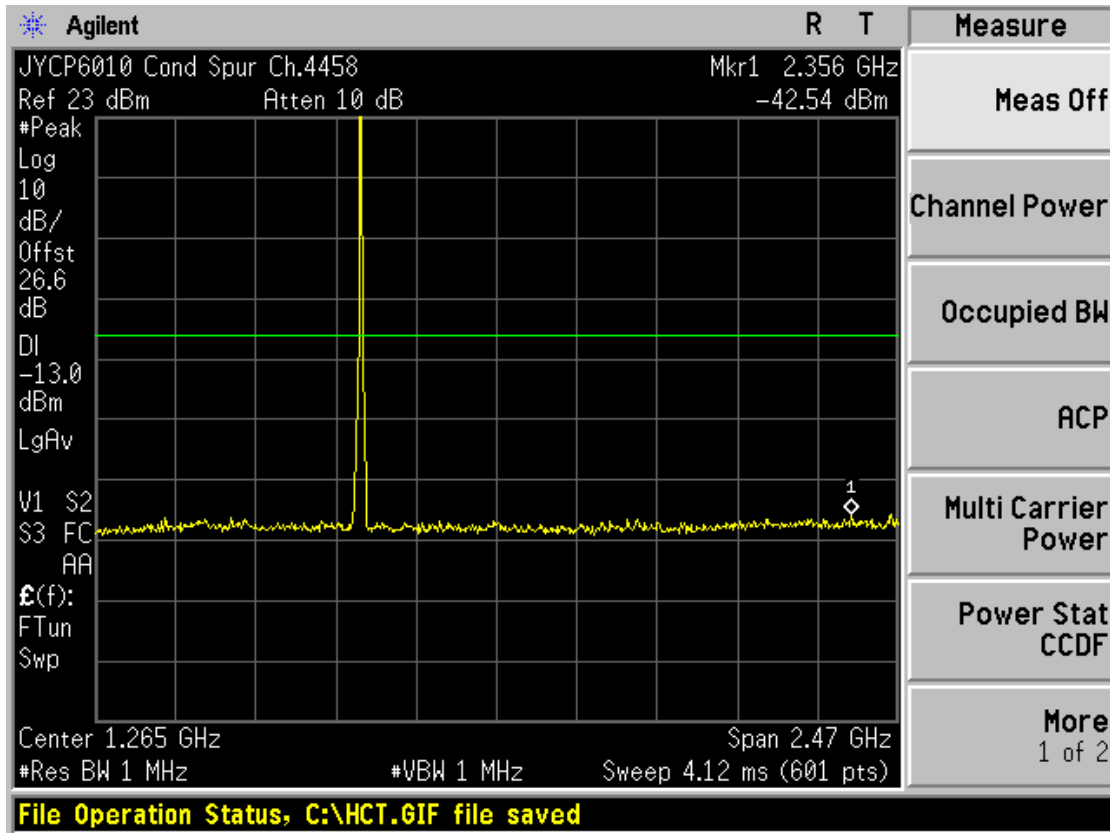

■ WCDMA850MODE (4233 CH.) Conducted Spurious Emissions2

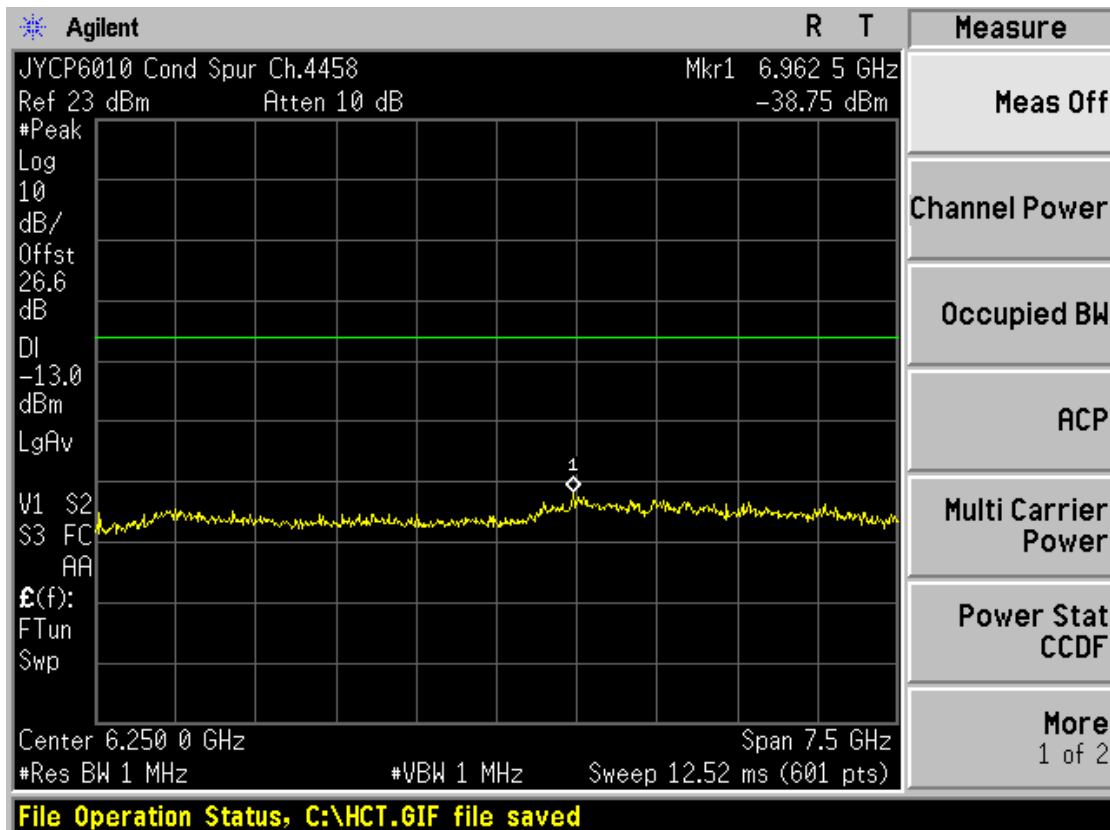

■ WCDMA1900 MODE (9262 CH.) Conducted Spurious Emissions1

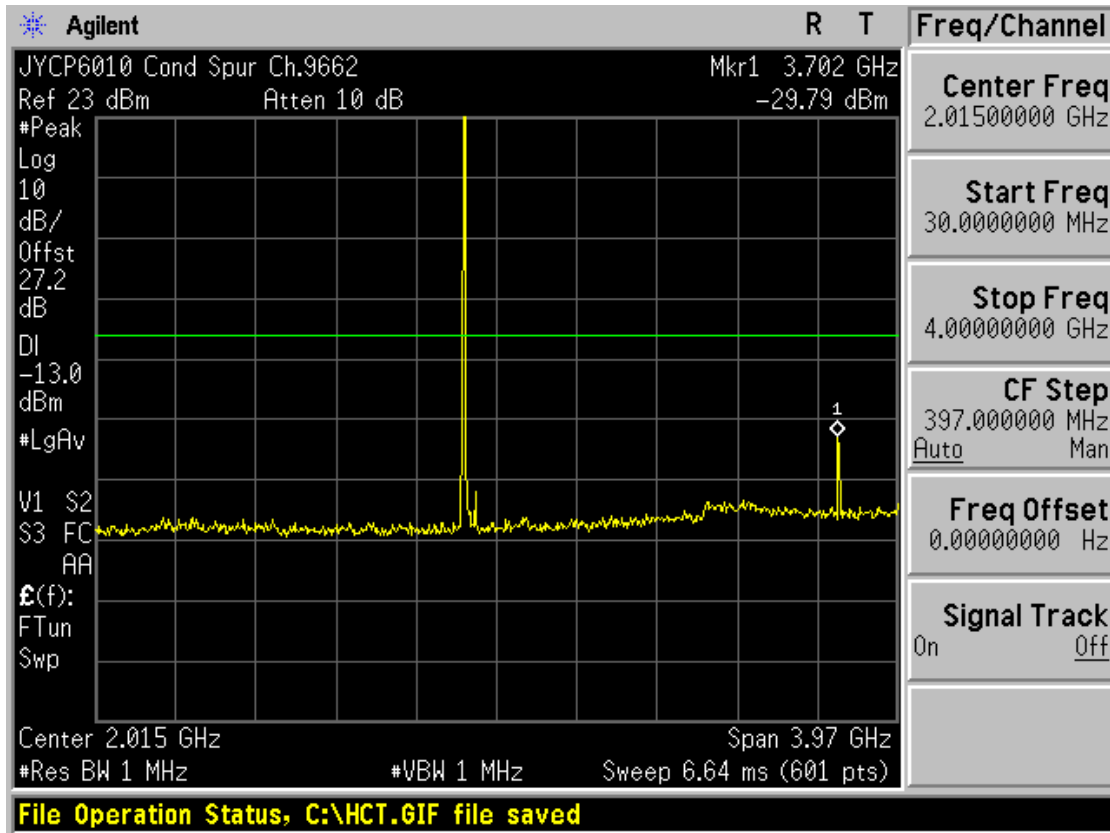

■ WCDMA1900 MODE (9262 CH.) Conducted Spurious Emissions2

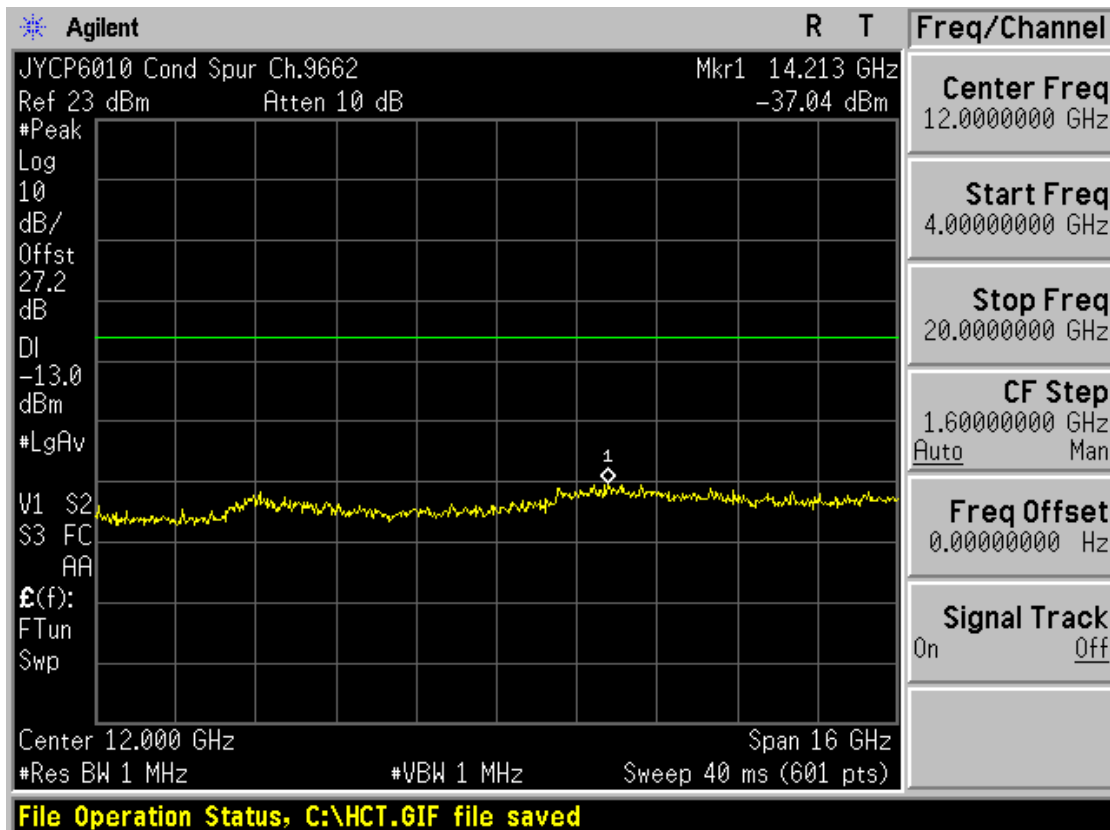

■ WCDMA1900 MODE (9400 CH.) Conducted Spurious Emissions1

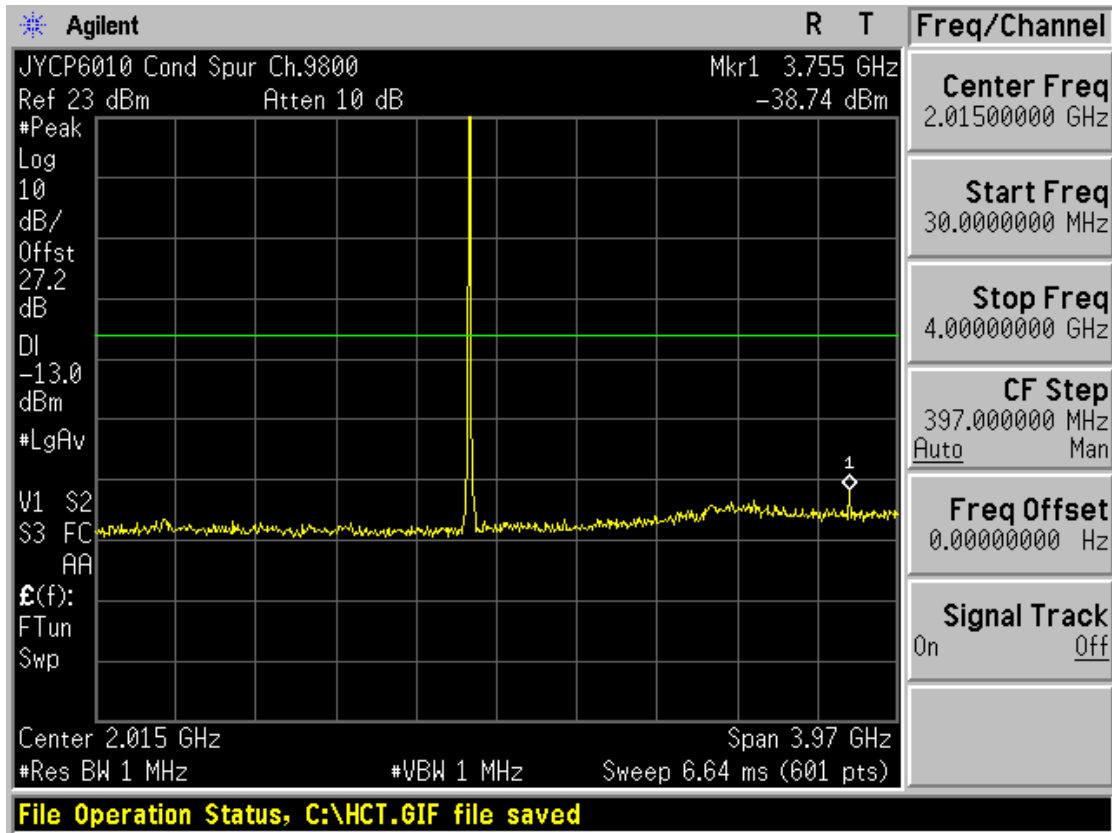

■ WCDMA1900 MODE (9400 CH.) Conducted Spurious Emissions2

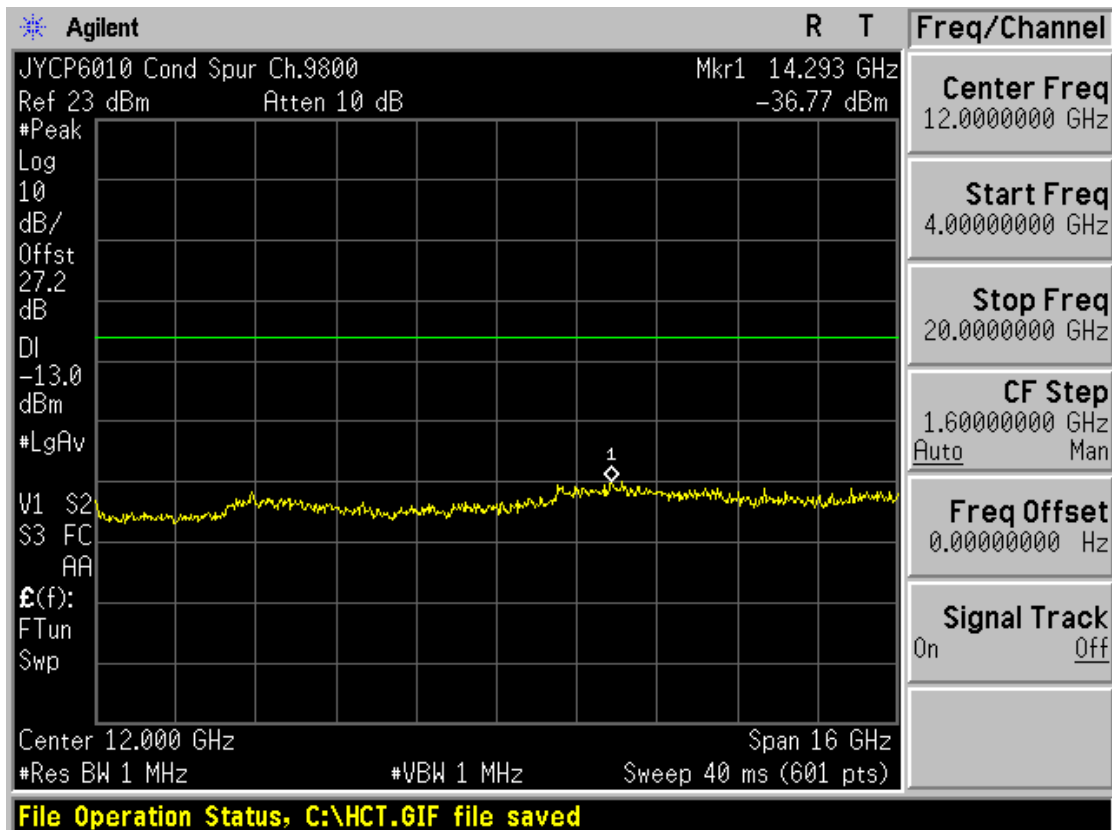

■ WCDMA1900 MODE (9538 CH.) Conducted Spurious Emissions1

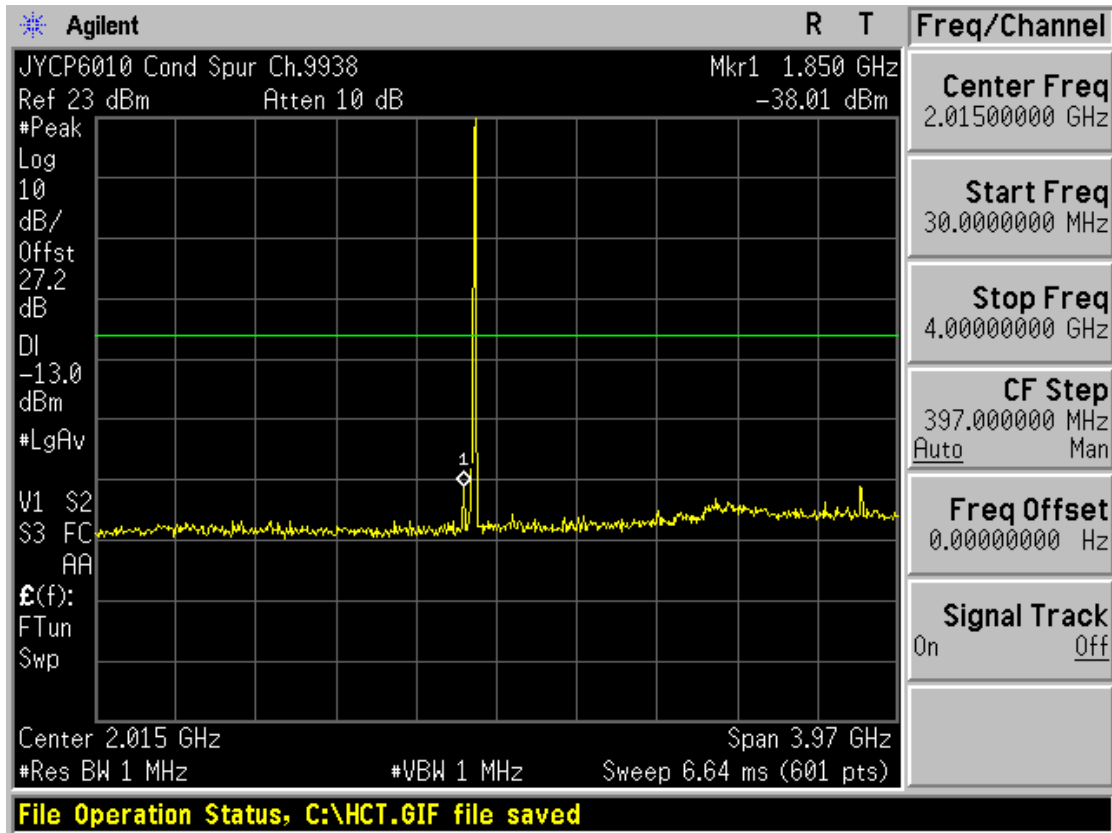

■ WCDMA1900 MODE (9538 CH.) Conducted Spurious Emissions2

